

RELIABLE CUTTING TOOLS FOR EVERY MACHINE SHOP

CUTTING TOOLS

METRIC | 2022



WIDIA 

AHB
TOOLING & MACHINERY

 **HANITA**[™]

COMPLETE METALWORKING SOLUTIONS
(800) 991-4225 www.ahbinc.com
ISO Certified customerservice@ahbinc.com

For more than 95 years, the WIDIA™ brand has delivered high-quality milling, turning, holemaking, tapping, and systems tooling to metalcutting customers across the globe. Customers experience reliability from selection to post-delivery support through product availability, digital connectivity, and an accessible network of authorized distribution partners.

For more information regarding the WIDIA brand or products, visit widia.com or connect with us on Instagram, Facebook, LinkedIn, and YouTube.

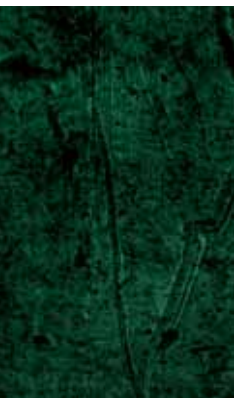

WIDIA is a brand for machinists, mechanical engineers, and machine shop owners who are depending on a reliable tool to keep their shop running through the night.

The brand offers a full portfolio of standard milling, drilling, holemaking tools, technical information, and support to everyday consumers.

WIDIA tools are sold through distribution partners. Find a distributor in your area by using the distributor finder on widia.com.



Hanita™ solutions are developed for customers who have a passion for performance. Hanita delivers not only the tool for the job but the experience to develop a solution for the customer.

The Hanita brand offers a comprehensive range of custom and standard end mills spanning a broad range of diameters and lengths, all boasting unparalleled metal removal rates through innovative geometries.

Hanita solutions are sold primarily through WIDIA channel partners, alongside WIDIA.

Table of Contents

Rotating Tools

Indexable Milling	A3–A339
Face Milling	A14–A88
Chamfer Milling	A90–A97
90° Shoulder Milling	A98–A177
High-Speed Milling.....	A178–A185
Helical Mills	A186–A205
Slotting Milling.....	A206–A213
High-Feed Milling	A214–A243
Copy Milling	A244–A325
ISO and General Milling Inserts.....	A326–A339
Solid End Milling	B3–B199
WIDIA Multi-Purpose End Mills	B4–B63
Hanita High-Performance Solid Carbide End Mills.....	B64–B199
Holemaking	C3–C152
Solid Carbide Drills.....	C8–C53
Modular Drills	C54–C84
Indexable Drills.....	C86–C110
Hole Finishing.....	C112–C132
Modular Boring	C134–C152
Tapping	D3–D33
Multipurpose	D4–D30
Technical Information.....	D31–D33

Stationary Tools

Turning	E3–E515
External Turning and Internal Boring.....	E4–E297
Grooving and Cut-Off.....	E298–E429
Threading	E430–E515
Customer Application Support	F2
Informational Icons Guide	F3–F7
All-Star Program	F8–F9
Material Cross Reference	F10

Spare Parts & Accessories Information

**Lost a screw? Have to replace worn-out clamping wedges?
Need to find and re-order those spare parts?**

Are you in need of some accessories, like a torque wrench or coolant shower plate? These tools are at your fingertips!
Go to **widia.com** and find what you need in seconds. Enter the catalog number of the corresponding tool, and it will display.

STEP 1 Enter the tool catalog number here

SAP Material Number	6495103
ISO Coding Number	M1200010020273219411
[D1] Effective Cutting Diameter	100.0000
[D1MAX] Maximum Cutting Diameter	111.8000
[D] Adapter / Shank / Nose Diameter	52.0
[Dn] Hub Diameter	78.0000
[L] Overall Length	36.0000
[L1] Flange Length	52.0000
[API-MAX] 1st Maximum Cutting Depth	7.5000
Number of Teeth	7
Coated Supply	16
Weight Kilograms	1.49

See all Product Systems

Uses and application

Workplace Mat

STEP 2 Select the spare parts & accessories

Spare Parts for M1200-MAX Screw Clamping - 56° - Shell Mills - Metric

INSERT SCR INO-0.8 x 17 D1

0750 TORX SCREWDRIVER TOOL

Spare Part With 0625 0286Cand

WIDIA™ Digital Solutions



WIDIA Machining Central

WIDIA™ Machining Central Mobile App
 Download for iOS or Android™:
widia.com/en/featured/WidiaMobileApp

Product Data

- Tooling Dimensional Data
- Feeds and Speeds
- Inventory Availability
- ...and More!

Tools and Resources at Your Fingertips



DOWNLOAD THE WIDIA MOBILE APPS TODAY!



www.youtube.com/c/widiatools



www.linkedin.com/company/widiatools/



www.instagram.com/widiatools/



www.facebook.com/widiatools



TO SEE ALL PRODUCT LINES, VISIT OUR DIGITAL RESOURCES



**WIDIA™ Machining Central
Mobile App**
Download for iOS or Android™:
[widia.com/en/featured/
WidiaMobileApp](https://www.widia.com/en/featured/WidiaMobileApp)



[widia.com](https://www.widia.com)



www.youtube.com/c/widiatools



www.linkedin.com/company/widiatools/



www.instagram.com/widiatools/



www.facebook.com/widiatools



Speed

The WIDIA™ brand encompasses a variety of standard tooling designed to perform well in a range of typical machine shop operations. A team of experienced application support specialists is readily available to help increase productivity in your shop via WIDIA website chat or over the phone for every step of the way.

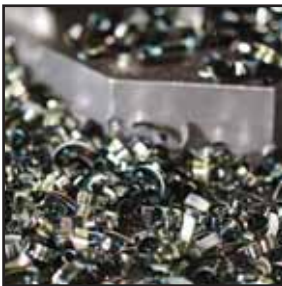

Simplicity

Machinists can rely on the NOVO™ machining advisor or widia.com to easily select the right tool for the job.



Reliability

Trust our network of authorized distributors to put WIDIA tools to work for you — in your industry, in your region, and in your business. Together we will keep your machine running through the night.

For more than 95 years, the WIDIA brand has delivered quality milling, turning, holmaking, tapping, and systems tooling to metalcutting customers across the globe. Customers experience reliability from selection to post-delivery support through product availability, digital connectivity, and an accessible network of authorized distribution partners.

Test WIDIA tooling today by selecting tools from the All-Star program. The All-Star program is comprised of proven tooling solutions that are easy to find and always available. This includes solid end mills, turning tools, drills, and taps from our most popular platforms, grades, and sizes grouped into one program and guaranteed to be in stock with same-day shipping on orders placed before 4pm CET.

Visit widia.com to see what products are available for same-day shipping through All-Star.



Indexable Milling

Technical Information	A4–A13
Face Milling	A14–A88
Portfolio Overview	A14–A15
M640	A16–A21
M660 Series	A22–A31
M1600 Series	A32–A39
M1200 Series	A40–A58
M8065HD	A60–A64
M8090 Series	A66–A73
M4070	A74–A78
SuperFeed	A80–A84
M4000	A86–A88
Chamfer Milling	A90–A97
M25	A90–A97
90° Shoulder Milling	A98–A177
Portfolio Overview	A98–A99
VSM11	A100–A109
VSM17	A110–A119
VSM22	A120–A124
VSM490 Series	A126–A141
VSM890 Series	A142–A147
M680 Series	A148–A165
M690	A166–A177
High-Speed Milling	A178–A185
VHSC	A178–A185
Helical Mills	A186–A205
M390	A186–A192
M300	A194–A205
Slotting Milling	A206–A213
M16	A208–A213
High-Feed Milling	A214–A243
VXF Series	A214–A232
M370 Series	A234–A243
Copy Milling	A244–A325
M200 Series	A244–A263
M170	A264–A284
M100 Series	A286–A305
M270	A306–A325
ISO and General Milling Inserts	A326–A339
Face Milling ISO Inserts	A326–A336
Shoulder Milling ISO Inserts	A336–A338
Copy Milling ISO Inserts	A338–A339

Choosing the Correct Cutter

Find and Select the Right Milling Cutter

1. Identify material to be machined:

A Each tool has a material grid marked with a letter indicating the materials that can be machined.

2. Select tool based on maximum depth of cut and diameter required:

- B Information is given in this area to provide specific detail as a quick reference.
- C Informational Icons. Connection type and possible operations.

3. Select product name

D Navigate to introduction detail, toolbodies, inserts, and cutting data within section.

Face Milling Portfolio Overview						
Face Milling	SuperFeed™	M640	M660	M1600 Mini-F	M1600	M1200 Mini
Page	A82-A83	A18-A20	A24-A27	A34-A35	A37-A38	A42-A47
Work Piece Materials	M	P M K N S H	P M K N S H	K	P M K	P M K N S H
Max. Axial Depth of Cut (Ap1 Max)	6,35mm	1,52mm	6,4/8,0mm	1,52mm	3,7mm	4,7mm
Approach/Lead Angle	90°	58°	45°	45°	43°	15/45/59°
Effective Cutting Edges	1	6	4	16	16	12
Diameter Range	25-200mm	32-125mm	20-160mm	80-160mm	50-160mm	25-125mm
Insert Style	Single-Sided	Single-Sided	Single-Sided	Double-Sided	Double-Sided	Double-Sided
Ground Insert	<input checked="" type="checkbox"/>	<input checked="" type="checkbox"/>	<input checked="" type="checkbox"/>	<input checked="" type="checkbox"/>	<input checked="" type="checkbox"/>	<input checked="" type="checkbox"/>
Pressed to Size Insert	<input type="checkbox"/>	<input checked="" type="checkbox"/>	<input checked="" type="checkbox"/>	<input type="checkbox"/>	<input type="checkbox"/>	<input checked="" type="checkbox"/>
Insert Nose Radii	0,8/2,36mm	0,90/0,98mm	Not applicable	0,8mm	1,2mm	1,2/3,2mm
Embedded Wiper Facet	1,52mm	—	1,54-2,0mm	0,6mm	0,765mm	1,454-1,6mm
Separate Wiper Insert	<input type="checkbox"/>	<input checked="" type="checkbox"/>	<input checked="" type="checkbox"/>	<input checked="" type="checkbox"/>	<input type="checkbox"/>	<input checked="" type="checkbox"/>
Cutter Pitch	fine	coarse	regular	regular	regular	coarse & fine
Workpiece Floor Finish	✓	✓	✓	✓	✓	✓
Screw Insert Clamping	<input type="checkbox"/>	<input checked="" type="checkbox"/>	<input checked="" type="checkbox"/>	<input checked="" type="checkbox"/>	<input checked="" type="checkbox"/>	<input checked="" type="checkbox"/>
Wedge Clamping of Inserts	<input checked="" type="checkbox"/>	<input type="checkbox"/>	<input type="checkbox"/>	<input type="checkbox"/>	<input type="checkbox"/>	<input type="checkbox"/>
Additional Operations	<input checked="" type="checkbox"/>	<input checked="" type="checkbox"/>	<input checked="" type="checkbox"/>	<input checked="" type="checkbox"/>	<input checked="" type="checkbox"/>	<input checked="" type="checkbox"/>
Shell Mills	<input checked="" type="checkbox"/>	<input checked="" type="checkbox"/>	<input checked="" type="checkbox"/>	<input checked="" type="checkbox"/>	<input checked="" type="checkbox"/>	<input checked="" type="checkbox"/>
Screw-On End Mills	<input type="checkbox"/>	<input type="checkbox"/>	<input type="checkbox"/>	<input type="checkbox"/>	<input type="checkbox"/>	<input checked="" type="checkbox"/>
Cylindrical End Mills	<input checked="" type="checkbox"/>	<input type="checkbox"/>	<input type="checkbox"/>	<input type="checkbox"/>	<input type="checkbox"/>	<input checked="" type="checkbox"/>
Weldon® End Mills	<input type="checkbox"/>	<input checked="" type="checkbox"/>	<input checked="" type="checkbox"/>	<input type="checkbox"/>	<input type="checkbox"/>	<input checked="" type="checkbox"/>
Cartridge for M4000	<input type="checkbox"/>	<input checked="" type="checkbox"/>	<input checked="" type="checkbox"/>	<input type="checkbox"/>	<input type="checkbox"/>	<input checked="" type="checkbox"/>



You can also use our NOVO app to guide you to the correct choice!

For more information, please visit widia.com/novo.

Determining Cutting Data

Selecting Tool Body, Insert, and Cutting Data

4. Choose the tool body:

Choose diameter (D1) and pitch (Z) of tool body.

NOTE: Make sure you select the correct shank style for your toolholder. For toolholders, visit widia.com.

Face Mills • M640 Series

M640 • Weldon® End Mills • Metric

order number	catalogue number	D1	D1 max	D	L	L2	Ap1 max	Z	max RPM	coolant supply	kg
2263165	12395405200	32	58.4	52	100	42	4.8	7	26500	Yes	0.38

5. Choose the inserts with the WIDIA™ insert selection guide:

- A Determine light machining, general purpose, or heavy machining according to workpiece material. See the Material Overview at the end of the catalog for material descriptions.
- B Select the grade given in the insert selection guide. Use the six-digit order number to easily place your order.

Material Group	Light Machining		General Purpose		Heavy Machining	
	Geometry	Grade	Geometry	Grade	Geometry	Grade
PS-P4	E, LD	WP42PM	E, GD	WP42PM	E, GD	WP42PM
PS-P6	E, LD	WP25PM	E, GD	WP42PM	E, GD	WP42PM
PS-P8	E, LD	WP25PM	E, GD	WP25PM	E, GD	WP25PM
M1-M3	E, LD	WP25PM	E, GD	WP25PM	E, GD	WP25PM
M3	E, LD	WP42PM	E, GD	WP25PM	E, GD	WP25PM
K1-K2	E, LD	TN6510	E, GD	WK15CM	E, GD	WK15CM
K3	E, LD	TN6520	E, GD	WP25PM	E, GD	WP25PM

catalogue number	cutting edges	D	S	R	hm	TiAlN	TiAlN-U	TN6510	TN6520	TN6525	TN6540	WK15CM	WP42PM	WP25PM	WP42PM	WP25PM	WP42PM	WP25PM
HPGT25DZENGD	6	432	136	0.28	0.04													

6. Determine cutting data — with the WIDIA Recommended Speeds and Feeds tables:

- A Choose the recommended speed value according to the workpiece material and grade.
- B Choose the recommended starting feed rate according to the insert geometry and % of radial engagement ae.

Starting values are given in bold.

Material Group	TN6510		TN6520		TN6525		TN6540		WK15CM		
	1	2	1	2	1	2	1	2	1	2	
P	1	-	-	-	410	250	280	360	260	240	-
	2	-	-	-	320	250	215	250	190	170	-
	3	-	-	-	280	215	185	215	170	140	-
	4	-	-	-	235	170	145	180	130	110	-
	5	-	-	-	310	230	200	240	180	150	-
M	1	-	-	-	205	160	130	160	120	100	-
	2	-	-	-	190	120	80	130	90	60	-
	3	-	-	-	120	80	50	80	50	40	-
K	1	480	350	260	450	320	230	275	245	220	220
	2	420	280	208	300	250	190	215	180	175	155
	3	335	260	200	300	250	190	180	145	155	145
N	1	-	-	-	-	-	-	-	-	-	-
	2	-	-	-	-	-	-	-	-	-	-
	3	-	-	-	-	-	-	-	-	-	-
S	1	-	-	-	-	-	-	50	35	30	-
	2	-	-	-	-	-	-	25	20	10	-
	3	-	-	-	-	-	-	70	40	30	-
4	-	-	-	-	-	-	60	30	25	-	
1	-	-	-	-	-	-	-	-	-	-	

M640 • Recommended Starting Feeds [mm]

Insert Geometry	Programmed Feed per Tooth (fz) as a % of Radial Depth of Cut (ae)							Insert Geometry
	5%	10%	15%	20%	30%	40-100%		
F 1 (L)	0.13	0.24	0.27	0.35	0.44	0.55	0.68	F 1 (L)
F 1 (R)	0.13	0.24	0.27	0.35	0.44	0.55	0.68	F 1 (R)
E 200	0.13	0.24	0.27	0.35	0.44	0.55	0.68	E 200

NOTE: Use "Light Machining" value as starting feed rate.

Inserts • Catalog Numbering System

Each character in our catalog number signifies a specific trait of that product. Use the following key columns and corresponding images to easily identify which attributes apply.

H		N		P		J				
Insert Shape		Insert Clearance Angle		Tolerance Class		Geometry and Clamping Type				
A		A	3°			symbol	hole	shape of hole	chipbreaker	shape of insert's section
B		B	5°			N	without		without	
C		C	7°			R	without		single-sided	
E		D	15°			F	without		double-sided	
H		E	20°			A	with	cylindrical hole	without	
L		F	25°			M	with		single-sided	
O		G	30°			G	with		double-sided	
R		N	0°			W	with	partly cylindrical hole, 40-60° countersink	without	
S		P	11°			T	with		single-sided	
T						Q	with	partly cylindrical hole, 40-60° double countersink	without	
W						U	with		double-sided	
X	Special Design					B	with	partly cylindrical hole, 70-90° countersink	without	
						H	with		single-sided	
						C	with	partly cylindrical hole, 70-90° double countersink	without	
						J	with		double-sided	
						X			special design	

indexable inserts with facets/wipers

indexable inserts with corner radii

insert thickness

iC	tolerances on "iC"		tolerances on "M"	
	classes J, K, L, M, N (/-)	class U (/-)	classes M & N (/-)	class U (/-)
4,76-10,00	0,051	0,076	0,076	0,127
11,11-14,29	0,076	0,127	0,127	0,203
15,00-20,64	0,102	0,178	0,152	0,279
22,00-31,16	0,127	0,254	0,178	0,381
31,75-35,00	0,152	0,254	0,2	0,381

	iC (+/-)	M (/-)	T (/-)		iC (+/-)	M (/-)	T (/-)
A	0,025	0,005	0,025	J	0,05-0,15*	0,005	0,025
B	0,025	0,005	0,013	K	0,05-0,15*	0,013	0,025
C	0,025	0,013	0,025	L	0,05-0,15*	0,025	0,025
D	0,025	0,013	0,013	M	0,05-0,15*	0,08-0,20*	0,013
E	0,025	0,025	0,025	N	0,05-0,15*	0,08-0,20*	0,025
F	0,013	0,005	0,025	P**	0,038	0,038	0,038
G	0,025	0,025	0,013	U	0,08-0,25*	0,13-0,30*	0,013
H	0,013	0,013	0,025				

*See table above for tolerances according to insert size and class.
 **WIDIA standard only.

Inserts • Catalog Numbering System

(continued)

07

Size
(Cutting Edge Length)

04

Insert Thickness

symbol	thickness
T1	1,98
02	2,38
03	3,18
T3	3,97
04	4,76
05	5,56
06	6,35
07	7,94

AN

Corner
Configuration

S

Cutting Edge
Form

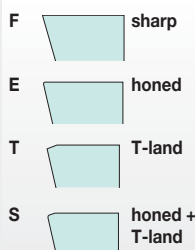

N

Insert Hand

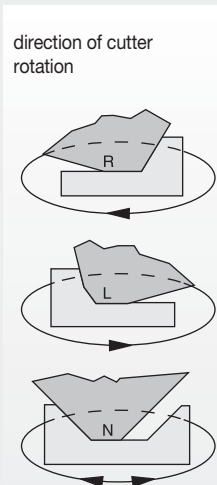

GD

Edge
Geometry

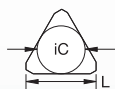

inscribed circle "iC" versus cutting edge length "L"
For shapes A, L, and X, see position #1; use length of leading cutting edge.

iC	"L" for shapes						
	S	T	R	O	C	H	E
6,00	-	-	06	-	-	-	-
6,35	06	11	06	02	06	03	06
8,00	-	-	08	-	-	-	-
9,52	09	16	09	04	09	05	09
10,00	-	-	10	-	-	-	-
12,00	-	-	12	-	-	-	-
12,70	12	22	12	05	12	07	13
15,88	15	27	15	06	16	09	16
16,00	-	-	16	-	-	-	-
19,05	19	33	19	07	19	11	19
20,00	-	-	20	-	-	-	-
25,00	-	-	25	-	-	-	-
25,40	25	4					

radius		leading or major cutting edge	assumed direction of feed motion	wiper edge clearance P
MO	round insert			
01	0,1mm			A 3°
02	0,2mm			B 5°
04	0,4mm			C 7°
05	0,5mm			D 15°
08	0,8mm			E 20°
10	1,0mm			F 25°
12	1,2mm			G 30°
15	1,5mm	A	45°	N 0°
16	1,6mm	D	60°	P 11°
24	2,4mm	E	75°	
32	3,2mm	P	90°	

If letter is replaced by number(s), refer to table for radius "r."

lead angle K





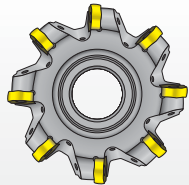





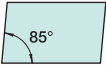

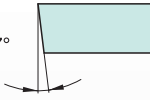

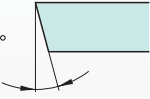

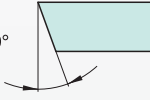

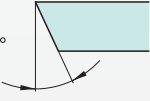
Tool Bodies • Catalog Numbering System

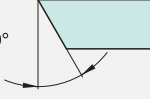
Each character in our catalog number signifies a specific trait of that product. Use the following key columns and corresponding images to easily identify which attributes apply.

<div data-bbox="140 376 418 448" style="text-align: center;">M1200</div> <div data-bbox="245 456 312 486">Series</div>	<div data-bbox="453 376 609 448" style="text-align: center;">D</div> <div data-bbox="564 456 724 486">Cutting Diameter</div>	<div data-bbox="647 376 833 448" style="text-align: center;">100</div>	<div data-bbox="871 376 1046 448" style="text-align: center;">Z</div> <div data-bbox="976 456 1136 486">Number of Flutes</div> <div data-bbox="874 546 1031 600"> <p>Z = Number of effective flutes</p> </div> <div data-bbox="1059 533 1248 716">  </div>	<div data-bbox="1062 376 1248 448" style="text-align: center;">03</div>	<div data-bbox="1289 376 1468 448" style="text-align: center;">C</div> <div data-bbox="1321 456 1436 486">Shank Form</div> <div data-bbox="1295 533 1436 698"> <ul style="list-style-type: none"> C = Cylindrical W = Weldon® M = Modular S = Shell Mill </div>
---	---	---	--	--	--

Tool Bodies • Catalog Numbering System

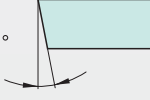
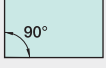
(continued)

100		H		N		07		L		800	
Shank/Pilot Diameter		Insert Shape		Insert Clearance Angle		Insert Size (Cutting Edge Length)		Overall Length of Tool Used for all cylindrical shank and long version Weldon® if required (standard Weldon without)		Optional uses as required	
A		M		C		LH	Left Hand				
B		O		D		C	Carbide Shank				
C		P		E		HM	Heavy Metal Shank				
D		R		F							
E		S		G							
H		T		N							
K		V		P							
L		W									
		X	Special Design								

INDEXABLE MILLING

SOLID END MILLING

HOLE/MAKING

TAPPING

TURNING

Grades and Grade Descriptions

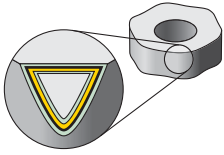

Modern coating technologies provide higher speed capabilities, greater productivity, and longer tool life.

Each insert has a material grid indicating primary and alternate uses for that tool, as well as whether it can be operated dry or with coolant.

P	Steel
M	Stainless Steel
K	Cast Iron
N	Non-Ferrous
S	High-Temp Alloys
H	Hardened Materials

primary use		alternate use	
▽▽▽	Light (finishing)	▽▽▽	Light (finishing)
▽▽	Medium	▽▽	Medium
▽	Heavy (roughing)	▽	Heavy (roughing)

Grade		P	M	K	N	S	H	dry	with coolant
TN2505		▽▽▽		▽▽▽			▽▽▽	•	
HC-H05 • PVD-TiAlN									
TN2510		▽▽		▽▽			▽▽	•	
HC-H10 • MT-CVD/CVD-TiN-TiCN-(ZrO ₂ -Al ₂ O ₃ -TiOx)									
TN2525		▽▽		▽▽			▽▽	•	
HC-H20 • PVD-TiAlN									
TN6501					▽▽▽			•	•
HC-N03 • PVD-TiB ₂									
TN6510				▽▽				•	
HC-K10 • PVD-TiAlN Nanolayer									
TN6520				▽▽				•	•
HC-K20 • PVD-TiAlN Nanolayer									

Grades and Grade Descriptions

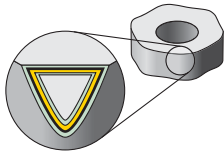

Modern coating technologies provide higher speed capabilities, greater productivity, and longer tool life.

Each insert has a material grid indicating primary and alternate uses for that tool, as well as whether it can be operated dry or with coolant.

P	Steel
M	Stainless Steel
K	Cast Iron
N	Non-Ferrous
S	High-Temp Alloys
H	Hardened Materials

primary use		alternate use	
▼▼▼	Light (finishing)	▼▼▼	Light (finishing)
▼▼	Medium	▼▼	Medium
▼	Heavy (roughing)	▼	Heavy (roughing)

Grade		P	M	K	N	S	H	dry	with coolant
TN6525		▼▼	▼▼	▼▼				•	
HC-P25 • PVD-TiAlN Nanolayer									
TN6540		▼	▼	▼		▼▼		•	•
HC-P40 • PVD-TiAlN Nanolayer									
TTI25		▼▼▼	▼▼▼					•	•
HT-P15 • Cermet									
THM				▼	▼	▼		•	•
HW-K15 • Uncoated									
THM-U					▼▼▼			•	•
HF-N05 • Uncoated									
TTM/TTM08		▼▼	▼▼	▼▼				•	•
HW-P25 • Uncoated									

INDEXABLE MILLING

SOLID END MILLING

HOLEMAKING

TAPPING

TURNING

Grades and Grade Descriptions

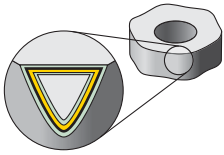

Modern coating technologies provide higher speed capabilities, greater productivity, and longer tool life.

Each insert has a material grid indicating primary and alternate uses for that tool, as well as whether it can be operated dry or with coolant.

P	Steel
M	Stainless Steel
K	Cast Iron
N	Non-Ferrous
S	High-Temp Alloys
H	Hardened Materials

primary use		alternate use	
▼▼▼	Light (finishing)	▼▼▼	Light (finishing)
▼▼	Medium	▼▼	Medium
▼	Heavy (roughing)	▼	Heavy (roughing)

Grade		P	M	K	N	S	H	dry	with coolant
WK15PM				▼▼				•	•
PVD-TiAlN Nanolayer									
WK15CM™				▼▼				•	
MT-CVD/TiN-TiCN-Al ₂ O ₃									
WP20CM		▼▼		▼▼					
MT-CVD/TiN-TiCN-Al ₂ O ₃									
WP25PM		▼▼	▼▼	▼▼			▼▼	•	•
PVD-AlTiN Multilayer									
WS30PM™		▼▼	▼▼			▼▼		•	•
PVD-AlTiN Multilayer									
WS40PM		▼	▼			▼		•	•
PVD-TiAlN/TiN Multilayer									

Grades and Grade Descriptions

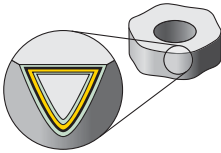

Modern coating technologies provide higher speed capabilities, greater productivity, and longer tool life.

Each insert has a material grid indicating primary and alternate uses for that tool, as well as whether it can be operated dry or with coolant.

P	Steel
M	Stainless Steel
K	Cast Iron
N	Non-Ferrous
S	High-Temp Alloys
H	Hardened Materials

primary use		alternate use	
▼▼▼	Light (finishing)	▼▼▼	Light (finishing)
▼▼	Medium	▼▼	Medium
▼	Heavy (roughing)	▼	Heavy (roughing)

Grade		P	M	K	N	S	H	dry	with coolant
WU20PM		▼▼	▼▼	▼▼		▼▼	▼▼	•	•
PVD-TiAlN									
WU35PM		▼	▼			▼		•	•
PVD-AlTiN Multilayer									
WP35CM		▼	▼	▼				•	
MT-CVD/TiN-TiCN-Al ₂ O ₃									
WP40PM™		▼	▼			▼		•	•
PVD TiAlN-AlCrN Multilayer									
WK25YM				▼▼				•	
Silicon Nitride									
WDN00U™					▼▼▼				•
Ultra-fine grain PCD					▼				

INDEXABLE MILLING

SOLID END MILLING

HOLEMAKING

TAPPING

TURNING

Face Milling Portfolio Overview































































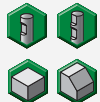























INDEXABLE MILLING

SOLID END MILLING





































































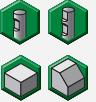
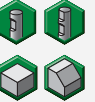
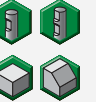

































HOLEMAKING





TAPPING

TURNING

Face Milling						
	SuperFeed™	M640	M660	M1600 Mini-F	M1600	M1200 Mini
Page	A82–A83	A18–A20	A24–A27	A34–A35	A37–A38	A42–A47
Work Piece Materials						
Max. Axial Depth of Cut (Ap1 Max)	6,35mm	1,52mm	6,4/8,0mm	1,52mm	3,7mm	4,7mm
Approach/Lead Angle	90°	58°	45°	45°	43°	15/45/59°
Effective Cutting Edges	1	6	4	16	16	12
Diameter Range	25–200mm	32–125mm	20–160mm	80–160mm	50–160mm	25–125mm
Insert Style	Single-Sided	Single-Sided	Single-Sided	Double-Sided	Double-Sided	Double-Sided
Ground Insert						
Pressed to Size Insert						
Insert Nose Radii	0,8/2,36mm	0,90/0,98mm	Not applicable	0,8mm	1,2mm	1,2/3,2mm
Embedded Wiper Facet	1,52mm	—	1,54–2,0mm	0,6mm	0,765mm	1,454–1,6mm
Separate Wiper Insert						
Cutter Pitch	fine	coarse	regular	regular	regular	coarse & fine
Workpiece Floor Finish						
Screw Insert Clamping						
Wedge Clamping of Inserts						
Additional Operations						
 Shell Mills						
 Screw-On End Mills						
 Cylindrical End Mills	 <i>Shoulder Mill only</i>					
 Weldon® End Mills						
Cartridge for M4000						

Face Milling Portfolio Overview

							
M1200	M1200 Max Screw	M1200 Max Wedge	M8065HD	M8090	M8090-F	M4070	M4000
A49–A54	A56–A57	A56–A57	A62–A63	A68–A69	A71–A72	A76–A77	A88
							—
6mm	7,5mm	7,5mm	9,0mm	11,5mm	1mm	17mm	—
15/45/59°	56°	56°	64°	89°	89°	70°	—
12	12	12	8	8	8	4	—
50–315mm	80–250mm	63–250mm	50–315mm	63–250mm	80–250mm	125–315mm	125–315mm
Double-Sided	Double-Sided	Double-Sided	Double-Sided	Double-Sided	Double-Sided	Double-Sided	—
							—
							—
1,2/4,34mm	Not applicable	Not applicable	1,2mm	1,2mm	1,2mm	1,2mm	—
1,8mm	1,2mm	1,2mm	2,37mm	—	—	—	—
							—
coarse & fine	regular	regular	regular	coarse & fine	regular	regular	—
							
							—
							—
							
							
							
							
							
							—

 Good
  Perfect
  Yes
  No
  All-Star Program

INDEXABLE MILLING

SOLID END MILLING

HOLEMAKING

TAPPING

TURNING

M640

M640 Face Mill

Use the M640 face mill to create smooth finishes in all workpiece materials using soft cutting action on low-power machines.



The M640 face mill features six cutting edges on the insert with a highly positive rake enhancing productivity in finishing operations on low-power machines and driven units.

WIPER INSERT



P M K N S H

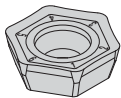

-GD

Positive and stable geometry for medium machining. The positive stabilized cutting edge improves the milling action.



-3W

Geometry with wiper facet for best surface qualities. Only to be used in conjunction with the ground geometry -GD

INSERT



P M K N S H

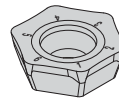

-LD

Highly positive geometry for smooth and soft cutting action. Geometry with face cutting edge for finish machining.

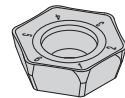

-AL

Geometry for machining aluminum. The main and secondary cutting edges are sharp edged.

LOW CUTTING FORCES, FINISHING OPERATIONS

PRODUCT

SERIES

M640

DIAMETER RANGE

32–125mm

SHANK TYPES

Weldon® End Mills
Shell Mills

INDUSTRY



APPLICATIONS



FACE
MILLING

SLEEK FINISH

LOW CUTTING FORCES

Highly positive rake angle for extremely low cutting forces.



M640 • Weldon® End Mills • Metric

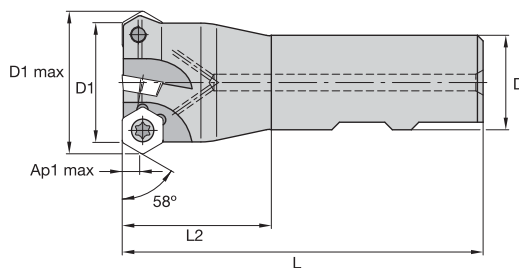

order number	catalogue number	D1	D1 max	D	L	L2	Ap1 max	Z	max RPM	coolant supply	kg
2263165	12395405200	32	38,4	32	100	40	4,8	4	29500	Yes	0,35

M640 • Shell Mills • Metric

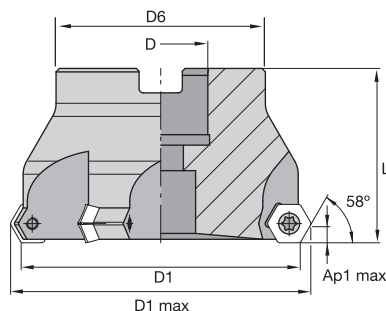

order number	catalogue number	D1	D1 max	D	D6	L	Ap1 max	Z	max RPM	coolant supply	kg
2263132	12395410200	50	56,4	22	47	40	4,8	4	19000	Yes	0,40
2263154	12395410400	63	69,4	22	50	40	4,8	5	15000	Yes	0,55
2263156	12395410600	80	86,4	27	60	50	4,8	6	11500	Yes	1,05
2263158	12395410800	100	106,4	32	78	50	4,8	7	9500	No	1,50
2263159	12395415800	100	106,4	32	78	50	4,8	10	9500	No	1,65
2263160	12395411000	125	131,4	40	89	63	4,8	8	7500	No	2,90

FOR SPARE PARTS, PLEASE VISIT WIDIA.COM OR WIDIANOVO.COM.
MOUNTING SCREWS ARE NOT INCLUDED IN STANDARD PACKAGING.

M640 • HPGT-LDAL

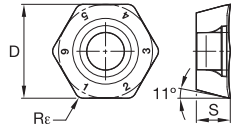
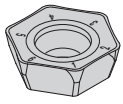

● first choice
○ alternate choice

P	●					●	●	●	●	○	○
M	●					○	○	○	○	○	○
K	●	○	○	○	○	○	○	○	○	○	○
N	○	○	○	○	○	○	○	○	○	○	○
S	○	○	○	○	○	○	○	○	○	○	○
H	○	○	○	○	○	○	○	○	○	○	○

ISO catalogue number	cutting edges	D	S	Rε	hm	THM	THM-U	TN6510	TN6520	TN6525	TN6540	WK15CM	WP25PM	WP40PM	WS30PM	WS40PM
HPGT06T3DZFRLDAL	6	11	4,00	0,90	0,08	2288106	2288107	●	○	○	○	○	○	○	○	○

M640 • HPGT-LD

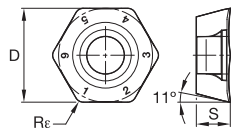
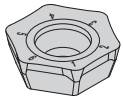

● first choice
○ alternate choice

P	●					●	●	●	●	○	○
M	●					○	○	○	○	○	○
K	●	○	○	○	○	○	○	○	○	○	○
N	○	○	○	○	○	○	○	○	○	○	○
S	○	○	○	○	○	○	○	○	○	○	○
H	○	○	○	○	○	○	○	○	○	○	○

ISO catalogue number	cutting edges	D	S	Rε	hm	THM	THM-U	TN6510	TN6520	TN6525	TN6540	WK15CM	WP25PM	WP40PM	WS30PM	WS40PM
HPGT06T3DZERLD	6	11	3,99	0,98	0,08	●	○	○	2957585	2957547	○	○	5895784	5895785	○	6180312

M640 • HPPT-GD

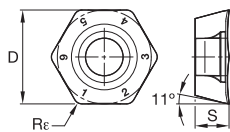
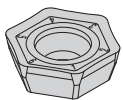

● first choice
○ alternate choice

P	●					●	●	●	●	○	○
M	●					○	○	○	○	○	○
K	●	○	○	○	○	○	○	○	○	○	○
N	○	○	○	○	○	○	○	○	○	○	○
S	○	○	○	○	○	○	○	○	○	○	○
H	○	○	○	○	○	○	○	○	○	○	○

ISO catalogue number	cutting edges	D	S	Rε	hm	THM	THM-U	TN6510	TN6520	TN6525	TN6540	WK15CM	WP25PM	WP40PM	WS30PM	WS40PM
HPPT06T3DZENGD	6	11	3,97	0,98	0,10	○	○	○	2957583	2957586	2957552	○	5895788	5895789	○	6180315

M640 • HPGT-GD

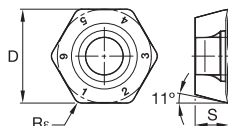
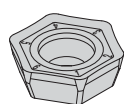

- first choice
- alternate choice

P	●								●	●	●	●	○	○
M	●								○	○	○	○	○	○
K	○	○	○	○	○	○	○	○	○	○	○	○	○	○
N	○	○	○	○	○	○	○	○	○	○	○	○	○	○
S	○	○	○	○	○	○	○	○	○	○	○	○	○	○
H	○	○	○	○	○	○	○	○	○	○	○	○	○	○

ISO catalogue number	cutting edges	D	S	Rε	hm	THM	THM-U	TN6510	TN6520	TN6525	TN6540	WK15CM	WP25PM	WP40PM	WS30PM	WS40PM
HPGT06T3DZENGD	6	11	3,97	0,98	0,10	●	●	○	○	○	○	○	○	○	○	○

M640 • HPGT-GD Wiper

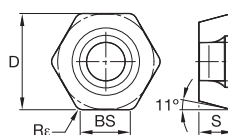

- first choice
- alternate choice

P	●									●	●	●	●	○	○
M	○									○	○	○	○	○	○
K	○	○	○	○	○	○	○	○	○	○	○	○	○	○	○
N	○	○	○	○	○	○	○	○	○	○	○	○	○	○	○
S	○	○	○	○	○	○	○	○	○	○	○	○	○	○	○
H	○	○	○	○	○	○	○	○	○	○	○	○	○	○	○

ISO catalogue number	cutting edges	D	S	BS	Rε	hm	THM	THM-U	TN6510	TN6520	TN6525	TN6540	WK15CM	WP25PM	WP40PM	WS30PM	WS40PM
HPGT06T3DZERGD3W	3	11	4,00	2,88	0,98	0,10	●	●	○	○	○	○	○	○	○	○	○

M640 • Insert Selection Guide

Material Group	Light Machining		General Purpose		Heavy Machining	
	Geometry	Grade	Geometry	Grade	Geometry	Grade
P1-P2	.E..LD	WP40PM	.E..GD	WP40PM	.E..GD	WP40PM
P3-P4	.E..LD	WP25PM	.E..GD	WS40PM	.E..GD	WS40PM
P5-P6	.E..LD	WP25PM	.E..GD	WP25PM	.E..GD	WP25PM
M1-M2	.E..LD	WP25PM	.E..GD	WP25PM	.E..GD	WP25PM
M3	.E..LD	WP40PM	.E..GD	WS30PM	.E..GD	WS30PM
K1-K2	.E..GD	TN6510	.E..GD	WK15CM	.E..GD	WK15CM
K3	.E..LD	TN6520	.E..GD	WP25PM	.E..GD	WP25PM
N1-N2	.E..LD	WS40PM	.E..GD	WS40PM	.E..GD	WS40PM
N3	.E..LD	WS40PM	.E..GD	WS40PM	.E..GD	WS40PM

M640 • Recommended Starting Speeds [m/min]

Material Group		TN6510			TN6520			TN6525			TN6540			WK15CM		
P	1	-	-	-	-	-	-	410	320	280	360	280	240	-	-	-
	2	-	-	-	-	-	-	320	250	215	250	190	170	-	-	-
	3	-	-	-	-	-	-	280	215	185	215	170	140	-	-	-
	4	-	-	-	-	-	-	235	170	145	180	130	110	-	-	-
	5	-	-	-	-	-	-	310	235	200	240	180	150	-	-	-
	6	-	-	-	-	-	-	205	160	130	160	120	100	-	-	-
M	1	-	-	-	-	-	-	190	120	80	130	80	60	-	-	-
	2	-	-	-	-	-	-	120	80	50	80	50	40	-	-	-
	3	-	-	-	-	-	-	125	80	55	85	50	40	-	-	-
K	1	480	350	260	450	320	230	275	245	220	220	205	180	505	460	410
	2	420	280	205	390	250	190	215	190	180	175	155	140	400	355	330
	3	335	260	200	300	230	160	180	160	145	155	145	125	335	300	275
N	1	-	-	-	-	-	-	-	-	-	-	-	-	-	-	-
	2	-	-	-	-	-	-	-	-	-	-	-	-	-	-	-
	3	-	-	-	-	-	-	-	-	-	-	-	-	-	-	-
S	1	-	-	-	-	-	-	-	-	-	50	35	30	-	-	-
	2	-	-	-	-	-	-	-	-	-	25	20	10	-	-	-
	3	-	-	-	-	-	-	-	-	-	70	40	30	-	-	-
	4	-	-	-	-	-	-	-	-	-	60	30	25	-	-	-
H	1	-	-	-	-	-	-	-	-	-	-	-	-	-	-	-
	2	-	-	-	-	-	-	-	-	-	-	-	-	-	-	-
	3	-	-	-	-	-	-	-	-	-	-	-	-	-	-	-

Material Group		WP25PM			WP40PM			WS30PM			WS40PM			THM-U			THM		
P	1	395	340	325	355	310	295	-	-	-	-	-	-	-	-	-	-	-	
	2	330	290	240	300	260	215	-	-	-	-	-	-	-	-	-	-	-	
	3	305	260	210	275	235	190	-	-	-	-	-	-	-	-	-	-	-	
	4	270	220	180	245	205	160	-	-	-	-	-	-	-	-	-	-	-	
	5	220	205	180	205	185	160	-	-	-	205	175	145	-	-	-	-	-	
	6	200	150	120	180	140	110	-	-	-	180	130	95	-	-	-	-	-	
M	1	245	215	200	235	205	185	270	240	220	250	205	170	-	-	-	-	-	
	2	220	190	155	210	180	150	245	215	175	215	175	145	-	-	-	-	-	
	3	170	145	115	155	140	110	185	160	125	175	130	100	-	-	-	-	-	
K	1	275	245	220	-	-	-	-	-	-	-	-	-	230	205	180	145	110	90
	2	215	190	180	-	-	-	-	-	-	-	-	-	-	-	-	150	120	85
	3	180	160	145	-	-	-	-	-	-	-	-	-	-	-	-	155	115	70
N	1	-	-	-	-	-	-	-	-	-	-	-	-	2400	1440	1200	1080	720	600
	2	-	-	-	-	-	-	-	-	-	-	-	-	1640	980	800	820	560	460
	3	-	-	-	-	-	-	-	-	-	-	-	-	960	600	480	540	335	240
S	1	50	40	30	50	40	35	55	50	35	50	40	30	-	-	-	-	-	-
	2	50	40	30	50	40	35	55	50	35	50	40	30	-	-	-	-	-	-
	3	60	50	30	60	50	35	65	55	35	60	50	30	-	-	-	-	-	-
	4	85	60	40	80	60	40	100	70	50	70	60	35	-	-	-	-	-	-
H	1	-	-	-	-	-	-	-	-	-	-	-	-	-	-	-	-	-	-
	2	-	-	-	-	-	-	-	-	-	-	-	-	-	-	-	-	-	-
	3	-	-	-	-	-	-	-	-	-	-	-	-	-	-	-	-	-	-

NOTE: FIRST choice starting speeds are in **bold** type.
As the average chip thickness increases, the speed should be decreased.

M640 • Recommended Starting Feeds [mm]

Light Machining	General Purpose	Heavy Machining
-----------------	-----------------	-----------------

Insert Geometry	Programmed Feed per Tooth (fz) as a % of Radial Depth of Cut (ae)															Insert Geometry
	5%			10%			20%			30%			40-100%			
.F..LDAL	0,13	0,34	0,47	0,10	0,25	0,34	0,07	0,18	0,25	0,06	0,16	0,22	0,06	0,15	0,20	.F..LDAL
.E..LD	0,13	0,34	0,47	0,10	0,25	0,34	0,07	0,18	0,25	0,06	0,16	0,22	0,06	0,15	0,20	.E..LD
.E..GD	0,13	0,48	0,54	0,10	0,35	0,39	0,07	0,26	0,29	0,06	0,23	0,25	0,06	0,21	0,23	.E..GD

NOTE: Use "Light Machining" value as starting feed rate.

M660

M660 Face Mill

The M660 face mill is designed with a strong tool body and perfect axial and radial runout for heavy roughing of steel and cast iron materials.



THREE CHIPBREAKERS FOR ALL HEAVY-DUTY APPLICATIONS IN STEEL AND CAST IRON

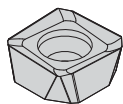

-20



Light Machining

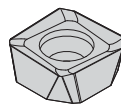

-21



General Purpose
Machining

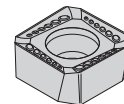

-31



General Purpose
and Heavy Machining

HEAVY-DUTY FACE MILLING OF STEEL AND CAST IRON

PRODUCT

SERIES

M660

DIAMETER RANGE

20–160mm

SHANK TYPES

Shell Mills
Weldon® End Mills

INDUSTRY



APPLICATIONS



FACE
MILLING

**HEAVY
DUTY**



M660 • Weldon® Shank SN1205.. • Metric

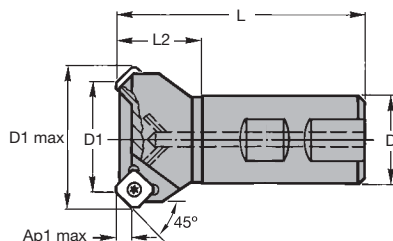

order number	catalogue number	D1	D1 max	D	L	L2	Ap1 max	Z	max RPM	coolant supply	kg
2002367	12396202200	20	33,8	25	86	30	6,4	2	17000	Yes	0,30
2002370	12396202600	25	38,7	25	91	35	6,4	2	15000	Yes	0,40

M660 • Shell Mills SN1205.. • Metric

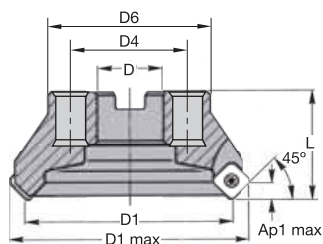

order number	catalogue number	D1	D1 max	D	D4	D6	L	Ap1 max	Z	max RPM	coolant supply	kg
2003541	12396203800	50	63,5	22	—	50	40	6,4	4	12500	Yes	0,45
2003558	12396204200	63	76,5	22	—	50	40	6,4	5	11000	Yes	0,60
2003575	12396204600	80	94,3	27	—	60	50	6,4	6	9900	Yes	1,15
2003582	12396205000	100	113,4	32	—	78	50	6,4	7	8900	No	1,60
2003679	12396205400	125	138,3	40	—	89	63	6,4	8	7900	No	2,80
2003780	12396205800	160	173,3	40	66,7	90	63	6,4	10	7000	No	4,10

FOR SPARE PARTS, PLEASE VISIT WIDIA.COM OR WIDIANOVO.COM.
MOUNTING SCREWS ARE NOT INCLUDED IN STANDARD PACKAGING.

M660 • SNKT-20 • SN1205..

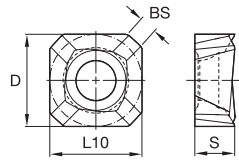
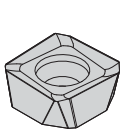

- first choice
- alternate choice

P	●	●	●	●	●	●	●	●	●	●
M	○	○	○	○	○	○	○	○	○	○
K	○	○	○	○	○	○	○	○	○	○
N	●									
S	○									
H										

ISO catalogue number	cutting edges	D	L10	S	BS	hm	THM	TN6525	TN6540	TT125	TTM08	WK15CM	WP25PM	WP35CM	WP40PM
SNKT1205AZER20	4	12,70	12,70	5,49	2,00	0,10	●	○	○	○	○	○	○	○	○
SNKT1205AZER20	4	12,70	12,70	5,49	2,00	—	○	○	○	○	○	○	○	○	○

M660 • SNKT-21 • SN1205..

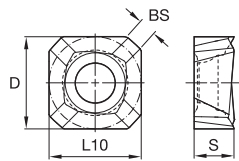
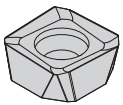

- first choice
- alternate choice

P	●	●	●	●	●	●	●	●	●	●
M	○	○	○	○	○	○	○	○	○	○
K	○	○	○	○	○	○	○	○	○	○
N	○	○	○	○	○	○	○	○	○	○
S	○									
H										

ISO catalogue number	cutting edges	D	L10	S	BS	hm	THM	TN6525	TN6540	TT125	TTM08	WK15CM	WP25PM	WP35CM	WP40PM
SNKT1205AZR21	4	12,70	12,70	5,56	1,54	0,15	○	○	○	○	○	○	○	○	○
SNKT1205AZR21	4	12,70	12,70	5,56	1,54	—	○	○	○	○	○	○	○	○	○

M660 • SNMT-31 • SN1205..

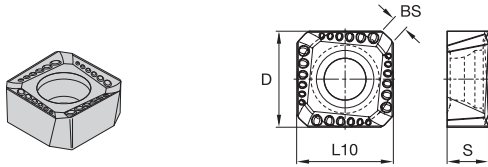

- first choice
- alternate choice

P	■	■	●	●	●	●	■	■	■	■
M	■	■	○	○	○	○	■	■	■	■
K	■	■	○	○	○	○	●	○	○	○
N	■	■	●	○	○	○	○	○	○	○
S	■	■	○	○	○	○	○	○	○	○
H	■	■	○	○	○	○	○	○	○	○

catalogue number	cutting edges	D	L10	S	BS	R _ε	hm	THM	TN6525	TN6540	TT125	TTM08	WK15CM	WP25PM	WP35CM	WP40PM
SNMT1205AZR31	4	12,70	12,70	5,56	1,54	—	0,16	■	●	○	○	○	○	○	○	○

M660 • SNKT-31 • SN1205..

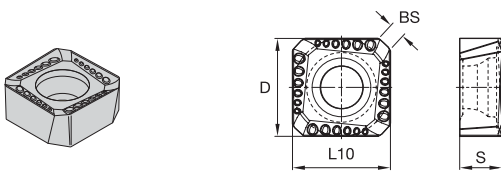

- first choice
- alternate choice

P	■	■	●	●	●	●	■	■	■	■
M	■	■	○	○	○	○	■	■	■	■
K	■	■	○	○	○	○	●	○	○	○
N	■	■	●	○	○	○	○	○	○	○
S	■	■	○	○	○	○	○	○	○	○
H	■	■	○	○	○	○	○	○	○	○

catalogue number	cutting edges	D	L10	S	BS	hm	THM	TN6525	TN6540	TT125	TTM08	WK15CM	WP25PM	WP35CM	WP40PM
SNKT1205AZR31	4	12,70	12,70	5,56	1,54	0,16	■	●	○	○	○	○	○	○	○

M660 • XNKT-11 Wiper • SN1205..

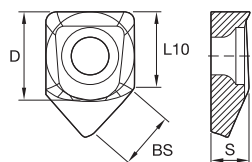
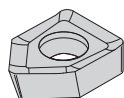

- first choice
- alternate choice

	P	M	K	N	S	H	THM	TN6525	TN6540	TT125	TTM08	WK15CM	WP25PM	WP35CM	WP40PM
P	●	○	○	○	○	○									
M	○	●	○	○	○	○									
K	○	○	●	○	○	○									
N	○	○	○	●	○	○									
S	○	○	○	○	●	○									
H	○	○	○	○	○	●									

ISO catalogue number	cutting edges	D	L10	S	BS	Rε	hm	THM	TN6525	TN6540	TT125	TTM08	WK15CM	WP25PM	WP35CM	WP40PM
XNKT1205AZER11	1	12,70	12,70	5,15	8,00	1,30	0,15	2015246	–	–	–	–	5427381	–	6842111	–

M660 • SN1205.. • Insert Selection Guide

Material Group	Light Machining		General Purpose		Heavy Machining	
	Geometry	Grade	Geometry	Grade	Geometry	Grade
P1-P2	...20	TN6540	...31	WP40PM	...31	WP40PM
P3-P4	...20	WP35CM	...31	WP35CM	...31	WP35CM
P5-P6	...20	WP35CM	...31	WP35CM	...31	WP35CM
M1-M2	...20	TN6540	...31	WP25PM	...31	WP25PM
M3	...20	WP35CM	...31	WP35CM	...31	WP35CM
K1-K2	...21	WK15CM	...31	WK15CM	...31	WK15CM
K3	...21	WK15CM	...31	WP35CM	...31	WP35CM
N1-N2	–	–	–	–	–	–
N3	–	–	–	–	–	–
S1-S2	...20	TN6540	...31	WP25PM	...31	WP25PM
S3	–	–	–	–	–	–
S4	...20	TN6540	...31	WP40PM	...31	WP40PM
H1	–	–	–	–	–	–

M660 • SN1205.. • Recommended Starting Speeds [m/min]

Material Group	TN6525			TN6540			TTM08			WP25PM			WP35CM			
P	1	410	320	280	360	280	240	230	200	190	395	340	325	455	395	370
	2	320	250	215	250	190	170	195	170	140	330	290	240	280	255	230
	3	280	215	185	215	170	140	180	150	125	305	260	210	255	230	205
	4	235	170	145	180	130	110	160	130	105	270	220	180	190	175	160
	5	310	235	200	240	180	150	-	-	-	220	205	180	260	230	210
	6	205	160	130	160	120	100	-	-	-	200	150	120	160	135	110
M	1	190	120	80	130	80	60	-	-	-	245	215	200	205	185	155
	2	120	80	50	80	50	40	-	-	-	220	190	155	185	160	140
	3	125	80	55	85	50	40	-	-	-	170	145	115	145	130	115
K	1	275	245	220	220	205	180	-	-	-	275	245	220	295	265	240
	2	215	190	180	175	155	140	-	-	-	215	190	180	235	210	190
	3	180	160	145	155	145	125	-	-	-	180	160	145	195	175	160
N	1	-	-	-	-	-	-	-	-	-	-	-	-	-	-	-
	2	-	-	-	-	-	-	-	-	-	-	-	-	-	-	-
	3	-	-	-	-	-	-	-	-	-	-	-	-	-	-	-
S	1	-	-	-	50	35	30	-	-	-	50	40	30	-	-	-
	2	-	-	-	25	20	10	-	-	-	50	40	30	-	-	-
	3	-	-	-	70	40	30	-	-	-	60	50	30	-	-	-
	4	-	-	-	60	30	25	-	-	-	85	60	40	66	50	33
H	1	-	-	-	-	-	-	-	-	-	-	-	-	-	-	-
	2	-	-	-	-	-	-	-	-	-	-	-	-	-	-	-
	3	-	-	-	-	-	-	-	-	-	-	-	-	-	-	-

Material Group	WK15CM			WP40PM			TT125			THM			
P	1	-	-	-	355	310	295	430	360	300	-	-	-
	2	-	-	-	300	260	215	310	250	215	-	-	-
	3	-	-	-	275	235	190	310	250	215	-	-	-
	4	-	-	-	245	205	160	265	215	180	-	-	-
	5	-	-	-	205	185	160	320	235	200	-	-	-
	6	-	-	-	180	140	110	145	110	90	-	-	-
M	1	-	-	-	235	205	185	480	310	215	-	-	-
	2	-	-	-	210	180	150	325	205	145	-	-	-
	3	-	-	-	155	140	110	320	210	145	-	-	-
K	1	505	460	410	-	-	-	220	185	155	145	110	90
	2	400	355	330	-	-	-	180	145	125	150	120	85
	3	335	300	275	-	-	-	145	125	100	155	115	70
N	1	-	-	-	-	-	-	-	-	-	1080	720	600
	2	-	-	-	-	-	-	-	-	-	820	560	460
	3	-	-	-	-	-	-	-	-	-	540	335	240
S	1	-	-	-	50	40	35	-	-	-	-	-	-
	2	-	-	-	50	40	35	-	-	-	-	-	-
	3	-	-	-	60	50	35	-	-	-	-	-	-
	4	-	-	-	80	60	40	-	-	-	-	-	-
H	1	-	-	-	-	-	-	-	-	-	-	-	-
	2	-	-	-	-	-	-	-	-	-	-	-	-
	3	-	-	-	-	-	-	-	-	-	-	-	-

NOTE: FIRST choice starting speeds are in **bold** type.
As the average chip thickness increases, the speed should be decreased.

M660 • SN1205.. • Recommended Starting Feeds [mm]

Light Machining	General Purpose	Heavy Machining
-----------------	-----------------	-----------------

Insert Geometry	Programmed Feed per Tooth (fz) as a % of Radial Depth of Cut (ae)															Insert Geometry
	5%			10%			20%			30%			40-100%			
...20	0,17	0,66	1,19	0,12	0,47	0,86	0,09	0,35	0,64	0,08	0,31	0,56	0,07	0,28	0,51	...20
...21	0,24	0,74	1,25	0,18	0,53	0,89	0,13	0,40	0,66	0,12	0,35	0,58	0,11	0,32	0,53	...21
...31	0,26	0,76	1,28	0,19	0,55	0,91	0,14	0,41	0,68	0,12	0,36	0,59	0,11	0,33	0,54	...31

NOTE: Use "Light Machining" value as starting feed rate.

M660 • Shell Mills SN1505..

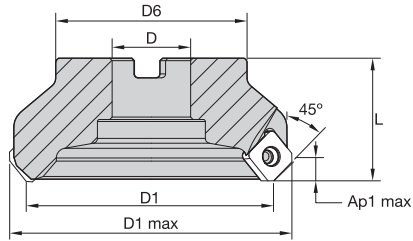

order number	catalogue number	D1	D1 max	D	D6	L	Ap1 max	Z	max RPM	coolant supply	kg
2003593	12396215000	100	116,9	32	78	50	8,0	7	8900	No	1,60

INDEXABLE MILLING

SOLID END MILLING

HOLEMAKING

TAPPING

TURNING

M660 • SNMT-31 • SN1505..

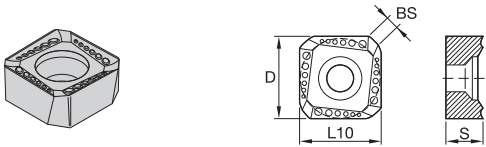

● first choice
○ alternate choice

P	•	•	•	•	•	•	•	•	•
M	•	•	•	•	•	•	•	•	•
K	•	•	•	•	•	•	•	•	•
N	•	•	•	•	•	•	•	•	•
S	•	•	•	•	•	•	•	•	•
H	•	•	•	•	•	•	•	•	•

catalogue number	cutting edges	D	L10	S	BS	hm	THM	TN6525	TN6540	TT125	TTM08	WK15CM	WP25PM	WP35CM	WP40PM
SNMT1505AZR31	4	16	15,88	5,56	2,00	0,16						5427386			
SNMT1505AZR31	4	16	15,88	5,56	—	0,16								6901873	

M660 • SNKT-31 • SN1505..

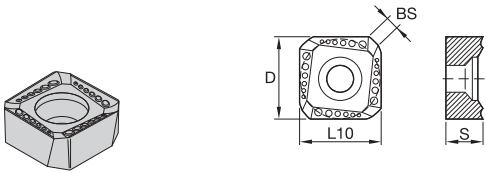

● first choice
○ alternate choice

P	•	•	•	•	•	•	•	•	•
M	•	•	•	•	•	•	•	•	•
K	•	•	•	•	•	•	•	•	•
N	•	•	•	•	•	•	•	•	•
S	•	•	•	•	•	•	•	•	•
H	•	•	•	•	•	•	•	•	•

ISO catalogue number	cutting edges	D	L10	S	BS	hm	THM	TN6525	TN6540	TT125	TTM08	WK15CM	WP25PM	WP35CM	WP40PM
SNKT1505AZR31	4	15,88	15,88	5,56	2,00	0,16						5427386		6843998	5895540

M660 • SN1505.. • Insert Selection Guide

Material Group	Light Machining		General Purpose		Heavy Machining	
	Geometry	Grade	Geometry	Grade	Geometry	Grade
P1-P2	...31	WP40PM	...31	WP40PM	...31	WP40PM
P3-P4	...31	WP25PM	...31	WP35CM	...31	WP35CM
P5-P6	...31	WP25PM	...31	WP35CM	...31	WP35CM
M1-M2	...31	WP25PM	...31	WP25PM	...31	WP25PM
M3	...31	WP35CM	...31	WP35CM	...31	WP35CM
K1-K2	...31	WK15CM	...31	WK15CM	...31	WK15CM
K3	...31	WK15CM	...31	WK35CM	...31	WK15CM
N1-N2	-	-	-	-	-	-
N3	-	-	-	-	-	-
S1-S2	...31	WP25PM	...31	WP25PM	...31	WP25PM
S3	-	-	-	-	-	-
S4	...31	WP40PM	...31	WP40PM	...31	WP40PM
H1	-	-	-	-	-	-

M660 • SN1505.. • Recommended Starting Speeds [m/min]

Material Group	TN6525			TN6540			WP25PM			WP35CM			
P	1	410	320	280	360	280	240	395	340	325	455	395	370
	2	320	250	215	250	190	170	330	290	240	280	255	230
	3	280	215	185	215	170	140	305	260	210	255	230	205
	4	235	170	145	180	130	110	270	220	180	190	175	160
	5	310	235	200	240	180	150	220	205	180	260	230	210
	6	205	160	130	160	120	100	200	150	120	160	135	110
M	1	190	120	80	130	80	60	245	215	200	205	185	155
	2	120	80	50	80	50	40	220	190	155	185	160	140
	3	125	80	55	85	50	40	170	145	115	145	130	115
K	1	275	245	220	220	205	180	275	245	220	295	265	240
	2	215	190	180	175	155	140	215	190	180	235	210	190
	3	180	160	145	155	145	125	180	160	145	195	175	160
N	1	-	-	-	-	-	-	-	-	-	-	-	-
	2	-	-	-	-	-	-	-	-	-	-	-	-
	3	-	-	-	-	-	-	-	-	-	-	-	-
S	1	-	-	-	50	35	30	50	40	30	-	-	-
	2	-	-	-	25	20	10	50	40	30	-	-	-
	3	-	-	-	70	40	30	60	50	30	-	-	-
	4	-	-	-	60	30	25	85	60	40	66	50	33
H	1	-	-	-	-	-	-	-	-	-	-	-	-
	2	-	-	-	-	-	-	-	-	-	-	-	-
	3	-	-	-	-	-	-	-	-	-	-	-	-

Material Group	WK15CM			WP40PM			TT125			THM			
P	1	-	-	-	355	310	295	430	360	300	-	-	-
	2	-	-	-	300	260	215	310	250	215	-	-	-
	3	-	-	-	275	235	190	310	250	215	-	-	-
	4	-	-	-	245	205	160	265	215	180	-	-	-
	5	-	-	-	205	185	160	320	235	200	-	-	-
	6	-	-	-	180	140	110	145	110	90	-	-	-
M	1	-	-	-	235	205	185	480	310	215	-	-	-
	2	-	-	-	210	180	150	325	205	145	-	-	-
	3	-	-	-	155	140	110	320	210	145	-	-	-
K	1	505	460	410	-	-	-	220	185	155	145	110	90
	2	400	355	330	-	-	-	180	145	125	150	120	85
	3	335	300	275	-	-	-	145	125	100	155	115	70
N	1	-	-	-	-	-	-	-	-	-	1080	720	600
	2	-	-	-	-	-	-	-	-	-	820	560	460
	3	-	-	-	-	-	-	-	-	-	540	335	240
S	1	-	-	-	50	40	35	-	-	-	-	-	-
	2	-	-	-	50	40	35	-	-	-	-	-	-
	3	-	-	-	60	50	35	-	-	-	-	-	-
	4	-	-	-	80	60	40	-	-	-	-	-	-
H	1	-	-	-	-	-	-	-	-	-	-	-	-
	2	-	-	-	-	-	-	-	-	-	-	-	-
	3	-	-	-	-	-	-	-	-	-	-	-	-

NOTE: FIRST choice starting speeds are in **bold** type.
As the average chip thickness increases, the speed should be decreased.

M660 • SN1505.. • Recommended Starting Feeds [mm]

Light Machining	General Purpose	Heavy Machining
-----------------	-----------------	-----------------

Insert Geometry	Programmed Feed per Tooth (fz) as a % of Radial Depth of Cut (ae)															Insert Geometry
	5%			10%			20%			30%			40-100%			
...31	0,33	0,84	1,35	0,24	0,60	0,97	0,18	0,45	0,72	0,16	0,39	0,63	0,14	0,36	0,57	...31

NOTE: Use "Light Machining" value as starting feed rate.

M1600 Series

M1600, M1600 Mini-F Face Mills

The M1600 Series includes versatile, 16-edged face mills for roughing, semi-finishing, and finishing of steel, cast iron, and nodular iron materials that will run in low-power machines, unstable and non-rigid set-ups, and long overhang conditions.



M1600 MINI-F

The M1600 Mini-F face mill is a finishing solution with an A_p max of 2,1mm to achieve surface finish below Ra 1,6.



M1600

The M1600 standard sized face mill is a reliable semi-finishing and roughing tool with an A_p max of 3,7mm and lead angle of 43 degrees.

M1600 MINI-F INSERTS

SEMI-FINISH INSERTS



WK15CM



WU10PM



WU20PM



WIPER INSERTS



THM-F



WU10PM



M1600 INSERTS

-MM



WK15CM



WK15CM is a wear-resistant grade with balanced toughness for general milling of cast irons. Best results in dry machining, but can also be used wet.

WP35CM





WP35CM has a wide range of applications in general and rough milling of steels and cast iron. Performs best in dry, but can also be used under wet conditions.

WU20PM



WU20PM is a universal grade for machining of steel, stainless steel, and high-temperature alloys. Also suitable for machining of gray and nodular irons. Resists breakage and offers improved wear resistance and increased strength. Can be used for both dry and wet machining.

VERSATILE FACE MILL FOR ALL MACHINE CONDITIONS

PRODUCT		INSERTS		
SERIES	DIAMETER RANGE	INSERT TYPE	GRADE	MATERIALS
M1600 MINI-F	80–160mm	MM, Wiper	WK15CM, WU10PM, WU20PM Wiper: THM-F, WU10PM	
M1600	50–160mm	MM	WK15CM, WP35CM, WU20PM	

APPLICATIONS



FACE
MILLING

INDUSTRY



43°

LEAD ANGLE

redistributes cutting forces in the spindle z-axis direction.



M1600 Mini-F • 42° • Shell Mills • Metric

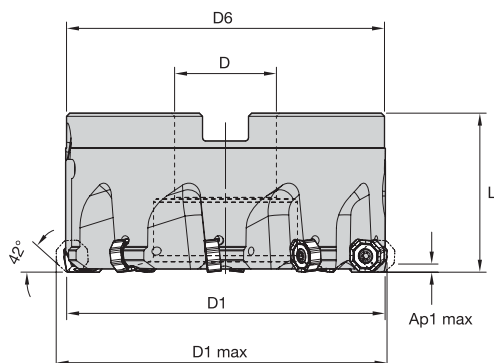

order number	catalogue number	D1	D1 max	D	D6	L	Ap1 max	Z	max RPM	coolant supply	kg
5626416	M1600D080Z08W2S27ON04	80	86,4	27	80	50	2,1	8	—	No	1,56
5626417	M1600D100Z10W2S32ON04	100	106,4	32	100	50	2,1	10	—	No	4,79
5546056	M1600D125Z12W3S40ON04	125	131,4	40	89	63	2,1	12	—	No	8,39
5626418	M1600D160Z16W4S40ON04	160	166,4	40	90	63	2,1	16	5700	No	6,40

FOR SPARE PARTS, PLEASE VISIT WIDIA.COM OR WIDIANOVO.COM.
MOUNTING SCREWS ARE NOT INCLUDED IN STANDARD PACKAGING.

M1600 Mini-F • ONGX-MM

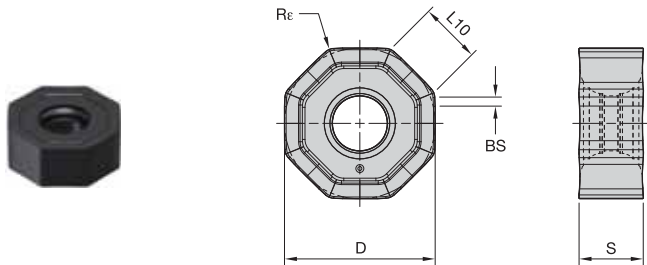

- first choice
- alternate choice

P	■	■	■	■	■	■	■
M	■	■	■	■	■	■	■
K	■	●	●	●	●	○	○
N	■	●	○	○	○	○	○
S	■	○	○	○	○	○	○
H	■	○	○	○	○	○	○

ISO catalogue number	cutting edges	D	L10	S	BS	Re	hm	THM-F	WK15CM	WU10PM	WU20PM
ONGX04T308ANSNMM	16	10	4,10	3,97	0,60	0,80	0,04	■	6095310	6243772	■
ONGX04T308ANSNMM	16	10	4,10	3,97	0,60	0,80	0,05	■	■	■	6291724

M1600 Mini-F • Wiper Inserts • XDHX-W2C

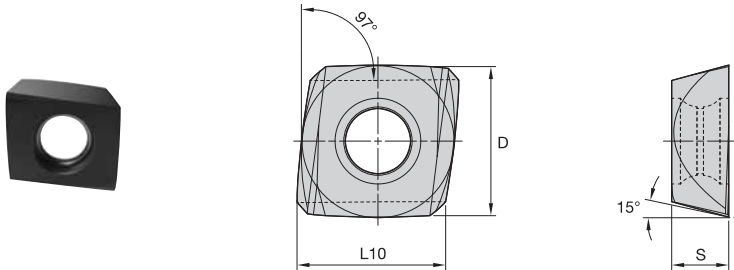

- first choice
- alternate choice

P	■	■	■	■	■	■	■
M	■	■	■	■	■	■	■
K	■	●	●	●	●	○	○
N	■	●	○	○	○	○	○
S	■	○	○	○	○	○	○
H	■	○	○	○	○	○	○

ISO catalogue number	cutting edges	D	L10	S	Re	hm	THM-F	WK15CM	WU10PM	WU20PM
XDHX1004RW2C	2	13	8,72	4,76	0,00	0,02	6739214	■	■	■
XDHX1004RW2C	2	13	—	4,76	—	0,02	■	■	6877620	■

M1600 Mini-F • Insert Selection Guide

Material Group	Light Machining		General Purpose		Heavy Machining	
	Geometry	Grade	Geometry	Grade	Geometry	Grade
P1-P2	.S.MM	WU10PM	.S.MM	WU10PM	.S.MM	WU20PM
P3-P4	.S.MM	WU10PM	.S.MM	WU20PM	.S.MM	WU20PM
P5-P6	.S.MM	WU20PM	.S.MM	WU20PM	.S.MM	WU20PM
M1-M2	.S.MM	WU20PM	.S.MM	WU20PM	.S.MM	WU20PM
M3	.S.MM	WU20PM	.S.MM	WU20PM	.S.MM	WU20PM
K1-K2	.S.MM	WK15CM	.S.MM	WK15CM	.S.MM	WU20PM
K3	.S.MM	WU20PM	.S.MM	WU10PM	.S.MM	WK15CM
N1-N2	.S.MM	WU10PM	.S.MM	WU10PM	.S.MM	WU20PM
N3	.S.MM	WU10PM	.S.MM	WU10PM	.S.MM	WU20PM
S1-S2	.S.MM	WU20PM	.S.MM	WU20PM	.S.MM	WU20PM
S3	.S.MM	WU20PM	.S.MM	WU20PM	.S.MM	WU20PM
S4	.S.MM	WU20PM	.S.MM	WU20PM	.S.MM	WU20PM
H1	.S.MM	WU10PM	.S.MM	WU20PM	.S.MM	WU20PM

M1600 Mini-F • Recommended Starting Speeds [m/min]

Material Group		WK15CM			WU10PM			WU20PM			THM-F																																																																			
		P	1	-	-	-	-	-	-	330	290	270	-	-	-	2	-	-	-	-	-	-	275	250	200	-	-	-	3	-	-	-	-	-	-	255	220	175	-	-	-	4	-	-	-	245	200	170	225	190	150	-	-	-	5	-	-	-	-	-	-	185	175	150	-	-	-	6	-	-	-	-	-	-	165	130	100	-
M	1	-	-	-	-	-	-	205	180	165	-	-	-	2	-	-	-	-	-	185	160	130	-	-	-	3	-	-	-	-	-	-	140	120	95	-	-	-																																								
K	1	420	385	340	295	265	240	250	220	185	190	170	150	2	335	295	275	230	205	190	200	180	150	-	-	-	3	280	250	230	195	175	160	180	150	120	-	-	-																																							
N	1	-	-	-	640	570	525	550	470	400	795	695	600	2	-	-	-	640	570	525	550	470	400	795	695	600	3	-	-	-	580	535	490	400	350	300	-	-	-																																							
S	1	-	-	-	-	-	-	40	35	25	-	-	-	2	-	-	-	-	-	40	35	25	-	-	-	3	-	-	-	-	-	-	50	40	25	-	-	-	4	-	-	-	-	-	-	70	50	35	-	-	-																											
H	1	-	-	-	160	130	90	110	80	70	-	-	-																																																																	

NOTE: FIRST choice starting speeds are in bold type.
As the average chip thickness increases, the speed should be decreased.

M1600 Mini-F • Recommended Starting Feeds [mm]

Insert Geometry	Programmed Feed per Tooth (fz) as a % of Radial Depth of Cut (ae)												Insert Geometry			
	5%			10%			20%			30%				40-100%		
.S.MM	0,17	0,61	1,23	0,12	0,44	0,88	0,09	0,33	0,66	0,08	0,29	0,57	0,07	0,26	0,52	.S.MM

NOTE: First choice starting feed (fz) is in bold type.
Use corresponding speed (vc).
fz and vc are valid for ae ≥ 0,4 D1.
For smaller ae, fz and vc should be multiplied by the factor given below:

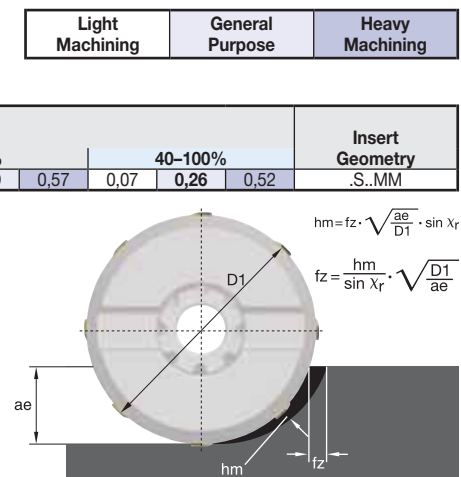

M1600 • 43° • Shell Mills • Metric

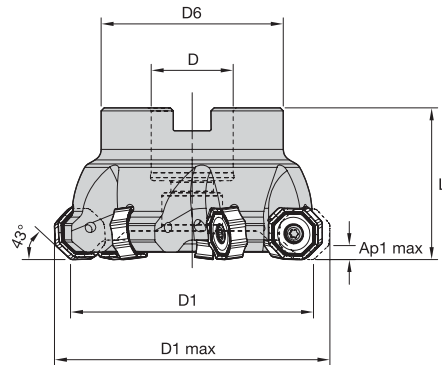

order number	catalogue number	D1	D1 max	D	D6	L	Ap1 max	Z	max RPM	coolant supply	kg
4002796	M1600D050Z04S22ON06	50	60,7	22	40	40	3,7	4	—	Yes	0,28
4002797	M1600D063Z05S22ON06	63	73,7	22	40	40	3,7	5	—	Yes	0,43
3837977	M1600D080Z07S27ON06	80	90,7	27	60	50	3,7	7	—	Yes	0,97
3860336	M1600D100Z09S32ON06	100	110,7	32	78	50	3,7	9	—	Yes	1,52
3837978	M1600D125Z11S40ON06	125	135,7	40	89	63	3,7	11	6900	Yes	2,70
4002798	M1600D160Z13S40ON06	160	170,7	40	90	63	3,7	13	—	Yes	3,83

INDEXABLE MILLING

SOLID END MILLING

HOLEMAKING

TAPPING

TURNING

M1600 • ONGX-MM • General Purpose Face Milling

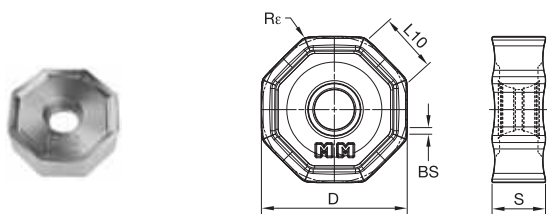

- first choice
- alternate choice

P	■	■	●
M	■	■	●
K	●	○	○
N	■	○	○
S	■	○	○
H	■	○	○

ISO catalogue number	cutting edges	D	L10	S	BS	Re	hm			
ONGX060512ANSNMM	16	17	6,87	5,47	0,77	1,20	0,04	6072424	WK15CM	WP35CM
ONGX060512ANSNMM	16	17	6,87	5,47	0,77	1,20	0,06	6652431		WU20PM
										3778942

INDEXABLE MILLING

SOLID END MILLING

HOLEMAKING

TAPPING

TURNING

M1600 • Insert Selection Guide

Material Group	Light Machining		General Purpose		Heavy Machining	
	Geometry	Grade	Geometry	Grade	Geometry	Grade
P1-P2	.S.MM	WP35CM	.S.MM	WP35CM	.S.MM	WU20PM
P3-P4	.S.MM	WP35CM	.S.MM	WP35CM	.S.MM	WU20PM
P5-P6	.S.MM	WP35CM	.S.MM	WP35CM	.S.MM	WP35CM
M1-M2	.S.MM	WU20PM	.S.MM	WU20PM	.S.MM	WU20PM
M3	.S.MM	WP35CM	.S.MM	WP35CM	.S.MM	WP35CM
K1-K2	.S.MM	WK15CM	.S.MM	WK15CM	.S.MM	WU20PM
K3	.S.MM	WU20PM	.S.MM	WU20PM	.S.MM	WK15CM
N1-N2	.S.MM	WU20PM	.S.MM	WU20PM	.S.MM	WU20PM
N3	.S.MM	WU20PM	.S.MM	WU20PM	.S.MM	WU20PM
S1-S2	.S.MM	WU20PM	.S.MM	WU20PM	.S.MM	WU20PM
S3	.S.MM	WU20PM	.S.MM	WU20PM	.S.MM	WU20PM
S4	.S.MM	WP35CM	.S.MM	WU20PM	.S.MM	WU20PM
H1	.S.MM	WU20PM	-	-	-	-

M1600 • Recommended Starting Speeds [m/min]

Material Group		WP35CM			WK15CM			WU20PM		
P	1	455	395	370	-	-	-	330	290	270
	2	280	255	230	-	-	-	275	250	200
	3	255	230	205	-	-	-	255	220	175
	4	190	175	160	-	-	-	225	190	150
	5	260	230	210	-	-	-	185	175	150
	6	160	135	110	-	-	-	165	130	100
M	1	205	185	155	-	-	-	205	180	165
	2	185	160	140	-	-	-	185	160	130
	3	145	130	115	-	-	-	140	120	95
K	1	295	265	240	420	385	340	250	220	185
	2	235	210	190	335	295	275	200	180	150
	3	195	175	160	280	250	230	180	150	120
N	1	-	-	-	-	-	-	550	470	400
	2	-	-	-	-	-	-	550	470	400
	3	-	-	-	-	-	-	400	350	300
S	1	-	-	-	-	-	-	40	35	25
	2	-	-	-	-	-	-	40	35	25
	3	-	-	-	-	-	-	50	40	25
	4	-	-	-	-	-	-	70	50	35
H	1	-	-	-	-	-	-	110	80	70

NOTE: First choice starting feed (fz) is in bold type.
As the average chip thickness increases, the speed should be decreased.

M1600 • Recommended Starting Feeds [mm]

Insert Geometry	Programmed Feed per Tooth (fz) as a % of Radial Depth of Cut (ae)														Insert Geometry	
	5%			10%			20%			30%			40-100%			
.S.MM	0,26	0,85	1,42	0,19	0,62	1,01	0,14	0,46	0,75	0,12	0,40	0,66	0,11	0,37	0,60	.S.MM

NOTE: First choice starting feed (fz) is in bold type.
Use corresponding speed (vc).
fz and vc are valid for ae ≥ 0,4 D1.
For smaller ae, fz and vc should be multiplied by the factor given below:

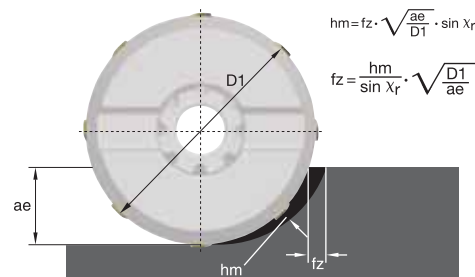

M1200 Series

M1200 Mini, M1200, M1200 Max Face Mills



M1200 MINI

The M1200 mini face mill is a first-choice for low depth of cut face milling that will improve productivity on taper 40 spindle milling machines.



M1200

The M1200 standard sized face mill is an all-inclusive series that will improve productivity on taper 50 spindle milling machines and driven tools using 15-, 45-, and 60-degree lead angles.



M1200 MAX SCREW CLAMPING • FOR BIGGER STOCK REMOVAL

The M1200 Max is a 12-edged face mill for customers who need to run at a higher DOC (up to 7,5mm) in steel, stainless steel, gray cast iron, and nodular iron.



M1200 MAX WEDGE CLAMPING • FOR CAST IRON COMPONENTS

The M1200 Max wedge clamping is a 12-edged face mill for medium roughing - semi-finishing while running higher DOC (up to 7,5mm) in gray cast iron and nodular iron components.

ONE INSERT STYLE FITS INTO ALL DIFFERENT CUTTER BODY VERSIONS

M1200 &
M1200 MINI HF
High-Feed 15°

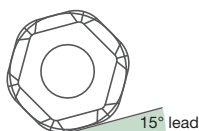

M1200 &
M1200 MINI
45°

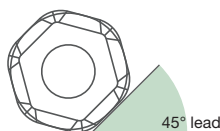

M1200 &
M1200 MINI HD
60°

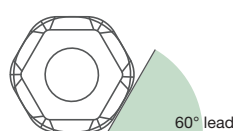

WIPER
(XNGJ)

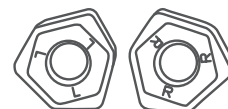

3RH + 3LH

12-EDGED FACE MILL

PRODUCT		INSERTS		
SERIES	DIAMETER RANGE	GEOMETRY	GRADE	MATERIALS
M1200 MINI HNPJ0905... - PRESSED AND SINTERED TO SIZE HNGJ0905... - PRECISION GROUND	25–125mm	LDJ — Machining Aluminum	WK15CM, WK25YM	K
			WP35CM, WP25PM	P M S
M1200 HNPJ0905... - PRESSED AND SINTERED TO SIZE HNGJ0905... - PRECISION GROUND	40–315mm	LD — Light Machining	WP40PM	P M
		GD — General Purpose	WS30PM	S
M1200 MAX HNMU1107... - PRESSED AND SINTERED TO SIZE HNMF1107... - PRESSED AND SINTERED TO SIZE	63–250mm		WS40PM	P M S
		HD — Heavy Machining	TN6501, THM-U	N
		MM — Medium Machining	WK15CM, WP35CM, WU20PM	P M K

APPLICATIONS



WELDON®
SHANK



WELDON: 2
FLAT



FACE
MILLING



EASED
CHAMFER

INDUSTRY



M1200 Mini • 15° • High Feed • Screw-On End Mills • Metric

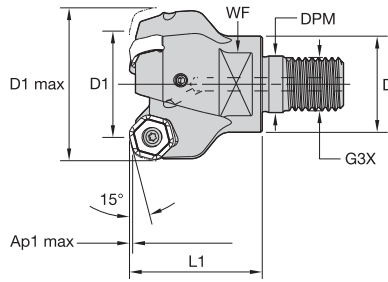

order number	catalogue number	D1	D1 max	D	DPM	G3X	L1	WF	Ap1 max	Z	max RPM	coolant supply	kg
4136875	M1200HF025Z03M16HN07	25	39	29	17,0	M16	32	22	1,7	3	20000	Yes	0,2

M1200 Mini • 15° • High Feed • Cylindrical Shank • Metric

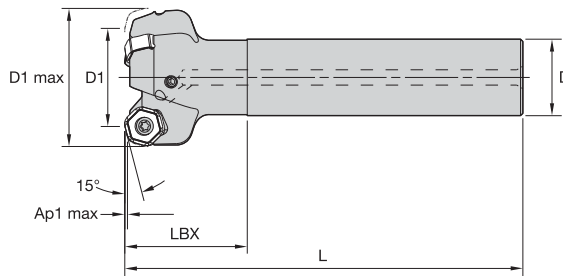

order number	catalogue number	D1	D1 max	D	L	LBX	Ap1 max	Z	max RPM	coolant supply	kg
4136882	M1200HF032Z03A25HN07L130	32	46,1	25	130	40	1,7	3	17600	Yes	0,52
4136883	M1200HF032Z04A25HN07L130	32	46,1	25	130	40	1,7	4	17600	Yes	0,53

M1200 Mini • 15° • High Feed • Shell Mills • Metric

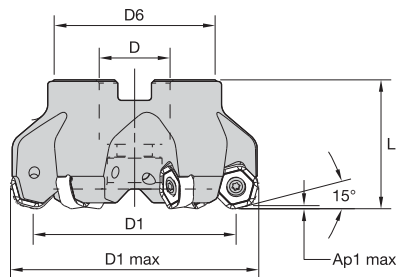

order number	catalogue number	D1	D1 max	D	D6	L	Ap1 max	Z	max RPM	coolant supply	kg
4136884	M1200HF040Z05HN07	40	54,1	22	38	40	1,7	5	15800	Yes	0,29
4136885	M1200HF050Z05HN07	50	64,1	22	38	40	1,7	5	12700	Yes	0,40
4136886	M1200HF063Z06HN07	63	77,1	22	50	40	1,7	6	10100	Yes	0,67
4136887	M1200HF080Z08HN07	80	94,1	27	60	50	1,7	8	7900	Yes	1,26

FOR SPARE PARTS, PLEASE VISIT WIDIA.COM OR WIDIANOVO.COM.
MOUNTING SCREWS ARE NOT INCLUDED IN STANDARD PACKAGING.

M1200 Mini • 45° • Screw-On End Mills • Metric

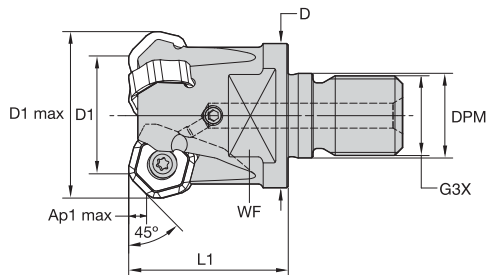

order number	catalogue number	D1	D1 max	D	DPM	G3X	L1	WF	Ap1 max	Z	max RPM	coolant supply	kg
3957840	M1200D025Z03M16HN07	25	33,7	29	17,0	M16	32	22	3,5	3	20000	Yes	0,13
3957841	M1200D032Z03M16HN07	32	40,7	29	17,0	M16	40	22	3,5	3	17600	Yes	0,20
3957842	M1200D032Z04M16HN07	32	40,7	29	17,0	M16	40	22	3,5	4	17600	Yes	0,20

M1200 Mini • 45° • Weldon® End Mills • Metric

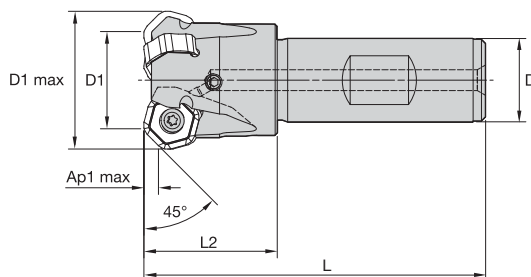

order number	catalogue number	D1	D1 max	D	L	L2	Ap1 max	Z	max RPM	coolant supply	kg
3958012	M1200D025Z03B20HN07	25	33,7	20	82	32	3,5	3	20000	Yes	0,21
3958023	M1200D032Z03B25HN07	32	40,7	25	97	40	3,5	3	17600	Yes	0,39
3958024	M1200D032Z04B25HN07	32	40,7	25	97	40	3,5	4	17600	Yes	0,40

M1200 Mini • 45° • Cylindrical Shank • Metric

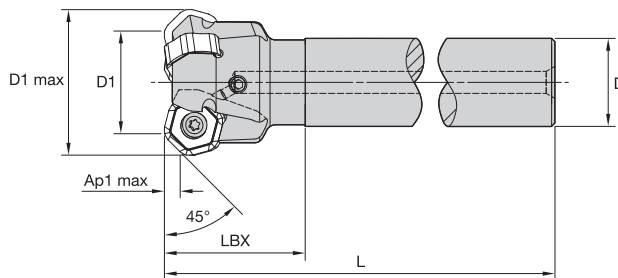

order number	catalogue number	D1	D1 max	D	L	LBX	Ap1 max	Z	max RPM	coolant supply	kg
3958025	M1200D025Z02A20HN07L120	25	33,7	20	120	32	3,5	2	20000	Yes	0,29
3958026	M1200D025Z03A20HN07L120	25	33,7	20	120	32	3,5	3	20000	Yes	0,28
3958029	M1200D025Z02A25HN07L200	25	33,7	25	200	32	3,5	2	20000	Yes	0,72
3958030	M1200D025Z03A25HN07L200	25	33,7	25	200	32	3,5	3	20000	Yes	0,71
3958027	M1200D032Z03A25HN07L130	32	40,7	25	130	40	3,5	3	17600	Yes	0,49
3958028	M1200D032Z04A25HN07L130	32	40,7	25	130	40	3,5	4	17600	Yes	0,50

M1200 Mini • 45° • Shell Mills • Metric

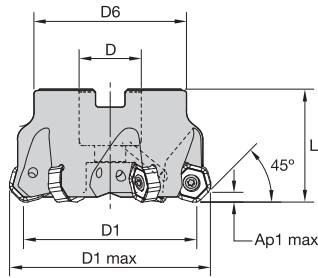

order number	catalogue number	D1	D1 max	D	D6	L	Ap1 max	Z	max RPM	coolant supply	kg
3957995	M1200D040Z04HN07	40	48,7	22	38	40	3,5	4	15800	Yes	0,26
3957996	M1200D040Z05HN07	40	48,7	22	38	40	3,5	5	15800	Yes	0,26
3957997	M1200D050Z04HN07	50	58,7	22	38	40	3,5	4	12700	Yes	0,35
3957998	M1200D050Z05HN07	50	58,7	22	38	40	3,5	5	12700	Yes	0,36
3957999	M1200D050Z06HN07	50	58,7	22	38	40	3,5	6	12700	Yes	0,35
3958000	M1200D063Z04HN07	63	71,7	22	50	40	3,5	4	10100	Yes	0,58
3958001	M1200D063Z06HN07	63	71,7	22	50	40	3,5	6	10100	Yes	0,65
3958002	M1200D063Z08HN07	63	71,7	22	50	40	3,5	8	10100	Yes	0,62
3958003	M1200D080Z05HN07	80	88,7	27	60	50	3,5	5	7900	Yes	1,11
3958004	M1200D080Z08HN07	80	88,7	27	60	50	3,5	8	7900	Yes	1,24
3958005	M1200D080Z10HN07	80	88,7	27	60	50	3,5	10	7900	Yes	1,17
3958006	M1200D100Z06HN07	100	108,7	32	80	50	3,5	6	6300	Yes	1,71
3958007	M1200D100Z09HN07	100	108,7	32	80	50	3,5	9	6300	Yes	1,82
3958008	M1200D100Z12HN07	100	108,7	32	80	50	3,5	12	6300	Yes	1,82
4138470	M1200D125Z08HN07	125	133,7	40	90	63	3,5	8	5050	Yes	2,84
4138471	M1200D125Z12HN07	125	133,7	40	90	63	3,5	12	5050	Yes	2,96
4138472	M1200D125Z16HN07	125	133,7	40	90	63	3,5	16	5050	Yes	3,02

NOTE: Mounting screw with coolant groove, coolant screw assembly, coolant lock screw, and coolant cap must be ordered separately.

M1200 Mini • 60° • Shell Mills • Metric

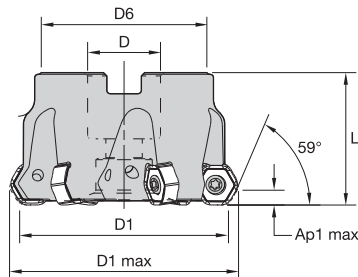

order number	catalogue number	D1	D1 max	D	D6	L	Ap1 max	Z	max RPM	coolant supply	kg
4136863	M1200HD040Z05HN07	40	46,8	22	38	40	4,7	5	15800	Yes	0,22
4136865	M1200HD050Z05HN07	50	56,8	22	38	40	4,7	5	12700	Yes	0,34
4136867	M1200HD063Z06HN07	63	69,8	22	50	40	4,7	6	10100	Yes	0,60
4136868	M1200HD080Z05HN07	80	86,8	27	60	50	4,7	5	7900	Yes	1,11
4136869	M1200HD080Z08HN07	80	86,8	27	60	50	4,7	8	7900	Yes	1,17
4136870	M1200HD100Z06HN07	100	106,7	32	80	50	4,7	6	6300	Yes	1,74
4136871	M1200HD100Z09HN07	100	106,7	32	80	50	4,7	9	6300	Yes	1,74
4136872	M1200HD125Z08HN07	125	131,7	40	90	63	4,7	8	5050	Yes	2,86
4136873	M1200HD125Z12HN07	125	131,7	40	90	63	4,7	12	5050	Yes	2,90

NOTE: Mounting screw with coolant groove, coolant screw assembly, coolant lock screw, and coolant cap must be ordered separately.

FOR SPARE PARTS, PLEASE VISIT WIDIA.COM OR WIDIANOVO.COM.

MOUNTING SCREWS ARE NOT INCLUDED IN STANDARD PACKAGING.

M1200 Mini • HNGJ-LDJ • HN0704

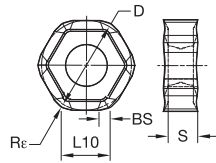
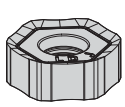

- first choice
- alternate choice

P						●	●	●	●	●	○	○
M						○	○	○	○	○	○	○
K	●	●	●	●	●	○	○	○	○	○	○	○
N	○	○	○	○	○	○	○	○	○	○	○	○
S						●	●	●	●	●	○	○
H												

ISO catalogue number	cutting edges	D	L10	S	BS	Rε	hm	THM-U	TN6501	TN6510	TN6520	TN6525	TN6540	WK15CM	WP25PM	WP35CM	WP40PM	WS30PM	WS40PM
HNGJ0704ANFLDJ	12	13	6,84	4,48	1,51	1,20	0,08	3954332	3954414	●	●	●	●	●	●	●	●	○	○

M1200 Mini • HNGJ-LD • HN0704

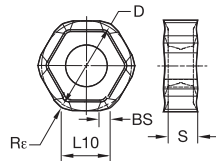

- first choice
- alternate choice

P						●	●	●	●	●	○	○
M						○	○	○	○	○	○	○
K	●	●	●	●	●	○	○	○	○	○	○	○
N	○	○	○	○	○	○	○	○	○	○	○	○
S						●	●	●	●	●	○	○
H												

ISO catalogue number	cutting edges	D	L10	S	BS	Rε	hm	THM-U	TN6501	TN6510	TN6520	TN6525	TN6540	WK15CM	WP25PM	WP35CM	WP40PM	WS30PM	WS40PM
HNGJ070432ANENLD	12	13	6,00	4,48	—	3,21	0,08	●	●	●	●	●	●	●	●	●	○	○	○
HNGJ0704ANENLD	12	13	6,84	4,48	1,60	1,20	0,08	●	●	3954419	3954420	3954421	3954422	●	5895291	5895292	5550905	5528975	6180295

M1200 Mini • HNPJ-GD • HN0704

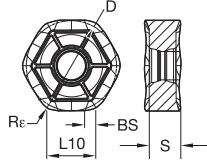

- first choice
- alternate choice

	P	M	K	N	S	H															
THM-U																					
TN6501																					
TN6510																					
TN6520																					
TN6525																					
TN6540																					
WK15CM																					
WP25PM																					
WP35CM																					
WP40PM																					
WS30PM																					
WS40PM																					

ISO catalogue number	cutting edges	D	L10	S	BS	Rε	hm	THM-U	TN6501	TN6510	TN6520	TN6525	TN6540	WK15CM	WP25PM	WP35CM	WP40PM	WS30PM	WS40PM	
HNPJ0704ANSNGD	12	13	6,80	4,45	1,45	1,20	0,10	●	●	●	●	●	●	●	●	●	●	●	●	●

M1200 Mini • HNPJ-HD • HN0704

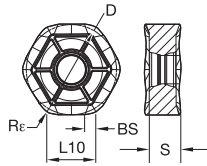

- first choice
- alternate choice

	P	M	K	N	S	H															
THM-U																					
TN6501																					
TN6510																					
TN6520																					
TN6525																					
TN6540																					
WK15CM																					
WP25PM																					
WP35CM																					
WP40PM																					
WS30PM																					
WS40PM																					

ISO catalogue number	cutting edges	D	L10	S	BS	Rε	hm	THM-U	TN6501	TN6510	TN6520	TN6525	TN6540	WK15CM	WP25PM	WP35CM	WP40PM	WS30PM	WS40PM	
HNPJ0704ANSNHD	12	13	6,80	4,41	1,45	1,20	0,14	●	●	●	●	●	●	●	●	●	●	●	●	●
HNPJ070432ANSNHD	12	13	6,84	4,42	—	3,20	0,14	●	●	●	●	●	●	●	●	●	●	●	●	●

M1200 Mini • XNGJ-LDJ-3 Wiper • XN0704

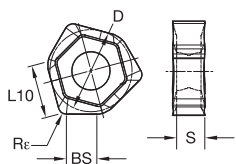
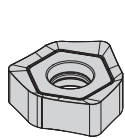

● first choice
○ alternate choice

ISO catalogue number	cutting edges	D	L10	S	BS	R ϵ	hm	THM-U	TN6501	TN6510	TN6520	TN6525	TN6540	WK15CM	WP25PM	WP35CM	WP40PM	WS30PM	WS40PM	
XNGJ0704ANFNLDJ3W	3	13	6,78	4,47	6,78	1,30	0,08	3954433	●	●	●	●	●	●	●	●	●	●	●	●

M1200 Mini • XNGJ-LD3 Wiper • XN0704

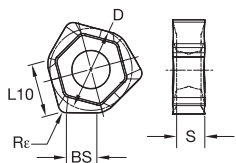
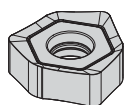

● first choice
○ alternate choice

ISO catalogue number	cutting edges	D	L10	S	BS	R ϵ	hm	THM-U	TN6501	TN6510	TN6520	TN6525	TN6540	WK15CM	WP25PM	WP35CM	WP40PM	WS30PM	WS40PM
XNGJ0704ANENLD3W	3	13	6,78	4,47	6,78	1,30	0,08	●	●	●	●	●	●	●	●	●	●	●	●

M1200 Mini • Insert Selection Guide

Material Group	Light Machining		General Purpose		Heavy Machining	
	Geometry	Grade	Geometry	Grade	Geometry	Grade
P1-P2	.E..LD	WP40PM	.S..GD	WP40PM	.S..HD	WP40PM
P3-P4	.E..LD	WP25PM	.S..GD	WP35CM	.S..HD	WP35CM
P5-P6	.E..LD	WP25PM	.S..GD	WP35CM	.S..HD	WP35CM
M1-M2	.E..LD	WP25PM	.S..GD	WP25PM	.S..HD	WP25PM
M3	.E..LD	WP35CM	.S..GD	WP35CM	.S..HD	WP35CM
K1-K2	.E..LD	TN6510	.S..GD	WK15CM	.S..HD	WK15CM
K3	.E..LD	WP35CM	.S..GD	WP35CM	.S..HD	WP35CM
N1-N2	.F..LDJ	TN6501	.F..LDJ	TN6501	.F..LDJ	TN6501
N3	.F..LDJ	TN6501	.F..LDJ	TN6501	.F..LDJ	TN6501
S1-S2	.E..LD	WS30PM	.S..GD	WS30PM	.S..HD	WP25PM
S3	.E..LD	WS30PM	.S..GD	WS30PM	.S..GD	WS30PM
S4	.E..LD	WS30PM	.S..GD	WS30PM	.S..HD	WP40PM

M1200 Mini • Recommended Starting Speeds [m/min]

INDEXABLE MILLING

SOLID END MILLING

HOLEMAKING

TAPPING

TURNING

Material Group		TN6510			TN6520			TN6525			TN6540			WK15CM		
P	1	-	-	-	-	-	-	410	320	280	360	280	240	-	-	-
	2	-	-	-	-	-	-	320	250	215	250	190	170	-	-	-
	3	-	-	-	-	-	-	280	215	185	215	170	140	-	-	-
	4	-	-	-	-	-	-	235	170	145	180	130	110	-	-	-
	5	-	-	-	-	-	-	310	235	200	240	180	150	-	-	-
	6	-	-	-	-	-	-	205	160	130	160	120	100	-	-	-
M	1	-	-	-	-	-	-	190	120	80	130	80	60	-	-	-
	2	-	-	-	-	-	-	120	80	50	80	50	40	-	-	-
	3	-	-	-	-	-	-	125	80	55	85	50	40	-	-	-
K	1	480	350	260	450	320	230	275	245	220	220	205	180	505	460	410
	2	420	280	205	390	250	190	215	190	180	175	155	140	400	355	330
	3	335	260	200	300	230	160	180	160	145	155	145	125	335	300	275
N	1	-	-	-	-	-	-	-	-	-	-	-	-	-	-	-
	2	-	-	-	-	-	-	-	-	-	-	-	-	-	-	-
	3	-	-	-	-	-	-	-	-	-	-	-	-	-	-	-
S	1	-	-	-	-	-	-	-	-	-	50	35	30	-	-	-
	2	-	-	-	-	-	-	-	-	-	25	20	10	-	-	-
	3	-	-	-	-	-	-	-	-	-	70	40	30	-	-	-
	4	-	-	-	-	-	-	-	-	-	60	30	25	-	-	-
H	1	-	-	-	-	-	-	-	-	-	-	-	-	-	-	-
	2	-	-	-	-	-	-	-	-	-	-	-	-	-	-	-
	3	-	-	-	-	-	-	-	-	-	-	-	-	-	-	-

Material Group		WP25PM			WP35CM			WP40PM			WS30PM			WS40PM			TN6501			THM-U		
P	1	395	340	325	545	475	445	355	310	295	-	-	-	-	-	-	-	-	-	-	-	-
	2	330	290	240	335	305	275	300	260	215	-	-	-	-	-	-	-	-	-	-	-	-
	3	305	260	210	305	275	245	275	235	190	-	-	-	-	-	-	-	-	-	-	-	-
	4	270	220	180	230	210	190	245	205	160	-	-	-	-	-	-	-	-	-	-	-	-
	5	220	205	180	310	275	250	205	185	160	-	-	-	205	175	145	-	-	-	-	-	-
	6	200	150	120	190	160	130	180	140	110	-	-	-	180	130	95	-	-	-	-	-	-
M	1	245	215	200	245	220	185	235	205	185	270	240	220	250	205	170	-	-	-	-	-	-
	2	220	190	155	220	190	170	210	180	150	245	215	175	215	175	145	-	-	-	-	-	-
	3	170	145	115	175	155	140	155	140	110	185	160	125	175	130	100	-	-	-	-	-	-
K	1	275	245	220	355	320	290	-	-	-	-	-	-	-	-	-	-	-	-	-	-	-
	2	215	190	180	280	250	230	-	-	-	-	-	-	-	-	-	-	-	-	-	-	-
	3	180	160	145	235	210	190	-	-	-	-	-	-	-	-	-	-	-	-	-	-	-
N	1	-	-	-	-	-	-	-	-	-	-	-	-	-	-	-	2400	1440	1200	2400	1440	1200
	2	-	-	-	-	-	-	-	-	-	-	-	-	-	-	-	1640	980	800	1640	980	800
	3	-	-	-	-	-	-	-	-	-	-	-	-	-	-	-	960	600	480	960	600	480
S	1	50	40	30	-	-	-	50	40	35	55	50	35	50	40	30	-	-	-	-	-	-
	2	50	40	30	-	-	-	50	40	35	55	50	35	50	40	30	-	-	-	-	-	-
	3	60	50	30	-	-	-	60	50	35	65	55	35	60	50	30	-	-	-	-	-	-
	4	85	60	40	80	60	40	80	60	40	100	70	50	70	60	35	-	-	-	-	-	-
H	1	145	110	85	-	-	-	-	-	-	-	-	-	-	-	-	-	-	-	-	-	-
	2	-	-	-	-	-	-	-	-	-	-	-	-	-	-	-	-	-	-	-	-	-
	3	-	-	-	-	-	-	-	-	-	-	-	-	-	-	-	-	-	-	-	-	-

NOTE: FIRST choice starting speeds are in **bold** type.
As the average chip thickness increases, the speed should be decreased.

M1200 Mini • Recommended Starting Feeds [mm]

Light Machining	General Purpose	Heavy Machining
-----------------	-----------------	-----------------

Insert Geometry	Programmed Feed per Tooth (fz) as a % of Radial Depth of Cut (ae)															Insert Geometry
	5%			10%			20%			30%			40-100%			
.F.LDJ	0,48	0,89	1,81	0,34	0,64	1,29	0,26	0,48	0,96	0,22	0,42	0,83	0,21	0,38	0,76	.F.LDJ
.E.LD	0,48	1,38	2,85	0,34	0,99	2,00	0,26	0,74	1,48	0,22	0,64	1,28	0,21	0,59	1,17	.E.LD
.S.GD	0,92	2,35	3,89	0,66	1,67	2,70	0,49	1,23	1,98	0,43	1,07	1,72	0,39	0,98	1,57	.S.GD
.S.HD	0,92	2,35	3,89	0,66	1,67	2,70	0,49	1,23	1,98	0,43	1,07	1,72	0,39	0,98	1,57	.S.HD

NOTE: Use "Light Machining" value as starting feed rate.

M1200 • 15° • High Feed • Shell Mills • Metric

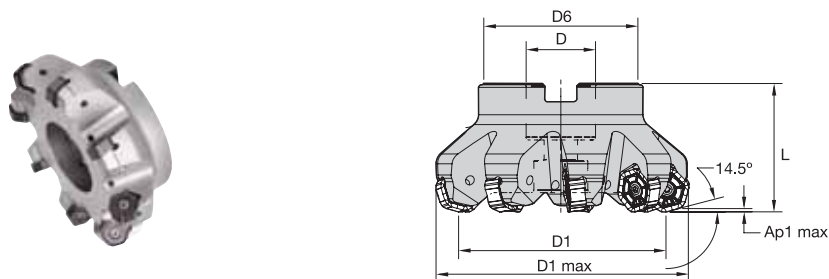

order number	catalogue number	D1	D1 max	D	D6	L	Ap1 max	Z	max RPM	coolant supply	kg
3750370	M1200HF050Z04HN09	50	67,9	22	38	40	2,2	4	11400	Yes	0,65
3750372	M1200HF063Z05HN09	63	80,9	22	50	40	2,2	5	8950	Yes	0,65
3750434	M1200HF080Z06HN09	80	97,9	27	60	50	2,2	6	7300	Yes	1,24
3750435	M1200HF100Z08HN09	100	117,9	32	80	50	2,2	8	5900	Yes	1,89
3750436	M1200HF125Z09HN09	125	142,9	40	90	63	2,2	9	4800	Yes	3,23

NOTE: Socket-head cap screw with coolant groove, coolant lock screw assembly, coolant lock screw, and coolant cap must be ordered separately.

M1200 • 45° • Weldon® End Mills • Metric

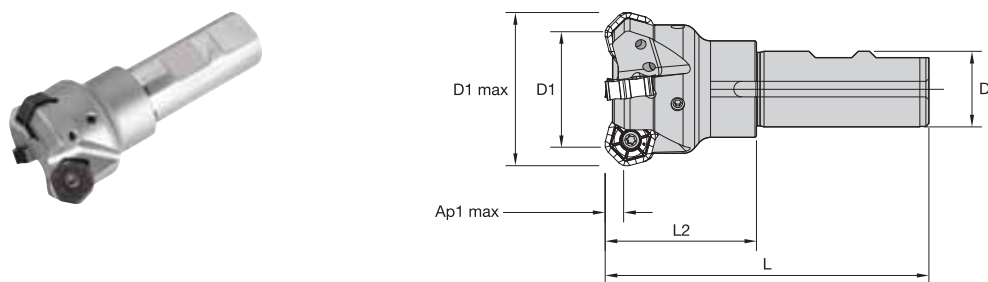

order number	catalogue number	D1	D1 max	D	L	L2	Ap1 max	Z	max RPM	coolant supply	kg
3325311	M1200D040Z04B25HN09	40	51,0	25	107	50	4,5	4	15800	Yes	0,52

FOR SPARE PARTS, PLEASE VISIT WIDIA.COM OR WIDIANOVO.COM.

MOUNTING SCREWS ARE NOT INCLUDED IN STANDARD PACKAGING.

M1200 • 45° • Shell Mills • Metric

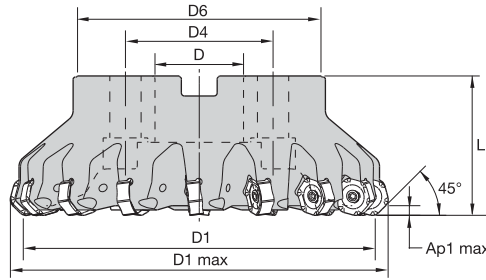

order number	catalogue number	D1	D1 max	D	D4	D6	L	Ap1 max	Z	max RPM	coolant supply	kg
3957970	M1200D040Z03HN09	40	51,0	22	—	39	40	4,4	3	15800	Yes	0,26
3957971	M1200D040Z04HN09	40	51,0	22	—	39	40	4,4	4	15800	Yes	0,25
3325312	M1200D050Z04HN09	50	61,0	22	—	38	40	4,5	4	12700	Yes	0,32
3325693	M1200D050Z05HN09	50	61,0	22	—	38	40	4,5	5	12700	Yes	0,33
3650535	M1200D063Z04HN09	63	74,0	22	—	50	40	4,5	4	10100	Yes	0,59
3093594	M1200D063Z06HN09	63	74,0	22	—	50	40	4,5	6	10100	Yes	0,56
3025376	M1200D063Z07HN09	63	74,0	22	—	50	40	4,5	7	10100	Yes	0,57
3650536	M1200D080Z05HN09	80	91,0	27	—	60	50	4,5	5	7900	Yes	1,12
3081507	M1200D080Z06HN09	80	91,0	27	—	60	50	4,5	6	7900	Yes	1,07
3025377	M1200D080Z09HN09	80	91,0	27	—	60	50	4,5	9	7900	Yes	1,11
3650537	M1200D100Z06HN09	100	111,0	32	—	80	50	4,5	6	6300	Yes	1,73
3325694	M1200D100Z08HN09	100	111,0	32	—	80	50	4,5	8	6300	Yes	1,68
3025378	M1200D100Z11HN09	100	111,0	32	—	80	50	4,5	11	6300	Yes	1,73
3650538	M1200D125Z08HN09	125	135,9	40	—	90	63	4,5	8	5050	Yes	2,84
3081508	M1200D125Z10HN09	125	135,9	40	—	90	63	4,5	10	5050	Yes	2,77
3093593	M1200D125Z14HN09	125	136,0	40	—	90	63	4,5	14	5050	Yes	2,86
3066118	M1200D160Z12HN09	160	171,0	40	66,7	110	63	4,5	12	3900	Yes	4,56
3066119	M1200D160Z16HN09	160	171,0	40	66,7	110	63	4,5	16	3900	Yes	4,70
3957972	M1200D200Z16HN09	200	211,0	60	101,6	130	63	4,5	16	3180	Yes	6,43
3957993	M1200D250Z20HN09	250	261,0	60	101,6	130	63	4,5	20	2550	Yes	9,93
3957994	M1200D315Z24HN09	315	326,0	60	101,6	230	80	4,5	24	2020	Yes	22,90

NOTE: Socket-head cap screw with coolant groove, coolant screw assembly, coolant lock screw, and coolant cap must be ordered separately.

M1200 • 60° • Shell Mills • Metric

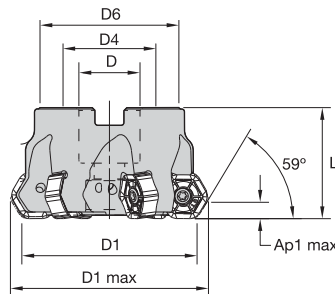

order number	catalogue number	D1	D1 max	D	D4	D6	L	Ap1 max	Z	max RPM	coolant supply	kg
4152116	M1200HD063Z06HN09	63	71,5	22	—	50	40	6,0	6	10100	Yes	0,55
4152117	M1200HD080Z05HN09	80	88,5	27	—	60	50	6,0	5	7900	Yes	1,05
4152118	M1200HD080Z08HN09	80	88,5	27	—	60	50	6,0	8	7900	Yes	1,10
4152119	M1200HD100Z06HN09	100	108,5	32	—	80	50	6,0	6	6300	Yes	1,61
4152120	M1200HD100Z08HN09	100	108,5	32	—	80	50	6,0	8	6300	Yes	1,63
4152121	M1200HD125Z08HN09	125	133,5	40	—	90	63	6,0	8	5050	Yes	2,88
4152123	M1200HD160Z09HN09	160	168,5	40	66,7	110	63	6,0	9	3900	Yes	4,62

NOTE: Coolant screw assembly, coolant lock screw, and coolant cap must be ordered separately.

FOR SPARE PARTS, PLEASE VISIT WIDIA.COM OR WIDIANOVO.COM.
MOUNTING SCREWS ARE NOT INCLUDED IN STANDARD PACKAGING.

M1200 • HNGJ-LDJ • HN0905

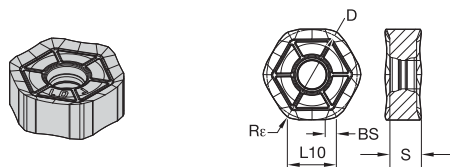

● first choice
○ alternate choice

P	●					●	●			●	●	●	●	○	●
M	●					○	●			●	●	●	●	●	●
K	●	●	●	●	●	○	○	○	○	●	●	○	○	○	○
N	○	●													○
S	○					●	○	○	○	○	○	○	○	○	○
H										○				○	

ISO catalogue number	cutting edges	D	L10	S	BS	Re	hm	THM-U	TN6501	TN6510	TN6520	TN6525	TN6540	WK15CM	WK25YM	WP25PM	WP35CM	WP40PM	WS30PM	WS40PM	
HNGJ0905ANFNLDJ	12	16	8,58	5,56	1,81	1,20	0,02	3606383	3865373												

M1200 • HNGJ-LD • HN0905

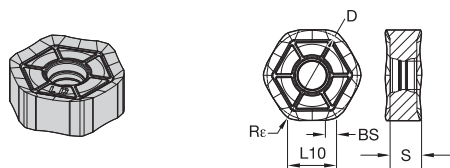

● first choice
○ alternate choice

P	●					●	●			●	●	●	●	○	●
M	●					○	●			●	●	●	●	●	●
K	●	●	●	●	●	○	○	○	○	●	●	○	○	○	○
N	○	●													○
S	○					●	○	○	○	○	○	○	○	○	○
H										○				○	

ISO catalogue number	cutting edges	D	L10	S	BS	Re	hm	THM-U	TN6501	TN6510	TN6520	TN6525	TN6540	WK15CM	WK25YM	WP25PM	WP35CM	WP40PM	WS30PM	WS40PM
HNGJ0905ANENLD	12	16	8,58	5,56	1,76	1,20	0,05				3093559	3330950	3030034			5895346	5895347	5895348	5528973	6180276

Face Mills • M1200 Series

INDEXABLE MILLING

M1200 • HNPJ-GD • HN0905

- first choice
- alternate choice

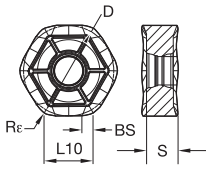

P	●																		
M	●																		
K	●																		
N	○	●																	
S	○																		
H																			

SOLID END MILLING

ISO catalogue number	cutting edges	D	L10	S	BS	Re	hm	THM-U	TN6501	TN6510	TN6520	TN6525	TN6540	WK15CM	WK25YM	WP25PM	WP35CM	WP40PM	WS30PM	WS40PM	
HNPJ0905ANSGD	12	16	8,58	5,56	1,80	1,20	0,10	●	●	●	○	○	○	○	○	○	○	○	○	○	○

HOLEMAKING

M1200 • HNGJ-GD • HN0905

- first choice
- alternate choice

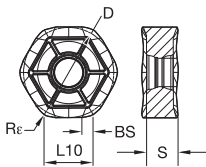

P	●																				
M	●																				
K	●																				
N	○	●																			
S	○																				
H																					

TAPPING

ISO catalogue number	cutting edges	D	L10	S	BS	Re	hm	THM-U	TN6501	TN6510	TN6520	TN6525	TN6540	WK15CM	WK25YM	WP25PM	WP35CM	WP40PM	WS30PM	WS40PM	
HNGJ0905ANSGD	12	16	8,59	5,56	1,71	1,20	0,10	●	●	●	○	○	○	○	○	○	○	○	○	○	○

TURNING

M1200 • HNPJ-HD • HN0905

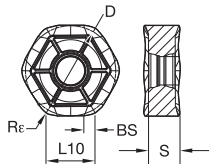

- first choice
- alternate choice

P	■							●	●								
M	■								○	●			●	●	●	●	●
K	■	●	●	●	●	●	●	●	○	○	○	○	○	○	○	○	○
N	■	○	●														○
S	■							●				●	○	○	○	●	●
H	■											○				○	

ISO catalogue number	cutting edges	D	L10	S	BS	Rε	hm	THM-U	TN6501	TN6510	TN6520	TN6525	TN6540	WK15CM	WK25YM	WP25PM	WP35CM	WP40PM	WS30PM	WS40PM	
								●	●	●	●	●	●	●	●	●	○	○	○	○	○
HNPJ090543ANSNHD	12	16	8,50	5,44	—	4,35	0,13	●	●	●	●	●	●	●	●	●	●	●	○	○	○
HNPJ0905ANSNHD	12	16	8,59	5,46	1,65	1,20	0,18	●	●	●	●	●	●	●	●	●	●	●	○	○	○

M1200 • HNGJ-HD • HN0905

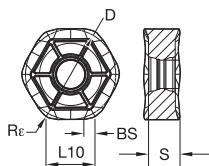
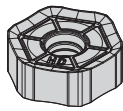

- first choice
- alternate choice

P	■							●	●											
M	■								○	○	○	○	○	○	○	○	○	○		
K	■	●	●	●	●	●	●	●	○	○	○	○	○	○	○	○	○	○		
N	■	○	●															○		
S	■							●				●	○	○	○	○	○	○		
H	■															○	○	○	○	○

ISO catalogue number	cutting edges	D	L10	S	BS	Rε	hm	THM-U	TN6501	TN6510	TN6520	TN6525	TN6540	WK15CM	WK25YM	WP25PM	WP35CM	WP40PM	WS30PM	WS40PM	
								●	●	●	●	●	●	●	●	○	○	○	○	○	○
HNGJ090543ANSNHD	12	16	8,50	5,44	—	4,35	0,20	●	●	●	●	●	●	●	●	●	●	●	○	○	○
HNGJ0905ANSNHD	12	16	8,59	5,46	1,65	1,20	0,17	●	●	●	●	●	●	●	●	●	●	●	○	○	○

Face Mills • M1200 Series

INDEXABLE MILLING

M1200 • HNEC • HN0905

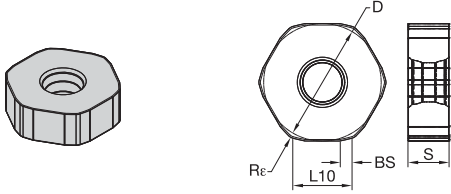

- first choice
- alternate choice

P	■	■	■	■	■	■	■	■	○	○	○	○
M	■	■	■	■	■	■	■	■	○	○	○	○
K	■	■	■	■	■	■	■	■	○	○	○	○
N	○	○	○	○	○	○	○	○	○	○	○	○
S	■	■	■	■	■	■	■	■	○	○	○	○
H	■	■	■	■	■	■	■	■	○	○	○	○

ISO catalogue number	cutting edges	D	L10	S	BS	Rc	hm	THM-U	TN6501	TN6510	TN6520	TN6525	TN6540	WK15CM	WK25YM	WP25PM	WP35CM	WP40PM	WS30PM	WS40PM	
HNEC0905ANSN	12	16	9,17	5,56	1,95	1,20	0,19	■	■	■	■	■	■	■	■	■	■	■	○	○	○

SOLID END MILLING

HOLEMAKING

M1200 • XNGJ-GD3 Wiper • HN0905

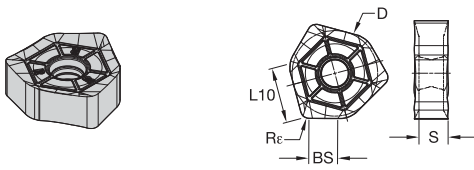

- first choice
- alternate choice

P	■	■	■	■	■	■	■	■	○	○	○	○
M	■	■	■	■	■	■	■	■	○	○	○	○
K	■	■	■	■	■	■	■	■	○	○	○	○
N	○	○	○	○	○	○	○	○	○	○	○	○
S	■	■	■	■	■	■	■	■	○	○	○	○
H	■	■	■	■	■	■	■	■	○	○	○	○

ISO catalogue number	cutting edges	D	L10	S	BS	Rc	hm	THM-U	TN6501	TN6510	TN6520	TN6525	TN6540	WK15CM	WK25YM	WP25PM	WP35CM	WP40PM	WS30PM	WS40PM
XNGJ0905ANSNGD3W	6	16	9,56	5,51	6,00	1,60	0,09	■	■	3117962	3524707	3523620	3066479	5622622	■	5995381	■	5995382	■	6180277

TAPPING

TURNING

M1200 • Insert Selection Guide

Material Group	Light Machining		General Purpose		Heavy Machining	
	Geometry	Grade	Geometry	Grade	Geometry	Grade
P1-P2	.E..LD	WP40PM	.S..GD	WP40PM	.S..HD	WP40PM
P3-P4	.E..LD	WP25PM	.S..GD	WP35CM	.S..HD	WP35CM
P5-P6	.E..LD	WP25PM	.S..GD	WP35CM	.S..HD	WP35CM
M1-M2	.E..LD	WP25PM	.S..GD	WP25PM	.S..HD	WP25PM
M3	.E..LD	WP35CM	.S..GD	WP35CM	.S..HD	WP35CM
K1-K2	.E..LD	TN6520	.S..GD	WK15CM	.S..HD	WK15CM
K3	.E..LD	WP35CM	.S..GD	WP35CM	.S..HD	WP35CM
N1-N2	.F..LDJ	TN6501	.F..LDJ	TN6501	.F..LDJ	TN6501
N3	.F..LDJ	TN6501	.F..LDJ	TN6501	.F..LDJ	TN6501
S1-S2	.E..LD	WS30PM	.S..GD	WS30PM	.S..HD	WP25PM
S3	.E..LD	WS30PM	.S..GD	WS30PM	.S..HD	WP40PM
S4	.E..LD	WS30PM	.S..GD	WS30PM	.S..HD	WP40PM

M1200 • Recommended Starting Speeds [m/min]

Material Group		TN6510	TN6520	TN6525	TN6540	WK15CM	WP25PM
P	1	-	-	410 320 280	360 280 240	-	395 340 325
	2	-	-	320 250 215	250 190 170	-	330 290 240
	3	-	-	280 215 185	215 170 140	-	305 260 210
	4	-	-	235 170 145	180 130 110	-	270 220 180
	5	-	-	310 235 200	240 180 150	-	220 205 180
	6	-	-	205 160 130	160 120 100	-	200 150 120
M	1	-	-	190 120 80	130 80 60	-	245 215 200
	2	-	-	120 80 50	80 50 40	-	220 190 155
	3	-	-	125 80 55	85 50 40	-	170 145 115
K	1	480 350 260	450 320 230	275 245 220	220 205 180	505 460 410	275 245 220
	2	420 280 205	390 250 190	215 190 180	175 155 140	400 355 330	215 190 180
	3	335 260 200	300 230 160	180 160 145	155 145 125	335 300 275	180 160 145
N	1	-	-	-	-	-	-
	2	-	-	-	-	-	-
	3	-	-	-	-	-	-
S	1	-	-	-	50 35 30	-	50 40 30
	2	-	-	-	25 20 10	-	50 40 30
	3	-	-	-	70 40 30	-	60 50 30
	4	-	-	-	60 30 25	-	85 60 40
H	1	-	-	-	-	-	145 110 85
	2	-	-	-	-	-	-
	3	-	-	-	-	-	-

Material Group		WP35CM	WP40PM	WS30PM	WS40PM	WK25YM	TN6501	THM-U
P	1	545 475 445	355 310 295	-	-	-	-	-
	2	335 305 275	300 260 215	-	-	-	-	-
	3	305 275 245	275 235 190	-	-	-	-	-
	4	230 210 190	245 205 160	-	-	-	-	-
	5	310 275 250	205 185 160	-	205 175 145	-	-	-
	6	190 160 130	180 140 110	-	180 130 95	-	-	-
M	1	245 220 185	235 205 185	270 240 220	250 205 170	-	-	-
	2	220 190 170	210 180 150	245 215 175	215 175 145	-	-	-
	3	175 155 140	155 140 110	185 160 125	175 130 100	-	-	-
K	1	355 320 290	-	-	-	965 880 780	-	-
	2	280 250 230	-	-	-	765 685 635	-	-
	3	235 210 190	-	-	-	645 570 525	-	-
N	1	-	-	-	-	-	2400 1440 1200	2400 1440 1200
	2	-	-	-	-	-	1640 980 800	1640 980 800
	3	-	-	-	-	-	960 600 480	960 600 480
S	1	-	50 40 35	55 50 35	50 40 30	-	-	-
	2	-	50 40 35	55 50 35	50 40 30	-	-	-
	3	-	60 50 35	65 55 35	60 50 30	-	-	-
	4	80 60 40	80 60 40	100 70 50	70 60 35	-	-	-
H	1	-	-	-	-	-	-	-
	2	-	-	-	-	-	-	-
	3	-	-	-	-	-	-	-

NOTE: FIRST choice starting speeds are in **bold** type.
As the average chip thickness increases, the speed should be decreased.

M1200 • Recommended Starting Feeds [mm]

Insert Geometry	Programmed Feed per Tooth (fz) as a % of Radial Depth of Cut (ae)																Insert Geometry
	5%			10%			20%			30%			40-100%				
.F.LDJ	0,17	0,33	0,66	0,12	0,24	0,47	0,09	0,18	0,35	0,08	0,15	0,31	0,07	0,14	0,28	.F.LDJ	
.E.LD	0,17	0,49	0,99	0,12	0,35	0,71	0,09	0,27	0,53	0,08	0,23	0,46	0,07	0,21	0,42	.E.LD	
.S.GD	0,26	0,84	1,35	0,19	0,60	0,97	0,14	0,45	0,72	0,12	0,39	0,63	0,11	0,36	0,57	.S.GD	
.S.HD	0,33	0,84	1,35	0,24	0,60	0,97	0,18	0,45	0,72	0,16	0,39	0,63	0,14	0,36	0,57	.S.HD	
.S.Ceramic	0,17	0,33	0,49	0,12	0,24	0,35	0,09	0,18	0,27	0,08	0,15	0,23	0,07	0,14	0,21	.S.Ceramic	

NOTE: Use "Light Machining" value as starting feed rate.

Light Machining	General Purpose	Heavy Machining
-----------------	-----------------	-----------------

M1200 Max Screw Clamping • 56° • Shell Mills • Metric

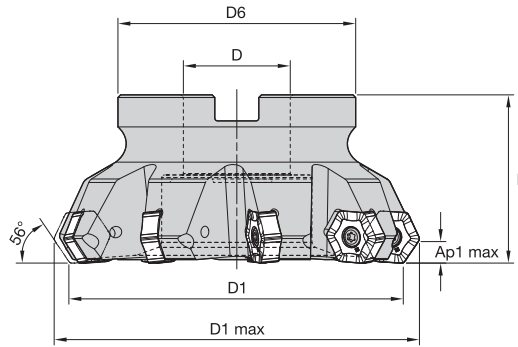

order number	catalogue number	D1	D1 max	D	D6	L	Ap1 max	Z	max RPM	coolant supply	kg
6581490	M1200D080Z05S27HN11	80	91,8	27	60	50	7,5	5	—	No	0,99
6495103	M1200D100Z07S32HN11	100	111,8	32	78	50	7,5	7	8100	No	1,49
6495104	M1200D125Z09S40HN11	125	136,7	40	89	63	7,5	9	—	No	2,72
6581561	M1200D160Z10S40HN11	160	171,7	40	90	63	7,5	10	—	No	3,81
6626921	M1200D200Z12S60HN11	200	211,7	60	130	63	7,5	12	—	No	6,88
6852419	M1200D250Z14S60HN11	250	261,7	60	130	63	7,5	14	—	No	6,88

M1200 Max Wedge Clamping • 56° • Shell Mills • Metric

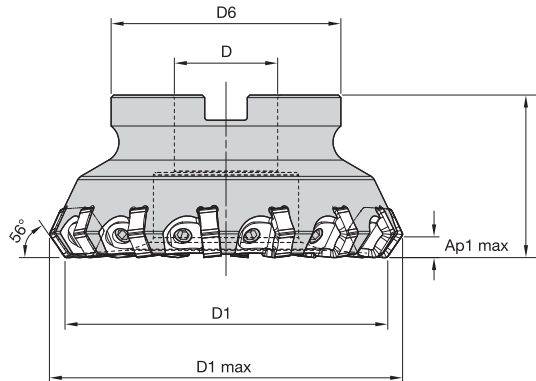

order number	catalogue number	D1	D1 max	D	D6	L	Ap1 max	Z	max RPM	coolant supply	kg
6175726	M1200D063Z06S22HN11W	63	74,8	22	55	40	7,5	6	3600	No	0,56
6020535	M1200D080Z08S27HN11W	80	91,8	27	60	50	7,5	8	3100	No	1,17
6020523	M1200D100Z10S32HN11W	100	111,8	32	78	50	7,5	10	2700	No	1,73
6020530	M1200D125Z14S40HN11W	125	136,8	40	89	63	7,5	14	2400	No	3,05
6020621	M1200D160Z18S40HN11W	160	171,8	40	90	63	7,5	18	2050	No	4,19
6175727	M1200D200Z22S60HN11W	200	211,8	60	130	63	7,5	22	1800	No	7,43
6175728	M1200D250Z28S60HN11W	250	261,8	60	130	63	7,5	28	1600	No	10,81

FOR SPARE PARTS, PLEASE VISIT WIDIA.COM OR WIDIANOVO.COM.
MOUNTING SCREWS ARE NOT INCLUDED IN STANDARD PACKAGING.

M1200 Max Screw Clamping Inserts • HNMU-MM • Heavy-Duty Face Milling

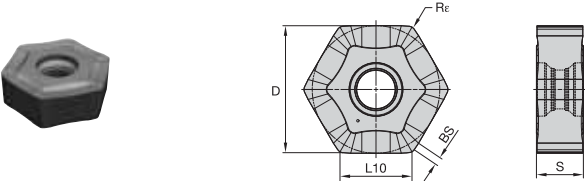

- first choice
- alternate choice

P	■	■	●	●
M	■	■	●	●
K	■	●	○	○
N	■	■	○	○
S	■	○	○	○
H	■	■	○	○

ISO catalogue number	cutting edges	D	L10	S	BS	Rε	hm		
HNMU110710ZNSNMM	12	19	10,75	6,92	1,20	1,00	0,06	6495106	6495105
								WK15CM	WP35CM
									WU20PM
								6852420	

M1200 Max Wedge Clamping Inserts • HNMF-MM

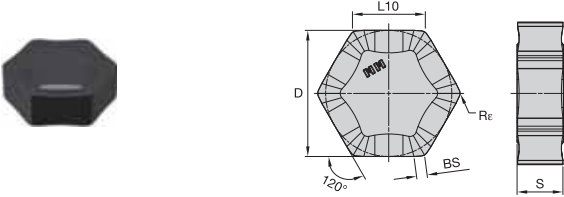

- first choice
- alternate choice

P	■	■	●	●
M	■	■	●	●
K	■	●	○	○
N	■	■	○	○
S	■	○	○	○
H	■	■	○	○

ISO catalogue number	cutting edges	D	L10	S	BS	Rε	hm		
HNMF110710ZNSNMM	12	19	10,75	6,87	1,20	1,00	0,06	6465300	6870109
								WK15CM	WP35CM

INDEXABLE MILLING

SOLID END MILLING

HOLE/MAKING

TAPPING

TURNING

M1200 Max • Insert Selection Guide

Material Group	Light Machining		General Purpose		Heavy Machining	
	Geometry	Grade	Geometry	Grade	Geometry	Grade
P1-P2	.S.MM	WP35CM	.S.MM	WP35CM	.S.MM	WU20PM
P3-P4	.S.MM	WP35CM	.S.MM	WP35CM	.S.MM	WU20PM
P5-P6	.S.MM	WP35CM	.S.MM	WP35CM	.S.MM	WP35CM
M1-M2	.S.MM	WU20PM	.S.MM	WU20PM	.S.MM	WU20PM
M3	.S.MM	WP35CM	.S.MM	WP35CM	.S.MM	WP35CM
K1-K2	.S.MM	WK15CM	.S.MM	WK15CM	.S.MM	WU20PM
K3	.S.MM	WU20PM	.S.MM	WU20PM	.S.MM	WK15CM
N1-N2	.S.MM	WU20PM	.S.MM	WU20PM	.S.MM	WU20PM
N3	.S.MM	WU20PM	.S.MM	WU20PM	.S.MM	WU20PM
S1-S2	.S.MM	WU20PM	.S.MM	WU20PM	.S.MM	WU20PM
S3	.S.MM	WU20PM	.S.MM	WU20PM	.S.MM	WU20PM
S4	.S.MM	WP35CM	.S.MM	WU20PM	.S.MM	WU20PM

M1200 Max • Recommended Starting Speeds [m/min]

Material Group		WP35CM			WK15CM			WU20PM		
		1	2	3	1	2	3	1	2	3
P	1	455	395	370	—	—	—	330	290	270
	2	280	255	230	—	—	—	275	250	200
	3	255	230	205	—	—	—	255	220	175
	4	190	175	160	—	—	—	225	190	150
	5	260	230	210	—	—	—	185	175	150
	6	160	135	—	—	—	—	165	130	100
M	1	205	185	155	—	—	—	205	180	165
	2	185	160	140	—	—	—	185	160	130
	3	145	130	115	—	—	—	140	120	95
K	1	295	265	240	420	385	340	250	220	185
	2	235	210	190	335	295	275	200	180	150
	3	195	175	160	280	250	230	180	150	120
N	1	—	—	—	—	—	—	550	470	400
	2	—	—	—	—	—	—	550	470	400
	3	—	—	—	—	—	—	400	350	300
S	1	—	—	—	—	—	—	40	35	25
	2	—	—	—	—	—	—	40	35	25
	3	—	—	—	—	—	—	50	40	25
	4	—	—	—	—	—	—	70	50	35
H	1	—	—	—	—	—	—	110	80	70

NOTE: First choice starting feed (fz) is in **bold** type.
As the average chip thickness increases, the speed should be decreased.

M1200 Max • Recommended Starting Feeds [mm]

Insert Geometry	Programmed Feed per Tooth (fz) as a % of Radial Depth of Cut (ae)												Insert Geometry			
	5%			10%			20%			30%				40-100%		
.S.MM	0,22	0,71	1,15	0,16	0,51	0,82	0,12	0,38	0,61	0,10	0,33	0,54	0,09	0,31	0,49	.S.MM

NOTE: First choice starting feed (fz) is in **bold** type.
Use corresponding speed (vc).
fz and vc are valid for ae ≥ 0,4 D1.
For smaller ae, fz and vc should be multiplied by the factor given below:

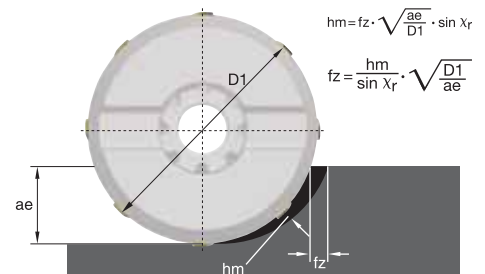

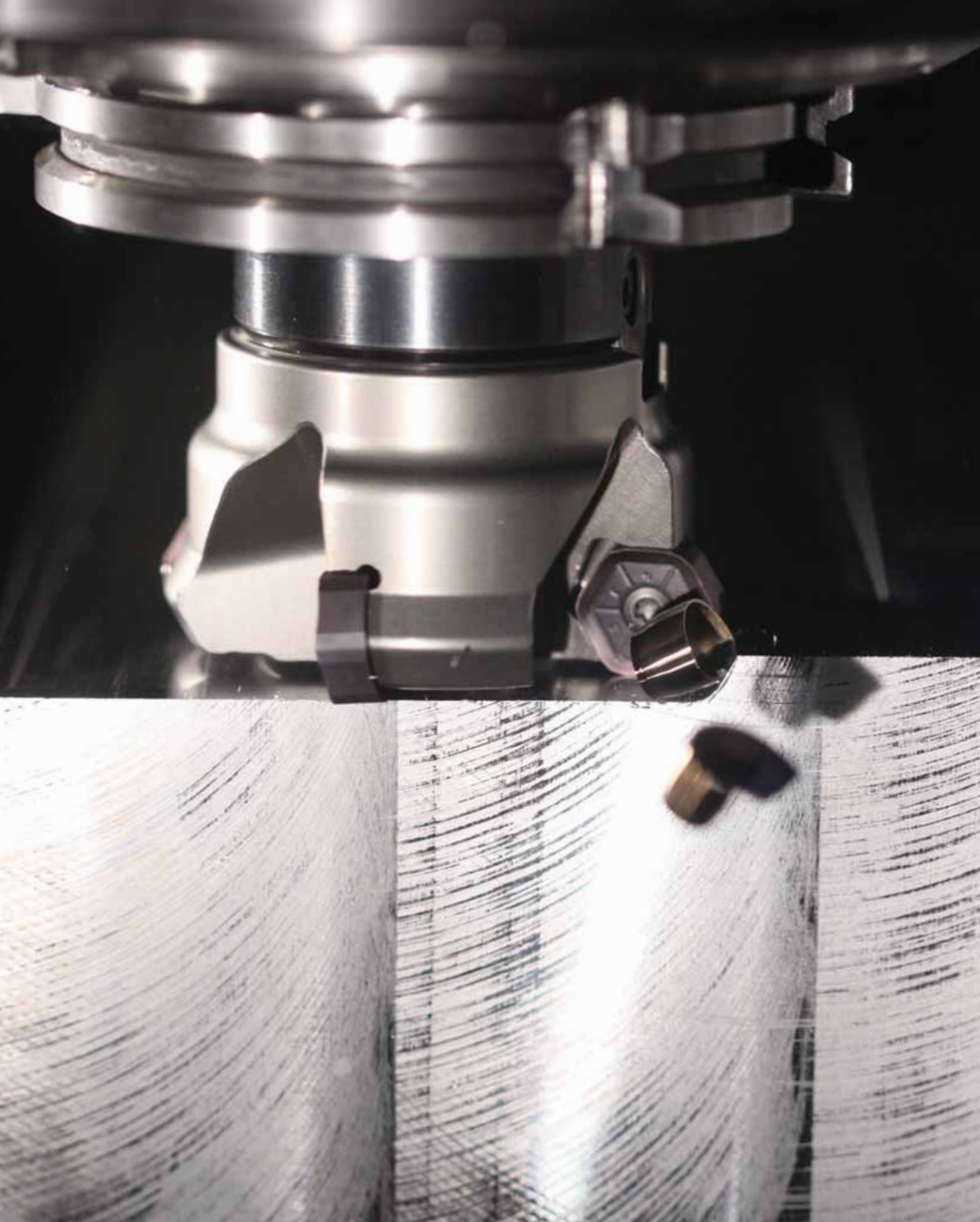

M8065HD

M8065HD Face Mill

Use the M8065HD to easily confront heavy-duty milling jobs in steel and cast-iron materials by applying deep depths of cut while consistently maintaining high metal removal rates.

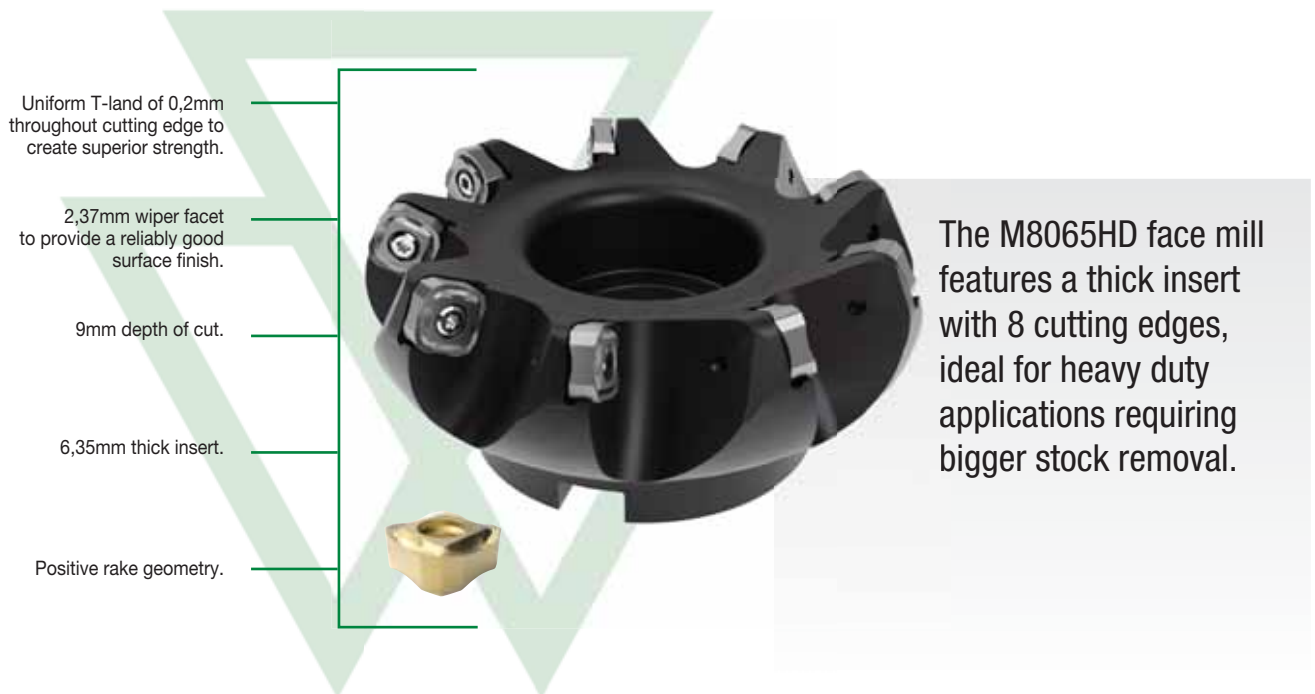

-MM



WK15CM

K

WK15CM is a wear-resistant grade with balanced toughness for general milling of cast irons. Best results in dry machining, but can also be used wet.

WP35CM

P K

WP35CM has a wide range of applications in general and rough milling of steels and cast iron. Performs best in dry, but can also be used under wet conditions.

WU20PM

P M K N S H

WU20PM is a universal grade for machining of steel, stainless steel, and high-temperature alloys. Also suitable for machining of gray and nodular irons. Resists breakage and offers improved wear resistance and increased strength. Can be used for both dry and wet machining.

DIVE INTO THE DOC WITH M8065HD

PRODUCT

SERIES

M8065HD

DIAMETER RANGE

50–315mm

SHANK TYPES

Shell Mills

INDUSTRY



APPLICATIONS



FACE
MILLING



SIDE/SHOULDER MILLING:
EASED CHAMFER

**HEAVY
DUTY**

RELIABLE



M8065HD • 64° • Shell Mills • Metric

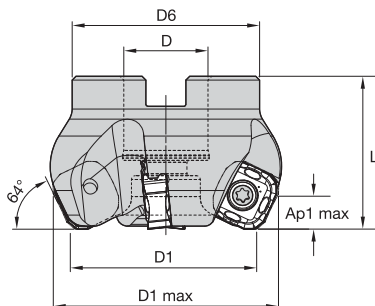

order number	catalogue number	D1	D1 max	D	D6	L	Ap1 max	Z	coolant supply	kg
4124248	M8065HD050Z04S22SN15	50	58,9	22	49	40	9,0	4	No	0,38
4102270	M8065HD063Z05S22SN15	63	71,9	22	49	40	9,0	5	No	0,53
4073639	M8065HD080Z06S27SN15	80	88,8	27	60	50	9,0	6	No	1,15
4073640	M8065HD100Z07S32SN15	100	108,8	32	78	50	9,0	7	No	1,68
4039413	M8065HD125Z09S40SN15	125	133,8	40	89	63	9,0	9	No	3,24
4061110	M8065HD160Z11S40SN15	160	168,8	40	90	63	9,0	11	No	4,33
4113702	M8065HD200Z14S60SN15	200	208,8	60	130	63	9,0	14	No	7,13
4113753	M8065HD250Z16S60SN15	250	258,8	60	130	63	9,0	16	No	11,52
4113754	M8065HD315Z20S60SN15	315	323,8	60	225	80	9,0	20	No	27,90

FOR SPARE PARTS, PLEASE VISIT WIDIA.COM OR WIDIANOVO.COM.
MOUNTING SCREWS ARE NOT INCLUDED IN STANDARD PACKAGING.

M8065HD • SNMX-MM • Heavy-Duty Face Milling

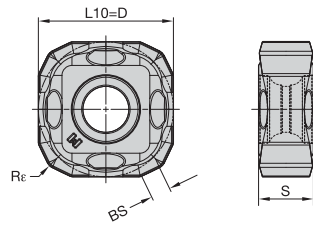

- first choice
- alternate choice

P			●	●
M			●	●
K		●	○	○
N			○	○
S			○	○
H			○	○

ISO catalogue number	cutting edges	D	L10	S	BS	Rε	hm	WK15CM	WP35CM	WU20PM
SNMX150612ZNSNMM	8	16	15,88	6,35	2,37	1,20	0,05	5649102	—	—
SNMX150612ZNSNMM	8	16	15,88	6,35	2,37	1,20	0,06	—	6852432	4137987
SNMX1506ZZXP	8	16	15,88	6,35	2,37	1,20	—	—	6801786	—

INDEXABLE MILLING

SOLID END MILLING

HOLEMAKING

TAPPING

TURNING

M8065HD • Insert Selection Guide

Material Group	Light Machining		General Purpose		Heavy Machining	
	Geometry	Grade	Geometry	Grade	Geometry	Grade
P1-P2	.S..MM	WP35CM	.S..MM	WP35CM	.S..MM	WU20PM
P3-P4	.S..MM	WP35CM	.S..MM	WP35CM	.S..MM	WU20PM
P5-P6	.S..MM	WP35CM	.S..MM	WP35CM	.S..MM	WP35CM
M1-M2	.S..MM	WU20PM	.S..MM	WU20PM	.S..MM	WU20PM
M3	.S..MM	WP35CM	.S..MM	WP35CM	.S..MM	WP35CM
K1-K2	.S..MM	WK15CM	.S..MM	WK15CM	.S..MM	WU20PM
K3	.S..MM	WU20PM	.S..MM	WU20PM	.S..MM	WK15CM
N1-N2	.S..MM	WU20PM	.S..MM	WU20PM	.S..MM	WU20PM
N3	.S..MM	WU20PM	.S..MM	WU20PM	.S..MM	WU20PM
S1-S2	.S..MM	WU20PM	.S..MM	WU20PM	.S..MM	WU20PM
S3	.S..MM	WU20PM	.S..MM	WU20PM	.S..MM	WU20PM
S4	.S..MM	WP35CM	.S..MM	WU20PM	.S..MM	WU20PM

M8065HD • Recommended Starting Speeds [m/min]

Material Group		WP35CM			WK15CM			WU20PM		
P	1	455	395	370	—	—	—	330	290	270
	2	280	255	230	—	—	—	275	250	200
	3	255	230	205	—	—	—	255	220	175
	4	190	175	160	—	—	—	225	190	150
	5	260	230	210	—	—	—	185	175	150
	6	160	135	—	—	—	—	165	130	100
M	1	205	185	155	—	—	—	205	180	165
	2	185	160	140	—	—	—	185	160	130
	3	145	130	115	—	—	—	140	120	95
K	1	295	265	240	420	385	340	250	220	185
	2	235	210	190	335	295	275	200	180	150
	3	195	175	160	280	250	230	180	150	120
N	1	—	—	—	—	—	—	550	470	400
	2	—	—	—	—	—	—	550	470	400
	3	—	—	—	—	—	—	400	350	300
S	1	—	—	—	—	—	—	40	35	25
	2	—	—	—	—	—	—	40	35	25
	3	—	—	—	—	—	—	50	40	25
	4	—	—	—	—	—	—	70	50	35
H	1	—	—	—	—	—	—	110	80	70

NOTE: FIRST choice starting speeds are in **bold** type.
As the average chip thickness increases, the speed should be decreased.

M8065HD • Recommended Starting Feeds [mm]

Light Machining	General Purpose	Heavy Machining
-----------------	-----------------	-----------------

Insert Geometry	Programmed Feed per Tooth (fz) as a % of Radial Depth of Cut (ae)														Insert Geometry	
	5%	10%	20%	30%	40-100%											
.S..MM	0,22	0,65	1,07	0,16	0,47	0,77	0,12	0,35	0,58	0,10	0,31	0,50	0,10	0,28	0,46	.S..MM

NOTE: First choice starting feed (fz) is in **bold** type.
Use corresponding speed (vc).
fz and vc are valid for ae ≥ 0,4 D1.
For smaller ae, fz and vc should be multiplied by the factor given below:

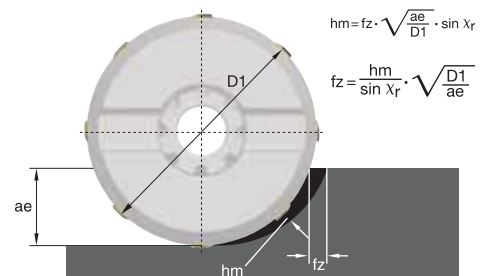



M8090 Series

M8090, M8090-F Face Mills

The M8090 face mill series is an 8-edged, fine pitched face milling series for rough, semi-finish and finish milling of a variety of cast and nodular irons at high-feed rates.

M8090
The M8090 face mill is designed with an 89° approach angle for rough and semi-finish milling applications in cast iron and nodular iron with the added flexibility of using carbide or ceramic inserts on the same cutter depending on productivity needs.

M8090-F
The M8090-F finish mill is designed to achieve a surface finish <math><1,6</math> microns Ra in cast iron finish milling applications at high feeds.

Features for M8090:

- Fine pitch.
- Insert with eight cutting edges.
- 89-degree approach angle to machine close to the fixture.
- Clamping wedge with double thread screw.
- Rigid 'monoblock' cutter body design.

Features for M8090-F:

- Fine pitch cutter with fixed pocket for semi-finisher inserts and adjustable pockets for wiper inserts.
- Inserts with eight cutting edges, wiper inserts with four cutting edges.
- Axial adjustable wiper pocket seats to set up axial run-out within 0,005mm.
- Precision ground inserts and wiper.

WIPER INSERTS WITH FOUR EFFECTIVE CUTTING EDGES OFFERED IN CARBIDE GRADE WK15PM, AND CERAMICS WK25YM AND PCBN WBK40U



SNEN Insert



Ceramic insert with eight effective cutting edges



-MM Insert



Insert with eight effective cutting edges and a positive geometry to work on weak fixtures.

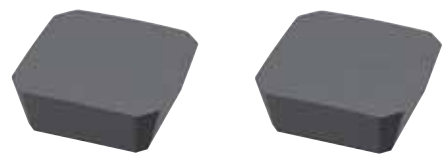

M8090-F Wiper Insert



Wiper inserts with four effective cutting edges.

HIGH-FEED CAST IRON ROUGHING, SEMI-FINISHING, AND FINISHING

PRODUCT

SERIES
M8090,
M8090-F

DIAMETER RANGE

M8090:
63–250mm

M8090F:
80–250mm

SHANK TYPES

Shell Mills

INDUSTRY



APPLICATIONS



FACE
MILLING

CAST IRON MILLING

Versatile, productive face mill for
cast iron and ductile iron.

HIGH-FEED

Multiple insert configurations
provide high surface quality
at high cutting parameters
in cast iron.



M8090 • 89° • Shell Mills • Metric

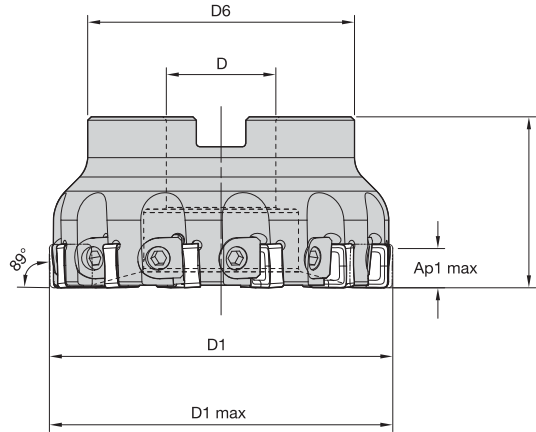

order number	catalogue number	D1	D1 max	D	D6	L	Ap1 max	Z	max RPM	coolant supply	kg
6876426	M8090D063Z05S22SN12	63	63,4	22	49	40	11,5	5	6000	No	0,57
3858649	M8090D063Z07S22SN12	63	63,4	22	49	40	11,5	7	6000	No	0,54
5049033	M8090D080Z07S27SN12	80	80,4	27	60	50	11,5	7	4800	No	1,18
3767299	M8090D080Z09S27SN12	80	80,4	27	60	50	11,5	9	4800	No	1,16
6870509	M8090D100Z10S32SN12	100	100,4	32	78	50	11,5	10	3800	No	1,77
6467715	M8090D100Z12S32SN12	100	100,4	32	78	50	11,5	12	3800	No	1,74
3889658	M8090D125Z12S40SN12	125	125,4	40	89	63	11,5	12	—	No	3,17
6873027	M8090D125Z16S40SN12	125	125,4	40	89	63	11,5	16	—	No	3,11
3996360	M8090D160Z15S40SN12	160	160,4	40	90	63	11,5	15	—	No	4,51
6870508	M8090D160Z18S40SN12	160	160,4	40	90	63	11,5	18	—	No	4,46
6876428	M8090D200Z18S60SN12	200	200,4	60	130	63	11,5	18	—	No	7,48
6876429	M8090D200Z24S60SN12	200	200,4	60	130	63	11,5	24	—	No	7,38
6877402	M8090D250Z24S60SN12	250	250,4	60	130	63	11,5	24	—	No	12,34
6877403	M8090D250Z28S60SN12	250	250,4	60	130	63	11,5	28	—	No	12,27

INDEXABLE MILLING

SOLID END MILLING

HOLEMAKING

TAPPING

TURNING

FOR SPARE PARTS, PLEASE VISIT WIDIA.COM OR WIDIANOVO.COM.
MOUNTING SCREWS ARE NOT INCLUDED IN STANDARD PACKAGING.

M8090 • Roughing Inserts • SNHF

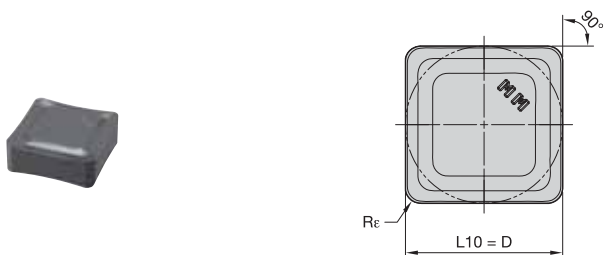

- first choice
- alternate choice

P	■	■	■	■
M	■	■	■	■
K	■	●	●	●
N	■	■	■	■
S	■	■	■	■
H	■	■	■	■

ISO catalogue number	cutting edges	D	L10	S	Re	hm	WK15CM	WK15PM	WK25YM
SNHF120412SNMM	8	12,70	12,70	4,76	1,20	0,05	■	●	■
SNHF120412SNMM	8	12,70	12,70	4,76	1,20	—	6342141	6870510	■

M8090 • Ceramic Inserts • SNEN

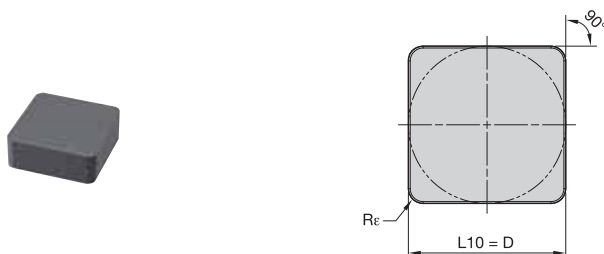

- first choice
- alternate choice

P	■	■	■	■
M	■	■	■	■
K	■	●	●	●
N	■	■	■	■
S	■	■	■	■
H	■	■	■	■

ISO catalogue number	cutting edges	D	L10	S	Re	hm	WK15CM	WK15PM	WK25YM
SNEN120412SNHN	4	12,70	12,70	4,76	1,20	0,04	■	■	6880278

M8090 • Insert Selection Guide

Material Group	Light Machining		General Purpose		Heavy Machining	
	Geometry	Grade	Geometry	Grade	Geometry	Grade
P1-P2	-	-	-	-	-	-
P3-P4	-	-	-	-	-	-
P5-P6	-	-	-	-	-	-
M1-M2	-	-	-	-	-	-
M3	-	-	-	-	-	-
K1-K2	.S..HN	WK25YM	.S..MM	WK15CM	.S..MM	WK15CM
K3	.S..MM	WK15PM	.S..MM	WK15PM	.S..MM	WK15PM
N1-N2	-	-	-	-	-	-
N3	-	-	-	-	-	-
S1-S2	-	-	-	-	-	-
S3	-	-	-	-	-	-
S4	-	-	-	-	-	-

M8090 • Recommended Starting Speeds [m/min]

Material Group		WK15CM			WK15PM			WK25YM		
P	1	-	-	-	-	-	-	-	-	-
	2	-	-	-	-	-	-	-	-	-
	3	-	-	-	-	-	-	-	-	-
	4	-	-	-	-	-	-	-	-	-
	5	-	-	-	-	-	-	-	-	-
	6	-	-	-	-	-	-	-	-	-
M	1	-	-	-	-	-	-	-	-	-
	2	-	-	-	-	-	-	-	-	-
	3	-	-	-	-	-	-	-	-	-
K	1	420	385	340	325	295	260	965	875	780
	2	335	295	275	250	230	210	760	685	635
	3	280	250	230	210	190	175	640	570	520
N	1	-	-	-	-	-	-	-	-	-
	2	-	-	-	-	-	-	-	-	-
	3	-	-	-	-	-	-	-	-	-
S	1	-	-	-	-	-	-	-	-	-
	2	-	-	-	-	-	-	-	-	-
	3	-	-	-	-	-	-	-	-	-
	4	-	-	-	-	-	-	-	-	-
H	1	-	-	-	-	-	-	-	-	-
	2	-	-	-	-	-	-	-	-	-
	3	-	-	-	-	-	-	-	-	-

NOTE: FIRST choice starting speeds are in **bold** type.
As the average chip thickness increases, the speed should be decreased.

M8090 • Recommended Starting Feeds [mm]

Light Machining	General Purpose	Heavy Machining
-----------------	-----------------	-----------------

Insert Geometry	Programmed Feed per Tooth (fz) as a % of Radial Depth of Cut (ae)															Insert Geometry
	5%			10%			20%			30%			40-100%			
.S..MM	0.16	0.58	0.94	0.12	0.42	0.68	0.09	0.31	0.51	0.08	0.27	0.44	0.07	0.25	0.41	.S..MM
.S..HN	0.12	0.40	0.81	0.08	0.29	0.59	0.06	0.22	0.44	0.06	0.19	0.38	0.05	0.18	0.35	.S..HN

NOTE: Use "Light Machining" value as starting feed rate.
For new applications, starting at a lighter feed rate is recommended.
% = ae/Dc X 100 (ae = radial depth of cut, Dc = cutting diameter)

M8090-F • 89° • Shell Mills • Metric

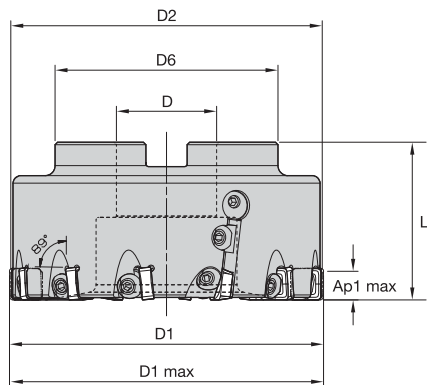

order number	catalogue number	D1	D1 max	D	D6	L	Ap1 max	Z	coolant supply	kg
6668000	M8090FD080Z08W2S27SN12	80	80,4	27	75	50	11,5	8	No	1,49
6750589	M8090FD100Z10W2S32SN12	100	100,4	32	95	50	11,5	10	No	2,21
6381961	M8090FD125Z12W2S40SN12	125	125,4	40	89	63	11,5	12	No	3,99
6779127	M8090FD160Z18W2S60SN12	160	160,4	40	89	63	11,5	18	No	6,85
6876424	M8090FD200Z24W4S60SN12	200	200,4	60	130	63	11,5	24	No	9,94
6876425	M8090FD250Z28W4S60SN12	250	250,4	60	130	63	11,5	28	No	13,46

INDEXABLE MILLING

SOLID END MILLING

HOLEMAKING

TAPPING

TURNING

FOR SPARE PARTS, PLEASE VISIT WIDIA.COM OR WIDIANOVO.COM.

MOUNTING SCREWS ARE NOT INCLUDED IN STANDARD PACKAGING.

INDEXABLE MILLING

M8090 • Roughing Inserts • SNHF

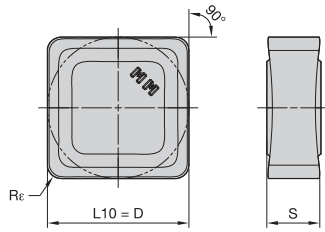

- first choice
- alternate choice

P	■	■	■	■
M	■	■	■	■
K	■	●	●	●
N	■	■	■	■
S	■	■	■	■
H	■	■	■	■

SOLID END MILLING

ISO catalogue number	cutting edges	D	L10	S	Re	hm	WK15CM	WK15PM	WK25YM
SNHF120412SNMM	8	12,70	12,70	4,76	1,20	0,05	○	●	○
SNHF120412SNMM	8	12,70	12,70	4,76	1,20	—	●	○	○

HOLEMAKING

M8090 • Ceramic Inserts • SNEN

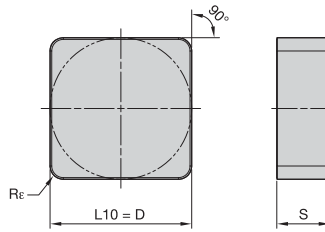

- first choice
- alternate choice

P	■	■	■	■
M	■	■	■	■
K	■	●	●	●
N	■	■	■	■
S	■	■	■	■
H	■	■	■	■

TAPPING

ISO catalogue number	cutting edges	D	L10	S	Re	hm	WK15CM	WK15PM	WK25YM
SNEN120412SNHN	4	12,70	12,70	4,76	1,20	0,04	○	○	●

TURNING

M8090-F • Wiper Inserts • SDEN

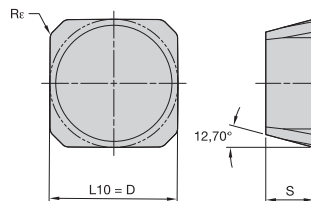

- first choice
- alternate choice

P	■	■	■	■
M	■	■	■	■
K	■	●	●	●
N	■	■	■	■
S	■	■	■	■
H	■	■	■	■

ISO catalogue number	cutting edges	D	L10	S	BS	THM-F	WBK40U	WK15CM	WK15PM	WK25YM
SDEN1204PDEN4WC	4	12,70	12,70	4,76	9,00	●	○	○	○	○

M8090 • Insert Selection Guide

Material Group	Light Machining		General Purpose		Heavy Machining	
	Geometry	Grade	Geometry	Grade	Geometry	Grade
P1-P2	-	-	-	-	-	-
P3-P4	-	-	-	-	-	-
P5-P6	-	-	-	-	-	-
M1-M2	-	-	-	-	-	-
M3	-	-	-	-	-	-
K1-K2	.S..HN	WK25YM	.S..MM	WK15CM	.S..MM	WK15CM
K3	.S..MM	WK15PM	.S..MM	WK15PM	.S..MM	WK15PM
N1-N2	-	-	-	-	-	-
N3	-	-	-	-	-	-
S1-S2	-	-	-	-	-	-
S3	-	-	-	-	-	-
S4	-	-	-	-	-	-

M8090-F • Recommended Starting Speeds [m/min]

Material Group		WK15CM			WK15PM			WK25YM			THM-F			WBK40U		
		P	1	-	-	-	-	-	-	-	-	-	-	-	-	-
	2	-	-	-	-	-	-	-	-	-	-	-	-	-	-	
	3	-	-	-	-	-	-	-	-	-	-	-	-	-	-	
	4	-	-	-	-	-	-	-	-	-	-	-	-	-	-	
	5	-	-	-	-	-	-	-	-	-	-	-	-	-	-	
	6	-	-	-	-	-	-	-	-	-	-	-	-	-	-	
M	1	-	-	-	-	-	-	-	-	-	-	-	-	-	-	
	2	-	-	-	-	-	-	-	-	-	-	-	-	-	-	
	3	-	-	-	-	-	-	-	-	-	-	-	-	-	-	
K	1	420	385	340	325	295	260	965	875	780	145	110	90	1400	800	550
	2	335	295	275	250	230	210	760	685	635	150	120	85	1000	665	500
	3	280	250	230	210	190	175	640	570	520	155	115	70	100	665	500
N	1	-	-	-	-	-	-	-	-	-	-	-	-	-	-	-
	2	-	-	-	-	-	-	-	-	-	-	-	-	-	-	-
	3	-	-	-	-	-	-	-	-	-	-	-	-	-	-	-
S	1	-	-	-	-	-	-	-	-	-	-	-	-	-	-	-
	2	-	-	-	-	-	-	-	-	-	-	-	-	-	-	-
	3	-	-	-	-	-	-	-	-	-	-	-	-	-	-	-
	4	-	-	-	-	-	-	-	-	-	-	-	-	-	-	-
H	1	-	-	-	-	-	-	-	-	-	-	-	-	-	-	-
	2	-	-	-	-	-	-	-	-	-	-	-	-	-	-	-
	3	-	-	-	-	-	-	-	-	-	-	-	-	-	-	-

NOTE: FIRST choice starting speeds are in bold type.
As the average chip thickness increases, the speed should be decreased.

M8090 • Recommended Starting Feeds [mm]

Light Machining	General Purpose	Heavy Machining
-----------------	-----------------	-----------------

Insert Geometry	Programmed Feed per Tooth (fz) as a % of Radial Depth of Cut (ae)															Insert Geometry
	5%			10%			20%			30%			40-100%			
.S..MM	0,16	0,58	0,94	0,12	0,42	0,68	0,09	0,31	0,51	0,08	0,27	0,44	0,07	0,25	0,41	.S..MM
.S..HN	0,12	0,40	0,81	0,08	0,29	0,59	0,06	0,22	0,44	0,06	0,19	0,38	0,05	0,18	0,35	.S..HN

NOTE: Use "Light Machining" value as starting feed rate.
For new applications, starting at a lighter feed rate is recommended.
% = ae/Dc X 100 (ae = radial depth of cut, Dc = cutting diameter)

M4070

M4070 Face Mill

The M4070 heavy-duty face mill has powerful features trusted to continuously perform in demanding machining conditions while running high cutting parameters on uneven, non-uniform surfaces.

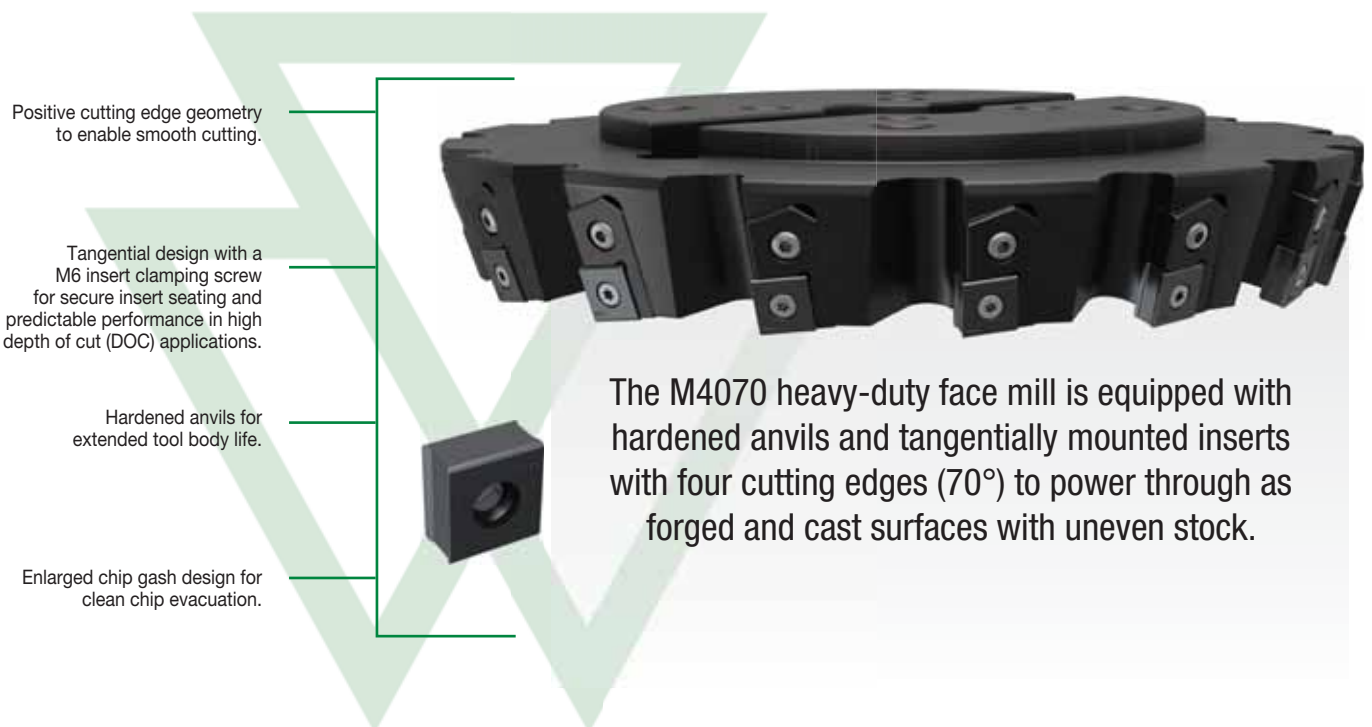

-MH



WK15CM



WK15CM is a wear-resistant grade with balanced toughness for general milling of cast irons. Best results in dry machining, but can also be used wet.

WP35CM



WP35CM has a wide range of applications in general and rough milling of steels and cast iron. Performs best in dry, but can also be used under wet conditions.

RELIABILITY AND SECURITY WITH M4070

PRODUCT

SERIES
M4070

DIAMETER RANGE

125–315mm

SHANK TYPES

Shell Mills

INDUSTRY



APPLICATIONS



FACE
MILLING

RELIABILITY

Hardened anvils to protect the cutter body from heavy-duty machining conditions.

SECURITY

Tangential design with an M6 insert clamping screw for secure insert seating.

TO TACKLE HEAVY-DUTY MACHINING CONDITIONS

M4070 • 70° • Shell Mills • Metric

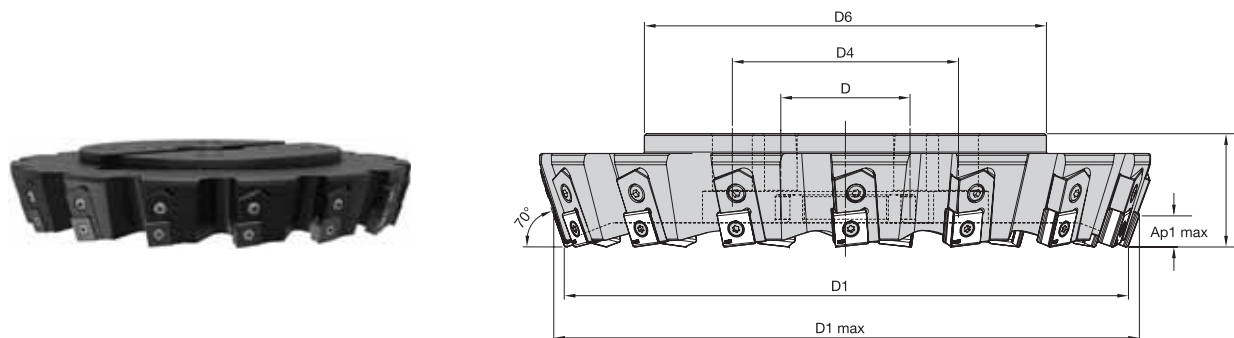

order number	catalogue number	D1	D1 max	D	D4	D6	L	Ap1 max	Z	coolant supply	kg
6318346	M4070D125Z06S40LN20	125	137,8	40	—	89	63	17,3	6	No	4,22
6317290	M4070D160Z08S40LN20	160	172,7	40	66,7	90	63	17,3	8	No	7,18
6524556	M4070D200Z10S60LN20	200	212,7	60	101,6	130	63	17,3	10	No	10,30
6524557	M4070D250Z12S60LN20	250	262,7	60	101,6	225	63	17,3	12	No	16,86
6524558	M4070D315Z15S60LN20	315	327,7	60	101,6	225	63	17,3	15	No	25,17

FOR SPARE PARTS, PLEASE VISIT WIDIA.COM OR WIDIANOVO.COM.
MOUNTING SCREWS ARE NOT INCLUDED IN STANDARD PACKAGING.

M4070 • LNGX-MH

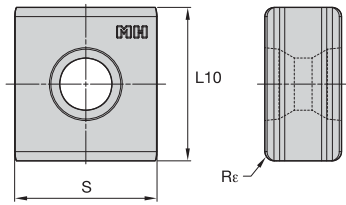

- first choice
- alternate choice

P					●
M					●
K					○
N					○
S					○
H					

ISO catalogue number	cutting edges	L10	S	Re	hm	6852417	6852418
LNGU201012SNMH	4	20,00	10,00	1,20	0,07	WK15CM	WP35CM

INDEXABLE MILLING

SOLID END MILLING

HOLEMAKING

TAPPING

TURNING

M4070 • Insert Selection Guide

Material Group	Light Machining		General Purpose		Heavy Machining	
	Geometry	Grade	Geometry	Grade	Geometry	Grade
P1-P2	.S..MH	WP35CM	.S..MH	WP35CM	.S..MH	WP35CM
P3-P4	.S..MH	WP35CM	.S..MH	WP35CM	.S..MH	WP35CM
P5-P6	.S..MH	WP35CM	.S..MH	WP35CM	.S..MH	WP35CM
M1-M2	.S..MH	WP35CM	.S..MH	WP35CM	.S..MH	WP35CM
M3	.S..MH	WP35CM	.S..MH	WP35CM	.S..MH	WP35CM
K1-K2	.S..MH	WK15CM	.S..MH	WK15CM	.S..MH	WK15CM
K3	.S..MH	WK15CM	.S..MH	WK15CM	.S..MH	WK15CM
N1-N2	-	-	-	-	-	-
N3	-	-	-	-	-	-
S1-S2	-	-	-	-	-	-
S3	-	-	-	-	-	-
S4	.S..MH	WP35CM	.S..MH	WP35CM	.S..MH	WP35CM

M4070 • Recommended Starting Speeds [m/min]

Material Group		WP35CM			WK15CM		
		1	2	3	1	2	3
P	1	545	475	445	—	—	—
	2	335	305	275	—	—	—
	3	305	275	245	—	—	—
	4	230	210	190	—	—	—
	5	310	275	250	—	—	—
	6	190	160	110	—	—	—
M	1	245	220	185	—	—	—
	2	220	190	170	—	—	—
	3	175	155	140	—	—	—
K	1	355	320	290	505	460	410
	2	280	250	230	400	355	330
	3	235	210	190	335	300	275
N	1	—	—	—	—	—	—
	2	—	—	—	—	—	—
	3	—	—	—	—	—	—
S	1	—	—	—	—	—	—
	2	—	—	—	—	—	—
	3	—	—	—	—	—	—
	4	80	60	40	—	—	—
H	1	—	—	—	—	—	—
	2	—	—	—	—	—	—
	3	—	—	—	—	—	—

NOTE: FIRST choice starting speeds are in **bold** type.
As the average chip thickness increases, the speed should be decreased.

M4070 • Recommended Starting Feeds [mm]

Insert Geometry	Programmed Feed per Tooth (fz) as a % of Radial Depth of Cut (ae)												Insert Geometry			
	Light Machining			General Purpose			Heavy Machining			Heavy Machining						
	5%		10%		20%		30%		40-100%							
.S..MH	0,24	0,62	1,00	0,18	0,45	0,72	0,13	0,34	0,54	0,11	0,29	0,47	0,11	0,27	0,43	.S..MH

NOTE: Use "Light Machining" value as starting feed rate.
For new applications, starting at a lighter feed rate is recommended.
% = ae/Dc X 100 (ae = radial depth of cut, Dc = cutting diameter)



The SuperFeed face mill is a PCD face mill for finish milling of non-ferrous materials.

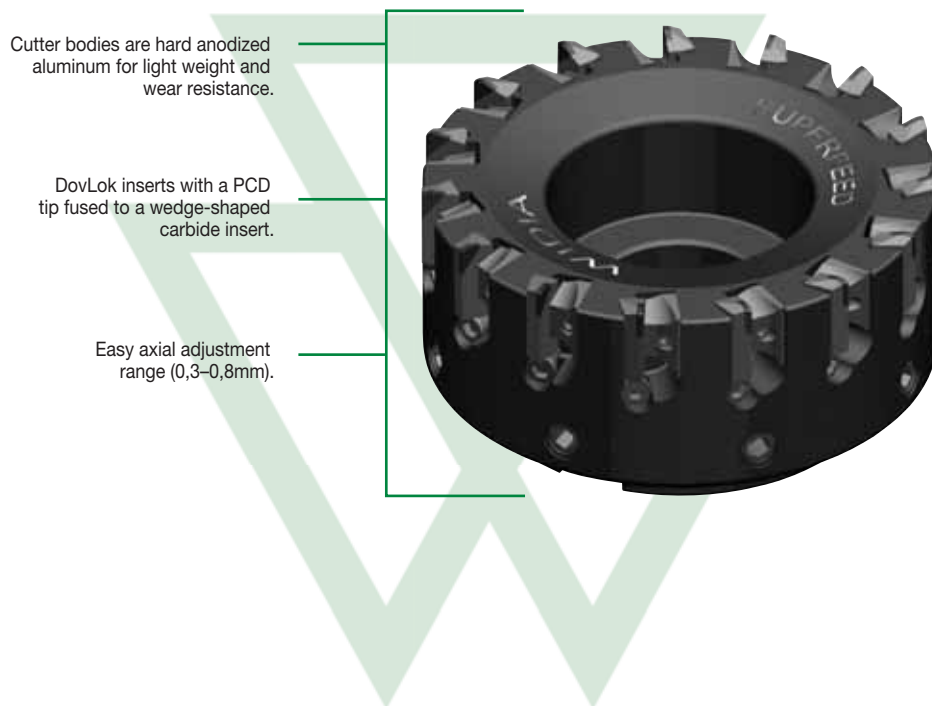

INSERTS OFFERED IN GRADE WDN00U



EDR INSERT
For Shoulder Milling



Corner radii 0,8mm.
Axial DOC 6,35mm max.



SDR INSERT
For Face Milling



Corner radii 0,8mm
and 2,36mm.
Axial DOC 6,35mm max.

NON-FERROUS PCD FACE MILLING

PRODUCT

SERIES

SuperFeed™

DIAMETER RANGE

63–200mm

SHANK TYPES

Shell Mills
Cylindrical End Mills

INDUSTRY



APPLICATIONS



FACE
MILLING



THROUGH
COOLANT:
RADIAL:
INDEXABLE
MILLING



PCD



SIDE MILLING/
SHOULDER
MILLING:
SQUARE END

NON-FERROUS

PCD

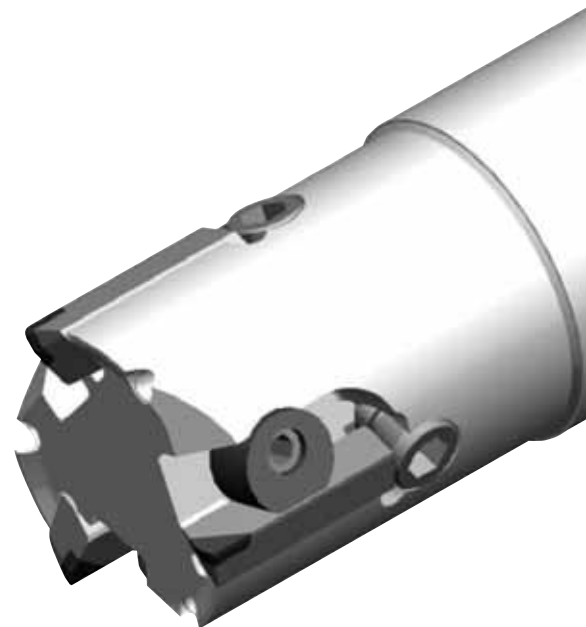

SuperFeed • Face Mills • Metric

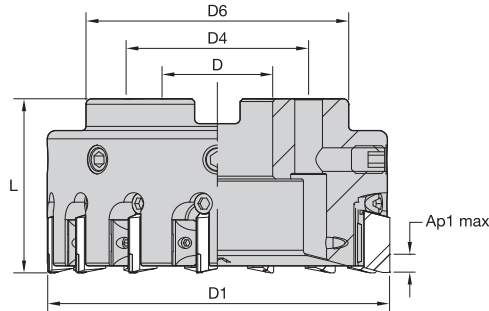

order number	catalogue number	D1	D	D4	D6	L	Ap1 max	Z	Z ADJ	kg	max RPM
5363208	SF06306RH	63	22	—	60	40	6	6	6	0,45	20000
5363209	SF08008RH	80	27	—	77	50	6	8	8	0,63	20000
5363220	SF10012RH	100	32	—	97	50	6	12	12	1,13	17320
5363221	SF12515RH	125	40	—	122	63	6	15	15	2,30	15500
5363222	SF16018RH	160	40	—	157	63	6	18	18	3,20	14150
5363223	SF20024RH	200	60	102	197	63	6	24	24	4,21	12240

NOTE: Z = Number of cartridges.

Z ADJ = Number of adjustable cartridges.

NOTE: Coolant cap or coolant shower plate must be ordered separately.

SuperFeed • End Mills • Metric

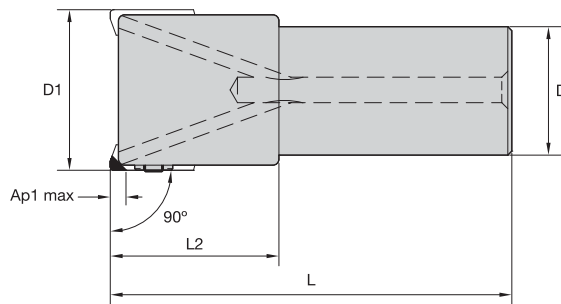

order number	catalogue number	D1	D	L2	L	Ap1 max	Z	Z ADJ	kg	max RPM
5363252	WSSEM02502RH	25	20	40	100	6,4	2	2	0,22	35800
5363253	WSSEM03203RH	32	32	42	100	6,4	3	3	0,54	31600
5363254	WSSEM04004RH	40	32	42	100	6,4	4	4	0,49	28300
5363255	WSSEM05005RH	50	32	42	100	6,4	5	5	0,79	25300

NOTE: Z = Number of cartridges.

Z ADJ = Number of adjustable cartridges.

NOTE: For setting procedure, see page A85.

FOR SPARE PARTS, PLEASE VISIT WIDIA.COM OR WIDIANOVO.COM.

MOUNTING SCREWS ARE NOT INCLUDED IN STANDARD PACKAGING.

SuperFeed • PCD Inserts • Face Mills • SDR

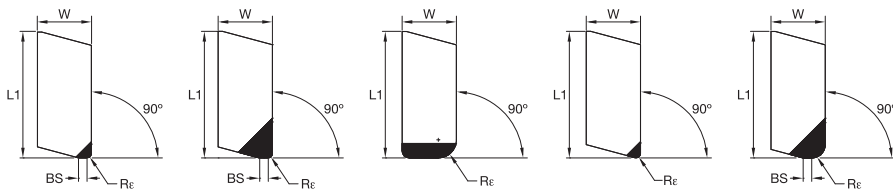

● first choice
○ alternate choice

P	■
M	■
K	■
N	●
S	■
H	■

catalogue number	cutting edges	L1	BS	W	Rε	hm	WDN00U
SDR100031E0NW	1	22,23	—	9,53	0,80	0,02	5358450
SDR100031E0W4	1	22,23	1,52	9,53	0,80	0,02	5358407
SDR100031E1W4	1	22,23	1,52	9,53	0,80	0,02	5358408
SDR100093E1W4	1	22,23	1,52	9,53	2,36	0,02	5358409
SDR102	1	22,22	—	9,52	3,17	0,02	5358451

NOTE: hm = Average chip thickness
BS = Wiper facet length

SuperFeed • PCD Inserts • End Mills • EDR

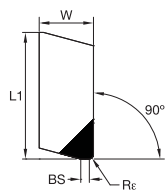

● first choice
○ alternate choice

P	■
M	■
K	■
N	●
S	■
H	■

catalogue number	cutting edges	L1	BS	W	Rε	hm	WDN00U
EDR100031E1W4	1	22,23	1,52	6,36	0,79	0,02	5358452

NOTE: hm = Average chip thickness
BS = Wiper facet length
E0 = 2,5 ap1 max
E1 = 6,3 ap1 max.

SuperFeed • Insert Selection Guide

Material Group	Light Machining		General Purpose		Heavy Machining	
	Geometry	Grade	Geometry	Grade	Geometry	Grade
P1-P2	-	-	-	-	-	-
P3-P4	-	-	-	-	-	-
P5-P6	-	-	-	-	-	-
M1-M2	-	-	-	-	-	-
M3	-	-	-	-	-	-
K1-K2	-	-	-	-	-	-
K3	-	-	-	-	-	-
N1-N2	SDR.../EDR...	WDN00U	SDR.../EDR...	WDN00U	SDR.../EDR...	WDN00U
N3	SDR.../EDR...	WDN00U	SDR.../EDR...	WDN00U	SDR.../EDR...	WDN00U
S1-S2	-	-	-	-	-	-
S3	-	-	-	-	-	-
S4	-	-	-	-	-	-
H1	-	-	-	-	-	-

SuperFeed • Recommended Starting Speeds [m/min]

Material Group		WDN00U		
P	1	-	-	-
	2	-	-	-
	3	-	-	-
	4	-	-	-
	5	-	-	-
	6	-	-	-
M	1	-	-	-
	2	-	-	-
	3	-	-	-
K	1	-	-	-
	2	-	-	-
	3	-	-	-
N	1-2	910	1980	4880
	3	460	610	760
S	1	-	-	-
	2	-	-	-
	3	-	-	-
	4	-	-	-
H	1	-	-	-

NOTE: FIRST choice starting speeds are in **bold** type.
As the average chip thickness increases, the speed should be decreased.

SuperFeed • Recommended Starting Feeds [mm]

Light Machining	General Purpose	Heavy Machining
-----------------	-----------------	-----------------

Insert Geometry	Programmed Feed per Tooth (fz) as a % of Radial Depth of Cut (ae)														Insert Geometry	
	10%			20%			30%			40%			50-100%			
SDR...	0,08	0,17	0,33	0,06	0,13	0,25	0,06	0,11	0,22	0,05	0,10	0,20	0,05	0,10	0,20	SDR...
EDR...	0,08	0,17	0,33	0,06	0,13	0,25	0,06	0,11	0,22	0,05	0,10	0,20	0,05	0,10	0,20	EDR...

NOTE: First choice starting feed (fz) is in **bold** type.
Use corresponding speed (vc).
fz and vc are valid for ae ≥ 0,4 D1.
For smaller ae, fz and vc should be multiplied by the factor given below:

ae/D1 =	0,2	0,3	0,4
fz-Factor	1,5	1,3	1,0
vc-Factor	1,3	1,2	1,1

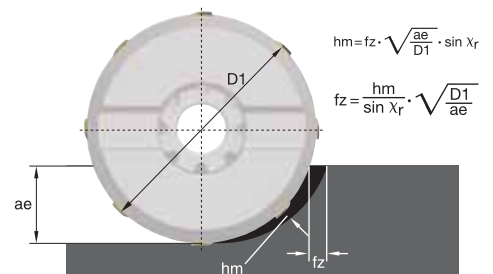

Insert Setting and Fine Adjustment Procedure

▼ General

- Non-contact gages are preferred.
- Contact gages can be used with the following precautions:
 - Indicator must be flat and parallel to the base.
 - Always approach the PCD cartridge from the relief angle under the PCD segment.
 - Do NOT let the indicator drop on the PCD segment.
- Remove all worn PCD cartridges.
- Clean the pockets of the cutter completely.

▼ Face Mills

- Apply a small amount of lubricant to the following areas:
 - Pocket area where the wedge slides.
 - Threads of the cartridge locking screw.
 - Threads of the axial adjustment screw.
- Install cartridges applying light torque to the wedge assembly locking screw.
- Turn axial adjustment screw until the cartridge is 0,01–0,015mm below the final set height.
- Tighten the wedge assembly locking screw to 4 Nm.
- Turn the axial adjustment screw moving the PCD cartridge 0,005mm to the final set height position.
- Set all cartridges as above.

▼ End Mills

- Apply a small amount of lubricant to the following areas:
 - Threads of the cartridge locking screw.
 - Threads of the axial adjustment screw.
- Install cartridges applying light torque to the locking screws.
- Turn axial adjustment screw until the cartridge is 0,01–0,015mm below the final set height.
- Tighten the locking screw (left-hand threads) to 8 Nm leaving 0,005mm below the final set height.
- Turn the axial adjustment screw moving the PCD cartridge 0,005mm to the final set height position.
- Set all cartridges as above.

M4000

Cartridge Milling System

The M4000 cartridge milling system is a roughing and finishing solution with a single tool featuring easy-change cartridges with different insert styles and lead angles.

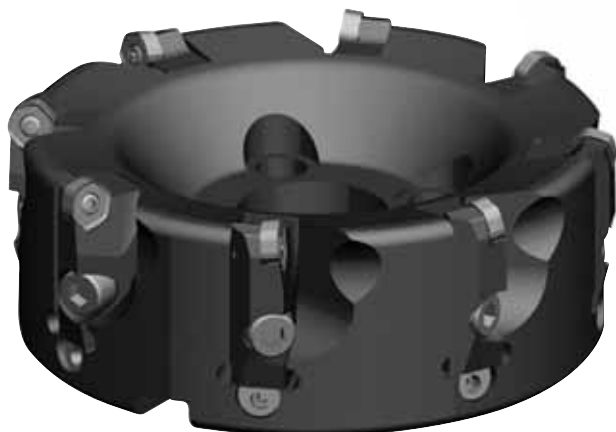

Quick cartridge stop — ready to go in a minute with no adjustment for roughing.

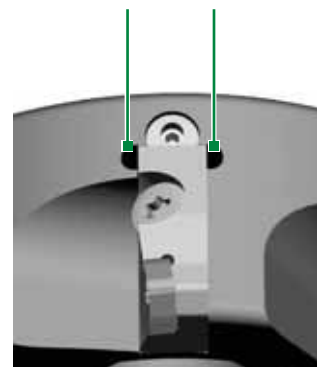

ROUGHING AND FINISHING

PRODUCT

SERIES
M4000

DIAMETER RANGE

125–315mm

SHANK TYPES

Face Mills

INDUSTRY



APPLICATIONS



FACE
MILLING



SIDE MILLING/
SHOULDER
MILLING:
SQUARE END

VSM890-12 CARTRIDGE FOR M4000

M4000CA-SNHX12
Order code: 6602179

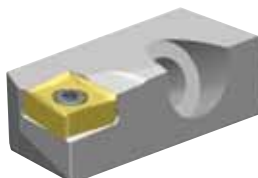

Face Mills • M4000 • Adjustable Cartridge Milling System Cutter Bodies • Metric

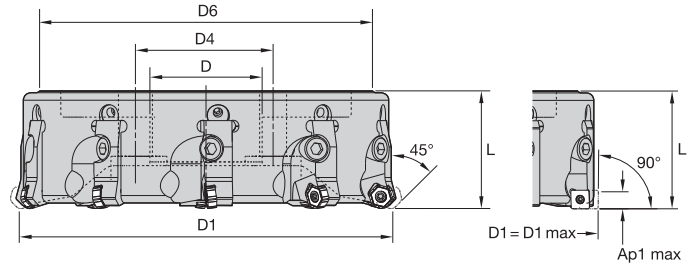

order number	catalogue number	D1	D	D4	D6	L	number of cartridges	max RPM	coolant supply	kg
4136343	M4000D125Z06ADJ	125	40	—	108	68,0	6	2000	No	3,34
4136344	M4000D125Z08ADJ	125	40	—	108	68,0	8	2000	No	3,51
4136345	M4000D160Z08ADJ	160	40	66,7	137	63,0	8	1800	No	5,19
4136346	M4000D160Z12ADJ	160	40	66,7	137	63,0	12	1800	No	5,20
4136347	M4000D200Z10ADJ	200	60	101,6	178	63,0	10	1500	No	8,02
4136348	M4000D200Z14ADJ	200	60	101,6	178	80,0	14	1500	No	12,57
4136349	M4000D250Z12ADJ	250	60	101,6	228	63,0	12	1200	No	13,53
4136350	M4000D250Z18ADJ	250	60	101,6	228	63,0	18	1200	No	13,90
4136351	M4000D315Z16ADJ	315	60	101,6	293	80,0	16	1000	No	25,08
4136352	M4000D315Z22ADJ	315	60	101,6	293	80,0	22	1000	No	25,42

* For all details regarding insert offering and cutting conditions, please refer to the master platforms.

Face Mills • M4000 • Cartridge Milling System • Metric

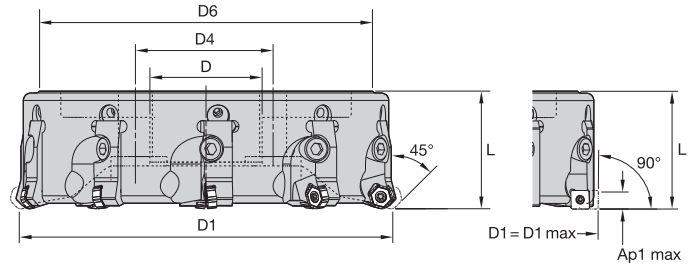

order number	catalogue number	insert style	master platform *	Ap max
3968124	M4000CA-HN07	HN.J0704/XNGJ0704	M1200 Mini	3,5
4159018	M4000CA-HN07HD	HN.J0704	M1200 Mini	4,7
4159017	M4000CA-HN07HF	HN.J0704	M1200 Mini	1,0
3126691	M4000CA-HN09	HN.J0905/XNGJ0905	M1200	4,4
4159019	M4000CA-HN09HD	HN.J0905	M1200	6,0
2511344	M4000CA-HP06	HP.T06T3	M640	4,8
2006361	M4000CA-MDHX10	MDHX1004	M76	1,0
2006346	M4000CA-RC1606	RC.T1606	M100	8,0
2067492	M4000CA-SD1204	SDM.1204	M690	11,7
2006359	M4000CA-SD1506	SDM.1506	M690	14,9
2033495	M4000CA-SE1204	SE.N1204/SE.R1204	M68	6,0
2006377	M4000CA-SE1504	SE.N1504/SE.R1504	M68	8,0
2006348	M4000CA-SN12	SN.T1205/XNKT1205	M660	6,3
2006360	M4000CA-SN15	SN.T1505	M660	8,0
6602179	M4000CA-SNHX12	SNHX1204	VSM890-12	9,8
2006362	M4000CA-SP12	121358680	M40Wiper	9,0
2006373	M4000CA-SP1203	SP.N1203/SP.R1203	M40	9,0
2006376	M4000CA-SP1504	SP.N1504	M40	12,0
2033496	M4000CA-TP1603	TP.N1603/TP.R1603	M40	12,0
6152926	M4000CA-XDPT11	XDCT / XDET / XDPT / XDCW 1104	VSM11	11,5
6152927	M4000CA-XDPT17	XDCT / XDET / XDPT 1704	VSM17	15,9
6433216	M4000CA-XN10	XNPU / XNGU 1004	VSM490-10	10,0
6357989	M4000CA-XN15	XNPU / XNGU 15T6	VSM490-15	15,0
2006347	M4000CA-XP16	XP.T1604	M680	14,0

FOR SPARE PARTS, PLEASE VISIT WIDIA.COM OR WIDIANOVO.COM.
MOUNTING SCREWS ARE NOT INCLUDED IN STANDARD PACKAGING.



DP-151P

WIDIA  Made in India
E9BN 03
VSM890D050Z04822301

The M25 chamfer mill is designed with body clearance for back-chamfer operations to perform on steel, stainless steel, and cast iron materials in countersinking and chamfering operations.

M25 chamfer mills are equipped with thick inserts and a body design with a large chip gash to efficiently evacuate chips from heavy-duty applications.

45-degree lead angle for most chamfering applications.

Strong tool design for optimum insert support.

Clearance for back chamfer operations.



HEAVY-DUTY CHAMFER MILL FOR OF STEEL AND CAST IRON

PRODUCT

SERIES

M25™

DIAMETER RANGE

25–63mm

SHANK TYPES

Shell Mills
Weldon® End Mills

INDUSTRY



APPLICATIONS



M25 • Shell Mills SP1204 • Metric

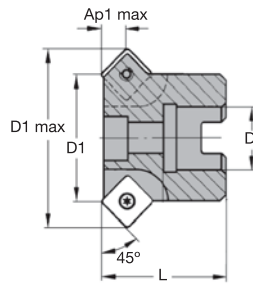

order number	catalogue number	D1	D1 max	D	L	Ap1 max	Z	insert 1	coolant supply	kg
2022632	12292511400	50	66,7	22	40	8,3	4	SP..1204..	No	0,90
2022633	12292511600	63	79,7	22	40	8,3	5	SP..1204..	No	1,10

M25 • Weldon® Shank SD0903 • Metric

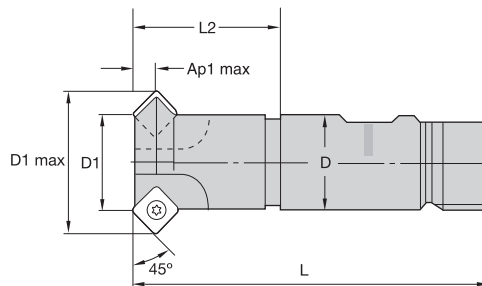

order number	catalogue number	D	D1	D1 max	L	L2	Ap1 max	Z	insert 1	coolant supply	kg
2022628	12292510400	16	16	28,8	75	27	6,4	2	SD..0903..	No	0,10
2022629	12292510800	25	25	37,8	96	40	6,4	2	SD..0903..	No	0,30
2022630	12292511000	32	32	44,8	100	40	6,4	3	SD..0903..	No	0,50

FOR SPARE PARTS, PLEASE VISIT WIDIA.COM OR WIDIANOVO.COM.
MOUNTING SCREWS ARE NOT INCLUDED IN STANDARD PACKAGING.

M25 • Cylindrical Shank SD0903 • Metric

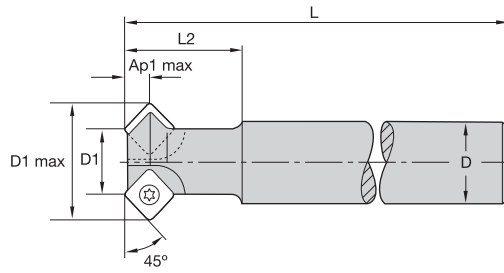

order number	catalogue number	D1	D1 max	D	L	L2	Ap1 max	Z	insert 1	coolant supply	kg
2022634	12292550400	16	28,8	16	200	27	6,4	2	SD..0903..	No	0,40
2022635	12292550800	25	37,8	25	200	40	6,4	2	SD..0903..	No	0,70
2022636	12292551000	32	44,8	32	200	40	6,4	3	SD..0903..	No	1,20

M25 • Shell Mills SD0903 • Metric

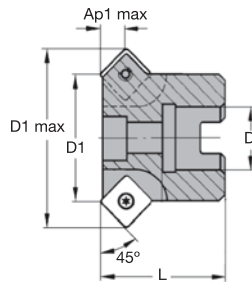

order number	catalogue number	D1	D1 max	D	L	Ap1 max	Z	insert 1	coolant supply	kg
2022631	12292511200	40	52,3	22	40	6,1	4	SD..0903..	No	0,80

NOTE: Standard milling cutters will accept insert nose radii up to 2mm without modification.

INDEXABLE MILLING

M25 • SDNT

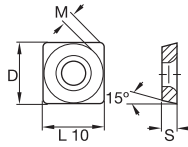
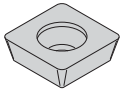

- first choice
- alternate choice

P	■	■	■	●	●	●	■	■
M	■	■	■	○	○	○	○	○
K	■	○	○	○	○	○	○	○
N	■	●	○	○	○	○	○	○
S	■	○	○	○	○	○	○	○
H	■	■	■	■	■	■	■	■

catalogue number	cutting edges	D	L10	M	S	hm	THM	THR	TTM08	TTM09	TTR	WK15CM	WP35CM
SDNT090308T	4	9,53	9,53	1,64	3,18	0,10	2028337	■	■	■	■	■	■
SDNT090308T	4	9,53	9,53	1,64	3,18	—	■	■	■	■	■	6724749	■
SDNT090308	4	9,53	9,53	1,64	3,18	—	■	■	■	■	■	■	6910858

SOLID END MILLING

HOLEMAKING

M25 • SDMW

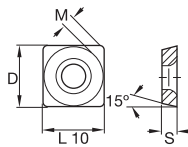
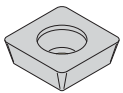

- first choice
- alternate choice

P	■	■	■	●	●	●	■	■
M	■	■	■	○	○	○	○	○
K	■	○	○	○	○	○	○	○
N	■	●	○	○	○	○	○	○
S	■	○	○	○	○	○	○	○
H	■	■	■	■	■	■	■	■

catalogue number	cutting edges	D	L10	M	S	hm	THM	THR	TTM08	TTM09	TTR	WK15CM	WP35CM
SDMW090308	4	9,53	9,53	1,64	3,18	0,08	■	■	■	■	■	■	6901197
SDMW090308	4	9,53	9,53	1,64	3,18	0,10	2028332	■	2028333	■	■	■	■

TAPPING

TURNING

M25 • SPMW

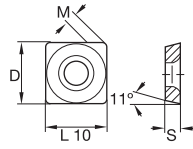
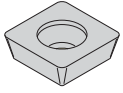

- first choice
- alternate choice

P	●			●	●	●		
M	●					○		●
K	○	○						○
N	●	○						
S	○							○
H								

catalogue number	cutting edges	D	L10	M	S	hm	THM	THR	TTM08	TTM09	TTR	WK15CM	WP35CM
SPMW120408	4	12,70	12,70	2,30	4,76	0,14	2014066	2028528	2028529	-	2024780	5427380	-

INDEXABLE MILLING

SOLID END MILLING

HOLE/MAKING

TAPPING

TURNING

M25 • SD09 • Insert Selection Guide

Material Group	Light Machining		General Purpose		Heavy Machining	
	Geometry	Grade	Geometry	Grade	Geometry	Grade
P1-P2	SDNT	WP35CM	SDNT	WP35CM	SDNT	WP35CM
P3-P4	SDNT	WP35CM	SDNT	WP35CM	SDNT	WP35CM
P5-P6	SDNT	WP35CM	SDNT	WP35CM	SDNT	WP35CM
M1-M2	SDNT	WP35CM	SDNT	WP35CM	SDNT	WP35CM
M3	SDNT	WP35CM	SDNT	WP35CM	SDNT	WP35CM
K1-K2	SDNT	WK15CM	SDNT	WK15CM	SDNT	WK15CM
K3	SDNT	WK15CM	SDNT	WK15CM	SDNT	WK15CM
N1-N2	-	-	-	-	-	-
N3	-	-	-	-	-	-
S1-S2	-	-	-	-	-	-
S3	-	-	-	-	-	-
S4	-	-	-	-	-	-
H1	-	-	-	-	-	-

M25 • SP12 • Insert Selection Guide

Material Group	Light Machining		General Purpose		Heavy Machining	
	Geometry	Grade	Geometry	Grade	Geometry	Grade
P1-P2	SPMW	TTM09	SPMW	TTM09	SPMW	TTM09
P3-P4	SPMW	TTM09	SPMW	TTM09	SPMW	TTM09
P5-P6	SPMW	TTR	SPMW	TTR	SPMW	TTR
M1-M2	SPMW	TTR	SPMW	TTR	SPMW	TTR
M3	SPMW	TTR	SPMW	TTR	SPMW	TTR
K1-K2	SPMW	WK15CM	SPMW	WK15CM	SPMW	WK15CM
K3	SPMW	WK15CM	SPMW	WK15CM	SPMW	WK15CM
N1-N2	-	-	-	-	-	-
N3	-	-	-	-	-	-
S1-S2	-	-	-	-	-	-
S3	-	-	-	-	-	-
S4	-	-	-	-	-	-
H1	-	-	-	-	-	-

M25 • Recommended Starting Speeds [m/min]

Material Group	THR	TTM08	TTM09	TTR	WP35CM	WK15CM	THM
P	1	- - -	230 200 190	210 180 170	170 150 140	455 395 370	- - -
	2	- - -	195 170 140	175 150 125	105 85 75	280 255 230	- - -
	3	- - -	180 150 125	160 130 110	105 85 75	255 230 205	- - -
	4	- - -	160 130 105	140 115 90	85 60 55	190 175 160	- - -
	5	- - -	- - -	- - -	110 85 80	260 230 210	- - -
	6	- - -	- - -	- - -	50 40 35	160 135 110	- - -
M	1	- - -	- - -	- - -	100 60 40	205 185 155	- - -
	2	- - -	- - -	- - -	60 35 25	185 160 140	- - -
	3	- - -	- - -	- - -	65 40 30	145 130 115	- - -
K	1	150 135 120	- - -	- - -	- - -	295 265 240	505 460 410
	2	185 140 120	- - -	- - -	- - -	235 210 190	400 355 330
	3	105 75 50	- - -	- - -	- - -	195 175 160	335 300 275
N	1	900 600 500	- - -	- - -	- - -	- - -	1080 720 600
	2	685 465 385	- - -	- - -	- - -	- - -	820 560 460
	3	450 280 200	- - -	- - -	- - -	- - -	540 335 240
S	1	35 25 20	- - -	- - -	- - -	- - -	- - -
	2	25 20 15	- - -	- - -	- - -	- - -	- - -
	3	50 40 30	- - -	- - -	- - -	- - -	- - -
	4	35 25 18	- - -	- - -	- - -	66 50 33	- - -
H	1	- - -	- - -	- - -	- - -	- - -	- - -
	2	- - -	- - -	- - -	- - -	- - -	- - -
	3	- - -	- - -	- - -	- - -	- - -	- - -

NOTE: FIRST choice starting speeds are in **bold** type.
As the average chip thickness increases, the speed should be decreased.

M25 • Recommended Starting Feeds [mm]

Light Machining	General Purpose	Heavy Machining
-----------------	-----------------	-----------------

Recommended Starting Feeds [mm]

Insert Geometry	Programmed Feed per Tooth (fz) as a % of Radial Depth of Cut (ae)			Insert Geometry
SD09	0,10	0,15	0,30	SD09
SP12	0,10	0,15	0,35	SP12

NOTE: Use "Light Machining" value as starting feed rate.

INDEXABLE MILLING





SOLID END MILLING

HOLEMAKING

TAPPING

TURNING

Shoulder Milling Portfolio Overview

	INDEXABLE MILLING				
					
Product	VSM890™ -12	VSM490™ -15	VSM490™ -10	VSM11™	VSM17™
Page	A144–A147	A136–A140	A128–A133	A102–A108	A112–A118
Victory™ – High-Performance					
Versatility					
Insert Style	Double-Sided	Double-Sided	Double-Sided	Single-Sided	Single-Sided
Pressed Inserts (PSTS)					
Ground Inserts					
Cutting Edge	8	4	4	2	2
Corner Radii	0,8–1,6	0,4–2,0	0,4–1,6	0,2–2,4	0,4–6,0
Max Depth-of-Cut	9,8mm	15mm	10mm	11mm	16mm
Internal Coolant Supply					
Materials					
Achievable Surface Quality Wall					
Achievable Surface Quality Bottom					
Additional Operations					
Shell Mills	40–250mm	40–125mm	40–125mm	40–125mm	40–160mm
Shank Mills – Cylindrical	–	25–32mm	16–32mm	12–32mm	25–40mm
Shank Mills – Weldon®	32mm	25–32mm	16–40mm	12–32mm	25–40mm
Screw-On	–	25–35mm	16–32mm	16–40mm	25–40mm
M4000 Cartridge					
Helical Mills					











SOLID END MILLING



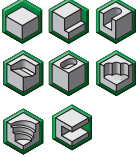
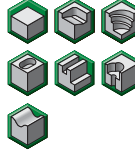
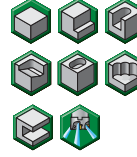
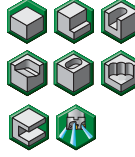
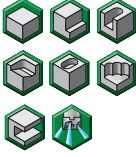

HOLEMAKING

TAPPING

TURNING

Shoulder Milling Portfolio Overview

	 VSM22™	 VHSC	M680	M680+	M680-09	M690-12	M690-15
							
	A122–A123	A180–A181	A154–A160	A162–A163	A150–A152	A168–A172	A174–A176
	✓	✓✓	✓✓	✓	✓	✓	✓
	✓	✓✓	✓	✓	✓	✓	✓
	Single-Sided	Single-Sided	Single-Sided	Single-Sided	Single-Sided	Single-Sided	Single-Sided
	○	○	⊙	○	○	○	○
	⊙	⊙	⊙	⊙	○	⊙	⊙
	2	2	2	2	2	4	4
	1,2	0,4–5	0,4–4,0	0,8	0,4–2,0	0,4–3,2	1,2–1,6
	20mm	16mm	14mm	9,5mm	9mm	10mm	12mm
	⊙	⊙	○	○	○	○	○
	P M K	N	P M K N S H	P M K N	P M K N	P M K N S H	P M K S H
	✓	✓✓	✓	✓	✓	✓	✓
	✓	✓✓	✓	✓	✓	✓	✓
							
	50–125mm	40–80mm	40–125mm	40mm	–	50–125mm	50–125mm
	–	25–32mm	–	–	16–32mm	–	–
	–	–	25–40mm	32mm	–	–	–
	–	–	25–40mm	25–32mm	–	–	–
	○	○	⊙	⊙	⊙	○	⊙
	○	○	⊙	⊙	○	⊙	○

 Good	 Perfect	 Yes	 No	 All-Star Program
--	---	---	---	--

INDEXABLE MILLING

SOLID END MILLING

HOLEMAKING

TAPPING

TURNING

VSM Single-Sided Series

VSM 11™ Shoulder Mill

The VSM11 shoulder mill will thrive in precise machining to medium roughing applications. Its two-edged, single-sided inserts deliver low horsepower consumption and soft cutting action on a variety of workpieces.

Body:

- Internal coolant supply.
- Optimized chip gash for improved cutter stability and chip flow.





Insert:

- Embedded wiper facet for great surface floor finish.
- Multiple corner nose radii R0,20mm to R3,20mm available; includes uses for aerospace applications.
- Super-positive rake design for soft cutting action and low machine power consumption.

The VSM11 shoulder mill is built for high DOC scenarios with A_p capabilities up to 11mm and a super-positive rake design for soft cutting action and low machine power consumption.

Six insert geometries are available to apply in a variety of applications and materials.

GEOMETRIES FOR ALL MATERIAL GROUPS IN SHOULDER MILLING APPLICATIONS

<p>-ALP</p>  <p>N</p> <p>Roughing and finishing of aluminum alloys. High precision. Periphery ground.</p>	<p>-ML</p>  <p>P M S H</p> <p>Light machining and finishing. First choice for stainless steel and titanium. Periphery ground.</p>	<p>-MM</p>  <p>P M K S H</p> <p>Medium machining. First choice for general purpose. Precision pressed to size.</p>	<p>-MH</p>  <p>P M K S</p> <p>First choice for heavy-duty machining. Steel and cast iron materials. Precision pressed to size.</p>	<p>-MU</p>  <p>P M K N S</p> <p>First choice for low to medium cutting parameters. Precision pressed to size and periphery ground.</p>
--	--	---	--	---

Finishing Capabilities/Lower Cutting Forces

Geometry Strengthening

LOW POWER CONSUMPTION, HIGH DEPTH OF CUT

PRODUCT

SERIES

VSM11™

DIAMETER RANGE

Screw on: 16–40mm
 Weldon: 12–32mm
 Cylindrical: 12–32mm
 Shell: 40–125mm
 Helical: 25–50mm

SHANK TYPES

Screw-On End Mills
 Weldon® End Mills
 Cylindrical End Mills
 Shell Mills
 Helical End Mills

INDUSTRY



APPLICATIONS



SIDE MILLING/
 SHOULDER
 MILLING:
 SQUARE END



SLOTTING:
 SQUARE END



FACE
 MILLING



RAMPING



POCKETING



PLUNGE
 MILLING



HELICAL
 INTERPOLATION/
 POCKET MILLING



3D
 PROFILING



SIDE MILLING/
 SHOULDER
 MILLING:
 BOTTOM
 SHOULDERING

**LOW POWER
 CONSUMPTION**

**SINGLE-SIDED
 INSERTS**



VSM11™ • Screw-On End Mills • Metric

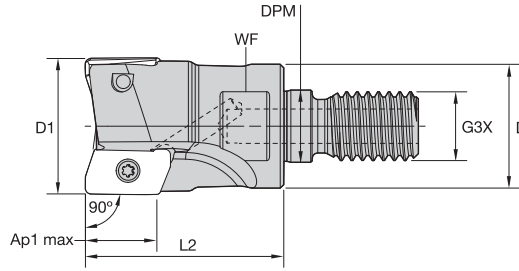

order number	catalogue number	D1	D	DPM	G3X	L2	WF	Ap1 max	Z	max ramp angle	max RPM	coolant supply	kg
5417011	VSM11D016Z02M08XD11	16	13	8,5	M8	25	10	11,5	2	10.0°	41400	Yes	0,02
5417013	VSM11D020Z03M10XD11	20	18	10,5	M10	28	15	11,6	3	7.8°	35100	Yes	0,05
5417015	VSM11D025Z04M12XD11	25	21	12,5	M12	32	17	11,5	4	5.3°	30200	Yes	0,08
5417017	VSM11D032Z04M16XD11	32	29	17,0	M16	40	24	11,4	4	3.6°	25800	Yes	0,18
5417019	VSM11D040Z06M16XD11	40	29	17,0	M16	40	24	11,4	6	2.6°	22600	Yes	0,24

NOTE: Standard milling cutters will accept insert nose radii up to 1,6mm without modification.
For tool body modification instructions, see page A114.

VSM11 • Weldon® End Mills • Metric

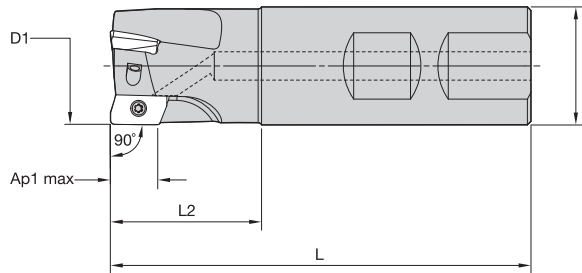

order number	catalogue number	D1	D	L	L2	Ap1 max	Z	max ramp angle	max RPM	coolant supply	kg
5416454	VSM11D012Z01B16XD11	12	16	70	21	11,7	1	3.7°	53100	Yes	0,08
6616467	VSM11D016Z02B12XD11	16	12	67	21	11,5	2	10.0°	41400	Yes	0,05
5416455	VSM11D016Z02B16XD11	16	16	70	21	11,5	2	10.0°	41400	Yes	0,09
6171449	VSM11D018Z02B16XD11	18	16	70	21	11,6	2	—	39000	Yes	0,09
6616468	VSM11D020Z03B16XD11	20	16	79	30	11,6	3	7.8°	35100	Yes	0,11
5416457	VSM11D020Z02B20XD11	20	20	81	30	11,6	2	7.8°	35100	Yes	0,15
5416458	VSM11D020Z03B20XD11	20	20	81	30	11,6	3	7.8°	35100	Yes	0,16
6171501	VSM11D022Z03B20XD11	22	20	81	30	11,5	3	—	33460	Yes	0,17
6616469	VSM11D025Z03B20XD11	25	20	82	31	11,5	3	5.3°	30200	Yes	0,18
5416459	VSM11D025Z03B25XD11	25	25	88	31	11,5	3	5.3°	30200	Yes	0,27
5416480	VSM11D025Z04B25XD11	25	25	88	31	11,5	4	5.3°	30200	Yes	0,28
5416481	VSM11D030Z04B25XD11	30	25	88	31	11,5	4	3.2°	26900	Yes	0,30
6616470	VSM11D032Z04B25XD11	32	25	96	40	11,4	4	3.6°	25800	Yes	0,35
6616481	VSM11D032Z05B25XD11	32	25	96	39	11,4	5	3.6°	25800	Yes	0,36
5416482	VSM11D032Z04B32XD11	32	32	100	39	11,4	4	3.6°	25800	Yes	0,51
5416483	VSM11D032Z05B32XD11	32	32	100	39	11,4	5	3.6°	25800	Yes	0,52

NOTE: Weldon type not recommended for finishing operations.

FOR SPARE PARTS, PLEASE VISIT WIDIA.COM OR WIDIANOVO.COM.
MOUNTING SCREWS ARE NOT INCLUDED IN STANDARD PACKAGING.

VSM11™ • Cylindrical End Mills • Metric

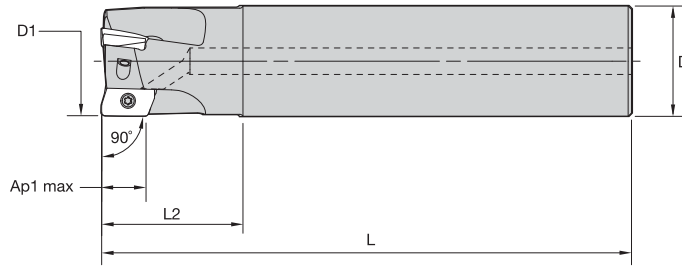

order number	catalogue number	D1	D	L	L2	Ap1 max	Z	max ramp angle	max RPM	coolant supply	kg
5416632	VSM11D012Z01A16XD11L100	12	16	100	25	11,7	1	3.7°	53100	Yes	0,13
6164360	VSM11D016Z02A12XD11L100	16	12	100	31	11,5	2	—	41400	Yes	0,08
5416633	VSM11D016Z02A16XD11L100	16	16	100	31	11,5	2	10.0°	41400	Yes	0,12
5416700	VSM11D016Z02A16XD11L170	16	16	170	25	11,5	2	10.0°	41400	Yes	0,23
6171450	VSM11D018Z02A16XD11L100	18	16	100	31	11,6	2	—	39000	Yes	0,13
5416701	VSM11D018Z02A16XD11L170	18	16	170	25	11,6	2	9.7°	37900	Yes	0,23
5416634	VSM11D020Z02A20XD11L110	20	20	110	31	11,6	2	7.8°	35100	Yes	0,22
5416702	VSM11D020Z02A20XD11L170	20	20	170	41	11,6	2	7.8°	35100	Yes	0,35
5416635	VSM11D020Z03A20XD11L110	20	20	110	31	11,6	3	7.8°	35100	Yes	0,23
5416703	VSM11D020Z03A20XD11L170	20	20	170	41	11,6	3	7.8°	35100	Yes	0,36
6171502	VSM11D022Z03A20XD11L110	22	20	110	31	11,5	3	—	33460	Yes	0,24
5416704	VSM11D022Z03A20XD11L170	22	20	170	30	11,5	3	6.6°	32900	Yes	0,37
5416636	VSM11D025Z03A25XD11L120	25	25	120	33	11,5	3	5.3°	30200	Yes	0,39
5416705	VSM11D025Z03A25XD11L210	25	25	210	50	11,5	3	5.3°	30200	Yes	0,70
5416637	VSM11D025Z04A25XD11L120	25	25	120	33	11,5	4	5.3°	30200	Yes	0,40
5416706	VSM11D025Z04A25XD11L210	25	25	210	50	11,5	4	5.3°	30200	Yes	0,72
6171503	VSM11D032Z03A25XD11L130	32	25	130	41	11,4	3	—	25800	Yes	0,37
5416638	VSM11D032Z03A32XD11L130	32	32	130	41	11,4	3	3.6°	25800	Yes	0,70
5416707	VSM11D032Z03A32XD11L250	32	32	250	65	11,4	3	3.6°	25800	Yes	1,39
5416639	VSM11D032Z05A32XD11L130	32	32	130	41	11,4	5	3.6°	25800	Yes	0,71

NOTE: Standard milling cutters will accept insert nose radii up to 1,6mm without modification.
For tool body modification instructions, see page A114.

VSM11 • Shell Mills • Metric

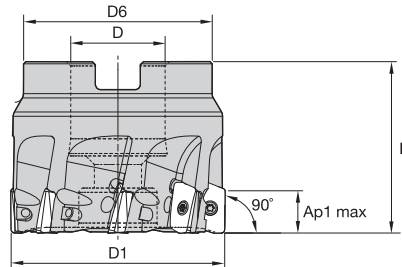

order number	catalogue number	D1	D	D6	L	Ap1 max	Z	max ramp angle	max RPM	coolant supply	kg
5416316	VSM11D040Z04S016XD11	40	16	37	40	11,4	4	2.6°	22600	Yes	0,22
5416317	VSM11D040Z06S016XD11	40	16	37	40	11,4	6	2.6°	22600	Yes	0,22
5416318	VSM11D050Z05S022XD11	50	22	44	40	11,3	5	1.9°	19900	Yes	0,33
5416319	VSM11D050Z08S022XD11	50	22	44	40	11,3	8	1.9°	19900	Yes	0,33
5416340	VSM11D063Z06S022XD11	63	22	44	40	11,3	6	1.5°	17500	Yes	0,50
5416341	VSM11D063Z09S022XD11	63	22	44	40	11,3	9	1.5°	17500	Yes	0,52
5416342	VSM11D080Z08S027XD11	80	27	60	50	11,3	8	1.1°	15300	Yes	1,14
5416345	VSM11D100Z09S032XD11	100	32	80	50	11,3	9	.9°	13600	Yes	1,79
5416347	VSM11D125Z011S040XD11	125	40	80	63	11,3	11	.7°	12100	Yes	3,01

VSM11™ • Helical End Mills with Weldon® Shank • Metric

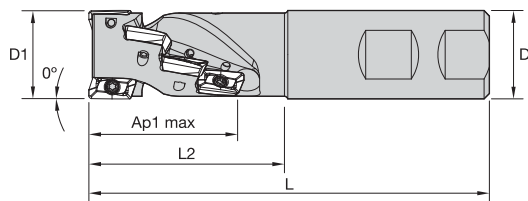

order number	catalogue number	D1	D	L	L2	Ap1 max	Z	Z U	max ramp angle	max RPM	coolant supply	kg
6738387	VSM11H025Z02B25XD11	25	25	113	56	43,1	8	2	3.2	30000	Yes	0,3
6738389	VSM11H032Z03B32XD11	32	32	117	56	42,7	12	3	3.2	26500	Yes	0,6
6738411	VSM11H032Z04B32XD11	32	32	117	56	42,2	16	4	4.5	26500	Yes	0,6

NOTE: Z = number of pockets; ZU = number of flutes.

VSM11 • Helical Shell Mills • Metric

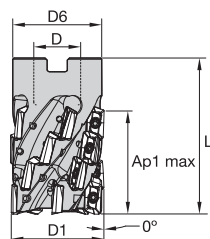

order number	catalogue number	D1	D	D6	L	Ap1 max	Z	Z U	max ramp angle	max RPM	coolant supply	kg
6738412	VSM11H040Z04S016XD11	40	16	37	60	42,3	16	4	2.4	22100	Yes	0,3
6738413	VSM11H040Z05S016XD11	40	16	37	60	42,7	20	5	2.4	22100	Yes	0,3
6738414	VSM11H050Z04S022XD11	50	22	44	70	51,6	20	4	1.8	19800	Yes	0,6
6738415	VSM11H050Z06S022XD11	50	22	44	70	51,6	30	6	1.8	19800	Yes	0,6

NOTE: Z = number of pockets; ZU = number of flutes.

FOR SPARE PARTS, PLEASE VISIT WIDIA.COM OR WIDIANOVO.COM.

MOUNTING SCREWS ARE NOT INCLUDED IN STANDARD PACKAGING.

90° Shoulder Mills • VSM Single-Sided Series

INDEXABLE MILLING

SOLID END MILLING

HOLEMAKING

TAPPING

TURNING

VSM11™ • XDCW-PCD

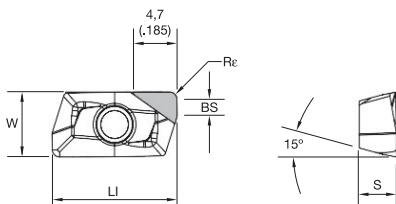

- first choice
- alternate choice

P	■	■	■	■	■	■	■	■	■	■	■	■	■	■	■	■	■
M	■	■	■	■	■	■	■	■	■	■	■	■	■	■	■	■	■
K	■	■	■	■	■	■	■	■	■	■	■	■	■	■	■	■	■
N	■	■	■	■	■	■	■	■	■	■	■	■	■	■	■	■	■
S	■	■	■	■	■	■	■	■	■	■	■	■	■	■	■	■	■
H	■	■	■	■	■	■	■	■	■	■	■	■	■	■	■	■	■

ISO catalogue number	cutting edges	LI	BS	S	W	Re	hm	WDN10U	WK15CM	WK15PM	WN10HM	WN25PM	WP25PM	WP35CM	WP40PM	WS30PM	WS40PM	WU20PM	WU35PM	
XDCW110404PDFRPCD	1	13,41	2,22	4,00	6,90	0,40	0,02	5415420	■	■	■	■	■	■	■	■	■	■	■	■
XDCW110408PDFRPCD	1	13,42	1,80	4,00	6,90	0,80	0,02	5415421	■	■	■	■	■	■	■	■	■	■	■	■

VSM11 • XDCT-ML

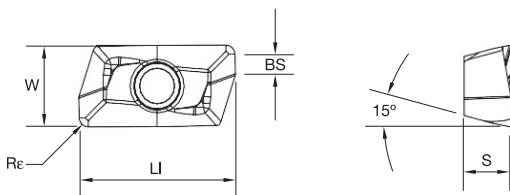

- first choice
- alternate choice

P	■	■	■	■	■	■	■	■	■	■	■	■	■	■	■	■	■
M	■	■	■	■	■	■	■	■	■	■	■	■	■	■	■	■	■
K	■	■	■	■	■	■	■	■	■	■	■	■	■	■	■	■	■
N	■	■	■	■	■	■	■	■	■	■	■	■	■	■	■	■	■
S	■	■	■	■	■	■	■	■	■	■	■	■	■	■	■	■	■
H	■	■	■	■	■	■	■	■	■	■	■	■	■	■	■	■	■

ISO catalogue number	cutting edges	LI	BS	S	W	Re	hm	WDN10U	WK15CM	WK15PM	WN10HM	WN25PM	WP25PM	WP35CM	WP40PM	WS30PM	WS40PM	WU20PM	WU35PM	
XDCT110404PDERML	2	13,43	2,09	4,00	6,90	0,40	0,04	■	■	6242456	■	■	■	5536671	5536670	5642230	■	■	■	■
XDCT110408PDERML	2	13,44	1,69	4,00	6,90	0,80	0,04	5415549	6242457	■	■	■	5415548	5536671	5536670	5642230	5517826	6180173	6180174	■
XDCT110412PDERML	2	13,44	1,29	4,00	6,90	1,20	—	■	■	■	■	■	6408003	■	■	■	■	■	■	■
XDCT110416PDERML	2	13,44	0,88	4,00	6,89	1,60	0,04	■	■	■	■	■	5964861	6408003	■	■	■	6408002	■	■
XDCT110424PDERML	2	13,44	0,16	4,00	6,88	2,40	—	■	■	■	■	■	■	■	■	■	■	6408006	■	■
XDCT110432PDERML	2	12,86	—	4,00	6,89	3,20	—	■	■	■	■	■	■	■	■	■	■	6408007	■	■

VSM11™ • XDET-MU

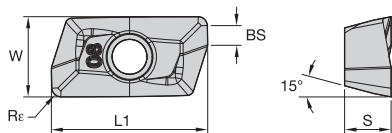

- first choice
- alternate choice

P	●								●	●	●	●	●	●	○	●	●	●	●
M	●								●	●	●	●	●	●	○	●	●	●	●
K	●								●	●	●	●	●	●	○	●	●	●	●
N	●								●	●	●	●	●	●	○	●	●	●	●
S	●								●	●	●	●	●	●	○	●	●	●	●
H	●								●	●	●	●	●	●	○	●	●	●	●

ISO catalogue number	cutting edges	LI	BS	S	W	Re	hm		WDN10U	WK15CM	WK15PM	WN10HM	WN25PM	WP25PM	WP35CM	WP40PM	WS30PM	WS40PM	WU20PM	WU35PM	
XDET110404PDERMU	2	13,43	2,09	4,00	6,90	0,40	0,04		●	●	●	●	●	●	●	●	●	●	●	●	●
XDET110408PDERMU	2	13,44	1,69	4,00	6,90	0,80	0,04		●	●	●	●	●	●	●	●	●	●	●	●	●

VSM11 • XDPT-MM

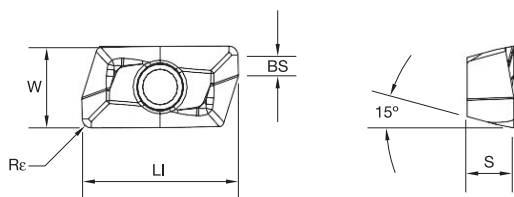

- first choice
- alternate choice

P	●																				
M	●								●	●	●	●	●	●	●	●	●	●	●	●	●
K	●								●	●	●	●	●	●	●	●	●	●	●	●	●
N	●								●	●	●	●	●	●	●	●	●	●	●	●	●
S	●								●	●	●	●	●	●	●	●	●	●	●	●	●
H	●								●	●	●	●	●	●	●	●	●	●	●	●	●

ISO catalogue number	cutting edges	LI	BS	S	W	Re	hm		WDN10U	WK15CM	WK15PM	WN10HM	WN25PM	WP25PM	WP35CM	WP40PM	WS30PM	WS40PM	WU20PM	WU35PM
XDPT110404PDSRMM	2	13,49	2,06	4,13	6,94	0,39	0,06		●	●	●	●	●	●	●	●	●	●	●	●
XDPT110408PDSRMM	2	13,50	1,66	4,13	6,90	0,78	0,06		●	●	●	●	●	●	●	●	●	●	●	●
XDPT110412PDSRMM	2	13,44	1,29	4,00	6,90	1,20	0,06		●	●	●	●	●	●	●	●	●	●	●	●
XDPT110416PDSRMM	2	13,51	0,85	4,13	6,95	1,60	0,06		●	●	●	●	●	●	●	●	●	●	●	●
XDPT110420PDSRMM	2	13,51	0,45	4,13	6,94	2,00	0,06		●	●	●	●	●	●	●	●	●	●	●	●
XDPT110424PDSRMM	2	13,37	—	4,01	6,94	2,40	0,06		●	●	●	●	●	●	●	●	●	●	●	●
XDPT110431PDSRMM	2	12,94	—	4,01	6,94	3,10	0,06		●	●	●	●	●	●	●	●	●	●	●	●

90° Shoulder Mills • VSM Single-Sided Series

INDEXABLE MILLING

VSM11 • XDPT-MH

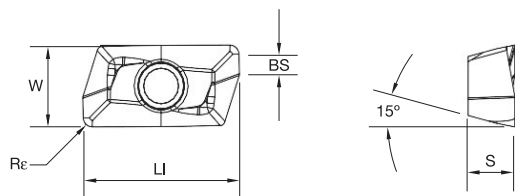

● first choice
○ alternate choice

P	■	■	■	■	■	●	●	●	○	●	●	●
M	■	■	■	■	■	●	●	●	○	●	●	●
K	■	■	■	■	■	●	●	●	○	●	●	●
N	■	■	■	■	■	●	●	●	○	●	●	●
S	■	■	■	■	■	●	●	●	○	●	●	●
H	■	■	■	■	■	●	●	●	○	●	●	●

ISO catalogue number	cutting edges	LI	BS	S	W	R _r	hm	WDN10U	WK15CM	WK15PM	WN10HM	WN25PM	WP25PM	WP35CM	WP40PM	WS30PM	WS40PM	WU20PM	WU35PM
XDPT110408PDSRMH	2	13,44	1,68	4,00	6,90	0,79	0,13	■	■	■	■	■	■	■	○	■	■	■	■
XDPT110412PDSRMH	2	13,44	1,29	4,00	6,90	1,20	0,13	■	■	■	■	■	■	■	○	■	■	■	■
XDPT110416PDSRMH	2	13,44	0,90	4,00	6,90	1,59	0,13	■	■	■	■	■	■	■	○	■	■	■	■

SOLID END MILLING

HOLEMAKING

VSM11 • XDPT-MU

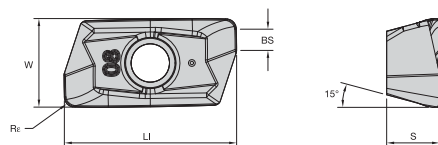

● first choice
○ alternate choice

P	■	■	■	■	■	●	●	●	○	●	●	●
M	■	■	■	■	■	●	●	●	○	●	●	●
K	■	■	■	■	■	●	●	●	○	●	●	●
N	■	■	■	■	■	●	●	●	○	●	●	●
S	■	■	■	■	■	●	●	●	○	●	●	●
H	■	■	■	■	■	●	●	●	○	●	●	●

ISO catalogue number	cutting edges	LI	BS	S	W	R _r	hm	WDN10U	WK15CM	WK15PM	WN10HM	WN25PM	WP25PM	WP35CM	WP40PM	WS30PM	WS40PM	WU20PM	WU35PM
XDPT110408PDSRMU	2	13,50	1,66	4,13	6,94	0,80	0,06	■	■	■	■	■	■	■	○	■	■	■	■
XDPT110416PDSRMU	2	13,51	0,85	4,13	6,95	1,60	0,06	■	■	■	■	■	■	■	○	■	■	■	■

TAPPING

TURNING

VSM11 • Insert Selection Guide

Material Group	Light Machining		General Purpose		Universal		Heavy Machining	
	Geometry	Grade	Geometry	Grade	Geometry	Grade	Geometry	Grade
P1-P2	XDCT-ML	WP40PM	XDPT-MM	WP40PM	XD..MU	WU20PM	XDPT-MH	WP40PM
P3-P4	XDCT-ML	WP40PM	XDPT-MM	WP40PM	XD..MU	WU20PM	XDPT-MH	WP40PM
P5-P6	XDPT-MM	WP25PM	XDPT-MM	WP35CM	XD..MU	WU20PM	XDPT-MH	WP40PM
M1-M2	XDCT-ML	WS40PM	XDPT-MM	WS40PM	XD..MU	WU20PM	XDPT-MH	WS40PM
M3	XDCT-ML	WS40PM	XDPT-MM	WS40PM	XD..MU	WU20PM	XDPT-MH	WS40PM
K1-K2	XDCT-ML	WK15CM	XDPT-MM	WK15CM	XD..MU	WU20PM	XDPT-MH	WK15CM
K3	XDCT-ML	WP35CM	XDPT-MM	WP35CM	XD..MU	WU20PM	XDPT-MH	WP35CM
N1-N2	XDCT-ALP	WN10HM	XDCT-ALP	WN25PM	-	-	XDCT-ALP	WN25PM
N3	XDCW-PCD	WDN10U	XDCW-PCD	WDN10U	-	-	XDCW-PCD	WDN10U
S1-S2	XDCT-ML	WP25PM	XDPT-MM	WS40PM	XD..MU	WU20PM	XDPT-MH	WS40PM
S3	XDCT-ML	WS40PM	XDPT-MM	WS40PM	XD..MU	WU20PM	XDPT-MH	WS40PM
S4	XDCT-ML	WS40PM	XDPT-MM	WS40PM	XD..MU	WU20PM	XDPT-MH	WS40PM
H1	XDCT-ML	WP25PM	XDPT-MM	WP25PM	XD..MU	WU20PM	XDPT-MU	WU20PM

NOTE: Use XDCT/XDET for precision.

VSM11™ • Recommended Starting Speeds [m/min]

Material Group		WDN10U			WK15CM			WK15PM			WN10HM			WN25PM			WP25PM		
P	1	—	—	—	—	—	—	—	—	—	—	—	—	—	—	330	285	270	
	2	—	—	—	—	—	—	—	—	—	—	—	—	—	—	275	240	200	
	3	—	—	—	—	—	—	—	—	—	—	—	—	—	—	255	215	175	
	4	—	—	—	—	—	—	—	—	—	—	—	—	—	—	225	185	150	
	5	—	—	—	—	—	—	—	—	—	—	—	—	—	—	185	170	150	
	6	—	—	—	—	—	—	—	—	—	—	—	—	—	—	165	125	100	
M	1	—	—	—	—	—	—	—	—	—	—	—	—	—	205	180	165		
	2	—	—	—	—	—	—	—	—	—	—	—	—	—	185	160	130		
	3	—	—	—	—	—	—	—	—	—	—	—	—	—	140	120	95		
K	1	—	—	—	420	385	340	270	245	215	—	—	—	—	230	205	185		
	2	—	—	—	335	295	275	210	190	175	—	—	—	—	180	160	150		
	3	—	—	—	280	250	230	175	160	145	—	—	—	—	150	135	120		
N	1	4010	3505	2990	—	—	—	—	—	—	795	695	600	1075	945	875	—		
	2	1600	1495	1400	—	—	—	—	—	—	795	695	600	945	875	760	—		
	3	1600	1495	1400	—	—	—	—	—	—	560	485	420	945	875	760	—		
S	1	—	—	—	—	—	—	—	—	—	—	—	—	—	40	35	25		
	2	—	—	—	—	—	—	—	—	—	—	—	—	—	40	35	25		
	3	—	—	—	—	—	—	—	—	—	—	—	—	—	50	40	25		
	4	—	—	—	—	—	—	—	—	—	—	—	—	—	70	50	35		
H	1	—	—	—	—	—	—	—	—	—	—	—	—	—	120	90	70		

Material Group		WP35CM			WP40PM			WS30PM			WS40PM			WU20PM			WU35PM		
P	1	455	395	370	295	260	245	—	—	—	—	—	—	330	290	270	260	230	215
	2	280	255	230	250	215	180	—	—	—	—	—	—	275	250	200	220	190	160
	3	255	230	205	230	195	160	—	—	—	—	—	—	255	220	175	200	170	140
	4	190	175	160	205	170	135	—	—	—	—	—	—	225	190	150	180	150	120
	5	260	230	210	170	155	135	—	—	—	170	145	120	185	175	150	150	135	120
	6	160	135	110	150	115	90	—	—	—	150	110	80	165	130	100	130	100	80
M	1	205	185	155	195	170	155	225	200	185	210	170	140	205	180	165	170	150	135
	2	185	160	140	175	150	125	205	180	145	180	145	120	185	160	130	155	130	110
	3	145	130	115	130	115	90	155	135	105	145	110	85	140	120	95	115	100	80
K	1	295	265	240	—	—	—	—	—	—	—	—	—	250	220	185	—	—	—
	2	235	210	190	—	—	—	—	—	—	—	—	—	200	180	150	—	—	—
	3	195	175	160	—	—	—	—	—	—	—	—	—	180	150	120	—	—	—
N	1	—	—	—	—	—	—	—	—	—	—	—	—	550	470	400	—	—	—
	2	—	—	—	—	—	—	—	—	—	—	—	—	550	470	400	—	—	—
	3	—	—	—	—	—	—	—	—	—	—	—	—	400	350	300	—	—	—
S	1	—	—	—	—	—	—	45	40	30	40	35	25	40	35	25	35	30	25
	2	—	—	—	—	—	—	45	40	30	40	35	25	40	35	25	35	30	25
	3	—	—	—	—	—	—	55	45	30	50	40	25	50	40	25	45	35	25
	4	—	—	—	—	—	—	70	60	40	60	50	30	70	50	35	60	45	30
H	1	—	—	—	—	—	—	—	—	—	—	—	—	110	80	70	—	—	—

NOTE: FIRST choice starting speeds are in bold type. As the average chip thickness increases, the speed should be decreased.
 *Material groups P, M, K, and H show recommended starting speeds for dry machining. For wet machining, reduce speed by 20%.
 *Material groups N and S show recommended starting speeds for wet machining. Not recommended for dry machining.

VSM11 • Recommended Starting Feeds [mm]

Light Machining	General Purpose	Heavy Machining
-----------------	-----------------	-----------------

Insert Geometry	Programmed Feed per Tooth (fz) as a % of Radial Depth of Cut (ae)															Insert Geometry
	5%			10%			20%			30%			40-100%			
.F..PCD	0,12	0,18	0,29	0,08	0,13	0,21	0,06	0,10	0,16	0,06	0,09	0,14	0,05	0,08	0,12	.F..PCD
.F..ALP	0,12	0,22	0,31	0,08	0,16	0,23	0,06	0,12	0,17	0,06	0,10	0,15	0,05	0,10	0,14	.F..ALP
.E..ML	0,17	0,27	0,36	0,13	0,20	0,26	0,10	0,15	0,19	0,08	0,13	0,17	0,08	0,12	0,16	.E..ML
.S..MM/.S..MU	0,23	0,32	0,47	0,17	0,23	0,34	0,13	0,17	0,25	0,11	0,15	0,22	0,10	0,14	0,20	.S..MM/.S..MU
.S..MH	0,23	0,37	0,56	0,17	0,27	0,40	0,13	0,20	0,30	0,11	0,17	0,26	0,10	0,16	0,24	.S..MH

NOTE: Use "Light Machining" value as starting feed rate.

VSM Single-Sided Series

VSM17™ Shoulder Mill



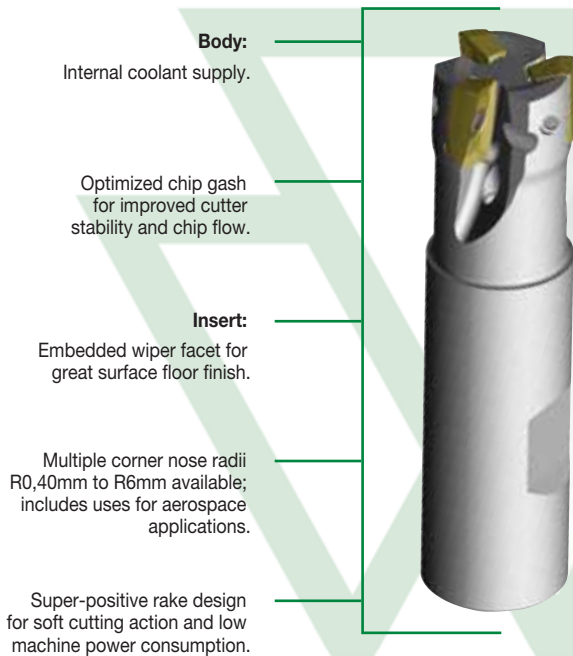

The VSM17 shoulder mill will thrive in precise machining to medium roughing applications. Its two-edged, single-sided inserts deliver low horsepower consumption and soft cutting action on a variety of workpieces.



The VSM17 shoulder mill is built for high DOC scenarios with A_p capabilities up to 16mm and a super-positive rake design for soft cutting action and low machine power consumption.

Six insert geometries are available to apply in a variety of applications and materials.

GEOMETRIES FOR ALL MATERIAL GROUPS IN SHOULDER MILLING APPLICATIONS

-ALP	-ML	-MM	-MH	-MU
				
N	P M S H	P M K S H	P M K S	P M K N S
Roughing and finishing of aluminum alloys. High precision. Periphery ground.	Light machining and finishing. First choice for stainless steel and titanium. Periphery ground.	Medium machining. First choice for general purpose. Precision pressed to size.	First choice for heavy-duty machining. Steel and cast iron materials. Precision pressed to size.	First choice for low to medium cutting parameters. Precision pressed to size and periphery ground.

Finishing Capabilities/Lower Cutting Forces

Geometry Strengthening

LOW POWER CONSUMPTION, HIGH DEPTH OF CUT

PRODUCT

SERIES

VSM17™

DIAMETER RANGE

Screw-On End Mills: 25–40mm
 Weldon End Mills: 25–40mm
 Cylindrical End Mills: 25–40mm
 Shell Mills: 40–125mm
 Helical End Mills: 50–80mm

SHANK TYPES

Screw-On End Mills
 Weldon® End Mills
 Cylindrical End Mills
 Shell Mills
 Helical End Mills

INDUSTRY



APPLICATIONS



SIDE MILLING/
SHOULDER
MILLING:
SQUARE END



SIDE MILLING/
SHOULDER
MILLING:
BOTTOM
SHOULDERING



SLOTING:
SQUARE END



SLOTING
SIDE



FACE
MILLING



RAMPING
BLANK



HELICAL
INTERPOLATION/
POCKET MILLING



3D
PROFILING



POCKETING



PLUNGE
MILLING

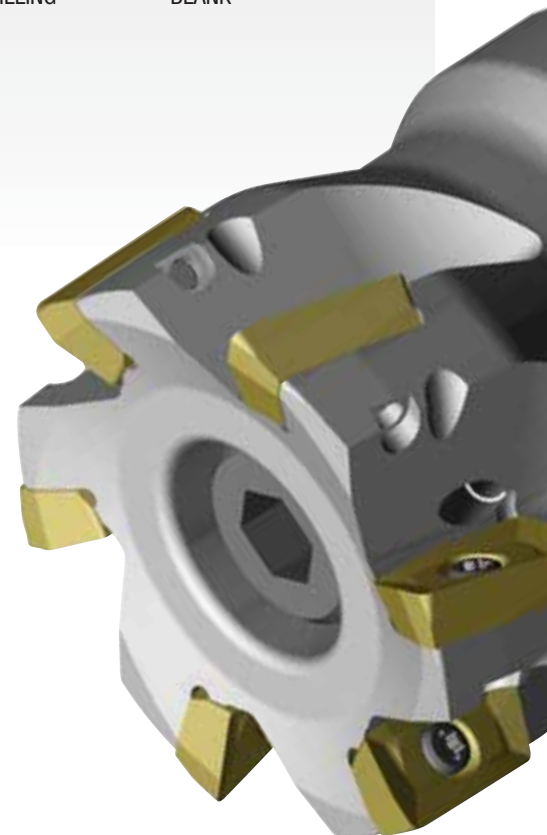

**LOW POWER
CONSUMPTION**

**SINGLE-SIDED
INSERTS**

VSM17™ • Screw-On End Mills • Metric

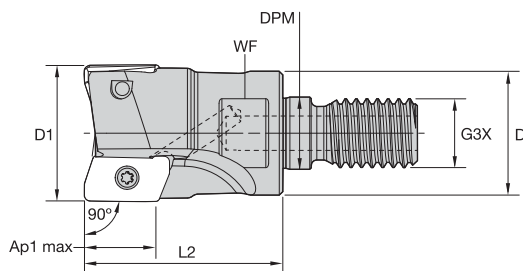

order number	catalogue number	D1	D	DPM	G3X	L2	WF	Ap1 max	Z	max ramp angle	max RPM	coolant supply	kg
5988091	VSM17D025Z02M12XD17	25	21	12,5	M12	35	17	16,4	2	8.8°	41800	Yes	0,08
5988092	VSM17D032Z03M16XD17	32	29	17,0	M16	40	24	16,3	3	5.7°	34700	Yes	0,17
5988131	VSM17D40Z03M016XD17	40	29	17,0	M16	40	24	16,2	3	4.0°	29800	Yes	0,20
5988093	VSM17D040Z04M16XD17	40	29	17,0	M16	40	24	16,2	4	4.0°	29800	Yes	0,20

NOTE: Standard milling cutters will accept insert nose radii up to 1,6mm without modification.
For tool body modification instructions, see page A114.

VSM17 • Weldon® End Mills • Metric

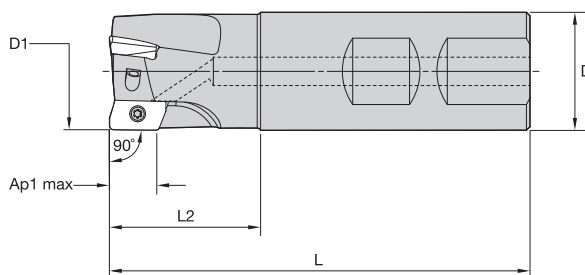

order number	catalogue number	D1	D	L	L2	Ap1 max	Z	max ramp angle	max RPM	coolant supply	kg
5988102	VSM17D025Z02B25XD17	25	25	90	33	16,4	2	8.8°	41800	Yes	0,26
5988103	VSM17D032Z03B32XD17	32	32	100	39	16,3	3	5.7°	34700	Yes	0,48
5988104	VSM17D040Z04B40XD17	40	40	110	39	16,2	4	4.0°	29800	Yes	0,87

NOTE: Weldon type not recommended for finishing operations.
NOTE: Standard milling cutters will accept insert nose radii up to 1,6mm without modification.
For tool body modification instructions, see page A114.

FOR SPARE PARTS, PLEASE VISIT WIDIA.COM OR WIDIANOVO.COM.
MOUNTING SCREWS ARE NOT INCLUDED IN STANDARD PACKAGING.

VSM17™ • Cylindrical End Mills • Metric

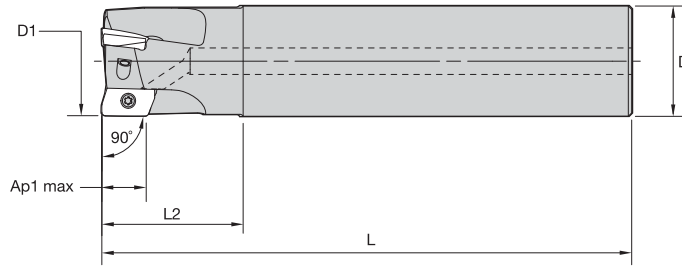

order number	catalogue number	D1	D	L	L2	Ap1 max	Z	max ramp angle	max RPM	coolant supply	kg
5988055	VSM17D025Z02A25XD17L110	25	25	110	44	16,4	2	8.8°	41800	Yes	0,32
5988056	VSM17D025Z02A25XD17L170	25	25	170	44	16,4	2	8.8°	41800	Yes	0,54
5988107	VSM17D032Z02A32XD17L120	32	32	120	50	16,3	2	5.7°	34700	Yes	0,60
5988108	VSM17D032Z02A32XD17L210	32	32	210	50	16,3	2	5.7°	34700	Yes	1,14
5988057	VSM17D032Z03A32XD17L120	32	32	120	50	16,3	3	5.7°	34700	Yes	0,60
5988058	VSM17D032Z03A32XD17L210	32	32	210	50	16,3	3	5.7°	34700	Yes	1,13
5988109	VSM17D040Z03A32XD17L130	40	32	130	50	16,2	3	4.0°	29800	Yes	0,77
5988110	VSM17D040Z03A32XD17L250	40	32	250	50	16,2	3	4.0°	29800	Yes	1,49
5988059	VSM17D040Z04A32XD17L130	40	32	130	50	16,2	4	4.0°	29800	Yes	0,77
5988060	VSM17D040Z04A32XD17L250	40	32	250	50	16,2	4	4.0°	29800	Yes	1,49

NOTE: Standard milling cutters will accept insert nose radii up to 2,0mm without modification.
For tool body modification instructions, see page A114.

VSM17 • Shell Mills • Metric

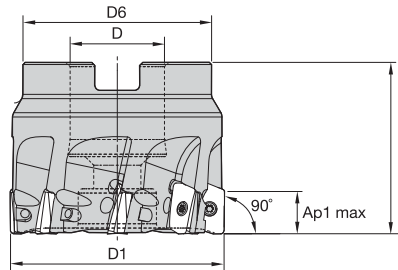

order number	catalogue number	D1	D	D6	L	Ap1 max	Z	max ramp angle	max RPM	coolant supply	kg
5988094	VSM17D040Z04S16XD17	40	16	37	40	16,2	4	4.0°	29800	Yes	0,19
5988095	VSM17D050Z04S22XD17	50	22	45	40	16,1	4	3.0°	25800	Yes	0,28
5988096	VSM17D050Z05S22XD17	50	22	45	40	16,1	5	3.0°	25800	Yes	0,29
5988134	VSM17D050Z06S22XD17	50	22	45	40	16,1	6	3.0°	25800	Yes	0,28
5988097	VSM17D063Z05S22XD17	63	22	50	40	16,0	5	2.1°	22400	Yes	0,45
5988135	VSM17D063Z06S22XD17	63	22	50	40	16,0	6	2.1°	22400	Yes	0,45
5988098	VSM17D080Z06S27XD17	80	27	60	50	15,9	6	1.6°	19500	Yes	0,98
5988133	VSM17D080Z07S27XD17	80	27	60	50	15,9	7	1.6°	19500	Yes	0,96
5988099	VSM17D100Z08S32XD17	100	32	80	50	15,8	8	1.2°	17200	Yes	1,63
5988100	VSM17D125Z09S40XD17	125	40	90	63	15,7	9	.9°	15200	Yes	2,94
5988101	VSM17D160Z12S40XD17	160	40	100	63	15,8	12	.7°	13300	Yes	3,66

NOTE: Standard milling cutters will accept insert nose radii up to 2,0mm without modification.
For tool body modification instructions, see page A114.

INDEXABLE MILLING

SOLID END MILLING

HOLEMAKING

TAPPING

TURNING

VSM17™ • Helical Shell Mills • Metric

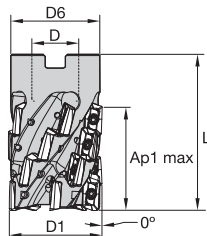

order number	catalogue number	D1	D	D6	L	Ap1 max	Z	Z U	max ramp angle	max RPM	coolant supply	kg
6740674	VSM17H050Z04S022XD17	50	22	44	85	60,4	16	4	2.8	25000	Yes	0,7
6740675	VSM17H050Z05S022XD17	50	22	44	85	60,4	20	5	2.8	25000	Yes	0,7
6740676	VSM17H063Z04S027XD17	63	27	60	100	75,0	20	4	2.1	22300	Yes	1,5
6740677	VSM17H063Z05S027XD17	63	27	60	100	75,0	25	5	2.1	22300	Yes	1,5
6740678	VSM17H080Z05S032XD17	80	32	70	100	75,0	25	5	1.6	19700	Yes	2,6

NOTE: Z = number of pockets; ZU = number of flutes.

Application Example

Modification Instructions for Use of Larger Radii Inserts
(Shoulder Mills and Helical Mills)

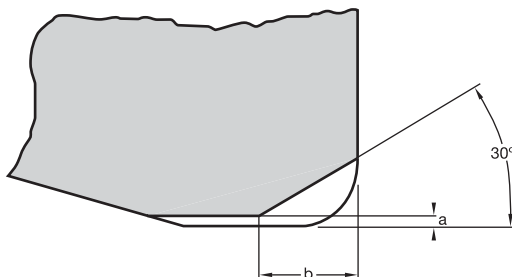

insert corner radius	material to remove	
	a	b
3,1mm	0,2mm	1,8mm

FOR SPARE PARTS, PLEASE VISIT WIDIA.COM OR WIDIANOVO.COM.
MOUNTING SCREWS ARE NOT INCLUDED IN STANDARD PACKAGING.

VSM17™ • XDCT-ML

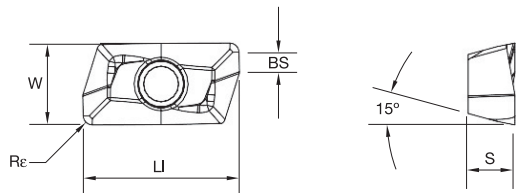

- first choice
- alternate choice

P						●	●	●	●	●	●	●	●	●	●
M						●				●	●	●	●	●	●
K	●		●						○	○	○	○	○	○	○
N						●	●					○	○	○	○
S									●	●	○	○	○	○	○
H									○					○	

ISO catalogue number	cutting edges	LI	BS	S	W	R _ε	hm	WK15CM	WK15PM	WN10HM	WN25PM	WP25PM	WP35CM	WP40PM	WS40PM	WU20PM	WU35PM
XDCT170404PEERML	2	19,15	2,62	4,90	9,60	0,40	0,04	•	•	•	•	•	•	•	•	•	•
XDCT170408PEERML	2	19,15	2,22	4,90	9,60	0,80	0,04	•	•	•	•	•	•	•	•	•	•
XDCT170412PEERML	2	19,16	1,82	4,90	9,60	1,20	0,04	•	•	•	•	•	•	•	•	•	•
XDCT170416PEERML	2	19,17	1,42	4,90	9,60	1,60	0,04	•	•	•	•	•	•	•	•	•	•
XDCT170420PEERML	2	19,17	1,01	4,90	9,60	2,00	0,04	•	•	•	•	•	•	•	•	•	•
XDCT170424PEERML	2	19,17	0,63	4,90	9,60	2,40	0,04	•	•	•	•	•	•	•	•	•	•
XDCT170432PEERML	2	18,85	—	4,89	9,59	3,20	0,04	•	•	•	•	•	•	•	•	•	•
XDCT170440PEERML	2	18,33	—	4,87	9,59	4,00	0,04	•	•	•	•	•	•	•	•	•	•
XDCT170460PEERML	2	17,02	—	4,80	9,56	6,00	0,04	•	•	•	•	•	•	•	•	•	•

90° Shoulder Mills • VSM Single-Sided Series

INDEXABLE MILLING

SOLID END MILLING

HOLEMAKING

TAPPING

TURNING

VSM17™ • XDCT-ALP

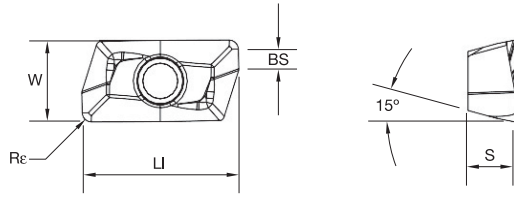

- first choice
- alternate choice

P							●	●	●	●	●	●	●
M	●						○	○	○	○	○	○	○
K	●	●					○	○	○	○	○	○	○
N							○	○	○	○	○	○	○
S							○	○	○	○	○	○	○
H							○	○	○	○	○	○	○

ISO catalogue number	cutting edges	LI	BS	S	W	Rε	hm	WK15CM	WK15PM	WN10HM	WN25PM	WP25PM	WP35CM	WP40PM	WS40PM	WU20PM	WU35PM
XDCT170404PEFRALP	2	19,15	2,62	4,90	9,60	0,40	0,02	●	●	○	○	○	○	○	○	○	○
XDCT170408PEFRALP	2	19,15	2,22	4,90	9,60	0,80	0,02	●	●	○	○	○	○	○	○	○	○
XDCT170412PEFRALP	2	19,16	1,82	4,90	9,60	1,20	0,02	●	●	○	○	○	○	○	○	○	○
XDCT170416PEFRALP	2	19,17	1,42	4,90	9,60	1,60	0,02	●	●	○	○	○	○	○	○	○	○
XDCT170420PEFRALP	2	19,17	1,01	4,90	9,60	2,00	0,02	●	●	○	○	○	○	○	○	○	○
XDCT170424PEFRALP	2	19,17	0,63	4,90	9,60	2,40	0,02	●	●	○	○	○	○	○	○	○	○
XDCT170432PEFRALP	2	18,85	—	4,88	9,59	3,20	0,02	●	●	○	○	○	○	○	○	○	○
XDCT170440PEFRALP	2	18,33	—	4,87	9,59	4,00	0,02	●	●	○	○	○	○	○	○	○	○
XDCT170460PEFRALP	2	17,02	—	4,80	9,56	6,00	0,02	●	●	○	○	○	○	○	○	○	○

VSM17™ • XDET -MU

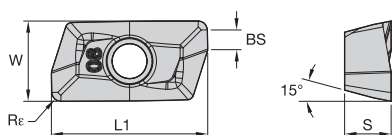

- first choice
- alternate choice

P										
M										
K										
N										
S										
H										

ISO catalogue number	cutting edges	LI	BS	S	W	Rε	hm	WK15CM	WK15PM	WN10HM	WN25PM	WP25PM	WP35CM	WP40PM	WS40PM	WU20PM	WU35PM	
XDET170408PEERMU	2	19,15	2,22	4,90	9,60	0,80	0,04	●	●	●	●	●	●	●	●	●	●	6862947

VSM17 • XDPT-MM

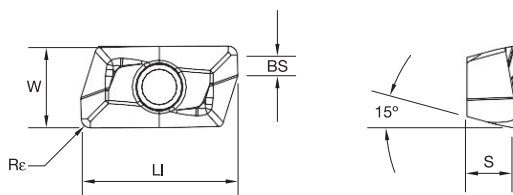

- first choice
- alternate choice

P																	
M																	
K																	
N																	
S																	
H																	

ISO catalogue number	cutting edges	LI	BS	S	W	Rε	hm	WK15CM	WK15PM	WN10HM	WN25PM	WP25PM	WP35CM	WP40PM	WS40PM	WU20PM	WU35PM
XDPT170404PESRMM	2	19,15	2,52	4,90	9,60	0,40	0,10	●	●	●	●	●	●	●	●	●	●
XDPT170408PESRMM	2	19,15	2,15	4,90	9,60	0,80	0,10	5987948	6242460	●	●	●	●	●	●	●	●
XDPT170412PESRMM	2	19,16	1,77	4,90	9,60	1,20	0,10	5988138	●	●	●	●	●	●	●	●	●
XDPT170416PESRMM	2	19,17	1,38	4,90	9,60	1,60	0,10	5988153	●	●	●	●	●	●	●	●	●
XDPT170420PESRMM	2	19,17	0,99	4,90	9,60	2,00	0,10	●	●	●	●	●	●	●	●	●	●
XDPT170424PESRMM	2	19,17	0,62	4,90	9,60	2,40	0,10	●	●	●	●	●	●	●	●	●	●
XDPT170432PESRMM	2	18,85	—	4,89	9,59	3,20	0,10	●	●	●	●	●	●	●	●	●	●
XDPT170440PESRMM	2	18,33	—	4,87	9,59	4,00	0,10	●	●	●	●	●	●	●	●	●	●

VSM17™ • XDPT-MH

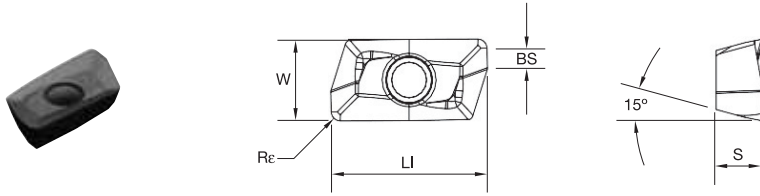

- first choice
- alternate choice

P	●					●	●	●	●	●	●	●
M	●											●
K	●	●						○	○			○
N	●											○
S	●							○	○	○		○
H												○

ISO catalogue number	cutting edges	LI	BS	S	W	Re	hm	WK15CM	WK15PM	WN10HM	WN25PM	WP25PM	WP35CM	WP40PM	WS40PM	WU20PM	WU35PM
XDPT170408PESRMH	2	19,15	2,10	4,91	9,60	0,80	0,13	5989053					5989054	5989052	6425148		
XDPT170412PESRMH	2	19,16	1,73	4,91	9,60	1,20	0,13	5991817					5991816	5991815	6425149		

VSM17 • XDPT-MU

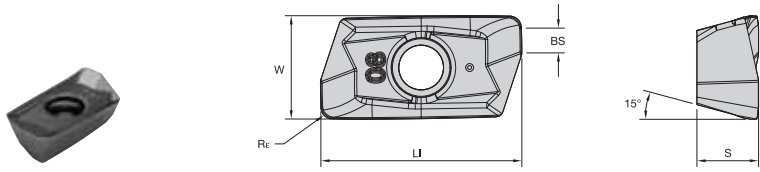

- first choice
- alternate choice

P	●					●	●	●	●	●	●	●
M	●											●
K	●	●						○	○			○
N	●											○
S	●							○	○	○		○
H												○

ISO catalogue number	cutting edges	LI	BS	S	W	Re	hm	WK15CM	WK15PM	WN10HM	WN25PM	WP25PM	WP35CM	WP40PM	WS40PM	WU20PM	WU35PM
XDPT170408PESRMU	2	19,15	2,15	4,90	9,60	0,80	0,05									6487444	

VSM17 • Insert Selection Guide

Material Group	Light Machining		General Purpose		Universal		Heavy Machining	
	Geometry	Grade	Geometry	Grade	Geometry	Grade	Geometry	Grade
P1-P2	XDCT-ML	WP40PM	XDPT-MM	WP40PM	XD..-MU	WU20PM	XDPT-MH	WP40PM
P3-P4	XDCT-ML	WP40PM	XDPT-MM	WP40PM	XD..-MU	WU20PM	XDPT-MH	WP40PM
P5-P6	XDPT-MM	WP25PM	XDPT-MM	WP35CM	XD..-MU	WU20PM	XDPT-MH	WP40PM
M1-M2	XDCT-ML	WS40PM	XDPT-MM	WS40PM	XD..-MU	WU20PM	XDPT-MM	WS40PM
M3	XDCT-ML	WS40PM	XDPT-MM	WS40PM	XD..-MU	WU20PM	XDPT-MH	WS40PM
K1-K2	XDPT-MM	WK15CM	XDPT-MM	WK15CM	XD..-MU	WU20PM	XDPT-MH	WK15CM
K3	XDPT-MM	WP35CM	XDPT-MM	WP35CM	XD..-MU	WU20PM	XDPT-MH	WP35CM
N1-N2	XDCT-ALP	WN10HM	XDCT-ALP	WN25PM	-	-	XDCT-ALP	WN25PM
N3	XDCT-ALP	WN10HM	XDCT-ALP	WN25PM	-	-	XDCT-ALP	WN25PM
S1-S2	XDCT-ML	WP25PM	XDPT-MM	WS40PM	XD..-MU	WU20PM	XDPT-MM	WS40PM
S3	XDCT-ML	WS40PM	XDPT-MM	WS40PM	XD..-MU	WU20PM	XDPT-MM	WS40PM
S4	XDCT-ML	WS40PM	XDPT-MM	WS40PM	XD..-MU	WU20PM	XDPT-MM	WS40PM
H1	-	-	-	-	XD..-MU	WU20PM	-	-

NOTE: Use XDCT/XDET for precision.

VSM17™ • Recommended Starting Speeds [m/min]

Material Group		WK15CM			WK15PM			WN10HM			WN25PM			WP25PM		
P	1	—	—	—	—	—	—	—	—	—	—	—	330	285	270	
	2	—	—	—	—	—	—	—	—	—	—	—	275	240	200	
	3	—	—	—	—	—	—	—	—	—	—	—	255	215	175	
	4	—	—	—	—	—	—	—	—	—	—	—	225	185	150	
	5	—	—	—	—	—	—	—	—	—	—	—	185	170	150	
	6	—	—	—	—	—	—	—	—	—	—	—	165	125	100	
M	1	—	—	—	—	—	—	—	—	—	—	—	205	180	165	
	2	—	—	—	—	—	—	—	—	—	—	—	185	160	130	
	3	—	—	—	—	—	—	—	—	—	—	—	140	120	95	
K	1	420	385	340	270	245	215	—	—	—	—	—	230	205	185	
	2	335	295	275	210	190	175	—	—	—	—	—	180	160	150	
	3	280	250	230	175	160	145	—	—	—	—	—	150	135	120	
N	1	—	—	—	—	—	—	795	695	600	1075	945	875	—	—	—
	2	—	—	—	—	—	—	795	695	600	945	875	760	—	—	—
	3	—	—	—	—	—	—	560	485	420	945	875	760	—	—	—
S	1	—	—	—	—	—	—	—	—	—	—	—	40	35	25	
	2	—	—	—	—	—	—	—	—	—	—	—	40	35	25	
	3	—	—	—	—	—	—	—	—	—	—	—	50	40	25	
	4	—	—	—	—	—	—	—	—	—	—	—	70	50	35	
H	1	—	—	—	—	—	—	—	—	—	—	—	120	90	70	

Material Group		WP35CM			WP40PM			WS40PM			WU20PM			WU35PM		
P	1	455	395	370	295	260	245	—	—	—	330	290	270	260	230	215
	2	280	255	230	250	215	180	—	—	—	275	250	200	220	190	160
	3	255	230	205	230	195	160	—	—	—	255	220	175	200	170	140
	4	190	175	160	205	170	135	—	—	—	225	190	150	180	150	120
	5	260	230	210	170	155	135	170	145	120	185	175	150	150	135	120
	6	160	135	110	150	115	90	150	110	80	165	130	100	130	100	80
M	1	205	185	155	195	170	155	210	170	140	205	180	165	170	150	135
	2	185	160	140	175	150	125	180	145	120	185	160	130	155	130	110
	3	145	130	115	130	115	90	145	110	85	140	120	95	115	100	80
K	1	295	265	240	—	—	—	—	—	—	250	220	185	—	—	—
	2	235	210	190	—	—	—	—	—	—	200	180	150	—	—	—
	3	195	175	160	—	—	—	—	—	—	180	150	120	—	—	—
N	1	—	—	—	—	—	—	—	—	—	550	470	400	—	—	—
	2	—	—	—	—	—	—	—	—	—	550	470	400	—	—	—
	3	—	—	—	—	—	—	—	—	—	400	350	300	—	—	—
S	1	—	—	—	—	—	—	40	35	25	40	35	25	35	30	25
	2	—	—	—	—	—	—	40	35	25	40	35	25	35	30	25
	3	—	—	—	—	—	—	50	40	25	50	40	25	45	35	25
	4	—	—	—	—	—	—	60	50	30	70	50	35	60	45	30
H	1	—	—	—	—	—	—	—	—	—	110	80	70	—	—	—

NOTE: FIRST choice starting speeds are in bold type. As the average chip thickness increases, the speed should be decreased.
 *Material groups P, M, K, and H show recommended starting speeds for dry machining. For wet machining, reduce speed by 20%.
 *Material groups N and S show recommended starting speeds for wet machining. Not recommended for dry machining.

VSM17 • Recommended Starting Feeds [mm]

Light Machining	General Purpose	Heavy Machining
-----------------	-----------------	-----------------

Insert Geometry	Programmed Feed per Tooth (fz) as a % of Radial Depth of Cut (ae)															Insert Geometry
	5%			10%			20%			30%			40-100%			
.F..ALP	0,12	0,23	0,40	0,08	0,17	0,29	0,06	0,13	0,22	0,06	0,11	0,19	0,05	0,10	0,18	.F..ALP
.E..ML	0,16	0,35	0,46	0,12	0,25	0,33	0,09	0,19	0,25	0,08	0,16	0,22	0,07	0,15	0,20	.E..ML
.S..MM/.S..MU	0,16	0,40	0,64	0,12	0,29	0,46	0,09	0,22	0,34	0,08	0,19	0,30	0,07	0,18	0,28	.S..MM/.S..MU
.S..MH	0,23	0,46	0,74	0,17	0,33	0,54	0,13	0,25	0,40	0,11	0,22	0,35	0,10	0,20	0,32	.S..MH

NOTE: Use "Light Machining" value as starting feed rate.

VSM Single-Sided Series

VSM22™ Shoulder Mill

The VSM22 shoulder mill will continuously face large-walled, big components in stainless steel, cast iron, and steel using high depth of cuts while providing free chip flow for a clean workpiece.



TWO INSERTS, EACH AVAILABLE IN THREE GRADES

-MH



-MM



WK15CM



WK15CM is a wear-resistant grade with balanced toughness for general milling of cast irons. Best results in dry machining, but can also be used wet.

WP35CM



WP35CM has a wide range of applications in general and rough milling of steels and cast iron. Performs best in dry, but can also be used under wet conditions.

WU20PM



WU20PM is a universal grade for machining of steel, stainless steel, and high-temperature alloys. Also suitable for machining of gray and nodular irons. Resists breakage and offers improved wear resistance and increased strength. Can be used for both dry and wet machining.

RELIABILITY, WHEN IT MATTERS MOST

PRODUCT

SERIES

VSM22™

DIAMETER RANGE

50–125mm

SHANK TYPES

Shell Mills

INDUSTRY



APPLICATIONS



FACE MILLING



PLUNGE MILLING



POCKETING



RAMPING



SIDE MILLING/
SHOULDER
MILLING:
SQUARE END



SLOTTING:
SQUARE END



POCKET MILLING



SLOTTING
SIDE

HEAVY DUTY

6,35mm thick -MH insert for heavy roughing.

HIGH DEPTH OF CUT

Insert with 20mm long cutting edge coupled with large chip gash to achieve high DOC.



VSM22™ Series • 90° • Shell Mills • Metric

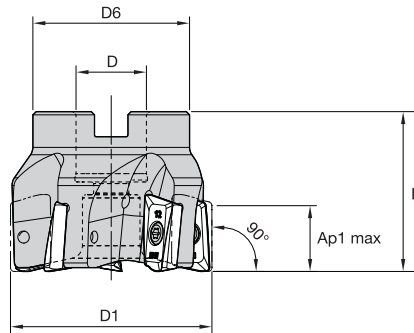

order number	catalogue number	D1	D	D6	L	Ap1 max	Z	max RPM	coolant supply	kg
3889581	VSM22D050Z04S22XP22	50	22	40	50	20,0	4	—	Yes	0,27
4056543	VSM22D063Z05S22XP22	63	22	49	50	20,0	5	—	Yes	0,54
3789432	VSM22D080Z06S27XP22	80	27	60	50	20,0	6	—	Yes	0,86
4056544	VSM22D100Z08S32XP22	100	32	78	50	20,0	8	—	Yes	1,38
4056545	VSM22D125Z09S40XP22	125	40	89	63	20,0	9	—	Yes	2,73
4056546	VSM22D160Z10S40XP22	160	40	90	63	20,0	10	6600	Yes	3,91

FOR SPARE PARTS, PLEASE VISIT WIDIA.COM OR WIDIANOVO.COM.
MOUNTING SCREWS ARE NOT INCLUDED IN STANDARD PACKAGING.

VSM22™ • XPHT-MH

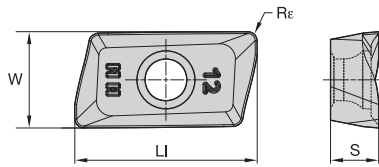

- first choice
- alternate choice

P	●	●	●
M	●	●	●
K	●	○	○
N	○	○	○
S	○	○	○
H	○	○	○

ISO catalogue number	cutting edges	LI	S	W	Re	hm	WK15CM	WP35CM	WU20PM
XPHT220612PDSRMH	2	22,55	6,35	12,70	1,20	0,23	6094886	6852416	3789524

VSM22 • XPHT-MM

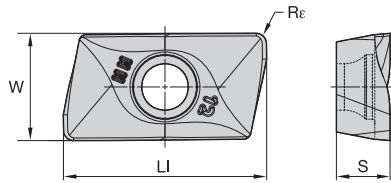

- first choice
- alternate choice

P	●	●	●
M	●	●	●
K	●	○	○
N	○	○	○
S	○	○	○
H	○	○	○

ISO catalogue number	cutting edges	LI	S	W	Re	hm	WK15CM	WP35CM	WU20PM
XPHT220612PDSRMM	2	22,55	6,35	12,70	1,20	0,23	6870184	6852415	-
XPHT220612PDSRMM	2	22,55	6,35	12,70	1,20	0,05	-	-	2567049

VSM22™ • Insert Selection Guide

Material Group	Light Machining		General Purpose		Heavy Machining	
	Geometry	Grade	Geometry	Grade	Geometry	Grade
P1-P2	.S.MM	WP35CM	.S.MH	WU20PM	.S.MH	WP35CM
P3-P4	.S.MM	WP35CM	.S.MH	WP35CM	.S.MH	WP35CM
P5-P6	.S.MM	WP35CM	.S.MH	WP35CM	.S.MH	WP35CM
M1-M2	.S.MH	WU20PM	.S.MH	WU20PM	.S.MH	WU20PM
M3	.S.MM	WP35CM	.S.MH	WP35CM	.S.MH	WP35CM
K1-K2	.S.MM	WK15CM	.S.MM	WK15CM	.S.MH	WK15CM
K3	.S.MM	WK15CM	.S.MM	WK15CM	.S.MH	WU20PM
N1-N2	.S.MH	WU20PM	.S.MH	WU20PM	.S.MH	WU20PM
N3	.S.MH	WU20PM	.S.MH	WU20PM	.S.MH	WU20PM
S1-S2	.S.MH	WU20PM	.S.MH	WU20PM	.S.MH	WU20PM
S3	.S.MH	WU20PM	.S.MH	WU20PM	.S.MH	WU20PM
S4	.S.MM	WP35CM	.S.MM	WP35CM	.S.MH	WP35CM
H1	.S.MH	WU20PM	.S.MH	WU20PM	-	-

VSM22 • Recommended Starting Speeds [m/min]

Material Group	1	WK15CM			WU20PM			WP35CM		
		1	2	3	1	2	3	1	2	3
P	1	-	-	-	330	290	270	455	395	370
	2	-	-	-	275	250	200	280	255	230
	3	-	-	-	255	220	175	255	230	205
	4	-	-	-	225	190	150	190	175	160
	5	-	-	-	185	175	150	260	230	210
	6	-	-	-	165	130	100	160	135	-
M	1	-	-	-	205	180	165	205	185	155
	2	-	-	-	185	160	130	185	160	140
	3	-	-	-	140	120	95	145	130	115
K	1	420	385	340	250	220	185	295	265	240
	2	335	295	275	200	180	150	235	210	190
	3	280	250	230	180	150	120	195	175	160
N	1	-	-	-	550	470	400	-	-	-
	2	-	-	-	550	470	400	-	-	-
	3	-	-	-	400	350	300	-	-	-
S	1	-	-	-	40	35	25	-	-	-
	2	-	-	-	40	35	25	-	-	-
	3	-	-	-	50	40	25	-	-	-
	4	-	-	-	70	50	35	66	50	33
H	1	-	-	-	110	80	70	-	-	-
	2	-	-	-	-	-	-	-	-	-
	3	-	-	-	-	-	-	-	-	-

NOTE: FIRST choice starting speeds are in **bold** type.
As the average chip thickness increases, the speed should be decreased.

VSM22 • Recommended Starting Feeds [mm]

Insert Geometry	Programmed Feed per Tooth (fz) as a % of Radial Depth of Cut (ae)															Insert Geometry
	5%			10%			20%			30%			40-100%			
.S.MM	0,23	0,55	0,90	0,17	0,40	0,65	0,13	0,30	0,49	0,11	0,26	0,42	0,10	0,24	0,39	.S.MM
.S.MH	0,23	0,59	0,95	0,17	0,43	0,68	0,13	0,32	0,51	0,11	0,28	0,44	0,10	0,25	0,41	.S.MH

NOTE: Use "Light Machining" value as starting feed rate.
For new applications, starting at a lighter feed rate is recommended.
% = ae/Dc X 100 (ae = radial depth of cut, Dc = cutting diameter)



VSM Series

VSM490-10™, VSM490-15™ Shoulder Mills

The VSM Series is a four-edged, double-sided roughing shoulder mill with embedded finishing capabilities known for producing a smooth wall finish in axial step-down jobs.



VSM490-10
Ap1 max = 10mm
Taper 40 spindles



VSM490-15
Ap1 max = 15mm
Taper 50 spindles

FOUR INSERT GEOMETRIES FOR ALL MATERIAL GROUPS IN SHOULDER MILLING APPLICATIONS

★ -ALP



N

For non-ferrous materials.

★ -ML



P M K S H

First choice for stainless steel, light machining, and finishing jobs.

★ -MM



P M K S H

First choice for general purpose in all material groups.

★ -MH



P K

First choice for HPC roughing cast iron. Strongest edge protection with additional margins.

Finishing Capabilities/Lower Cutting Forces

Geometry Strengthening

FOUR-EDGED SHOULDER MILL

PRODUCT		INSERTS		
SERIES	DIAMETER RANGE	INSERT TYPE	GRADE	MATERIALS
VSM490-10™	Screw-On End Mills: 16–32mm Cylindrical End Mills: 16–25mm Shell Mills: 40–125mm Weldon® End Mills: 16–25mm	ALP, ML, MM, MH	WP40PM, WS40PM, WP25PM, WU10PM	P M K S H
VSM490-15™	Weldon End Mills: 16–32mm Cylindrical End Mills: 16–32mm Shell Mills: 40–125mm	ALP, ML, MM, MH	WS40PM, WP25PM, WP40PM	P M S

APPLICATIONS



FACE
MILLING



EASED
CHAMFER



SIDE MILLING/
SHOULDER
MILLING:
SQUARE END



SLOTTING:
SQUARE END



POCKETING



SIDE MILLING/
SHOULDER
MILLING:
BOTTOM
SHOULDERING

INDUSTRY

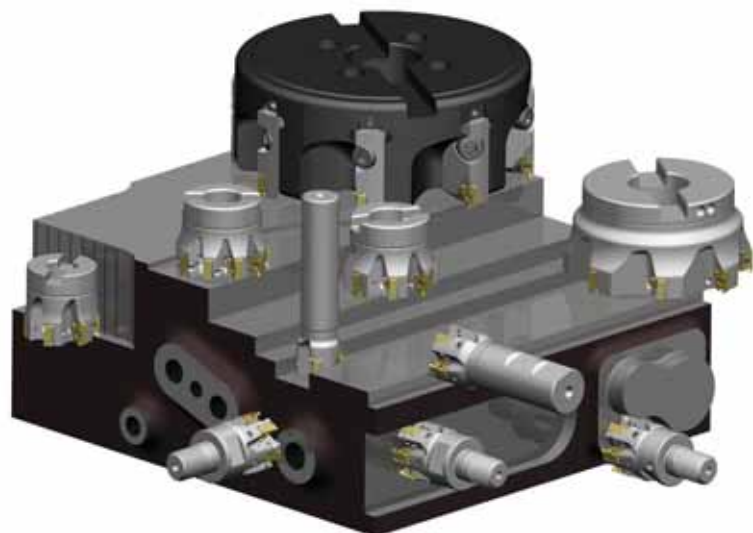

VSM490-10™ • Screw-On End Mills • Metric

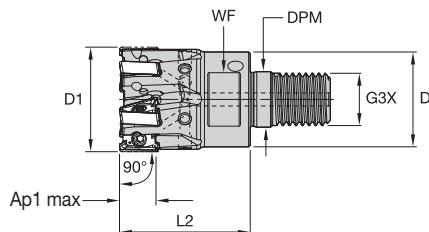

order number	catalogue number	D1	D	DPM	G3X	L2	WF	Ap1 max	Z	max RPM	coolant supply	kg
6425553	VSM490D016Z02M08XN10	16	13	8,5	M8	25	10	10,0	2	48000	Yes	0,03
6425554	VSM490D020Z03M10XN10	20	18	10,5	M10	28	15	10,0	3	40200	Yes	0,05
6425555	VSM490D025Z04M12XN10	25	21	12,5	M12	32	17	10,0	4	34300	Yes	0,09
6425556	VSM490D032Z05M16XN10	32	29	17,0	M16	40	24	10,0	5	29200	Yes	0,20
6425557	VSM490D032Z06M16XN10	32	29	17,0	M16	40	24	10,0	6	29200	Yes	0,20

VSM490-10 • Weldon® End Mills • Metric

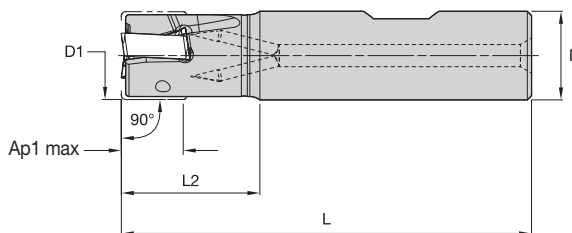

Regular Shank

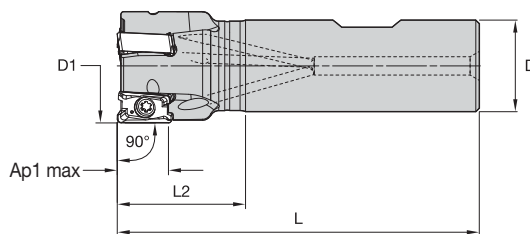

Reduced Shank

order number	catalogue number	D1	D	L	L2	Ap1 max	Z	max RPM	coolant supply	kg
6425558	VSM490D016Z02B16XN10	16	16	74	25	10,0	2	48000	Yes	0,09
6425559	VSM490D020Z02B20XN10	20	20	79	28	10,0	2	40200	Yes	0,16
6425560	VSM490D020Z03B20XN10	20	20	79	28	10,0	3	40200	Yes	0,16
6425571	VSM490D025Z03B20XN10	25	20	79	28	10,0	3	34300	Yes	0,18
6425572	VSM490D025Z03B25XN10	25	25	89	32	10,0	3	34300	Yes	0,29
6425573	VSM490D025Z04B25XN10	25	25	89	32	10,0	4	34300	Yes	0,29
6425574	VSM490D032Z04B25XN10	32	25	89	32	10,0	4	29200	Yes	0,29
6425575	VSM490D032Z05B25XN10	32	25	89	32	10,0	5	29200	Yes	0,33

NOTE: Weldon type not recommended for finishing operations.

FOR SPARE PARTS, PLEASE VISIT WIDIA.COM OR WIDIANOVO.COM.

MOUNTING SCREWS ARE NOT INCLUDED IN STANDARD PACKAGING.

VSM490™ -10 • Cylindrical End Mills (regular and long version) • Metric

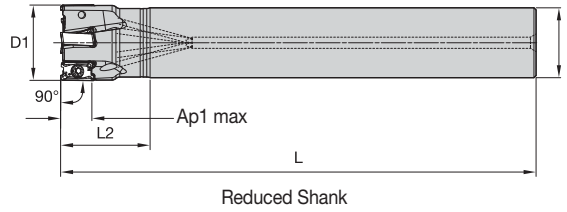
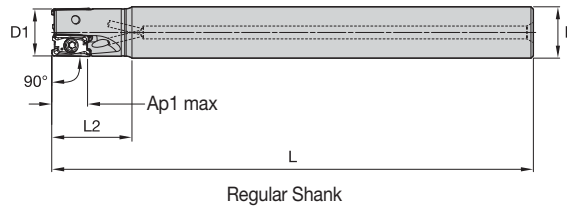

order number	catalogue number	D1	D	L	L2	Ap1 max	Z	max RPM	coolant supply	kg
6425502	VSM490D016Z02A16XN10L090	16	16	90	25	10,0	2	48000	Yes	0,12
6425503	VSM490D016Z02A16XN10L150	16	16	150	25	10,0	2	48000	Yes	0,21
6425504	VSM490D018Z02A16XN10L150	18	16	150	25	10,0	2	43500	Yes	0,21
6425506	VSM490D020Z02A20XN10L150	20	20	150	28	10,0	2	40200	Yes	0,33
6425505	VSM490D020Z03A20XN10L090	20	20	90	28	10,0	3	40200	Yes	0,19
6425507	VSM490D020Z03A20XN10L150	20	20	150	28	10,0	3	40200	Yes	0,33
6425508	VSM490D022Z03A20XN10L150	22	20	150	28	10,0	3	37500	Yes	0,34
6425509	VSM490D025Z03A20XN10L100	25	20	100	28	10,0	3	34300	Yes	0,23
6425511	VSM490D025Z03A25XN10L170	25	25	170	43	10,0	3	34300	Yes	0,60
6425510	VSM490D025Z04A25XN10L100	25	25	100	43	10,0	4	34300	Yes	0,33
6425512	VSM490D025Z04A25XN10L170	25	25	170	43	10,0	4	34300	Yes	0,59
6425513	VSM490D028Z04A25XN10L170	28	25	170	32	10,0	4	31800	Yes	0,61
6425514	VSM490D032Z04A25XN10L110	32	25	110	32	10,0	4	29200	Yes	0,41
6425516	VSM490D032Z04A25XN10L200	32	25	200	32	10,0	4	29200	Yes	0,75
6425515	VSM490D032Z05A25XN10L110	32	25	110	32	10,0	5	29200	Yes	0,41
6425517	VSM490D032Z05A25XN10L200	32	25	200	32	10,0	5	29200	Yes	0,75

INDEXABLE MILLING

SOLID END MILLING

HOLEMAKING

TAPPING

TURNING

VSM490-10 • Shell Mills • Metric

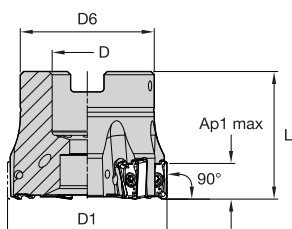

order number	catalogue number	D1	D	D6	L	Ap1 max	Z	max RPM	coolant supply	kg
6425434	VSM490D040Z04S16XN10	40	16	37	40	10,0	4	25400	Yes	0,23
6425435	VSM490D040Z06S16XN10	40	16	37	40	10,0	6	25400	Yes	0,23
6425436	VSM490D040Z07S16XN10	40	16	37	40	10,0	7	25400	Yes	0,23
6425437	VSM490D050Z05S22XN10	50	22	42	40	10,0	5	22300	Yes	0,31
6425438	VSM490D050Z07S22XN10	50	22	42	40	10,0	7	22300	Yes	0,35
6425439	VSM490D050Z09S22XN10	50	22	42	40	10,0	9	22300	Yes	0,32
6425440	VSM490D063Z05S22XN10	63	22	49	40	10,0	5	19500	Yes	0,56
6425481	VSM490D063Z07S22XN10	63	22	49	40	10,0	7	19500	Yes	0,56
6425482	VSM490D063Z09S22XN10	63	22	49	40	10,0	9	19500	Yes	0,56
6425483	VSM490D080Z06S27XN10	80	27	60	50	10,0	6	17100	Yes	1,10
6425484	VSM490D080Z08S27XN10	80	27	60	50	10,0	8	17100	Yes	1,11
6425485	VSM490D080Z10S27XN10	80	27	60	50	10,0	10	17100	Yes	1,12
6425486	VSM490D100Z08S32XN10	100	32	80	50	10,0	8	15200	Yes	1,73
6425487	VSM490D100Z12S32XN10	100	32	80	50	10,0	12	15200	Yes	1,74
6425488	VSM490D125Z10S40XN10	125	40	90	63	10,0	10	13500	Yes	3,18
6425489	VSM490D125Z14S40XN10	125	40	90	63	10,0	14	13500	Yes	3,20

NOTE: Socket-head cap screw with coolant groove and coolant lock screw assembly must be ordered separately.

VSM490-10 • Shell Mills • Japanese Industry Standard JIS • Metric

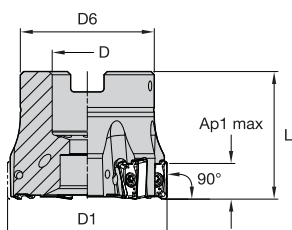

order number	catalogue number	D1	D	D6	L	Ap1 max	Z	max RPM	coolant supply	kg
6425490	VSM490D080Z06S254XN10JIS	80	25,40	50	50	10,0	6	17100	Yes	0,93
6425491	VSM490D080Z08S254XN10JIS	80	25,40	50	50	10,0	8	17100	Yes	0,94
6425492	VSM490D100Z08S3175XN10JIS	100	31,75	60	50	10,0	8	15200	Yes	1,41
6425493	VSM490D125Z10S381XN10JIS	125	38,10	80	63	10,0	10	13500	Yes	3,02

FOR SPARE PARTS, PLEASE VISIT WIDIA.COM OR WIDIANOVO.COM.

MOUNTING SCREWS ARE NOT INCLUDED IN STANDARD PACKAGING.

VSM490-10 • XNGU-ALP • For Aluminum and Other Non-Ferrous Alloys

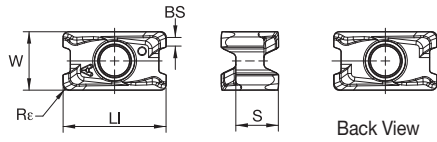

- first choice
- alternate choice

P	■	■	■	●	●	●	●
M	■	■	■	●	●	●	●
K	■	●	●	○	○	○	●
N	■	■	●	○	○	○	○
S	■	■	○	○	○	○	●
H	■	■	○	○	○	○	●

ISO catalogue number	cutting edges	LI	S	W	BS	Re	hm	WK15CM	WK15PM	WN25PM	WP25PM	WP35CM	WP40PM	WS40PM	WU10PM
XNGU100404ERALP	4	11,66	4,83	6,60	1,37	0,40	0,02	■	■	6425382	■	■	■	■	■
XNGU100408ERALP	4	11,66	4,83	6,60	1,00	0,80	0,02	■	■	6425411	■	■	■	■	■

VSM490-10 • XNGU-ML • Precision Finishing and Light Machining

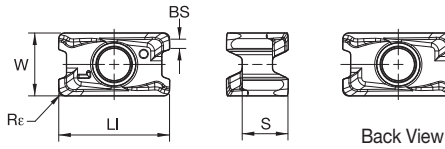

- first choice
- alternate choice

P	■	■	■	●	●	●	●
M	■	■	■	●	●	●	●
K	■	●	●	○	○	○	●
N	■	■	●	○	○	○	○
S	■	■	○	○	○	○	●
H	■	■	○	○	○	○	●

ISO catalogue number	cutting edges	LI	S	W	BS	Re	hm	WK15CM	WK15PM	WN25PM	WP25PM	WP35CM	WP40PM	WS40PM	WU10PM
XNGU100404ERML	4	11,66	4,83	6,60	1,37	0,40	0,02	■	■	■	6425414	■	■	6425415	■
XNGU100408ERML	4	11,66	4,83	6,60	1,00	0,80	0,02	■	■	6425369	■	■	6425370	6425421	■

INDEXABLE MILLING

VSM490-10 • XNGU-MM • Universal Geometry for Medium Machining

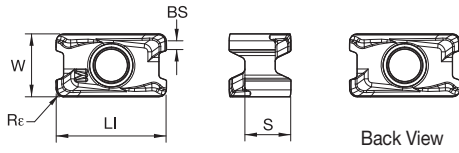

- first choice
- alternate choice

P	■	■	■	●	●	●	●
M	■	■	■	●	●	●	●
K	■	■	○	○	○	○	●
N	■	■	●	○	○	○	○
S	■	■	○	○	○	○	○
H	■	■	○	○	○	○	●

ISO catalogue number	cutting edges	LI	S	W	BS	Rr	hm	WK15CM	WK15PM	WN25PM	WP25PM	WP35CM	WP40PM	WS40PM	WU10PM
XNGU100404SRMM	4	11,66	4,83	6,60	1,37	0,40	0,08	■	■	■	●	●	●	●	●
XNGU100408SRMM	4	11,66	4,83	6,60	1,00	0,80	0,08	■	■	■	●	●	●	●	●

SOLID END MILLING

HOLEMAKING

VSM490-10 • XNGU-MH • Heavy Roughing

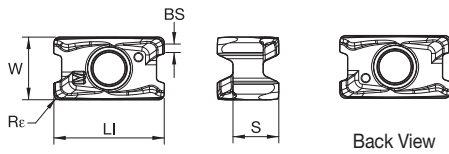

- first choice
- alternate choice

P	■	■	■	●	●	●	●
M	■	■	■	●	●	●	●
K	■	■	○	○	○	○	●
N	■	■	●	○	○	○	○
S	■	■	○	○	○	○	○
H	■	■	○	○	○	○	●

ISO catalogue number	cutting edges	LI	S	W	BS	Rr	hm	WK15CM	WK15PM	WN25PM	WP25PM	WP35CM	WP40PM	WS40PM	WU10PM
XNGU100408SRMH	4	11,66	4,83	6,60	0,90	0,80	0,08	●	■	■	●	●	●	●	●

TAPPING

TURNING

VSM490-10 • XNPU-ML • Light Machining

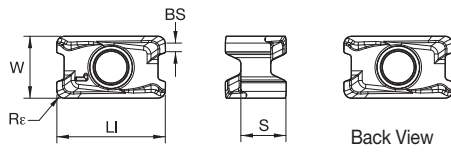

- first choice
- alternate choice

P	■	■	■	●	●	●	●
M	■	■	■	●	●	●	●
K	■	■	■	○	○	○	○
N	■	■	■	○	○	○	○
S	■	■	■	○	○	○	○
H	■	■	■	○	○	○	○

ISO catalogue number	cutting edges	LI	S	W	BS	Rε	hm	WK15CM	WK15PM	WN25PM	WP25PM	WP35CM	WP40PM	WS40PM	WU10PM
XNPU100408ERML	4	11,60	4,83	6,60	0,90	0,80	0,02	■	●	○	○	○	○	○	○

VSM490-10 • XNPU-MM • Universal Geometry for Medium Machining

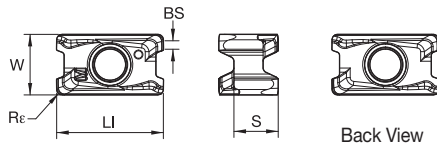

- first choice
- alternate choice

P	■	■	■	●	●	●	●
M	■	■	■	●	●	●	●
K	■	■	■	○	○	○	○
N	■	■	■	○	○	○	○
S	■	■	■	○	○	○	○
H	■	■	■	○	○	○	○

ISO catalogue number	cutting edges	LI	S	W	BS	Rε	hm	WK15CM	WK15PM	WN25PM	WP25PM	WP35CM	WP40PM	WS40PM	WU10PM
XNPU100408SRMM	4	11,60	4,83	6,60	0,90	0,80	0,08	■	●	○	○	○	○	○	○
XNPU100412SRMM	4	11,61	4,83	6,60	0,50	1,20	0,08	■	○	○	○	○	○	○	○
XNPU100416SRMM	4	11,61	4,83	6,60	0,10	1,60	0,08	■	○	○	○	○	○	○	○

VSM490-10 • Insert Selection Guide

Material Group	Light Machining		General Purpose		Heavy Machining	
	Geometry	Grade	Geometry	Grade	Geometry	Grade
P1-P2	XNGU-ML	WP40PM	XNPU-MM	WP40PM	XNPU-MM	WP40PM
P3-P4	XNGU-ML	WP40PM	XNPU-MM	WP40PM	XNPU-MM	WP40PM
P5-P6	XNGU-MM	WP25PM	XNPU-MM	WP35CM	XNPU-MM	WP40PM
M1-M2	XNGU-ML	WS40PM	XNGU-ML	WS40PM	XNPU-MM	WS40PM
M3	XNGU-ML	WS40PM	XNGU-ML	WS40PM	XNPU-MM	WS40PM
K1-K2	XNPU-ML	WK15PM	XNGU-MH	WK15CM	XNGU-MH	WK15CM
K3	XNPU-MM	WK15PM	XNGU-MH	WP35CM	XNGU-MH	WP35CM
N1-N2	XNGU-ALP	WN25PM	XNGU-ALP	WN25PM	XNGU-ALP	WN25PM
N3	XNGU-ALP	WN25PM	XNGU-ALP	WN25PM	XNGU-ALP	WN25PM
S1-S2	XNGU-ML	WP25PM	XNGU-ML	WS40PM	XNPU-MM	WS40PM
S3	XNGU-ML	WS40PM	XNGU-ML	WS40PM	XNPU-MM	WS40PM
S4	XNGU-ML	WS40PM	XNGU-ML	WS40PM	XNPU-MM	WS40PM
H1	XNGU-ML	WU10PM	XNGU-MM	WU10PM	-	-

VSM490-10 • Recommended Starting Speeds [m/min]

Material Group	WK15CM	WK15PM	WN25PM	WP25PM	WP35CM	WP40PM	WS40PM	WU10PM
P	1	- - -	- - -	330 285 270	455 395 370	295 260 245	- - -	- - -
	2	- - -	- - -	275 240 200	280 255 230	250 215 180	- - -	- - -
	3	- - -	- - -	255 215 175	255 230 205	230 195 160	- - -	- - -
	4	- - -	- - -	225 185 150	190 175 160	205 170 135	- - -	- - -
	5	- - -	- - -	185 170 150	260 230 210	170 155 135	170 145 120	- - -
M	1	- - -	- - -	165 125 100	160 135 110	150 115 90	150 110 80	- - -
	2	- - -	- - -	205 180 165	205 185 155	195 170 155	210 170 140	- - -
	3	- - -	- - -	185 160 130	185 160 140	175 150 125	180 145 120	- - -
K	1	420 385 340	270 245 215	- - -	230 205 185	295 265 240	- - -	295 265 240
	2	335 295 275	210 190 175	- - -	180 160 150	235 210 190	- - -	230 205 190
	3	280 250 230	175 160 145	- - -	150 135 120	195 175 160	- - -	195 175 160
N	1	- - -	- - -	1075 945 875	- - -	- - -	- - -	- - -
	2	- - -	- - -	945 875 760	- - -	- - -	- - -	- - -
	3	- - -	- - -	945 875 760	- - -	- - -	- - -	- - -
S	1	- - -	- - -	- - -	40 35 25	- - -	40 35 25	- - -
	2	- - -	- - -	- - -	40 35 25	- - -	40 35 25	- - -
	3	- - -	- - -	- - -	50 40 25	- - -	50 40 25	- - -
	4	- - -	- - -	- - -	70 50 35	- - -	60 50 30	- - -
H	1	- - -	- - -	- - -	- - -	- - -	- - -	160 130 90

NOTE: FIRST choice starting speeds are in **bold** type. As the average chip thickness increases, the speed should be decreased.
 *Material groups P, M, K, and H show recommended starting speeds for dry machining. For wet machining, reduce speed by 20%.
 *Material groups N and S show recommended starting speeds for wet machining. Not recommended for dry machining.

VSM490-10 • Recommended Starting Feeds [mm]

Light Machining	General Purpose	Heavy Machining
-----------------	-----------------	-----------------

Insert Geometry	Programmed Feed per Tooth (fz) as a % of Radial Depth of Cut (ae)															Insert Geometry
	5%			10%			20%			30%			40-100%			
.E..ALP	0.12	0.23	0.32	0.08	0.17	0.23	0.06	0.13	0.18	0.06	0.11	0.15	0.05	0.10	0.14	.E..ALP
.E..ML	0.18	0.28	0.37	0.13	0.20	0.27	0.10	0.15	0.20	0.09	0.13	0.17	0.08	0.12	0.16	.E..ML
.S..MM	0.23	0.35	0.46	0.17	0.25	0.33	0.13	0.19	0.25	0.11	0.17	0.22	0.10	0.15	0.20	.S..MM
.S..MH	0.23	0.43	0.58	0.17	0.31	0.42	0.13	0.23	0.31	0.11	0.20	0.27	0.10	0.18	0.25	.S..MH

NOTE: Use "Light Machining" value as starting feed rate.

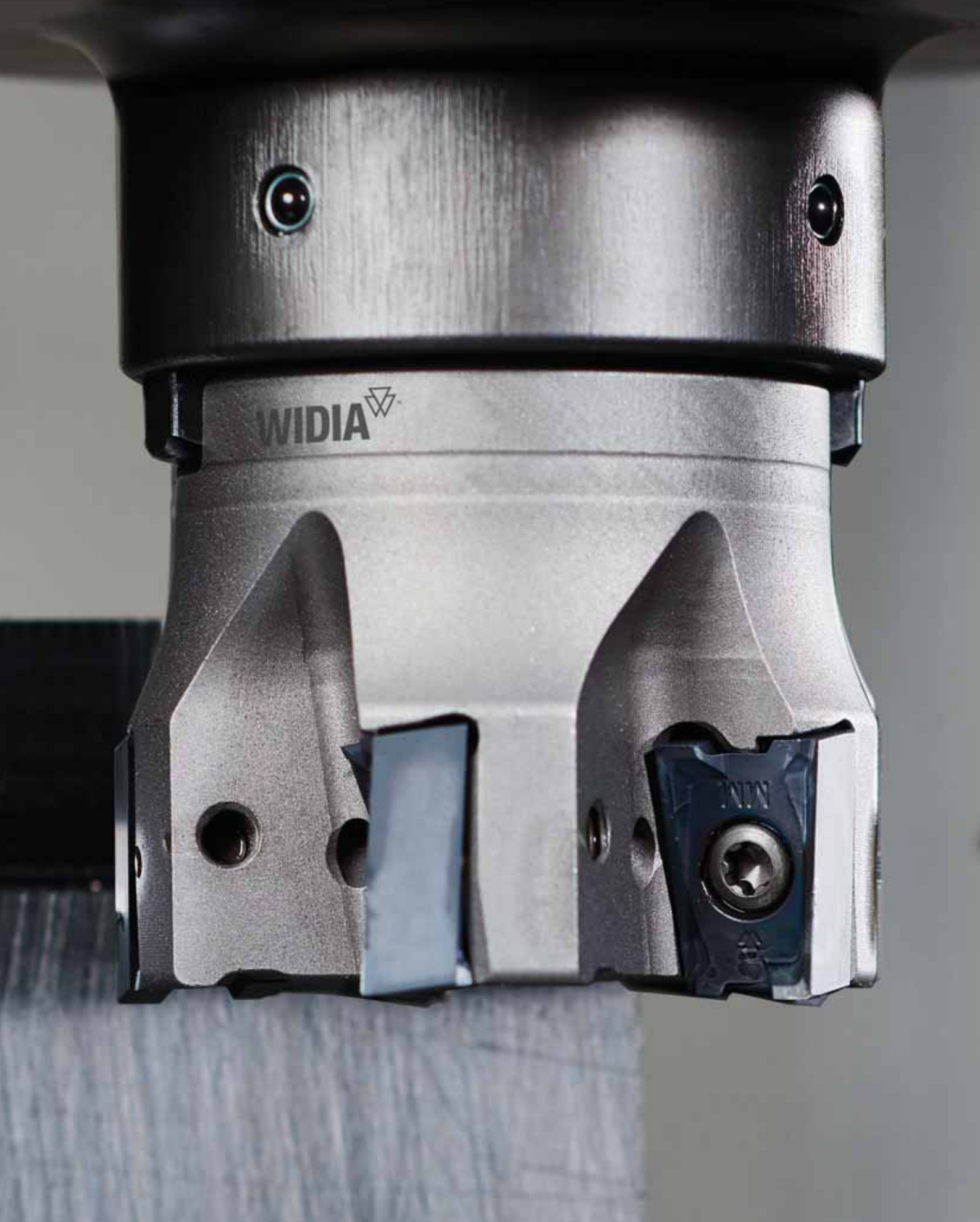

INDEXABLE MILLING

VSM490-15 • Screw-On End Mills • Metric

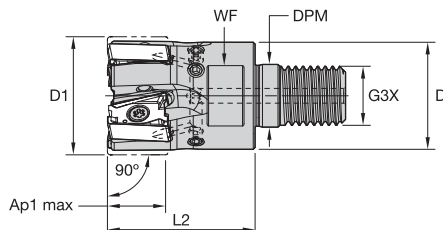

order number	catalogue number	D1	D	DPM	G3X	L2	WF	Ap1 max	Z	max RPM	coolant supply	kg
5873211	VSM490D025Z02M12XN15	25	21	12,5	M12	32	17	15,0	2	26700	Yes	0,18
5873212	VSM490D032Z03M16XN15	32	29	17,0	M16	40	24	15,0	3	22000	Yes	0,18
5873213	VSM490D032Z04M16XN15	32	29	17,0	M16	40	24	15,0	4	22000	Yes	0,18
5873214	VSM490D035Z04M16XN15	35	29	17,0	M16	40	24	15,0	4	20600	Yes	0,19

SOLID END MILLING

VSM490-15 • Weldon® End Mills • Metric

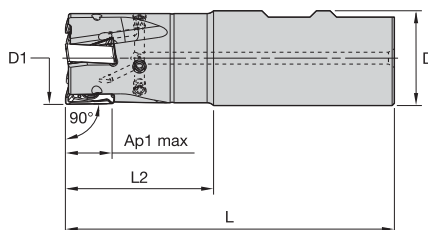

order number	catalogue number	D1	D	L	L2	Ap1 max	Z	max RPM	coolant supply	kg
5710285	VSM490D025Z02B25XN15	25	25	89	32	15,0	2	26700	Yes	0,28
5710286	VSM490D032Z03B32XN15	32	32	111	50	15,0	3	22000	Yes	0,58
5873215	VSM490D040Z03B32XN15	40	32	111	50	15,0	3	18800	Yes	0,65

NOTE: Weldon type not recommended for finishing operations.

HOLEMAKING

TAPPING

VSM490-15 • Cylindrical End Mills • Metric

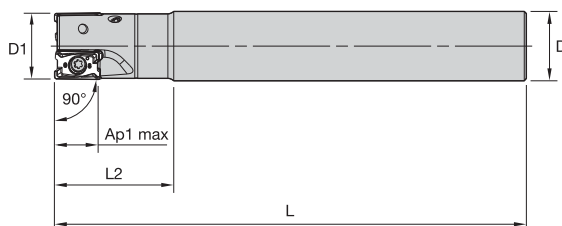

order number	catalogue number	D1	D	L	L2	Ap1 max	Z	max RPM	coolant supply	kg
5873216	VSM490D025Z02A25XN15L100	25	25	100	43	15,0	2	26700	Yes	0,32
5710287	VSM490D025Z02A25XN15L170	25	25	170	43	15,0	2	26700	Yes	0,59
5873217	VSM490D032Z03A32XN15L110	32	32	110	49	15,0	3	22000	Yes	0,59
5710288	VSM490D032Z03A32XN15L200	32	32	200	50	15,0	3	22000	Yes	1,14
5873218	VSM490D032Z04A32XN15L110	32	32	110	49	15,0	4	22000	Yes	0,58
5873219	VSM490D032Z04A32XN15L200	32	32	200	50	15,0	4	22000	Yes	1,14

TURNING

FOR SPARE PARTS, PLEASE VISIT WIDIA.COM OR WIDIANOVO.COM.

MOUNTING SCREWS ARE NOT INCLUDED IN STANDARD PACKAGING.

VSM490-15 • Shell Mills • Metric

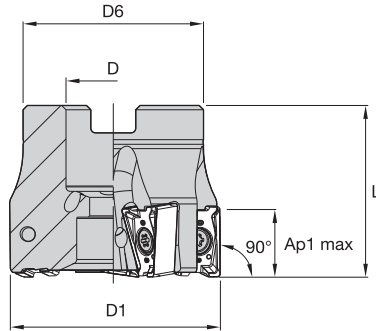

order number	catalogue number	D1	D	D6	L	Ap1 max	Z	max RPM	coolant supply	kg
5710289	VSM490D040Z04S16XN15	40	16	37	40	15,0	4	18800	Yes	0,20
5710520	VSM490D040Z05S16XN15	40	16	37	40	15,0	5	18800	Yes	0,19
5873221	VSM490D050Z04S22XN15	50	22	42	40	15,0	4	16300	Yes	0,28
5710521	VSM490D050Z05S22XN15	50	22	42	40	15,0	5	16300	Yes	0,28
5710522	VSM490D050Z06S22XN15	50	22	42	40	15,0	6	16300	Yes	0,28
5873222	VSM490D063Z05S22XN15	63	22	50	40	15,0	5	14200	Yes	0,50
5710523	VSM490D063Z06S22XN15	63	22	50	40	15,0	6	14200	Yes	0,49
5710524	VSM490D063Z07S22XN15	63	22	50	40	15,0	7	14200	Yes	0,48
5873223	VSM490D080Z05S27XN15	80	27	60	50	15,0	5	12300	Yes	1,03
5710525	VSM490D080Z07S27XN15	80	27	60	50	15,0	7	12300	Yes	1,03
5873224	VSM490D080Z09S27XN15	80	27	60	50	15,0	9	12300	Yes	1,04
5710526	VSM490D100Z08S32XN15	100	32	80	50	15,0	8	10900	Yes	1,61
5873225	VSM490D100Z11S32XN15	100	32	80	50	15,0	11	10900	Yes	1,64
5873226	VSM490D125Z09S40XN15	125	40	90	63	15,0	9	9600	Yes	2,96
5873227	VSM490D125Z12S40XN15	125	40	90	63	15,0	12	9600	Yes	3,11
5873228	VSM490D160Z12S40XN15	160	40	110	63	15,0	12	8400	Yes	4,80

NOTE: Socket-head cap screw with coolant groove and coolant lock screw assembly must be ordered separately.

VSM490-15 • Shell Mills • Japanese Industry Standard JIS • Metric

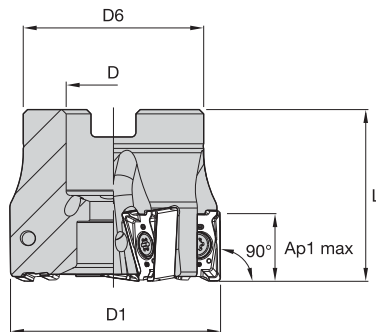

order number	catalogue number	D1	D	D6	L	Ap1 max	Z	max RPM	coolant supply	kg
6342806	VSM490D080Z05S254XN15JIS	80	25,40	50	50	15,0	5	12300	Yes	0,89
6342807	VSM490D080Z07S254XN15JIS	80	25,40	50	50	15,0	7	12300	Yes	0,87
6342808	VSM490D100Z08S3175XN15JIS	100	31,76	60	50	15,0	8	10900	Yes	1,23
6342809	VSM490D125Z09S381XN15JIS	125	38,10	80	63	15,0	9	9600	Yes	2,81
6342810	VSM490D160Z12S508XN15JIS	160	50,80	100	63	15,0	12	8400	Yes	4,88

VSM490-15 • XNGU-ALP • For Aluminum and Other Non-Ferrous Alloys

INDEXABLE MILLING

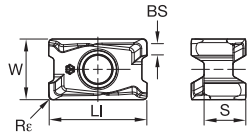

- first choice
- alternate choice

P	■	■	■	●	●	●	●	●
M	■	■	■	●	●	●	●	●
K	■	■	■	○	○	○	○	○
N	■	■	■	○	○	○	○	○
S	■	■	■	○	○	○	○	○
H	■	■	■	○	○	○	○	○

SOLID END MILLING

ISO catalogue number	cutting edges	LI	S	W	BS	Re	hm	WK15CM	WK15PM	WN25PM	WP25PM	WP35CM	WP40PM	WS40PM	WU35PM
XNGU15T604ERALP	4	16,20	6,88	10,00	2,20	0,40	0,03	●	●	●	●	●	●	●	●
XNGU15T608ERALP	4	16,20	6,88	10,00	1,80	0,80	0,03	○	○	○	○	○	○	○	○

HOLEMAKING

VSM490-15 • XNGU-ML • Precision Finishing and Light Machining

TAPPING

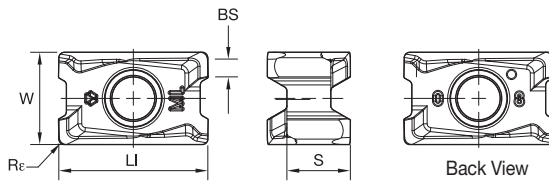
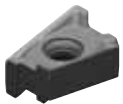

- first choice
- alternate choice

P	■	■	■	●	●	●	●	●
M	■	■	■	●	●	●	●	●
K	■	■	■	○	○	○	○	○
N	■	■	■	○	○	○	○	○
S	■	■	■	○	○	○	○	○
H	■	■	■	○	○	○	○	○

TURNING

ISO catalogue number	cutting edges	LI	S	W	BS	Re	hm	WK15CM	WK15PM	WN25PM	WP25PM	WP35CM	WP40PM	WS40PM	WU35PM
XNGU15T604ERML	4	16,20	6,88	10,00	2,20	0,40	0,08	○	○	○	○	○	○	○	○
XNGU15T608ERML	4	16,20	6,88	10,00	1,80	0,80	0,08	○	○	○	○	○	○	○	○

VSM490-15 • XNGU-MM • Universal Geometry for Medium Machining

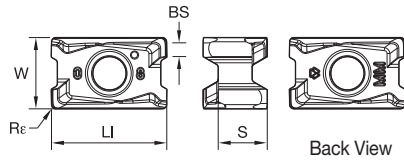

- first choice
- alternate choice

P	■	■	■	■	■	■	■	■	■	■
M	■	■	■	■	■	■	■	■	■	■
K	■	■	■	○	○	○	○	○	○	○
N	■	■	■	■	■	■	■	■	■	■
S	■	■	■	○	○	○	○	○	○	○
H	■	■	■	■	■	■	■	■	■	■

ISO catalogue number	cutting edges	LI	S	W	BS	Re	hm	WK15CM	WK15PM	WN25PM	WP25PM	WP35CM	WP40PM	WS40PM	WU35PM
XNGU15T604SRMM	4	16,20	6,88	10,00	2,20	0,40	0,10	■	■	■	■	■	■	■	■
XNGU15T608SRMM	4	16,20	6,88	10,00	1,90	0,80	0,10	■	■	■	■	■	■	■	■
XNGU15T612SRMM	4	16,20	6,88	10,00	1,50	1,20	0,08	■	■	■	■	■	■	■	■

VSM490-15 • XNGU-MH • Heavy Roughing

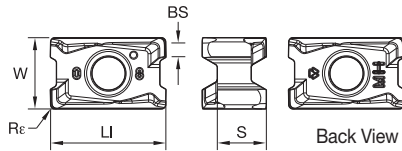

- first choice
- alternate choice

P	■	■	■	■	■	■	■	■	■	■
M	■	■	■	■	■	■	■	■	■	■
K	■	■	■	○	○	○	○	○	○	○
N	■	■	■	■	■	■	■	■	■	■
S	■	■	■	○	○	○	○	○	○	○
H	■	■	■	■	■	■	■	■	■	■

ISO catalogue number	cutting edges	LI	S	W	BS	Re	hm	WK15CM	WK15PM	WN25PM	WP25PM	WP35CM	WP40PM	WS40PM	WU35PM
XNGU15T608SRMH	4	16,20	6,88	10,00	1,80	0,80	0,10	■	■	■	■	■	■	■	■
XNGU15T616SRMH	4	16,20	6,88	10,00	1,00	1,60	0,10	■	■	■	■	■	■	■	■

INDEXABLE MILLING

VSM490-15 • XNPU-ML • Light Machining

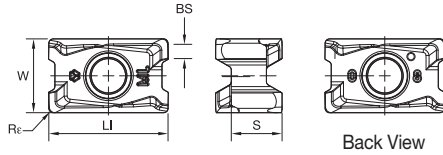

- first choice
- alternate choice

P	●	●	●	●	●	●	●	●
M	●	●	●	●	●	●	●	●
K	●	●	○	○	○	○	○	○
N	●	●	○	○	○	○	○	○
S	○	○	○	○	○	○	○	○
H	○	○	○	○	○	○	○	○

ISO catalogue number	cutting edges	LI	S	W	BS	Re	hm	WK15CM	WK15PM	WN25PM	WP25PM	WP35CM	WP40PM	WS40PM	WU35PM
XNPU15T608ERML	4	16,10	6,88	10,00	1,90	0,80	0,08	●	●	●	○	○	○	○	○

SOLID END MILLING

HOLEMAKING

VSM490-15 • XNPU-MM • Universal Geometry for Medium Machining

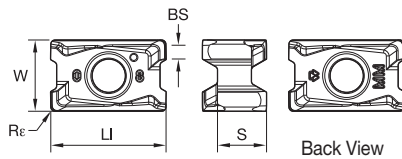

- first choice
- alternate choice

P	●	●	●	●	●	●	●	●
M	●	●	●	●	●	●	●	●
K	●	●	○	○	○	○	○	○
N	●	●	○	○	○	○	○	○
S	○	○	○	○	○	○	○	○
H	○	○	○	○	○	○	○	○

ISO catalogue number	cutting edges	LI	S	W	BS	Re	hm	WK15CM	WK15PM	WN25PM	WP25PM	WP35CM	WP40PM	WS40PM	WU35PM
XNPU15T608SRMM	4	16,10	6,88	10,00	1,90	0,80	0,10	●	●	●	○	○	○	○	○
XNPU15T612SRMM	4	16,10	6,88	10,00	1,50	1,20	0,10	●	●	●	○	○	○	○	○
XNPU15T616SRMM	4	16,10	6,88	10,00	1,10	1,60	0,10	●	●	●	○	○	○	○	○
XNPU15T620SRMM	4	16,10	6,88	10,00	0,70	2,00	0,10	●	●	●	○	○	○	○	○

TAPPING

TURNING

VSM490-15 • Insert Selection Guide

Material Group	Light Machining		General Purpose		Heavy Machining	
	Geometry	Grade	Geometry	Grade	Geometry	Grade
P1-P2	XNGU-ML	WP40PM	XNPU-MM	WP40PM	XNPU-MM	WP40PM
P3-P4	XNGU-ML	WP40PM	XNPU-MM	WP40PM	XNPU-MM	WP40PM
P5-P6	XNGU-MM	WP25PM	XNPU-MM	WP35CM	XNPU-MM	WP40PM
M1-M2	XNGU-ML	WS40PM	XNGU-ML	WS40PM	XNPU-MM	WS40PM
M3	XNGU-ML	WS40PM	XNGU-ML	WS40PM	XNPU-MM	WS40PM
K1-K2	XNPU-MM	WK15PM	XNGU-MH	WK15CM	XNGU-MH	WK15CM
K3	XNPU-MM	WK15PM	XNGU-MH	WP35CM	XNGU-MH	WP35CM
N1-N2	XNGU-ALP	WN25PM	XNGU-ALP	WN25PM	XNGU-ALP	WN25PM
N3	XNGU-ALP	WN25PM	XNGU-ALP	WN25PM	XNGU-ALP	WN25PM
S1-S2	XNGU-ML	WP25PM	XNGU-ML	WS40PM	XNPU-MM	WS40PM
S3	XNGU-ML	WS40PM	XNGU-ML	WS40PM	XNPU-MM	WS40PM
S4	XNGU-ML	WS40PM	XNGU-ML	WS40PM	XNPU-MM	WS40PM
H1	-	-	-	-	-	-

VSM490-15 • Recommended Starting Speeds [m/min]

Material Group		WK15CM	WK15PM	WN25PM	WP25PM	WP35CM	WP40PM	WS40PM	WU35PM
P	1	-	-	-	330 285 270	455 395 370	295 260 245	-	260 230 215
	2	-	-	-	275 240 200	280 255 230	250 215 180	-	220 190 160
	3	-	-	-	255 215 175	255 230 205	230 195 160	-	200 170 140
	4	-	-	-	225 185 150	190 175 160	205 170 135	-	180 150 120
	5	-	-	-	185 170 150	260 230 210	170 155 135	170 145 120	150 135 120
	6	-	-	-	165 125 100	160 135 110	150 115 90	150 110 80	130 100 80
M	1	-	-	-	205 180 165	205 185 155	195 170 155	210 170 140	170 150 135
	2	-	-	-	185 160 130	185 160 140	175 150 125	180 145 120	155 130 110
	3	-	-	-	140 120 95	145 130 115	130 115 90	145 110 85	115 100 80
K	1	420 385 340	270 245 215	-	230 205 185	295 265 240	-	-	-
	2	335 295 275	210 190 175	-	180 160 150	235 210 190	-	-	-
	3	280 250 230	175 160 145	-	150 135 120	195 175 160	-	-	-
N	1	-	-	1075 945 875	-	-	-	-	-
	2	-	-	945 875 760	-	-	-	-	-
	3	-	-	945 875 760	-	-	-	-	-
S	1	-	-	-	40 35 25	-	-	40 35 25	35 30 25
	2	-	-	-	40 35 25	-	-	40 35 25	35 30 25
	3	-	-	-	50 40 25	-	-	50 40 25	45 35 25
	4	-	-	-	70 50 35	-	-	60 50 30	60 45 30
H	1	-	-	-	-	-	-	-	-

NOTE: FIRST choice starting speeds are in **bold** type. As the average chip thickness increases, the speed should be decreased.
 *Material groups P, M, K, and H show recommended starting speeds for dry machining. For wet machining, reduce speed by 20%.
 *Material groups N and S show recommended starting speeds for wet machining. Not recommended for dry machining.

VSM490-15 • Recommended Starting Feeds [mm]

Light Machining	General Purpose	Heavy Machining
-----------------	-----------------	-----------------

Insert Geometry	Programmed Feed per Tooth (fz) as a % of Radial Depth of Cut (ae)															Insert Geometry
	5%			10%			20%			30%			40-100%			
.E..ALP	0,11	0,23	0,35	0,08	0,17	0,25	0,06	0,13	0,19	0,05	0,11	0,16	0,05	0,10	0,15	.E..ALP
.E..ML	0,17	0,31	0,46	0,13	0,23	0,33	0,09	0,17	0,25	0,08	0,15	0,22	0,08	0,14	0,20	.E..ML
.S..MM	0,22	0,40	0,64	0,16	0,29	0,46	0,12	0,22	0,34	0,10	0,19	0,30	0,10	0,18	0,28	.S..MM
.S..MH	0,23	0,45	0,74	0,17	0,33	0,54	0,13	0,24	0,40	0,11	0,21	0,35	0,10	0,20	0,32	.S..MH

NOTE: Use "Light Machining" value as starting feed rate.

Use VSM890 shoulder mills to perform a true 90-degree wall and axial step down in light machining to heavy roughing jobs while maintaining a smooth surface finish in all material groups.



UNIQUE INSERT RAKE DESIGN TO REDUCE AND PERFECTLY BALANCE AXIAL AND RADIAL CUTTING FORCES. ENGINEERED FOR LIGHT MACHINING TO HEAVY ROUGHING IN ALL MATERIAL GROUPS.

-ALP

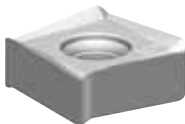

N

First choice for non-ferrous materials.

-ML

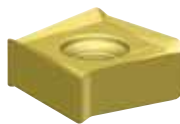

P M S

First choice for stainless steel, light machining, and finishing jobs.

-MM

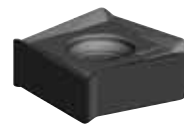

P M K S H

First choice for general purpose in all workpiece materials. Engineered for high-feed rates.

Finishing Capabilities/Lower Cutting Forces

Geometry Strengthening

TRUE 90-DEGREE WALL AND AXIAL STEP DOWN WITH VSM890™

PRODUCT

SERIES

VSM890

DIAMETER RANGE

Weldon End Mills: 32mm
Shell Mills: 40–250mm

SHANK TYPES

Weldon® End Mills
Shell Mills

INDUSTRY



APPLICATIONS



FACE MILLING



SIDE/
SHOULDER
MILLING:
SLOTting:
SHOULDER



SLOTting:
TROCHOIDAL
MILLING



PLUNGE
MILLING



SLOTting:
SQUARE END



POCKET
MILLING

VERSATILITY

Apply VSM890 in a variety of applications.

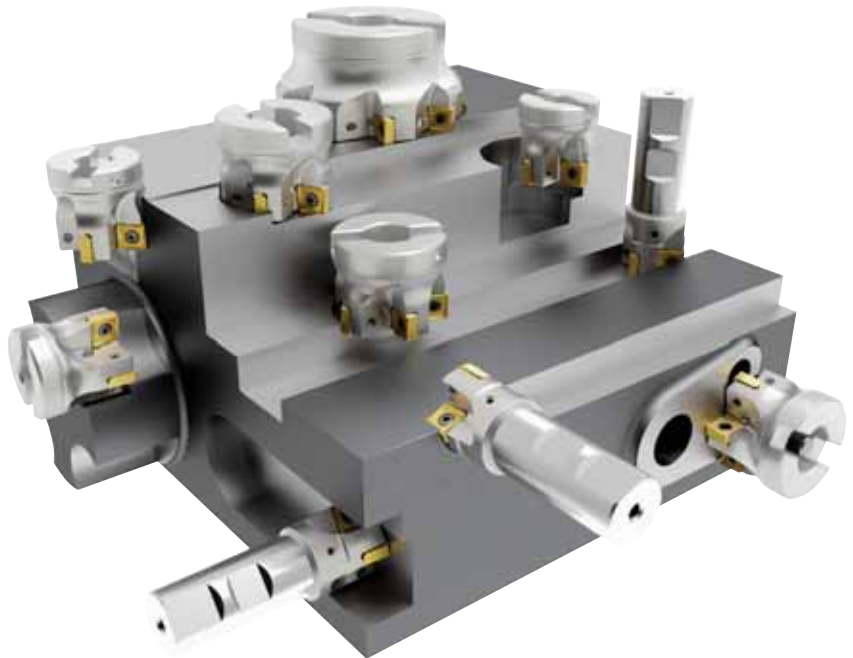

VSM890-12 • Weldon® End Mills • Metric

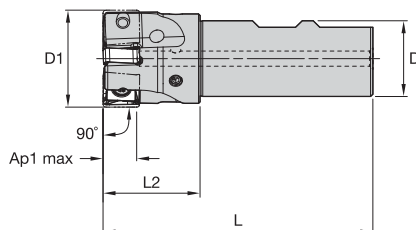
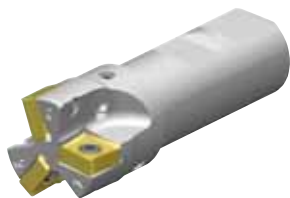

order number	catalogue number	D1	D	L	L2	Ap1 max	Z	max RPM	coolant supply	kg
6596066	VSM890D032Z03B25SN12	32	25	89	32	9,8	3	33200	Yes	0,31

VSM890-12 • Shell Mills • Metric

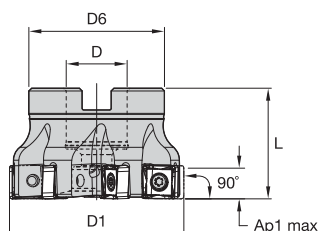

order number	catalogue number	D1	D	D6	L	Ap1 max	Z	max RPM	coolant supply	kg
6596067	VSM890D040Z04S22SN12	40	22	39	40	9,8	4	28000	Yes	0,20
6596068	VSM890D050Z04S22SN12	50	22	49	40	9,8	4	24100	Yes	0,32
6596069	VSM890D050Z05S22SN12	50	22	49	40	9,8	5	24100	Yes	0,32
6596070	VSM890D063Z05S22SN12	63	22	49	40	9,8	5	20800	Yes	0,48
6596111	VSM890D063Z07S22SN12	63	22	49	40	9,8	7	20800	Yes	0,45
6596112	VSM890D080Z05S27SN12	80	27	60	50	9,8	5	18000	Yes	0,96
6596113	VSM890D080Z07S27SN12	80	27	60	50	9,8	7	18000	Yes	1,03
6596114	VSM890D080Z09S27SN12	80	27	60	50	9,8	9	18000	Yes	1,01
6596115	VSM890D100Z06S32SN12	100	32	78	50	9,8	6	15800	Yes	1,69
6596116	VSM890D100Z08S32SN12	100	32	78	50	9,8	8	15800	Yes	1,56
6596117	VSM890D100Z11S32SN12	100	32	78	50	9,8	11	15800	Yes	1,53
6596118	VSM890D125Z07S40SN12	125	40	89	63	9,8	7	13900	Yes	2,79
6596119	VSM890D125Z10S40SN12	125	40	89	63	9,8	10	13900	Yes	2,98
6596121	VSM890D125Z14S40SN12	125	40	89	63	9,8	14	13900	Yes	2,86
6596122	VSM890D160Z08S40SN12	160	40	110	63	9,8	8	12200	Yes	4,10
6596123	VSM890D160Z12S40SN12	160	40	110	63	9,8	12	12200	Yes	4,15
6596124	VSM890D160Z16S40SN12	160	40	110	63	9,8	16	12200	Yes	8,97
6596125	VSM890D200Z10S60SN12	200	60	130	63	9,8	10	10800	Yes	5,62
6596126	VSM890D200Z14S60SN12	200	60	130	63	9,8	14	10800	Yes	5,59
6596127	VSM890D200Z22S60SN12	200	60	130	63	9,8	22	10800	Yes	5,67
6596128	VSM890D250Z16S60SN12	250	60	130	63	9,8	16	9600	Yes	8,10

FOR SPARE PARTS, PLEASE VISIT WIDIA.COM OR WIDIANOVO.COM.
MOUNTING SCREWS ARE NOT INCLUDED IN STANDARD PACKAGING.

VSM890-12 • SNHX-ALP • For Aluminum and Other Non-Ferrous Alloys

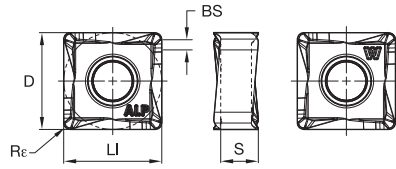

- first choice
- alternate choice

P	■	■	■	●	●	●	●
M	■	■	■	●	●	●	●
K	■	■	■	○	○	○	○
N	■	■	■	○	○	○	○
S	■	■	■	○	○	○	○
H	■	■	■	○	○	○	○

ISO catalogue number	cutting edges	LI	S	D	BS	Rε	WK15CM	WN25PM	WP25PM	WP35CM	WP40PM	WS40PM	WU10PM
SNHX120408PNERALP	8	12,00	4,61	12,00	1,34	0,80	■	■	■	■	■	■	■

VSM890-12 • SNHX-ML • Precision Finishing and Light Machining

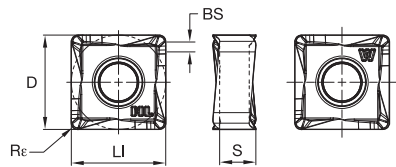
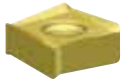

- first choice
- alternate choice

P	■	■	■	●	●	●	●
M	■	■	■	●	●	●	●
K	■	■	■	○	○	○	○
N	■	■	■	○	○	○	○
S	■	■	■	○	○	○	○
H	■	■	■	○	○	○	○

ISO catalogue number	cutting edges	LI	S	D	BS	Rε	WK15CM	WN25PM	WP25PM	WP35CM	WP40PM	WS40PM	WU10PM
SNHX120408PNERML	8	12,00	4,61	12,00	1,34	0,80	■	■	■	■	■	■	■

VSM890-12 • SNHX-MM • Universal Geometry for Medium Machining

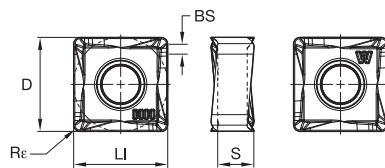
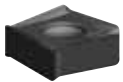

- first choice
- alternate choice

P	■	■	■	●	●	●	●
M	■	■	■	●	●	●	●
K	■	■	■	○	○	○	○
N	■	■	■	○	○	○	○
S	■	■	■	○	○	○	○
H	■	■	■	○	○	○	○

ISO catalogue number	cutting edges	LI	S	D	BS	Rε	WK15CM	WN25PM	WP25PM	WP35CM	WP40PM	WS40PM	WU10PM
SNHX120408PNSRMM	8	12,00	4,61	12,00	1,34	0,80	■	■	■	■	■	■	■
SNHX120416PNSRMM	8	12,00	4,58	12,00	1,00	1,60	■	■	■	■	■	■	■

VSM890-12 • Insert Selection Guide

Material Group	Light Machining		General Purpose		Heavy Machining	
	Geometry	Grade	Geometry	Grade	Geometry	Grade
P1-P2	SNHX-ML	WS40PM	SNHX-MM	WP40PM	SNHX-MM	WP40PM
P3-P4	SNHX-ML	WS40PM	SNHX-MM	WP40PM	SNHX-MM	WP40PM
P5-P6	SNHX-ML	WP25PM	SNHX-MM	WP40PM	SNHX-MM	WP40PM
M1-M2	SNHX-ML	WS40PM	SNHX-ML	WS40PM	SNHX-MM	WS40PM
M3	SNHX-ML	WS40PM	SNHX-ML	WS40PM	SNHX-MM	WS40PM
K1-K2	SNHX-MM	WK15CM	SNHX-MM	WK15CM	SNHX-MM	WK15CM
K3	SNHX-MM	WK15CM	SNHX-MM	WK15CM	SNHX-MM	WK15CM
N1-N2	SNHX-ALP	WN25PM	SNHX-ALP	WN25PM	SNHX-ALP	WN25PM
N3	SNHX-ALP	WN25PM	SNHX-ALP	WN25PM	SNHX-ALP	WN25PM
S1-S2	SNHX-ML	WP25PM	SNHX-ML	WS40PM	SNHX-MM	WS40PM
S3	SNHX-ML	WS40PM	SNHX-ML	WS40PM	SNHX-MM	WS40PM
S4	SNHX-ML	WS40PM	SNHX-ML	WS40PM	SNHX-MM	WS40PM
H1	SNHX-MM	WU10PM	SNHX-MM	WU10PM	-	-

VSM890-12 • Recommended Starting Speeds [m/min]

Material Group		WK15CM	WN25PM	WP25PM	WP35CM	WP40PM	WS40PM	WU10PM
P	1	-	-	330 285 270	455 395 370	295 260 245	-	-
	2	-	-	275 240 200	280 255 230	250 215 180	-	-
	3	-	-	255 215 175	255 230 205	230 195 160	-	-
	4	-	-	225 185 150	190 175 160	205 170 135	-	-
	5	-	-	185 170 150	260 230 210	170 155 135	170 145 120	-
	6	-	-	165 125 100	160 135 110	150 115 90	150 110 80	-
M	1	-	-	205 180 165	205 185 155	195 170 155	210 170 140	-
	2	-	-	185 160 130	185 160 140	175 150 125	180 145 120	-
	3	-	-	140 120 95	145 130 115	130 115 90	145 110 85	-
K	1	420 385 340	-	230 205 185	295 265 240	-	-	295 265 240
	2	335 295 275	-	180 160 150	235 210 190	-	-	230 205 190
	3	280 250 230	-	150 135 120	195 175 160	-	-	195 175 160
N	1	-	1075 945 875	-	-	-	-	-
	2	-	945 875 760	-	-	-	-	-
	3	-	945 875 760	-	-	-	-	-
S	1	-	-	40 35 25	-	-	40 35 25	-
	2	-	-	40 35 25	-	-	40 35 25	-
	3	-	-	50 40 25	-	-	50 40 25	-
	4	-	-	70 50 35	-	-	60 50 30	-
H	1	-	-	-	-	-	-	160 130 90

NOTE: FIRST choice starting speeds are in bold type. As the average chip thickness increases, the speed should be decreased.
 *Material groups P, M, K, and H show recommended starting speeds for dry machining. For wet machining, reduce speed by 20%.
 *Material groups N and S show recommended starting speeds for wet machining. Not recommended for dry machining.

VSM890-12 • Recommended Starting Feeds [mm]

Light Machining	General Purpose	Heavy Machining
-----------------	-----------------	-----------------

Insert Geometry	Programmed Feed per Tooth (fz) as a % of Radial Depth of Cut (ae)															Insert Geometry
	5%			10%			20%			30%			40-100%			
.E..ALP	0,12	0,28	0,43	0,08	0,20	0,31	0,06	0,15	0,23	0,06	0,13	0,20	0,05	0,12	0,18	.E..ALP
.E..ML	0,17	0,32	0,60	0,13	0,23	0,44	0,09	0,18	0,33	0,08	0,15	0,28	0,08	0,14	0,26	.E..ML
.S..MM	0,23	0,36	0,82	0,17	0,26	0,59	0,13	0,20	0,44	0,11	0,17	0,38	0,10	0,16	0,35	.S..MM

NOTE: Use "Light Machining" value as starting feed rate.

VSM890-12 Z-Axis Plunge Milling

cutting diameter (D1)	Y max	X
32	8,9	28,68
40	8,9	33,27
50	8,9	38,25
63	8,9	43,89
80	8,9	50,31
100	8,9	56,95
125	8,9	64,29
160	8,9	73,34
200	8,9	82,48
250	8,9	92,65

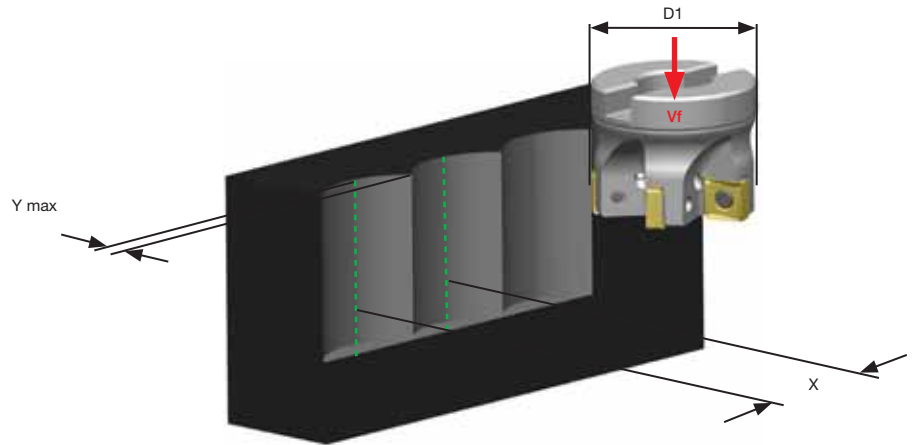

VSM890-12 Ap1 max at Full Slotting, 100% Radial Cutter Engagement

D1 diameter	Recommended Cutter Density Z	Ap1 max		
		Gray Cast Iron EN-GJL-250 EN-JL1040 GG25	Steel AISI 4140 1.7225 42CrMo4	Stainless Steel AISI 316L, 1.4404, X2CrNiMo1810
40	4	8,0	6,5	5,0
50	4	8,0	6,5	5,0
63	5	8,0	6,5	5,0
80	5	8,0	6,5	5,0
100	6	8,0	6,5	5,0

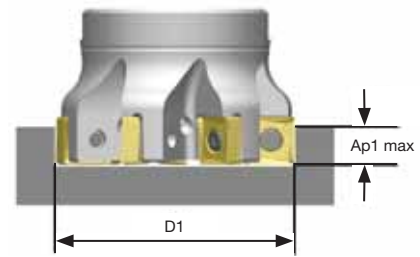

INDEXABLE MILLING

SOLID END MILLING

HOLEMAKING

TAPPING

TURNING

M680 Series

M680-09, M680-16, and M680+ Shoulder Mills



M680-09

The M680-09 shoulder mill provides the length needed to machine deep cavities or wall machines. The axially positive geometry makes this tool suitable for machining in unstable conditions.



M680-16

The M680-16 is a versatile 90° shoulder mill with optimized strong tool design for challenging milling operations. A wide selection of inserts are available to machine all material types.



M680+

The M680+ is a general purpose shoulder mill that features strong inserts for high reliability in roughing applications and interrupted cuts.

M680 TO M680-16



AL

Additional choice for aluminum and non-ferrous alloy machining.



XP.16..

First choice for general machining operations in steel and cast iron.

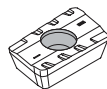

MR

First choice for heavy machining and unstable conditions (e.g., long reach).

M680-09



-XDHT

Versatile choice for general machining operations in steel, stainless steel, cast iron, non-ferrous, high-temp alloys, and hardened materials.









-MM

First choice for general machining in steel and cast iron.

WIDE RANGE OF INSERTS FOR OPTIMAL PERFORMANCE

PRODUCT		INSERTS		
SERIES	DIAMETER RANGE	INSERT TYPE	GRADE	MATERIALS
M680-09	.625–1.25" (16–32mm)	XDHT, MM	WK15PM, WU20PM	P M K N S H
M680-16	1–2" (16–160mm)	ALP, AL, GE, XP.16, MR	THR, THM-U, TN6501, TN6502, TN6510, TN6520, TN6525, TN6540, TTM08, WK15PM, WP35CM, WU20PM, TTI25, THM, WK15CM, WP40PM, WS30PM	P M K N S H
M680+	25–40mm (only available in metric sizes)	ML, MM, MH	THM, TN6510, TN6520, TN6540, WK15CM, WP35CM	P M K N S

APPLICATIONS

							
SIDE MILLING/ SHOULDER MILLING: SQUARE END	SLOTTING: SQUARE END	FACE MILLING	THROUGH COOLANT: RADIAL: INDEXABLE MILLING	SLOTTING: SIDE MILLING	PLUNGE MILLING	POCKETING	RAMPING: BLANK

INDUSTRY



M680-09 • Cylindrical End Mills • XD09 • Metric

INDEXABLE MILLING



SOLID END MILLING



HOLEMAKING

TAPPING

TURNING

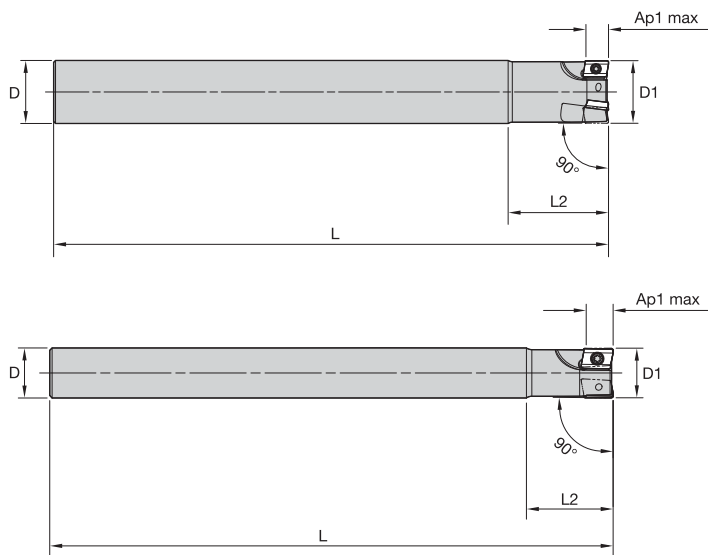

order number	catalogue number	D1	D	L	L2	Ap1 max	Z	max RPM	coolant supply	kg
2582447	M680D016Z02A16XD09L180	16	16	180	26	9,0	2	22000	No	0,27
2582446	M680D020Z02A20XD09L200	20	20	200	31	9,0	2	19700	No	0,47
2582445	M680D025Z03A25XD09L220	25	25	220	37	9,0	3	17630	No	0,80
2582441	M680D032Z04A32XD09L250	32	32	250	38	9,0	4	15580	No	1,51

NOTE: Please order wrench separately.

FOR SPARE PARTS, PLEASE VISIT WIDIA.COM OR WIDIANOVO.COM.

MOUNTING SCREWS ARE NOT INCLUDED IN STANDARD PACKAGING.

M680-09 • Recommended Starting Feeds [mm]

Material Group		THR	THM-U	TN6501	TN6502	TN6510	TN6520	TN6525	TN6540
P	0	- - -	- - -	- - -	- - -	- - -	- - -	340 265 235	300 235 200
	1	- - -	- - -	- - -	- - -	- - -	- - -	340 265 235	300 235 200
	2	- - -	- - -	- - -	- - -	- - -	- - -	265 210 180	210 160 140
	3	- - -	- - -	- - -	- - -	- - -	- - -	235 180 155	180 140 115
	4	- - -	- - -	- - -	- - -	- - -	- - -	195 140 120	150 110 90
	5	- - -	- - -	- - -	- - -	- - -	- - -	260 195 165	200 150 125
M	1	- - -	- - -	- - -	- - -	- - -	- - -	160 100 65	110 65 50
	2	- - -	- - -	- - -	- - -	- - -	- - -	100 65 40	65 40 35
	3	- - -	- - -	- - -	- - -	- - -	- - -	105 65 45	70 40 35
K	1	150 135 120	190 170 150	- - -	- - -	400 290 215	375 265 190	230 205 185	185 170 150
	2	185 140 120	- - -	- - -	- - -	350 235 170	325 210 160	180 160 150	145 130 115
	3	105 75 50	- - -	- - -	- - -	280 215 165	250 190 135	150 135 120	130 120 105
N	1	900 600 500	2000 1200 1000	2000 1200 1000	1075 945 875	- - -	- - -	- - -	- - -
	2	685 465 385	1365 815 665	1365 815 665	1075 945 875	- - -	- - -	- - -	- - -
	3	450 280 200	800 500 400	800 500 400	945 875 760	- - -	- - -	- - -	- - -
S	1	35 25 20	- - -	- - -	- - -	- - -	- - -	- - -	40 30 25
	2	25 20 15	- - -	- - -	- - -	- - -	- - -	- - -	20 15 10
	3	50 40 30	- - -	- - -	- - -	- - -	- - -	- - -	60 35 25
	4	35 25 18	- - -	- - -	- - -	- - -	- - -	- - -	50 25 20
H	1	- - -	- - -	- - -	- - -	- - -	- - -	- - -	- - -
	2	- - -	- - -	- - -	- - -	- - -	- - -	- - -	- - -
	3	- - -	- - -	- - -	- - -	- - -	- - -	- - -	- - -

Material Group		TTM08	WK15PM	WP35CM	WU20PM	TTI25	THM	WK15CM	WP40PM	WS30PM
P	0	- - -	- - -	- - -	- - -	360 300 250	- - -	- - -	295 260 245	- - -
	1	230 200 190	- - -	455 395 370	330 290 270	360 300 250	- - -	- - -	295 260 245	- - -
	2	195 170 140	- - -	280 255 230	275 250 200	260 210 180	- - -	- - -	250 215 180	- - -
	3	180 150 125	- - -	255 230 205	255 220 175	260 210 180	- - -	- - -	230 195 160	- - -
	4	160 130 105	- - -	190 175 160	225 190 150	220 180 150	- - -	- - -	205 170 135	- - -
	5	- - -	- - -	260 230 210	185 175 150	265 195 165	- - -	- - -	170 155 135	- - -
M	1	- - -	- - -	205 185 155	205 180 165	400 260 180	- - -	- - -	195 170 155	225 200 185
	2	- - -	- - -	185 160 140	185 160 130	270 170 120	- - -	- - -	175 150 125	205 180 145
	3	- - -	- - -	145 130 115	140 120 95	265 175 120	- - -	- - -	130 115 90	155 135 105
K	1	- - -	400 290 215	295 265 240	250 220 185	185 155 130	- - -	420 385 340	- - -	- - -
	2	- - -	350 235 170	235 210 190	200 180 150	150 120 105	- - -	335 295 275	- - -	- - -
	3	- - -	280 215 165	195 175 160	180 150 120	120 105 85	- - -	280 250 230	- - -	- - -
N	1	- - -	- - -	- - -	550 470 400	- - -	795 695 600	- - -	- - -	- - -
	2	- - -	- - -	- - -	550 470 400	- - -	795 695 600	- - -	- - -	- - -
	3	- - -	- - -	- - -	400 350 300	- - -	560 485 420	- - -	- - -	- - -
S	1	- - -	- - -	- - -	40 35 25	- - -	- - -	- - -	40 35 30	45 40 30
	2	- - -	- - -	- - -	40 35 25	- - -	- - -	- - -	40 35 30	45 40 30
	3	- - -	- - -	- - -	50 40 25	- - -	- - -	- - -	50 40 30	55 45 30
	4	- - -	- - -	66 50 33	70 50 35	- - -	- - -	- - -	65 50 35	85 60 40
H	1	- - -	- - -	- - -	110 80 70	- - -	- - -	- - -	- - -	- - -
	2	- - -	- - -	- - -	- - -	- - -	- - -	- - -	- - -	- - -
	3	- - -	- - -	- - -	- - -	- - -	- - -	- - -	- - -	- - -

NOTE: FIRST choice starting speeds are in **bold** type.
As the average chip thickness increases, the speed should be decreased.

M680-09 • Recommended Starting Speeds [m/min]

Insert Geometry	Programmed Feed per Tooth (fz) as a % of Radial Depth of Cut (ae)															Insert Geometry
	5%			10%			20%			30%			40-100%			
..XDHT..	0,15	0,43	0,65	0,11	0,30	0,46	0,08	0,23	0,34	0,07	0,20	0,30	0,06	0,18	0,27	..XDHT..
..SRMM	0,16	0,48	0,73	0,12	0,34	0,51	0,09	0,25	0,38	0,08	0,22	0,33	0,07	0,20	0,30	..SRMM

NOTE: Use "Light Machining" value as starting feed rate.

M680-16 • Screw-On End Mills • Metric

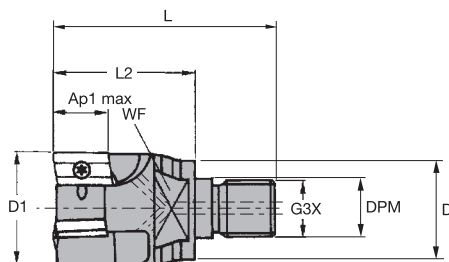

Insert Style XP.T16

order number	catalogue number	D1	D	DPM	G3X	L	L2	WF	Ap1 max	Z	max RPM	coolant supply	kg
2003477	12396932600	25	24	12,5	M12	52	30	19	14,0	2	8800	Yes	0,2
2003517	12396933000	32	28	17,0	M16	63	40	22	14,0	3	7800	Yes	0,3
2003521	12396933200	35	28	17,0	M16	63	40	22	14,0	3	7200	Yes	0,3
2003540	12396933400	40	28	17,0	M16	63	40	22	14,0	4	7000	Yes	0,3

NOTE: Standard milling cutters will accept insert nose radii up to 2mm without modification.

M680-16 • Weldon® End Mills • Metric

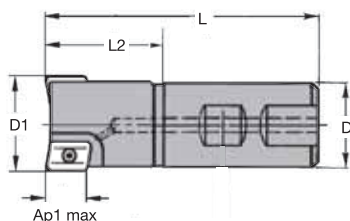

Insert Style XP.T16

order number	catalogue number	D1	D	L	L2	Ap1 max	Z	max RPM	coolant supply	kg
2003475	12396922600	25	25	96	39	14,0	2	17600	Yes	0,3
2003515	12396923000	32	32	100	39	15,4	3	15600	Yes	0,5
2003539	12396923400	40	32	110	50	14,0	4	14000	Yes	0,8

NOTE: Standard milling cutters will accept insert nose radii up to 2mm without modification.

M680-16 • Weldon End Mills • Metric

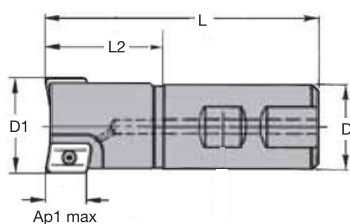

Insert Style XD.T09

order number	catalogue number	D1	D	L	L2	Ap1 max	Z	max RPM	coolant supply	kg
2002366	12396920400	16	16	75	27	9,0	2	28000	No	0,10
2002369	12396920600	20	20	82	32	9,0	2	27000	Yes	0,30

FOR SPARE PARTS, PLEASE VISIT WIDIA.COM OR WIDIANOVO.COM.

MOUNTING SCREWS ARE NOT INCLUDED IN STANDARD PACKAGING.

M680-16 • Shell Mills • Metric



Insert Style XP.T16

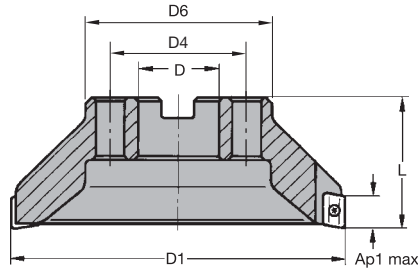

order number	catalogue number	D1	D	D4	D6	L	Ap1 max	Z	max RPM	coolant supply	kg
2003535	12396903600	40	22	—	39	45	15,3	4	14000	Yes	0,2
2003553	12396903800	50	22	—	42	40	14,0	4	12500	Yes	0,3
2003554	12396904000	50	22	—	42	40	14,0	5	12500	Yes	0,3
2003561	12396904200	63	22	—	50	40	14,0	5	11000	Yes	0,5
2003578	12396904600	80	27	—	60	50	14,0	6	9500	Yes	1,0
2003594	12396905000	100	32	—	78	50	14,0	8	8500	No	1,4
2003681	12396905400	125	40	—	89	63	14,0	9	7500	No	2,6
2003782	12396905800	160	40	66,7	90	63	14,0	12	7000	No	3,4

NOTE: Standard milling cutters will accept insert nose radii up to 2mm without modification.

INDEXABLE MILLING

SOLID END MILLING

HOLEMAKING

TAPPING

TURNING

90° Shoulder Mills • M680 Series

INDEXABLE MILLING

M680-16 • XPHT-AL

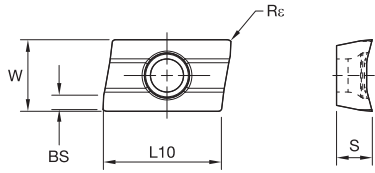

● first choice
○ alternate choice

P	■											●	●	●	●			●	●	○	○
M	■											○	○	○	○			○	○	○	○
K	■	○	○	○	○	○	○	○	○	○	○	○	○	○	○	○	○	○	○	○	○
N	■	○	○	○	○	○	○	○	○	○	○	○	○	○	○	○	○	○	○	○	○
S	■																			○	○
H	■																			○	○

SOLID END MILLING

ISO catalogue number	cutting edges	W	L10	S	BS	Rc	hm	THM	THM-U	THR	TN6501	TN6502	TN6510	TN6520	TN6525	TN6540	TTI25	TTM08	WK15CM	WK15PM	WP35CM	WP40PM	WS30PM	WU20PM	
XPHT160408AL	2	9,80	15,67	4,66	1,70	0,80	0,08	2031796	2031798	2963902															
XPHT160412AL	2	9,80	15,67	4,66	1,40	1,20	0,08	2031798																	
XPHT160416AL	2	9,80	15,67	4,66	0,90	1,60	0,08	2031801																	
XPHT160420AL	2	9,80	15,67	4,66	1,20	2,00	0,08	2031802																	
XPHT160425AL	2	9,80	15,67	4,66	1,20	2,50	0,08	2029067																	
XPHT160432AL	2	9,80	15,67	4,66	1,20	3,18	0,08	2031804																	
XPHT160440AL	2	9,80	15,67	4,66	1,20	4,00	0,08	2029073																	

HOLEMAKING

TAPPING

M680-16 • XPHT-ALP

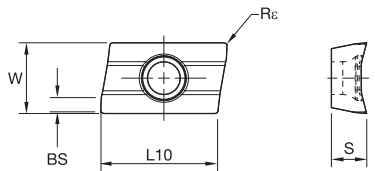
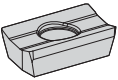

● first choice
○ alternate choice

P	■																					●	●	○	○
M	■																					○	○	○	○
K	■	○	○	○	○	○	○	○	○	○	○	○	○	○	○	○	○	○	○	○	○	○	○	○	○
N	■	○	○	○	○	○	○	○	○	○	○	○	○	○	○	○	○	○	○	○	○	○	○	○	○
S	■																					○	○	○	○
H	■																					○	○	○	○

TURNING

ISO catalogue number	cutting edges	W	L10	S	BS	Rc	hm	THM	THM-U	THR	TN6501	TN6502	TN6510	TN6520	TN6525	TN6540	TTI25	TTM08	WK15CM	WK15PM	WP35CM	WP40PM	WS30PM	WU20PM	
XPHT160404ALP	2	9,80	15,67	4,66	1,70	0,40	0,08	2031794	2031794																
XPHT160408ALP	2	9,80	15,67	4,66	1,70	0,80	0,08	2031797	2964136																
XPHT160412ALP	2	9,80	15,67	4,66	1,40	1,20	0,08	2031799																	

M680-16 • XPHT-GE

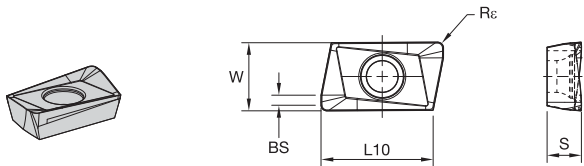

- first choice
- alternate choice

P	●								●	●	●	●				●	●	○	●
M	○								○										○
K	○	●							○	○						○	○		○
N	○	○	○								○								○
S	○	○	○	○															○
H	○	○	○	○							○								○

ISO catalogue number	cutting edges	W	L10	S	BS	Re	hm	THM	THM-U	THR	TN6501	TN6502	TN6510	TN6520	TN6525	TN6540	TTI25	TTM08	WK15CM	WP35CM	WP40PM	WS30PM	WU20PM		
XPHT160408ERGE	2	9,44	15,67	4,76	1,80	0,80	0,12	●					●												
XPHT160408ERGE	2	9,44	15,67	4,76	1,80	0,80	0,12	●					●												
XPHT160408ERGE	2	9,44	15,67	4,76	1,80	0,80	—	●					●								●				
XPHT160412ERGE	2	9,44	15,67	4,76	1,50	1,20	0,12	●					●												
XPHT160412ERGE	2	9,44	15,67	4,76	1,50	1,20	—	●					●								●				

M680-16 • XPHT

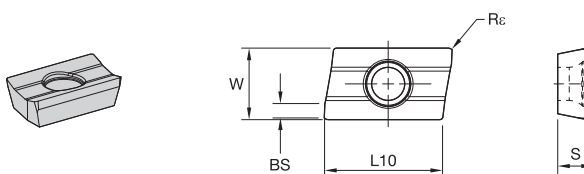

- first choice
- alternate choice

P	●													●	●	●	●				●	●	○	●
M	○													○	○	○	○				○	○		○
K	○	●							○	○			○	○	○	○					○	○		○
N	○	○	○								○													○
S	○	○	○	○																	○	○		○
H	○	○	○	○																				○

ISO catalogue number	cutting edges	W	L10	S	BS	Re	hm	THM	THM-U	THR	TN6501	TN6502	TN6510	TN6520	TN6525	TN6540	TTI25	TTM08	WK15CM	WP35CM	WP40PM	WS30PM	WU20PM		
XPHT160404	2	9,53	15,67	4,76	2,17	0,40	0,16	●																	
XPHT160408	2	9,53	15,67	4,76	1,80	0,80	0,16	●						●											
XPHT160408	2	9,53	15,67	4,76	1,80	0,80	—	●						●							●				
XPHT160412	2	9,53	15,67	4,76	1,50	1,20	0,16	●		●															

90° Shoulder Mills • M680 Series

M680-16 • XPHT

(continued)

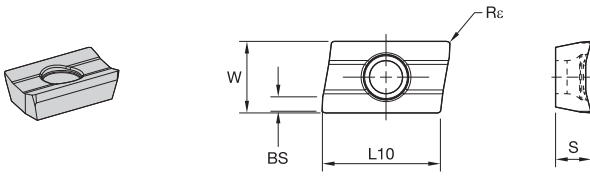

● first choice
○ alternate choice

P	●																								
M	●																								
K	○	○	○	○	○	○	○	○	○	○	○	○	○	○	○	○	○	○	○	○	○	○	○	○	○
N	○	○	○	○	○	○	○	○	○	○	○	○	○	○	○	○	○	○	○	○	○	○	○	○	○
S	○	○	○	○	○	○	○	○	○	○	○	○	○	○	○	○	○	○	○	○	○	○	○	○	○
H	○	○	○	○	○	○	○	○	○	○	○	○	○	○	○	○	○	○	○	○	○	○	○	○	○

ISO catalogue number	cutting edges	W	L10	S	BS	Rε	hm	THM	THM-U	THR	TN6501	TN6502	TN6510	TN6520	TN6525	TN6540	TT125	TTM08	WK15CM	WK15PM	WP35CM	WP40PM	WS30PM	WU20PM	
XPHT160412	2	9,53	15,67	4,76	1,50	1,20	—																		
XPHT160412	2	9,53	15,67	4,76	1,50	1,20	0,16	2025362					2964169	2964167	2964180	2964165	2029048	2029050	5427396			6843936	5645178		2562092
XPHT160416	2	9,53	15,67	4,76	0,80	1,60	0,16									2964166			5427391						
XPHT160416	2	9,53	15,67	4,76	0,80	1,60	—														6843997				
XPHT160420	2	9,53	15,67	4,76	0,50	2,00	0,16												5427398						
XPHT160420	2	9,53	15,67	4,76	0,50	2,00	—														6843994		5645210		
XPHT160425	2	9,53	15,67	4,76	1,20	2,50	0,16												5427392						
XPHT160425	2	9,53	15,67	4,76	1,20	2,50	—														6843995		5645211		
XPHT160432	2	9,53	15,67	4,76	1,20	3,17	—															6843996			
XPHT160432	2	9,53	15,67	4,76	1,20	3,17	0,16																5645212		
XPHT160440	2	9,53	15,67	4,76	1,20	4,00	0,16												5427394						
XPHT160440	2	9,53	15,67	4,76	1,20	4,00	—															6843992		5645213	

INDEXABLE MILLING

SOLID END MILLING

HOLE MAKING

TAPPING

TURNING

M680-16 • XPNT

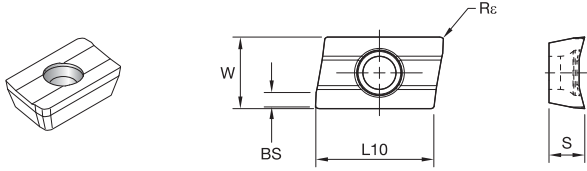

● first choice
○ alternate choice

P								●	●	●	●		●	●	○	○
M								○	○	○	○		●	●	●	●
K								○	○	○	○		●	●	○	○
N								●	○	○	○		○	○	○	○
S								○	○	○	○		○	○	○	○
H													○	○	○	○

ISO catalogue number	cutting edges	W	L10	S	BS	Re	hm	THM	THM-U	THR	TN6501	TN6502	TN6510	TN6520	TN6525	TN6540	TTI25	TTM08	WK15CM	WK15PM	WP35CM	WP40PM	WS30PM	WU20PM	
XPNT160412	2	9,53	15,88	4,79	1,20	1,20	0,16	○	○	○	○	○	○	○	○	○	○	○	○	○	○	○	○	○	○
XPNT160412	2	9,53	15,88	4,79	1,20	1,20	0,16	○	○	○	○	○	○	○	○	○	○	○	○	○	○	○	○	○	○

M680-16 • XPHT-MR

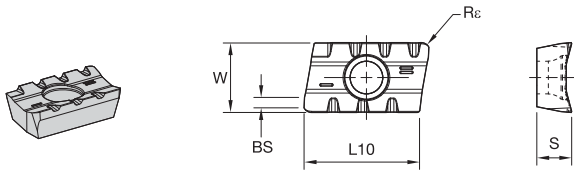

● first choice
○ alternate choice

P								●	●	●	●		●	●	○	○
M								○	○	○	○		●	●	○	○
K								○	○	○	○		●	●	○	○
N								●	○	○	○		○	○	○	○
S								○	○	○	○		○	○	○	○
H													○	○	○	○

ISO catalogue number	cutting edges	W	L10	S	BS	Re	hm	THM	THM-U	THR	TN6501	TN6502	TN6510	TN6520	TN6525	TN6540	TTI25	TTM08	WK15CM	WK15PM	WP35CM	WP40PM	WS30PM	WU20PM	
XPHT160412MR	2	9,53	15,77	4,76	1,70	1,20	0,18	○	○	○	○	○	○	○	○	○	○	○	○	○	○	○	○	○	○
XPHT160412MR	2	9,53	15,77	4,76	1,70	1,20	—	○	○	○	○	○	○	○	○	○	○	○	○	○	○	○	○	○	○

INDEXABLE MILLING

SOLID END MILLING

HOLEMAKING

TAPPING

TURNING

M680-16 • XPHT-L

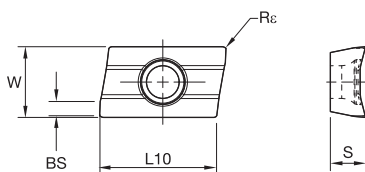
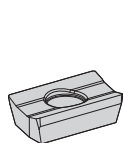

● first choice
○ alternate choice

P	■	■	■	■	■	■	■	■	●	●	●	●	●	●	○	○								
M	■	■	■	■	■	■	■	■	○	○	○	○	○	○	○	○								
K	■	○	○	○	○	○	○	○	●	●	●	●	●	●	○	○								
N	●	○	○	○	○	○	○	○	○	○	○	○	○	○	○	○								
S	○	○	○	○	○	○	○	○	○	○	○	○	○	○	○	○								
H	○	○	○	○	○	○	○	○	○	○	○	○	○	○	○	○								
									THM	THM-U	THR	TN6501	TN6502	TN6510	TN6520	TN6540	TT125	TTM08	WK15CM	WK15PM	WP35CM	WP40PM	WS30PM	WU20PM
ISO catalogue number	cutting edges	W	L10	S	BS	Re	hm												5427397		6843993			
XPHT160412L	2	9,53	—	4,76	1,40	1,20	0,16																	

M680 • Insert Selection Guide

Material Group	Light Machining		General Purpose		Heavy Machining	
	Geometry	Grade	Geometry	Grade	Geometry	Grade
P1-P2	XPHT-GE	WP40PM	XPHT..	WP40PM	XPHT..	WP40PM
P3-P4	XPHT-GE	TN6540	XPHT..	WP40PM	XPHT..	WP40PM
P5-P6	XPHT-GE	TN6540	XPHT..	WP40PM	XPHT..	WP40PM
M1-M2	XPHT-GE	TN6540	XPHT..	TN6540	XPHT-MR	TN6540
M3	XPHT-GE	TN7535	XPHT..	WP40PM	XPHT-MR	TN7535
K1-K2	XPHT-GE	TN6510	XPHT..	TN6520	XPHT-MR	WK15CM
K3	XPHT-GE	TN6510	XPHT..	TN7535	XPHT-MR	WK15CM
N1-N2	XPHT-ALP	TN6501	XPHT-ALP	TN6501	XPHT-ALP	TN6501
N3	XPHT-ALP	TN6501	XPHT-ALP	TN6501	XPHT-ALP	TN6501
S1-S2	XPHT-GE	TN6540	XPHT..	TN6540	XPHT-MR	TN6540
S3	XPHT-GE	WS30PM	XPHT..	TN6540	XPHT-MR	TN6540
S4	XPHT-GE	TN6540	XPHT..	TN6540	XPHT-MR	TN6540
H1	XPHT-GE	WS30PM	XPHT..	TN6540	XPHT-MR	TN6540

M680 • Recommended Starting Speeds [m/min]

Material Group		THR	THM-U	TN6501	TN6502	TN6510	TN6520	TN6525	TN6540
P	0	-	-	-	-	-	-	340 265 235	300 235 200
	1	-	-	-	-	-	-	340 265 235	300 235 200
	2	-	-	-	-	-	-	265 210 180	210 160 140
	3	-	-	-	-	-	-	235 180 155	180 140 115
	4	-	-	-	-	-	-	195 140 120	150 110 90
	5	-	-	-	-	-	-	260 195 165	200 150 125
M	1	-	-	-	-	-	-	160 100 65	110 65 50
	2	-	-	-	-	-	-	100 65 40	65 40 35
	3	-	-	-	-	-	-	105 65 45	70 40 35
K	1	150 135 120	190 170 150	-	-	400 290 215	375 265 190	230 205 185	185 170 150
	2	185 140 120	-	-	-	350 235 170	325 210 160	180 160 150	145 130 115
	3	105 75 50	-	-	-	280 215 165	250 190 135	150 135 120	130 120 105
N	1	900 600 500	2000 1200 1000	2000 1200 1000	1075 945 875	-	-	-	-
	2	685 465 385	1365 815 665	1365 815 665	1075 945 875	-	-	-	-
	3	450 280 200	800 500 400	800 500 400	945 875 760	-	-	-	-
S	1	35 25 20	-	-	-	-	-	-	40 30 25
	2	25 20 15	-	-	-	-	-	-	20 15 10
	3	50 40 30	-	-	-	-	-	-	60 35 25
	4	35 25 18	-	-	-	-	-	-	50 25 20
H	1	-	-	-	-	-	-	-	-
	2	-	-	-	-	-	-	-	-
	3	-	-	-	-	-	-	-	-

Material Group		TTM08	WK15PM	WP35CM	WU20PM	TTI25	THM	WK15CM	WP40PM	WS30PM
P	0	-	-	-	-	360 300 250	-	-	295 260 245	-
	1	230 200 190	-	455 395 370	330 290 270	360 300 250	-	-	295 260 245	-
	2	195 170 140	-	280 255 230	275 250 200	260 210 180	-	-	250 215 180	-
	3	180 150 125	-	255 230 205	255 220 175	260 210 180	-	-	230 195 160	-
	4	160 130 105	-	190 175 160	225 190 150	220 180 150	-	-	205 170 135	-
	5	-	-	260 230 210	185 175 150	265 195 165	-	-	170 155 135	-
M	1	-	-	205 185 155	205 180 165	400 260 180	-	-	195 170 155	225 200 185
	2	-	-	185 160 140	185 160 130	270 170 120	-	-	175 150 125	205 180 145
	3	-	-	145 130 115	140 120 95	265 175 120	-	-	130 115 90	155 135 105
K	1	-	400 290 215	295 265 240	250 220 185	185 155 130	-	420 385 340	-	-
	2	-	350 235 170	235 210 190	200 180 150	150 120 105	-	335 295 275	-	-
	3	-	280 215 165	195 175 160	180 150 120	120 105 85	-	280 250 230	-	-
N	1	-	-	-	550 470 400	-	795 695 600	-	-	-
	2	-	-	-	550 470 400	-	795 695 600	-	-	-
	3	-	-	-	400 350 300	-	560 485 420	-	-	-
S	1	-	-	-	40 35 25	-	-	-	40 35 30	45 40 30
	2	-	-	-	40 35 25	-	-	-	40 35 30	45 40 30
	3	-	-	-	50 40 25	-	-	-	50 40 30	55 45 30
	4	-	-	66 50 33	70 50 35	-	-	-	65 50 35	85 60 40
H	1	-	-	-	110 80 70	-	-	-	-	-
	2	-	-	-	-	-	-	-	-	-
	3	-	-	-	-	-	-	-	-	-

NOTE: FIRST choice starting speeds are in bold type.
As the average chip thickness increases, the speed should be decreased.

M680 • Recommended Starting Feeds [mm]

Light Machining	General Purpose	Heavy Machining
-----------------	-----------------	-----------------

Insert Geometry	Programmed Feed per Tooth (fz) as a % of Radial Depth of Cut (ae)												Insert Geometry			
	5%			10%			20%			30%				40-100%		
XPHT-ALP	0.12	0.35	0.58	0.08	0.25	0.42	0.06	0.19	0.31	0.06	0.17	0.27	0.05	0.15	0.25	XPHT-ALP
XPHT-GE	0.19	0.47	0.70	0.14	0.34	0.50	0.11	0.26	0.38	0.09	0.22	0.33	0.08	0.20	0.30	XPHT-GE
XPHT..	0.22	0.56	0.82	0.16	0.40	0.59	0.12	0.30	0.44	0.10	0.26	0.38	0.10	0.24	0.35	XPHT..
XPNT..	0.22	0.56	0.82	0.16	0.40	0.59	0.12	0.30	0.44	0.10	0.26	0.38	0.10	0.24	0.35	XPNT..
XPHT-MR	0.23	0.59	0.92	0.17	0.43	0.66	0.13	0.32	0.50	0.11	0.28	0.43	0.10	0.25	0.40	XPHT-MR

NOTE: Use "Light Machining" value as starting feed rate.

M680+ • Screw-On • Metric

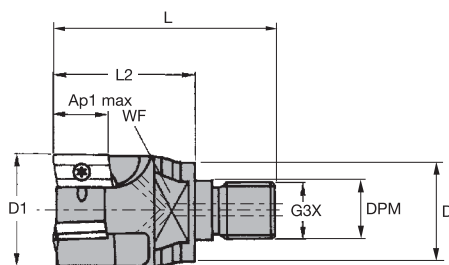

order number	catalogue number	D1	D	DPM	G3X	L	L2	WF	Ap1 max	Z	max RPM	coolant supply	kg
2223036	12396931400	25	25	12,5	M12	52	30	19	9,5	3	9500	Yes	0,2
2223037	12396931600	32	32	17,0	M16	63	40	22	9,5	5	8500	Yes	0,3

NOTE: Standard milling cutters will accept insert nose radii up to 2mm without modification. For tool body modification instructions, see page A114.

M680+ • Weldon® Shank • Metric

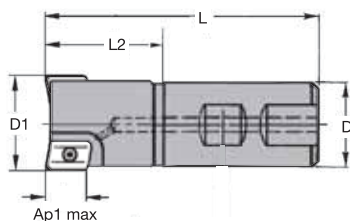

order number	catalogue number	D1	D	L	L2	Ap1 max	Z	max RPM	coolant supply	kg
2223034	12396925000	32	32	100	40	9,5	5	16000	Yes	0,5

NOTE: Standard milling cutters will accept insert nose radii up to 2mm without modification. For tool body modification instructions, see page A114.

M680+ • Shell Mills • Metric

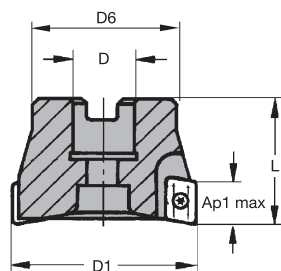

order number	catalogue number	D1	D	D6	L	Ap1 max	Z	max RPM	coolant supply	kg
2223028	12396906400	40	22	38	40	9,5	6	14000	Yes	0,2

NOTE: Standard milling cutters will accept insert nose radii up to 2mm without modification. For tool body modification instructions, see page A114.

FOR SPARE PARTS, PLEASE VISIT WIDIA.COM OR WIDIANOVO.COM.

MOUNTING SCREWS ARE NOT INCLUDED IN STANDARD PACKAGING.

M680+ • AONT-ML

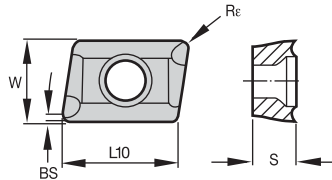
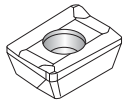

- first choice
- alternate choice

	P	M	K	N	S	H		THM	THM-U	THR	TN6501	TN6502	TN6510	TN6520	TN6525	TN6540	TTI25	TTM08	WK15CM	WK15PM	WP35CM	WP40PM	WS30PM	WU20PM	
	●														●	●	●	●			●	●	○	○	
	○		○	○	○								●	●	○	○	○	○		●	○	○	○	○	
	○		○	○	○						●	●	○	○							○	○	○	○	
	○		○	○	○										●						○	○	○	○	
																●					○	○	○	○	
ISO catalogue number	cutting edges	W	L10	S	BS	R _e	hm	THM	THM-U	THR	TN6501	TN6502	TN6510	TN6520	TN6525	TN6540	TTI25	TTM08	WK15CM	WK15PM	WP35CM	WP40PM	WS30PM	WU20PM	
AONT10T308ML	2	7,50	10,37	3,92	1,00	0,80	0,08	2031642					2957823	2957782		2957760									

M680+ • AONT-MM

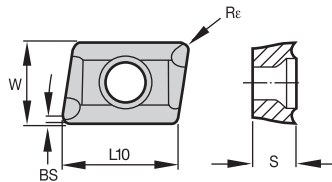

- first choice
- alternate choice

	P	M	K	N	S	H		THM	THM-U	THR	TN6501	TN6502	TN6510	TN6520	TN6525	TN6540	TTI25	TTM08	WK15CM	WK15PM	WP35CM	WP40PM	WS30PM	WU20PM
	●														●	●	●	●			●	●	○	○
	○		○	○	○								●	●	○	○	○	○		●	○	○	○	○
	○		○	○	○						●	●	○	○							○	○	○	○
	○		○	○	○										●						○	○	○	○
																●					○	○	○	○
ISO catalogue number	cutting edges	W	L10	S	BS	R _e	hm	THM	THM-U	THR	TN6501	TN6502	TN6510	TN6520	TN6525	TN6540	TTI25	TTM08	WK15CM	WK15PM	WP35CM	WP40PM	WS30PM	WU20PM
AONT10T308MM	2	7,54	10,44	3,97	1,00	0,80	0,10												6118214					

M680+ • AONT-MH

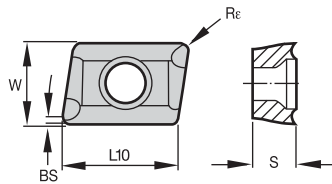
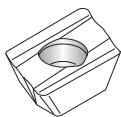

- first choice
- alternate choice

	P	M	K	N	S	H		THM	THM-U	THR	TN6501	TN6502	TN6510	TN6520	TN6525	TN6540	TTI25	TTM08	WK15CM	WK15PM	WP35CM	WP40PM	WS30PM	WU20PM
	●														●	●	●	●			●	●	○	○
	○		○	○	○								●	●	○	○	○	○		●	○	○	○	○
	○		○	○	○						●	●	○	○							○	○	○	○
	○		○	○	○										●						○	○	○	○
																●					○	○	○	○
ISO catalogue number	cutting edges	W	L10	S	BS	R _e	hm	THM	THM-U	THR	TN6501	TN6502	TN6510	TN6520	TN6525	TN6540	TTI25	TTM08	WK15CM	WK15PM	WP35CM	WP40PM	WS30PM	WU20PM
AONT10T308MH	2	7,54	10,44	3,97	1,00	0,80	0,12							2957827	2957824									
AONT10T308MM	2	7,54	10,44	3,97	1,00	0,80	0,10													6901185	6901183			

M680+ • Insert Selection Guide

Material Group	Light Machining		General Purpose		Heavy Machining	
	Geometry	Grade	Geometry	Grade	Geometry	Grade
P1-P2	XPHT-GE	WP40PM	XPHT..	WP40PM	XPHT..	WP40PM
P3-P4	XPHT-GE	TN6540	XPHT..	WP40PM	XPHT..	WP40PM
P5-P6	XPHT-GE	TN6540	XPHT..	WP40PM	XPHT..	WP40PM
M1-M2	XPHT-GE	TN6540	XPHT..	TN6540	XPHT-MR	TN6540
M3	XPHT-GE	TN7535	XPHT..	WP40PM	XPHT-MR	TN7535
K1-K2	XPHT-GE	TN6510	XPHT..	TN6520	XPHT-MR	WK15CM
K3	XPHT-GE	TN6510	XPHT..	TN7535	XPHT-MR	WK15CM
N1-N2	XPHT-ALP	TN6501	XPHT-ALP	TN6501	XPHT-ALP	TN6501
N3	XPHT-ALP	TN6501	XPHT-ALP	TN6501	XPHT-ALP	TN6501
S1-S2	XPHT-GE	TN6540	XPHT..	TN6540	XPHT-MR	TN6540
S3	XPHT-GE	WS30PM	XPHT..	TN6540	XPHT-MR	TN6540
S4	XPHT-GE	TN6540	XPHT..	TN6540	XPHT-MR	TN6540
H1	XPHT-GE	WS30PM	XPHT..	TN6540	XPHT-MR	TN6540

M680+ • Recommended Starting Speeds [m/min]

Material Group		THR			THM-U			TN6501			TN6502			TN6510			TN6520			TN6525			TN6540		
		1	2	3	1	2	3	1	2	3	1	2	3	1	2	3	1	2	3	1	2	3	1	2	3
P	0	-	-	-	-	-	-	-	-	-	-	-	-	-	-	-	-	-	-	340	265	235	300	235	200
	1	-	-	-	-	-	-	-	-	-	-	-	-	-	-	-	-	-	-	340	265	235	300	235	200
	2	-	-	-	-	-	-	-	-	-	-	-	-	-	-	-	-	-	-	265	210	180	210	160	140
	3	-	-	-	-	-	-	-	-	-	-	-	-	-	-	-	-	-	-	235	180	155	180	140	115
	4	-	-	-	-	-	-	-	-	-	-	-	-	-	-	-	-	-	-	195	140	120	150	110	90
	5	-	-	-	-	-	-	-	-	-	-	-	-	-	-	-	-	-	-	260	195	165	200	150	125
M	6	-	-	-	-	-	-	-	-	-	-	-	-	-	-	-	-	-	-	170	135	110	135	100	85
	1	-	-	-	-	-	-	-	-	-	-	-	-	-	-	-	-	-	-	160	100	65	110	65	50
	2	-	-	-	-	-	-	-	-	-	-	-	-	-	-	-	-	-	-	100	65	40	65	40	35
K	3	-	-	-	-	-	-	-	-	-	-	-	-	-	-	-	-	-	-	105	65	45	70	40	35
	1	150	135	120	190	170	150	-	-	-	400	290	215	375	265	190	230	205	185	185	170	150			
	2	185	140	120	-	-	-	-	-	-	350	235	170	325	210	160	180	160	150	145	130	115			
N	3	105	75	50	-	-	-	-	-	-	280	215	165	250	190	135	150	135	120	130	120	105			
	1	900	600	500	2000	1200	1000	2000	1200	1000	1075	945	875	-	-	-	-	-	-	-	-	-			
	2	685	465	385	1365	815	665	1365	815	665	1075	945	875	-	-	-	-	-	-	-	-	-			
S	3	450	280	200	800	500	400	800	500	400	945	875	760	-	-	-	-	-	-	-	-	-			
	1	35	25	20	-	-	-	-	-	-	-	-	-	-	-	-	-	-	-	-	-	-			
	2	25	20	15	-	-	-	-	-	-	-	-	-	-	-	-	-	-	-	40	30	25			
	3	50	40	30	-	-	-	-	-	-	-	-	-	-	-	-	-	-	-	20	15	10			
H	4	35	25	18	-	-	-	-	-	-	-	-	-	-	-	-	-	-	-	60	35	25			
	1	-	-	-	-	-	-	-	-	-	-	-	-	-	-	-	-	-	-	50	25	20			
	2	-	-	-	-	-	-	-	-	-	-	-	-	-	-	-	-	-	-	-	-	-			
H	3	-	-	-	-	-	-	-	-	-	-	-	-	-	-	-	-	-	-	-	-	-			

M680+ • Recommended Starting Speeds [m/min]

Material Group	TTM08	WK15PM	WP35CM	WU20PM	TTI25	THM	WK15CM	WP40PM	WS30PM	
P	0	- - -	- - -	- - -	- - -	360 300 250	- - -	- - -	295 260 245	- - -
	1	230 200 190	- - -	455 395 370	330 290 270	360 300 250	- - -	- - -	295 260 245	- - -
	2	195 170 140	- - -	280 255 230	275 250 200	260 210 180	- - -	- - -	250 215 180	- - -
	3	180 150 125	- - -	255 230 205	255 220 175	260 210 180	- - -	- - -	230 195 160	- - -
	4	160 130 105	- - -	190 175 160	225 190 150	220 180 150	- - -	- - -	205 170 135	- - -
	5	- - -	- - -	260 230 210	185 175 150	265 195 165	- - -	- - -	170 155 135	- - -
6	- - -	- - -	160 135 110	165 130 100	120 90 75	- - -	- - -	150 115 90	- - -	
M	1	- - -	- - -	205 185 155	205 180 165	400 260 180	- - -	- - -	195 170 155	225 200 185
	2	- - -	- - -	185 160 140	185 160 130	270 170 120	- - -	- - -	175 150 125	205 180 145
	3	- - -	- - -	145 130 115	140 120 95	265 175 120	- - -	- - -	130 115 90	155 135 105
K	1	- - -	400 290 215	295 265 240	250 220 185	185 155 130	- - -	420 385 340	- - -	- - -
	2	- - -	350 235 170	235 210 190	200 180 150	150 120 105	- - -	335 295 275	- - -	- - -
	3	- - -	280 215 165	195 175 160	180 150 120	120 105 85	- - -	280 250 230	- - -	- - -
N	1	- - -	- - -	- - -	550 470 400	- - -	795 695 600	- - -	- - -	- - -
	2	- - -	- - -	- - -	550 470 400	- - -	795 695 600	- - -	- - -	- - -
	3	- - -	- - -	- - -	400 350 300	- - -	560 485 420	- - -	- - -	- - -
S	1	- - -	- - -	- - -	40 35 25	- - -	- - -	- - -	40 35 30	45 40 30
	2	- - -	- - -	- - -	40 35 25	- - -	- - -	- - -	40 35 30	45 40 30
	3	- - -	- - -	- - -	50 40 25	- - -	- - -	- - -	50 40 30	55 45 30
	4	- - -	- - -	66 50 33	70 50 35	- - -	- - -	- - -	65 50 35	85 60 40
H	1	- - -	- - -	- - -	110 80 70	- - -	- - -	- - -	- - -	- - -
	2	- - -	- - -	- - -	- - -	- - -	- - -	- - -	- - -	- - -
	3	- - -	- - -	- - -	- - -	- - -	- - -	- - -	- - -	- - -

NOTE: FIRST choice starting speeds are in **bold** type.
As the average chip thickness increases, the speed should be decreased.

M680+ • Recommended Starting Feeds [mm]

Light Machining	General Purpose	Heavy Machining
-----------------	-----------------	-----------------

Insert Geometry	Programmed Feed per Tooth (fz) as a % of Radial Depth of Cut (ae)															Insert Geometry
	5%			10%			20%			30%			40-100%			
XPHT-ALP	0,12	0,35	0,58	0,08	0,25	0,42	0,06	0,19	0,31	0,06	0,17	0,27	0,05	0,15	0,25	XPHT-ALP
XPHT-GE	0,19	0,47	0,70	0,14	0,34	0,50	0,11	0,26	0,38	0,09	0,22	0,33	0,08	0,20	0,30	XPHT-GE
XPHT..	0,22	0,56	0,82	0,16	0,40	0,59	0,12	0,30	0,44	0,10	0,26	0,38	0,10	0,24	0,35	XPHT..
XPNT..	0,22	0,56	0,82	0,16	0,40	0,59	0,12	0,30	0,44	0,10	0,26	0,38	0,10	0,24	0,35	XPNT..
XPHT-MR	0,23	0,59	0,92	0,17	0,43	0,66	0,13	0,32	0,50	0,11	0,28	0,43	0,10	0,25	0,40	XPHT-MR

NOTE: Use "Light Machining" value as starting feed rate.

M690 Series

M690 IC12, M690 IC15 Shoulder Mills

The M690 shoulder mill is an economical, four-edged tool designed to deliver optimal chip evacuation, excellent shoulder finish, and free cutting action.



IC12 AND IC15 INSERTS OFFERED IN FOUR GEOMETRIES



-ALP



Recommended as a first choice for machining non-ferrous and aluminum materials.

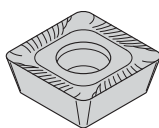

-ML



Steel, cast iron with secondary uses on stainless and titanium.



-MM



Steel, cast iron with secondary uses on stainless and titanium.
Recommended as a first choice for general machining of all materials.



-MH



This geometry is reserved for heavy or interrupted cut machining operations that require additional edge protection.

ECONOMICAL SHOULDER MILLING

PRODUCT

SERIES

M690

DIAMETER RANGE

125–315mm

SHANK TYPES

Shell Mills
Weldon® End Mills

INDUSTRY



APPLICATIONS



SIDE MILLING/
SHOULDER
MILLING:
SQUARE END



FACE
MILLING



SLOTING:
SQUARE END



M690 • Shell Mills SD1204.. • Metric

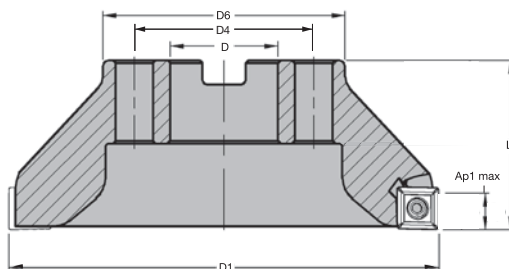

order number	catalogue number	D1	D	D4	D6	L	Ap1 max	Z	max RPM	coolant supply	kg
2003556	12396953800	50	22	—	47	40	10,0	4	22400	Yes	0,3
2003557	12396954000	50	22	—	47	40	10,0	5	22400	Yes	0,3
2003573	12396954200	63	22	—	50	40	10,0	5	20000	Yes	0,5
2003574	12396954400	63	22	—	50	40	10,0	6	20000	Yes	0,5
2003580	12396954600	80	27	—	60	50	10,0	6	17700	Yes	1,0
2003581	12396954800	80	27	—	60	50	10,0	8	17700	Yes	1,1
2003596	12396955000	100	32	—	78	50	10,0	8	15800	No	1,5
2003597	12396955200	100	32	—	78	50	10,0	10	15800	No	1,6
2003693	12396955400	125	40	—	89	63	10,0	9	14200	No	3,0
2003694	12396955600	125	40	—	89	63	10,0	12	14200	No	3,0
2003793	12396955800	160	40	66,7	90	63	10,0	12	12500	No	3,6

NOTE: Standard milling cutters will accept insert nose radius up to 2mm without modification.
For tool body modification instructions, see page A114.

FOR SPARE PARTS, PLEASE VISIT WIDIA.COM OR WIDIANOVO.COM.
MOUNTING SCREWS ARE NOT INCLUDED IN STANDARD PACKAGING.

M690 • SDMT-ML • SD1204..

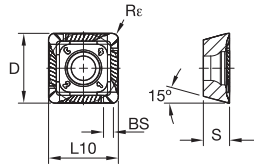
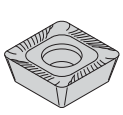

- first choice
- alternate choice

P	●	●	●	●	●	○	○	○	○
M	●	●	○	○	○	○	○	○	○
K	●	●	○	○	○	○	○	○	○
N	○	○	○	○	○	○	○	○	○
S	○	○	○	○	○	○	○	○	○
H	○	○	○	○	○	○	○	○	○

ISO catalogue number	cutting edges	D	L10	S	BS	R ϵ	hm	THM-U	TN6520	TN6525	TN6540	WK15CM	WP35CM	WS30PM	WS40PM
SDMT1204PDRML	4	13	12,70	4,77	1,10	1,20	0,08	3094667	-	-	3020185	5427423	-	-	6180319

INDEXABLE MILLING

SOLID END MILLING

HOLEMAKING

TAPPING

TURNING

M690 • SDMX-MM • SD1204..

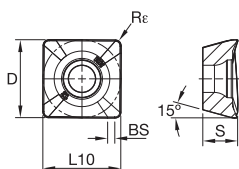

- first choice
- alternate choice

P	■	■	■	●	●	●	●	○	○	○
M	■	■	■	●	●	●	●	○	○	○
K	■	■	■	●	●	●	●	○	○	○
N	■	■	■	●	●	●	●	○	○	○
S	■	■	■	●	●	●	●	○	○	○
H	■	■	■	●	●	●	●	○	○	○

ISO catalogue number	cutting edges	D	L10	S	BS	R _ε	hm	THM-U	TN6520	TN6525	TN6540	WK15CM	WP35CM	WS30PM	WS40PM
SDMX120408RMM	4	13	12,70	4,76	1,93	0,80	0,10	■	■	○	○	○	○	○	○
SDMX120412RMM	4	13	12,70	4,76	1,50	1,20	0,10	■	■	○	○	○	○	○	○
SDMX120416RMM	4	13	12,70	4,76	1,50	1,60	0,10	■	4145063	■	■	■	■	■	■
SDMX120424RMM	4	13	12,70	4,76	0,60	2,40	0,10	■	■	■	4145072	■	6842091	■	■
SDMX120432RMM	4	13	12,70	4,76	—	3,20	0,10	■	■	■	4145094	■	6842092	■	■

M690 • SDMX-MH • SD1204..

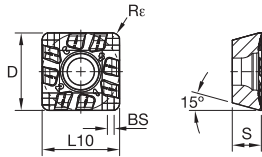

- first choice
- alternate choice

P	■	■	■	●	●	●	●	○	○	○	○
M	■	■	■	●	●	●	●	○	○	○	○
K	■	■	■	●	●	●	●	○	○	○	○
N	■	■	■	●	●	●	●	○	○	○	○
S	■	■	■	●	●	●	●	○	○	○	○
H	■	■	■	●	●	●	●	○	○	○	○

ISO catalogue number	cutting edges	D	L10	S	BS	R _ε	hm	THM-U	TN6520	TN6525	TN6540	WK15CM	WP35CM	WS30PM	WS40PM
SDMX120408RMH	4	13	12,70	4,76	1,93	0,80	0,14	■	■	■	■	■	■	■	■
SDMX120412RMH	4	13	12,70	4,76	1,54	1,20	0,14	■	■	■	■	■	■	■	■
SDMX120416RMH	4	13	12,70	4,76	1,50	1,60	0,14	■	■	■	■	■	■	■	■

INDEXABLE MILLING

SOLID END MILLING

HOLEMAKING

TAPPING

TURNING

M690 • SDMT-MH • SD1204..

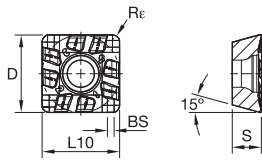

- first choice
- alternate choice

P	■	■	■	●	●	●	○	○	○
M	■	■	○	○	○	○	○	○	○
K	■	■	○	○	○	○	○	○	○
N	■	○	○	○	○	○	○	○	○
S	■	○	○	○	○	○	○	○	○
H	■	○	○	○	○	○	○	○	○

ISO catalogue number	cutting edges	D	L10	S	BS	R _e	hm	THM-U	TN6520	TN6525	TN6540	WK15CM	WP35CM	WS30PM	WS40PM
SDMT1204PDRMH	4	13	12,70	4,81	1,10	1,20	0,14	■	■	○	○	○	○	○	○

M690 • SDEX-ALP • SD1204..

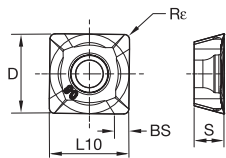

- first choice
- alternate choice

P	■	■	■	●	●	●	○	○	○
M	■	■	○	○	○	○	○	○	○
K	■	■	○	○	○	○	○	○	○
N	■	○	○	○	○	○	○	○	○
S	■	○	○	○	○	○	○	○	○
H	■	○	○	○	○	○	○	○	○

catalogue number	cutting edges	D	L10	S	BS	R _e	hm	THM-U	TN6520	TN6525	TN6540	WK15CM	WP35CM	WS30PM	WS40PM
SDEX120408FRALP	4	.500	.504	.187	.060	.031	.001	■	■	○	○	○	○	○	○

M690 SD1204 • Insert Selection Guide

Material Group	Light Machining		General Purpose		Heavy Machining	
	Geometry	Grade	Geometry	Grade	Geometry	Grade
P1-P2	.E..ML	TN6540	.S..MM	TN6540	.S..MH	TN6540
P3-P4	.E..ML	TN6540	.S..MM	TN6540	.S..MH	TN6540
P5-P6	.E..ML	TN6540	.S..MM	TN6540	.S..MH	TN6540
M1-M2	.E..ML	TN6540	.S..MM	TN6540	.S..MH	TN6540
M3	.E..ML	WS40PM	.S..MM	WS40PM	.S..MH	WP35CM
K1-K2	.E..ML	WK15CM	.E..ML	WK15CM	.S..MH	WK15CM
K3	.E..ML	WK15CM	.S..MM	TN6525	.S..MH	TN6525
N1-N2	.ALP	THM-U	.E..ML	THM-U	.S..ML	THM-U
N3	.ALP	THM-U	.E..ML	THM-U	.S..ML	THM-U
S1-S2	.E..ML	TN6540	.S..MM	TN6540	.S..MM	TN6540
S3	.E..ML	TN6540	.S..MM	WS30PM	.S..MM	TN6540
S4	.E..ML	TN6540	.S..MM	WS30PM	.S..MM	TN6540
H1	.S..MM	WS30PM	.S..MM	WS30PM	.S..MM	WS30PM

M690 SD1204 • Recommended Starting Speeds [m/min]

Material Group		TN6520			TN6525			TN6540			WP35CM		
P	0	-	-	-	340	265	235	300	235	200	-	-	-
	1	-	-	-	340	265	235	300	235	200	455	395	370
	2	-	-	-	265	210	180	210	160	140	280	255	230
	3	-	-	-	235	180	155	180	140	115	255	230	205
	4	-	-	-	195	140	120	150	110	90	190	175	160
	5	-	-	-	260	195	165	200	150	125	260	230	210
6	-	-	-	170	135	110	135	100	85	160	135	110	
M	1	-	-	-	160	100	65	110	65	50	205	185	155
	2	-	-	-	100	65	40	65	40	35	185	160	140
	3	-	-	-	105	65	45	70	40	35	145	130	115
K	1	375	265	190	230	205	185	185	170	150	295	265	240
	2	325	210	160	180	160	150	145	130	115	235	210	190
	3	250	190	135	150	135	120	130	120	105	195	175	160
N	1	-	-	-	-	-	-	-	-	-	-	-	-
	2	-	-	-	-	-	-	-	-	-	-	-	-
	3	-	-	-	-	-	-	-	-	-	-	-	-
S	1	-	-	-	-	-	-	40	30	25	-	-	-
	2	-	-	-	-	-	-	20	15	10	-	-	-
	3	-	-	-	-	-	-	60	35	25	-	-	-
	4	-	-	-	-	-	-	50	25	20	66	50	33
H	1	-	-	-	-	-	-	-	-	-	-	-	-
	2	-	-	-	-	-	-	-	-	-	-	-	-
	3	-	-	-	-	-	-	-	-	-	-	-	-

Material Group		WK15CM			WS30PM			WS40PM			THM-U		
P	0	-	-	-	-	-	-	-	-	-	-	-	-
	1	-	-	-	-	-	-	280	245	230	-	-	-
	2	-	-	-	-	-	-	235	205	170	-	-	-
	3	-	-	-	-	-	-	215	185	150	-	-	-
	4	-	-	-	-	-	-	195	160	130	-	-	-
	5	-	-	-	-	-	-	160	140	130	-	-	-
6	-	-	-	-	-	-	140	110	85	-	-	-	
M	1	-	-	-	225	200	185	260	190	115	-	-	-
	2	-	-	-	205	180	145	230	170	105	-	-	-
	3	-	-	-	155	135	105	190	140	80	-	-	-
K	1	420	385	340	-	-	-	-	-	-	190	170	150
	2	335	295	275	-	-	-	-	-	-	-	-	-
	3	280	250	230	-	-	-	-	-	-	-	-	-
N	1	-	-	-	-	-	-	1075	945	945	2000	1200	1000
	2	-	-	-	-	-	-	945	875	845	1365	815	665
	3	-	-	-	-	-	-	875	760	760	800	500	400
S	1	-	-	-	45	40	30	62	45	27	-	-	-
	2	-	-	-	45	40	30	55	40	26	-	-	-
	3	-	-	-	55	45	30	64	46	29	-	-	-
	4	-	-	-	85	60	40	90	66	42	-	-	-
H	1	-	-	-	-	-	-	-	-	-	-	-	-
	2	-	-	-	-	-	-	-	-	-	-	-	-
	3	-	-	-	-	-	-	-	-	-	-	-	-

NOTE: FIRST choice starting speeds are in **bold** type.
As the average chip thickness increases, the speed should be decreased.

M690 SD1204 • Recommended Starting Feeds [mm]

Light Machining	General Purpose	Heavy Machining
-----------------	-----------------	-----------------

Insert Geometry	Programmed Feed per Tooth (fz) as a % of Radial Depth of Cut (ae)															Insert Geometry
	5%			10%			20%			30%			40-100%			
.F..ALP	0,12	0,23	0,46	0,08	0,17	0,33	0,06	0,13	0,25	0,06	0,11	0,22	0,05	0,10	0,20	.F..ALP
.E..ML	0,12	0,35	0,58	0,08	0,25	0,42	0,06	0,19	0,31	0,06	0,17	0,27	0,05	0,15	0,25	.E..ML
.S..MM	0,12	0,42	0,70	0,08	0,30	0,50	0,06	0,23	0,38	0,06	0,20	0,33	0,05	0,18	0,30	.S..MM
.S..MH	0,23	0,54	0,85	0,17	0,39	0,61	0,13	0,29	0,46	0,11	0,25	0,40	0,10	0,23	0,36	.S..MH

NOTE: Use "Light Machining" value as starting feed rate.

M690 • Shell Mills SD1506.. • Metric

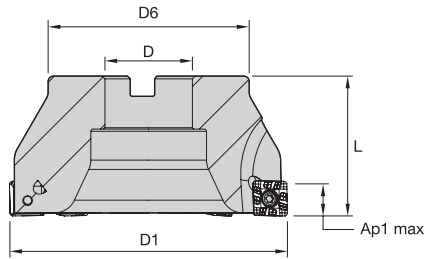

order number	catalogue number	D1	D	D6	L	Ap1 max	Z	max RPM	coolant supply	kg
2003555	12396943800	50	22	47	40	12,0	4	18500	Yes	0,3
2003562	12396944200	63	22	50	40	12,0	5	16100	Yes	0,4
2003579	12396944600	80	27	60	50	12,0	6	14000	Yes	0,9
2003595	12396945000	100	32	78	50	12,0	8	12300	No	1,3
2003682	12396945400	125	40	89	63	12,0	9	10800	No	2,7

FOR SPARE PARTS, PLEASE VISIT WIDIA.COM OR WIDIANOVO.COM.
MOUNTING SCREWS ARE NOT INCLUDED IN STANDARD PACKAGING.

M690 • SDMT-ML • SD1506..

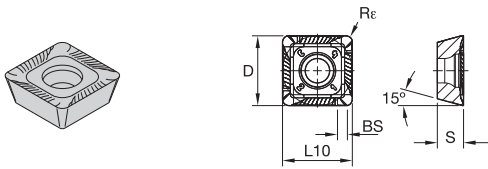

- first choice
- alternate choice

P	■	■	■	●	●	●	○	○	○
M	■	■	■	○	○	○	○	○	○
K	■	■	■	○	○	○	○	○	○
N	■	■	○	○	○	○	○	○	○
S	■	■	■	○	○	○	○	○	○
H	■	■	■	○	○	○	○	○	○

catalogue number	cutting edges	D	L10	S	BS	Rε	hm	THM-U	TN6520	TN6525	TN6540	3378677	5427425	WK15CM	WP35CM	WS30PM	WS40PM	
SDMT1506PDRML	4	.625	.625	.249	.043	.047	.003	■	■	■	○	○	○	○	○	○	○	○

M690 • SDMX-MM • SD1506..

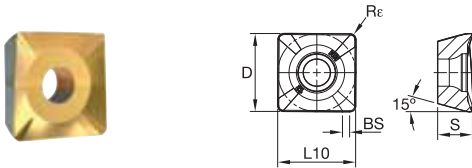

- first choice
- alternate choice

P	■	■	■	●	●	●	○	○	○
M	■	■	■	○	○	○	○	○	○
K	■	■	■	○	○	○	○	○	○
N	■	■	○	○	○	○	○	○	○
S	■	■	■	○	○	○	○	○	○
H	■	■	■	○	○	○	○	○	○

catalogue number	cutting edges	D	L10	S	BS	Rε	hm	THM-U	TN6520	TN6525	TN6540	3949807	WK15CM	WP35CM	WS30PM	WS40PM
SDMX150612RMM	4	.625	.625	.250	.057	.047	.006	■	■	■	○	○	○	○	○	○

INDEXABLE MILLING

SOLID END MILLING

HOLEMAKING

TAPPING

TURNING

M690 • SDMX-MM • SD1506..

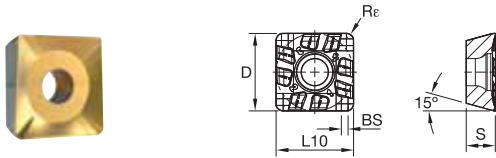

- first choice
- alternate choice

P	●	●	●	●	●	●	●	●	●
M	●	●	●	●	●	●	●	●	●
K	●	●	●	●	●	●	●	●	●
N	○	○	○	○	○	○	○	○	○
S	○	○	○	○	○	○	○	○	○
H	○	○	○	○	○	○	○	○	○

catalogue number	cutting edges	D	L10	S	BS	Rε	hm	THM-U	TN6520	TN6525	TN6540	WK15CM	WP35CM	WS30PM	WS40PM
SDMX150612RMH	4	.625	.625	.250	.057	.047	.008	●	●	●	○	○	○	○	○
SDMX150616RMH	4	.625	.625	.250	.059	.063	.008	●	●	●	○	○	○	○	○

M690 • SDMT-MH • SD1506..

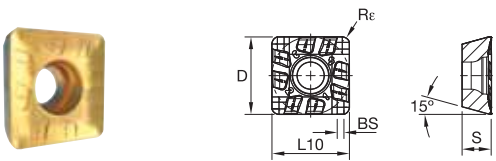

- first choice
- alternate choice

P	●	●	●	●	●	●	●	●	●
M	●	●	●	●	●	●	●	●	●
K	●	●	●	●	●	●	●	●	●
N	○	○	○	○	○	○	○	○	○
S	○	○	○	○	○	○	○	○	○
H	○	○	○	○	○	○	○	○	○

catalogue number	cutting edges	D	L10	S	BS	Rε	hm	THM-U	TN6520	TN6525	TN6540	WK15CM	WP35CM	WS30PM	WS40PM
SDMT1506PDRMH	4	.625	.625	.250	.043	.047	.003	●	●	●	○	○	○	○	○

M690 SD1506 • Insert Selection Guide

Material Group	Light Machining		General Purpose		Heavy Machining	
	Geometry	Grade	Geometry	Grade	Geometry	Grade
P1-P2	.E..ML	TN6540	.S..MM	TN6540	.S..MH	TN6540
P3-P4	.E..ML	TN6540	.S..MM	TN6540	.S..MH	TN6540
P5-P6	.E..ML	TN6540	.S..MM	TN6540	.S..MH	TN6540
M1-M2	.E..ML	TN6540	.S..MM	TN6540	.S..MH	TN6540
M3	.E..ML	TN6540	.S..MM	WP35CM	.S..MH	WP35CM
K1-K2	.E..ML	WK15CM	.E..ML	WK15CM	.S..MH	WK15CM
K3	.E..ML	WK15CM	.S..MM	WK15CM	.S..MH	WK15CM
N1-N2	-	-	-	-	-	-
N3	-	-	-	-	-	-
S1-S2	.E..ML	TN6540	.S..MM	TN6540	.S..MM	TN6540
S3	.E..ML	TN6540	.S..MM	TN6540	.S..MM	TN6540
S4	.E..ML	TN6540	.S..MM	TN6540	.S..MM	TN6540
H1	.S..MM	TN6540	.S..MM	TN6540	.S..MM	TN6540

M690 SD1506 • Recommended Starting Speeds [m/min]

Material Group		TN6520			TN6525			TN6540			WP35CM		
P	0	-	-	-	340	265	235	300	235	200	-	-	
	1	-	-	-	340	265	235	300	235	200	455	395	370
	2	-	-	-	265	210	180	210	160	140	280	255	230
	3	-	-	-	235	180	155	180	140	115	255	230	205
	4	-	-	-	195	140	120	150	110	90	190	175	160
	5	-	-	-	260	195	165	200	150	125	260	230	210
6	-	-	-	170	135	110	135	100	85	160	135	110	
M	1	-	-	-	160	100	65	110	65	50	205	185	155
	2	-	-	-	100	65	40	65	40	35	185	160	140
	3	-	-	-	105	65	45	70	40	35	145	130	115
K	1	375	265	190	230	205	185	185	170	150	295	265	240
	2	325	210	160	180	160	150	145	130	115	235	210	190
	3	250	190	135	150	135	120	130	120	105	195	175	160
N	1	-	-	-	-	-	-	-	-	-	-	-	-
	2	-	-	-	-	-	-	-	-	-	-	-	-
	3	-	-	-	-	-	-	-	-	-	-	-	-
S	1	-	-	-	-	-	-	40	30	25	-	-	-
	2	-	-	-	-	-	-	20	15	10	-	-	-
	3	-	-	-	-	-	-	60	35	25	-	-	-
	4	-	-	-	-	-	-	50	25	20	66	50	33
H	1	-	-	-	-	-	-	-	-	-	-	-	-
	2	-	-	-	-	-	-	-	-	-	-	-	-
	3	-	-	-	-	-	-	-	-	-	-	-	-

Material Group		WK15CM			WS30PM			WS40PM			THM-U		
P	0	-	-	-	-	-	-	-	-	-	-	-	-
	1	-	-	-	-	-	-	280	245	230	-	-	-
	2	-	-	-	-	-	-	235	205	170	-	-	-
	3	-	-	-	-	-	-	215	185	150	-	-	-
	4	-	-	-	-	-	-	195	160	130	-	-	-
	5	-	-	-	-	-	-	160	140	130	-	-	-
6	-	-	-	-	-	-	140	110	85	-	-	-	
M	1	-	-	-	225	200	185	260	190	115	-	-	-
	2	-	-	-	205	180	145	230	170	105	-	-	-
	3	-	-	-	155	135	105	190	140	80	-	-	-
K	1	420	385	340	-	-	-	-	-	-	190	170	150
	2	335	295	275	-	-	-	-	-	-	-	-	-
	3	280	250	230	-	-	-	-	-	-	-	-	-
N	1	-	-	-	-	-	-	1075	945	945	2000	1200	1000
	2	-	-	-	-	-	-	945	875	845	1365	815	665
	3	-	-	-	-	-	-	875	760	760	800	500	400
S	1	-	-	-	45	40	30	62	45	27	-	-	-
	2	-	-	-	45	40	30	55	40	26	-	-	-
	3	-	-	-	55	45	30	64	46	29	-	-	-
	4	-	-	-	85	60	40	90	66	42	-	-	-
H	1	-	-	-	-	-	-	-	-	-	-	-	-
	2	-	-	-	-	-	-	-	-	-	-	-	-
	3	-	-	-	-	-	-	-	-	-	-	-	-

NOTE: FIRST choice starting speeds are in bold type.
As the average chip thickness increases, the speed should be decreased.

M690 SD1506 • Recommended Starting Feeds [mm]

Light Machining	General Purpose	Heavy Machining
-----------------	-----------------	-----------------

Insert Geometry	Programmed Feed per Tooth (fz) as a % of Radial Depth of Cut (ae)														Insert Geometry	
	5%			10%			20%			30%			40-100%			
.F..ALP	0,12	0,23	0,46	0,08	0,17	0,33	0,06	0,13	0,25	0,06	0,11	0,22	0,05	0,10	0,20	.F..ALP
.E..ML	0,12	0,35	0,58	0,08	0,25	0,42	0,06	0,19	0,31	0,06	0,17	0,27	0,05	0,15	0,25	.E..ML
.S..MM	0,12	0,42	0,70	0,08	0,30	0,50	0,06	0,23	0,38	0,06	0,20	0,33	0,05	0,18	0,30	.S..MM
.S..MH	0,23	0,54	0,85	0,17	0,39	0,61	0,13	0,29	0,46	0,11	0,25	0,40	0,10	0,23	0,36	.S..MH

NOTE: Use "Light Machining" value as starting feed rate.

The VHSC Victory™ high-speed cutter is designed to perform true high-speed profiling and pocket milling operations on thin-walled aluminum alloy components using heavy feeds and high ramping angles.



Flute engineered for maximum chip evacuation.

Cylindrical shank designed and balanced to G6.3 at 30,000RPM.

Internal coolant to enable chip evacuation.

Inserts with different radii are held without losing gauge height of the cutter length.

The VHSC high-speed cutter's proprietary pocket design allows multiple insert radii (R0.4–R6.0) for one body definition while also maintaining axial positioning regardless of the size of the insert corner nose radius. This feature saves time for CNC programmers and operators by removing the step to re-balance and modify the body during the insert change process.

Seven different corner nose radii are available, each with 16mm axial cutting depth.

HIGH-SPEED CUTTING INSERTS XDET-ALP FOR NON-FERROUS MATERIALS

FR-ALP



Sharp cutting edge "F" preparation for roughing and finishing jobs.

ER-ALP



Honed cutting edge "E" preparation for heavy roughing jobs and demanding castings.

Finishing Capabilities/Lower Cutting Forces

Geometry Strengthening

TRUE HSC

Developed to achieve true HSC cutting of aluminum components up to 9843 SFM or 3,000m/min.

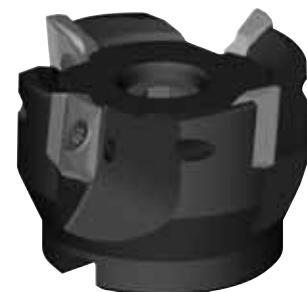

THIN-WALLED ALUMINUM HIGH-SPEED CUTTING

PRODUCT

SERIES

VHSC

DIAMETER RANGE

Cylindrical End Mills: 25–32mm
 Monoblocks: 25–50mm
 Shell Mills: 40–80mm

SHANK TYPES

Cylindrical End Mills
 Monoblocks
 Shell Mills

INDUSTRY



APPLICATIONS



FACE
MILLING



RAMPING
BLANK



HELICAL
MILLING



POCKETING



SIDE/
SHOULDER
MILLING:
SLOTING:
SHOULDER



SPIRAL/
CIRCULAR



3D PROFILING

USER-FRIENDLY SETUP MAKES A BIG DIFFERENCE

LARGE CORNER RADIUS

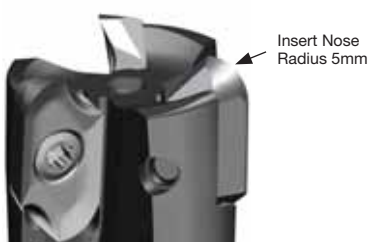

SMALL CORNER RADIUS

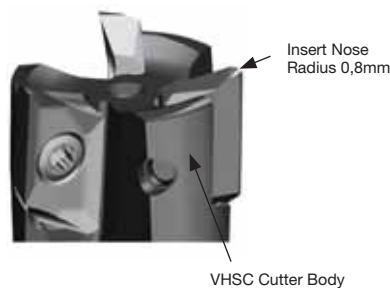

- Unique feature has a great impact on significant cost savings.
- Only one cutter body needed to load inserts with corner nose radii from R0,4mm to R6mm max.
- All other suppliers require modification and rebalance of the cutter body.

INSERT OVERLAY

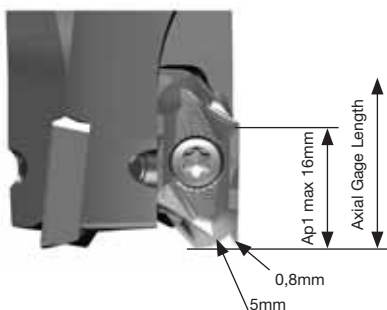

- Axial gage length on the cutter body will always be the same, no matter which insert nose radius is applied.
- Preferred by CNC programmers and operators.
- Ap1 max will always remain 16mm, no matter which insert nose radius is applied.

VHSC • Monoblocks • Metric

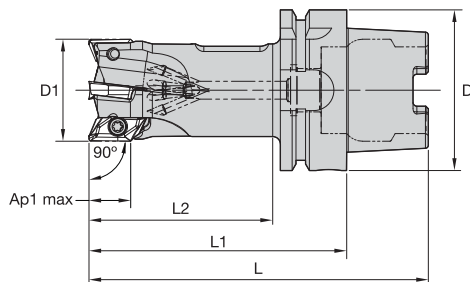

order number	catalogue number	D1	D	L	L1	L2	Ap1 max	Z	max ramp angle	max RPM	coolant supply	kg
6425447	VHSC025Z02HSK63XD16	25	63	133	101	75	16	2	14.5°	51000	Yes	0,81
6425449	VHSC032Z03HSK63XD16	32	63	133	101	75	16	3	11.4°	41500	Yes	0,91
6425451	VHSC040Z04HSK63XD16	40	63	133	101	75	16	4	7.8°	35000	Yes	1,09
6425453	VHSC050Z04HSK63XD16	50	63	133	101	75	15	4	7.9°	30000	Yes	1,41

NOTE: Pre-Balanced G6.3/30000 RPM.

NOTE: It is important to change the screw each time the insert is changed to ensure the highest security.

A dynamometric key and the correct insert screw torque value are key for HSC applications.

Adjustable torque wrench (order number 6197561) and Torx Plus 20 bit (order number 6205891)

may be purchased separately.

VHSC • Shell Mills • Metric

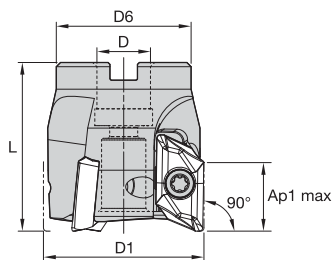

order number	catalogue number	D1	D	D6	L	Ap1 max	Z	max ramp angle	max RPM	coolant supply	kg
6425291	VHSC040Z03S16XD16	40	16	32	45	16	3	7.6°	35000	Yes	0,20
6425292	VHSC050Z04S22XD16	50	22	45	45	16	4	7.8°	30000	Yes	0,31
6425293	VHSC063Z04S22XD16	63	22	50	45	16	4	5.9°	26000	Yes	0,55
6425294	VHSC080Z05S27XD16	80	27	55	50	16	5	4.4°	22500	Yes	0,89

NOTE: It is important to change the screw each time the insert is changed to ensure the highest security.

A dynamometric key and the correct insert screw torque value are key for HSC applications.

Adjustable torque wrench (order number 6197561) and Torx Plus 20 bit (order number 6205891)

may be purchased separately.

VHSC • Cylindrical End Mills • Metric

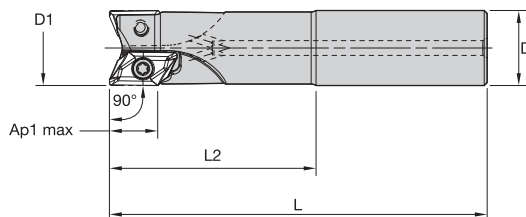

order number	catalogue number	D1	D	L	L2	Ap1 max	Z	max ramp angle	max RPM	coolant supply	kg
6425258	VHSC025Z02A25XD16	25	25	131	75	16	2	14.7°	50000	Yes	0,39
6425259	VHSC032Z02A32XD16	32	32	135	75	16	2	11.4°	41500	Yes	0,65
6425260	VHSC032Z03A32XD16	32	32	135	75	16	3	11.4°	41500	Yes	0,65

NOTE: Pre-balanced to G6.3/30000 RPM.

NOTE: It is important to change the screw each time the insert is changed to ensure the highest security.

A dynamometric key and the correct insert screw torque value are key for HSC applications.

Adjustable torque wrench (order number 6197561) and Torx Plus 20 bit (order number 6205891)

may be purchased separately.

VHSC • XDET-ALP

- first choice
- alternate choice

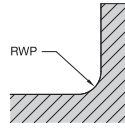
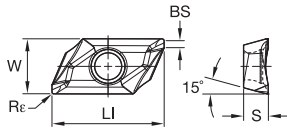

P	Blue	
M	Yellow	
K	Red	
N	Green	●
S	Orange	
H	Grey	

ISO catalogue number	cutting edges	LI	S	W	BS	Re	RWP*	hm	WN10HM
XDET16M5PDFRALP	2	22,92	5,00	11,25	1,42	0,30	0,30	0,02	6425772
XDET16M504FRALP	2	23,02	5,00	11,25	1,27	0,40	0,40	0,02	6425773
XDET16M508FRALP	2	23,02	5,00	11,25	0,87	0,80	0,80	0,02	6425774
XDET16M512FRALP	2	23,02	5,00	11,25	0,87	1,24	1,20	—	6797599
XDET16M516FRALP	2	23,02	5,00	11,25	0,87	1,68	1,60	—	6797600
XDET16M520FRALP	2	23,02	5,00	11,25	0,58	2,10	2,00	0,02	6425775
XDET16M530ERALP	2	23,02	5,00	11,25	0,48	3,10	3,00	0,03	6425776
XDET16M530FRALP	2	23,02	5,00	11,25	0,48	3,10	3,00	0,02	6425777
XDET16M540ERALP	2	23,02	5,00	11,25	0,60	4,10	4,00	0,03	6425778
XDET16M540FRALP	2	23,02	5,00	11,25	0,60	4,10	4,00	0,02	6425779
XDET16M550FRALP	2	23,02	5,00	11,25	0,24	5,20	5,00	0,02	6425780

INDEXABLE MILLING

SOLID END MILLING

HOLEMAKING

TAPPING

TURNING

FOR SPARE PARTS, PLEASE VISIT WIDIA.COM OR WIDIANOVO.COM.
MOUNTING SCREWS ARE NOT INCLUDED IN STANDARD PACKAGING.

VHSC • Insert Selection Guide

Material Group	Light Machining		General Purpose		Heavy Machining	
	Geometry	Grade	Geometry	Grade	Geometry	Grade
N1-N2	.F..ALP	WN10HM	.F..ALP	WN10HM	.E..ALP	WN10HM
N3	.F..ALP	WN10HM	.F..ALP	WN10HM	.E..ALP	WN10HM

VHSC • Recommended Starting Speeds [m/min]

Material Group	WN10HM		
	N	1	2950
	2	2950	875
	3	1600	480

NOTE: FIRST choice starting speeds are in **bold** type.
As the average chip thickness increases, the speed should be decreased.

VHSC • Recommended Starting Feeds [mm]

Light Machining	General Purpose	Heavy Machining
-----------------	-----------------	-----------------

Insert Geometry	Programmed Feed per Tooth (fz) as a % of Radial Depth of Cut (ae)														Insert Geometry	
	5%			10%			20%			30%			40-100%			
.F..ALP	0,12	0,45	0,81	0,08	0,33	0,58	0,06	0,25	0,43	0,06	0,21	0,38	0,05	0,20	0,35	.F..ALP
.E..ALP	0,15	0,50	0,92	0,11	0,36	0,66	0,08	0,27	0,50	0,07	0,24	0,43	0,07	0,22	0,40	.E..ALP

NOTE: Use "Light Machining" values as starting feed rate.

Recommendations for High Speed Machining at 8000 RPM or above

- Check spindle condition:
 - Runout
 - Clamping of the attachment in traction
 - Marking and cleanliness
- Check that the tool is suitable for the required use.
- Inserts must be locked positively in the pocket and secured using the torx screw provided. The screw must be torqued to the correct value as indicated in the charts on the product pages.
- Because of heavy force to the screw, it is important to change the screw when changing the insert.
- Check the balancing of the assembled tool: cutter body, inserts, and attachment.
- Before start up, note the maximum RPM engraved on the tool. The maximum RPM is linked to a precise balancing value.
- Ensure that the field of application of the tool shown in our technical documents and technological parameters is observed:
 - Ae (mm) Width of cut, lateral engagement (radial)
 - ap (mm) Axial depth of cut
 - fz (mm/tooth) mm per tooth
 - n (RPM) Revolutions per minute



WIDIA™ cannot accept responsibility for misuse of this product due to:

- Non-observance of the above instructions
- Machine without casing
- Incorrect clamping of workpieces
- No safety device on the machine
- Any misuse or incorrect clamping

The optimum rotation must be determined by condition of the spindle. The spindle must be rigid to run at these higher RPMs.

Under no circumstances must any attempt be made to repair this tool. The only permitted maintenance is the indexing or replacement of the inserts.

When assembling the cutter to a Shrink Fit holder, the maximum protrusion cannot exceed 10% of the reach of tool.

Balancing:

- Cylindrical shank and HSK63A integral shanks are designed and balanced to G6.3 at 30000 RPM for diameters up to 50mm.
- Cylindrical shank tools mounted in a Shrink Fit holder or any other chuck mill holder + inserts + screws must be re-inspected for balance as an assembly by the end-user when at or exceeding 8000 RPM. End-user must balance the assembly at a G6.3 at 30000 RPM maximum.
- Shell mills are not balanced. These tools must be re-inspected for balance as an assembly, cutter + inserts + screws by the end-user for high speed machining at 8000 RPM or above. End-user must balance the assembly at a G6.3 value minimum.
- Balancing requires removing some material by drilling or milling operations.
- For each new shell mill installed on the same toolholder, re-balance the assembly.

Tighten the bolt between the shell mill and toolholder; with lubricant, apply the torque value of:

Thread sizes (mm)	Cutter Bore Size (mm)	Torque Values Nm
M6	13	10
M8	16	30
M10	22	50
M12	27	80
M16	32	110
M20	40	120

Technical Information

▼ Machinability by Materials • Aluminum

Alloy Group	Alloy Designation	Chemical Composition Limits (WT%)												Typical Temper	Rm (Mpa)	Machinability Chip Formation	Machinability
		Cu	Si	Fe	Mn	Mg	Zn	Cr	Ti	Pb	Bi	Al	Others				
Al	1050	0.05	0.25	0.40	0.50	0.05	0.05	-	-	-	-	99.50min	-	H14	105	D	A
	1100	0.05-0.20	Si+Fe 1.00 max	-	0.05	-	0.10	-	-	-	-	99.00min	-	H14	90	D	A
AlCu	2011	5.00-6.00	0.40	0.70	-	-	0.30	-	-	0.20	0.60	remaining	-	T3	310	A	A
	2014	3.90-5.00	0.50-1.20	0.70	0.40-1.20	0.20-0.80	0.25	0.10	0.15	-	-	remaining	-	T6	430	B	A
	2017	3.50-4.50	0.20-0.80	0.70	0.40-1.00	0.40-0.80	0.25	0.10	0.15	-	-	remaining	-	T4	390	B	A
	2024	3.80-4.90	0.50	0.50	0.30-0.90	1.20-1.80	0.25	0.10	0.15	-	-	remaining	-	T4	465	B	A
	2218	3.50-4.50	0.90	1	0.20	1.20-1.80	0.25	0.10	-	-	-	remaining	Ni1.7-2.3	T72	331	B	B
	2224	3.80-4.40	0.12	0.15	0.30-0.90	1.20-1.80	0.25	0.10	0.15	-	-	remaining	-	-	-	A	A
AlMn	3003	0.05-0.20	0.60	0.70	1.00-1.50	-	0.10	-	-	-	-	remaining	-	H14	140	D	B
AlSi	4032	0.50-1.30	11.00-13.50	1	-	0.80-1.30	0.25	0.10	-	-	-	remaining	Ni0.5-1.3	T6	379	B	D
AlMg	5083	0.10	0.40	0.40	0.40-1.00	4.00-4.90	0.25	0.05-0.25	0.15	-	-	remaining	-	H112	335	C	A
AlMgSi	6061	0.15-0.40	0.40-0.80	0.70	0.15	0.80-1.20	0.25	0.04-0.35	0.15	-	-	remaining	-	T6	300	C	B
	6063	0.10	0.20-0.60	0.35	0.10	0.45-0.90	0.10	0.10	0.10	-	-	remaining	-	T5	200	C	B
	6070	0.15-0.40	1.00-1.70	0.50	0.40-1.00	0.50-1.20	0.25	0.10	0.15	-	-	remaining	-	T6	379	C	C
	6151	0.35	0.60-1.20	1	0.20	0.45-0.80	0.25	0.15-0.35	0.15	-	-	remaining	-	T6	-	C	C
	6262	0.15-0.40	0.40-0.80	0.70	0.15	0.80-1.20	0.25	0.04-0.14	0.15	0.40	0.70	remaining	-	T9	400	B	B
	6351	0.10	0.70-1.30	0.50	0.40-0.80	0.40-0.80	0.20	-	0.20	-	-	remaining	-	T6	310	D	C
	6463	0.20	0.20-0.60	0.15	0.05	0.45-0.90	0.05	-	-	-	-	remaining	-	T6	241	C	B
	AlZn	7001	1.60-2.60	0.35	0.40	0.20	2.60-3.40	6.80-8.00	0.18-0.35	0.20	-	-	remaining	-	O	-	B
7003		0.20	0.30	0.35	0.30	0.50-1.00	5.00-6.50	0.20	0.20	-	-	remaining	Zr0.05-0.25	T5	400	B	A
7050		2.00-2.60	0.12	0.15	0.10	1.90-2.60	5.70-6.70	0.04	0.06	-	-	remaining	Zr0.08-0.15	T73	530	B	A
7075		1.20-2.00	0.40	0.50	0.30	2.10-2.90	5.10-6.10	0.18-0.28	0.20	-	-	remaining	-	T6	570	B	A
7178		1.60-2.40	0.40	0.50	0.30	2.40-3.10	6.30-7.30	0.18-0.35	0.20	-	-	remaining	-	T6	600	B	A
7475		1.20-1.90	0.10	0.12	0.06	1.90-2.60	5.20-6.20	0.18-0.25	0.06	-	-	remaining	-	T61	565	B	A

Machinability: A (Excellent), B (Good to Excellent), C (Good), D (Not Good)

1. Face milling
2. First choice for deep pocketing and thin wall machining
3. Boring by circular interpolation into full material
4. Ramping
5. Pocketing
6. Slotting
7. Shoulder milling with excellent step-down capability and wall finish

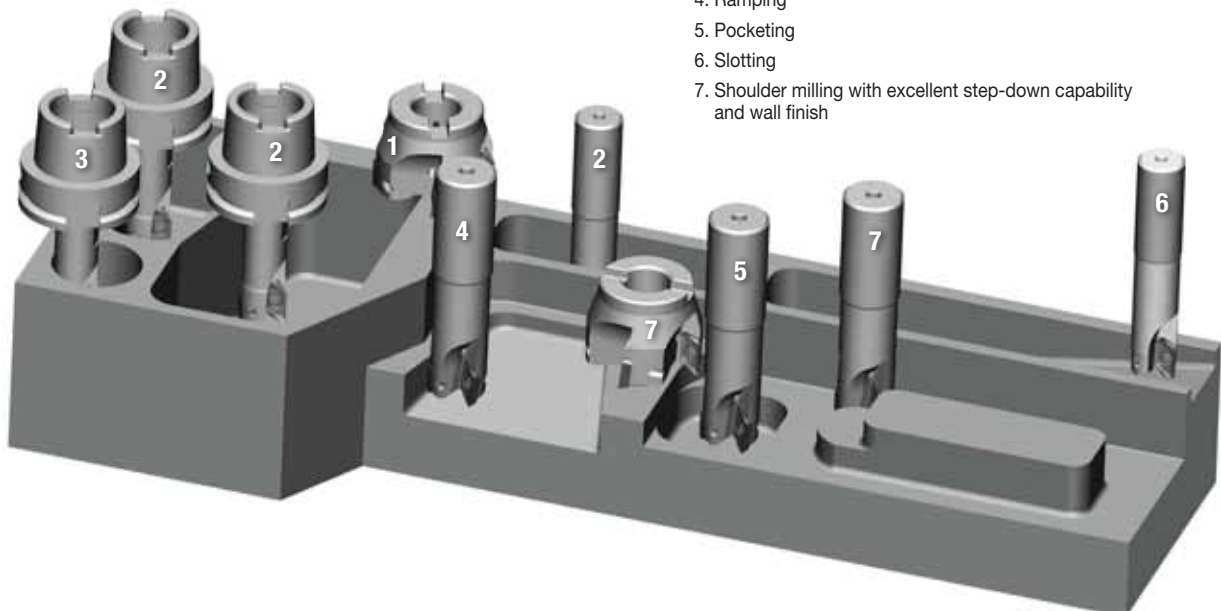

Best Practices

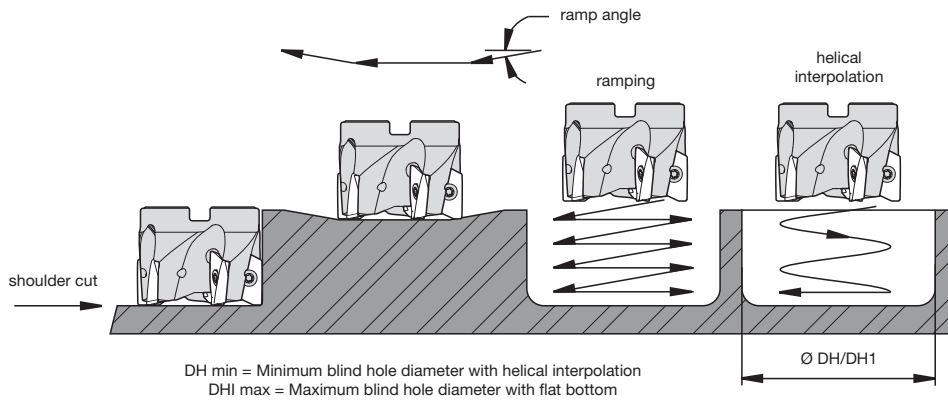

▼ Ramp Angle

cutter diameter	Max. Ramping Angle Related to Insert Corner Nose Radius and Cutter D1						
	Facet	R0.4	R0.8	R2.0	R3.0	R4.0	R5.0
25	14,8°	14,8°	14,8°	9,4°	18,8°	9,0°	11,2°
32	11,4°	11,4°	11,4°	11,9°	12,4°	13,1°	13,8°
40	7,6°	7,6°	7,6°	7,8°	8,1°	8,5°	8,8°
50	7,8°	7,5°	7,8°	7,7°	7,9°	8,4°	8,8°
63	5,8°	5,6°	5,9°	5,7°	5,8°	6,1°	6,3°
80	4,4°	4,2°	4,4°	4,2°	4,3°	4,5°	4,7°

▼ Helical Min. Hole and Helical Max. Hole

cutter diameter	DH min	DH1 max
25	30,3	48,8
32	43,5	62,0
40	59,5	78,0
50	79,5	98,0
63	105,5	124,0
80	139,5	158,0

▼ Ap1 max at Helical Interpolation for 360° Tool Path

cutter diameter	Helical Interpolation depth Ap1 max for 360° tool path
25	4,06
32	4,06
40	4,06
50	4,06
63	4,06
80	4,06

NOTE: Ap max depending on cutter diameter, rigidity of the cutter, rigidity of the machine, and size of the flute.

▼ Ap1 max at Full Slotting

cutting diameter (D1)	Number of inserts Z	Ap1 max
25	2	7,5
32	2	11,0
32	3	6,0
40	3	9,0
50	4	9,0
63	4	11,0
80	5	11,0

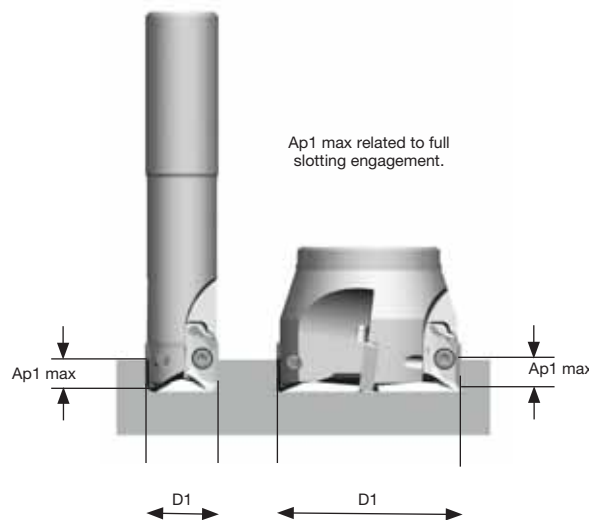

M390

M390 Helical Mill

The M390 helical mill uses a replaceable nose collar and positive helix to provide optimal chip evacuation and performance while maintaining lower maintenance costs.

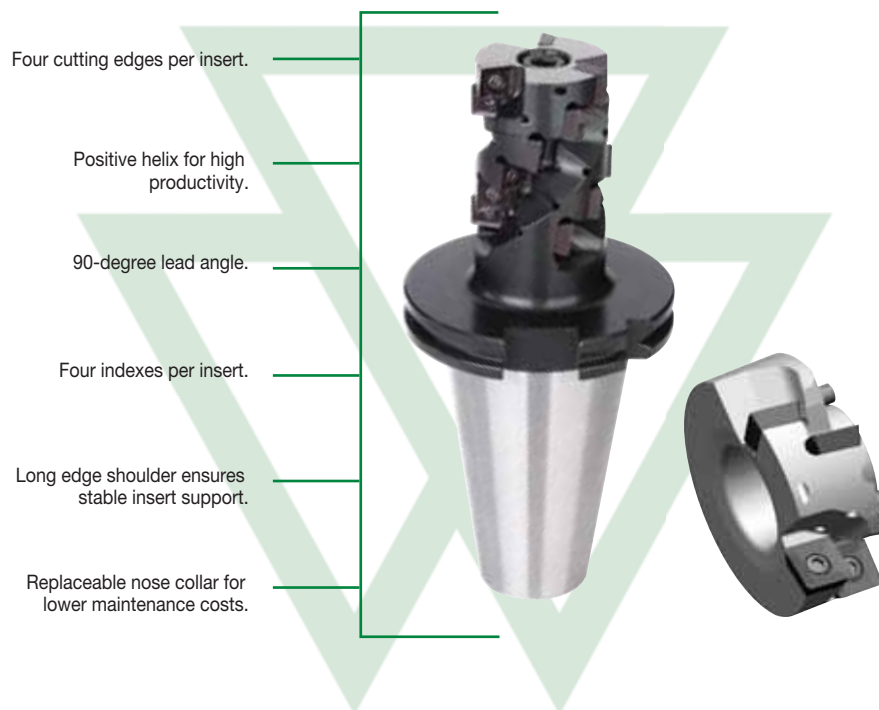

INSERTS

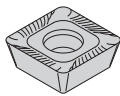

-ML
Positive geometry for light machining or shouldering with small engagements.



-MM
First choice for general machining in all materials.

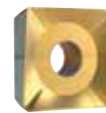

-MH
First choice for heavy machining in steel and cast iron.

FIRST CHOICE FOR HIGH-PRODUCTIVITY HELICAL MILLING

PRODUCT

SERIES

M390

DIAMETER RANGE

50–80mm

SHANK TYPES

Helical End Mills

INDUSTRY



APPLICATIONS



SIDE MILLING/
SHOULDER
MILLING:
SQUARE END



FACE
MILLING



SLOTTING:
SQUARE END

MAXIMUM CUTTING DEPTH (AP1) AND CONTACT WIDTH (AE) RATIOS BASED ON APPLICATION TYPE

SLOT MILLING

$$ae = 1 \times D_1$$

$$Ap1 \text{ max} = 0,6 \times D_1$$

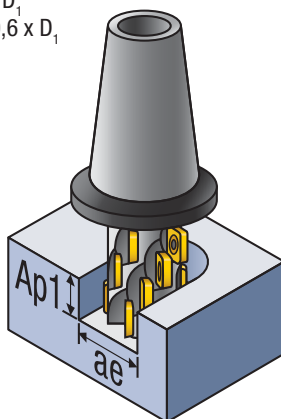

*Not recommended in ISO "H" materials.

CONTOURING

$$ae = 0,25-0,4 \times D_1$$

$$Ap1 \text{ max} = 1 \times D_1$$

$$ae = >0,4 \times D_1$$

$$Ap1 \text{ max} = 0,6 \times D_1$$

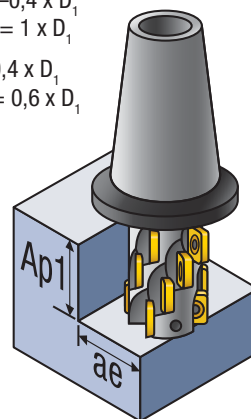

*Not recommended in ISO "H" materials.

PROFILING

$$ae = <0,25 \times D_1$$

$$Ap1 \text{ max} = Ap1 \text{ max}$$

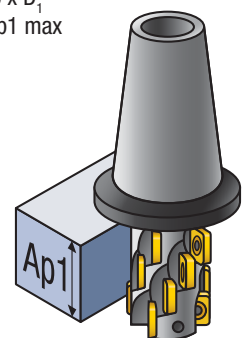

M390 • Integral SD1204.. • Metric

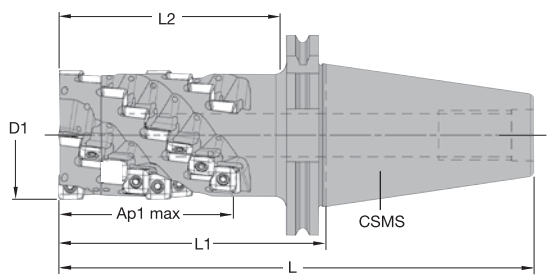

order number	catalogue number	D1	L	L1	L2	Ap1 max	Z	Z U	CSMS system size	max RPM	coolant supply	kg
2021422	12393041200	50	207	105	82	64,0	12	3	DV50	14000	Yes	3,4
2021423	12393041400	63	232	130	107	85,0	24	4	DV50	12000	Yes	4,3
2021424	12393041800	80	262	160	137	117,0	45	5	DV50	10500	Yes	6,3

NOTE: Z = number of pocket seats.
ZU = number of effective teeth.

M390 • End Cap • Metric

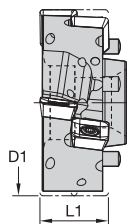

order number	catalogue number	D1	L1	Z U	Z	kg
2021428	12393051200	50	21	3	6	0,2
2021429	12393051400	63	21	4	8	0,3
2021430	12393051800	80	21	5	10	0,5

NOTE: Z = number of pocket seats.
ZU = number of effective teeth.

FOR SPARE PARTS, PLEASE VISIT WIDIA.COM OR WIDIANOVO.COM.
MOUNTING SCREWS ARE NOT INCLUDED IN STANDARD PACKAGING.

M390 • SDMT-ML • SD1204..

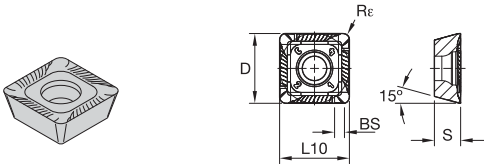

P	■	■	■	●	●	●	●	●	○	●
M	■	■	○	●	●	●	●	●	○	●
K	■	●	○	○	■	○	○	○	○	○
N	■	○	○	○	○	○	○	○	○	○
S	■	○	○	○	○	○	○	○	○	○
H	■	○	○	○	○	○	○	○	○	○

catalogue number	cutting edges	D	L10	S	BS	Rε	hm	THM-U	TN6520	TN6525	TN6540	TTM08	WK15CM	WP25PM	WP35CM	WP40PM	WS30PM	WS40PM	
SDMT1204PDRML	4	12,70	12,70	4,77	1,10	1,20	0,08	■	3094667	■	■	■	■	■	■	■	■	■	6180319
SDMT1204PDRML	4	12,70	12,70	4,77	1,10	1,20	—	■	■	■	■	■	■	6842094	■	■	■	■	■

M390 • SDMX-MM • SD1204..

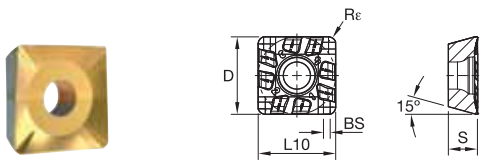

- first choice
- alternate choice

P	■	■	■	●	●	●	●	●	○	●
M	■	■	○	●	●	●	●	●	○	●
K	■	●	○	○	■	○	○	○	○	○
N	■	○	○	○	○	○	○	○	○	○
S	■	○	○	○	○	○	○	○	○	○
H	■	○	○	○	○	○	○	○	○	○

ISO catalogue number	cutting edges	D	L10	S	BS	Rε	hm	THM-U	TN6520	TN6525	TN6540	TTM08	WK15CM	WP25PM	WP35CM	WP40PM	WS30PM	WS40PM	
SDMX120408RMM	4	13	12,70	4,76	1,93	0,80	0,10	■	■	3950588	■	■	■	■	■	■	■	■	■
SDMX120412RMM	4	13	12,70	4,76	1,50	1,20	0,10	■	■	■	3950597	■	■	■	■	■	■	■	5522490
SDMX120416RMM	4	13	12,70	4,76	1,50	1,60	0,10	■	4145063	■	■	■	■	■	■	■	■	■	■
SDMX120424RMM	4	13	12,70	4,76	0,60	2,40	0,10	■	■	■	4145072	■	■	■	■	■	■	■	■
SDMX120432RMM	4	13	12,70	4,76	—	3,20	0,10	■	■	■	4145094	■	■	■	■	■	■	■	■

M390 • SDMX-MH • SD1204..

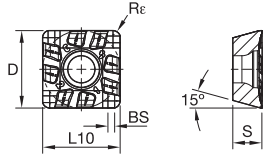

- first choice
- alternate choice

P	●	●	●	●	●	●	●	●	●	●	●	●	●	●	●
M	●	●	●	●	●	●	●	●	●	●	●	●	●	●	●
K	●	●	●	●	●	●	●	●	●	●	●	●	●	●	●
N	●	●	●	●	●	●	●	●	●	●	●	●	●	●	●
S	●	●	●	●	●	●	●	●	●	●	●	●	●	●	●
H	●	●	●	●	●	●	●	●	●	●	●	●	●	●	●

ISO catalogue number	cutting edges	D	L10	S	BS	R ϵ	hm	THM-U	TN6520	TN6525	TN6540	TTM08	WK15CM	WP25PM	WP35CM	WP40PM	WS30PM	WS40PM	
SDMX120408RMH	4	13	12,70	4,76	1,93	0,80	0,14	●	●	●	●	●	●	●	●	●	●	●	●
SDMX120412RMH	4	13	12,70	4,76	1,54	1,20	0,14	○	○	○	○	○	○	○	○	○	○	○	○
SDMX120416RMH	4	13	12,70	4,76	1,50	1,60	0,14	○	○	○	○	○	○	○	○	○	○	○	○

M390 • SDMT-MH • SD1204..

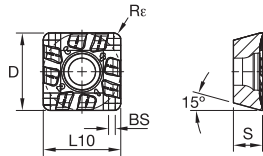

- first choice
- alternate choice

P	●	●	●	●	●	●	●	●	●	●	●	●	●	●	●	●	●	●	●
M	●	●	●	●	●	●	●	●	●	●	●	●	●	●	●	●	●	●	●
K	●	●	●	●	●	●	●	●	●	●	●	●	●	●	●	●	●	●	●
N	●	●	●	●	●	●	●	●	●	●	●	●	●	●	●	●	●	●	●
S	●	●	●	●	●	●	●	●	●	●	●	●	●	●	●	●	●	●	●
H	●	●	●	●	●	●	●	●	●	●	●	●	●	●	●	●	●	●	●

catalogue number	cutting edges	D	L10	S	BS	R ϵ	hm	THM-U	TN6520	TN6525	TN6540	TTM08	WK15CM	WP25PM	WP35CM	WP40PM	WS30PM	WS40PM	
SDMT1204PDRMH	4	12,70	12,70	4,81	1,10	1,20	0,14	○	○	○	○	○	○	○	○	○	○	○	○
SDMT1204PDRMH	4	12,70	12,70	4,81	1,10	1,20	—	○	○	○	○	○	○	○	○	○	○	○	○

M390 • Insert Selection Guide

Material Group	Light Machining		General Purpose		Heavy Machining	
	Geometry	Grade	Geometry	Grade	Geometry	Grade
P1-P2	.E..ML	TN6540	.S..MM	TN6540	.S..MH	TN6540
P3-P4	.E..ML	TN6540	.S..MM	TN6540	.S..MH	TN6540
P5-P6	.E..ML	TN6540	.S..MM	TN6540	.S..MH	TN6540
M1-M2	.E..ML	TN6540	.S..MM	TN6540	.S..MH	TN6540
M3	.E..ML	WP35CM	.S..MM	WS30PM	.S..MH	WP35CM
K1-K2	.E..ML	WK15CM	.E..ML	WK15CM	.S..MH	WK15CM
K3	.E..ML	WK15CM	.S..MM	TN6525	.S..MH	TN6525
N1-N2	-	-	-	-	-	-
N3	-	-	-	-	-	-
S1-S2	.E..ML	TN6540	.S..MM	TN6540	.S..MM	TN6540
S3	.E..ML	TN6540	.S..MM	WS30PM	.S..MM	TN6540
S4	.E..ML	TN6540	.S..MM	WS30PM	.S..MM	TN6540
H1	.S..MM	WS30PM	.S..MM	WS30PM	.S..MM	WS30PM

INDEXABLE MILLING

SOLID END MILLING

HOLE/MAKING

TAPPING

TURNING

M390 • Recommended Starting Speeds [m/min]

Material Group		THM-U			TN6520			TN6525			TN6540			TTM08		
P	0	-	-	-	-	-	-	340	265	235	300	235	200	-	-	-
	1	-	-	-	-	-	-	340	265	235	300	235	200	230	200	190
	2	-	-	-	-	-	-	265	210	180	210	160	140	195	170	140
	3	-	-	-	-	-	-	235	180	155	180	140	115	180	150	125
	4	-	-	-	-	-	-	195	140	120	150	110	90	160	130	105
	5	-	-	-	-	-	-	260	195	165	200	150	125	-	-	-
6	-	-	-	-	-	-	170	135	110	135	100	85	-	-	-	
M	1	-	-	-	-	-	-	160	100	65	110	65	50	-	-	-
	2	-	-	-	-	-	-	100	65	40	65	40	35	-	-	-
	3	-	-	-	-	-	-	105	65	45	70	40	35	-	-	-
K	1	190	170	150	375	265	190	230	205	185	185	170	150	-	-	-
	2	-	-	-	325	210	160	180	160	150	145	130	115	-	-	-
	3	-	-	-	250	190	135	150	135	120	130	120	105	-	-	-
N	1	2000	1200	1000	-	-	-	-	-	-	-	-	-	-	-	-
	2	1365	815	665	-	-	-	-	-	-	-	-	-	-	-	-
	3	800	500	400	-	-	-	-	-	-	-	-	-	-	-	-
S	1	-	-	-	-	-	-	-	-	-	40	30	25	-	-	-
	2	-	-	-	-	-	-	-	-	-	20	15	10	-	-	-
	3	-	-	-	-	-	-	-	-	-	60	35	25	-	-	-
	4	-	-	-	-	-	-	-	-	-	50	25	20	-	-	-
H	1	-	-	-	-	-	-	-	-	-	-	-	-	-	-	-
	2	-	-	-	-	-	-	-	-	-	-	-	-	-	-	-
	3	-	-	-	-	-	-	-	-	-	-	-	-	-	-	-

Material Group		WK15CM			WP25PM			WP35CM			WP40PM			WS30PM			WS40PM		
P	0	-	-	-	-	-	-	-	-	-	-	-	-	-	-	-	-	-	
	1	-	-	-	330	285	270	455	395	370	295	260	245	-	-	-	280	245	230
	2	-	-	-	275	240	200	280	255	230	250	215	180	-	-	-	235	205	170
	3	-	-	-	255	215	175	255	230	205	230	195	160	-	-	-	215	185	150
	4	-	-	-	225	185	150	190	175	160	205	170	135	-	-	-	195	160	130
	5	-	-	-	185	170	150	260	230	210	170	155	135	-	-	-	160	140	130
6	-	-	-	165	125	100	160	135	110	150	115	90	-	-	-	140	110	85	
M	1	-	-	-	205	180	165	205	185	155	195	170	155	225	200	185	260	190	115
	2	-	-	-	185	160	130	185	160	140	175	150	125	205	180	145	230	170	105
	3	-	-	-	140	120	95	145	130	115	130	115	90	155	135	105	190	140	80
K	1	420	385	340	230	205	185	295	265	240	-	-	-	-	-	-	-	-	-
	2	335	295	275	180	160	150	235	210	190	-	-	-	-	-	-	-	-	-
	3	280	250	230	150	135	120	195	175	160	-	-	-	-	-	-	-	-	-
N	1	-	-	-	-	-	-	-	-	-	-	-	-	-	-	-	1075	945	945
	2	-	-	-	-	-	-	-	-	-	-	-	-	-	-	-	945	875	845
	3	-	-	-	-	-	-	-	-	-	-	-	-	-	-	-	875	760	760
S	1	-	-	-	40	35	25	-	-	-	40	35	30	45	40	30	62	45	27
	2	-	-	-	40	35	25	-	-	-	40	35	30	45	40	30	55	40	26
	3	-	-	-	50	40	25	-	-	-	50	40	30	55	45	30	64	46	29
	4	-	-	-	70	50	35	66	50	33	65	50	35	85	60	40	90	66	42
H	1	-	-	-	120	90	70	-	-	-	-	-	-	-	-	-	-	-	-
	2	-	-	-	-	-	-	-	-	-	-	-	-	-	-	-	-	-	-
	3	-	-	-	-	-	-	-	-	-	-	-	-	-	-	-	-	-	-

NOTE: FIRST choice starting speeds are in **bold** type.
As the average chip thickness increases, the speed should be decreased.

M390 • Recommended Starting Feeds [mm]

Light Machining	General Purpose	Heavy Machining
-----------------	-----------------	-----------------

Insert Geometry	Programmed Feed per Tooth (fz) as a % of Radial Depth of Cut (ae)															Insert Geometry
	5%			10%			20%			30%			40-100%			
.F..ALP	0,12	0,23	0,46	0,08	0,17	0,33	0,06	0,13	0,25	0,06	0,11	0,22	0,05	0,10	0,20	.F..ALP
.E..ML	0,12	0,35	0,58	0,08	0,25	0,42	0,06	0,19	0,31	0,06	0,17	0,27	0,05	0,15	0,25	.E..ML
.S..MM	0,12	0,42	0,70	0,08	0,30	0,50	0,06	0,23	0,38	0,06	0,20	0,33	0,05	0,18	0,30	.S..MM
.S..MH	0,23	0,54	0,85	0,17	0,39	0,61	0,13	0,29	0,46	0,11	0,25	0,40	0,10	0,23	0,36	.S..MH

NOTE: Use "Light Machining" value as starting feed rate.



M300 Series

M300, M300+ Helical Mills

The M300 Series helical mill is a dependable, general-purpose series designed to provide high metal removal rates and consistent performance.

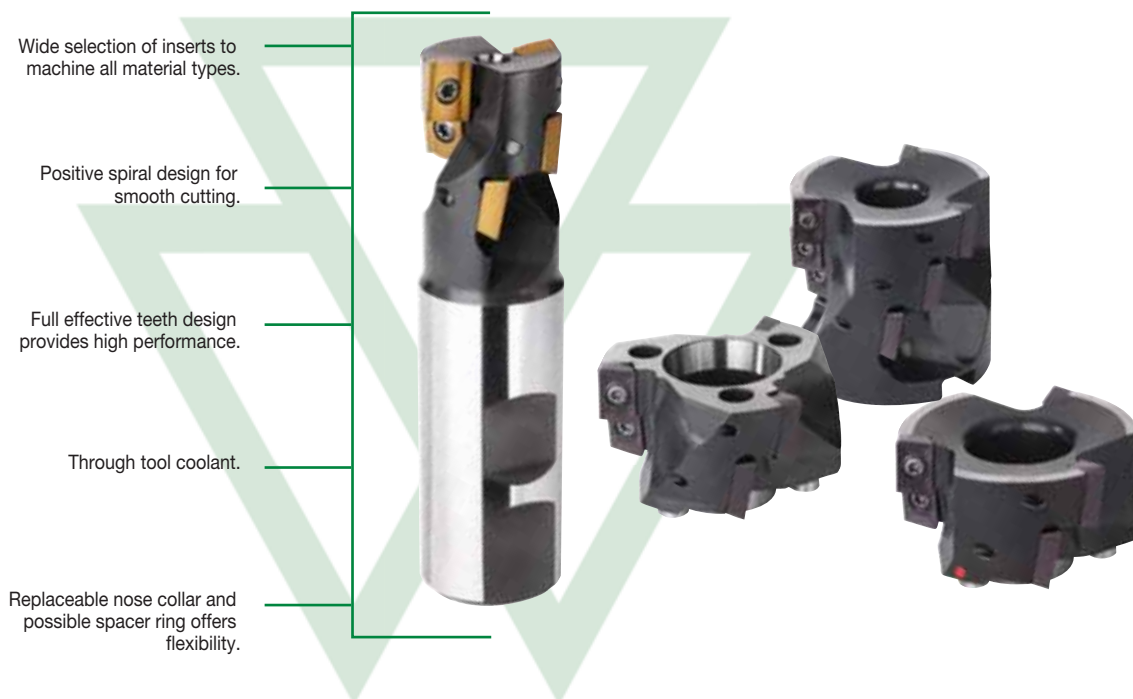

INSERTS

M300+

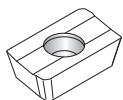

-ALP

First choice for aluminum and non-ferrous alloy machining.

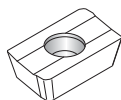

-AL

First choice for aluminum and non-ferrous alloy machining.

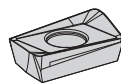

-GE

First choice for light machining in steel, stainless steel, and cast iron.

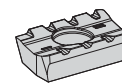

-MR

First choice for heavy machining and unstable conditions.

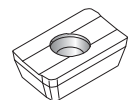

-XP.16

First choice for general machining operations in steel and cast iron.

RELIABLE OPTION FOR GENERAL-PURPOSE HELICAL MILLING

PRODUCT

SERIES

M300

DIAMETER RANGE

50–80mm

SHANK TYPES

Helical End Mills

INDUSTRY



APPLICATIONS



SIDE MILLING/
SHOULDER
MILLING:
SQUARE END



FACE
MILLING



SLOTING:
SQUARE END

MAXIMUM CUTTING DEPTH (AP1) AND CONTACT WIDTH (AE) RATIOS BASED ON APPLICATION TYPE

SLOT MILLING

$$ae = 1 \times D_1$$

$$Ap1 \text{ max} = 0,6 \times D_1$$

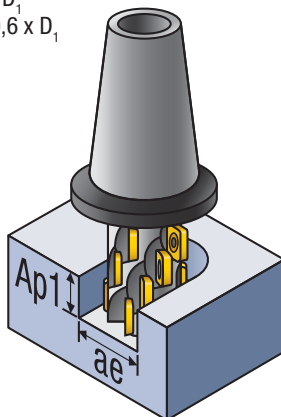

*Not recommended in ISO "H" materials.

CONTOURING

$$ae = 0,25-0,4 \times D_1$$

$$Ap1 \text{ max} = 1 \times D_1$$

$$ae = >0,4 \times D_1$$

$$Ap1 \text{ max} = 0,6 \times D_1$$

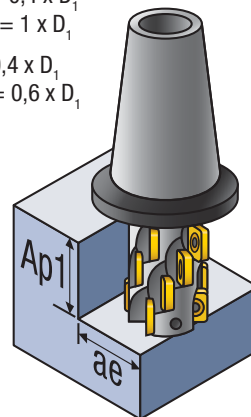

*Not recommended in ISO "H" materials.

PROFILING

$$ae = <0,25 \times D_1$$

$$Ap1 \text{ max} = Ap1 \text{ max}$$

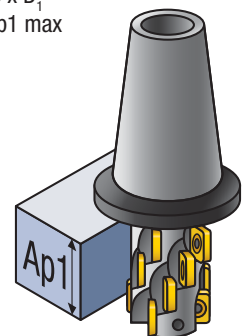

M300+ • Weldon® Shank • Metric

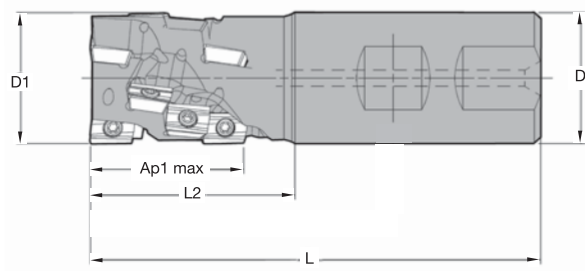

order number	catalogue number	D1	D	L	L2	Ap1 max	Z	Z U	max RPM	coolant supply	kg
2021407	12393001200	25	25	96	40	28,0	6	2	26100	Yes	0,3
2021408	12393001400	32	32	110	50	37,0	12	3	23000	Yes	0,6
2021409	12393001600	40	32	120	60	46,0	15	3	20600	Yes	0,7

NOTE: Standard milling cutters will accept insert nose radii up to 2mm without modification. For tool body modification instructions, see page A114.

FOR SPARE PARTS, PLEASE VISIT WIDIA.COM OR WIDIANOVO.COM.
MOUNTING SCREWS ARE NOT INCLUDED IN STANDARD PACKAGING.

M300+ • AONT-ML

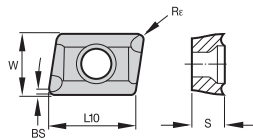
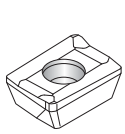

- first choice
- alternate choice

P	●									●	●	●	●	●	●	●	●	○	○
M	●																		
K	●	○	○	○	○	○	○	○	○	○	○	○	○	○	○	○	○	○	○
N	●	○	○	○	○	○	○	○	○	○	○	○	○	○	○	○	○	○	○
S	○	○	○	○	○	○	○	○	○	○	○	○	○	○	○	○	○	○	○
H	○	○	○	○	○	○	○	○	○	○	○	○	○	○	○	○	○	○	○

catalogue number	cutting edges	W	L10	S	BS	Rε	hm	THM	THM-U	THR	TN6501	TN6502	TN6510	TN6520	TN6525	TN6540	TT125	TTM08	WK15CM	WP35CM	WP40PM	WS30PM	WU20PM	
AONT10T308ML	2	7,50	10,37	3,92	1,00	0,80	0,08	2031642																

M300+ • AONT-MH

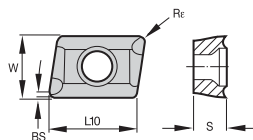
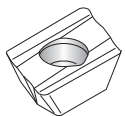

- first choice
- alternate choice

P	●																							
M	●																							
K	●	○	○	○	○	○	○	○	○	○	○	○	○	○	○	○	○	○	○	○	○	○	○	○
N	●	○	○	○	○	○	○	○	○	○	○	○	○	○	○	○	○	○	○	○	○	○	○	○
S	○	○	○	○	○	○	○	○	○	○	○	○	○	○	○	○	○	○	○	○	○	○	○	○
H	○	○	○	○	○	○	○	○	○	○	○	○	○	○	○	○	○	○	○	○	○	○	○	○

catalogue number	cutting edges	W	L10	S	BS	Rε	hm	THM	THM-U	THR	TN6501	TN6502	TN6510	TN6520	TN6525	TN6540	TT125	TTM08	WK15CM	WP35CM	WP40PM	WS30PM	WU20PM	
AONT10T308MH	2	7,54	10,44	3,97	1,00	0,80	0,12																	

M300+ • Insert Selection Guide

Material Group	Light Machining		General Purpose		Heavy Machining	
	Geometry	Grade	Geometry	Grade	Geometry	Grade
P1-P2	XPHT-GE	WP40PM	XPHT..	WP40PM	XPHT..	WP40PM
P3-P4	XPHT-GE	TN6540	XPHT..	WP40PM	XPHT..	WP40PM
P5-P6	XPHT-GE	TN6540	XPHT..	WP40PM	XPHT..	WP40PM
M1-M2	XPHT-GE	TN6540	XPHT..	TN6540	XPHT-MR	TN6540
M3	XPHT-GE	TN6540	XPHT..	WP40PM	XPHT-MR	TN6540
K1-K2	XPHT-GE	TN6510	XPHT..	TN6520	XPHT-MR	WK15CM
K3	XPHT-GE	TN6510	XPHT..	TN6540	XPHT-MR	WK15CM
N1-N2	XPHT-ALP	TN6501	XPHT-ALP	TN6501	XPHT-ALP	TN6501
N3	XPHT-ALP	TN6501	XPHT-ALP	TN6501	XPHT-ALP	TN6501
S1-S2	XPHT-GE	TN6540	XPHT..	TN6540	XPHT-MR	TN6540
S3	XPHT-GE	WS30PM	XPHT..	TN6540	XPHT-MR	TN6540
S4	XPHT-GE	TN6540	XPHT..	TN6540	XPHT-MR	TN6540
H1	XPHT-GE	WS30PM	XPHT..	TN6540	XPHT-MR	TN6540

M300+ • Recommended Starting Speeds [m/min]

Material Group	THR	THM-U	TN6501	TN6502	TN6510	TN6520	TN6525	TN6540	
P	0	-	-	-	-	-	-	340 265 235	300 235 200
	1	-	-	-	-	-	-	340 265 235	300 235 200
	2	-	-	-	-	-	-	265 210 180	210 160 140
	3	-	-	-	-	-	-	235 180 155	180 140 115
	4	-	-	-	-	-	-	195 140 120	150 110 90
	5	-	-	-	-	-	-	260 195 165	200 150 125
6	-	-	-	-	-	-	170 135 110	135 100 85	
M	1	-	-	-	-	-	-	160 100 65	110 65 50
	2	-	-	-	-	-	-	100 65 40	65 40 35
	3	-	-	-	-	-	-	105 65 45	70 40 35
K	1	150 135 120	190 170 150	-	-	400 290 215	375 265 190	230 205 185	185 170 150
	2	185 140 120	-	-	-	350 235 170	325 210 160	180 160 150	145 130 115
	3	105 75 50	-	-	-	280 215 165	250 190 135	150 135 120	130 120 105
N	1	900 600 500	2000 1200 1000	2000 1200 1000	1075 945 875	-	-	-	-
	2	685 465 385	1365 815 665	1365 815 665	1075 945 875	-	-	-	-
	3	450 280 200	800 500 400	800 500 400	945 875 760	-	-	-	-
S	1	35 25 20	-	-	-	-	-	-	40 30 25
	2	25 20 15	-	-	-	-	-	-	20 15 10
	3	50 40 30	-	-	-	-	-	-	60 35 25
	4	35 25 18	-	-	-	-	-	-	50 25 20
H	1	-	-	-	-	-	-	-	-
	2	-	-	-	-	-	-	-	-
	3	-	-	-	-	-	-	-	-

Material Group	TTM08	WK15PM	WP35CM	WU20PM	TTI25	THM	WK15CM	WP40PM	WS30PM	
P	0	-	-	-	-	-	-	-	-	
	1	230 200 190	-	455 395 370	330 290 270	360 300 250	-	-	295 260 245	-
	2	195 170 140	-	280 255 230	275 250 200	260 210 180	-	-	250 215 180	-
	3	180 150 125	-	255 230 205	255 220 175	260 210 180	-	-	230 195 160	-
	4	160 130 105	-	190 175 160	225 190 150	220 180 150	-	-	205 170 135	-
	5	-	-	260 230 210	185 175 150	265 195 165	-	-	170 155 135	-
6	-	-	160 135 110	165 130 100	120 90 75	-	-	150 115 90	-	
M	1	-	-	205 185 155	205 180 165	400 260 180	-	-	195 170 155	225 200 185
	2	-	-	185 160 140	185 160 130	270 170 120	-	-	175 150 125	205 180 145
	3	-	-	145 130 115	140 120 95	265 175 120	-	-	130 115 90	155 135 105
K	1	-	400 290 215	295 265 240	250 220 185	185 155 130	-	420 385 340	-	-
	2	-	350 235 170	235 210 190	200 180 150	150 120 105	-	335 295 275	-	-
	3	-	280 215 165	195 175 160	180 150 120	120 105 85	-	280 250 230	-	-
N	1	-	-	-	550 470 400	-	795 695 600	-	-	-
	2	-	-	-	550 470 400	-	795 695 600	-	-	-
	3	-	-	-	400 350 300	-	560 485 420	-	-	-
S	1	-	-	-	40 35 25	-	-	-	40 35 30	45 40 30
	2	-	-	-	40 35 25	-	-	-	40 35 30	45 40 30
	3	-	-	-	50 40 25	-	-	-	50 40 30	55 45 30
	4	-	-	66 50 33	70 50 35	-	-	-	65 50 35	85 60 40
H	1	-	-	-	110 80 70	-	-	-	-	-
	2	-	-	-	-	-	-	-	-	-
	3	-	-	-	-	-	-	-	-	-

NOTE: FIRST choice starting speeds are in bold type.
As the average chip thickness increases, the speed should be decreased.

M300+ • Recommended Starting Feeds [mm]

Light Machining	General Purpose	Heavy Machining
-----------------	-----------------	-----------------

Insert Geometry	Programmed Feed per Tooth (fz) as a % of Radial Depth of Cut (ae)															Insert Geometry
	5%			10%			20%			30%			40-100%			
XPHT-ALP	0,12	0,35	0,58	0,08	0,25	0,42	0,06	0,19	0,31	0,06	0,17	0,27	0,05	0,15	0,25	XPHT-ALP
XPHT-GE	0,19	0,47	0,70	0,14	0,34	0,50	0,11	0,26	0,38	0,09	0,22	0,33	0,08	0,20	0,30	XPHT-GE
XPHT..	0,22	0,56	0,82	0,16	0,40	0,59	0,12	0,30	0,44	0,10	0,26	0,38	0,10	0,24	0,35	XPHT..
XPNT..	0,22	0,56	0,82	0,16	0,40	0,59	0,12	0,30	0,44	0,10	0,26	0,38	0,10	0,24	0,35	XPNT..
XPHT-MR	0,23	0,59	0,92	0,17	0,43	0,66	0,13	0,32	0,50	0,11	0,28	0,43	0,10	0,25	0,40	XPHT-MR

NOTE: Use "Light Machining" value as starting feed rate.

M300 • Integral • Metric

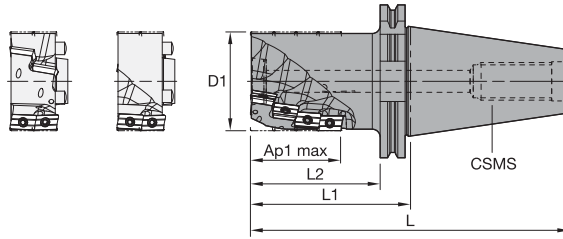

order number	catalogue number	D1	L	L1	L2	Ap1 max	Z	Z U	CSMS system size	max RPM	coolant supply	kg
2021419	12393040200	50	217	115	96	70,0	9	3	DV50	13090	Yes	3,7
2021420	12393040400	63	232	130	111	84,0	12	3	DV50	11690	Yes	4,3
2021421	12393040800	80	257	155	136	112,0	24	4	DV50	10360	Yes	6,0

NOTE: Standard milling cutters will accept insert nose radii up to 2mm without modification.
 For tool body modification instructions, see page A114.
 Z = number of pocket seats.
 ZU = number of effective teeth.

M300 • Shell Mills • Metric

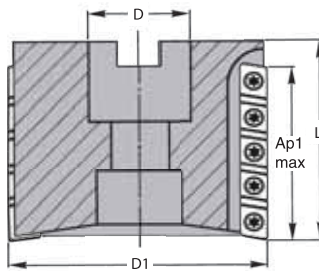

order number	catalogue number	D1	D	L	Ap1 max	Z	Z U	max RPM	coolant supply	kg
2021434	12393080200	50	22	50	28,0	6	3	13090	No	0,4
2021437	12393083200	50	22	65	42,0	12	4	13090	No	0,5
2021435	12393080400	63	27	61	42,0	9	3	11690	No	0,8
2021438	12393083400	63	27	75	56,0	20	5	11690	No	1,0
2021436	12393080600	80	32	70	56,0	16	4	10360	No	1,5
2021439	12393083600	80	32	85	70,0	30	6	10360	No	2,0

NOTE: Standard milling cutters will accept insert nose radii up to 2mm without modification.
 For tool body modification instructions, see page A114.
 Z = number of pocket seats.
 ZU = number of effective teeth.

FOR SPARE PARTS, PLEASE VISIT WIDIA.COM OR WIDIANOVO.COM.
 MOUNTING SCREWS ARE NOT INCLUDED IN STANDARD PACKAGING.

M300 • End Cap • Metric

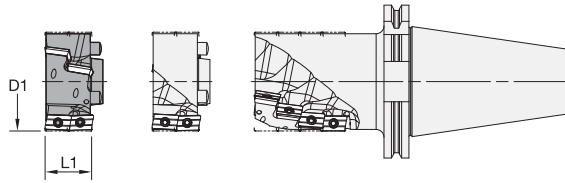

order number	catalogue number	D1	L1	Z U	Z	kg
2021431	12393060200	50	29	3	6	0,3
2021432	12393060400	63	29	3	6	0,4
2021433	12393060800	80	29	4	8	0,7

NOTE: Z = number of pocket seats.
ZU = number of effective teeth.

M300 • Extension Unit • Metric

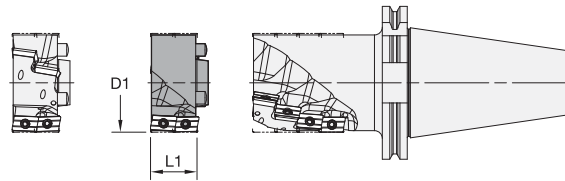

order number	catalogue number	D1	L1	Z U	Z	kg
2021425	12393050200	50	28	3	6	0,3
2021426	12393050400	63	28	3	6	0,3

NOTE: One spacer ring can be added to any M300 integral tool body assembly with matching D1.
Standard assembly cap screw must be replaced with the following part for correct mounting bolt length:
50mm — use longer socket head cap screw #12146030700 (M12 x 70).
63mm and 80mm — use longer socket head cap screw #12146030800 (M16 x 70).
Z = number of pocket seats.
ZU = number of effective teeth.

FOR SPARE PARTS, PLEASE VISIT WIDIA.COM OR WIDIANOVO.COM.
MOUNTING SCREWS ARE NOT INCLUDED IN STANDARD PACKAGING.

M300 • XPHT-ALP

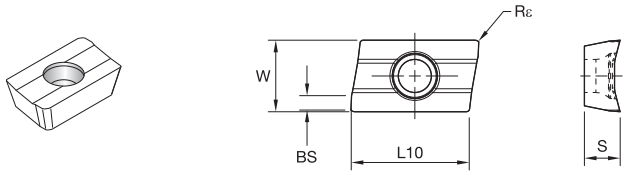

● first choice
○ alternate choice

P	■	■	■	■	■	■	■	■	■	■	■	■	■	■	■	■	■	■	■
M	■	■	○	○	○	○	○	○	○	○	○	○	○	○	○	○	○	○	○
K	○	○	○	○	○	○	○	○	○	○	○	○	○	○	○	○	○	○	○
N	○	○	○	○	○	○	○	○	○	○	○	○	○	○	○	○	○	○	○
S	○	○	○	○	○	○	○	○	○	○	○	○	○	○	○	○	○	○	○
H	○	○	○	○	○	○	○	○	○	○	○	○	○	○	○	○	○	○	○

catalogue number	cutting edges	W	L10	S	BS	R ϵ	hm	THM	THM-U	THR	TN6501	TN6502	TN6510	TN6520	TN6525	TN6540	TTI25	TTM08	WK15CM	WP35CM	WP40PM	WS30PM	WU20PM
XPHT160404ALP	2	9,80	15,67	4,66	1,70	0,40	0,08	-	2031794	-	-	-	-	-	-	-	-	-	-	-	-	-	-
XPHT160408ALP	2	9,80	15,67	4,66	1,70	0,80	0,08	-	2031797	-	2964136	-	-	-	-	-	-	-	-	-	-	-	-
XPHT160412ALP	2	9,80	15,67	4,66	1,40	1,20	0,08	-	2031799	-	-	-	-	-	-	-	-	-	-	-	-	-	-

INDEXABLE MILLING

SOLID END MILLING

HOLE/MAKING

TAPPING

TURNING

Helical Mills • M300 Series

INDEXABLE MILLING

M300 • XPHT-AL

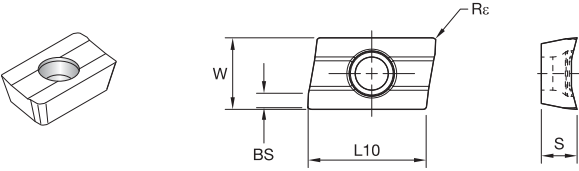

- first choice
- alternate choice

P	■						●	●	●	●	●	●	●	●	●	●	●
M	■						○	○	○	○	○	○	○	○	○	○	○
K	■	○	○	○	○	○	○	○	○	○	○	○	○	○	○	○	○
N	■	●	○	○	○	○	○	○	○	○	○	○	○	○	○	○	○
S	■	○	○	○	○	○	○	○	○	○	○	○	○	○	○	○	○
H	■	○	○	○	○	○	○	○	○	○	○	○	○	○	○	○	○

SOLID END MILLING

catalogue number	cutting edges	W	L10	S	BS	Rε	hm	THM	THM-U	THR	TN6501	TN6502	TN6510	TN6520	TN6525	TN6540	TT125	TTM08	WK15CM	WP35CM	WP40PM	WS30PM	WU20PM	
XPHT160408AL	2	9,80	15,67	4,66	1,70	0,80	0,08	2031796	2031796	■	■	■	○	○	○	○	○	○	○	○	○	○	○	○
XPHT160412AL	2	9,80	15,67	4,66	1,40	1,20	0,08	2031798	2031798	■	■	■	○	○	○	○	○	○	○	○	○	○	○	○
XPHT160416AL	2	9,80	15,67	4,66	0,90	1,60	0,08	2031801	2031801	■	■	■	○	○	○	○	○	○	○	○	○	○	○	○
XPHT160420AL	2	9,80	15,67	4,66	1,20	2,00	0,08	2031802	2031802	■	■	■	○	○	○	○	○	○	○	○	○	○	○	○
XPHT160425AL	2	9,80	15,67	4,66	1,20	2,50	0,08	2029067	2029067	■	■	■	○	○	○	○	○	○	○	○	○	○	○	○
XPHT160432AL	2	9,80	15,67	4,66	1,20	3,18	0,08	2031804	2031804	■	■	■	○	○	○	○	○	○	○	○	○	○	○	○
XPHT160440AL	2	9,80	15,67	4,66	1,20	4,00	0,08	2029073	2029073	■	■	■	○	○	○	○	○	○	○	○	○	○	○	○

HOLEMAKING

TAPPING

M300 • XPHT-GE

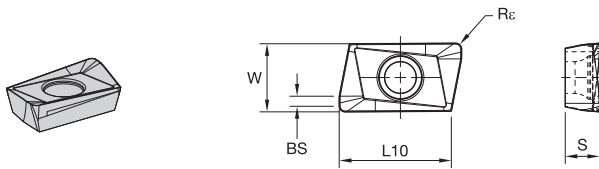

- first choice
- alternate choice

P	■						●	●	●	●	●	●	●	●	●	●	●
M	■						○	○	○	○	○	○	○	○	○	○	○
K	■	○	○	○	○	○	○	○	○	○	○	○	○	○	○	○	○
N	■	●	○	○	○	○	○	○	○	○	○	○	○	○	○	○	○
S	■	○	○	○	○	○	○	○	○	○	○	○	○	○	○	○	○
H	■	○	○	○	○	○	○	○	○	○	○	○	○	○	○	○	○

catalogue number	cutting edges	W	L10	S	BS	Rε	hm	THM	THM-U	THR	TN6501	TN6502	TN6510	TN6520	TN6525	TN6540	TT125	TTM08	WK15CM	WP35CM	WP40PM	WS30PM	WU20PM	
XPHT160408ERGE	2	9,44	15,67	4,76	1,80	0,80	0,12	■	■	■	■	■	○	○	○	○	○	○	○	○	○	○	○	○
XPHT160412ERGE	2	9,44	15,67	4,76	1,50	1,20	0,12	■	■	■	■	■	○	○	○	○	○	○	○	○	○	○	○	○

TURNING

M300 • XPHT

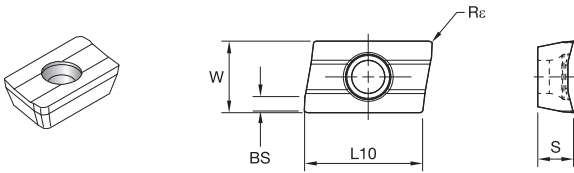

● first choice
○ alternate choice

P	■							●	●	●	●	●	●	●	○	○	○	○
M	■							○	○	○	○	○	○	○	○	○	○	○
K	■	○	○	○	○	○	○	○	○	○	○	○	○	○	○	○	○	○
N	■	○	○	○	○	○	○	○	○	○	○	○	○	○	○	○	○	○
S	■	○	○	○	○	○	○	○	○	○	○	○	○	○	○	○	○	○
H	■																	

catalogue number	cutting edges	W	L10	S	BS	R _ε	hm	THM	THM-U	THR	TN6501	TN6502	TN6510	TN6520	TN6525	TN6540	TT125	TTM08	WK15CM	WP35CM	WP40PM	WS30PM	WU20PM	
XPHT160408	2	9,53	15,67	4,76	1,80	0,80	0,16	■	■	■	■	■	■	■	■	■	■	■	■	■	■	■	■	■
XPHT160412	2	9,53	15,67	4,76	1,50	1,20	0,16	2025362	■	2029049	■	■	■	2964169	2964167	2964180	■	■	■	■	■	■	■	■
XPHT160416	2	9,53	15,67	4,76	0,80	1,60	0,16	■	■	■	■	■	■	■	■	2964166	■	■	■	■	■	■	■	■
XPHT160420	2	9,53	15,67	4,76	0,50	2,00	0,16	■	■	■	■	■	■	■	■	■	■	■	■	■	■	■	■	■
XPHT160425	2	9,53	15,67	4,76	1,20	2,50	0,16	■	■	■	■	■	■	■	■	■	■	■	■	■	■	■	■	■
XPHT160432	2	9,53	15,67	4,76	1,20	3,17	0,16	■	■	■	■	■	■	■	■	■	■	■	■	■	■	■	■	■
XPHT160440	2	9,53	15,67	4,76	1,20	4,00	0,16	■	■	■	■	■	■	■	■	■	■	■	■	■	■	■	■	■

M300 • XPNT

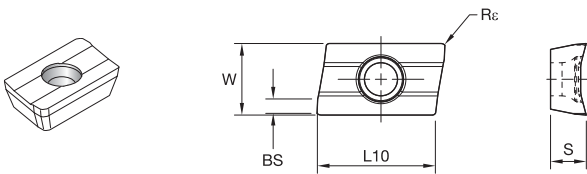

● first choice
○ alternate choice

P	■							●	●	●	●	●	●	●	○	○	○	○
M	■							○	○	○	○	○	○	○	○	○	○	○
K	■	○	○	○	○	○	○	○	○	○	○	○	○	○	○	○	○	○
N	■	○	○	○	○	○	○	○	○	○	○	○	○	○	○	○	○	○
S	■	○	○	○	○	○	○	○	○	○	○	○	○	○	○	○	○	○
H	■																	

catalogue number	cutting edges	W	L10	S	BS	R _ε	hm	THM	THM-U	THR	TN6501	TN6502	TN6510	TN6520	TN6525	TN6540	TT125	TTM08	WK15CM	WP35CM	WP40PM	WS30PM	WU20PM	
XPNT160412	2	9,53	15,88	4,79	1,20	1,20	0,16	■	■	■	■	■	■	■	2964141	2964174	■	■	■	■	■	■	■	■

M300 • XPHT-MR

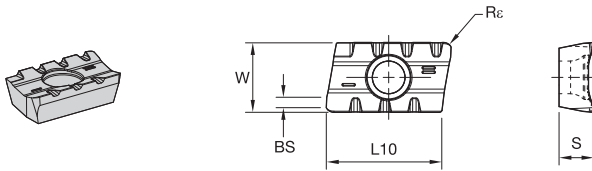

- first choice
- alternate choice

	P	M	K	N	S	H																	
	●	●	○	○	○	○	○	○	○	○	○	○	○	○	○	○	○	○	○	○	○	○	○
	○	○	○	○	○	○	○	○	○	○	○	○	○	○	○	○	○	○	○	○	○	○	
	○	○	○	○	○	○	○	○	○	○	○	○	○	○	○	○	○	○	○	○	○	○	
	○	○	○	○	○	○	○	○	○	○	○	○	○	○	○	○	○	○	○	○	○	○	
	○	○	○	○	○	○	○	○	○	○	○	○	○	○	○	○	○	○	○	○	○	○	
	○	○	○	○	○	○	○	○	○	○	○	○	○	○	○	○	○	○	○	○	○	○	
	○	○	○	○	○	○	○	○	○	○	○	○	○	○	○	○	○	○	○	○	○	○	
	○	○	○	○	○	○	○	○	○	○	○	○	○	○	○	○	○	○	○	○	○	○	
	○	○	○	○	○	○	○	○	○	○	○	○	○	○	○	○	○	○	○	○	○	○	
	○	○	○	○	○	○	○	○	○	○	○	○	○	○	○	○	○	○	○	○	○	○	
	○	○	○	○	○	○	○	○	○	○	○	○	○	○	○	○	○	○	○	○	○	○	
	○	○	○	○	○	○	○	○	○	○	○	○	○	○	○	○	○	○	○	○	○	○	
	○	○	○	○	○	○	○	○	○	○	○	○	○	○	○	○	○	○	○	○	○	○	
	○	○	○	○	○	○	○	○	○	○	○	○	○	○	○	○	○	○	○	○	○	○	
	○	○	○	○	○	○	○	○	○	○	○	○	○	○	○	○	○	○	○	○	○	○	
	○	○	○	○	○	○	○	○	○	○	○	○	○	○	○	○	○	○	○	○	○	○	

catalogue number	cutting edges	W	L10	S	BS	R _ε	hm	THM	THM-U	THR	TN6501	TN6502	TN6510	TN6520	TN6525	TN6540	TTI25	TTM08	WK15CM	WP35CM	WP40PM	WS30PM	WU20PM
XPHT160412MR	2	9,53	15,77	4,76	1,70	1,20	0,18	○	○	○	○	○	○	○	○	○	○	○	○	○	○	○	○

M300 • Insert Selection Guide

Material Group	Light Machining		General Purpose		Heavy Machining	
	Geometry	Grade	Geometry	Grade	Geometry	Grade
P1-P2	XPHT-GE	WP40PM	XPHT..	WP40PM	XPHT..	WP40PM
P3-P4	XPHT-GE	TN6540	XPHT..	WP40PM	XPHT..	WP40PM
P5-P6	XPHT-GE	TN6540	XPHT..	WP40PM	XPHT..	WP40PM
M1-M2	XPHT-GE	TN6540	XPHT..	TN6540	XPHT-MR	TN6540
M3	XPHT-GE	TN7535	XPHT..	WP40PM	XPHT-MR	TN7535
K1-K2	XPHT-GE	TN6510	XPHT..	TN6520	XPHT-MR	WK15CM
K3	XPHT-GE	TN6510	XPHT..	TN7535	XPHT-MR	WK15CM
N1-N2	XPHT-ALP	TN6501	XPHT-ALP	TN6501	XPHT-ALP	TN6501
N3	XPHT-ALP	TN6501	XPHT-ALP	TN6501	XPHT-ALP	TN6501
S1-S2	XPHT-GE	TN6540	XPHT..	TN6540	XPHT-MR	TN6540
S3	XPHT-GE	WS30PM	XPHT..	TN6540	XPHT-MR	TN6540
S4	XPHT-GE	TN6540	XPHT..	TN6540	XPHT-MR	TN6540
H1	XPHT-GE	WS30PM	XPHT..	TN6540	XPHT-MR	TN6540

M300 • Recommended Starting Speeds [m/min]

Material Group		THR	THM-U	TN6501	TN6502	TN6510	TN6520	TN6525	TN6540
P	0	-	-	-	-	-	-	340 265 235	300 235 200
	1	-	-	-	-	-	-	340 265 235	300 235 200
	2	-	-	-	-	-	-	265 210 180	210 160 140
	3	-	-	-	-	-	-	235 180 155	180 140 115
	4	-	-	-	-	-	-	195 140 120	150 110 90
	5	-	-	-	-	-	-	260 195 165	200 150 125
6	-	-	-	-	-	-	170 135 110	135 100 85	
M	1	-	-	-	-	-	-	160 100 65	110 65 50
	2	-	-	-	-	-	-	100 65 40	65 40 35
	3	-	-	-	-	-	-	105 65 45	70 40 35
K	1	150 135 120	190 170 150	-	-	400 290 215	375 265 190	230 205 185	185 170 150
	2	185 140 120	-	-	-	350 235 170	325 210 160	180 160 150	145 130 115
	3	105 75 50	-	-	-	280 215 165	250 190 135	150 135 120	130 120 105
N	1	900 600 500	2000 1200 1000	2000 1200 1000	1075 945 875	-	-	-	-
	2	685 465 385	1365 815 665	1365 815 665	1075 945 875	-	-	-	-
	3	450 280 200	800 500 400	800 500 400	945 875 760	-	-	-	-
S	1	35 25 20	-	-	-	-	-	-	40 30 25
	2	25 20 15	-	-	-	-	-	-	20 15 10
	3	50 40 30	-	-	-	-	-	-	60 35 25
	4	35 25 18	-	-	-	-	-	-	50 25 20
H	1	-	-	-	-	-	-	-	-
	2	-	-	-	-	-	-	-	-
	3	-	-	-	-	-	-	-	-

Material Group		TTM08	WK15PM	WP35CM	WU20PM	TTI25	THM	WK15CM	WP40PM	WS30PM
P	0	-	-	-	-	360 300 250	-	-	295 260 245	-
	1	230 200 190	-	455 395 370	330 290 270	360 300 250	-	-	295 260 245	-
	2	195 170 140	-	280 255 230	275 250 200	260 210 180	-	-	250 215 180	-
	3	180 150 125	-	255 230 205	255 220 175	260 210 180	-	-	230 195 160	-
	4	160 130 105	-	190 175 160	225 190 150	220 180 150	-	-	205 170 135	-
	5	-	-	260 230 210	185 175 150	265 195 165	-	-	170 155 135	-
6	-	-	160 135 110	165 130 100	120 90 75	-	-	150 115 90	-	
M	1	-	-	205 185 155	205 180 165	400 260 180	-	-	195 170 155	225 200 185
	2	-	-	185 160 140	185 160 130	270 170 120	-	-	175 150 125	205 180 145
	3	-	-	145 130 115	140 120 95	265 175 120	-	-	130 115 90	155 135 105
K	1	-	400 290 215	295 265 240	250 220 185	185 155 130	-	420 385 340	-	-
	2	-	350 235 170	235 210 190	200 180 150	150 120 105	-	335 295 275	-	-
	3	-	280 215 165	195 175 160	180 150 120	120 105 85	-	280 250 230	-	-
N	1	-	-	-	550 470 400	-	795 695 600	-	-	-
	2	-	-	-	550 470 400	-	795 695 600	-	-	-
	3	-	-	-	400 350 300	-	560 485 420	-	-	-
S	1	-	-	-	40 35 25	-	-	-	40 35 30	45 40 30
	2	-	-	-	40 35 25	-	-	-	40 35 30	45 40 30
	3	-	-	-	50 40 25	-	-	-	50 40 30	55 45 30
	4	-	-	66 50 33	70 50 35	-	-	-	65 50 35	85 60 40
H	1	-	-	-	110 80 70	-	-	-	-	-
	2	-	-	-	-	-	-	-	-	-
	3	-	-	-	-	-	-	-	-	-

NOTE: FIRST choice starting speeds are in **bold** type.
As the average chip thickness increases, the speed should be decreased.

M300 • Recommended Starting Feeds [mm]

Light Machining	General Purpose	Heavy Machining
-----------------	-----------------	-----------------

Insert Geometry	Programmed Feed per Tooth (fz) as a % of Radial Depth of Cut (ae)															Insert Geometry
	5%			10%			20%			30%			40-100%			
XPHT-ALP	0,12	0,35	0,58	0,08	0,25	0,42	0,06	0,19	0,31	0,06	0,17	0,27	0,05	0,15	0,25	XPHT-ALP
XPHT-GE	0,19	0,47	0,70	0,14	0,34	0,50	0,11	0,26	0,38	0,09	0,22	0,33	0,08	0,20	0,30	XPHT-GE
XPHT..	0,22	0,56	0,82	0,16	0,40	0,59	0,12	0,30	0,44	0,10	0,26	0,38	0,10	0,24	0,35	XPHT..
XPNT..	0,22	0,56	0,82	0,16	0,40	0,59	0,12	0,30	0,44	0,10	0,26	0,38	0,10	0,24	0,35	XPNT..
XPHT-MR	0,23	0,59	0,92	0,17	0,43	0,66	0,13	0,32	0,50	0,11	0,28	0,43	0,10	0,25	0,40	XPHT-MR

NOTE: Use "Light Machining" value as starting feed rate.

Slotting Mills

Find the offering of slotting mills at widia.com



M16 T-SLOTTING

Designed for maximum chip evacuation and optimum security, the M16 slot mill series is an excellent choice for T-slot milling of steel and cast iron materials.

APPLICATIONS

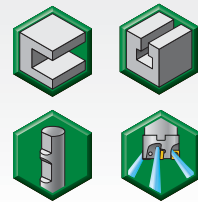

M94 PRECISE SLOTTING AND GROOVING

Designed for the most demanding small width slotting and grooving operations, the M94 slot mill series is an excellent choice for thin slotting and grooving of steel, stainless steel, and cast iron materials.

APPLICATIONS

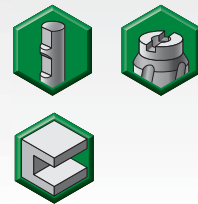

M95 SQUARE STYLE INSERT SLOTTING

The M95 slotting cutter is designed for deeper applications that require the cutting load to be shared from one insert to the other. Use in steel, stainless steel, and cast iron materials.

APPLICATIONS

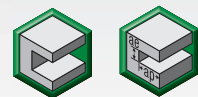

M900 ADJUSTABLE SLOTTING

The M900 slotting cutter is a multipurpose slotting cutter with high-precision capabilities in numerous operations. Use on steel, stainless steel, cast iron, and superalloys.

APPLICATIONS

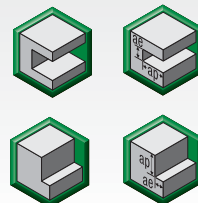



M16

M16 T-Slotting Mill

Use the M16 T-slot mill to create slots in steel and cast iron materials.



CPNT



Inserts with positive chipbreaker providing low cutting forces.

SMOOTH

The optimized chip gash design provides smooth chip evacuation.

SECURE

The strong and rigid tool body is reliable when machining steel and cast iron.

SMOOTH AND SECURE WITH M16

PRODUCT

SERIES

M16

DIAMETER RANGE

25–50mm

Slot Width Range:
11–21,9mm

SHANK TYPES

Weldon® End Mills

INDUSTRY



APPLICATIONS



SLOTTING:
SIDE



SLOTTING: T



WELDON
SHANK:
WELDON 2
FLAT



THROUGH
COOLANT:
MILLING

T-SLOTTING

STEEL

- If machining a vertical slot, minimize depth; reference Figure 1. If the depth is greater than Figure 1, chip evacuation problems could occur.
- Vibrations could occur when the T-slot cutter diameter increases; use Figure 1 as the starting point. If vibrations are a concern, adopt the Figure 2 solution.

CAST IRON

- Fewer problems with chip evacuation and reduced cutting forces enable deeper vertical slots as shown in Figures 2 and 3.

FIGURE 1

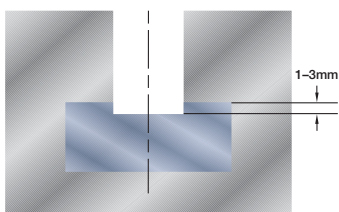

FIGURE 2

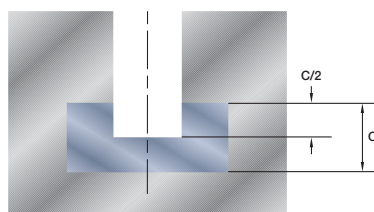
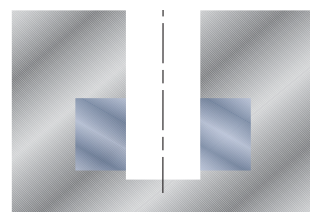
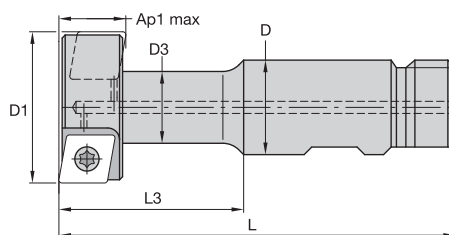

FIGURE 3



NOTE: Air blast is recommended to disperse the chips.

M16 • Weldon® Shank • Metric



order number	catalogue number	D1	D	D3	L	L3	Ap1 max	Z	Z U	insert 1	coolant supply	kg
2021380	12391602600M	25	16	13	80	32	11,0	4	2	CPNT060204T	Yes	0,1
2021381	12391603000	32	16	15	90	42	13,9	4	2	CPNT080308T	Yes	0,2
2021382	12391603400	40	25	19	105	49	17,9	4	2	CPNT09T308T	Yes	0,4
2021383	12391603800	50	32	25	120	60	21,9	4	2	CPNT120408T	Yes	0,7

NOTE: Z = number of pocket seats.
ZU = number of effective teeth.

FOR SPARE PARTS, PLEASE VISIT WIDIA.COM OR WIDIANOVO.COM.
MOUNTING SCREWS ARE NOT INCLUDED IN STANDARD PACKAGING.

M16 • CPNT • CP0602..

- first choice
- alternate choice

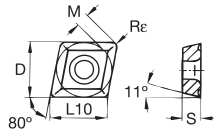
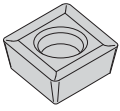

P	●	●	●	●	●
M	●	●	●	●	●
K	○	○	○	○	○
N	●	○	○	○	○
S	○	○	○	○	○
H	○	○	○	○	○

catalogue number	cutting edges	D	L10	M	S	Rε	hm	THM	TTM08	WK15CM	WP35CM	WP40PM
CPNT060204T	2	6,35	6,45	1,54	2,38	0,40	0,09	2022086	●	●	●	●
CPNT060204T	2	6,35	6,45	1,54	2,38	0,40	0,03	●	●	5903680	5903676	5578222

M16 • CPNT • CP0803..

- first choice
- alternate choice

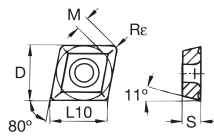
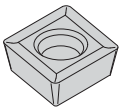

P	●	●	●	●	●
M	●	●	●	●	●
K	○	○	○	○	○
N	●	○	○	○	○
S	○	○	○	○	○
H	○	○	○	○	○

catalogue number	cutting edges	D	L10	M	S	Rε	hm	THM	TTM08	WK15CM	WP35CM	WP40PM
CPNT080308T	2	7,94	8,06	1,76	3,18	0,80	0,09	2022089	●	●	●	●
CPNT080308T	2	7,94	8,06	1,76	3,18	0,80	0,04	●	●	2022090	5903701	5903677

Slotting Mills • M16 Series

INDEXABLE MILLING

M16 • CPNT • CP09T3..

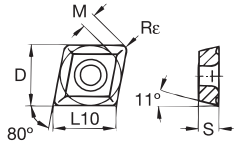
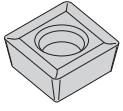

- first choice
- alternate choice

P	■	■	●	●	●
M	■	■	○	○	○
K	■	■	○	○	○
N	■	■	○	○	○
S	■	■	○	○	○
H	■	■	○	○	○

SOLID END MILLING

catalogue number	cutting edges	D	L10	M	S	Rε	hm	THM	TTM08	WK15CM	WP35CM	WP40PM
CPNT09T308T	2	9,52	9,67	2,20	3,97	0,80	0,04	■	2022092	5903702	5903678	■

HOLEMAKING

M16 • CPNT • CP1204..

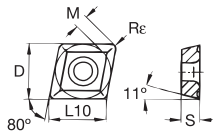
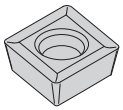

- first choice
- alternate choice

P	■	■	●	●	●
M	■	■	○	○	○
K	■	■	○	○	○
N	■	■	○	○	○
S	■	■	○	○	○
H	■	■	○	○	○

TAPPING

catalogue number	cutting edges	D	L10	M	S	Rε	hm	THM	TTM08	WK15CM	WP35CM	WP40PM
CPNT120408T	2	12,70	12,90	3,08	4,76	0,80	0,03	■	2022095	5903703	5903679	■

TURNING

M16 • Insert Selection Guide

Material Group	Light Machining		General Purpose		Heavy Machining	
	Geometry	Grade	Geometry	Grade	Geometry	Grade
P1-P2	CPNT	WP40PM	CPNT	WP40PM	CPNT	WP40PM
P3-P4	CPNT	WP35CM	CPNT	WP35CM	CPNT	WP35CM
P5-P6	CPNT	WP35CM	CPNT	WP40PM	CPNT	WP40PM
M1-M2	CPNT	WP40PM	CPNT	WP40PM	CPNT	WP40PM
M3	CPNT	TN7535	CPNT	WP35CM	CPNT	WP35CM
K1-K2	CPNT	WK15CM	CPNT	WK15CM	CPNT	WK15CM
K3	CPNT	WK15CM	CPNT	WP35CM	CPNT	WP35CM
N1-N2	-	-	-	-	-	-
N3	-	-	-	-	-	-
S1-S2	-	-	-	-	-	-
S3	-	-	-	-	-	-
S4	-	-	-	-	-	-
H1	-	-	-	-	-	-

M16 • Recommended Starting Speeds [m/min]

Material Group		THM			TTM08			WK15CM			WP35CM			WP40PM		
P	0	-	-	-	-	-	-	-	-	455	395	370	295	260	245	
	1	-	-	-	230	200	190	-	-	455	395	370	295	260	245	
	2	-	-	-	195	170	140	-	-	280	255	230	250	215	180	
	3	-	-	-	180	150	125	-	-	255	230	205	230	195	160	
	4	-	-	-	160	130	105	-	-	190	175	160	205	170	135	
	5	-	-	-	-	-	-	-	-	260	230	210	170	155	135	
M	1	-	-	-	-	-	-	-	-	205	185	155	195	170	155	
	2	-	-	-	-	-	-	-	-	185	160	140	175	150	125	
	3	-	-	-	-	-	-	-	-	145	130	115	130	115	90	
K	1	120	90	75	-	-	-	420	385	340	295	265	240	-	-	
	2	125	100	70	-	-	-	335	295	275	235	210	190	-	-	
	3	130	95	60	-	-	-	280	250	230	195	175	160	-	-	
N	1	900	600	500	-	-	-	-	-	-	-	-	-	-	-	
	2	685	465	385	-	-	-	-	-	-	-	-	-	-	-	
	3	450	280	200	-	-	-	-	-	-	-	-	-	-	-	
S	1	-	-	-	-	-	-	-	-	-	-	-	40	35	30	
	2	-	-	-	-	-	-	-	-	-	-	-	40	35	30	
	3	-	-	-	-	-	-	-	-	-	-	-	50	40	30	
	4	-	-	-	-	-	-	-	-	66	50	33	65	50	35	
H	1	-	-	-	-	-	-	-	-	-	-	-	-	-	-	
	2	-	-	-	-	-	-	-	-	-	-	-	-	-	-	
	3	-	-	-	-	-	-	-	-	-	-	-	-	-	-	

NOTE: FIRST choice starting speeds are in **bold** type.
As the average chip thickness increases, the speed should be decreased.

M16 • Recommended Starting Feeds [mm]

Insert Geometry	Programmed Feed per Tooth (fz) as a % of Radial Depth of Cut (ae)															Insert Geometry
	Light Machining			General Purpose			Heavy Machining									
	5%	10%	20%	30%	40-100%	5%	10%	20%	30%	40-100%	5%	10%	20%	30%	40-100%	
CPNT06	0,12	0,29	0,46	0,09	0,21	0,33	0,07	0,16	0,25	0,06	0,14	0,22	0,05	0,13	0,20	CPNT06
CPNT08	0,12	0,29	0,46	0,09	0,21	0,33	0,07	0,16	0,25	0,06	0,14	0,22	0,05	0,13	0,20	CPNT08
CPNT09	0,12	0,29	0,46	0,08	0,21	0,33	0,06	0,16	0,25	0,06	0,14	0,22	0,05	0,13	0,20	CPNT09
CPNT12	0,12	0,35	0,58	0,08	0,25	0,42	0,06	0,19	0,32	0,06	0,16	0,28	0,05	0,15	0,25	CPNT12

NOTE: Use "Light Machining" value as starting feed rate.

VXF™ Series

VXF-07, VXF-09, VXF-12, VXF-16 High-Feed Mills

The VXF Series high-feed mills have a nickel-plated body and four durable cutting edges to run at high feeds in deep cavities on primarily steel, stainless steel, titanium, and high-temp alloys.

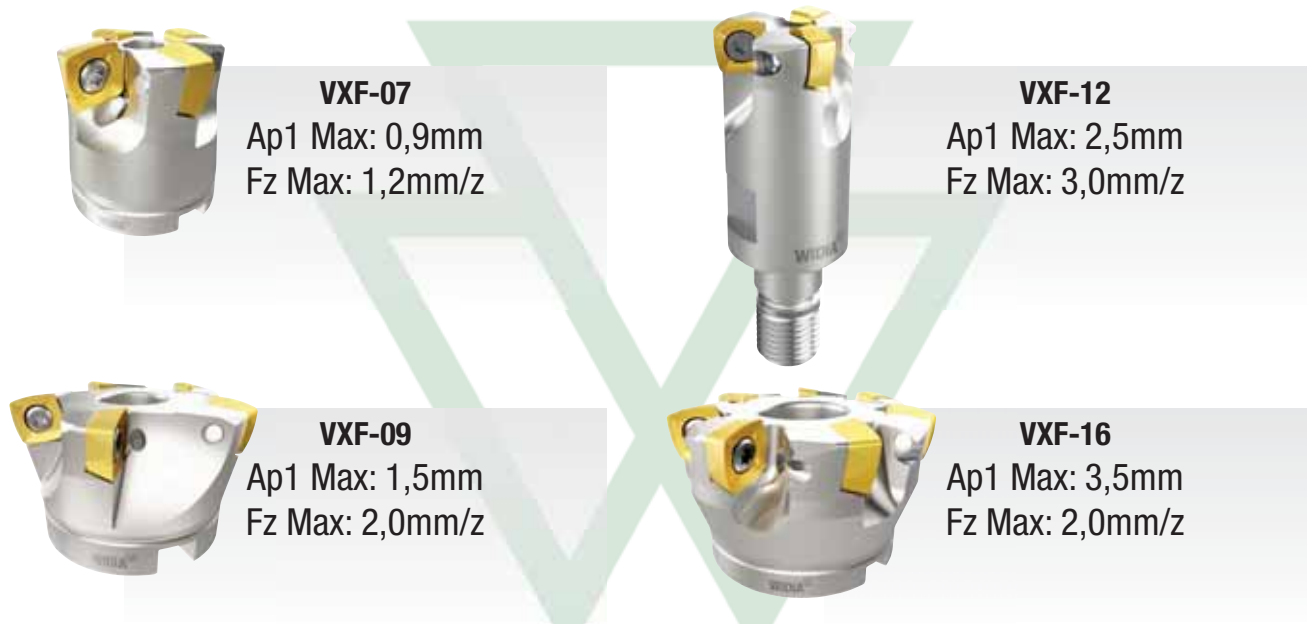

ALL-IN-ONE INSERT STYLE COMBINED FROM SQUARE AND ROUND DESIGNS TO ACHIEVE POWERFUL HIGH FEEDS

VXF-07

-MM

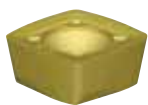

P M S

First choice for soft steel, stainless steel, and high-temp alloys. Best fit for pocketing and profiling operations.

-MH

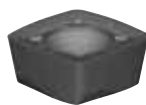

P K H

First choice for P3 and P4 materials. Stronger edge protection for heavy roughing jobs and hardened steel up to 48 HRC.

VXF-09

-MM



P M S

First choice for soft steel, stainless steel, and high-temp alloys. Best fit for pocketing and profiling operations.

-MH



P K H

First choice for P3 and P4 materials. Stronger edge protection for heavy roughing jobs.

VXF-12

-MM



P M S

First choice for soft steel, stainless steel, and high-temp alloys. Best fit for pocketing and profiling operations.

-MH

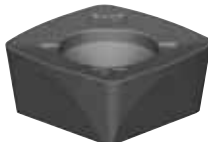

P K H

First choice for P3 and P4 materials. Stronger edge protection for heavy roughing jobs.

VXF-16

-MM



P M S

First choice for soft steel, stainless steel, and high-temp alloys. Best fit for pocketing and profiling operations.

HIGH FEEDS, DEEP CAVITIES

PRODUCT		INSERTS		
SERIES	DIAMETER RANGE	INSERT TYPE	GRADE	MATERIALS
VXF-07	16–50mm	MM, MH	WP40PM, WS40PM, WP25PM, WU10PM	P M K S H
VXF-09	25–63mm	MM, MH	WS40PM, WP25PM, WP40PM	P M S
VXF-12	32–100mm	MM, MH	WS40PM, WP25PM, WP40PM	P M K S H
VXF-16	50–125mm	MM	WS40PM, WP25PM	P M S

APPLICATIONS



FACE MILLING



3D PROFILING



POCKETING



HELICAL MILLING



RAMPING BLANK



SLOTING: TROCHOIDAL MILLING



PLUNGE MILLING

INDUSTRY



TRANSPORTATION



AEROSPACE



ENERGY



GENERAL ENGINEERING

16,5°

LEAD ANGLE

redistributes cutting forces in the spindle z-axis direction.

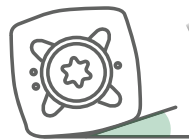

VXF-07 • Screw-On End Mills • Metric

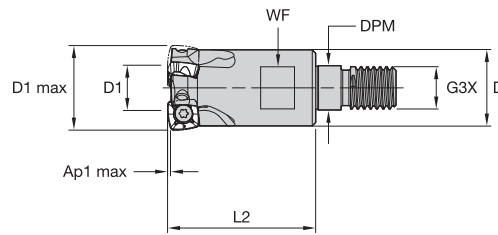

order number	catalogue number	D1 max	D1	D	DPM	G3X	L2	WF	Ap1 max	Z	max ramp angle	max RPM	coolant supply	kg
6597130	VXF016Z02M08XP07	16	7	13	8,5	M8	25	10	0,9	2	5.9°	65000	Yes	0,02
6597151	VXF020Z03M10XP07	20	11	18	10,5	M10	35	15	0,9	3	3.4°	57000	Yes	0,07
6597152	VXF025Z04M12XP07	25	16	21	12,5	M12	35	17	0,9	4	2.2°	49000	Yes	0,09
6597153	VXF032Z05M16XP07	32	23	29	17,0	M16	43	24	0,9	5	1.4°	41500	Yes	0,22

VXF-07 • Shell Mills • Metric

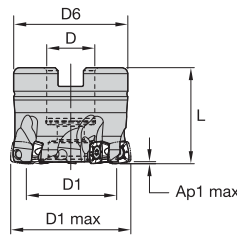

order number	catalogue number	D1 max	D1	D	D6	L	Ap1 max	Z	max ramp angle	max RPM	coolant supply	kg
6597158	VXF040Z05S16XP07	40	31	16	37	32	0,9	5	1.0°	35000	Yes	0,19
6597159	VXF050Z07S22XP07	50	41	22	42	40	0,9	7	.7°	31300	Yes	0,32

VXF-07 • Cylindrical End Mills • Metric

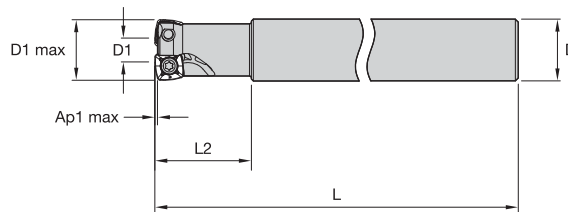

order number	catalogue number	D1 max	D1	D	L	L2	Ap1 max	Z	max ramp angle	max RPM	coolant supply	kg
6597154	VXF016Z02A16XP07L180	16	7	16	180	25	0,9	2	5.9°	65000	Yes	0,24
6597155	VXF018Z02A18XP07L180	18	9	18	180	25	0,9	2	5.4°	61000	Yes	0,31
6597156	VXF020Z03A20XP07L190	20	11	20	190	32	0,9	3	3.4°	57000	Yes	0,41
6597157	VXF025Z04A25XP07L200	25	16	25	200	40	0,9	4	2.2°	49000	Yes	0,69

FOR SPARE PARTS, PLEASE VISIT WIDIA.COM OR WIDIANOVO.COM.
MOUNTING SCREWS ARE NOT INCLUDED IN STANDARD PACKAGING.

VXF-07 • XPPT-MM

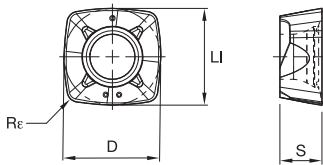
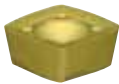

- first choice
- alternate choice

P	●	●	●	●
M	●	●	●	●
K	○	○	○	○
N	○	○	○	○
S	○	○	○	○
H	○	○	○	○

ISO catalogue number	cutting edges	LI	S	D	Re	WP25PM	WP40PM	WS40PM	WU10PM
XPPT070308ERMM	4	7,30	3,17	7,30	0,80	6595619	6595820		

VXF-07 • XPPW-MH

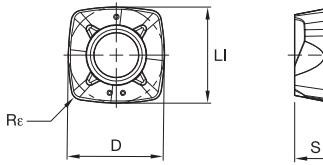
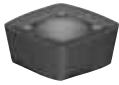

- first choice
- alternate choice

P	●	●	●	●
M	●	●	●	●
K	○	○	○	○
N	○	○	○	○
S	○	○	○	○
H	○	○	○	○

ISO catalogue number	cutting edges	LI	S	D	Re	WP25PM	WP40PM	WS40PM	WU10PM
XPPW070310SRMH	4	7,30	3,17	7,30	1,00	6595770	6595769		

VXF-07 • Insert Selection Guide

Material Group	Light Machining		General Purpose		Heavy Machining	
	Geometry	Grade	Geometry	Grade	Geometry	Grade
P1-P2	XPPT-MM	WP25PM	XPPT-MM	WS40PM	XPPW-MH	WP40PM
P3-P4	XPPT-MM	WP25PM	XPPT-MM	WS40PM	XPPW-MH	WP40PM
P5-P6	XPPT-MM	WP25PM	XPPT-MM	WS40PM	XPPW-MH	WP40PM
M1-M2	XPPT-MM	WS40PM	XPPT-MM	WS40PM	XPPW-MH	WP40PM
M3	XPPT-MM	WS40PM	XPPT-MM	WS40PM	XPPW-MH	WP40PM
K1-K2	XPPW-MH	WU10PM	XPPW-MH	WU10PM	XPPW-MH	WU10PM
K3	XPPW-MH	WU10PM	XPPW-MH	WU10PM	XPPW-MH	WU10PM
S1-S2	XPPT-MM	WP25PM	XPPT-MM	WS40PM	-	-
S3	XPPT-MM	WS40PM	XPPT-MM	WS40PM	-	-
S4	XPPT-MM	WS40PM	XPPT-MM	WS40PM	-	-
H1	XPPW-MH	WU10PM	XPPW-MH	WU10PM	-	-

VXF-07 • Recommended Starting Speeds [m/min]

Material Group		WP25PM			WP40PM			WS40PM			WU10PM		
P	1	395	340	325	355	310	295	-	-	-	-	-	
	2	330	290	240	300	260	215	-	-	-	-	-	
	3	305	260	210	275	235	190	-	-	-	-	-	
	4	270	220	180	245	205	160	-	-	-	-	-	
	5	220	205	180	205	185	160	205	175	145	-	-	
	6	200	150	120	180	140	110	180	130	95	-	-	
M	1	245	215	200	235	205	185	250	205	170	-	-	
	2	220	190	155	210	180	150	215	175	145	-	-	
	3	170	145	115	155	140	110	175	130	100	-	-	
K	1	275	245	220	-	-	-	-	-	-	355	320	290
	2	215	190	180	-	-	-	-	-	-	275	245	230
	3	180	160	145	-	-	-	-	-	-	235	210	190
S	1	50	40	30	50	40	35	50	40	30	-	-	-
	2	50	40	30	50	40	35	50	40	30	-	-	-
	3	60	50	30	60	50	35	60	50	30	-	-	-
	4	85	60	40	80	60	40	70	60	35	-	-	-
H	1	145	110	85	-	-	-	-	-	-	190	155	110

NOTE: FIRST choice starting speeds are in **bold** type. As the average chip thickness increases, the speed should be decreased.
 *Material groups P, M, K, and H show recommended starting speeds for dry machining. For wet machining, reduce speed by 20%.
 *Material groups N and S show recommended starting speeds for wet machining. Not recommended for dry machining.

VXF-07 • Recommended Starting Feeds [mm]

Light Machining	General Purpose	Heavy Machining
-----------------	-----------------	-----------------

At 0,60 Axial Depth of Cut (Ap1)

Insert Geometry	Recommended Starting Feed per Tooth (Fz) in Relation to % of Radial Engagement (ae)															Insert Geometry
	5%			10%			20%			30%			40-100%			
.E..MM	0,46	1,32	2,43	0,32	0,89	1,53	0,24	0,65	1,09	0,21	0,56	0,94	0,19	0,52	0,85	.E..MM
.S..MH	0,84	1,84	3,12	0,59	1,21	1,85	0,43	0,87	1,30	0,38	0,75	1,12	0,34	0,69	1,02	.S..MH

At 0,70 Axial Depth of Cut (Ap1)

Insert Geometry	Recommended Starting Feed per Tooth (Fz) in Relation to % of Radial Engagement (ae)															Insert Geometry
	5%			10%			20%			30%			40-100%			
.E..MM	0,42	1,21	2,20	0,30	0,83	1,41	0,22	0,60	1,01	0,19	0,52	0,87	0,18	0,48	0,79	.E..MM
.S..MH	0,78	1,68	2,79	0,55	1,12	1,71	0,40	0,81	1,21	0,35	0,70	1,04	0,32	0,64	0,94	.S..MH

At 0,90 Axial Depth of Cut (Ap1)

Insert Geometry	Recommended Starting Feed per Tooth (Fz) in Relation to % of Radial Engagement (ae)															Insert Geometry
	5%			10%			20%			30%			40-100%			
.E..MM	0,37	1,06	1,89	0,27	0,73	1,24	0,20	0,53	0,89	0,17	0,46	0,77	0,16	0,42	0,70	.E..MM
.S..MH	0,68	1,46	2,35	0,48	0,98	1,49	0,36	0,71	1,07	0,31	0,62	0,92	0,28	0,56	0,84	.S..MH

NOTE: Use "Light Machining" values as starting feed rate.

VXF-09 • Screw-On End Mills • Metric

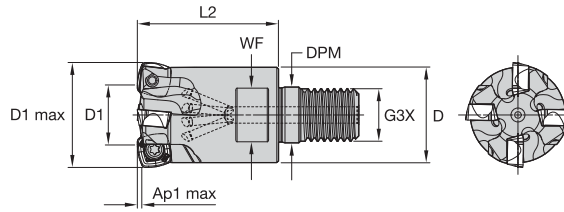

order number	catalogue number	D1 max	D1	D	DPM	G3X	L2	WF	Ap1 max	Z	max ramp angle	max RPM	coolant supply	kg
6597731	VXF025Z03M12XD09	25	11	21	12,5	M12	35	9	1,5	3	2.8°	48500	Yes	0,09
6597732	VXF032Z03M16XD09	32	18	29	17,0	M16	43	10	1,5	3	1.5°	40500	Yes	0,20
6597733	VXF032Z04M16XD09	32	18	29	17,0	M16	43	10	1,5	4	1.5°	40500	Yes	0,20
6597734	VXF035Z04M16XD09	35	21	29	17,0	M16	43	10	1,5	4	1.3°	37500	Yes	0,21
6597735	VXF042Z05M16XD09	42	28	29	17,0	M16	43	10	1,5	5	1.0°	34000	Yes	0,25

NOTE: Please order wrench separately.

VXF-09 • Weldon® End Mills • Metric

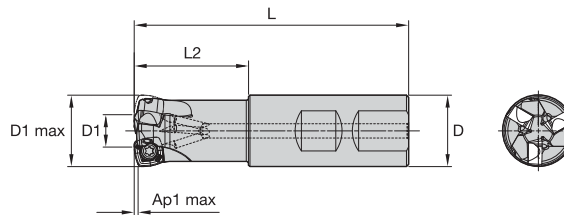
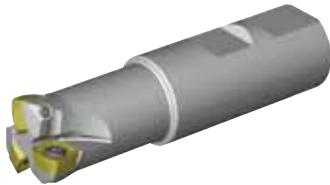

order number	catalogue number	D1 max	D1	D	L	L2	Ap1 max	Z	max ramp angle	max RPM	coolant supply	kg
6597736	VXF025Z03B25XD09	25	11	25	96	40	1,5	3	2.8°	48500	Yes	0,28
6597737	VXF032Z04B25XD09	32	18	25	96	40	1,5	4	1.5°	40500	Yes	0,36

NOTE: Please order wrench separately.

FOR SPARE PARTS, PLEASE VISIT WIDIA.COM OR WIDIANOVO.COM.
MOUNTING SCREWS ARE NOT INCLUDED IN STANDARD PACKAGING.

VXF-09 • Cylindrical End Mills • Metric

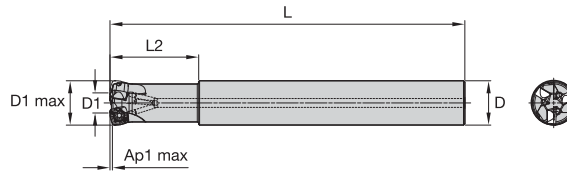

order number	catalogue number	D1 max	D1	D	L	L2	Ap1 max	Z	max ramp angle	max RPM	coolant supply	kg
6597740	VXF025Z02A25XD09L200	25	11	25	200	50	1,5	2	2.8°	48500	Yes	0,67
6597742	VXF025Z03A25XD09L200	25	11	25	200	50	1,5	3	2.8°	48500	Yes	0,67
6597743	VXF032Z03A25XD09L200	32	18	25	200	40	1,5	3	1.5°	40500	Yes	0,75
6597744	VXF032Z04A25XD09L200	32	18	25	200	40	1,5	4	1.5°	40500	Yes	0,75

NOTE: Please order wrench separately.

VXF-09 • Shell Mills • Metric

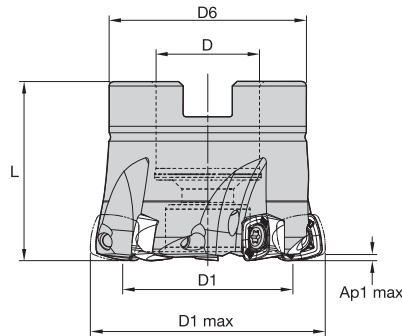

order number	catalogue number	D1 max	D1	D	D6	L	Ap1 max	Z	max ramp angle	max RPM	coolant supply	kg
6597746	VXF040Z04S16XD09	40	26	16	37	32	1,5	4	.8°	34500	Yes	0,15
6597747	VXF040Z05S16XD09	40	26	16	37	32	1,5	5	.8°	34500	Yes	0,14
6597748	VXF042Z05S16XD09	42	28	16	37	32	1,5	5	.8°	34000	Yes	0,16
6597750	VXF050Z07S22XD09	50	34	22	42	40	1,5	7	.7°	30000	Yes	0,28
6597749	VXF050Z05S22XD09	50	36	22	42	40	1,5	5	.7°	30000	Yes	0,29
6597751	VXF052Z06S22XD09	52	38	22	42	40	1,5	6	.7°	29500	Yes	0,30
6597755	VXF063Z06S22XD09	63	49	22	42	40	1,5	6	.5°	26000	Yes	0,40

NOTE: Please order wrench separately.

FOR SPARE PARTS, PLEASE VISIT WIDIA.COM OR WIDIANOVO.COM.
MOUNTING SCREWS ARE NOT INCLUDED IN STANDARD PACKAGING.

VXF-09 • XDPT-MM

- first choice
- alternate choice

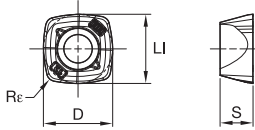

P	●	●	●	●
M	●	●	●	●
K	○	○	○	○
N	○	○	○	○
S	○	○	○	○
H	○	○	○	○

ISO catalogue number	cutting edges	LI	S	D	Rε	WP25PM	WP40PM	WS40PM
XDPT090412ERMM	4	10,00	4,76	10,00	1,20	6596471	I	6596472

VXF-09 • XDPT-MH

- first choice
- alternate choice

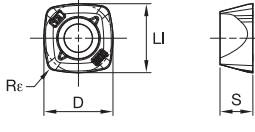

P	●	●	●	●
M	●	●	●	●
K	○	○	○	○
N	○	○	○	○
S	○	○	○	○
H	○	○	○	○

ISO catalogue number	cutting edges	LI	S	D	Rε	WP25PM	WP40PM	WS40PM
XDPT090412SRMH	4	10,00	4,76	10,00	1,20	I	6596622	I

INDEXABLE MILLING

SOLID END MILLING

HOLE/MAKING

TAPPING

TURNING

VXF-09 • Insert Selection Guide

Material Group	Light Machining		General Purpose		Heavy Machining	
	Geometry	Grade	Geometry	Grade	Geometry	Grade
P1-P2	XDPT-MM	WP25PM	XDPT-MM	WS40PM	XDPT-MH	WP40PM
P3-P4	XDPT-MM	WP25PM	XDPT-MM	WS40PM	XDPT-MH	WP40PM
P5-P6	XDPT-MM	WP25PM	XDPT-MM	WS40PM	XDPT-MH	WP40PM
M1-M2	XDPT-MM	WS40PM	XDPT-MM	WS40PM	XDPT-MH	WP40PM
M3	XDPT-MM	WS40PM	XDPT-MM	WS40PM	XDPT-MH	WP40PM
S1-S2	XDPT-MM	WP25PM	XDPT-MM	WS40PM	XDPT-MH	WP40PM
S3	XDPT-MM	WS40PM	XDPT-MM	WS40PM	XDPT-MH	WP40PM
S4	XDPT-MM	WS40PM	XDPT-MM	WS40PM	XDPT-MH	WP40PM

VXF-09 • Recommended Starting Speeds [m/min]

Material Group		WP25PM			WP40PM			WS40PM		
P	1	395	340	325	355	310	295	-	-	-
	2	330	290	240	300	260	215	-	-	-
	3	305	260	210	275	235	190	-	-	-
	4	270	220	180	245	205	160	-	-	-
	5	220	205	180	205	185	160	205	175	145
	6	200	150	120	180	140	110	180	130	95
M	1	245	215	200	235	205	185	250	205	170
	2	220	190	155	210	180	150	215	175	145
	3	170	145	115	155	140	110	175	130	100
S	1	50	40	30	50	40	35	50	40	30
	2	50	40	30	50	40	35	50	40	30
	3	60	50	30	60	50	35	60	50	30
	4	85	60	40	80	60	40	70	60	35

NOTE: FIRST choice starting speeds are in **bold** type. As the average chip thickness increases, the speed should be decreased.
 *Material groups P, M, K, and H show recommended starting speeds for dry machining. For wet machining, reduce speed by 20%.
 *Material groups N and S show recommended starting speeds for wet machining. Not recommended for dry machining.

VXF-09 • Recommended Starting Feeds [mm]

Light Machining	General Purpose	Heavy Machining
-----------------	-----------------	-----------------

At 0,90 Axial Depth of Cut (Ap1)

Insert Geometry	Recommended Starting Feed per Tooth (Fz) in Relation to % of Radial Engagement (ae)														Insert Geometry	
	5%			10%			20%			30%			40-100%			
.E..MM	0,48	1,42	2,20	0,35	1,00	1,52	0,26	0,74	1,11	0,23	0,64	0,96	0,21	0,59	0,88	.E..MM
.S..MH	0,70	1,58	2,65	0,50	1,11	1,80	0,37	0,82	1,31	0,33	0,71	1,14	0,30	0,65	1,04	.S..MH

At 1,10 Axial Depth of Cut (Ap1)

Insert Geometry	Recommended Starting Feed per Tooth (Fz) in Relation to % of Radial Engagement (ae)														Insert Geometry	
	5%			10%			20%			30%			40-100%			
.E..MM	0,44	1,28	1,98	0,32	0,90	1,37	0,24	0,67	1,01	0,21	0,58	0,87	0,19	0,53	0,80	.E..MM
.S..MH	0,64	1,42	2,37	0,45	1,00	1,63	0,34	0,74	1,19	0,30	0,64	1,03	0,27	0,59	0,94	.S..MH

At 1,50 Axial Depth of Cut (Ap1)

Insert Geometry	Recommended Starting Feed per Tooth (Fz) in Relation to % of Radial Engagement (ae)														Insert Geometry	
	5%			10%			20%			30%			40-100%			
.E..MM	0,64	1,42	2,37	0,45	1,00	1,63	0,34	0,74	1,19	0,30	0,64	1,03	0,27	0,59	0,94	.E..MM
.S..MH	0,55	1,22	2,01	0,39	0,86	1,39	0,29	0,64	1,02	0,25	0,55	0,89	0,23	0,51	0,81	.S..MH

NOTE: Use "Light Machining" values as starting feed rate.

VXF-12 • Screw-On End Mills • Metric

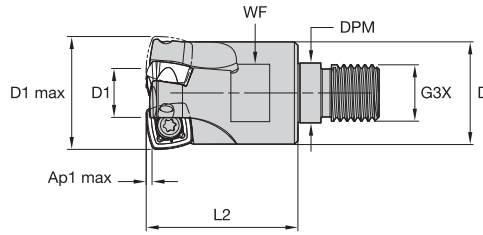

order number	catalogue number	D1 max	D1	D	DPM	G3X	L2	WF	Ap1 max	Z	max ramp angle	max RPM	coolant supply	kg
6596723	VXF032Z03M16XD12	32	14	29	17,0	M16	43	24	2,5	3	1.8°	31500	Yes	0,19

VXF-12 • Shell Mills • Metric

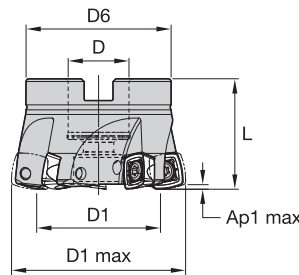

order number	catalogue number	D1 max	D1	D	D6	L	Ap1 max	Z	max ramp angle	max RPM	coolant supply	kg
6596725	VXF040Z04S22XD12	40	22	22	38	40	2,5	4	1.4°	26500	Yes	0,19
6596727	VXF042Z04S22XD12	42	24	22	38	40	2,5	4	1.3°	25500	Yes	0,21
6596728	VXF050Z04S22XD12	50	32	22	48	40	2,5	4	.9°	22500	Yes	0,31
6596729	VXF052Z05S22XD12	52	34	22	48	40	2,5	5	.8°	22000	Yes	0,32
6596730	VXF063Z05S22XD12	63	45	22	53	40	2,5	5	.6°	19500	Yes	0,47
6596732	VXF066Z06S27XD12	66	48	27	53	45	2,5	6	.5°	19000	Yes	0,55
6596733	VXF080Z06S27XD12	80	62	27	55	50	2,5	6	.5°	17000	Yes	0,87
6596734	VXF100Z07S32XD12	100	82	32	65	50	2,5	7	.3°	15000	Yes	1,34

FOR SPARE PARTS, PLEASE VISIT WIDIA.COM OR WIDIANOVO.COM.

MOUNTING SCREWS ARE NOT INCLUDED IN STANDARD PACKAGING.

VXF-12 • XDPT-MM

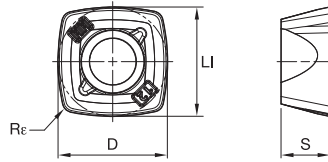

- first choice
- alternate choice

P	●	●	●
M	●	●	●
K	○	○	○
N	○	○	○
S	●	○	●
H	○	○	○

ISO catalogue number	cutting edges	LI	S	D	Re	WP25PM	WP40PM	WS40PM
XDPT120512ERMM	4	12,70	5,56	12,70	1,20	6596438	I	6596439

VXF-12 • XDPT-MH

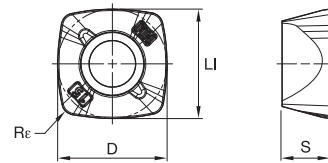
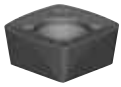

- first choice
- alternate choice

P	●	●	●
M	●	●	●
K	○	○	○
N	○	○	○
S	●	○	●
H	○	○	○

ISO catalogue number	cutting edges	LI	S	D	Re	WP25PM	WP40PM	WS40PM
XDPT120515SRMH	4	12,70	5,56	12,70	1,50	I	6596440	I

VXF-12 • Insert Selection Guide

Material Group	Light Machining		General Purpose		Heavy Machining	
	Geometry	Grade	Geometry	Grade	Geometry	Grade
P1-P2	XDPT-MM	WP25PM	XDPT-MM	WS40PM	XDPT-MH	WP40PM
P3-P4	XDPT-MM	WP25PM	XDPT-MM	WS40PM	XDPT-MH	WP40PM
P5-P6	XDPT-MM	WP25PM	XDPT-MM	WS40PM	XDPT-MH	WP40PM
M1-M2	XDPT-MM	WS40PM	XDPT-MM	WS40PM	XDPT-MH	WP40PM
M3	XDPT-MM	WS40PM	XDPT-MM	WS40PM	XDPT-MH	WP40PM
S1-S2	XDPT-MM	WP25PM	XDPT-MM	WS40PM	XDPT-MH	WP40PM
S3	XDPT-MM	WS40PM	XDPT-MM	WS40PM	XDPT-MH	WP40PM
S4	XDPT-MM	WS40PM	XDPT-MM	WS40PM	XDPT-MH	WP40PM

VXF-12 • Recommended Starting Speeds [m/min]

Material Group		WP25PM			WP40PM			WS40PM		
P	1	395	340	325	355	310	295	-	-	-
	2	330	290	240	300	260	215	-	-	-
	3	305	260	210	275	235	190	-	-	-
	4	270	220	180	245	205	160	-	-	-
	5	220	205	180	205	185	160	205	175	145
	6	200	150	120	180	140	110	180	130	95
M	1	245	215	200	235	205	185	250	205	170
	2	220	190	155	210	180	150	215	175	145
	3	170	145	115	155	140	110	175	130	100
S	1	50	40	30	50	40	35	50	40	30
	2	50	40	30	50	40	35	50	40	30
	3	60	50	30	60	50	35	60	50	30
	4	85	60	40	80	60	40	70	60	35

NOTE: FIRST choice starting speeds are in **bold** type. As the average chip thickness increases, the speed should be decreased.
 *Material groups P, M, K, and H show recommended starting speeds for dry machining. For wet machining, reduce speed by 20%.
 *Material groups N and S show recommended starting speeds for wet machining. Not recommended for dry machining.

VXF-12 • Recommended Starting Feeds [mm]

Light Machining	General Purpose	Heavy Machining
-----------------	-----------------	-----------------

At 1,30 Axial Depth of Cut (Ap1)

Insert Geometry	Recommended Starting Feed per Tooth (Fz) in Relation to % of Radial Engagement (ae)														Insert Geometry	
	5%			10%			20%			30%			40-100%			
.E..MM	0,49	1,59	2,52	0,35	1,13	1,78	0,26	0,84	1,31	0,23	0,73	1,14	0,21	0,67	1,04	.E..MM
.S..MH	0,70	1,80	2,76	0,51	1,28	1,94	0,38	0,95	1,44	0,33	0,83	1,25	0,30	0,76	1,14	.S..MH

At 1,70 Axial Depth of Cut (Ap1)

Insert Geometry	Recommended Starting Feed per Tooth (Fz) in Relation to % of Radial Engagement (ae)														Insert Geometry	
	5%			10%			20%			30%			40-100%			
.E..MM	0,43	1,39	2,20	0,31	0,99	1,56	0,23	0,74	1,15	0,20	0,64	1,00	0,19	0,59	0,92	.E..MM
.S..MH	0,62	1,57	2,41	0,45	1,12	1,70	0,33	0,84	1,26	0,29	0,73	1,10	0,27	0,67	1,00	.S..MH

At 2,50 Axial Depth of Cut (Ap1)

Insert Geometry	Recommended Starting Feed per Tooth (Fz) in Relation to % of Radial Engagement (ae)														Insert Geometry	
	5%			10%			20%			30%			40-100%			
.E..MM	0,36	1,15	1,81	0,26	0,83	1,29	0,19	0,62	0,96	0,17	0,54	0,83	0,15	0,49	0,76	.E..MM
.S..MH	0,51	1,30	1,99	0,37	0,93	1,41	0,28	0,70	1,05	0,24	0,61	0,91	0,22	0,55	0,83	.S..MH

NOTE: Use "Light Machining" values as starting feed rate.

VXF-16 • Shell Mills • Metric

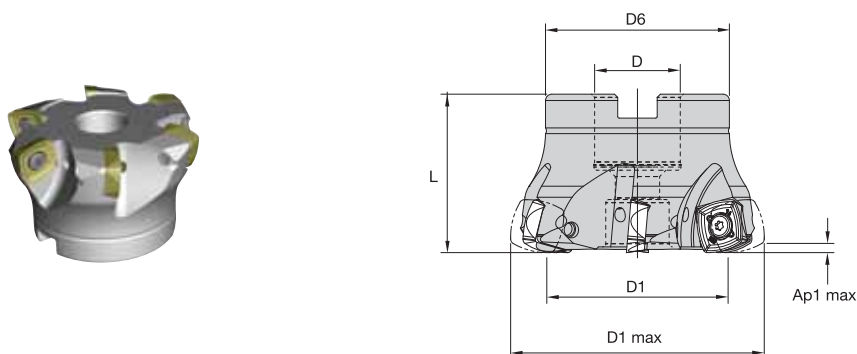

order number	catalogue number	D1 max	D1	D	D6	L	Ap1 max	Z	max ramp angle	max RPM	coolant supply	kg
6597776	VXF050Z04S22XE16	50	27	22	45	45	3,5	4	1.4°	25100	Yes	0,29
6597777	VXF063Z05S22XE16	63	40	22	47	40	3,5	5	.9°	21400	Yes	0,36
6597778	VXF080Z06S27XE16	80	57	27	58	50	3,5	6	.6°	18300	Yes	0,85
6597779	VXF100Z08S32XE16	100	77	32	68	50	3,5	8	.4°	16000	Yes	1,29
6597780	VXF125Z10S40XE16	125	102	40	84	63	3,5	10	.3°	14000	Yes	2,73

FOR SPARE PARTS, PLEASE VISIT WIDIA.COM OR WIDIANOVO.COM.
MOUNTING SCREWS ARE NOT INCLUDED IN STANDARD PACKAGING.

VXF-16 • XEPT-MM

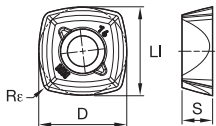

- first choice
- alternate choice

P	●	●
M	●	●
K	○	○
N	○	○
S	○	○
H	○	○

ISO catalogue number	cutting edges	LI	S	D	Re	WP25PM	WS40PM
XEPT160516ERMM	4	16,00	5,56	16,00	1,60	6596823	6596824

INDEXABLE MILLING

SOLID END MILLING

HOLE/MAKING

TAPPING

TURNING

VXF-16 • Insert Selection Guide

Material Group	Light Machining		General Purpose		Heavy Machining	
	Geometry	Grade	Geometry	Grade	Geometry	Grade
P1-P2	XEPT-MM	WP25PM	XEPT-MM	WS40PM	XEPT-MM	WS40PM
P3-P4	XEPT-MM	WP25PM	XEPT-MM	WS40PM	XEPT-MM	WS40PM
P5-P6	XEPT-MM	WP25PM	XEPT-MM	WS40PM	XEPT-MM	WS40PM
M1-M2	XEPT-MM	WS40PM	XEPT-MM	WS40PM	XEPT-MM	WS40PM
M3	XEPT-MM	WS40PM	XEPT-MM	WS40PM	XEPT-MM	WS40PM
S1-S2	XEPT-MM	WP25PM	XEPT-MM	WS40PM	XEPT-MM	WS40PM
S3	XEPT-MM	WS40PM	XEPT-MM	WS40PM	XEPT-MM	WS40PM
S4	XEPT-MM	WS40PM	XEPT-MM	WS40PM	XEPT-MM	WS40PM

VXF-16 • Recommended Starting Speeds [m/min]

Material Group		WP25PM			WS40PM		
P	1	395	340	325	-	-	-
	2	330	290	240	-	-	-
	3	305	260	210	-	-	-
	4	270	220	180	-	-	-
	5	220	205	180	205	175	145
	6	200	150	120	180	130	95
M	1	245	215	200	250	205	170
	2	220	190	155	215	175	145
	3	170	145	115	175	130	100
S	1	50	40	30	50	40	30
	2	50	40	30	50	40	30
	3	60	50	30	60	50	30
	4	85	60	40	70	60	35

NOTE: FIRST choice starting speeds are in **bold** type. As the average chip thickness increases, the speed should be decreased.
 *Material groups P, M, K, and H show recommended starting speeds for dry machining. For wet machining, reduce speed by 20%.
 *Material groups N and S show recommended starting speeds for wet machining. Not recommended for dry machining.

VXF-16 • Recommended Starting Feeds [mm]

Light Machining	General Purpose	Heavy Machining
-----------------	-----------------	-----------------

At 2,00 Axial Depth of Cut (Ap1)

Insert Geometry	Recommended Starting Feed per Tooth (Fz) in Relation to % of Radial Engagement (ae)															Insert Geometry
	5%			10%			20%			30%			40-100%			
.E..MM	0,40	1,28	2,18	0,29	0,92	1,54	0,21	0,68	1,14	0,19	0,60	0,99	0,17	0,55	0,91	.E..MM

At 2,50 Axial Depth of Cut (Ap1)

Insert Geometry	Recommended Starting Feed per Tooth (Fz) in Relation to % of Radial Engagement (ae)															Insert Geometry
	5%			10%			20%			30%			40-100%			
.E..MM	0,36	1,15	1,95	0,26	0,83	1,38	0,19	0,62	1,03	0,17	0,54	0,89	0,15	0,49	0,82	.E..MM

At 3,50 Axial Depth of Cut (Ap1)

Insert Geometry	Recommended Starting Feed per Tooth (Fz) in Relation to % of Radial Engagement (ae)															Insert Geometry
	5%			10%			20%			30%			40-100%			
.E..MM	0,30	0,98	1,66	0,22	0,71	1,18	0,17	0,53	0,88	0,14	0,46	0,76	0,13	0,42	0,70	.E..MM

NOTE: Use "Light Machining" values as starting feed rate.

Cylindrical Shank Extensions for Modular Heads • Screw-On Adapters • Metric

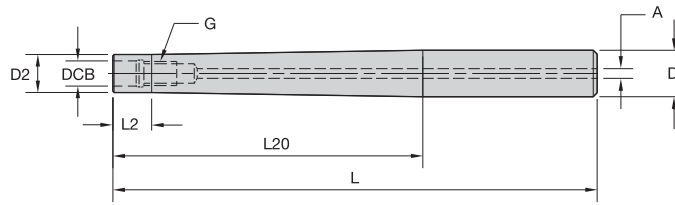

order number	catalogue number	DCB	G	D	D2	A	L	L2	L20
4160427	SS120STCHM06085M	6,5	M6	12	10	2,5	85	10	40
4160428	SS120STCHM06105M	6,5	M6	12	10	2,5	105	10	60
4160430	SS120STCHM06125M	6,5	M6	12	10	2,5	125	10	80
4160431	SS160STCHM08088M	8,5	M8	16	13	3,0	88	10	40
4160432	SS160STCHM08108M	8,5	M8	16	13	3,0	108	10	60
4160473	SS160STCHM08128M	8,5	M8	16	13	3,0	128	10	80
4160474	SS160STCHM08148M	8,5	M8	16	13	3,0	148	10	100
4160475	SS160STCHM08168M	8,5	M8	16	13	3,0	168	10	120
4160476	SS200STCHM10090M	10,5	M10	20	18	3,5	90	10	40
4160477	SS200STCHM10110M	10,5	M10	20	18	3,5	110	10	60
4160478	SS200STCHM10130M	10,5	M10	20	18	3,5	130	10	80
4160479	SS200STCHM10150M	10,5	M10	20	18	3,5	150	10	100
4160480	SS200STCHM10170M	10,5	M10	20	18	3,5	170	10	130

Cylindrical Shank Extensions for Modular Heads • Metric

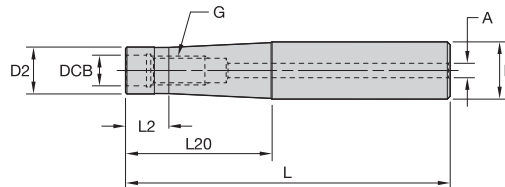

order number	catalogue number	DCB	G	D	D2	A	L	L2	L20
5672985	M-21-M12-CA25-131	12,50	M12	25	21	5	131	12	75
5672468	M-21-M12-CA25-156	12,50	M12	25	21	5	156	12	100
5672986	M-21-M12-CA25-181	12,50	M12	25	21	5	181	12	125
5672831	M-21-M12-CA25-206	12,50	M12	25	21	5	206	12	150
5672987	M-21-M12-CA25-231	12,50	M12	25	21	5	231	12	175
5672832	M-29-M16-CA32-160	17,00	M16	32	29	5	160	16	100
5672988	M-29-M16-CA32-210	17,00	M16	32	29	5	210	16	150
5673783	M-29-M16-CA32-260	17,00	M16	32	29	5	260	16	200
5672989	M-29-M16-CA32-310	17,00	M16	32	29	5	310	16	250

NOTE: Cylindrical shank extensions can be used with all modular heads found in several product family series.

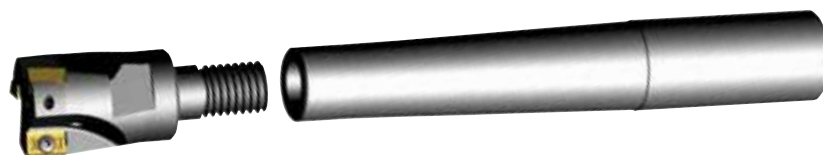

Best Practices

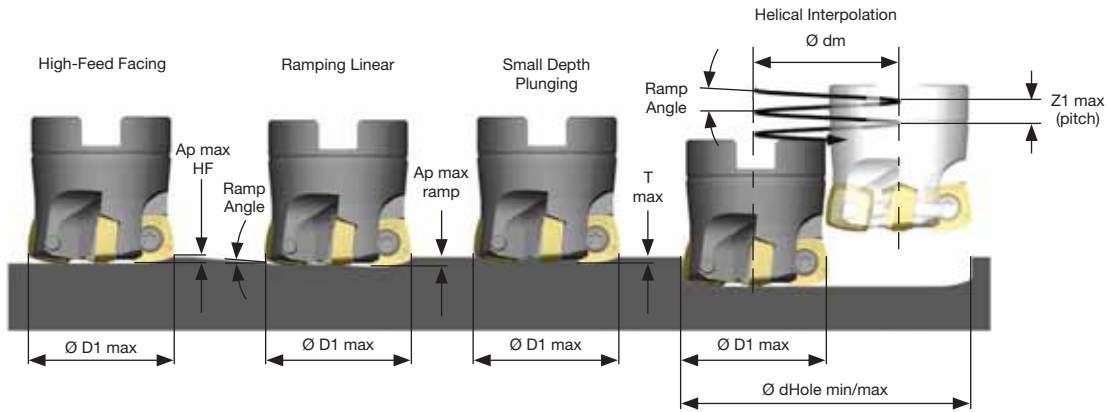

series	D1 max	High-feed Facing	Ramping Linear		Helical Interpolation			Small Depth Plunging	
		Ap max HF	Ramp Angle max	Ap max Ramp	Ramp Angle max	d Hole min	d Hole max	Z1 max Helical	T max
VXF-07	16	0,60	5,9	0,60	5,9	22,0	30,0	0,60	0,45
	18	0,60	5,4	0,60	5,4	24,0	34,0	0,60	0,45
	20	0,60	3,4	0,60	3,4	30,0	38,0	0,60	0,30
	25	0,60	2,2	0,60	2,2	40,0	48,0	0,60	0,30
	32	0,60	1,4	0,60	1,4	54,0	62,0	0,60	0,30
	40	0,60	1,0	0,60	1,0	70,0	78,0	0,60	0,30
	50	0,60	0,7	0,60	0,7	90,0	98,0	0,60	0,30
VXF-09	25	0,90	2,8	1,00	2,8	34,0	48,0	1,00	0,65
	32	0,90	1,5	1,00	1,5	48,0	62,0	1,00	0,65
	35	0,90	1,3	1,00	1,3	54,0	68,0	1,00	0,65
	40	0,90	0,8	1,00	0,8	64,0	78,0	1,00	0,65
	42	0,90	0,8	1,00	0,8	68,0	82,0	1,00	0,65
	50	0,90	0,7	1,00	0,7	84,0	98,0	1,00	0,65
	52	0,90	0,7	1,00	0,7	88,0	102,0	1,00	0,65
63	0,90	0,5	1,00	0,7	106,0	124,0	1,00	0,65	
VXF-12	32	1,30	1,8	1,80	1,8	42,0	62,0	1,80	0,80
	40	1,30	1,4	1,80	1,4	58,0	78,0	1,80	0,80
	42	1,30	1,3	1,80	1,3	62,0	82,0	1,80	0,80
	50	1,30	0,9	1,80	0,9	78,0	98,0	1,80	0,80
	52	1,30	0,8	1,80	0,8	82,0	102,0	1,80	0,80
	63	1,30	0,6	1,80	0,6	104,0	124,0	1,80	0,80
	66	1,30	0,5	1,80	0,5	110,0	130,0	1,80	0,80
	80	1,30	0,5	1,80	0,5	138,0	158,0	1,80	0,80
100	1,30	0,3	1,80	0,3	178,0	198,0	1,80	0,80	
VXF-16	50	2,00	1,4	2,50	1,4	70,0	98,0	2,50	0,70
	63	2,00	0,9	2,50	0,9	96,0	124,0	2,50	0,70
	80	2,00	0,6	2,50	0,6	130,0	158,0	2,50	0,70
	100	2,00	0,4	2,50	0,4	170,0	198,0	2,50	0,70
	125	2,00	0,3	2,50	0,3	220,0	248,0	2,50	0,70

$$\varnothing dm = \varnothing \text{Hole} - \varnothing D1 \text{ max}$$

$$Z1 = \varnothing dm \times 3,14 \times \tan \text{ramp angle}, Z1 \leq Z1 \text{ max and } \leq \text{ramp angle max}$$

$$\text{Ramp angle} = \arctan \left(\frac{Z1}{\varnothing dm \times 3,14} \right)$$

series	D1 max	X
VXF-07	16-50	4,20
VXF-09	25-63	6,80
VXF-12	32-100	9,10
VXF-16	50-125	11,40

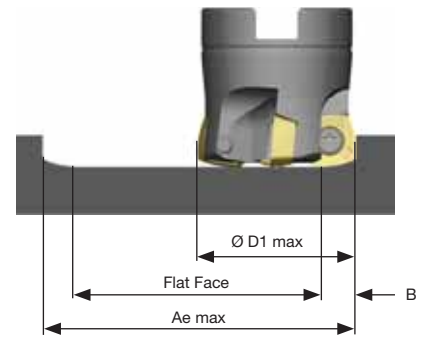

$$Ae \text{ max} \leq 2 \times \varnothing D1 \text{ max} - 2 \times B$$

$$\text{Flat Face} = Ae \text{ max} - 2 \times B$$

Z-Axis Plunge Milling

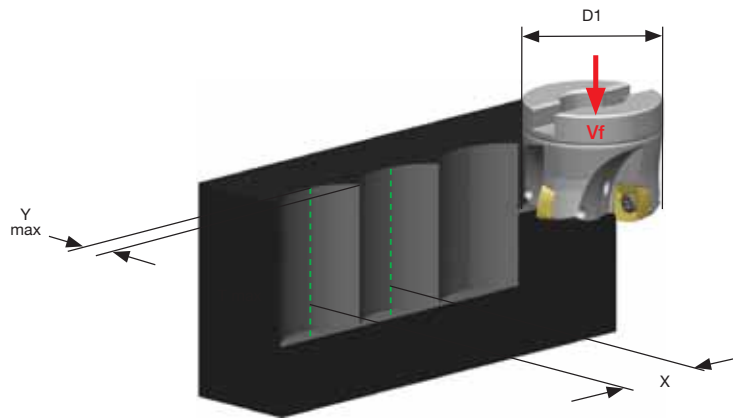

VXF-07			VXF-09			VXF-12			VXF-16		
D1 max	Y max	X	D1 max	Y max	X	D1 max	Y max	X	D1 max	Y max	X
16	3	12,49	25	6	21,35	32	9	28,77	50	13	43,86
18	3	13,41	32	6	24,98	40	9	33,40	63	13	50,99
20	3	14,28	35	6	26,38	42	9	34,46	80	13	59,02
25	3	16,24	40	6	28,56	50	9	38,41	100	13	67,26
32	3	18,65	42	6	29,39	52	9	39,34	125	13	76,31
40	3	21,07	50	6	32,49	63	9	44,09			
50	3	23,74	52	6	33,22	66	9	45,29			
			63	6	36,98	80	9	50,55			
						100	9	57,23			

Feed Rate Guide • Z-Axis Plunge Milling • fz (mm/tooth)

Insert Geometry	Recommended Starting Feed per Tooth (Fz)			Insert Geometry	Y max
	Light Machining	General Purpose	Heavy Machining		
VXF-07	.E..MM	0,06	0,15	.E..MM	3,0
	.S..MH	0,10	0,20		.S..MH
VXF-09	.E..MM	0,07	0,20	.E..MM	6,0
	.S..MH	0,10	0,22		.S..MH
VXF-12	.E..MM	0,07	0,20	.E..MM	9,0
	.S..MH	0,10	0,25		.S..MH
VXF-16	.E..MM	0,07	0,23	.E..MM	13,0

CAM Programming

Programming Data			
insert size	insert radius	R (to be programmed)	t
07	0,8	1,4	0,4
	1,0	1,5	0,4
09	0,8	2,0	0,72
	1,2	2,3	0,67
12	1,2	2,7	0,97
	1,5	2,8	0,95
16	1,2	4,2	1,46

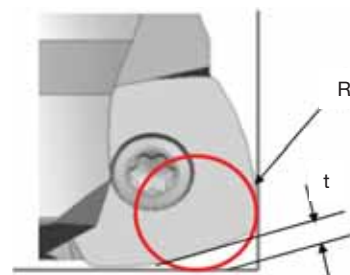

Solid ER Collets

Threaded solid ER collets turn CNC lathe machines into multitasking machines by providing access of any small diameter screw-on milling cutter to ER driven units. These new solid ER collets increase machine utilization through modular flexibility.

The short projection from the face of the collet nut provides rigid toolholding and a smaller required machine envelope.

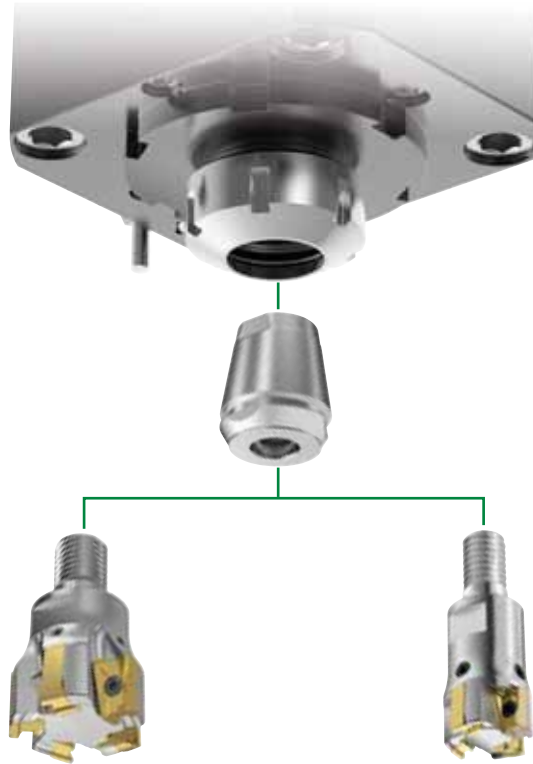

ERICKSON™

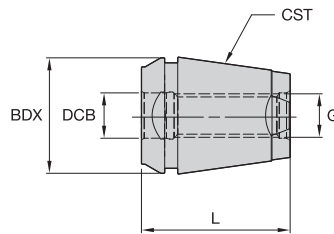

order number	catalogue number	collet capacity min		G	BDX	L
		CST	mm			
6587968	ER25STM08	ER25	9	M8	26	35
6587969	ER25STM10	ER25	11	M10	26	35
6587970	ER25STM12	ER25	13	M12	26	35
6588001	ER32STM08	ER32	9	M8	33	41
6588002	ER32STM10	ER32	11	M10	33	41
6588003	ER32STM12	ER32	13	M12	33	41
6588004	ER32STM16	ER32	17	M16	33	41
6588005	ER40STM08	ER40	9	M8	41	47
6588006	ER40STM10	ER40	11	M10	41	47
6588007	ER40STM12	ER40	13	M12	41	47
6588008	ER40STM16	ER40	17	M16	41	47



M370™ Series

M370 IC08, M370 IC12 Copy Mills

The M370 Series is a six-edged copy mill designed for high feed rate productivity in steel and cast iron materials.

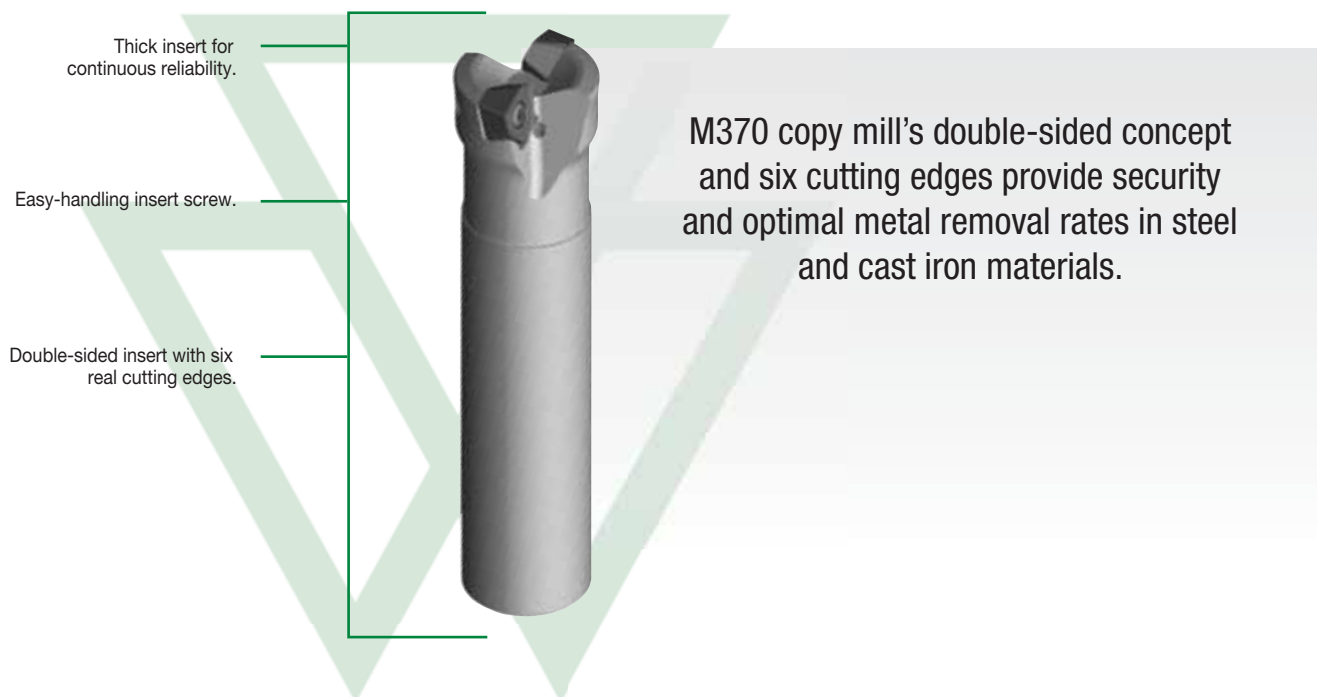

iC08 and iC12 inserts offered in THREE Geometries

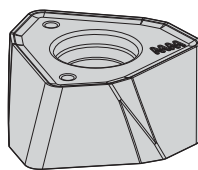

-MM



Designed for lower cutting forces. First choice for steel, stainless steel, and high-temp alloys.

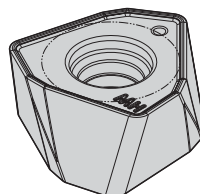

-MH



This insert has a strong cutting edge, making it a first choice for hard machining applications up to 48 HRC.



-MR



Designed for heavy-duty steel and cast iron applications.

HIGH-FEED ROUGHING

PRODUCT

SERIES

M370™

DIAMETER RANGE

25–125mm

SHANK TYPES

Screw-On End Mills
Weldon® End Mills
Shell Mills

INDUSTRY



APPLICATIONS



3D
PROFILING



SLOTTING:
SIDE MILLING



SLOTTING:
SQUARE END



FACE
MILLING



RAMPING
BLANK



POCKETING



HELICAL
MILLING



PLUNGE
MILLING



THROUGH
COOLANT:
RADIAL:
INDEXABLE
MILLING



M370 • Screw-On End Mills • W008.. • Metric

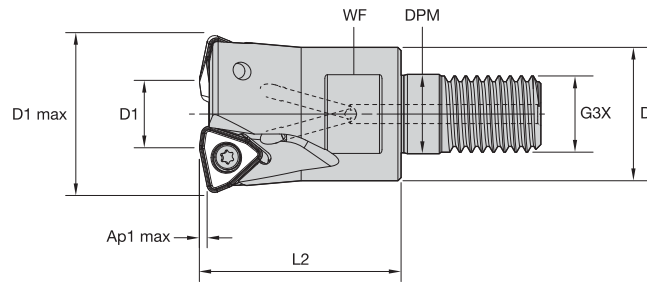

order number	catalogue number	D1 max	D1	D	DPM	G3X	L2	WF	Ap1 max	Z	max ramp angle	max RPM	coolant supply	kg
4056186	M370D025Z02M12W008	25	11	21	12,5	M12	35	17	1,3	2	2.1	46000	Yes	0,09
4170918	M370D025Z03M12W008	25	11	21	12,5	M12	35	17	1,3	3	2.1	46000	Yes	0,09
4056187	M370D032Z04M16W008	32	18	29	17,0	M16	43	24	1,3	4	1.4	38700	Yes	0,21
4056188	M370D042Z05M16W008	42	28	29	17,0	M16	43	24	1,3	5	1.0	32500	Yes	0,57

M370 • Cylindrical Shank • W008.. • Metric

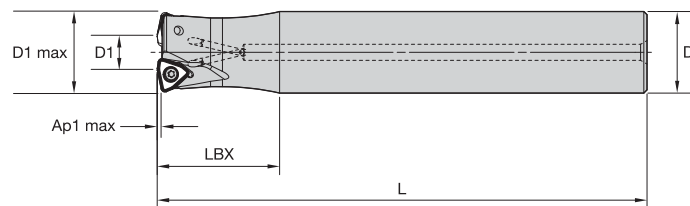

order number	catalogue number	D1 max	D1	D	L	LBX	Ap1 max	Z	max RPM	coolant supply	kg
4056189	M370D025Z03A25W008L150	25	11	25	150	40	1,3	3	46000	Yes	0,50
4008281	M370D025Z02A25W008L200	25	11	25	200	50	1,3	2	46000	Yes	0,68
4170919	M370D025Z03A25W008L200	25	11	25	200	40	1,3	3	46000	Yes	0,69
4170920	M370D025Z02A25W008L300	25	11	25	300	40	1,3	2	46000	Yes	1,08
4056190	M370D028Z03A25W008L200	28	14	25	200	40	1,3	3	42400	Yes	0,70
4056192	M370D032Z04A32W008L200	32	18	32	200	50	1,3	4	38700	Yes	1,14
4056191	M370D032Z04A32W008L150	32	18	32	150	40	1,3	4	38700	Yes	0,84
4170921	M370D032Z03A32W008L300	32	18	32	300	40	1,3	3	38700	Yes	1,77

FOR SPARE PARTS, PLEASE VISIT WIDIA.COM OR WIDIANOVO.COM.
MOUNTING SCREWS ARE NOT INCLUDED IN STANDARD PACKAGING.

M370 • Shell Mills • W008... • Metric

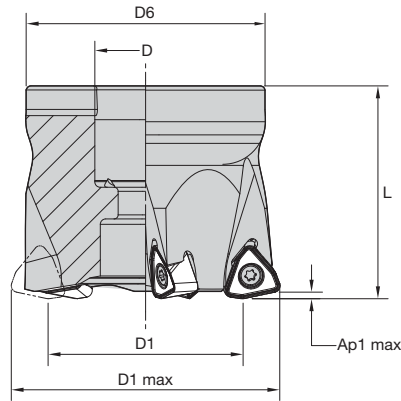

order number	catalogue number	D1 max	D1	D	D6	L	Ap1 max	Z	max RPM	coolant supply	kg
4056193	M370D040Z04W008	40	26	16	37	40	1,3	4	33500	Yes	0,19
4170922	M370D040Z05W008	40	26	16	37	40	1,3	5	33500	Yes	0,19
4008276	M370D050Z05W008	50	36	22	44	40	1,3	5	29200	Yes	0,29
4171223	M370D050Z06W008	50	36	22	44	40	1,3	6	29200	Yes	0,29
4171224	M370D052Z06W008	52	38	22	44	50	1,3	6	28600	Yes	0,40
4056194	M370D052Z05W008	52	38	22	44	50	1,3	5	28600	Yes	0,41
4056195	M370D063Z06W008	63	49	22	60	50	1,3	6	25500	Yes	0,74
4008277	M370D066Z06W008	66	52	27	60	50	1,3	6	24900	Yes	0,77
4171225	M370D080Z07W008	80	66	27	60	50	1,3	7	24900	Yes	2,36

NOTE: Socket-head cap screw with coolant groove must be ordered separately.

M370 • WOEJ-MH • W00804..

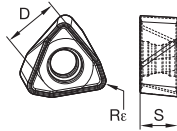
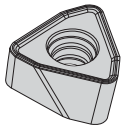

- first choice
- alternate choice

P	●	●	○	○	○	○	○	○	○	○	○
M	○	○	○	○	○	○	○	○	○	○	○
K	○	○	○	○	○	○	○	○	○	○	○
N	○	○	○	○	○	○	○	○	○	○	○
S	○	○	○	○	○	○	○	○	○	○	○
H	○	○	○	○	○	○	○	○	○	○	○

ISO catalogue number	cutting edges	D	S	Rε	TN6525	TN6540	WK15CM	WP25PM	WP35CM	WP40PM	WS30PM	WS40PM	WU35PM
WOEJ080412SRMH	6	7,79	4,75	1,22	4052411	4052410	5427443	5564596	-	5544752	-	6333664	-

M370 • WOEJ-MM • W00804..

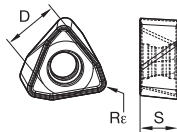
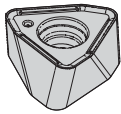

- first choice
- alternate choice

P	●	●	○	○	○	○	○	○	○	○	○	○	○
M	○	○	○	○	○	○	○	○	○	○	○	○	○
K	○	○	○	○	○	○	○	○	○	○	○	○	○
N	○	○	○	○	○	○	○	○	○	○	○	○	○
S	○	○	○	○	○	○	○	○	○	○	○	○	○
H	○	○	○	○	○	○	○	○	○	○	○	○	○

ISO catalogue number	cutting edges	D	S	Rε	TN6525	TN6540	WK15CM	WP25PM	WP35CM	WP40PM	WS30PM	WS40PM	WU35PM
WOEJ080412SRMM	6	7,79	4,70	1,22	4113892	4113915	-	5564597	-	5544753	5520248	6333665	-

M370 • 08 • Insert Selection Guide

Material Group	Light Machining		General Purpose		Heavy Machining	
	Geometry	Grade	Geometry	Grade	Geometry	Grade
P1-P2	...MM	WP40PM	...MM	WP40PM	...MM	WP40PM
P3-P4	...MM	WP25PM	...MM	WP40PM	...MH	WP40PM
P5-P6	...MM	WP25PM	...MH	WP25PM	...MH	WP40PM
M1-M2	...MM	WP25PM	...MM	WS30PM	...MM	WP40PM
M3	...MM	WP25PM	...MM	WP25PM	...MM	WP40PM
K1-K2	...MH	WK15CM	...MH	WK15CM	...MH	WK15CM
K3	...MH	TN6520	...MH	TN6520	...MH	WK15CM
N1-N2	-	-	-	-	-	-
N3	-	-	-	-	-	-
S1-S2	...MM	WP25PM	...MM	WS30PM	...MM	WP40PM
S3	...MM	WS30PM	...MM	WS30PM	...MM	WP40PM
S4	...MM	WS30PM	...MM	WP40PM	...MM	WP40PM
H1	...MH	WP25PM	-	-	-	-

M370 • 08 • Recommended Starting Speeds [m/min]

Material Group		TN6525			TN6540			WK15CM			WP25PM			WP35CM		
P	1	410	320	280	360	280	240	-	-	-	395	340	325	455	395	370
	2	320	250	215	250	190	170	-	-	-	330	290	240	280	255	230
	3	280	215	185	215	170	140	-	-	-	305	260	210	255	230	205
	4	235	170	145	180	130	110	-	-	-	270	220	180	190	175	160
	5	310	235	200	240	180	150	-	-	-	220	205	180	260	230	210
	6	205	160	130	160	120	100	-	-	-	200	150	120	160	135	110
M	1	190	120	80	130	80	60	-	-	-	245	215	200	205	185	155
	2	120	80	50	80	50	40	-	-	-	220	190	155	185	160	140
	3	125	80	55	85	50	40	-	-	-	170	145	115	145	130	115
K	1	275	245	220	220	205	180	505	460	410	275	245	220	295	265	240
	2	215	190	180	175	155	140	400	355	330	215	190	180	235	210	190
	3	180	160	145	155	145	125	335	300	275	180	160	145	195	175	160
N	1	-	-	-	-	-	-	-	-	-	-	-	-	-	-	-
	2	-	-	-	-	-	-	-	-	-	-	-	-	-	-	-
	3	-	-	-	-	-	-	-	-	-	-	-	-	-	-	-
S	1	-	-	-	50	35	30	-	-	-	50	40	30	-	-	-
	2	-	-	-	25	20	10	-	-	-	50	40	30	-	-	-
	3	-	-	-	70	40	30	-	-	-	60	50	30	-	-	-
	4	-	-	-	60	30	25	-	-	-	85	60	40	66	50	33
H	1	-	-	-	-	-	-	-	-	-	145	110	85	-	-	-
	2	-	-	-	-	-	-	-	-	-	-	-	-	-	-	-
	3	-	-	-	-	-	-	-	-	-	-	-	-	-	-	-

Material Group		WP40PM			WS30PM			WS40PM			WU35PM		
P	1	355	310	295	-	-	-	-	-	-	260	230	215
	2	300	260	215	-	-	-	-	-	-	220	190	160
	3	275	235	190	-	-	-	-	-	-	200	170	140
	4	245	205	160	-	-	-	-	-	-	180	150	120
	5	205	185	160	-	-	-	440	325	230	150	135	120
	6	180	140	110	-	-	-	375	260	165	130	100	80
M	1	235	205	185	270	240	220	850	605	375	170	150	135
	2	210	180	150	245	215	175	755	560	345	155	130	110
	3	155	140	110	185	160	125	625	440	280	115	100	80
K	1	-	-	-	-	-	-	-	-	-	-	-	-
	2	-	-	-	-	-	-	-	-	-	-	-	-
	3	-	-	-	-	-	-	-	-	-	-	-	-
N	1	-	-	-	-	-	-	-	-	-	-	-	-
	2	-	-	-	-	-	-	-	-	-	-	-	-
	3	-	-	-	-	-	-	-	-	-	-	-	-
S	1	50	40	35	55	50	35	200	145	90	35	30	25
	2	50	40	35	55	50	35	180	130	85	35	30	25
	3	60	50	35	65	55	35	210	150	95	45	35	25
	4	80	60	40	100	70	50	295	215	135	60	45	30
H	1	-	-	-	-	-	-	-	-	-	-	-	-
	2	-	-	-	-	-	-	-	-	-	-	-	-
	3	-	-	-	-	-	-	-	-	-	-	-	-

NOTE: FIRST choice starting speeds are in **bold** type.
As the average chip thickness increases, the speed should be decreased.

M370 • 08 • Recommended Starting Feeds [mm]

Light Machining	General Purpose	Heavy Machining
-----------------	-----------------	-----------------

Insert Geometry	Programmed Feed per Tooth (fz) as a % of Radial Depth of Cut (ae)														Insert Geometry	
	5%			10%			20%			30%			40-100%			
..MM	0,90	1,67	4,09	0,65	1,19	2,83	0,48	0,88	2,08	0,42	0,77	1,80	0,38	0,70	1,64	..MM
..MH	0,90	2,34	5,00	0,65	1,66	3,41	0,48	1,23	2,49	0,42	1,07	2,16	0,38	0,98	1,97	..MH

NOTE: Use "Light Machining" values as starting feed rate.

M370 • Shell Mills • W012... • Metric

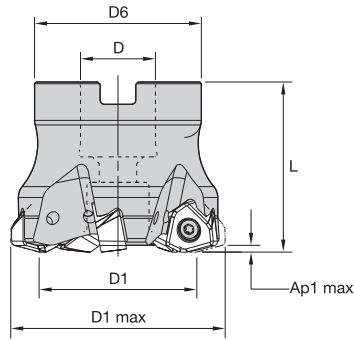

order number	catalogue number	D1 max	D1	D	D6	L	Ap1 max	Z	max RPM	coolant supply	kg
5338913	M370D50Z04W012	50,0	33	22	42	50	2,0	4	19530	Yes	0,38
5338914	M370D52Z04W012	52,0	35	22	49	50	2,0	4	19160	Yes	0,47
5338915	M370D63Z04W012	63,0	46	22	49	50	2,0	4	17400	Yes	0,57
5338916	M370D63Z05W012	63,0	46	22	49	50	2,0	5	17400	Yes	0,57
5338917	M370D66Z05W012	66,0	49	27	60	50	2,0	5	17000	Yes	0,79
5338918	M370D80Z05W012	80,0	63	27	60	50	2,0	5	15440	Yes	0,94
5338919	M370D80Z06W012	80,0	63	27	60	50	2,0	6	15440	Yes	0,94
5338920	M370D100Z06W012	100,0	83	32	78	50	2,0	6	13810	Yes	1,56
5338921	M370D100Z07W012	100,0	83	32	78	50	2,0	7	13810	Yes	1,57
5338922	M370D125Z07W012	125,0	108	40	90	63	2,0	7	12350	Yes	2,92
5338923	M370D125Z09W012	125,0	108	40	90	63	2,0	9	12350	Yes	2,94

NOTE: Socket-head cap screw with coolant groove and coolant lock screw assembly must be ordered separately.

FOR SPARE PARTS, PLEASE VISIT WIDIA.COM OR WIDIANOVO.COM.

MOUNTING SCREWS ARE NOT INCLUDED IN STANDARD PACKAGING.

M370 • WOEJ-MH • WO.J1207

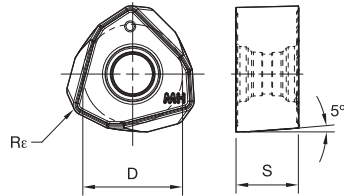
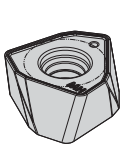

- first choice
- alternate choice

P	●	●	●	●	●	●	●	●	●	●
M	●	●	●	●	●	●	●	●	●	●
K	●	●	●	●	●	●	●	●	●	●
N	●	●	●	●	●	●	●	●	●	●
S	●	●	●	●	●	●	●	●	●	●
H	●	●	●	●	●	●	●	●	●	●

ISO catalogue number	cutting edges	D	S	Re	TN6525	TN6540	WK15CM	WP25PM	WP35CM	WP40PM	WS30PM	WS40PM	WU35PM
WOEJ120712SRMH	6	12,00	7,30	1,27	●	●	●	●	●	●	●	●	●

M370 • WOEJ-MM • WO.J1207

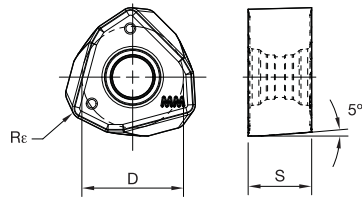
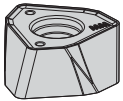

- first choice
- alternate choice

P	●	●	●	●	●	●	●	●	●	●	●	●	●
M	●	●	●	●	●	●	●	●	●	●	●	●	●
K	●	●	●	●	●	●	●	●	●	●	●	●	●
N	●	●	●	●	●	●	●	●	●	●	●	●	●
S	●	●	●	●	●	●	●	●	●	●	●	●	●
H	●	●	●	●	●	●	●	●	●	●	●	●	●

ISO catalogue number	cutting edges	D	S	Re	TN6525	TN6540	WK15CM	WP25PM	WP35CM	WP40PM	WS30PM	WS40PM	WU35PM
WOEJ120712SRMM	6	12,00	7,30	1,27	●	●	●	●	●	●	●	●	●

M370 • WOEJ-MR • WO.J1207

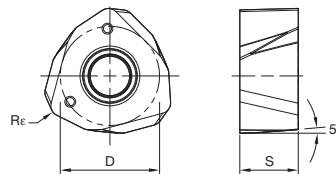

- first choice
- alternate choice

P	●	●	●	●	●	●	●	●	●	●	●	●	●
M	●	●	●	●	●	●	●	●	●	●	●	●	●
K	●	●	●	●	●	●	●	●	●	●	●	●	●
N	●	●	●	●	●	●	●	●	●	●	●	●	●
S	●	●	●	●	●	●	●	●	●	●	●	●	●
H	●	●	●	●	●	●	●	●	●	●	●	●	●

ISO catalogue number	cutting edges	D	S	Re	TN6525	TN6540	WK15CM	WP25PM	WP35CM	WP40PM	WS30PM	WS40PM	WU35PM
WOEJ120712SRMR	6	12,00	7,10	1,27	●	●	●	●	●	●	●	●	●

M370 • 12 • Insert Selection Guide

Material Group	Light Machining		General Purpose		Heavy Machining	
	Geometry	Grade	Geometry	Grade	Geometry	Grade
P1-P2	.S.MM	WU35PM	.S.MM	WP40PM	.S.MM	WP40PM
P3-P4	.S.MM	WP25PM	.S.MM	WP25PM	.S.MH	WP40PM
P5-P6	.S.MM	WP25PM	.S.MM	WP35CM	.S.MH	WP35CM
M1-M2	.S.MM	WS30PM	.S.MM	WU35PM	.S.MM	WP40PM
M3	.S.MM	WP25PM	.S.MM	WP35CM	.S.MM	WP40PM
K1-K2	.S.MH	WK15CM	.S.MH	WK15CM	.S.MH	WP20CM
K3	.S.MH	WK15CM	.S.MH	WK15CM	.S.MH	WP20CM
N1-N2	-	-	-	-	-	-
N3	-	-	-	-	-	-
S1-S2	.S.MM	WS30PM	.S.MM	WU35PM	.S.MM	WP40PM
S3	.S.MM	WS30PM	.S.MM	WU35PM	.S.MM	WP40PM
S4	.S.MM	WS30PM	.S.MM	WU35PM	.S.MM	WP40PM
H1	.S.MH	WP35CM	.S.MR	WP25PM	-	-

M370 • 12 • Recommended Starting Speeds [m/min]

Material Group		TN6525			TN6540			WK15CM			WP25PM			WP35CM		
		P	1	410	320	280	360	280	240	-	-	-	395	340	325	455
	2	320	250	215	250	190	170	-	-	-	330	290	240	280	255	230
	3	280	215	185	215	170	140	-	-	-	305	260	210	255	230	205
	4	235	170	145	180	130	110	-	-	-	270	220	180	190	175	160
	5	310	235	200	240	180	150	-	-	-	220	205	180	260	230	210
	6	205	160	130	160	120	100	-	-	-	200	150	120	160	135	110
M	1	190	120	80	130	80	60	-	-	-	245	215	200	205	185	155
	2	120	80	50	80	50	40	-	-	-	220	190	155	185	160	140
	3	125	80	55	85	50	40	-	-	-	170	145	115	145	130	115
K	1	275	245	220	220	205	180	505	460	410	275	245	220	295	265	240
	2	215	190	180	175	155	140	400	355	330	215	190	180	235	210	190
	3	180	160	145	155	145	125	335	300	275	180	160	145	195	175	160
N	1	-	-	-	-	-	-	-	-	-	-	-	-	-	-	-
	2	-	-	-	-	-	-	-	-	-	-	-	-	-	-	-
	3	-	-	-	-	-	-	-	-	-	-	-	-	-	-	-
S	1	-	-	-	50	35	30	-	-	-	50	40	30	-	-	-
	2	-	-	-	25	20	10	-	-	-	50	40	30	-	-	-
	3	-	-	-	70	40	30	-	-	-	60	50	30	-	-	-
	4	-	-	-	60	30	25	-	-	-	85	60	40	66	50	33
H	1	-	-	-	-	-	-	-	-	-	145	110	85	-	-	-
	2	-	-	-	-	-	-	-	-	-	-	-	-	-	-	-
	3	-	-	-	-	-	-	-	-	-	-	-	-	-	-	-

Material Group		WP40PM			WS30PM			WS40PM			WU35PM		
		P	1	355	310	295	-	-	-	-	-	-	260
	2	300	260	215	-	-	-	-	-	-	220	190	160
	3	275	235	190	-	-	-	-	-	-	200	170	140
	4	245	205	160	-	-	-	-	-	-	180	150	120
	5	205	185	160	-	-	-	440	325	230	150	135	120
	6	180	140	110	-	-	-	375	260	165	130	100	80
M	1	235	205	185	270	240	220	850	605	375	170	150	135
	2	210	180	150	245	215	175	755	560	345	155	130	110
	3	155	140	110	185	160	125	625	440	280	115	100	80
K	1	-	-	-	-	-	-	-	-	-	-	-	-
	2	-	-	-	-	-	-	-	-	-	-	-	-
	3	-	-	-	-	-	-	-	-	-	-	-	-
N	1	-	-	-	-	-	-	-	-	-	-	-	-
	2	-	-	-	-	-	-	-	-	-	-	-	-
	3	-	-	-	-	-	-	-	-	-	-	-	-
S	1	50	40	35	55	50	35	200	145	90	35	30	25
	2	50	40	35	55	50	35	180	130	85	35	30	25
	3	60	50	35	65	55	35	210	150	95	45	35	25
	4	80	60	40	100	70	50	295	215	135	60	45	30
H	1	-	-	-	-	-	-	-	-	-	-	-	-
	2	-	-	-	-	-	-	-	-	-	-	-	-
	3	-	-	-	-	-	-	-	-	-	-	-	-

NOTE: FIRST choice starting speeds are in bold type.
As the average chip thickness increases, the speed should be decreased.

M370 • 12 • Recommended Starting Feeds [mm]

Light Machining	General Purpose	Heavy Machining
-----------------	-----------------	-----------------

Insert Geometry	Programmed Feed per Tooth (fz) as a % of Radial Depth of Cut (ae)														Insert Geometry	
	5%			10%			20%			30%			40-100%			
..MM	0,90	1,87	3,62	0,65	1,33	2,52	0,48	0,99	1,86	0,42	0,86	1,61	0,39	0,79	1,47	..MM
..MH	0,90	2,35	4,97	0,65	1,67	3,40	0,48	1,23	2,48	0,42	1,07	2,15	0,39	0,98	1,96	..MH
..MR	0,90	2,81	5,44	0,65	1,97	3,69	0,48	1,46	2,69	0,42	1,27	2,33	0,39	1,16	2,13	..MR

NOTE: Use "Light Machining" values as starting feed rate.

INDEXABLE MILLING

SOLID END MILLING

HOLEMAKING

TAPPING

TURNING

M200™ Series

M200 IC10, M200 IC12, M200 IC16 Copy Mills

The M200 copy mill is a double-sided round insert series with an effective anti-rotation feature and 12 cutting edges per insert to tackle pocketing and face milling operations in power generation and general engineering applications.

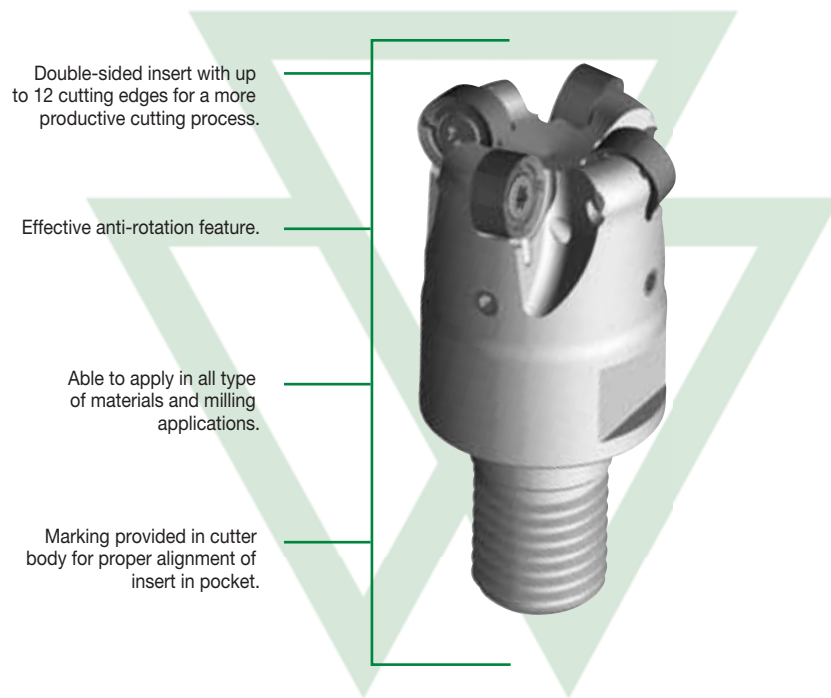

M200 iC10

10mm iC insert
8 cutting edges

-ALP



N

For non-ferrous materials.

-ML



P M S

First choice for stainless steel and high-temp alloys.

-MM



P M S

First choice for general purpose, especially for steel.

-MH



P K

First choice for heavy machining and cast iron.

M200 iC12

12mm iC insert
12 cutting edges

-ALP



N

For non-ferrous materials.

-ML



P M S

First choice for stainless steel and high-temp alloys.

-MM



P M S

First choice for general purpose, especially for steel.

-MH



P K

First choice for heavy machining and cast iron.

M200 iC16

16mm iC insert
12 cutting edges

-ALP



N

For non-ferrous materials.

-ML



P M S

First choice for stainless steel and high-temp alloys.

-MM



P M S

First choice for general purpose, especially for steel.

-MH



P K

First choice for heavy machining and cast iron.

DOUBLE-SIDED ROUND INSERT COPY MILLING SERIES

PRODUCT

SERIES

M200™

DIAMETER RANGE

50–80mm

SHANK TYPES

Screw-On End Mills
Cylindrical End Mills
Shell Mills

INDUSTRY



APPLICATIONS



FACE
MILLING



POCKETING



3D
PROFILING

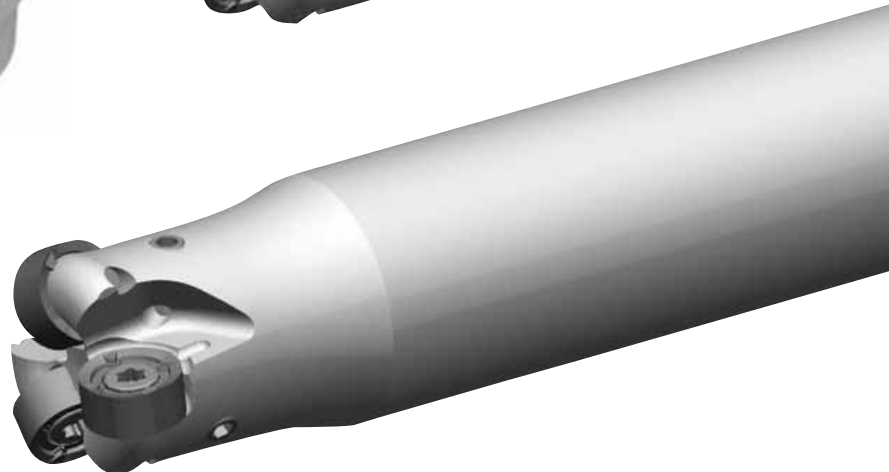
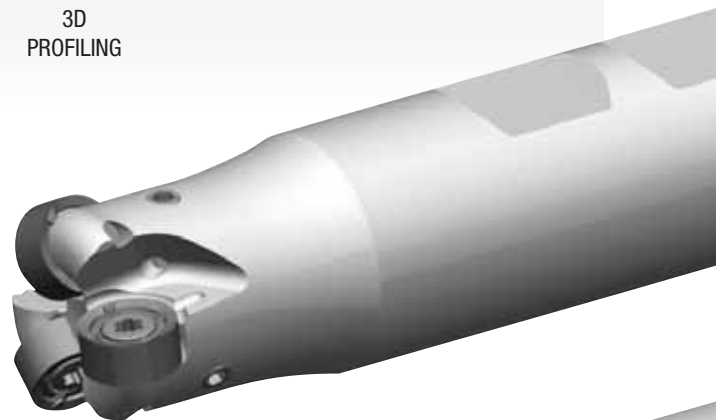

M200 • iC10 • Screw-On End Mills • Metric

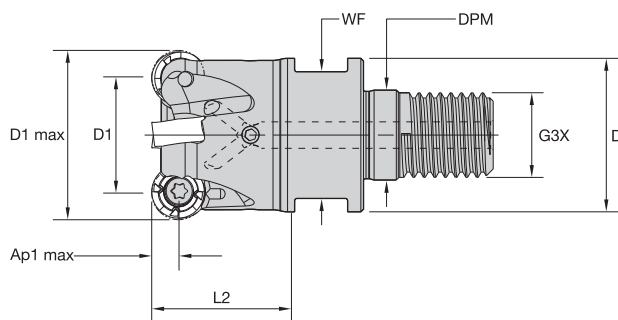

order number	catalogue number	D1 max	D1	D	DPM	G3X	L2	WF	Ap1 max	Z	max ramp angle	max RPM	coolant supply	kg
5210273	M200D25Z03M12RN10	25	15	21	12,5	M12	32	17	5,0	3	0.6	54700	Yes	0,08
5210274	M200D32Z04M16RN10	32	22	29	17,0	M16	40	24	5,0	4	0.5	48300	Yes	0,18
5210275	M200D35Z05M16RN10	35	25	29	17,0	M16	40	24	5,0	5	0.5	46200	Yes	0,20
5210276	M200D42Z06M16RN10	42	32	29	17,0	M16	40	25	5,0	6	0.4	42200	Yes	0,24

M200 • iC10 • Weldon® End Mills • Metric

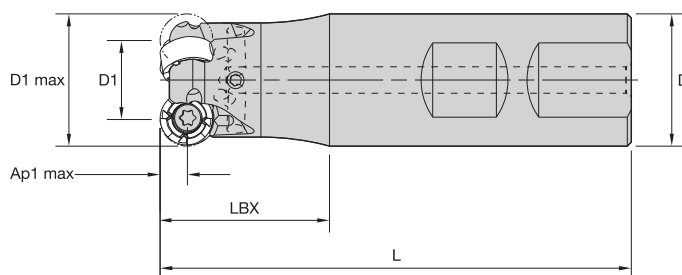

order number	catalogue number	D1 max	D1	D	L	LBX	Ap1 max	Z	max ramp angle	max RPM	coolant supply	kg
5210277	M200D25Z03B25RN10	25	15	25	89	40	5,0	3	0.6	54700	Yes	0,27
5210278	M200D32Z04B32RN10	32	22	32	101	40	5,0	4	0.5	48300	Yes	0,52

FOR SPARE PARTS, PLEASE VISIT WIDIA.COM OR WIDIANOVO.COM.
MOUNTING SCREWS ARE NOT INCLUDED IN STANDARD PACKAGING.

M200 • iC10 • Cylindrical End Mills • Metric

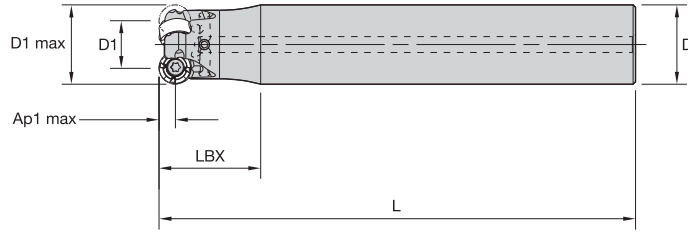

order number	catalogue number	D1 max	D1	D	L	LBX	Ap1 max	Z	max ramp angle	max RPM	coolant supply	kg
5210279	M200D25Z03A25RN10L150	25	15	25	150	32	5,0	3	0.6	54700	Yes	0,50
5210300	M200D25Z03A25RN10L200	25	15	25	200	32	5,0	3	0.6	54700	Yes	0,69
5210301	M200D25Z03A32RN10L250	25	15	32	250	32	5,0	3	0.6	54700	Yes	1,42
5210302	M200D28Z03A25RN10L200	28	18	25	200	40	5,0	3	0.6	51600	Yes	0,70
5210304	M200D32Z03A32RN10L200	32	22	32	200	40	5,0	3	0.5	48300	Yes	1,14
5210303	M200D32Z04A32RN10L150	32	22	32	150	40	5,0	4	0.5	48300	Yes	0,83

M200 • iC10 • Shell Mills • Metric

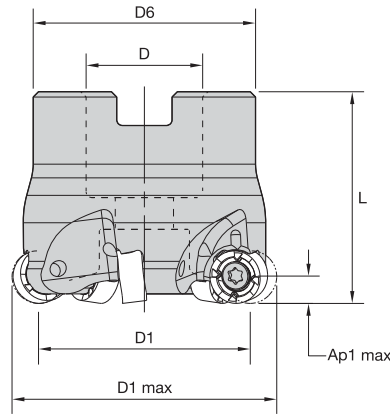

order number	catalogue number	D1 max	D1	D	D6	L	L1	Ap1 max	Z	max ramp angle	max RPM	coolant supply	kg
5210305	M200D40Z04RN10	40	30	16	38	40	40	5,0	4	0.4	43200	Yes	0,23
5210306	M200D40Z06RN10	40	30	16	38	40	40	5,0	6	0.4	43200	Yes	0,24
5210307	M200D50Z05RN10	50	40	22	42	40	40	5,0	5	0.3	38600	Yes	0,32
5210308	M200D50Z06RN10	50	40	22	42	40	40	5,0	6	0.3	38600	Yes	0,32
5210309	M200D52Z06RN10	52	42	22	49	50	50	5,0	6	0.3	37900	Yes	0,52

NOTE: Socket-head cap screw and socket-head cap screw with coolant groove must be ordered separately.

INDEXABLE MILLING

SOLID END MILLING

HOLEMAKING

TAPPING

TURNING

M200 • RN.J10... • RNGJ-ML

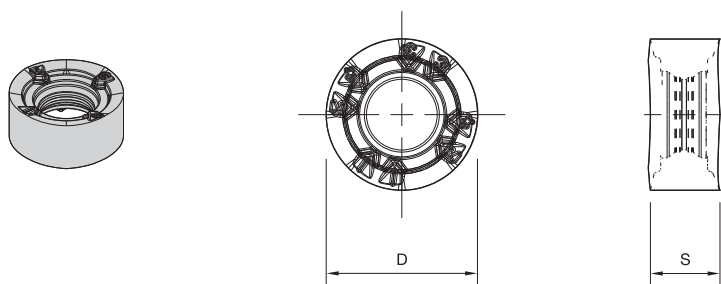

- first choice
- alternate choice

P	M	K	N	S	H	WK15CM	WK15PM	WN25PM	WP20CM	WP25PM	WP35CM	WP40PM	WS30PM	WS40PM	WU35PM
●	●	●	●	●	●	●	○	○	○	○	○	○	○	○	○
○	○	○	○	○	○	○	○	○	○	○	○	○	○	○	○
○	○	○	○	○	○	○	○	○	○	○	○	○	○	○	○
○	○	○	○	○	○	○	○	○	○	○	○	○	○	○	○
○	○	○	○	○	○	○	○	○	○	○	○	○	○	○	○
○	○	○	○	○	○	○	○	○	○	○	○	○	○	○	○

ISO catalogue number	cutting edges	D	S	hm	WK15CM	WK15PM	WN25PM	WP20CM	WP25PM	WP35CM	WP40PM	WS30PM	WS40PM	WU35PM
RNGJ10T3M0EML	2	10,00	3,93	0,04	●	○	○	○	○	○	○	○	○	○

M200 • RN.J10... • RNGJ-MM

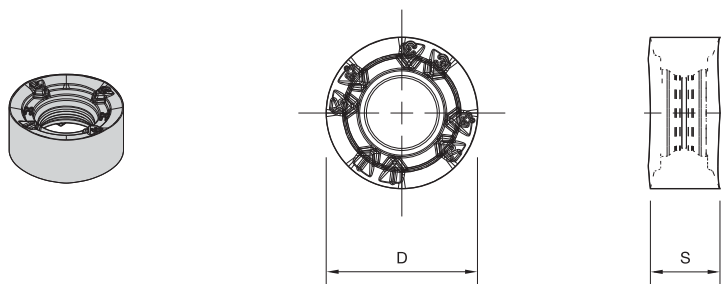



- first choice
- alternate choice

P	M	K	N	S	H	WK15CM	WK15PM	WN25PM	WP20CM	WP25PM	WP35CM	WP40PM	WS30PM	WS40PM	WU35PM
●	●	●	●	●	●	●	○	○	○	○	○	○	○	○	○
○	○	○	○	○	○	○	○	○	○	○	○	○	○	○	○
○	○	○	○	○	○	○	○	○	○	○	○	○	○	○	○
○	○	○	○	○	○	○	○	○	○	○	○	○	○	○	○
○	○	○	○	○	○	○	○	○	○	○	○	○	○	○	○
○	○	○	○	○	○	○	○	○	○	○	○	○	○	○	○

catalogue number	number of indexes	D	S	hm	WK15CM	WK15PM	WN25PM	WP20CM	WP25PM	WP35CM	WP40PM	WS30PM	WS40PM	WU35PM
RNGJ10T3M0SMM	8	10,00	3,93	0,09	●	○	○	○	○	○	○	○	○	○

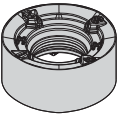
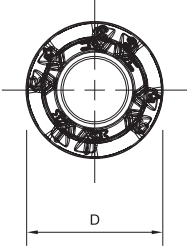

M200 • RN.J10... • RNPJ-MM

● first choice
○ alternate choice

ISO catalogue number	cutting edges	D	S	hm	WK15CM	WK15PM	WN25PM	WP20CM	WP25PM	WP35CM	WP40PM	WS30PM	WS40PM	WU35PM
RNPJ10T3M0SMM	2	10,00	3,93	0,09	•	•	•	•	•	•	•	•	•	•

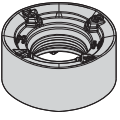
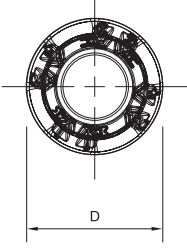

M200 • RN.J10... • RNPJ-MH

● first choice
○ alternate choice

ISO catalogue number	cutting edges	D	S	hm	WK15CM	WK15PM	WN25PM	WP20CM	WP25PM	WP35CM	WP40PM	WS30PM	WS40PM	WU35PM
RNPJ10T3M0SMH	2	10,00	3,93	0,18	•	•	•	•	•	•	•	•	•	•

M200 • RN.J10... • RNGJ-ALP

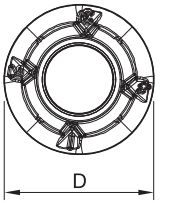
● first choice
○ alternate choice

catalogue number	number of indexes	D	S	hm	WK15CM	WK15PM	WN25PM	WP20CM	WP25PM	WP35CM	WP40PM	WS30PM	WS40PM	WU35PM
RNGJ10T3M0FALP	8	10,00	3,93	0,02	•	•	•	•	•	•	•	•	•	•

M200 • RN.J10... • Insert Selection Guide

Material Group	Light Machining		General Purpose		Heavy Machining	
	Geometry	Grade	Geometry	Grade	Geometry	Grade
P1-P2	ML	WP25PM	MM	WP40PM	MM	WP40PM
P3-P4	ML	WP25PM	MM	WP25PM	MH	WP40PM
P5-P6	ML	WP35CM	MM	WP35CM	MH	WP35CM
M1-M2	ML	WP25PM	ML	WU35PM	MM	WU35PM
M3	ML	WP25PM	MM	WU35PM	MM	WU35PM
K1-K2	MH	WK15CM	MH	WK15CM	MH	WP20CM
K3	MH	WK15CM	MH	WK15CM	MH	WP25PM
N1-N2	ALP	WN25PM	ALP	WN25PM	ALP	WN25PM
N3	ALP	WN25PM	ALP	WN25PM	ALP	WN25PM
S1-S2	ML	WS30PM	MM	WS30PM	MM	WU35PM
S3	ML	WS30PM	MM	WU35PM	MM	WU35PM
S4	ML	WS30PM	MM	WU35PM	MM	WU35PM
H1	MH	WP25PM	MH	WP20CM	-	-

M200 • RN.J10... • Recommended Starting Speeds [m/min]

Material Group		WK15CM			WK15PM			WN25PM			WP20CM			WP25PM		
		P	1	-	-	-	-	-	-	-	-	-	660	580	540	395
	2	-	-	-	-	-	-	-	-	-	410	370	330	330	290	240
	3	-	-	-	-	-	-	-	-	-	370	330	305	305	260	210
	4	-	-	-	-	-	-	-	-	-	275	260	230	270	220	180
	5	-	-	-	-	-	-	-	-	-	330	300	275	220	205	180
	6	-	-	-	-	-	-	-	-	-	230	205	175	200	150	120
M	1	-	-	-	-	-	-	-	-	-	270	240	210	245	215	200
	2	-	-	-	-	-	-	-	-	-	245	210	190	220	190	155
	3	-	-	-	-	-	-	-	-	-	190	175	150	170	145	115
K	1	505	460	410	400	290	215	-	-	-	430	390	355	275	245	220
	2	400	355	330	350	235	170	-	-	-	340	305	280	215	190	180
	3	335	300	275	280	245	165	-	-	-	290	260	240	180	160	145
N	1	-	-	-	-	-	-	1290	1135	1050	-	-	-	-	-	-
	2	-	-	-	-	-	-	1135	1050	910	-	-	-	-	-	-
	3	-	-	-	-	-	-	1135	1050	910	-	-	-	-	-	-
S	1	-	-	-	-	-	-	-	-	-	-	-	-	50	40	30
	2	-	-	-	-	-	-	-	-	-	-	-	-	50	40	30
	3	-	-	-	-	-	-	-	-	-	-	-	-	60	50	30
	4	-	-	-	-	-	-	-	-	-	-	-	-	85	60	40
H	1	-	-	-	-	-	-	-	-	-	170	140	115	145	110	85
	2	-	-	-	-	-	-	-	-	-	-	-	-	-	-	-
	3	-	-	-	-	-	-	-	-	-	-	-	-	-	-	-

Material Group		WP35CM			WP40PM			WS30PM			WS40PM			WU35PM		
		P	1	545	475	445	355	310	295	445	385	360	280	245	230	310
	2	335	305	275	300	260	215	365	325	265	235	205	170	265	230	190
	3	305	275	245	275	235	190	340	290	235	215	185	150	240	205	170
	4	230	210	190	245	205	160	300	245	200	195	160	130	215	180	145
	5	310	275	250	205	185	160	245	230	200	160	140	130	180	160	145
	6	190	160	130	180	140	110	220	170	130	140	110	85	155	120	95
M	1	245	220	185	235	205	185	270	240	220	260	190	115	205	180	160
	2	220	190	170	210	180	150	245	215	175	230	170	105	185	155	130
	3	175	155	140	155	140	110	185	160	125	190	140	80	140	120	95
K	1	355	320	290	-	-	-	-	-	-	-	-	-	-	-	-
	2	280	250	230	-	-	-	-	-	-	-	-	-	-	-	-
	3	235	210	190	-	-	-	-	-	-	-	-	-	-	-	-
N	1	-	-	-	-	-	-	-	-	-	1075	945	945	-	-	-
	2	-	-	-	-	-	-	-	-	-	945	875	845	-	-	-
	3	-	-	-	-	-	-	-	-	-	875	760	760	-	-	-
S	1	-	-	-	50	40	35	55	50	35	62	45	27	40	35	30
	2	-	-	-	50	40	35	55	50	35	55	40	26	40	35	30
	3	-	-	-	60	50	35	65	55	35	64	46	29	55	40	30
	4	80	60	40	80	60	40	100	70	50	90	66	42	70	55	35
H	1	-	-	-	-	-	-	160	120	90	-	-	-	-	-	-
	2	-	-	-	-	-	-	-	-	-	-	-	-	-	-	-
	3	-	-	-	-	-	-	-	-	-	-	-	-	-	-	-

NOTE: FIRST choice starting speeds are in **bold** type.
As the average chip thickness increases, the speed should be decreased.

M200 • RN.J10... • Recommended Starting Feeds [mm]

Light Machining	General Purpose	Heavy Machining
-----------------	-----------------	-----------------

At 5,00 Axial Depth of Cut (ap)

Insert Geometry	Programmed Feed per Tooth (fz) as a % of Radial Depth of Cut (ae)														Insert Geometry	
	5%			10%			20%			30%			40-100%			
ALP	0,12	0,20	0,28	0,08	0,15	0,20	0,06	0,11	0,15	0,06	0,09	0,13	0,05	0,09	0,12	ALP
ML	0,13	0,44	0,80	0,10	0,32	0,57	0,07	0,24	0,43	0,06	0,21	0,37	0,06	0,19	0,34	ML
MM	0,28	0,50	0,91	0,20	0,36	0,66	0,15	0,27	0,49	0,13	0,24	0,43	0,12	0,22	0,39	MM
MH	0,46	0,58	0,96	0,33	0,42	0,69	0,25	0,31	0,51	0,22	0,27	0,45	0,20	0,25	0,41	MH

At 2,50 Axial Depth of Cut (ap)

Insert Geometry	Programmed Feed per Tooth (fz) as a % of Radial Depth of Cut (ae)														Insert Geometry	
	5%			10%			20%			30%			40-100%			
ALP	0,12	0,20	0,28	0,08	0,15	0,20	0,06	0,11	0,15	0,06	0,09	0,13	0,05	0,09	0,12	ALP
ML	0,15	0,51	0,92	0,11	0,37	0,66	0,08	0,27	0,49	0,07	0,24	0,43	0,07	0,22	0,39	ML
MM	0,32	0,58	1,06	0,23	0,42	0,76	0,18	0,31	0,57	0,15	0,27	0,49	0,14	0,25	0,45	MM
MH	0,54	0,67	1,11	0,39	0,48	0,80	0,29	0,36	0,59	0,25	0,32	0,52	0,23	0,29	0,47	MH

At 1,25 Axial Depth of Cut (ap)

Insert Geometry	Programmed Feed per Tooth (fz) as a % of Radial Depth of Cut (ae)														Insert Geometry	
	5%			10%			20%			30%			40-100%			
ALP	0,12	0,20	0,28	0,08	0,15	0,20	0,06	0,11	0,15	0,06	0,09	0,13	0,05	0,09	0,12	ALP
ML	0,20	0,67	1,21	0,14	0,48	0,87	0,11	0,36	0,65	0,09	0,31	0,56	0,09	0,29	0,52	ML
MM	0,43	0,77	1,39	0,31	0,55	1,00	0,23	0,41	0,74	0,20	0,36	0,65	0,18	0,33	0,59	MM
MH	0,70	0,88	1,46	0,51	0,63	1,04	0,38	0,47	0,78	0,33	0,41	0,68	0,30	0,38	0,62	MH

At 0,63 Axial Depth of Cut (ap)

Insert Geometry	Programmed Feed per Tooth (fz) as a % of Radial Depth of Cut (ae)														Insert Geometry	
	5%			10%			20%			30%			40-100%			
ALP	0,12	0,20	0,28	0,08	0,15	0,20	0,06	0,11	0,15	0,06	0,09	0,13	0,05	0,09	0,12	ALP
ML	0,27	0,92	1,67	0,20	0,66	1,19	0,15	0,49	0,89	0,13	0,43	0,77	0,12	0,39	0,71	ML
MM	0,58	1,05	1,92	0,42	0,75	1,37	0,31	0,56	1,02	0,27	0,49	0,88	0,25	0,45	0,81	MM
MH	0,96	1,21	2,02	0,69	0,87	1,43	0,52	0,65	1,06	0,45	0,56	0,93	0,41	0,52	0,85	MH

NOTE: Use "Light Machining" value as starting feed rate.

INDEXABLE MILLING

SOLID END MILLING

HOLEMAKING

TAPPING

TURNING

M200 • RN.J12... • Screw-On End Mills • Metric

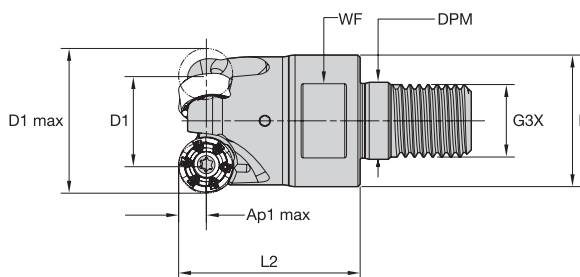

order number	catalogue number	D1 max	D1	D	DPM	G3X	L2	WF	Ap1 max	Z	max ramp angle	max RPM	coolant supply	kg
4147560	M200D32Z03M16RN12	32	20	29	17,0	M16	40	24	3,0	3	0.5	39160	Yes	0,18
4147561	M200D35Z03M16RN12	35	23	29	17,0	M16	40	24	3,0	3	0.4	37440	Yes	0,19
4147562	M200D42Z04M16RN12	42	30	29	17,0	M16	40	24	3,0	4	0.4	34180	Yes	0,23

M200 • RN.J12... • Weldon® Shank • Metric

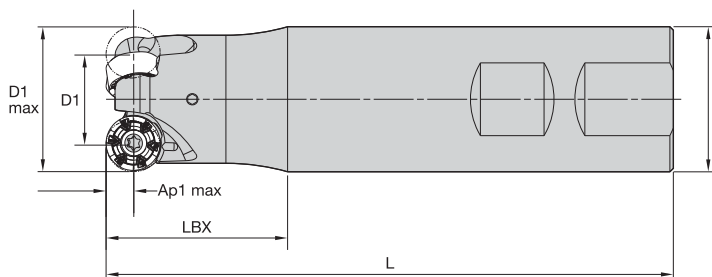

order number	catalogue number	D1 max	D1	D	L	LBX	Ap1 max	Z	max ramp angle	max RPM	coolant supply	kg
4147564	M200D32Z03B32RN12	32	20	32	125	40	3,0	3	0.5	39160	Yes	0,65

FOR SPARE PARTS, PLEASE VISIT WIDIA.COM OR WIDIANOVO.COM.
MOUNTING SCREWS ARE NOT INCLUDED IN STANDARD PACKAGING.

M200 • RN.J12... • Cylindrical Shank • Metric

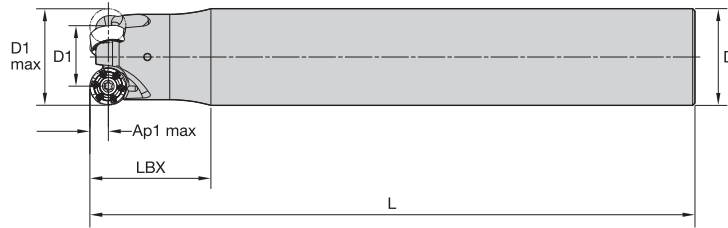

order number	catalogue number	D1 max	D1	D	L	LBX	Ap1 max	Z	max ramp angle	max RPM	coolant supply	kg
4147567	M200D32Z02A32RN12L250	32	20	32	250	40	3,0	2	0.4	39160	Yes	1,42
4147566	M200D32Z03A32RN12L200	32	20	32	200	40	3,0	3	0.5	39160	Yes	1,10

M200 • RN.J12... • Shell Mills • Metric

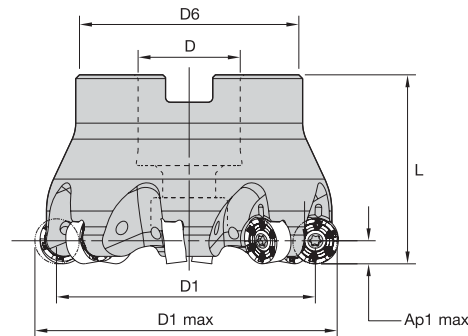

order number	catalogue number	D1 max	D1	D	D6	L	Ap1 max	Z	max ramp angle	max RPM	coolant supply	kg
4147568	M200D40Z04RN12	40	28	16	38	40	3,0	4	0.4	35020	Yes	0,22
4147569	M200D50Z04RN12	50	38	22	42	40	3,0	4	0.5	31330	Yes	0,29
4147570	M200D50Z05RN12	50	38	22	42	40	3,0	5	0.3	31330	Yes	0,29
4147571	M200D52Z05RN12	52	40	22	49	50	3,0	5	0.5	30720	Yes	0,50
4147572	M200D63Z05RN12	63	51	22	49	50	3,0	5	0.5	27910	Yes	0,63
4147573	M200D63Z07RN12	63	51	22	49	50	3,0	7	0.3	27910	Yes	0,63
4147574	M200D66Z07RN12	66	54	27	60	50	3,0	7	0.3	27260	Yes	0,82
4147575	M200D80Z06RN12	80	68	27	60	50	3,0	6	0.5	24760	Yes	1,02
4147576	M200D80Z08RN12	80	68	27	60	50	3,0	8	0.2	24760	Yes	1,02
4147577	M200D100Z07RN12	100	88	32	78	50	3,0	7	0.2	22150	Yes	1,45
4147578	M200D100Z09RN12	100	88	32	78	50	3,0	9	0.2	22150	Yes	1,41

NOTE: Socket-head cap screw with coolant groove and coolant lock screw assembly must be ordered separately.

INDEXABLE MILLING

SOLID END MILLING

HOLEMAKING

TAPPING

TURNING

INDEXABLE MILLING

M200 • RN.J1204.. • RNGJ-ML

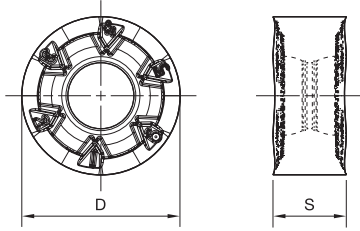

- first choice
- alternate choice

P	■	■	■	■	●	●	●	●	○	●	●
M	■	■	■	○	●	●	●	●	●	●	●
K	■	●	●	○	○	○	○	○	○	○	○
N	■	■	●	○	○	○	○	○	○	○	○
S	■	■	○	○	○	○	○	○	○	○	○
H	■	■	○	○	○	○	○	○	○	○	○

ISO catalogue number	cutting edges	D	S	hm	WK15CM	WK15PM	WN25PM	WP20CM	WP25PM	WP35CM	WP40PM	WS30PM	WS40PM	WU35PM
RNGJ1204M0EML	2	12,00	4,75	0,04	■	■	■	■	■	■	■	○	○	○

SOLID END MILLING

HOLEMAKING

M200 • RN.J1204.. • RNGJ-MM

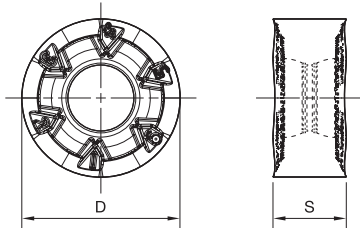
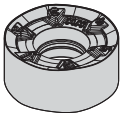

- first choice
- alternate choice

P	■	■	■	■	●	●	●	●	○	●	●
M	■	■	■	○	●	●	●	●	●	●	●
K	■	●	●	○	○	○	○	○	○	○	○
N	■	■	●	○	○	○	○	○	○	○	○
S	■	■	○	○	○	○	○	○	○	○	○
H	■	■	○	○	○	○	○	○	○	○	○

ISO catalogue number	cutting edges	D	S	hm	WK15CM	WK15PM	WN25PM	WP20CM	WP25PM	WP35CM	WP40PM	WS30PM	WS40PM	WU35PM
RNGJ1204M0SMM	2	12,00	4,75	0,09	■	■	■	■	■	■	■	○	○	○

TAPPING

TURNING

M200 • RN.J1204.. • RNGJ-MH

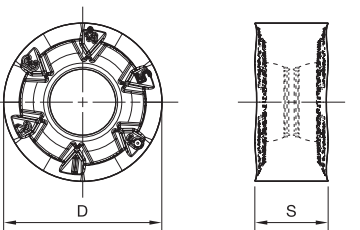
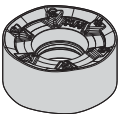

- first choice
- alternate choice

P	■	■	■	■	●	●	●	●	○	●	●
M	■	■	■	○	●	●	●	●	●	●	●
K	■	●	●	○	○	○	○	○	○	○	○
N	■	■	●	○	○	○	○	○	○	○	○
S	■	■	○	○	○	○	○	○	○	○	○
H	■	■	○	○	○	○	○	○	○	○	○

ISO catalogue number	cutting edges	D	S	hm	WK15CM	WK15PM	WN25PM	WP20CM	WP25PM	WP35CM	WP40PM	WS30PM	WS40PM	WU35PM
RNGJ1204M0SMH	2	12,00	4,75	0,19	■	5123900	■	■	5123901	5123903	■	6408154	WS40PM	5123902

M200 • RN.J1204.. • RNPJ-MM

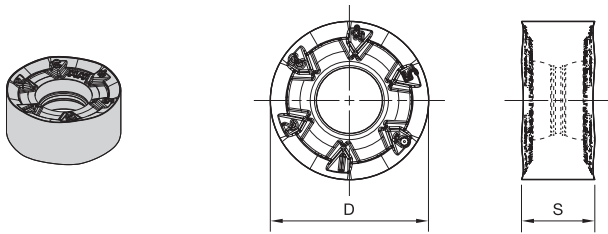

- first choice
- alternate choice

P	■	■	■	■	●	●	●	●	○	●	●
M	■	■	■	○	●	●	●	●	●	●	●
K	■	●	●	○	○	○	○	○	○	○	○
N	■	■	●	○	○	○	○	○	○	○	○
S	■	■	○	○	○	○	○	○	○	○	○
H	■	■	○	○	○	○	○	○	○	○	○

ISO catalogue number	cutting edges	D	S	hm	WK15CM	WK15PM	WN25PM	WP20CM	WP25PM	WP35CM	WP40PM	WS30PM	WS40PM	WU35PM
RNPJ1204M0SMM	2	12,00	4,75	0,09	■	■	■	■	■	■	■	○	○	○

M200 • RN.J1204.. • RNPJ-MH

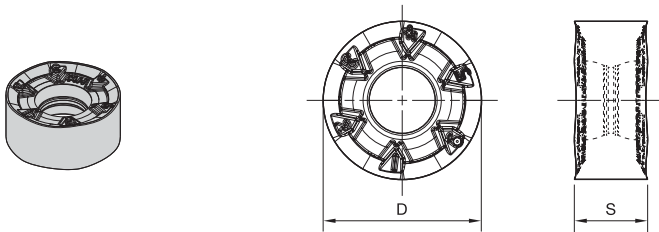

- first choice
- alternate choice

P	■	■	■	■	●	●	●	●	○	●	●	○	●	●
M	■	■	■	○	●	●	●	●	○	○	○	○	○	○
K	■	●	●	○	○	○	○	○	○	○	○	○	○	○
N	■	■	●	○	○	○	○	○	○	○	○	○	○	○
S	■	■	○	○	○	○	○	○	○	○	○	○	○	○
H	■	■	○	○	○	○	○	○	○	○	○	○	○	○

catalogue number	cutting edges	D	S	hm	WK15CM	WK15PM	WN25PM	WP20CM	WP25PM	WP35CM	WP40PM	WS30PM	WS40PM	WU35PM
RNPJ1204M0SMH	12	12,00	4,75	0,18	■	■	■	■	■	■	■	○	○	○

M200 • RN.J1204.. • RNGJ-ALP

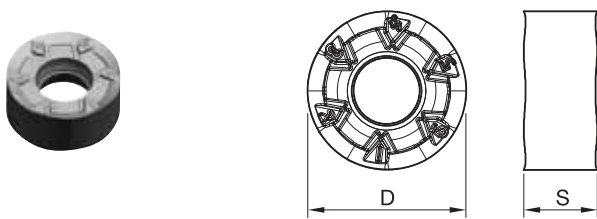

- first choice
- alternate choice

P	■	■	■	■	●	●	●	●	○	●	●	○	●	●
M	■	■	■	○	●	●	●	●	○	○	○	○	○	○
K	■	●	●	○	○	○	○	○	○	○	○	○	○	○
N	■	■	●	○	○	○	○	○	○	○	○	○	○	○
S	■	■	○	○	○	○	○	○	○	○	○	○	○	○
H	■	■	○	○	○	○	○	○	○	○	○	○	○	○

catalogue number	cutting edges	D	S	hm	WK15CM	WK15PM	WN25PM	WP20CM	WP25PM	WP35CM	WP40PM	WS30PM	WS40PM	WU35PM
RNGJ1204M0FALP	12	12,00	4,75	0,02	■	■	6065661	■	■	■	■	■	■	■

M200 RN.J1204.. • Insert Selection Guide

Material Group	Light Machining		General Purpose		Heavy Machining	
	Geometry	Grade	Geometry	Grade	Geometry	Grade
P1-P2	ML	WP25PM	MM	WP40PM	MM	WP40PM
P3-P4	ML	WP25PM	MM	WP25PM	MH	WP40PM
P5-P6	ML	WP35CM	MM	WP35CM	MH	WP35CM
M1-M2	ML	WP25PM	ML	WU35PM	MM	WU35PM
M3	ML	WP25PM	MM	WU35PM	MM	WU35PM
K1-K2	MH	WK15CM	MH	WK15CM	MH	WP20CM
K3	MH	WK15PM	MH	WK15PM	MH	WP25PM
N1-N2	ALP	WN25PM	ALP	WN25PM	ALP	WN25PM
N3	ALP	WN25PM	ALP	WN25PM	ALP	WN25PM
S1-S2	ML	WS30PM	MM	WS30PM	MM	WU35PM
S3	ML	WS30PM	MM	WU35PM	MM	WU35PM
S4	ML	WS30PM	MM	WU35PM	MM	WU35PM
H1	MH	WP25PM	MH	WP20CM	-	-

M200 RN.J1204.. • Recommended Starting Speeds [m/min]

Material Group		WK15CM			WK15PM			WN25PM			WP20CM			WP25PM		
		P	1	-	-	-	-	-	-	-	-	-	660	580	540	395
P	2	-	-	-	-	-	-	-	-	-	410	370	330	330	290	240
P	3	-	-	-	-	-	-	-	-	-	370	330	305	305	260	210
P	4	-	-	-	-	-	-	-	-	-	275	260	230	270	220	180
P	5	-	-	-	-	-	-	-	-	-	330	300	275	220	205	180
P	6	-	-	-	-	-	-	-	-	-	230	205	175	200	150	120
M	1	-	-	-	-	-	-	-	-	-	270	240	210	245	215	200
M	2	-	-	-	-	-	-	-	-	-	245	210	190	220	190	155
M	3	-	-	-	-	-	-	-	-	-	190	175	150	170	145	115
K	1	505	460	410	400	290	215	-	-	-	430	390	355	275	245	220
K	2	400	355	330	350	235	170	-	-	-	340	305	280	215	190	180
K	3	335	300	275	280	245	165	-	-	-	290	260	240	180	160	145
N	1	-	-	-	-	-	-	1290	1135	1050	-	-	-	-	-	-
N	2	-	-	-	-	-	-	1135	1050	910	-	-	-	-	-	-
N	3	-	-	-	-	-	-	1135	1050	910	-	-	-	-	-	-
S	1	-	-	-	-	-	-	-	-	-	-	-	-	50	40	30
S	2	-	-	-	-	-	-	-	-	-	-	-	-	50	40	30
S	3	-	-	-	-	-	-	-	-	-	-	-	-	60	50	30
S	4	-	-	-	-	-	-	-	-	-	-	-	-	85	60	40
H	1	-	-	-	-	-	-	-	-	-	170	140	115	145	110	85
H	2	-	-	-	-	-	-	-	-	-	-	-	-	-	-	-
H	3	-	-	-	-	-	-	-	-	-	-	-	-	-	-	-

Material Group		WP35CM			WP40PM			WS30PM			WS40PM			WU35PM		
		P	1	545	475	445	355	310	295	445	385	360	280	245	230	310
P	2	335	305	275	300	260	215	365	325	265	235	205	170	265	230	190
P	3	305	275	245	275	235	190	340	290	235	215	185	150	240	205	170
P	4	230	210	190	245	205	160	300	245	200	195	160	130	215	180	145
P	5	310	275	250	205	185	160	245	230	200	160	140	130	180	160	145
P	6	190	160	130	180	140	110	220	170	130	140	110	85	155	120	95
M	1	245	220	185	235	205	185	270	240	220	260	190	115	205	180	160
M	2	220	190	170	210	180	150	245	215	175	230	170	105	185	155	130
M	3	175	155	140	155	140	110	185	160	125	190	140	80	140	120	95
K	1	355	320	290	-	-	-	-	-	-	-	-	-	-	-	-
K	2	280	250	230	-	-	-	-	-	-	-	-	-	-	-	-
K	3	235	210	190	-	-	-	-	-	-	-	-	-	-	-	-
N	1	-	-	-	-	-	-	-	-	-	1075	945	945	-	-	-
N	2	-	-	-	-	-	-	-	-	-	945	875	845	-	-	-
N	3	-	-	-	-	-	-	-	-	-	875	760	760	-	-	-
S	1	-	-	-	50	40	35	55	50	35	62	45	27	40	35	30
S	2	-	-	-	50	40	35	55	50	35	55	40	26	40	35	30
S	3	-	-	-	60	50	35	65	55	35	64	46	29	55	40	30
S	4	80	60	40	80	60	40	100	70	50	90	66	42	70	55	35
H	1	-	-	-	-	-	-	160	120	90	-	-	-	-	-	-
H	2	-	-	-	-	-	-	-	-	-	-	-	-	-	-	-
H	3	-	-	-	-	-	-	-	-	-	-	-	-	-	-	-

NOTE: FIRST choice starting speeds are in **bold** type.
As the average chip thickness increases, the speed should be decreased.

M200 RN.J1204.. • Recommended Starting Feeds [mm]

Light Machining	General Purpose	Heavy Machining
-----------------	-----------------	-----------------

At 6,00 Axial Depth of Cut (ap)

Insert Geometry	Programmed Feed per Tooth (fz) as a % of Radial Depth of Cut (ae)														Insert Geometry	
	5%			10%			20%			30%			40-100%			
ALP	0,12	0,20	0,28	0,08	0,15	0,20	0,06	0,11	0,15	0,06	0,09	0,13	0,05	0,09	0,12	ALP
ML	0,12	0,18	0,32	0,09	0,13	0,23	0,07	0,10	0,18	0,06	0,08	0,15	0,05	0,08	0,14	ML
MM	0,28	0,51	0,84	0,21	0,37	0,61	0,15	0,28	0,45	0,13	0,24	0,39	0,12	0,22	0,36	MM
MH	0,46	0,70	1,02	0,33	0,50	0,73	0,25	0,38	0,55	0,22	0,33	0,48	0,20	0,30	0,44	MH

At 3,00 Axial Depth of Cut (ap)

Insert Geometry	Programmed Feed per Tooth (fz) as a % of Radial Depth of Cut (ae)														Insert Geometry	
	5%			10%			20%			30%			40-100%			
ALP	0,12	0,20	0,28	0,08	0,15	0,20	0,06	0,11	0,15	0,06	0,09	0,13	0,05	0,09	0,12	ALP
ML	0,14	0,20	0,37	0,10	0,15	0,27	0,08	0,11	0,20	0,07	0,10	0,18	0,06	0,09	0,16	ML
MM	0,33	0,59	0,97	0,24	0,43	0,70	0,18	0,32	0,52	0,16	0,28	0,45	0,14	0,25	0,42	MM
MH	0,54	0,81	1,18	0,39	0,58	0,85	0,29	0,43	0,63	0,25	0,38	0,55	0,23	0,35	0,51	MH

At 1,50 Axial Depth of Cut (ap)

Insert Geometry	Programmed Feed per Tooth (fz) as a % of Radial Depth of Cut (ae)														Insert Geometry	
	5%			10%			20%			30%			40-100%			
ALP	0,12	0,20	0,28	0,08	0,15	0,20	0,06	0,11	0,15	0,06	0,09	0,13	0,05	0,09	0,12	ALP
ML	0,18	0,27	0,49	0,13	0,19	0,35	0,10	0,15	0,26	0,09	0,13	0,23	0,08	0,12	0,21	ML
MM	0,43	0,77	1,28	0,31	0,56	0,92	0,23	0,42	0,68	0,20	0,36	0,60	0,19	0,33	0,55	MM
MH	0,70	1,06	1,56	0,51	0,76	1,12	0,38	0,57	0,83	0,33	0,50	0,72	0,30	0,45	0,66	MH

At 0,75 Axial Depth of Cut (ap)

Insert Geometry	Programmed Feed per Tooth (fz) as a % of Radial Depth of Cut (ae)														Insert Geometry	
	5%			10%			20%			30%			40-100%			
ALP	0,12	0,20	0,28	0,08	0,15	0,20	0,06	0,11	0,15	0,06	0,09	0,13	0,05	0,09	0,12	ALP
ML	0,25	0,37	0,67	0,18	0,27	0,48	0,14	0,20	0,36	0,12	0,17	0,32	0,11	0,16	0,29	ML
MM	0,59	1,06	1,77	0,43	0,76	1,26	0,32	0,57	0,94	0,28	0,50	0,81	0,25	0,45	0,75	MM
MH	0,96	1,46	2,16	0,69	1,04	1,53	0,52	0,78	1,14	0,45	0,68	0,99	0,41	0,62	0,90	MH

NOTE: Use "Light Machining" value as starting feed rate.

INDEXABLE MILLING

SOLID END MILLING

HOLEMAKING

TAPPING

TURNING

M200 • RN.J16... • Shell Mills • Metric

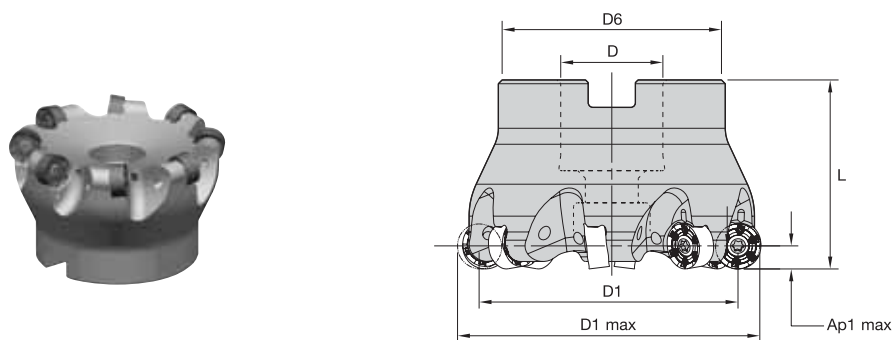

order number	catalogue number	D1 max	D1	D	D6	L	Ap1 max	Z	max ramp angle	max RPM	coolant supply	kg
5209989	M200D50Z04RN16	50	34	22	42	50	4,0	4	0.5	26700	Yes	0,36
5210210	M200D52Z04RN16	52	36	22	42	50	4,0	4	0.4	26000	Yes	0,39
5210211	M200D63Z04RN16	63	47	22	49	50	4,0	4	0.4	22700	Yes	0,58
5210212	M200D63Z06RN16	63	47	22	49	50	4,0	6	0.4	22700	Yes	0,56
5210213	M200D66Z05RN16	66	50	27	60	50	4,0	5	0.4	22000	Yes	0,69
5210214	M200D80Z05RN16	80	64	27	60	50	4,0	5	0.3	19500	Yes	0,88
5210215	M200D80Z07RN16	80	64	27	60	50	4,0	7	0.3	19500	Yes	0,89
5210216	M200D100Z06RN16	100	84	32	78	50	4,0	6	0.3	17000	Yes	1,36
5210217	M200D100Z08RN16	100	84	32	78	50	4,0	8	0.3	17000	Yes	1,37
5210218	M200D125Z08RN16	125	109	40	90	63	4,0	8	0.2	14900	Yes	2,50

NOTE: Socket-head cap screw with coolant groove and coolant lock screw assembly must be ordered separately.

FOR SPARE PARTS, PLEASE VISIT WIDIA.COM OR WIDIANOVO.COM.

MOUNTING SCREWS ARE NOT INCLUDED IN STANDARD PACKAGING.

M200 • RN.J1605.. • RNGJ-ML

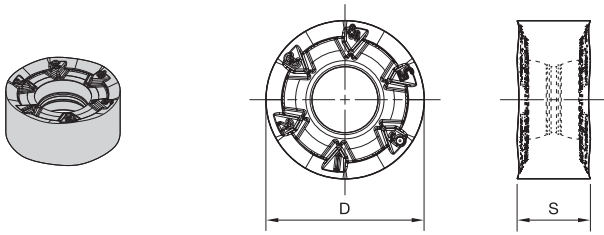

- first choice
- alternate choice

P	■	■	■	■	●	●	●	●	○	●	●
M	■	■	■	○	●	●	●	●	●	●	●
K	■	●	●	●	○	○	○	○	○	○	○
N	■	■	■	○	○	○	○	○	○	○	○
S	■	■	■	○	○	○	○	○	○	○	○
H	■	■	■	○	○	○	○	○	○	○	○

ISO catalogue number	cutting edges	D	S	hm		WK15CM	WK15PM	WN25PM	WP20CM	WP25PM	WP35CM	WP40PM	WS30PM	WS40PM	WU35PM
RNGJ1605M0EML	2	16,00	5,52	0,04		■	■	■	■	■	■	■	○	○	○

M200 • RN.J1605.. • RNPJ-MM

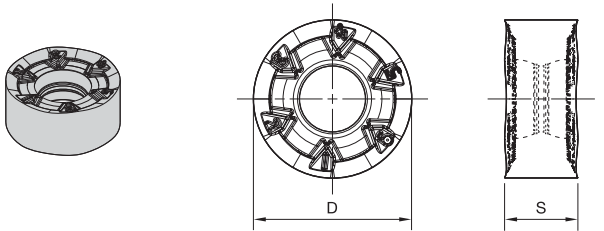

- first choice
- alternate choice

P	■	■	■	■	●	●	●	●	○	●	●
M	■	■	■	○	●	●	●	●	●	●	●
K	■	●	●	●	○	○	○	○	○	○	○
N	■	■	■	○	○	○	○	○	○	○	○
S	■	■	■	○	○	○	○	○	○	○	○
H	■	■	■	○	○	○	○	○	○	○	○

catalogue number	cutting edges	D	S	hm		WK15CM	WK15PM	WN25PM	WP20CM	WP25PM	WP35CM	WP40PM	WS30PM	WS40PM	WU35PM
RNPJ1605M0SMM	12	16,00	5,52	0,09		■	■	■	■	■	■	■	○	○	○

INDEXABLE MILLING

SOLID END MILLING

HOLEMAKING

TAPPING

TURNING

INDEXABLE MILLING

M200 • RN.J1605.. • RNPJ-MH

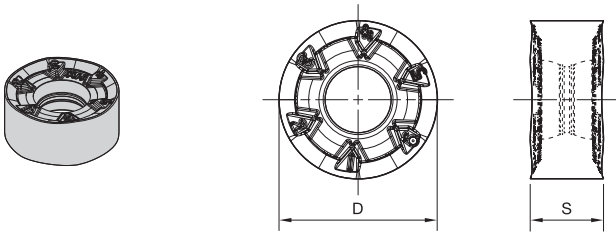

● first choice
○ alternate choice

P	■	■	■	●	●	●	●	○	●	●
M	■	■	■	○	●	●	●	●	●	●
K	■	■	■	○	○	○	○	○	○	○
N	■	■	■	●	○	○	○	○	○	○
S	■	■	■	○	○	○	○	○	○	○
H	■	■	■	○	○	○	○	○	○	○

ISO catalogue number	cutting edges	D	S	hm		WK15CM	WK15PM	WN25PM	WP20CM	WP25PM	WP35CM	WP40PM	WS30PM	WS40PM	WU35PM
RNPJ1605M0SMH	2	16,00	5,52	0,23	5276476	■	■	■	■	5276474	5276473	5542342	6408157	5476636	

SOLID END MILLING

HOLEMAKING

TAPPING

TURNING

M200 • RN.J1605.. • RNGJ-ALP

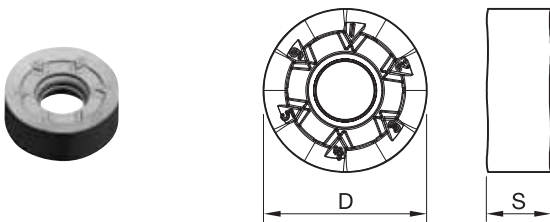

● first choice
○ alternate choice

P	■	■	■	●	●	●	●	○	●	●
M	■	■	■	○	●	●	●	●	●	●
K	■	■	■	○	○	○	○	○	○	○
N	■	■	■	●	○	○	○	○	○	○
S	■	■	■	○	○	○	○	○	○	○
H	■	■	■	○	○	○	○	○	○	○

catalogue number	cutting edges	D	S	hm		WK15CM	WK15PM	WN25PM	WP20CM	WP25PM	WP35CM	WP40PM	WS30PM	WS40PM	WU35PM
RNGJ1605M0FALP	12	16,00	5,52	0,02	6065662	■	■	■	■	■	■	■	■	■	■

M200 • RN.J1605.. • Insert Selection Guide

Material Group	Light Machining		General Purpose		Heavy Machining	
	Geometry	Grade	Geometry	Grade	Geometry	Grade
P1-P2	ML	WP25PM	MM	WP40PM	MM	WP40PM
P3-P4	ML	WP25PM	MM	WP25PM	MH	WP40PM
P5-P6	ML	WP35CM	MM	WP35CM	MH	WP35CM
M1-M2	ML	WP25PM	ML	WU35PM	MM	WU35PM
M3	ML	WP25PM	MM	WU35PM	MM	WU35PM
K1-K2	MH	WK15CM	MH	WK15CM	MH	WP20CM
K3	MH	WK15CM	MH	WP20CM	MH	WP35CM
N1-N2	ALP	WN25PM	ALP	WN25PM	ALP	WN25PM
N3	ALP	WN25PM	ALP	WN25PM	ALP	WN25PM
S1-S2	ML	WS30PM	ML	WS30PM	ML	WU35PM
S3	ML	WS30PM	ML	WU35PM	ML	WU35PM
S4	ML	WS30PM	ML	WU35PM	ML	WU35PM
H1	MH	WP25PM	MH	WP20CM	-	-

INDEXABLE MILLING

SOLID END MILLING

HOLEMAKING

TAPPING

TURNING

M200 • RN.J1605.. • Recommended Starting Speeds [m/min]

INDEXABLE MILLING

SOLID END MILLING

HOLEMAKING

TAPPING

TURNING

Material Group		WK15CM			WK15PM			WN25PM			WP20CM			WP25PM		
P	1	-	-	-	-	-	-	-	-	-	660	580	540	395	340	325
	2	-	-	-	-	-	-	-	-	-	410	370	330	330	290	240
	3	-	-	-	-	-	-	-	-	-	370	330	305	305	260	210
	4	-	-	-	-	-	-	-	-	-	275	260	230	270	220	180
	5	-	-	-	-	-	-	-	-	-	330	300	275	220	205	180
	6	-	-	-	-	-	-	-	-	-	230	205	175	200	150	120
M	1	-	-	-	-	-	-	-	-	-	270	240	210	245	215	200
	2	-	-	-	-	-	-	-	-	-	245	210	190	220	190	155
	3	-	-	-	-	-	-	-	-	-	190	175	150	170	145	115
K	1	505	460	410	400	290	215	-	-	-	430	390	355	275	245	220
	2	400	355	330	350	235	170	-	-	-	340	305	280	215	190	180
	3	335	300	275	280	245	165	-	-	-	290	260	240	180	160	145
N	1	-	-	-	-	-	-	1290	1135	1050	-	-	-	-	-	-
	2	-	-	-	-	-	-	1135	1050	910	-	-	-	-	-	-
	3	-	-	-	-	-	-	1135	1050	910	-	-	-	-	-	-
S	1	-	-	-	-	-	-	-	-	-	-	-	-	50	40	30
	2	-	-	-	-	-	-	-	-	-	-	-	-	50	40	30
	3	-	-	-	-	-	-	-	-	-	-	-	-	60	50	30
	4	-	-	-	-	-	-	-	-	-	-	-	-	85	60	40
H	1	-	-	-	-	-	-	-	-	-	170	140	115	145	110	85
	2	-	-	-	-	-	-	-	-	-	-	-	-	-	-	-
	3	-	-	-	-	-	-	-	-	-	-	-	-	-	-	-

Material Group		WP35CM			WP40PM			WS30PM			WS40PM			WU35PM		
P	1	545	475	445	355	310	295	445	385	360	280	245	230	310	275	260
	2	335	305	275	300	260	215	365	325	265	235	205	170	265	230	190
	3	305	275	245	275	235	190	340	290	235	215	185	150	240	205	170
	4	230	210	190	245	205	160	300	245	200	195	160	130	215	180	145
	5	310	275	250	205	185	160	245	230	200	160	140	130	180	160	145
	6	190	160	130	180	140	110	220	170	130	140	110	85	155	120	95
M	1	245	220	185	235	205	185	270	240	220	260	190	115	205	180	160
	2	220	190	170	210	180	150	245	215	175	230	170	105	185	155	130
	3	175	155	140	155	140	110	185	160	125	190	140	80	140	120	95
K	1	355	320	290	-	-	-	-	-	-	-	-	-	-	-	-
	2	280	250	230	-	-	-	-	-	-	-	-	-	-	-	-
	3	235	210	190	-	-	-	-	-	-	-	-	-	-	-	-
N	1	-	-	-	-	-	-	-	-	-	1075	945	945	-	-	-
	2	-	-	-	-	-	-	-	-	-	945	875	845	-	-	-
	3	-	-	-	-	-	-	-	-	-	875	760	760	-	-	-
S	1	-	-	-	50	40	35	55	50	35	62	45	27	40	35	30
	2	-	-	-	50	40	35	55	50	35	55	40	26	40	35	30
	3	-	-	-	60	50	35	65	55	35	64	46	29	55	40	30
	4	80	60	40	80	60	40	100	70	50	90	66	42	70	55	35
H	1	-	-	-	-	-	-	160	120	90	-	-	-	-	-	-
	2	-	-	-	-	-	-	-	-	-	-	-	-	-	-	-
	3	-	-	-	-	-	-	-	-	-	-	-	-	-	-	-

NOTE: FIRST choice starting speeds are in **bold** type.
As the average chip thickness increases, the speed should be decreased.

M200 • RN.J1605.. • Recommended Starting Feeds [mm]

Light Machining	General Purpose	Heavy Machining
-----------------	-----------------	-----------------

At 8,00mm Axial Depth of Cut (ap)

Insert Geometry	Programmed Feed per Tooth (fz) as a % of Radial Depth of Cut (ae)															Insert Geometry
	5%			10%			20%			30%			40-100%			
ALP	0,12	0,20	0,28	0,08	0,15	0,20	0,06	0,11	0,15	0,06	0,09	0,13	0,05	0,09	0,12	ALP
ML	0,12	0,37	0,48	0,09	0,27	0,35	0,07	0,20	0,26	0,06	0,17	0,23	0,05	0,16	0,21	ML
MM	0,28	0,70	0,81	0,21	0,50	0,58	0,15	0,38	0,44	0,13	0,33	0,38	0,12	0,30	0,35	MM
MH	0,53	0,70	1,17	0,38	0,50	0,84	0,29	0,38	0,63	0,25	0,33	0,55	0,23	0,30	0,50	MH

At 4,00mm Axial Depth of Cut (ap)

Insert Geometry	Programmed Feed per Tooth (fz) as a % of Radial Depth of Cut (ae)															Insert Geometry
	5%			10%			20%			30%			40-100%			
ALP	0,12	0,20	0,28	0,08	0,15	0,20	0,06	0,11	0,15	0,06	0,09	0,13	0,05	0,09	0,12	ALP
ML	0,14	0,43	0,56	0,10	0,31	0,40	0,08	0,23	0,30	0,07	0,20	0,26	0,06	0,18	0,24	ML
MM	0,33	0,81	0,94	0,24	0,58	0,67	0,18	0,43	0,50	0,16	0,38	0,44	0,14	0,35	0,40	MM
MH	0,62	0,81	1,36	0,44	0,58	0,97	0,33	0,43	0,72	0,29	0,38	0,63	0,27	0,35	0,58	MH

At 2,00mm Axial Depth of Cut (ap)

Insert Geometry	Programmed Feed per Tooth (fz) as a % of Radial Depth of Cut (ae)															Insert Geometry
	5%			10%			20%			30%			40-100%			
ALP	0,12	0,20	0,28	0,08	0,15	0,20	0,06	0,11	0,15	0,06	0,09	0,13	0,05	0,09	0,12	ALP
ML	0,19	0,56	0,73	0,14	0,40	0,53	0,10	0,30	0,40	0,09	0,26	0,34	0,08	0,24	0,32	ML
MM	0,43	1,06	1,24	0,31	0,76	0,89	0,23	0,57	0,66	0,20	0,50	0,57	0,19	0,45	0,53	MM
MH	0,81	1,06	1,79	0,58	0,76	1,28	0,44	0,57	0,95	0,38	0,50	0,83	0,35	0,45	0,76	MH

At 1,00mm Axial Depth of Cut (ap)

Insert Geometry	Programmed Feed per Tooth (fz) as a % of Radial Depth of Cut (ae)															Insert Geometry
	5%			10%			20%			30%			40-100%			
ALP	0,12	0,20	0,28	0,08	0,15	0,20	0,06	0,11	0,15	0,06	0,09	0,13	0,05	0,09	0,12	ALP
ML	0,26	0,77	1,01	0,19	0,55	0,73	0,14	0,41	0,54	0,12	0,36	0,47	0,11	0,33	0,43	ML
MM	0,59	1,46	1,70	0,43	1,04	1,21	0,32	0,78	0,90	0,28	0,68	0,79	0,25	0,62	0,72	MM
MH	1,11	1,46	2,48	0,80	1,04	1,75	0,60	0,78	1,30	0,52	0,68	1,13	0,48	0,62	1,03	MH

NOTE: Use "Light Machining" value as starting feed rate.

INDEXABLE MILLING

SOLID END MILLING

HOLEMAKING

TAPPING

TURNING

M170™ Series

M170 IC07, M170 IC10, M170 IC12, M170 IC16 Copy Mills

Use the M170 for hard machining in die and mold manufacturing while maintaining long tool life and smooth chip flow.

Nickel-coated cutter bodies improve tool life and chip flow.

High tooth density for high-speed machining (HSM).

Strong PSTS inserts provide ramping and helical interpolation capabilities.



The M170 is equipped with a hard nickel-coated body and tough PSTS inserts to enhance performance in die and mold manufacturing.

INSERT OFFERING



iC07
7mm iC insert RD.X
Up to 3,5mm Ap max.
Diameter range
12–35mm.



iC10
10mm iC insert RDPX
Up to 5mm Ap max.
Diameter range
20–52mm.



iC12
12mm iC insert RDPX
Up to 6mm Ap max.
Diameter range
24–100mm.



iC16
16mm iC insert RDPX
Up to 8mm Ap max.
Diameter range
32–125mm.

MAXIMIZE PERFORMANCE WITH M170

PRODUCT

SERIES

M170™

DIAMETER RANGE

12–125mm

SHANK TYPES

Screw-On End Mills
Weldon® End Mills
Shell Mills
Cylindrical End Mills

INDUSTRY



APPLICATIONS



3D PROFILING



FACE MILLING



HELICAL MILLING



POCKETING



RAMPING
BLANK



SIDE MILLING/
SHOULDER
MILLING: BALL
NOSE



SLOTTING:
BALL NOSE

STRONG AND DURABLE

The nickel-coated tool body and sturdy PSTS inserts ensure longer tool life.

DIE AND MOLD

Designed and suited for hard machining in die and mold manufacturing.



M170 • Screw-On RD07T1.. • Metric

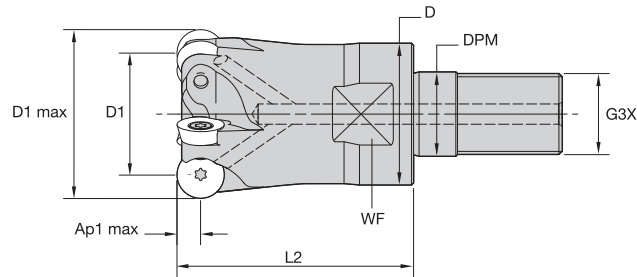

order number	catalogue number	D1 max	D1	D	DPM	G3X	L2	WF	Ap1 max	Z	max ramp angle	max RPM	coolant supply	kg
3935337	M170D012Z02M08RD07T	12	5	13	8,5	M8	23	10	3,5	2	22.0	26200	Yes	0,02

NOTE: All spare parts except the insert screws must be ordered separately.

M170 • Cylindrical Shank RD07T1.. • Metric

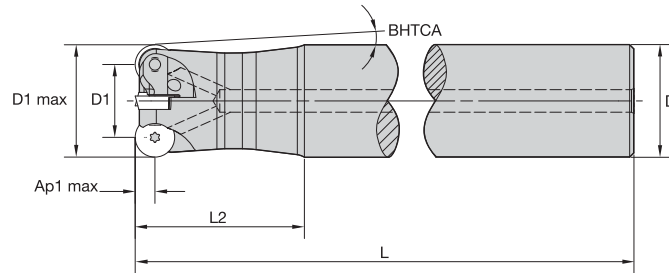

order number	catalogue number	D1 max	D1	D	L	L2	BHTCA	Ap1 max	Z	max ramp angle	max RPM	coolant supply	kg
3935339	M170D012Z02A12RD07TL100	12	5	12	100	20	—	3,5	2	22.0	26200	Yes	0,07
3935340	M170D012Z02A16RD07TL120	12	5	16	120	60	2.0	3,5	2	22.0	26200	Yes	0,14
3935341	M170D012Z02A16RD07TL140	12	5	16	140	80	1.5	3,5	2	22.0	26200	Yes	0,16

NOTE: All spare parts except the insert screws must be ordered separately.

FOR SPARE PARTS, PLEASE VISIT WIDIA.COM OR WIDIANOVO.COM.
MOUNTING SCREWS ARE NOT INCLUDED IN STANDARD PACKAGING.

M170 • RDHX-MH • RD07T1..

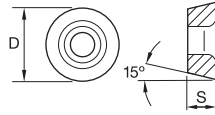
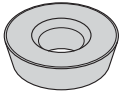

- first choice
- alternate choice

P	<input checked="" type="checkbox"/>	<input type="checkbox"/>	<input type="checkbox"/>	<input type="checkbox"/>
M	<input type="checkbox"/>	<input type="checkbox"/>	<input type="checkbox"/>	<input type="checkbox"/>
K	<input type="checkbox"/>	<input checked="" type="checkbox"/>	<input type="checkbox"/>	<input type="checkbox"/>
N	<input type="checkbox"/>	<input type="checkbox"/>	<input type="checkbox"/>	<input type="checkbox"/>
S	<input type="checkbox"/>	<input type="checkbox"/>	<input type="checkbox"/>	<input checked="" type="checkbox"/>
H	<input type="checkbox"/>	<input checked="" type="checkbox"/>	<input type="checkbox"/>	<input type="checkbox"/>

catalogue number	D	S	hm		
RDHX07T1M0SNMH	7,00	1,98	0,08	TN2505	TN6540
				3960578	3960573
					I

INDEXABLE MILLING

SOLID END MILLING

HOLE/MAKING

TAPPING

TURNING

M170 • Screw-On RD0702.. • Metric

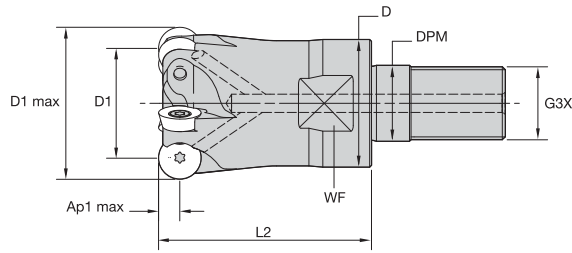

order number	catalogue number	D1 max	D1	D	DPM	G3X	L2	WF	Ap1 max	Z	max ramp angle	max RPM	coolant supply	kg
3926607	M170D015Z02M08RD07	15	8	13	8,5	M8	23	10	3,5	2	18.0	21200	Yes	0,03
3926608	M170D016Z03M08RD07	16	9	13	8,5	M8	23	10	3,5	3	9.0	21200	Yes	0,03
3926609	M170D020Z04M10RD07	20	13	18	10,5	M10	30	14	3,5	4	12.5	19600	Yes	0,06
3926610	M170D025Z05M12RD07	25	18	21	12,5	M12	35	19	3,5	5	8.5	12700	Yes	0,10

NOTE: All spare parts except the insert screws must be ordered separately.

M170 • Weldon® Shank RD0702.. • Metric

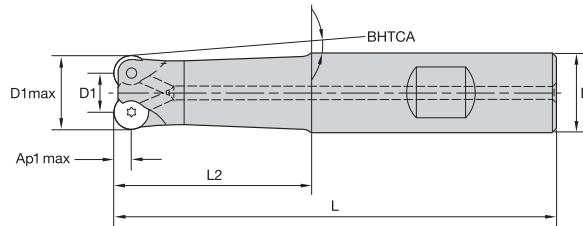

order number	catalogue number	D1 max	D1	D	L	L2	BHTCA	Ap1 max	Z	max ramp angle	max RPM	coolant supply	kg
3929403	M170D015Z02B16RD07	15	8	16	90	40	1.0	3,5	2	18.0	21200	Yes	0,11

NOTE: All spare parts except the insert screws must be ordered separately.

M170 • Cylindrical Shank RD0702.. • Metric

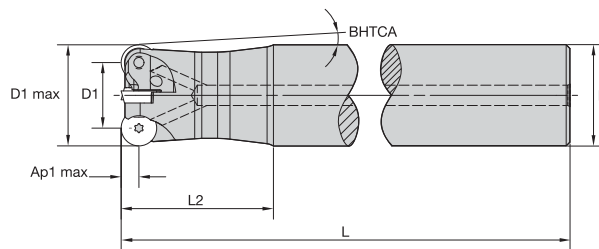

order number	catalogue number	D1 max	D1	D	L	L2	BHTCA	Ap1 max	Z	max ramp angle	max RPM	coolant supply	kg
3929404	M170D015Z02A16RD07L110	15	8	16	110	60	0.5	3,5	2	18.0	21200	Yes	0,14
3929405	M170D015Z02A16RD07L150	15	8	16	150	60	0.5	3,5	2	18.0	21200	Yes	0,20
3929407	M170D016Z02A16RD07L150	16	9	16	150	30	—	3,5	2	9.0	21200	Yes	0,21
3929406	M170D016Z03A16RD07L110	16	9	16	110	20	—	3,5	3	9.0	21200	Yes	0,16
3929409	M170D020Z03A20RD07L140	20	13	20	140	40	—	3,5	3	12.0	10600	Yes	0,29
3929408	M170D020Z04A20RD07L115	20	13	20	115	30	—	3,5	4	12.0	10600	Yes	0,25

NOTE: All spare parts except the insert screws must be ordered separately.

FOR SPARE PARTS, PLEASE VISIT WIDIA.COM OR WIDIANOVO.COM.
MOUNTING SCREWS ARE NOT INCLUDED IN STANDARD PACKAGING.

M170 • RDPX-MH • RD0702..

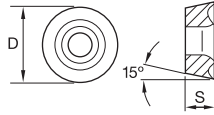
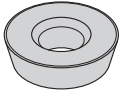

- first choice
- alternate choice

P	●	○	●	●
M	●	○	●	●
K	●	○	○	○
N	●	○	○	○
S	●	○	○	○
H	●	○	○	○

catalogue number	D	S	hm			
RDPX0702M0SNMH	7,00	2,38	0,08	TN2505	TN6525	TN6540
				3959627	3959626	3959625

M170 • RD07.. • Insert Selection Guide

Material Group	Light Machining		General Purpose		Heavy Machining	
	Geometry	Grade	Geometry	Grade	Geometry	Grade
P1-P2	-	-	-	-	-	-
P3-P4	MH	TN2505	MH	TN6525	MH	TN6540
P5-P6	MH	TN2505	MH	TN6525	MH	TN6540
M1-M2	-	-	-	-	-	-
M3	-	-	-	-	-	-
K1-K2	MH	TN2505	MH	TN2505	MH	TN6525
K3	MH	TN2505	MH	TN2505	MH	TN6525
N1-N2	-	-	-	-	-	-
N3	-	-	-	-	-	-
S1-S2	-	-	-	-	-	-
S3	-	-	-	-	-	-
S4	-	-	-	-	-	-
H1	MH	TN2505	MH	TN2505	-	-

INDEXABLE MILLING

SOLID END MILLING

HOLEMAKING

TAPPING

TURNING

M170 • RD07.. • Recommended Starting Speeds [m/min]

Material Group		TN2505			TN6525			TN6540		
P	1	550	420	360	410	320	280	360	280	240
	2	320	240	205	320	250	215	250	190	170
	3	320	240	205	280	215	185	215	170	140
	4	-	-	-	235	170	145	180	130	110
	5	-	-	-	310	235	200	240	180	150
	6	-	-	-	205	160	130	160	120	100
M	1	-	-	-	190	120	80	130	80	60
	2	-	-	-	120	80	50	80	50	40
	3	-	-	-	125	80	55	85	50	40
K	1	400	300	250	275	245	220	220	205	180
	2	540	365	280	215	190	180	175	155	140
	3	310	190	155	180	160	145	155	145	125
N	1	-	-	-	-	-	-	-	-	-
	2	-	-	-	-	-	-	-	-	-
	3	-	-	-	-	-	-	-	-	-
S	1	-	-	-	-	-	-	50	35	30
	2	-	-	-	-	-	-	25	20	10
	3	-	-	-	-	-	-	70	40	30
	4	-	-	-	-	-	-	60	30	25
H	1	175	140	95	-	-	-	-	-	-
	2	175	140	95	-	-	-	-	-	-
	3	140	115	80	-	-	-	-	-	-

NOTE: FIRST choice starting speeds are in **bold** type.
As the average chip thickness increases, the speed should be decreased.

M170 • RD07.. • Recommended Starting Feeds [mm]

Light Machining	General Purpose	Heavy Machining
-----------------	-----------------	-----------------

At 3,50mm Axial Depth of Cut (ap)

Insert Geometry	Programmed Feed per Tooth (fz) as a % of Radial Depth of Cut (ae)															Insert Geometry
	5%			10%			20%			30%			40-100%			
MH	0,23	0,46	0,74	0,17	0,33	0,54	0,13	0,25	0,40	0,11	0,22	0,35	0,10	0,20	0,32	MH

At 1,50mm Axial Depth of Cut (ap)

Insert Geometry	Programmed Feed per Tooth (fz) as a % of Radial Depth of Cut (ae)															Insert Geometry
	5%			10%			20%			30%			40-100%			
MH	0,28	0,56	0,91	0,20	0,41	0,65	0,15	0,31	0,49	0,13	0,27	0,43	0,12	0,24	0,39	MH

At 0,75mm Axial Depth of Cut (ap)

Insert Geometry	Programmed Feed per Tooth (fz) as a % of Radial Depth of Cut (ae)															Insert Geometry
	5%			10%			20%			30%			40-100%			
MH	0,37	0,75	1,21	0,27	0,54	0,87	0,20	0,40	0,65	0,18	0,35	0,56	0,16	0,32	0,52	MH

At 0,50mm Axial Depth of Cut (ap)

Insert Geometry	Programmed Feed per Tooth (fz) as a % of Radial Depth of Cut (ae)															Insert Geometry
	5%			10%			20%			30%			40-100%			
MH	0,45	0,91	1,47	0,32	0,65	1,05	0,24	0,49	0,78	0,21	0,42	0,68	0,19	0,39	0,62	MH

NOTE: Use "Light Machining" value as starting feed rate.

INDEXABLE MILLING

SOLID END MILLING

HOLEMAKING

TAPPING

TURNING

WIDIA™ Indexable Milling Additional Application Advice RD07.. • M170

Selecting the Correct Cutting Values

1. fz depends on the Ap1 and ae values

With round inserts, two factors can affect the hm: Ap1 and ae. fz has to be adjusted accordingly.

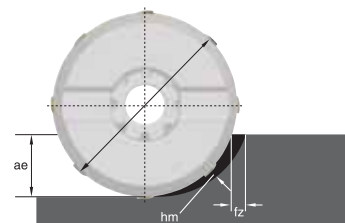

Recommended Starting Feed Rate Values (fz) Related to the Ap1 and ae Values:

ae engagement	10%	20%	30%	40%	50%	100%
Ap1 = 0,5mm	0,59mm	0,42mm	0,34mm	0,30mm	0,26mm	0,19mm
Ap1 = 0,75mm	0,50mm	0,36mm	0,29mm	0,25mm	0,22mm	0,16mm
Ap1 = 1mm	0,42mm	0,30mm	0,24mm	0,21mm	0,19mm	0,13mm
Ap1 = 1,5mm	0,34mm	0,24mm	0,20mm	0,17mm	0,15mm	0,11mm
Ap1 = 3,5mm	0,22mm	0,16mm	0,13mm	0,11mm	0,10mm	0,08mm

Example application highlighted.

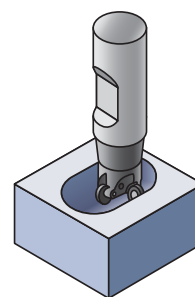

Example Cutting Conditions for RD..07... Insert in Pocketing, L/D ratio = 2 x D:

insert = RDPX0702M0SNMH		TN2505			TN6525			TN6540		
		feed per tooth fz (mm)/ae>50%								
		min	med	max	min	med	max	min	med	max
ae>50%	Recommended starting Ap1 = 0,5mm	0,19mm	0,22mm	0,30mm	0,19mm	0,30mm	0,35mm	0,19mm	0,30mm	0,40mm

2. Ap1 and vc corrections depend on L/D ratio

With increasing L/D ratios, or overhang, vibrations can occur due to reduced rigidity. To ensure successful application, it is recommended to adjust Ap1 and vc values according to the following table:

L/D ratio	% of Ap1 max to reduce	% of vc to reduce
<2	0%	0%
2<L/D<4	65-75%	10-15%
>4	80-95%	20-40%

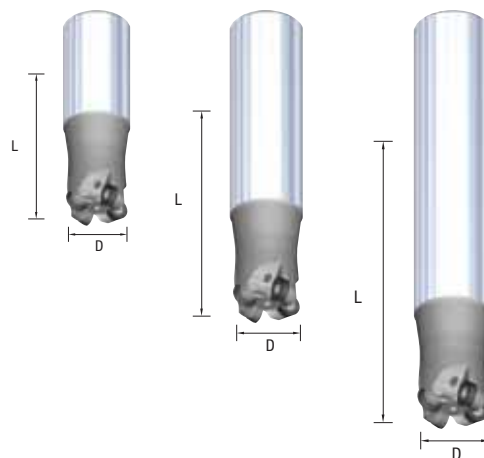

Recommended Cutting Conditions • Helical Interpolation from Solid

cutter diameter	min hole diameter	max hole diameter (flat bottom)	Ap1 max per revolution	max ramp angle	Ap1 max when plunging
12	17mm	17mm	3,5mm	22°	1mm
15	18mm	23mm	2,8mm	18°	2,2mm
16	20mm	25mm	1,9mm	9°	1,4mm
20	28mm	33mm	3,5mm	12°	1,5mm
25	36,5mm	43mm	3,5mm	8.5°	2,5mm
30	46,4mm	53mm	3,5mm	6.5°	2,5mm

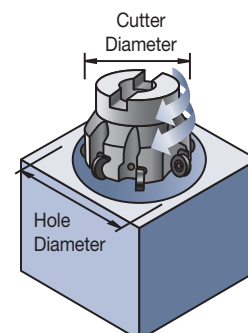

M170 • Screw-On RD1003.. • Metric

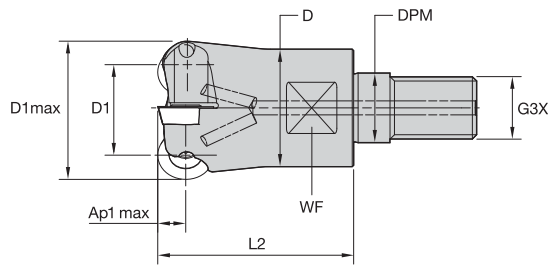

order number	catalogue number	D1 max	D1	D	DPM	G3X	L2	WF	Ap1 max	Z	max ramp angle	max RPM	coolant supply	kg
3934647	M170D020Z02M10RD10	20	10	18	10,5	M10	30	15	5,0	2	20.0	15900	Yes	0,06
3934649	M170D025Z03M12RD10	25	15	21	12,5	M12	35	19	5,0	3	8.0	12800	Yes	0,10
3934650	M170D030Z04M16RD10	30	20	29	17,0	M16	43	22	5,0	4	10.0	10600	Yes	0,24
3934652	M170D042Z06M16RD10	42	32	29	17,0	M16	45	22	5,0	6	6.0	7800	Yes	0,28

NOTE: All spare parts except the insert screws must be ordered separately.

M170 • Weldon® Shank RD1003.. • Metric

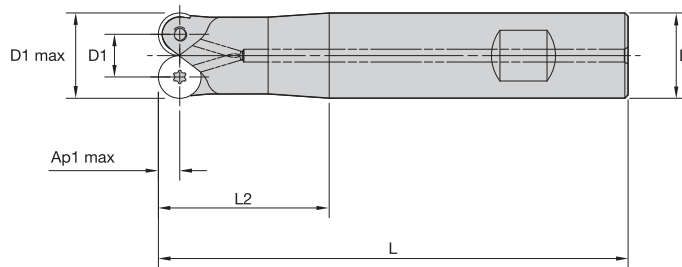

order number	catalogue number	D1 max	D1	D	L	L2	Ap1 max	Z	max ramp angle	max RPM	coolant supply	kg
3940703	M170D020Z02B20RD10	20	10	20	110	40	5,0	2	20.0	15900	Yes	0,24
3940708	M170D025Z03B25RD10	25	15	25	110	40	5,0	3	9.0	12900	Yes	0,35

NOTE: All spare parts except the insert screws must be ordered separately.

FOR SPARE PARTS, PLEASE VISIT WIDIA.COM OR WIDIANOVO.COM.
MOUNTING SCREWS ARE NOT INCLUDED IN STANDARD PACKAGING.

M170 • Cylindrical Shank RD1003.. • Metric

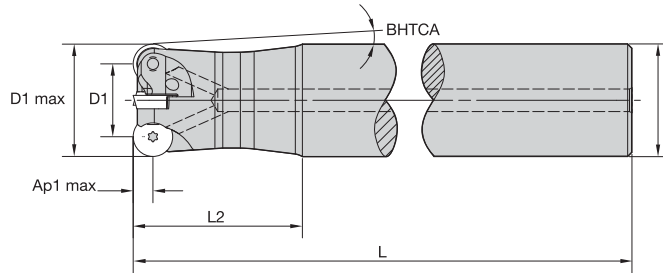

order number	catalogue number	D1 max	D1	D	L	L2	BHTCA	Ap1 max	Z	max ramp angle	max RPM	coolant supply	kg
3940704	M170D020Z02A20RD10L140	20	10	20	140	60	—	5,0	2	20,0	15900	Yes	0,30
3940705	M170D020Z02A25RD10L160	20	10	25	160	80	2,0	5,0	2	20,0	15900	Yes	0,48
3940706	M170D020Z02A25RD10L180	20	10	25	180	100	1,5	5,0	2	20,0	15900	Yes	0,53
3940707	M170D022Z02A20RD10L160	22	12	20	160	40	—	5,0	2	12,0	14400	Yes	0,35
3940709	M170D025Z02A25RD10L180	25	15	25	180	70	—	5,0	2	9,0	12800	Yes	0,61
3940710	M170D025Z02A25RD10L220	25	15	25	220	100	—	5,0	2	9,0	12800	Yes	0,74

NOTE: All spare parts except the insert screws must be ordered separately.

M170 • Shell Mills RD1003.. • Metric

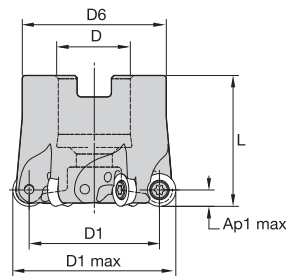

order number	catalogue number	D1 max	D1	D	D6	L	Ap1 max	Z	max ramp angle	max RPM	coolant supply	kg
3940712	M170D040Z05RD10	40	30	16	37	40	5,0	5	7,2	9950	Yes	0,28
3940723	M170D042Z05RD10	42	32	16	37	40	5,0	5	5,8	9500	Yes	0,28
3940724	M170D050Z06RD10	50	40	22	44	40	5,0	6	5,2	7950	Yes	0,35
3940725	M170D052Z06RD10	52	42	22	44	50	5,0	6	3,0	7650	Yes	0,51

NOTE: All spare parts except the insert screws must be ordered separately.

INDEXABLE MILLING

M170 • RDPX-MM • RD1003..

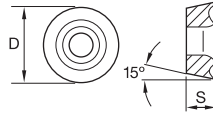
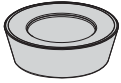

- first choice
- alternate choice

P	■	○	●	●
M	■	○	○	●
K	■	●	○	○
N	■	○	○	○
S	■	○	○	○
H	■	●	○	○

SOLID END MILLING

catalogue number	D	S	hm	TN2505	TN6525	TN6540
RDPX1003M0SNMM	10,00	3,18	0,11	●	○	○

HOLE/MAKING

M170 • RDPX-MH • RD1003..

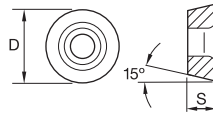
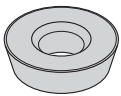

- first choice
- alternate choice

P	■	○	●	●
M	■	○	○	●
K	■	●	○	○
N	■	○	○	○
S	■	○	○	○
H	■	●	○	○

TAPPING

catalogue number	D	S	hm	TN2505	TN6525	TN6540
RDPX1003M0SNMH	10,00	3,18	0,12	○	○	○

TURNING

M170 • RD1003.. • Insert Selection Guide

Material Group	Light Machining		General Purpose		Heavy Machining	
	Geometry	Grade	Geometry	Grade	Geometry	Grade
P1-P2	MM	TN6525	MM	TN6525	MM	TN6540
P3-P4	MH	TN2505	MH	TN6525	MH	TN6540
P5-P6	MH	TN2505	MH	TN6525	MH	TN6540
M1-M2	-	-	MM	TN6525	MM	TN6540
M3	-	-	MM	TN6525	MM	TN6540
K1-K2	MH	TN2505	MH	TN2505	MH	TN6525
K3	MH	TN2505	MH	TN2505	MH	TN6525
N1-N2	-	-	-	-	-	-
N3	-	-	-	-	-	-
S1-S2	-	-	MM	TN6540	-	-
S3	-	-	MM	TN6540	-	-
S4	-	-	MM	TN6540	-	-
H1	MH	TN2505	MH	TN2505	-	-

M170 • RD1003.. • Recommended Starting Speeds [m/min]

Material Group		TN2505			TN6525			TN6540		
P	1	550	420	360	410	320	280	360	280	240
	2	320	240	205	320	250	215	250	190	170
	3	320	240	205	280	215	185	215	170	140
	4	-	-	-	235	170	145	180	130	110
	5	-	-	-	310	235	200	240	180	150
	6	-	-	-	205	160	130	160	120	100
M	1	-	-	-	190	120	80	130	80	60
	2	-	-	-	120	80	50	80	50	40
	3	-	-	-	125	80	55	85	50	40
K	1	400	300	250	275	245	220	220	205	180
	2	540	365	280	215	190	180	175	155	140
	3	310	190	155	180	160	145	155	145	125
N	1	-	-	-	-	-	-	-	-	-
	2	-	-	-	-	-	-	-	-	-
	3	-	-	-	-	-	-	-	-	-
S	1	-	-	-	-	-	-	50	35	30
	2	-	-	-	-	-	-	25	20	10
	3	-	-	-	-	-	-	70	40	30
	4	-	-	-	-	-	-	60	30	25
H	1	175	140	95	-	-	-	-	-	-
	2	175	140	95	-	-	-	-	-	-
	3	140	115	80	-	-	-	-	-	-

NOTE: FIRST choice starting speeds are in **bold** type.
As the average chip thickness increases, the speed should be decreased.

M170 • RD1003.. • Recommended Starting Feeds [mm]

Light Machining	General Purpose	Heavy Machining
-----------------	-----------------	-----------------

At 5,00mm Axial Depth of Cut (ap)

Insert Geometry	Programmed Feed per Tooth (fz) as a % of Radial Depth of Cut (ae)															Insert Geometry
	5%			10%			20%			30%			40-100%			
MM	0,28	0,41	0,74	0,20	0,29	0,53	0,15	0,22	0,4	0,13	0,19	0,35	0,12	0,18	0,32	MM
MH	0,33	0,58	0,98	0,24	0,42	0,71	0,18	0,32	0,53	0,16	0,28	0,46	0,14	0,25	0,42	MH

At 2,00mm Axial Depth of Cut (ap)

Insert Geometry	Programmed Feed per Tooth (fz) as a % of Radial Depth of Cut (ae)															Insert Geometry
	5%			10%			20%			30%			40-100%			
MM	0,35	0,51	0,93	0,25	0,37	0,67	0,19	0,28	0,50	0,17	0,24	0,44	0,15	0,22	0,40	MM
MH	0,42	0,73	1,23	0,30	0,53	0,88	0,23	0,39	0,66	0,20	0,34	0,57	0,18	0,32	0,53	MH

At 1,00mm Axial Depth of Cut (ap)

Insert Geometry	Programmed Feed per Tooth (fz) as a % of Radial Depth of Cut (ae)															Insert Geometry
	5%			10%			20%			30%			40-100%			
MM	0,47	0,68	1,25	0,34	0,49	0,89	0,25	0,37	0,67	0,22	0,32	0,58	0,20	0,29	0,53	MM
MH	0,56	0,98	1,66	0,40	0,71	1,18	0,30	0,53	0,88	0,26	0,46	0,76	0,24	0,42	0,70	MH

At 0,50mm Axial Depth of Cut (ap)

Insert Geometry	Programmed Feed per Tooth (fz) as a % of Radial Depth of Cut (ae)															Insert Geometry
	5%			10%			20%			30%			40-100%			
MM	0,64	0,94	1,73	0,46	0,68	1,24	0,35	0,51	0,92	0,30	0,44	0,80	0,28	0,40	0,73	MM
MH	0,77	1,36	2,31	0,55	0,97	1,63	0,41	0,73	1,21	0,36	0,63	1,05	0,33	0,58	0,96	MH

NOTE: Use "Light Machining" value as starting feed rate.

WIDIA™ Indexable Milling Additional Application Advice RD1003.. • M170

Selecting the Correct Cutting Values

1. fz depends on the Ap1 and ae values

With round inserts, two factors can affect the hm: Ap1 and ae. fz has to be adjusted accordingly.

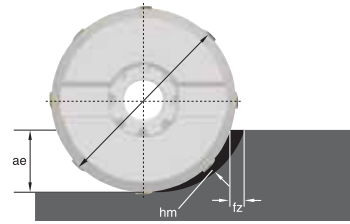

Recommended Starting Feed Rate Values (fz) Related to the Ap1 and ae Values:

ae engagement	10%	20%	30%	40%	50%	100%
Ap1 = 0,5mm	1,18mm	0,70mm	0,63mm	0,56mm	0,50mm	0,35mm
Ap1 = 0,75mm	0,95mm	0,62mm	0,56mm	0,50mm	0,45mm	0,30mm
Ap1 = 1mm	0,80mm	0,57mm	0,46mm	0,40mm	0,36mm	0,25mm
Ap1 = 2mm	0,57mm	0,40mm	0,33mm	0,28mm	0,25mm	0,18mm
Ap1 = 3mm	0,46mm	0,33mm	0,27mm	0,23mm	0,21mm	0,15mm
Ap1 = 5mm	0,36mm	0,25mm	0,21mm	0,18mm	0,16mm	0,11mm

Example application highlighted.

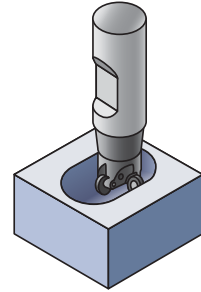

Example Cutting Conditions for RD..10... Insert in Pocketing, L/D ratio = 2 x D:

insert = RDPX1003M0SN			TN2505			TN6525			TN6540		
			feed per tooth fz (mm)/ae>50%								
			min	med	max	min	med	max	min	med	max
Edge Geometry MM	ae>50%	Recommended starting Ap1 = 1mm	-	-	-	0,25mm	0,30mm	0,40mm	0,25mm	0,32mm	0,45mm
Edge Geometry MH	ae>50%	Recommended starting Ap1 = 1mm	0,25mm	0,32mm	0,40mm	0,25mm	0,35mm	0,55mm	0,25mm	0,45mm	0,65mm

2. Ap1 and vc corrections depend on L/D ratio

With increasing L/D ratios, or overhang, vibrations can occur due to reduced rigidity. To ensure successful application, it is recommended to adjust Ap1 and vc values according to the following table:

L/D ratio	% of Ap1 max to reduce	% of vc to reduce
<2	0%	0%
2<L/D<4	65-75%	10-15%
>4	80-95%	20-40%

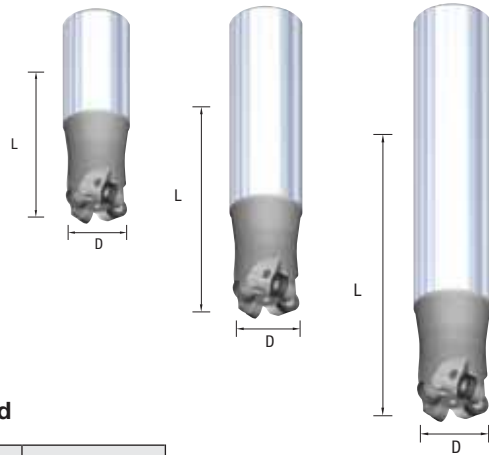

Recommended Cutting Conditions • Helical Interpolation from Solid

cutter diameter	min hole diameter	max hole diameter (flat bottom)	Ap1 max per revolution	max ramp angle	Ap1 max when plunging
20	22mm	30mm	2,1mm	20°	4mm
22	24mm	34mm	2,1mm	20°	2,4mm
25	33mm	40mm	3,2mm	8°	1,7mm
28	36mm	46mm	5mm	15°	3,8mm
30	40,6mm	50mm	5mm	10°	3,4mm
35	50,7mm	60mm	5mm	8,5°	3,4mm
40	60,5mm	70mm	5mm	7,2°	3,6mm
42	64,5mm	74mm	5mm	5,8°	3,6mm
50	80,3mm	90mm	5mm	5,2°	4mm
52	85,8mm	94mm	5mm	3°	2,2mm

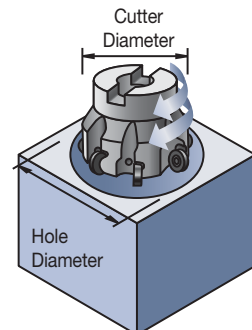

M170 • Screw-On RD12T3.. • Metric

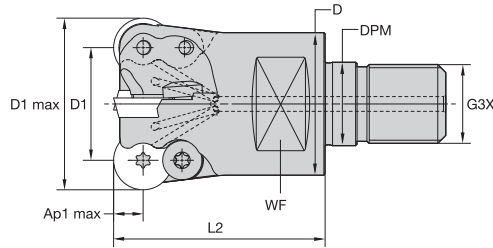

order number	catalogue number	D1 max	D1	D	DPM	G3X	L2	WF	Ap1 max	Z	max ramp angle	max RPM	coolant supply	kg
3930954	M170D035Z03M16RD12	35	23	29	17,0	M16	43	22	6,0	3	11,0	9900	Yes	0,22
3930956	M170D035Z04M16RD12	35	23	29	17,0	M16	43	22	6,0	4	10,5	9900	Yes	0,21

NOTE: All spare parts except the insert screws must be ordered separately.

M170 • Weldon® Shank RD12T3.. • Metric

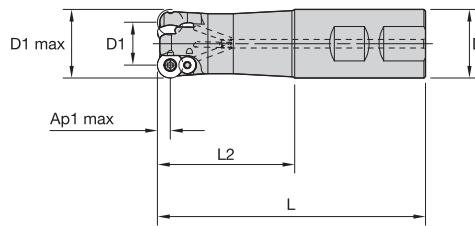

order number	catalogue number	D1 max	D1	D	L	L2	Ap1 max	Z	max ramp angle	max RPM	coolant supply	kg
3930960	M170D032Z03B32RD12	32	20	32	125	64	6,0	3	12,0	9500	Yes	0,63

NOTE: All spare parts except the insert screws must be ordered separately.

M170 • Shell Mills RD12T3.. • Metric

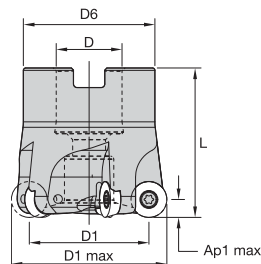

order number	catalogue number	D1 max	D1	D	D6	L	Ap1 max	Z	max ramp angle	max RPM	coolant supply	kg
3930968	M170D040Z04RD12	40	28	16	37	40	6,0	4	9,3	7000	Yes	0,22
3930970	M170D050Z05RD12	50	38	22	44	40	6,0	5	6,1	7950	Yes	0,32
3930972	M170D052Z05RD12	52	40	22	44	50	6,0	5	4,5	7600	Yes	0,44
3930975	M170D063Z06RD12	63	51	22	44	40	6,0	6	4,5	6300	Yes	0,45
3930976	M170D066Z06RD12	66	54	27	60	50	6,0	6	4,5	6030	Yes	0,81
3930979	M170D080Z07RD12	80	68	27	60	50	6,0	7	3,5	4900	Yes	0,97
3930981	M170D100Z08RD12	100	88	32	80	55	6,0	8	2,2	3900	Yes	1,95

NOTE: Socket-head cap screw, socket-head cap screw with coolant groove, low-head cap screw with coolant groove, and Torx driver must be ordered separately.

FOR SPARE PARTS, PLEASE VISIT WIDIA.COM OR WIDIANOVO.COM.
MOUNTING SCREWS ARE NOT INCLUDED IN STANDARD PACKAGING.

M170 • RDPX-MM • RD12T3..

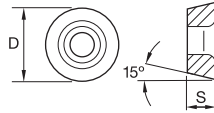
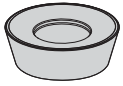

- first choice
- alternate choice

P	●	○	●	○
M	●	○	●	○
K	●	○	●	○
N	○	○	○	○
S	○	○	○	○
H	○	○	○	○

catalogue number	D	S	hm	TN2505	TN6525	TN6540
RDPX12T3M0SNMM	12,00	3,97	0,13	●	○	○

M170 • RDPX-MH • RD12T3..

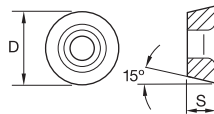
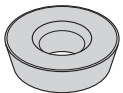

- first choice
- alternate choice

P	●	○	●	○
M	●	○	●	○
K	●	○	●	○
N	○	○	○	○
S	○	○	○	○
H	○	○	○	○

catalogue number	D	S	hm	TN2505	TN6525	TN6540
RDPX12T3M0SNMH	12,00	3,97	0,17	○	○	○

M170 • RD12T3.. • Insert Selection Guide

Material Group	Light Machining		General Purpose		Heavy Machining	
	Geometry	Grade	Geometry	Grade	Geometry	Grade
P1-P2	MM	TN6525	MM	TN6525	MM	TN6540
P3-P4	MH	TN2505	MH	TN6525	MH	TN6540
P5-P6	MH	TN2505	MH	TN6525	MH	TN6540
M1-M2	-	-	MM	TN6525	MM	TN6540
M3	-	-	MM	TN6525	MM	TN6540
K1-K2	MH	TN2505	MH	TN2505	MH	TN6525
K3	MH	TN2505	MH	TN2505	MH	TN6525
N1-N2	-	-	-	-	-	-
N3	-	-	-	-	-	-
S1-S2	-	-	MM	TN6540	-	-
S3	-	-	MM	TN6540	-	-
S4	-	-	MM	TN6540	-	-
H1	MH	TN2505	MH	TN2505	-	-

M170 • RD12T3.. • Recommended Starting Speeds [m/min]

Material Group		TN2505			TN6525			TN6540		
P	1	550	420	360	410	320	280	360	280	240
	2	320	240	205	320	250	215	250	190	170
	3	320	240	205	280	215	185	215	170	140
	4	-	-	-	235	170	145	180	130	110
	5	-	-	-	310	235	200	240	180	150
	6	-	-	-	205	160	130	160	120	100
M	1	-	-	-	190	120	80	130	80	60
	2	-	-	-	120	80	50	80	50	40
	3	-	-	-	125	80	55	85	50	40
K	1	400	300	250	275	245	220	220	205	180
	2	540	365	280	215	190	180	175	155	140
	3	310	190	155	180	160	145	155	145	125
N	1	-	-	-	-	-	-	-	-	-
	2	-	-	-	-	-	-	-	-	-
	3	-	-	-	-	-	-	-	-	-
S	1	-	-	-	-	-	-	50	35	30
	2	-	-	-	-	-	-	25	20	10
	3	-	-	-	-	-	-	70	40	30
	4	-	-	-	-	-	-	60	30	25
H	1	175	140	95	-	-	-	-	-	-
	2	175	140	95	-	-	-	-	-	-
	3	140	115	80	-	-	-	-	-	-

NOTE: FIRST choice starting speeds are in **bold** type.
As the average chip thickness increases, the speed should be decreased.

M170 • RD12T3.. • Recommended Starting Feeds [mm]

Light Machining	General Purpose	Heavy Machining
-----------------	-----------------	-----------------

At 6,00mm Axial Depth of Cut (ap)

Insert Geometry	Programmed Feed per Tooth (fz) as a % of Radial Depth of Cut (ae)															Insert Geometry
	5%			10%			20%			30%			40-100%			
MM	0,33	0,48	0,76	0,24	0,35	0,54	0,18	0,26	0,41	0,16	0,23	0,35	0,14	0,21	0,33	MM
MH	0,35	0,70	1,17	0,25	0,50	0,84	0,19	0,38	0,63	0,16	0,33	0,55	0,15	0,30	0,50	MH

At 3,00mm Axial Depth of Cut (ap)

Insert Geometry	Programmed Feed per Tooth (fz) as a % of Radial Depth of Cut (ae)															Insert Geometry
	5%			10%			20%			30%			40-100%			
MM	0,38	0,56	0,88	0,28	0,40	0,63	0,21	0,30	0,47	0,18	0,26	0,41	0,17	0,24	0,38	MM
MH	0,40	0,81	1,36	0,29	0,58	0,97	0,22	0,43	0,72	0,19	0,38	0,63	0,17	0,35	0,58	MH

At 2,00mm Axial Depth of Cut (ap)

Insert Geometry	Programmed Feed per Tooth (fz) as a % of Radial Depth of Cut (ae)															Insert Geometry
	5%			10%			20%			30%			40-100%			
MM	0,44	0,65	1,02	0,32	0,47	0,73	0,24	0,35	0,55	0,21	0,30	0,48	0,19	0,28	0,44	MM
MH	0,47	0,94	1,59	0,34	0,68	1,13	0,25	0,50	0,84	0,22	0,44	0,73	0,20	0,40	0,67	MH

At 1,00mm Axial Depth of Cut (ap)

Insert Geometry	Programmed Feed per Tooth (fz) as a % of Radial Depth of Cut (ae)															Insert Geometry
	5%			10%			20%			30%			40-100%			
MM	0,60	0,88	1,38	0,43	0,63	0,99	0,32	0,47	0,74	0,28	0,41	0,64	0,26	0,38	0,59	MM
MH	0,63	1,28	2,16	0,45	0,91	1,53	0,34	0,68	1,14	0,30	0,59	0,99	0,27	0,54	0,90	MH

NOTE: Use "Light Machining" value as starting feed rate.

WIDIA™ Indexable Milling Additional Application Advice RD12T3.. • M170

Selecting the Correct Cutting Values

1. fz depends on the Ap1 and ae values

With round inserts, two factors can affect the hm: Ap1 and ae. fz has to be adjusted accordingly.

Recommended Starting Feed Rate Values (fz) Related to the Ap1 and ae Values:

ae engagement	10%	20%	30%	40%	50%	100%
Ap1 = 1mm	1,01mm	0,77mm	0,63mm	0,55mm	0,49mm	0,35mm
Ap1 = 2mm	0,77mm	0,55mm	0,45mm	0,39mm	0,35mm	0,24mm
Ap1 = 3mm	0,63mm	0,45mm	0,37mm	0,32mm	0,28mm	0,20mm
Ap1 = 4mm	0,55mm	0,39mm	0,32mm	0,27mm	0,24mm	0,17mm
Ap1 = 5mm	0,49mm	0,35mm	0,28mm	0,24mm	0,22mm	0,15mm
Ap1 = 6mm	0,45mm	0,32mm	0,26mm	0,22mm	0,20mm	0,14mm

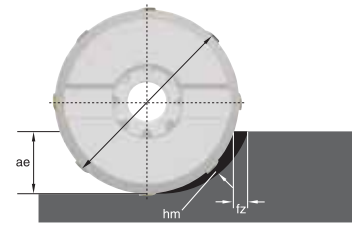

Example application highlighted.

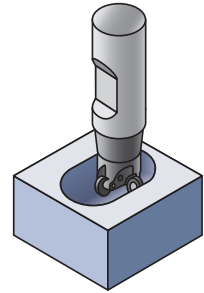

Example Cutting Conditions for RD..10... Insert in Pocketing, L/D ratio = 2 x D:

insert = RDPX12T3M0SN			TN2505			TN6525			TN6540		
			feed per tooth fz (mm)/ae>50%								
			min	med	max	min	med	max	min	med	max
Edge Geometry MM	ae>50%	Recommended starting Ap1 = 2mm	-	-	-	0,24mm	0,30mm	0,50mm	0,24mm	0,40mm	0,60mm
Edge Geometry MH	ae>50%	Recommended starting Ap1 = 2mm	0,24mm	0,30mm	0,50mm	0,24mm	0,40mm	0,65mm	0,24mm	0,50mm	0,70mm

2. Ap1 and vc corrections depend on L/D ratio

With increasing L/D ratios, or overhang, vibrations can occur due to reduced rigidity. To ensure successful application, it is recommended to adjust Ap1 and vc values according to the following table:

L/D ratio	% of Ap1 max to reduce	% of vc to reduce
<2	0%	0%
2<L/D<4	65-75%	10-15%
>4	80-95%	20-40%

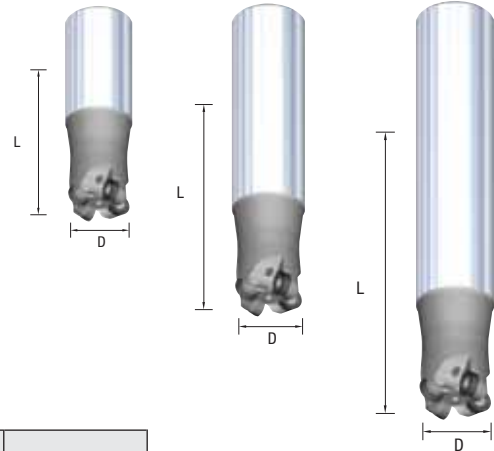

Recommended Cutting Conditions • Helical Interpolation from Solid

cutter diameter	min hole diameter	max hole diameter (flat bottom)	Ap1 max per revolution	max ramp angle	Ap1 max when plunging
24	25,6mm	36mm	1,3mm	15°	3mm
32	40,6mm	52mm	5,3mm	12°	4,4mm
35	46,9mm	58mm	6mm	11°	3,9mm
40	57,4mm	68mm	6mm	9,3°	3,3mm
42	61,2mm	72mm	6mm	7,2°	3,5mm
50	77,4mm	88mm	6mm	6,1°	3,5mm
52	81,3mm	92mm	6mm	4,5°	3,2mm
63	102,4mm	114mm	6mm	4,5°	4,6mm
66	108,5mm	120mm	6mm	4,5°	4,4mm
80	136,5mm	148mm	6mm	3,5°	4,2mm
100	176,5mm	188mm	6mm	2,2°	4,2mm

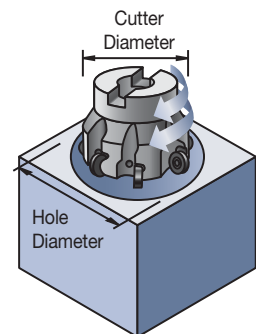

M170 • Screw-On RD1604.. • Metric

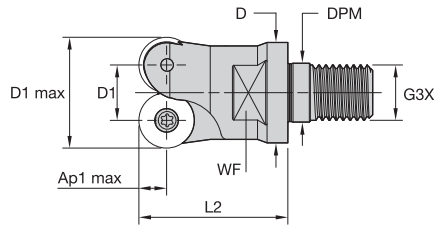

order number	catalogue number	D1 max	D1	D	DPM	G3X	L2	WF	Ap1 max	Z	max ramp angle	max RPM	coolant supply	kg
3926601	M170D032Z02M16RD16	32	16	29	17,0	M16	43	22	8,0	2	20.0	9950	Yes	0,17

NOTE: All spare parts except the insert screws must be ordered separately.

M170 • Shell Mills RD1604.. • Metric

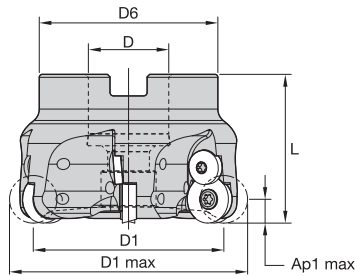

order number	catalogue number	D1 max	D1	D	D6	L	L1	Ap1 max	Z	max ramp angle	max RPM	coolant supply	kg
3926602	M170D050Z04RD16	50	34	22	44	40	40	8,0	4	8.5	7900	Yes	0,28
3934623	M170D052Z04RD16	52	36	22	44	50	50	8,0	4	8.2	7650	Yes	0,36
3934624	M170D063Z05RD16	63	47	22	44	40	40	8,0	5	5.5	5300	Yes	0,39
3934626	M170D080Z06RD16	80	64	27	60	50	50	8,0	6	3.0	4900	Yes	1,06
3934629	M170D125Z08RD16	125	109	40	90	60	60	8,0	8	2.2	3200	Yes	2,90

NOTE: All spare parts except the insert screws and clamp screws must be ordered separately.

INDEXABLE MILLING

SOLID END MILLING

HOLE/MAKING

TAPPING

TURNING

INDEXABLE MILLING

RDPX-MM • RD1604..

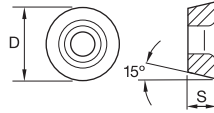
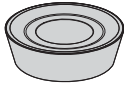

- first choice
- alternate choice

P	●	○	○	○
M	●	○	○	○
K	●	○	○	○
N	○	○	○	○
S	○	○	○	○
H	○	○	○	○

catalogue number	D	S	hm	TN2505	TN6525	TN6540
RDPX1604M0SNMM	16,00	4,76	0,14	●	○	○

SOLID END MILLING

HOLEMAKING

RDPX-MH • RD1604..

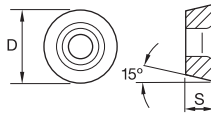
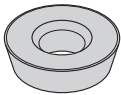

- first choice
- alternate choice

P	●	○	○	○
M	●	○	○	○
K	●	○	○	○
N	○	○	○	○
S	○	○	○	○
H	○	○	○	○

catalogue number	D	S	hm	TN2505	TN6525	TN6540
RDPX1604M0SNMH	16,00	4,76	0,22	○	○	○

TAPPING

TURNING

Insert Selection Guide • M170 • RD16 • Metric

Material Group	Light Machining		General Purpose		Heavy Machining	
	Geometry	Grade	Geometry	Grade	Geometry	Grade
P1-P2	MM	TN6525	MM	TN6525	MM	TN6540
P3-P4	MH	TN2505	MH	TN6525	MH	TN6540
P5-P6	MH	TN2505	MH	TN6525	MH	TN6540
M1-M2	-	-	MM	TN6525	MM	TN6540
M3	-	-	MM	TN6525	MM	TN6540
K1-K2	MH	TN2505	MH	TN2505	MH	TN6525
K3	MH	TN2505	MH	TN2505	MH	TN6525
N1-N2	-	-	-	-	-	-
N3	-	-	-	-	-	-
S1-S2	-	-	MM	TN6540	-	-
S3	-	-	MM	TN6540	-	-
S4	-	-	MM	TN6540	-	-
H1	MH	TN2505	MH	TN2505	-	-

Recommended Starting Speeds • M170 • RD1604 • Metric

Material Group		TN2505			TN6525			TN6540		
P	1	550	420	360	410	320	280	360	280	240
	2	320	240	205	320	250	215	250	190	170
	3	320	240	205	280	215	185	215	170	140
	4	-	-	-	235	170	145	180	130	110
	5	-	-	-	310	235	200	240	180	150
	6	-	-	-	205	160	130	160	120	100
M	1	-	-	-	190	120	80	130	80	60
	2	-	-	-	120	80	50	80	50	40
	3	-	-	-	125	80	55	85	50	40
K	1	400	300	250	275	245	220	220	205	180
	2	540	365	280	215	190	180	175	155	140
	3	310	190	155	180	160	145	155	145	125
N	1	-	-	-	-	-	-	-	-	-
	2	-	-	-	-	-	-	-	-	-
	3	-	-	-	-	-	-	-	-	-
S	1	-	-	-	-	-	-	50	35	30
	2	-	-	-	-	-	-	25	20	10
	3	-	-	-	-	-	-	70	40	30
	4	-	-	-	-	-	-	60	30	25
H	1	175	140	95	-	-	-	-	-	-
	2	175	140	95	-	-	-	-	-	-
	3	140	115	80	-	-	-	-	-	-

NOTE: FIRST choice starting speeds are in **bold** type.
As the average chip thickness increases, the speed should be decreased.

Recommended Starting Feeds • M170 • RD16 • Metric

Light Machining	General Purpose	Heavy Machining
-----------------	-----------------	-----------------

At 8,00mm Axial Depth of Cut (ap)

Insert Geometry	Programmed Feed per Tooth (fz) as a % of Radial Depth of Cut (ae)															Insert Geometry
	5%			10%			20%			30%			40-100%			
MM	0,39	0,52	0,82	0,28	0,37	0,59	0,21	0,28	0,44	0,18	0,24	0,38	0,17	0,22	0,35	MM
MH	0,51	0,70	1,17	0,37	0,50	0,84	0,28	0,38	0,63	0,24	0,33	0,55	0,22	0,30	0,50	MH

At 4,00mm Axial Depth of Cut (ap)

Insert Geometry	Programmed Feed per Tooth (fz) as a % of Radial Depth of Cut (ae)															Insert Geometry
	5%			10%			20%			30%			40-100%			
MM	0,45	0,60	0,94	0,32	0,43	0,68	0,24	0,32	0,51	0,21	0,28	0,44	0,19	0,26	0,40	MM
MH	0,59	0,81	1,36	0,43	0,58	0,97	0,32	0,43	0,72	0,28	0,38	0,63	0,25	0,35	0,58	MH

At 2,00mm Axial Depth of Cut (ap)

Insert Geometry	Programmed Feed per Tooth (fz) as a % of Radial Depth of Cut (ae)															Insert Geometry
	5%			10%			20%			30%			40-100%			
MM	0,59	0,79	1,24	0,43	0,57	0,89	0,32	0,42	0,66	0,28	0,37	0,58	0,25	0,34	0,53	MM
MH	0,77	1,06	1,79	0,56	0,76	1,28	0,42	0,57	0,95	0,36	0,50	0,83	0,33	0,45	0,76	MH

At 1,00mm Axial Depth of Cut (ap)

Insert Geometry	Programmed Feed per Tooth (fz) as a % of Radial Depth of Cut (ae)															Insert Geometry
	5%			10%			20%			30%			40-100%			
MM	0,81	1,08	1,71	0,58	0,78	1,22	0,43	0,58	0,91	0,38	0,51	0,79	0,35	0,46	0,72	MM
MH	1,06	1,46	2,48	0,76	1,04	1,75	0,57	0,78	1,30	0,50	0,68	1,13	0,45	0,62	1,03	MH

NOTE: Use "Light Machining" value as starting feed rate.

WIDIA Indexable Milling Additional Application Advice RD1604.. • M170

Selecting the Correct Cutting Values

1. fz depends on the Ap1 and ae values

With round inserts, two factors can affect the hm: Ap1 and ae. fz has to be adjusted accordingly.

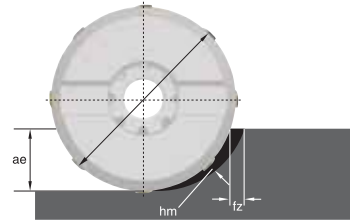

Recommended Starting Feed Rate Values (fz) Related to the Ap1 and ae Values:

ae engagement	10%	20%	30%	40%	50%	100%
Ap1 = 1mm	1,52mm	1,07mm	0,88mm	0,76mm	0,68mm	0,48mm
Ap1 = 2mm	1,07mm	0,76mm	0,62mm	0,54mm	0,48mm	0,34mm
Ap1 = 3mm	0,88mm	0,62mm	0,51mm	0,44mm	0,39mm	0,28mm
Ap1 = 4mm	0,76mm	0,54mm	0,44mm	0,38mm	0,34mm	0,24mm
Ap1 = 5mm	0,62mm	0,44mm	0,36mm	0,31mm	0,26mm	0,20mm
Ap1 = 6mm	0,54mm	0,38mm	0,31mm	0,27mm	0,24mm	0,17mm

Example application highlighted.

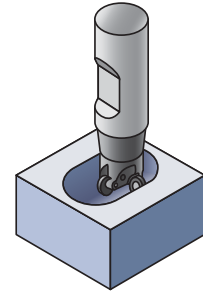

Example Cutting Conditions for iC16mm... Insert in Pocketing, up to 3 L/D approximately:

insert = RDPX1604M0SN			TN2505			TN6525			TN6540		
			feed per tooth fz (mm)/ae>50%								
			min	med	max	min	med	max	min	med	max
Edge Geometry MM	ae>50%	Recommended starting Ap1 = 3mm	-	-	-	0,28mm	0,45mm	0,65mm	0,28mm	0,50mm	0,70mm
Edge Geometry MH	ae>50%	Recommended starting Ap1 = 3mm	0,28mm	0,35mm	0,50mm	0,28mm	0,50mm	0,75mm	0,28mm	0,60mm	0,80mm

2. Ap1 and vc corrections depend on L/D ratio

With increasing L/D ratios, or overhang, vibrations can occur due to reduced rigidity. To ensure successful application, it is recommended to adjust Ap1 and vc values according to the following table:

L/D ratio	% of Ap1 max to reduce	% of vc to reduce
<2	0%	0%
2<L/D<4	65-75%	10-15%
>4	80-95%	20-40%

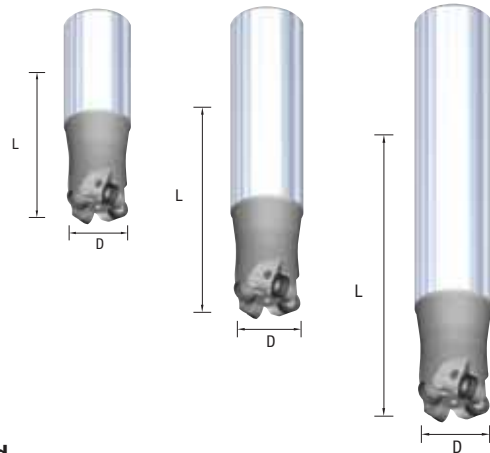

Recommended Cutting Conditions • Helical Interpolation from Solid

cutter diameter	min hole diameter	max hole diameter (flat bottom)	Ap1 max per revolution	max ramp angle	Ap1 max when plunging
32	36mm	48mm	3mm	20°	3mm
50	69mm	84mm	8mm	9,5°	4,8mm
52	73mm	88mm	8mm	8,2°	5mm
63	95mm	110mm	8mm	5,5°	4,7mm
66	101mm	120mm	8mm	4°	4,2mm
80	129mm	144mm	8mm	3°	4,1mm
100	169mm	184mm	8mm	2,4°	4,6mm
125	219mm	234mm	8mm	2,2°	4,4mm

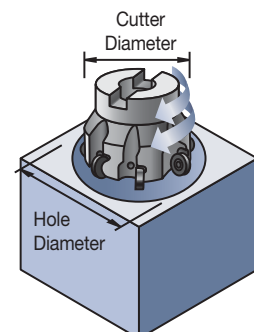

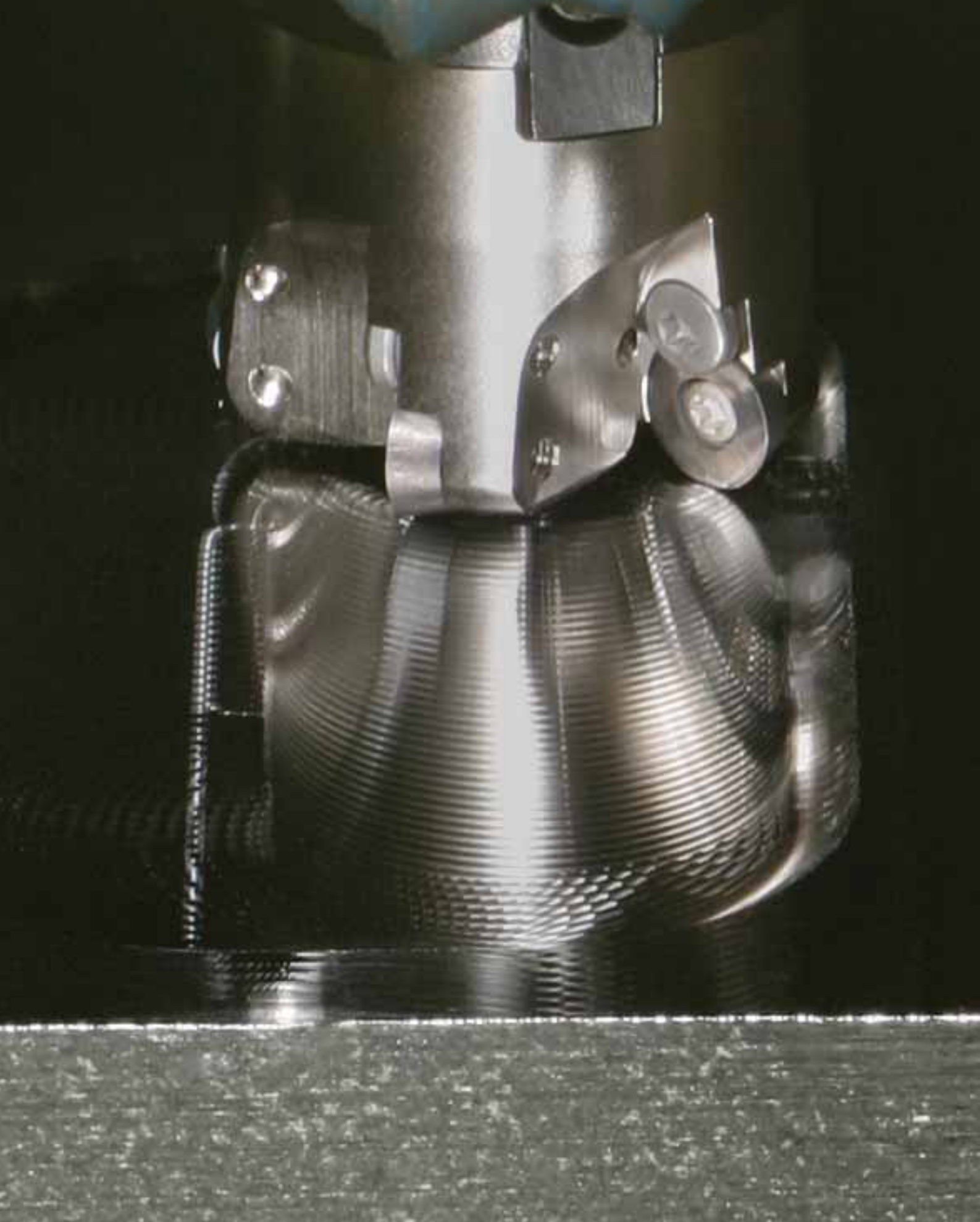

M100™ Series

M100 IC06, M100 IC10, M100 IC12, M100 IC16, M100 IC18 Copy Mills

The M100 copy mill is a reliable multipurpose solution for copy milling, face milling, helical interpolation, and roughing. The strong and rigid body design paired with the thick inserts ensures consistent results in even the most demanding operations.

Thick inserts paired with the rigid body design provide rigidity and consistency.

Anti-rotation systems in the larger iC inserts provide stability to allow for higher depth of cuts.

Large chip gashes and through tool coolant capabilities provide smooth and increased chip evacuation.



The M100 copy mill is equipped with thick inserts, rigid body design, and anti-rotation systems to stay engaged with the workpiece in high depth of cuts.

INSERT OFFERING



08mm iC
RD Insert Type
Ground and PSTS



10mm iC
RD Insert Type
Ground and PSTS



12mm iC
RD Insert Type
Anti-Rotation Feature
Ground and PSTS



16mm iC
RD Insert Type
Anti-Rotation Feature
Ground and PSTS



16mm iC
RC Insert Type
Anti-Rotation Feature
Ground and PSTS

PROFILING AND COPY APPLICATIONS

PRODUCT

SERIES

M100™

DIAMETER RANGE

16–160mm

SHANK TYPES

Shell Mills
Weldon® End Mills
Screw-On End Mills

INDUSTRY



APPLICATIONS



FACE
MILLING



HELICAL
MILLING/
POCKET
MILLING



3D
PROFILING



POCKETING



RAMPING
BLANK



SIDE MILLING/
SHOULDER
MILLING: BALL
NOSE



SLOTTING

CONSISTENCY

Thick inserts combined with the rigid body provide a strong foundation for consistent results.

STABILITY

Anti-rotation systems in the larger iC inserts provide a sure fit for stability in high depth of cuts.



M100 • Weldon® Shank RD0802.. • Metric

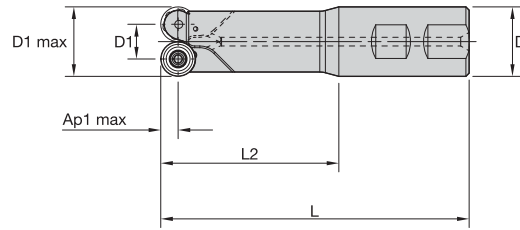

order number	catalogue number	D1 max	D1	D	L	L2	Ap1 max	Z	max ramp angle	max RPM	coolant supply	kg
2021333	12391010600	16	8	16	90	42	4,0	2	7.5	28000	Yes	0,10
2021334	12391011000	16	8	20	132	82	4,0	2	7.5	28000	Yes	0,20
2021335	12391011400	16	8	25	183	127	4,0	2	7.5	28000	Yes	0,40

NOTE: All spare parts except the insert screws must be ordered separately.

FOR SPARE PARTS, PLEASE VISIT WIDIA.COM OR WIDIANOVO.COM.

MOUNTING SCREWS ARE NOT INCLUDED IN STANDARD PACKAGING.

M100 • RDMT-M0T • RD0802..

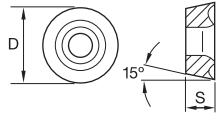
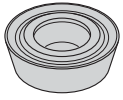

- first choice
- alternate choice

P	●	●	●	●	●	○	○
M	○	○	○	○	○	○	○
K	○	○	○	○	○	○	○
N	○	○	○	○	○	○	○
S	○	○	○	○	○	○	○
H	○	○	○	○	○	○	○

ISO catalogue number	cutting edges	D	S	THM	TN6525	TN6540	TTM08	WK15CM	WP35CM	WS30PM	WS40PM
RDMT0802M0T	1	8,00	2,38	●	○	○	○	○	○	○	○
RDMT1003M0T	1	10,00	3,18	○	○	○	○	○	○	○	○

M100 • RDMW-M0 / -M0T • RD0802..

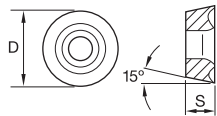
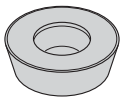

- first choice
- alternate choice

P	●	●	●	●	●	○	○
M	○	○	○	○	○	○	○
K	○	○	○	○	○	○	○
N	○	○	○	○	○	○	○
S	○	○	○	○	○	○	○
H	○	○	○	○	○	○	○

ISO catalogue number	cutting edges	D	S	hm	THM	TN6525	TN6540	TTM08	WK15CM	WP35CM	WS30PM	WS40PM
RDMW0802M0	1	8,00	2,38	0,09	2012566	○	○	○	○	○	○	○
RDMW0802M0T	1	8,00	2,38	0,09	○	3353278	○	○	○	○	○	○

M100 • RD08 • Insert Selection Guide

Material Group	Light Machining		General Purpose		Heavy Machining	
	Geometry	Grade	Geometry	Grade	Geometry	Grade
P1-P2	RDMT-T	WP35CM	RDMT-T	WP35CM	RDMT-T	WP35CM
P3-P4	RDMT-T	WP35CM	RDMW-T	TN6540	RDMW-T	TN6540
P5-P6	RDMT-T	WP35CM	RDMT-T	WP35CM	RDMT-T	WP35CM
M1-M2	RDMT-T	WP35CM	RDMT-T	WP35CM	RDMT-T	WP35CM
M3	RDMT-T	WP35CM	RDMT-T	WP35CM	RDMT-T	WP35CM
K1-K2	-	-	RDMT-T	WP35CM	RDMT-T	WP35CM
K3	-	-	RDMT-T	WP35CM	RDMT-T	WP35CM

M100 • RD08 • Recommended Starting Speeds [m/min]

Material Group	THM	TN6525			TN6540			TTM08			WK15CM			WP35CM			WS30PM			WS40PM					
P	1	-	-	-	410	320	280	360	280	240	230	200	190	-	-	-	455	395	370	-	-	-	-	-	-
	2	-	-	-	320	250	215	250	190	170	195	170	140	-	-	-	280	255	230	-	-	-	-	-	-
	3	-	-	-	280	215	185	215	170	140	180	150	125	-	-	-	255	230	205	-	-	-	-	-	-
	4	-	-	-	235	170	145	180	130	110	160	130	105	-	-	-	190	175	160	-	-	-	-	-	-
	5	-	-	-	310	235	200	240	180	150	-	-	-	-	-	-	260	230	210	-	-	-	205	175	145
	6	-	-	-	205	160	130	160	120	100	-	-	-	-	-	-	160	135	110	-	-	-	180	130	95
M	1	-	-	-	190	120	80	130	80	60	-	-	-	-	-	-	205	185	155	270	240	220	250	205	170
	2	-	-	-	120	80	50	80	50	40	-	-	-	-	-	-	185	160	140	245	215	175	215	175	145
	3	-	-	-	125	80	55	85	50	40	-	-	-	-	-	-	145	130	115	185	160	125	175	130	100
K	1	120	90	75	275	245	220	220	205	180	-	-	-	505	460	410	295	265	240	-	-	-	-	-	-
	2	125	100	70	215	190	180	175	155	140	-	-	-	400	355	330	235	210	190	-	-	-	-	-	-
	3	130	95	60	180	160	145	155	145	125	-	-	-	335	300	275	195	175	160	-	-	-	-	-	-
N	1	900	600	500	-	-	-	-	-	-	-	-	-	-	-	-	-	-	-	-	-	-	-	-	-
	2	685	465	385	-	-	-	-	-	-	-	-	-	-	-	-	-	-	-	-	-	-	-	-	-
	3	450	280	200	-	-	-	-	-	-	-	-	-	-	-	-	-	-	-	-	-	-	-	-	-
S	1	-	-	-	-	-	-	50	35	30	-	-	-	-	-	-	-	-	-	55	50	35	50	40	30
	2	-	-	-	-	-	-	25	20	10	-	-	-	-	-	-	-	-	-	55	50	35	50	40	30
	3	-	-	-	-	-	-	70	40	30	-	-	-	-	-	-	-	-	-	65	55	35	60	50	30
	4	-	-	-	-	-	-	60	30	25	-	-	-	-	-	-	66	50	33	100	70	50	70	60	35
H	1	-	-	-	-	-	-	-	-	-	-	-	-	-	-	-	-	-	-	-	-	-	-	-	-
	2	-	-	-	-	-	-	-	-	-	-	-	-	-	-	-	-	-	-	-	-	-	-	-	-
	3	-	-	-	-	-	-	-	-	-	-	-	-	-	-	-	-	-	-	-	-	-	-	-	-

NOTE: FIRST choice starting speeds are in **bold** type.
As the average chip thickness increases, the speed should be decreased.

M100 • RD08 • Recommended Starting Feeds [mm]

Light Machining	General Purpose	Heavy Machining
-----------------	-----------------	-----------------

At 4,00 Axial Depth of Cut (ap)

Insert Geometry	Programmed Feed per Tooth (fz) as a % of Radial Depth of Cut (ae)															Insert Geometry
	5%			10%			20%			30%			40-100%			
RDMW-	0,19	0,29	0,42	0,14	0,21	0,30	0,10	0,16	0,23	0,09	0,14	0,20	0,08	0,13	0,18	RDMW-
RDHT-T	0,23	0,31	0,63	0,17	0,23	0,45	0,13	0,17	0,34	0,11	0,15	0,29	0,10	0,14	0,27	RDHT-T
RDMT-T	0,23	0,31	0,63	0,17	0,23	0,45	0,13	0,17	0,34	0,11	0,15	0,29	0,10	0,14	0,27	RDMT-T
RDMW-T	0,23	0,42	0,73	0,17	0,30	0,53	0,13	0,23	0,39	0,11	0,20	0,34	0,10	0,18	0,32	RDMW-T

At 2,00 Axial Depth of Cut (ap)

Insert Geometry	Programmed Feed per Tooth (fz) as a % of Radial Depth of Cut (ae)															Insert Geometry
	5%			10%			20%			30%			40-100%			
RDMW-	0,22	0,34	0,48	0,16	0,24	0,35	0,12	0,18	0,26	0,10	0,16	0,23	0,09	0,15	0,21	RDMW-
RDHT-T	0,27	0,36	0,72	0,19	0,26	0,52	0,14	0,20	0,39	0,13	0,17	0,34	0,12	0,16	0,31	RDHT-T
RDMT-T	0,27	0,36	0,72	0,19	0,26	0,52	0,14	0,20	0,39	0,13	0,17	0,34	0,12	0,16	0,31	RDMT-T
RDMW-T	0,27	0,48	0,85	0,19	0,35	0,61	0,14	0,26	0,46	0,13	0,23	0,40	0,12	0,21	0,36	RDMW-T

At 1,00 Axial Depth of Cut (ap)

Insert Geometry	Programmed Feed per Tooth (fz) as a % of Radial Depth of Cut (ae)															Insert Geometry
	5%			10%			20%			30%			40-100%			
RDMW-	0,28	0,44	0,63	0,20	0,32	0,46	0,15	0,24	0,34	0,13	0,21	0,30	0,12	0,19	0,27	RDMW-
RDHT-T	0,35	0,47	0,95	0,25	0,34	0,69	0,19	0,26	0,51	0,17	0,22	0,45	0,15	0,20	0,41	RDHT-T
RDMT-T	0,35	0,47	0,95	0,25	0,34	0,69	0,19	0,26	0,51	0,17	0,22	0,45	0,15	0,20	0,41	RDMT-T
RDMW-T	0,35	0,63	1,12	0,25	0,46	0,80	0,19	0,34	0,60	0,17	0,30	0,52	0,15	0,27	0,48	RDMW-T

At 0,50 Axial Depth of Cut (ap)

Insert Geometry	Programmed Feed per Tooth (fz) as a % of Radial Depth of Cut (ae)															Insert Geometry
	5%			10%			20%			30%			40-100%			
RDMW-	0,39	0,60	0,87	0,28	0,44	0,62	0,21	0,33	0,47	0,18	0,28	0,41	0,17	0,26	0,37	RDMW-
RDHT-T	0,48	0,65	1,31	0,35	0,47	0,94	0,26	0,35	0,70	0,23	0,30	0,61	0,21	0,28	0,56	RDHT-T
RDMT-T	0,48	0,65	1,31	0,35	0,47	0,94	0,26	0,35	0,70	0,23	0,30	0,61	0,21	0,28	0,56	RDMT-T
RDMW-T	0,48	0,87	1,54	0,35	0,62	1,10	0,26	0,47	0,82	0,23	0,41	0,71	0,21	0,37	0,65	RDMW-T

NOTE: Use "Light Machining" value as starting feed rate.

M100 • Screw-On RD1003.. • Metric

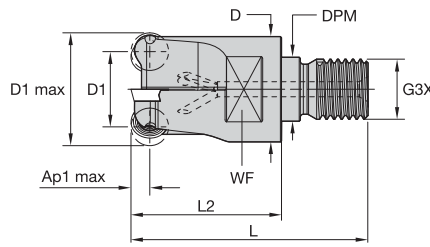

order number	catalogue number	D1 max	D1	D	DPM	G3X	L	L2	WF	Ap1 max	Z	max ramp angle	max RPM	coolant supply	kg
2021375	12391050400	25	15	22	12,5	M12	52	30	19	5,0	2	15.8	22000	Yes	0,10
2021376	12391050600	30	20	28	17,0	M16	63	40	22	5,0	3	10,3	20000	Yes	0,20

NOTE: All spare parts except the insert screws must be ordered separately.

M100 • Weldon® Shank RD1003.. • Metric

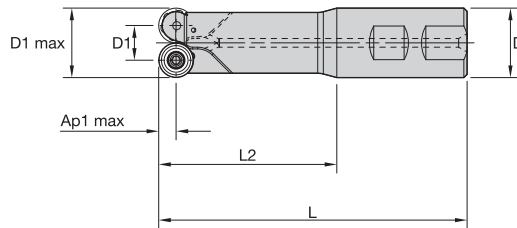

order number	catalogue number	D1 max	D1	D	L	L2	Ap1 max	Z	max ramp angle	max RPM	coolant supply	kg
2021336	12391011600	20	10	20	92	42	5,0	2	7.8	25000	Yes	0,20
2021337	12391012000	20	10	25	138	82	5,0	2	8.8	25000	Yes	0,40
2021339	12391012800	26	16	32	142	82	5,0	2	13.5	22000	Yes	0,60
2021340	12391013200	26	16	32	187	127	5,0	2	14.3	22000	Yes	0,90

NOTE: All spare parts except the insert screws must be ordered separately.

FOR SPARE PARTS, PLEASE VISIT WIDIA.COM OR WIDIANOVO.COM.
MOUNTING SCREWS ARE NOT INCLUDED IN STANDARD PACKAGING.

M100 • RDMT-M0T • RD1003..

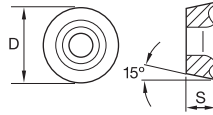
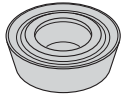

- first choice
- alternate choice

P	●	●	●	●	●	●	●	●	●
M	○	○	○	○	○	○	○	○	○
K	○	○	○	○	○	○	○	○	○
N	○	○	○	○	○	○	○	○	○
S	○	○	○	○	○	○	○	○	○
H	○	○	○	○	○	○	○	○	○

ISO catalogue number	cutting edges	D	S	hm	THM	TN6525	TN6540	TTM08	WK15CM	WP35CM	WS30PM	WS40PM
RDMT1003M0	1	10,00	3,18	0,14	2012538	●	●	●	●	○	○	○
RDMT1003M0T	1	10,00	3,18	0,14	2957429	○	○	○	○	○	○	○

M100 • RDMW-M0 / -M0T • RD1003..

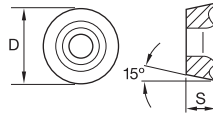
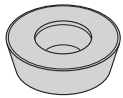

- first choice
- alternate choice

P	●	●	●	●	●	●	●	●	●
M	○	○	○	○	○	○	○	○	○
K	○	○	○	○	○	○	○	○	○
N	○	○	○	○	○	○	○	○	○
S	○	○	○	○	○	○	○	○	○
H	○	○	○	○	○	○	○	○	○

ISO catalogue number	cutting edges	D	S	hm	THM	TN6525	TN6540	TTM08	WK15CM	WP35CM	WS30PM	WS40PM
RDMW1003M0T	1	10,00	3,18	0,14	3353279	○	○	○	○	○	○	○
RDMW1003M0	1	10,00	3,18	—	6724747	○	○	○	○	○	○	○

M100 • RD10 • Insert Selection Guide

Material Group	Light Machining		General Purpose		Heavy Machining	
	Geometry	Grade	Geometry	Grade	Geometry	Grade
P1-P2	RDMT-T	TN6525	RDMT-T	TN6540	RDMW-T	TN6540
P3-P4	RDMT-T	TN6525	RDMW-T	TN6540	RDMW-T	TN6540
P5-P6	RDMT-T	TN6525	RDMW-T	TN6540	RDMW-T	TN6540
M1-M2	RDMT-T	TN6540	RDMT-T	TN6540	RDMT-T	TN6540
M3	RDMT-T	TN6540	RDMT-T	TN6540	RDMT-T	TN6540
K1-K2	RDMW-MH	TN2510	RDMW-MH	TN2510	RDMW	WK15CM
K3	RDMW-MH	TN2510	RDMW-MH	TN2510	RDMW	WK15CM
N1-N2	-	-	-	-	-	-
N3	-	-	-	-	-	-
S1-S2	-	-	RDMT-T	TN6540	-	-
S3	-	-	RDMT-T	TN6540	-	-
S4	-	-	RDMT-T	TN6540	RDMT-T	TN6540
H1	RDMW-MH	TN2510	RDMW-MH	TN2510	-	-

M100 • RD10 • Recommended Starting Speeds [m/min]

Material Group	THM	TN6525			TN6540			TTM08			WK15CM			WP35CM			WS30PM			WS40PM					
P	1	-	-	-	410	320	280	360	280	240	230	200	190	-	-	-	455	395	370	-	-	-	-	-	-
	2	-	-	-	320	250	215	250	190	170	195	170	140	-	-	-	280	255	230	-	-	-	-	-	-
	3	-	-	-	280	215	185	215	170	140	180	150	125	-	-	-	255	230	205	-	-	-	-	-	-
	4	-	-	-	235	170	145	180	130	110	160	130	105	-	-	-	190	175	160	-	-	-	-	-	-
	5	-	-	-	310	235	200	240	180	150	-	-	-	-	-	-	260	230	210	-	-	-	205	175	145
	6	-	-	-	205	160	130	160	120	100	-	-	-	-	-	-	160	135	110	-	-	-	180	130	95
M	1	-	-	-	190	120	80	130	80	60	-	-	-	-	-	-	205	185	155	270	240	220	250	205	170
	2	-	-	-	120	80	50	80	50	40	-	-	-	-	-	-	185	160	140	245	215	175	215	175	145
	3	-	-	-	125	80	55	85	50	40	-	-	-	-	-	-	145	130	115	185	160	125	175	130	100
K	1	120	90	75	275	245	220	220	205	180	-	-	-	505	460	410	295	265	240	-	-	-	-	-	-
	2	125	100	70	215	190	180	175	155	140	-	-	-	400	355	330	235	210	190	-	-	-	-	-	-
	3	130	95	60	180	160	145	155	145	125	-	-	-	335	300	275	195	175	160	-	-	-	-	-	-
N	1	900	600	500	-	-	-	-	-	-	-	-	-	-	-	-	-	-	-	-	-	-	-	-	-
	2	685	465	385	-	-	-	-	-	-	-	-	-	-	-	-	-	-	-	-	-	-	-	-	-
	3	450	280	200	-	-	-	-	-	-	-	-	-	-	-	-	-	-	-	-	-	-	-	-	-
S	1	-	-	-	-	-	-	50	35	30	-	-	-	-	-	-	-	-	-	55	50	35	50	40	30
	2	-	-	-	-	-	-	25	20	10	-	-	-	-	-	-	-	-	-	55	50	35	50	40	30
	3	-	-	-	-	-	-	70	40	30	-	-	-	-	-	-	-	-	-	65	55	35	60	50	30
	4	-	-	-	-	-	-	60	30	25	-	-	-	-	-	-	66	50	33	100	70	50	70	60	35
H	1	-	-	-	-	-	-	-	-	-	-	-	-	-	-	-	-	-	-	-	-	-	-	-	-
	2	-	-	-	-	-	-	-	-	-	-	-	-	-	-	-	-	-	-	-	-	-	-	-	-
	3	-	-	-	-	-	-	-	-	-	-	-	-	-	-	-	-	-	-	-	-	-	-	-	-

NOTE: FIRST choice starting speeds are in **bold** type.
As the average chip thickness increases, the speed should be decreased.

M100 • RD10 • Recommended Starting Feeds [mm]

Light Machining	General Purpose	Heavy Machining
-----------------	-----------------	-----------------

At 5,00mm Axial Depth of Cut (ap)

Insert Geometry	Programmed Feed per Tooth (fz) as a % of Radial Depth of Cut (ae)															Insert Geometry
	5%			10%			20%			30%			40-100%			
RDHT-T	0,23	0,39	0,65	0,17	0,28	0,47	0,13	0,21	0,35	0,11	0,18	0,31	0,10	0,17	0,28	RDHT-T
RDHW-MH	0,23	0,42	0,88	0,17	0,30	0,63	0,13	0,23	0,47	0,11	0,20	0,41	0,10	0,18	0,38	RDHW-MH
RDMT-T	0,23	0,39	0,65	0,17	0,28	0,47	0,13	0,21	0,35	0,11	0,18	0,31	0,10	0,17	0,28	RDMT-T
RDMW	0,23	0,21	0,61	0,17	0,15	0,44	0,13	0,11	0,33	0,11	0,10	0,28	0,10	0,09	0,26	RDMW
RDMW-T	0,23	0,57	0,88	0,17	0,41	0,63	0,13	0,31	0,47	0,11	0,27	0,41	0,10	0,25	0,38	RDMW-T

At 2,00mm Axial Depth of Cut (ap)

Insert Geometry	Programmed Feed per Tooth (fz) as a % of Radial Depth of Cut (ae)															Insert Geometry
	5%			10%			20%			30%			40-100%			
RDHT-T	0,29	0,49	0,82	0,21	0,35	0,59	0,16	0,26	0,44	0,14	0,23	0,38	0,13	0,21	0,35	RDHT-T
RDHW-MH	0,29	0,53	1,11	0,21	0,38	0,79	0,16	0,28	0,59	0,14	0,25	0,52	0,13	0,23	0,47	RDHW-MH
RDMT-T	0,29	0,49	0,82	0,21	0,35	0,59	0,16	0,26	0,44	0,14	0,23	0,38	0,13	0,21	0,35	RDMT-T
RDMW	0,29	0,26	0,76	0,21	0,19	0,55	0,16	0,14	0,41	0,14	0,12	0,36	0,13	0,11	0,33	RDMW
RDMW-T	0,29	0,71	1,11	0,21	0,51	0,79	0,16	0,38	0,59	0,14	0,33	0,52	0,13	0,31	0,47	RDMW-T

At 1,00mm Axial Depth of Cut (ap)

Insert Geometry	Programmed Feed per Tooth (fz) as a % of Radial Depth of Cut (ae)															Insert Geometry
	5%			10%			20%			30%			40-100%			
RDHT-T	0,39	0,65	1,09	0,28	0,47	0,78	0,21	0,35	0,58	0,18	0,31	0,51	0,17	0,28	0,47	RDHT-T
RDHW-MH	0,39	0,71	1,49	0,28	0,51	1,06	0,21	0,38	0,79	0,18	0,33	0,69	0,17	0,30	0,63	RDHW-MH
RDMT-T	0,39	0,65	1,09	0,28	0,47	0,78	0,21	0,35	0,58	0,18	0,31	0,51	0,17	0,28	0,47	RDMT-T
RDMW	0,39	0,35	1,02	0,28	0,25	0,73	0,21	0,19	0,55	0,18	0,16	0,48	0,17	0,15	0,44	RDMW
RDMW-T	0,39	0,95	1,49	0,28	0,69	1,06	0,21	0,51	0,79	0,18	0,45	0,69	0,17	0,41	0,63	RDMW-T

At 0,50mm Axial Depth of Cut (ap)

Insert Geometry	Programmed Feed per Tooth (fz) as a % of Radial Depth of Cut (ae)															Insert Geometry
	5%			10%			20%			30%			40-100%			
RDHT-T	0,53	0,90	1,52	0,38	0,65	1,08	0,29	0,48	0,81	0,25	0,42	0,70	0,23	0,39	0,64	RDHT-T
RDHW-MH	0,53	0,98	2,07	0,38	0,70	1,47	0,29	0,52	1,09	0,25	0,46	0,95	0,23	0,42	0,87	RDHW-MH
RDMT-T	0,53	0,90	1,52	0,38	0,65	1,08	0,29	0,48	0,81	0,25	0,42	0,70	0,23	0,39	0,64	RDMT-T
RDMW	0,53	0,48	1,41	0,38	0,35	1,01	0,29	0,26	0,75	0,25	0,23	0,65	0,23	0,21	0,60	RDMW
RDMW-T	0,53	1,32	2,07	0,38	0,95	1,47	0,29	0,70	1,09	0,25	0,61	0,95	0,23	0,56	0,87	RDMW-T

NOTE: Use "Light Machining" value as starting feed rate.

M100 • Screw-On RD1204... • Metric

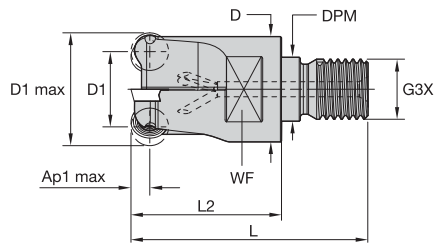

order number	catalogue number	D1 max	D1	D	DPM	G3X	L	L2	WF	Ap1 max	Z	max ramp angle	max RPM	coolant supply	kg
2021374	12391050200	24	12	22	12,5	M12	52	30	19	6,0	2	10.0	23000	Yes	0,10
2021378	12391051000	35	23	28	17,0	M16	63	40	22	6,0	3	10.8	19000	Yes	0,20
2021379	12391051200	40	28	28	17,0	M16	63	40	22	6,0	4	8.3	17000	Yes	0,30

NOTE: All spare parts except the insert screws must be ordered separately.

M100 • Shell Mills RD1204... • Metric

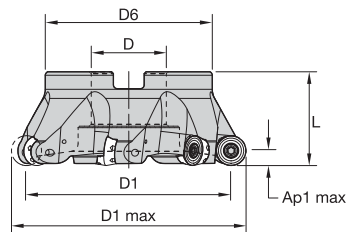

order number	catalogue number	D1 max	D1	D	D6	L	Ap1 max	Z	max ramp angle	max RPM	coolant supply	kg
2021342	12391020000	50	38	22	40	40	6,0	4	6.8	15000	Yes	0,20
2021361	12391024000	52	40	22	40	40	6,0	4	6.5	15000	Yes	0,20
2021343	12391020200	63	51	27	48	40	6,0	5	4.5	14000	Yes	0,30
2021344	12391020400	80	68	27	60	50	6,0	6	3.5	12000	Yes	0,90
2021345	12391020600	100	88	32	78	50	6,0	6	2.5	11000	No	1,20

NOTE: All spare parts except the insert screws must be ordered separately.

FOR SPARE PARTS, PLEASE VISIT WIDIA.COM OR WIDIANOVO.COM.

MOUNTING SCREWS ARE NOT INCLUDED IN STANDARD PACKAGING.

M100 • RDMT-TX • RD1204..

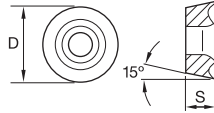
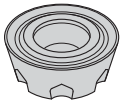

- first choice
- alternate choice

P	■	■	●	●	●	●	○	○
M	■	■	○	○	○	○	○	○
K	■	■	○	○	○	○	○	○
N	■	■	○	○	○	○	○	○
S	■	■	○	○	○	○	○	○
H	■	■	○	○	○	○	○	○

ISO catalogue number	number of indexes	D	S	hm	THM	TN6525	TN6540	TTM08	WK15CM	WP35CM	WS30PM	WS40PM
RDMT1204M0TX	6	12,00	4,76	0,15	■	2957430	2957432	2012546	■	■	5520247	■
RDMT1204M0TX	6	12,00	4,76	—	■	■	■	6724748	■	6901188	■	■

M100 • RDMW-TX • RD1204..

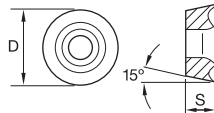
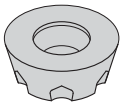

- first choice
- alternate choice

P	■	■	●	●	●	●	○	○
M	■	■	○	○	○	○	○	○
K	■	■	○	○	○	○	○	○
N	■	■	○	○	○	○	○	○
S	■	■	○	○	○	○	○	○
H	■	■	○	○	○	○	○	○

ISO catalogue number	number of indexes	D	S	hm	THM	TN6525	TN6540	TTM08	WK15CM	WP35CM	WS30PM	WS40PM
RDMW1204M0TX	6	12,00	4,76	0,15	■	■	3353281	2012600	5427441	■	■	■
RDMW1204M0TX	6	12,00	4,76	—	■	■	■	■	6901190	■	■	■

M100 • RDPT-MMX • RD1204..

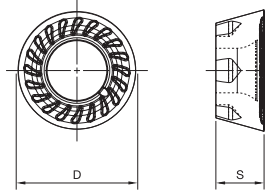

- first choice
- alternate choice

P	■	■	●	●	●	●	○	○
M	■	■	○	○	○	○	○	○
K	■	■	○	○	○	○	○	○
N	■	■	○	○	○	○	○	○
S	■	■	○	○	○	○	○	○
H	■	■	○	○	○	○	○	○

ISO catalogue number	number of indexes	D	S	hm	THM	TN6525	TN6540	TTM08	WK15CM	WP35CM	WS30PM	WS40PM
RDPT1204M0SMMX	6	12,00	4,76	0,18	■	■	5176974	■	■	■	■	6412897
RDPT1204M0SMMX4	4	12,00	4,76	—	■	■	■	■	■	■	■	6412898
RDPT1204M0SMMX	6	12,00	4,76	—	■	■	■	■	6901783	■	■	■

M100 • RD12 • Insert Selection Guide

Material Group	Light Machining		General Purpose		Heavy Machining	
	Geometry	Grade	Geometry	Grade	Geometry	Grade
P1-P2	RDMT-TX	WP35CM	RDMT-TX	TN6540	RDMT-TX	TN6540
P3-P4	RDMT-TX	WP35CM	RDMW-TX	TN6540	RDMW-TX	TN6540
P5-P6	RDMT-TX	WP35CM	RDPT-MMX	WP35CM	RDPT-MMX	WP35CM
M1-M2	RDHT-TX	WS30PM	RDMT-TX	TN6540	RDPT-MMX	TN6540
M3	RDHT-TX	WS30PM	RDMT-TX	TN6540	RDPT-MMX	TN6540
K1-K2	RDMW-TX	WK15CM	RDMW-TX	WK15CM	RDMW-TX	WK15CM
K3	RDHW-MH	TN2510	RDMW-TX	WK15CM	RDMW-TX	WK15CM
N1-N2	-	-	-	-	-	-
N3	-	-	-	-	-	-
S1-S2	-	-	RDMT-TX	TN6540	-	-
S3	-	-	RDMT-TX	TN6540	-	-
S4	-	-	RDMT-TX	TN6540	RDPT-MMX	TN6540
H1	RDHW-MH	TN2510	RDHW-MH	TN2510	-	-

M100 • RD12 • Recommended Starting Speeds [m/min]

Material Group		THM			TN6525			TN6540			TTM08			WK15CM			WP35CM			WS30PM			WS40PM		
P	1	-	-	-	410	320	280	360	280	240	230	200	190	-	-	-	455	395	370	-	-	-	-	-	-
	2	-	-	-	320	250	215	250	190	170	195	170	140	-	-	-	280	255	230	-	-	-	-	-	-
	3	-	-	-	280	215	185	215	170	140	180	150	125	-	-	-	255	230	205	-	-	-	-	-	-
	4	-	-	-	235	170	145	180	130	110	160	130	105	-	-	-	190	175	160	-	-	-	-	-	-
	5	-	-	-	310	235	200	240	180	150	-	-	-	-	-	-	260	230	210	-	-	-	205	175	145
	6	-	-	-	205	160	130	160	120	100	-	-	-	-	-	-	160	135	110	-	-	-	180	130	95
M	1	-	-	-	190	120	80	130	80	60	-	-	-	-	-	-	205	185	155	270	240	220	250	205	170
	2	-	-	-	120	80	50	80	50	40	-	-	-	-	-	-	185	160	140	245	215	175	215	175	145
	3	-	-	-	125	80	55	85	50	40	-	-	-	-	-	-	145	130	115	185	160	125	175	130	100
K	1	120	90	75	275	245	220	220	205	180	-	-	-	505	460	410	295	265	240	-	-	-	-	-	-
	2	125	100	70	215	190	180	175	155	140	-	-	-	400	355	330	235	210	190	-	-	-	-	-	-
	3	130	95	60	180	160	145	155	145	125	-	-	-	335	300	275	195	175	160	-	-	-	-	-	-
N	1	900	600	500	-	-	-	-	-	-	-	-	-	-	-	-	-	-	-	-	-	-	-	-	-
	2	685	465	385	-	-	-	-	-	-	-	-	-	-	-	-	-	-	-	-	-	-	-	-	-
	3	450	280	200	-	-	-	-	-	-	-	-	-	-	-	-	-	-	-	-	-	-	-	-	-
S	1	-	-	-	-	-	-	50	35	30	-	-	-	-	-	-	-	-	-	55	50	35	50	40	30
	2	-	-	-	-	-	-	25	20	10	-	-	-	-	-	-	-	-	-	55	50	35	50	40	30
	3	-	-	-	-	-	-	70	40	30	-	-	-	-	-	-	-	-	-	65	55	35	60	50	30
	4	-	-	-	-	-	-	60	30	25	-	-	-	-	-	-	66	50	33	100	70	50	70	60	35
H	1	-	-	-	-	-	-	-	-	-	-	-	-	-	-	-	-	-	-	-	-	-	-	-	-
	2	-	-	-	-	-	-	-	-	-	-	-	-	-	-	-	-	-	-	-	-	-	-	-	-
	3	-	-	-	-	-	-	-	-	-	-	-	-	-	-	-	-	-	-	-	-	-	-	-	-

NOTE: FIRST choice starting speeds are in **bold** type.
As the average chip thickness increases, the speed should be decreased.

M100 • RD12 • Recommended Starting Feeds [mm]

Light Machining	General Purpose	Heavy Machining
-----------------	-----------------	-----------------

At 6,00 Axial Depth of Cut (ap)

Insert Geometry	Programmed Feed per Tooth (fz) as a % of Radial Depth of Cut (ae)															Insert Geometry
	5%			10%			20%			30%			40-100%			
RDHT-TX	0,35	0,33	0,56	0,25	0,24	0,40	0,19	0,18	0,30	0,16	0,16	0,26	0,15	0,14	0,24	RDHT-TX
RDMT-TX	0,35	0,42	0,70	0,25	0,30	0,50	0,19	0,23	0,38	0,16	0,20	0,33	0,15	0,18	0,30	RDMT-TX
RDPT-MMX	0,35	0,57	0,93	0,25	0,41	0,67	0,19	0,31	0,50	0,16	0,27	0,43	0,15	0,25	0,40	RDPT-MMX
RDHW-MH	0,35	0,70	1,08	0,25	0,50	0,78	0,19	0,38	0,58	0,16	0,33	0,50	0,15	0,30	0,46	RDHW-MH
RDMW-TX	0,35	0,70	1,16	0,25	0,50	0,83	0,19	0,38	0,62	0,16	0,33	0,54	0,15	0,30	0,50	RDMW-TX

At 3,00 Axial Depth of Cut (ap)

Insert Geometry	Programmed Feed per Tooth (fz) as a % of Radial Depth of Cut (ae)															Insert Geometry
	5%			10%			20%			30%			40-100%			
RDHT-TX	0,40	0,38	0,64	0,29	0,28	0,46	0,22	0,21	0,35	0,19	0,18	0,30	0,17	0,17	0,28	RDHT-TX
RDMT-TX	0,40	0,48	0,81	0,29	0,35	0,58	0,22	0,26	0,43	0,19	0,23	0,38	0,17	0,21	0,35	RDMT-TX
RDPT-MMX	0,40	0,66	1,08	0,29	0,48	0,77	0,22	0,36	0,58	0,19	0,31	0,50	0,17	0,29	0,46	RDPT-MMX
RDHW-MH	0,40	0,81	1,25	0,29	0,58	0,90	0,22	0,43	0,67	0,19	0,38	0,58	0,17	0,35	0,53	RDHW-MH
RDMW-TX	0,40	0,81	1,34	0,29	0,58	0,96	0,22	0,43	0,72	0,19	0,38	0,62	0,17	0,35	0,57	RDMW-TX

At 1,50 Axial Depth of Cut (ap)

Insert Geometry	Programmed Feed per Tooth (fz) as a % of Radial Depth of Cut (ae)															Insert Geometry
	5%			10%			20%			30%			40-100%			
RDHT-TX	0,53	0,50	0,85	0,38	0,36	0,61	0,28	0,27	0,45	0,25	0,24	0,40	0,23	0,22	0,36	RDHT-TX
RDMT-TX	0,53	0,63	1,06	0,38	0,46	0,76	0,28	0,34	0,57	0,25	0,30	0,50	0,23	0,27	0,45	RDMT-TX
RDPT-MMX	0,53	0,87	1,42	0,38	0,63	1,01	0,28	0,47	0,76	0,25	0,41	0,66	0,23	0,37	0,60	RDPT-MMX
RDHW-MH	0,53	1,06	1,65	0,38	0,76	1,18	0,28	0,57	0,88	0,25	0,50	0,76	0,23	0,45	0,70	RDHW-MH
RDMW-TX	0,53	1,06	1,78	0,38	0,76	1,26	0,28	0,57	0,94	0,25	0,50	0,82	0,23	0,45	0,75	RDMW-TX

At 0,75 Axial Depth of Cut (ap)

Insert Geometry	Programmed Feed per Tooth (fz) as a % of Radial Depth of Cut (ae)															Insert Geometry
	5%			10%			20%			30%			40-100%			
RDHT-TX	0,72	0,69	1,16	0,52	0,50	0,83	0,39	0,37	0,62	0,34	0,32	0,54	0,31	0,30	0,50	RDHT-TX
RDMT-TX	0,72	0,87	1,46	0,52	0,62	1,04	0,39	0,47	0,78	0,34	0,41	0,68	0,31	0,37	0,62	RDMT-TX
RDPT-MMX	0,72	1,20	1,96	0,52	0,86	1,39	0,39	0,64	1,03	0,34	0,56	0,90	0,31	0,51	0,82	RDPT-MMX
RDHW-MH	0,72	1,46	2,29	0,52	1,04	1,62	0,39	0,78	1,20	0,34	0,68	1,04	0,31	0,62	0,95	RDHW-MH
RDMW-TX	0,72	1,46	2,46	0,52	1,04	1,74	0,39	0,78	1,29	0,34	0,68	1,12	0,31	0,62	1,02	RDMW-TX

NOTE: Use "Light Machining" value as starting feed rate.

M100 • Weldon® Shank RD1605.. • Metric

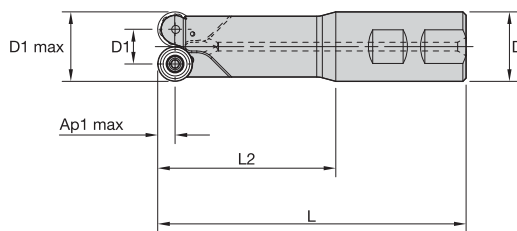

order number	catalogue number	D1 max	D1	D	L	L2	Ap1 max	Z	max ramp angle	max RPM	coolant supply	kg
2021341	12391013800	32	16	32	142	82	8,0	2	7.8	19000	Yes	1,10

NOTE: All spare parts except the insert screws must be ordered separately.

M100 • Shell Mills RD1605.. • Metric

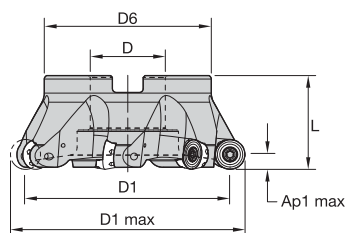

order number	catalogue number	D1 max	D1	D	D6	L	Ap1 max	Z	max ramp angle	max RPM	coolant supply	kg
2021347	12391021000	50	34	22	40	40	8,0	4	10.3	13000	Yes	0,20
2021348	12391021200	63	47	27	48	40	8,0	4	7.0	12000	Yes	0,30
2021349	12391021400	80	64	27	60	50	8,0	5	4.8	10000	Yes	0,90
2021350	12391021600	100	84	32	78	50	8,0	6	3.8	9000	No	1,20
2021351	12391021800	125	109	40	89	50	8,0	7	2.8	8000	No	1,70

NOTE: All spare parts except the insert screws must be ordered separately.

FOR SPARE PARTS, PLEASE VISIT WIDIA.COM OR WIDIANOVO.COM.
MOUNTING SCREWS ARE NOT INCLUDED IN STANDARD PACKAGING.

M100 • Shell Mills RC1606.. • Metric

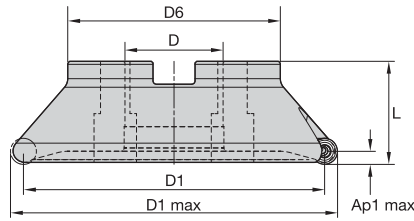

order number	catalogue number	D1 max	D1	D	D4	D6	L	Ap1 max	Z	max ramp angle	max RPM	coolant supply	kg
2021358	12391023400	50	34	22	—	40	40	8,0	4	6.0	13000	Yes	0,20
2021359	12391023600	52	36	22	—	40	40	8,0	4	5.8	13000	Yes	0,30
2021357	12391023200	63	47	27	—	48	40	8,0	5	4.0	12000	Yes	0,20
2021360	12391023800	66	50	27	—	48	40	8,0	5	3.8	12000	Yes	0,30
2021352	12391022000	80	64	27	—	60	50	8,0	6	2.8	10000	Yes	0,90
2021353	12391022200	100	84	32	—	78	50	8,0	7	2.3	9000	No	1,20
2021354	12391022400	125	109	40	—	89	50	8,0	8	1.8	8000	No	1,80
2021355	12391022600	160	144	40	67	90	63	8,0	9	1.3	7000	No	2,90

NOTE: All spare parts except the insert screws must be ordered separately.

INDEXABLE MILLING

SOLID END MILLING

HOLEMAKING

TAPPING

TURNING

INDEXABLE MILLING

M100 • RDMT-MOTX • RD1605..

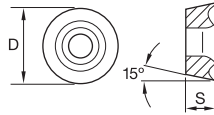
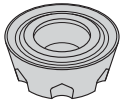

- first choice
- alternate choice

P	■	■	●	●	●	○	●
M	■	○	●	●	●	●	●
K	■	○	○	○	●	○	○
N	■	●	■	■	■	○	○
S	■	■	■	■	■	○	●
H	■	■	■	■	■	○	○

ISO catalogue number	number of indexes	D	S	hm	THM	TN6525	TN6540	TTM08	WK15CM	WP35CM	WS30PM	WS40PM
RDMT1605M0TX	6	16,00	5,56	—	■	■	■	■	■	6901189	■	■

SOLID END MILLING

HOLEMAKING

M100 • RDMW-MOTX • RD1605..

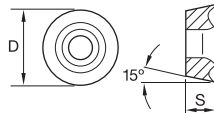
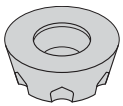

- first choice
- alternate choice

P	■	■	●	●	●	○	●
M	■	○	●	●	●	●	●
K	■	○	○	○	●	○	○
N	■	●	■	■	■	○	○
S	■	■	■	■	■	○	●
H	■	■	■	■	■	○	○

ISO catalogue number	number of indexes	D	S	hm	THM	TN6525	TN6540	TTM08	WK15CM	WP35CM	WS30PM	WS40PM
RDMW1605M0TX	6	16,00	5,56	0,15	■	■	3523083	2012608	■	■	■	■
RDMW1605M0TX	6	16,00	5,56	—	■	■	■	■	6901191	■	■	■

TAPPING

TURNING

M100 • RCMT-43 • RC1606..

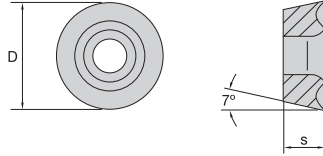
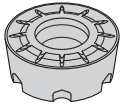

- first choice
- alternate choice

P	●	●	●	●	●	○	○
M	●	○	○	○	○	○	○
K	○	○	○	○	○	○	○
N	○	○	○	○	○	○	○
S	○	○	○	○	○	○	○
H	○	○	○	○	○	○	○

ISO catalogue number	D	S	hm	THM	TN6525	TN6540	TTM08	WK15CM	WP35CM	WS30PM	WS40PM
RCMT1606M043M	16,00	6,35	0,20	2028170	2957537						
RCMT1606M043	16,00	6,35	0,20								

M100 • RCMT-MOTX • RC1606..

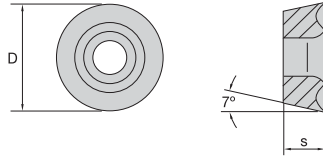

- first choice
- alternate choice

P	●	●	●	●	●	○	○
M	○	○	○	○	○	○	○
K	○	○	○	○	○	○	○
N	○	○	○	○	○	○	○
S	○	○	○	○	○	○	○
H	○	○	○	○	○	○	○

ISO catalogue number	number of indexes	D	S	hm	THM	TN6525	TN6540	TTM08	WK15CM	WP35CM	WS30PM	WS40PM
RCMT1606M0TX	6	16,00	6,35	0,24	2957535	2957427			5427442			
RCMT1606M0TX	6	16,00	6,35	—					6924077			

INDEXABLE MILLING

SOLID END MILLING

HOLEMAKING

TAPPING

TURNING

M100 • RD1605 • Insert Selection Guide

Material Group	Light Machining		General Purpose		Heavy Machining	
	Geometry	Grade	Geometry	Grade	Geometry	Grade
P1-P2	RDMT-TX	TN6525	RDMT-TX	TN6540	RDMT-TX	TN6540
P3-P4	RDMT-TX	TN6525	RDMW-TX	TN6540	RDMW-TX	TN6540
P5-P6	RDMT-TX	WP35CM	RDMT-TX	WP35CM	RDMT-TX	WP35CM
M1-M2	RDMT-TX	TN6525	RDMT-TX	TN6540	RDMT-TX	TN6540
M3	RDMT-TX	TN6525	RDMT-TX	TN6540	RDMT-TX	TN6540
K1-K2	RDMW-TX	TN2510	RDMW-TX	WP35CM	RDMW-TX	WP35CM
K3	RDMW-TX	TN2510	RDMW-TX	WP35CM	RDMW-TX	WP35CM
N1-N2	-	-	-	-	-	-
N3	-	-	-	-	-	-
S1-S2	-	-	RDMT-TX	TN6540	-	-
S3	-	-	RDMT-TX	TN6540	-	-
S4	-	-	RDMT-TX	TN6540	RDMT-TX	TN6540
H1	RDMW-TX	TN2510	RDMW-TX	TN2510	-	-

M100 • RD1605 • Recommended Starting Speeds [m/min]

Material Group		THM			TN6525			TN6540			TTM08			WK15CM			WP35CM			WS30PM			WS40PM		
P	1	-	-	-	410	320	280	360	280	240	230	200	190	-	-	-	455	395	370	-	-	-	-	-	-
	2	-	-	-	320	250	215	250	190	170	195	170	140	-	-	-	280	255	230	-	-	-	-	-	-
	3	-	-	-	280	215	185	215	170	140	180	150	125	-	-	-	255	230	205	-	-	-	-	-	-
	4	-	-	-	235	170	145	180	130	110	160	130	105	-	-	-	190	175	160	-	-	-	-	-	-
	5	-	-	-	310	235	200	240	180	150	-	-	-	-	-	-	260	230	210	-	-	-	205	175	145
	6	-	-	-	205	160	130	160	120	100	-	-	-	-	-	-	160	135	110	-	-	-	180	130	95
M	1	-	-	-	190	120	80	130	80	60	-	-	-	-	-	-	205	185	155	270	240	220	250	205	170
	2	-	-	-	120	80	50	80	50	40	-	-	-	-	-	-	185	160	140	245	215	175	215	175	145
	3	-	-	-	125	80	55	85	50	40	-	-	-	-	-	-	145	130	115	185	160	125	175	130	100
K	1	120	90	75	275	245	220	220	205	180	-	-	-	505	460	410	295	265	240	-	-	-	-	-	-
	2	125	100	70	215	190	180	175	155	140	-	-	-	400	355	330	235	210	190	-	-	-	-	-	-
	3	130	95	60	180	160	145	155	145	125	-	-	-	335	300	275	195	175	160	-	-	-	-	-	-
N	1	900	600	500	-	-	-	-	-	-	-	-	-	-	-	-	-	-	-	-	-	-	-	-	-
	2	685	465	385	-	-	-	-	-	-	-	-	-	-	-	-	-	-	-	-	-	-	-	-	-
	3	450	280	200	-	-	-	-	-	-	-	-	-	-	-	-	-	-	-	-	-	-	-	-	-
S	1	-	-	-	-	-	-	50	35	30	-	-	-	-	-	-	-	-	-	55	50	35	50	40	30
	2	-	-	-	-	-	-	25	20	10	-	-	-	-	-	-	-	-	-	55	50	35	50	40	30
	3	-	-	-	-	-	-	70	40	30	-	-	-	-	-	-	-	-	-	65	55	35	60	50	30
	4	-	-	-	-	-	-	60	30	25	-	-	-	-	-	-	66	50	33	100	70	50	70	60	35
H	1	-	-	-	-	-	-	-	-	-	-	-	-	-	-	-	-	-	-	-	-	-	-	-	-
	2	-	-	-	-	-	-	-	-	-	-	-	-	-	-	-	-	-	-	-	-	-	-	-	-
	3	-	-	-	-	-	-	-	-	-	-	-	-	-	-	-	-	-	-	-	-	-	-	-	-

NOTE: FIRST choice starting speeds are in **bold** type.
As the average chip thickness increases, the speed should be decreased.

M100 • RD1605 • Recommended Starting Feeds [mm]

Light Machining	General Purpose	Heavy Machining
-----------------	-----------------	-----------------

At 8,00mm Axial Depth of Cut (ap)

Insert Geometry	Programmed Feed per Tooth (fz) as a % of Radial Depth of Cut (ae)															Insert Geometry
	5%			10%			20%			30%			40-100%			
RDHX-TX	0,11	0,35	0,70	0,08	0,25	0,50	0,06	0,19	0,38	0,05	0,16	0,33	0,05	0,15	0,30	RDHX-TX
RDMT-TX	0,23	0,42	0,84	0,17	0,30	0,60	0,13	0,23	0,45	0,11	0,20	0,39	0,10	0,18	0,36	RDMT-TX
RDMW-TX	0,23	0,52	1,05	0,17	0,38	0,76	0,13	0,28	0,56	0,11	0,25	0,49	0,10	0,23	0,45	RDMW-TX

At 4,00mm Axial Depth of Cut (ap)

Insert Geometry	Programmed Feed per Tooth (fz) as a % of Radial Depth of Cut (ae)															Insert Geometry
	5%			10%			20%			30%			40-100%			
RDHX-TX	0,13	0,40	0,81	0,10	0,29	0,58	0,07	0,22	0,43	0,06	0,19	0,38	0,06	0,17	0,35	RDHX-TX
RDMT-TX	0,27	0,48	0,97	0,19	0,35	0,70	0,14	0,26	0,52	0,13	0,23	0,45	0,12	0,21	0,42	RDMT-TX
RDMW-TX	0,27	0,60	1,22	0,19	0,44	0,87	0,14	0,33	0,65	0,13	0,28	0,57	0,12	0,26	0,52	RDMW-TX

At 2,00mm Axial Depth of Cut (ap)

Insert Geometry	Programmed Feed per Tooth (fz) as a % of Radial Depth of Cut (ae)															Insert Geometry
	5%			10%			20%			30%			40-100%			
RDHX-TX	0,17	0,53	1,06	0,13	0,38	0,76	0,09	0,28	0,57	0,08	0,25	0,50	0,08	0,23	0,45	RDHX-TX
RDMT-TX	0,35	0,63	1,28	0,25	0,46	0,92	0,19	0,34	0,68	0,17	0,30	0,59	0,15	0,27	0,54	RDMT-TX
RDMW-TX	0,35	0,79	1,61	0,25	0,57	1,15	0,19	0,43	0,85	0,17	0,37	0,74	0,15	0,34	0,68	RDMW-TX

At 1,00mm Axial Depth of Cut (ap)

Insert Geometry	Programmed Feed per Tooth (fz) as a % of Radial Depth of Cut (ae)															Insert Geometry
	5%			10%			20%			30%			40-100%			
RDHX-TX	0,24	0,72	1,46	0,17	0,52	1,04	0,13	0,39	0,78	0,11	0,34	0,68	0,10	0,31	0,62	RDHX-TX
RDMT-TX	0,48	0,87	1,76	0,35	0,62	1,26	0,26	0,47	0,93	0,23	0,41	0,81	0,21	0,37	0,74	RDMT-TX
RDMW-TX	0,48	1,09	2,22	0,35	0,78	1,58	0,26	0,58	1,17	0,23	0,51	1,02	0,21	0,46	0,93	RDMW-TX

NOTE: Use "Light Machining" value as starting feed rate.

INDEXABLE MILLING

SOLID END MILLING

HOLEMAKING

TAPPING

TURNING

M100 • RC1606 • Insert Selection Guide

Material Group	Light Machining		General Purpose		Heavy Machining	
	Geometry	Grade	Geometry	Grade	Geometry	Grade
P1-P2	...TX	TN6525	...43M	TN6540	...43M	TN6540
P3-P4	...TX	TN6525	...TX	TN6540	...43M	TN6540
P5-P6	...TX	TN6525	...TX	WP35CM	...TX	WP35CM
M1-M2	...TX	TN6525	...TX	TN6540	...TX	TN6540
M3	...TX	TN6525	...TX	TN6540	...TX	TN6540
K1-K2	...43	TN2510	...TX	WK15CM	...TX	WK15CM
K3	...TX	TN6525	...TX	WK15CM	...TX	WK15CM
N1-N2	-	-	-	-	-	-
N3	-	-	-	-	-	-
S1-S2	-	-	-	-	-	-
S3	-	-	-	-	-	-
S4	...43M	TN6540	...TX	TN6540	...TX	TN6540
H1	-	-	...TX	TN2510	-	-

M100 • RC1606 • Recommended Starting Speeds [m/min]

Material Group	THM	TN6525			TN6540			TTM08			WK15CM			WP35CM			WS30PM			WS40PM					
P	1	-	-	-	410	320	280	360	280	240	230	200	190	-	-	-	455	395	370	-	-	-	-	-	-
	2	-	-	-	320	250	215	250	190	170	195	170	140	-	-	-	280	255	230	-	-	-	-	-	-
	3	-	-	-	280	215	185	215	170	140	180	150	125	-	-	-	255	230	205	-	-	-	-	-	-
	4	-	-	-	235	170	145	180	130	110	160	130	105	-	-	-	190	175	160	-	-	-	-	-	-
	5	-	-	-	310	235	200	240	180	150	-	-	-	-	-	-	260	230	210	-	-	-	205	175	145
	6	-	-	-	205	160	130	160	120	100	-	-	-	-	-	-	160	135	110	-	-	-	180	130	95
M	1	-	-	-	190	120	80	130	80	60	-	-	-	-	-	-	205	185	155	270	240	220	250	205	170
	2	-	-	-	120	80	50	80	50	40	-	-	-	-	-	-	185	160	140	245	215	175	215	175	145
	3	-	-	-	125	80	55	85	50	40	-	-	-	-	-	-	145	130	115	185	160	125	175	130	100
K	1	120	90	75	275	245	220	220	205	180	-	-	-	505	460	410	295	265	240	-	-	-	-	-	-
	2	125	100	70	215	190	180	175	155	140	-	-	-	400	355	330	235	210	190	-	-	-	-	-	-
	3	130	95	60	180	160	145	155	145	125	-	-	-	335	300	275	195	175	160	-	-	-	-	-	-
N	1	900	600	500	-	-	-	-	-	-	-	-	-	-	-	-	-	-	-	-	-	-	-	-	-
	2	685	465	385	-	-	-	-	-	-	-	-	-	-	-	-	-	-	-	-	-	-	-	-	-
	3	450	280	200	-	-	-	-	-	-	-	-	-	-	-	-	-	-	-	-	-	-	-	-	-
S	1	-	-	-	-	-	-	50	35	30	-	-	-	-	-	-	-	-	-	55	50	35	50	40	30
	2	-	-	-	-	-	-	25	20	10	-	-	-	-	-	-	-	-	-	55	50	35	50	40	30
	3	-	-	-	-	-	-	70	40	30	-	-	-	-	-	-	-	-	-	65	55	35	60	50	30
	4	-	-	-	-	-	-	60	30	25	-	-	-	-	-	-	66	50	33	100	70	50	70	60	35
H	1	-	-	-	-	-	-	-	-	-	-	-	-	-	-	-	-	-	-	-	-	-	-	-	-
	2	-	-	-	-	-	-	-	-	-	-	-	-	-	-	-	-	-	-	-	-	-	-	-	-
	3	-	-	-	-	-	-	-	-	-	-	-	-	-	-	-	-	-	-	-	-	-	-	-	-

NOTE: FIRST choice starting speeds are in **bold** type.
As the average chip thickness increases, the speed should be decreased.

M100 • RC1606 • Recommended Starting Feeds [mm]

Light Machining	General Purpose	Heavy Machining
-----------------	-----------------	-----------------

At 8,00mm Axial Depth of Cut (ap)

Insert Geometry	Programmed Feed per Tooth (fz) as a % of Radial Depth of Cut (ae)ç															Insert Geometry
	5%			10%			20%			30%			40-100%			
...43	0,46	0,60	0,93	0,33	0,44	0,67	0,25	0,33	0,50	0,22	0,28	0,44	0,20	0,26	0,40	...43
...TX	0,46	0,70	1,12	0,33	0,50	0,81	0,25	0,38	0,60	0,22	0,33	0,52	0,20	0,30	0,48	...TX

At 4,00mm Axial Depth of Cut (ap)

Insert Geometry	Programmed Feed per Tooth (fz) as a % of Radial Depth of Cut (ae)															Insert Geometry
	5%			10%			20%			30%			40-100%			
...43	0,54	0,70	1,08	0,39	0,50	0,78	0,29	0,38	0,58	0,25	0,33	0,50	0,23	0,30	0,46	...43
...TX	0,54	0,81	1,30	0,39	0,58	0,93	0,29	0,43	0,69	0,25	0,38	0,61	0,23	0,35	0,55	...TX

At 2,00mm Axial Depth of Cut (ap)

Insert Geometry	Programmed Feed per Tooth (fz) as a % of Radial Depth of Cut (ae)															Insert Geometry
	5%			10%			20%			30%			40-100%			
...43	0,70	0,92	1,42	0,51	0,66	1,02	0,38	0,49	0,76	0,33	0,43	0,66	0,30	0,39	0,60	...43
...TX	0,70	1,06	1,72	0,51	0,76	1,23	0,38	0,57	0,91	0,33	0,50	0,79	0,30	0,45	0,73	...TX

At 1,00mm Axial Depth of Cut (ap)

Insert Geometry	Programmed Feed per Tooth (fz) as a % of Radial Depth of Cut (ae)															Insert Geometry
	5%			10%			20%			30%			40-100%			
...43	0,96	1,26	1,97	0,69	0,90	1,40	0,52	0,67	1,04	0,45	0,59	0,90	0,41	0,54	0,83	...43
...TX	0,96	1,46	2,38	0,69	1,04	1,68	0,52	0,78	1,25	0,45	0,68	1,08	0,41	0,62	0,99	...TX

NOTE: Use "Light Machining" value as starting feed rate.

INDEXABLE MILLING

SOLID END MILLING

HOLEMAKING

TAPPING

TURNING

M270™ Series

M270 Toroidal, M270 High-Feed, M270 Ball Nose Copy Mills

With precision-engineered ball nose, toroidal, and high-feed inserts, the M270 Copy Mill Series provides the highest accuracy and insert stability for exceptional reliability and performance in semi-finishing and finishing applications.



Secure and rigid insert clamping.

Toroidal and high-feed inserts can use the same holder.

V-shaped contact faces enable maximum stability and accuracy.

Inserts offered can machine steel, stainless steel, cast iron, high-temp alloys, and hardened materials.

The M270 Series offers reliability and accuracy in semi-finishing and finishing operations with rigid insert clamping and V-shaped contact faces in various materials.

INSERTS

BF/BR



Ball nose inserts

TF

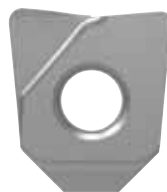

Toroidal inserts

HF



High-feed inserts

ACCURATE AND RELIABLE WITH M270

PRODUCT

SERIES

M270™

DIAMETER RANGE

10–32mm

SHANK TYPES

Screw-On End Mills
Cylindrical End Mills
Weldon® End Mills

INDUSTRY



APPLICATIONS



3D
PROFILING



FACE
MILLING



HELICAL
MILLING/
POCKET
MILLING



POCKETING



RAMPING
BLANK



SIDE MILLING/
SHOULDER
MILLING: BALL
NOSE



SIDE MILLING/
SHOULDER
MILLING:
SQUARE END



SLOTTING:
BALL NOSE



SLOTTING:
SQUARE END

ACCURATE

V-shaped contact faces ensure highly accurate insert positioning.

RELIABLE

Secure insert clamping provides a rigid setup for machining operations.



M270 Ball Nose • Screw-On • Metric

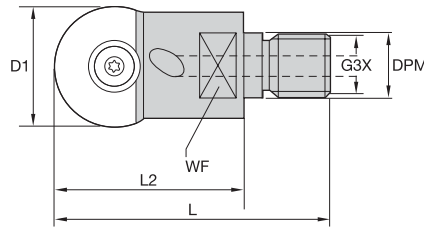

order number	catalogue number	D1	DPM	G3X	L	L2	WF	Z	Z U	insert	max RPM	coolant supply	kg
2243624	M270BD010M08	10	8,5	M8	42	25	10,0	1	2	M270B.10	57000	Yes	0,05
2243625	M270BD012M08	12	8,5	M8	42	25	10,0	1	2	M270B.12	55000	Yes	0,05
2243626	M270BD016M08	16	8,5	M8	47	30	10,0	1	2	M270B.16	53000	Yes	0,05
2243627	M270BD020M10	20	10,5	M10	59	40	14,0	1	2	M270B.20	52000	Yes	0,10
2243628	M270BD025M12	25	12,5	M12	72	50	19,0	1	2	M270B.25	50000	Yes	0,10
2243629	M270BD032M16	32	17,0	M16	73	50	22,0	1	2	M270B.32	46000	Yes	0,20

NOTE: ZU = Effective teeth.

Z = number of pocket seats.

NOTE: All spare parts except the insert screws must be ordered separately.

M270 Ball Nose • Weldon® Shank • Metric

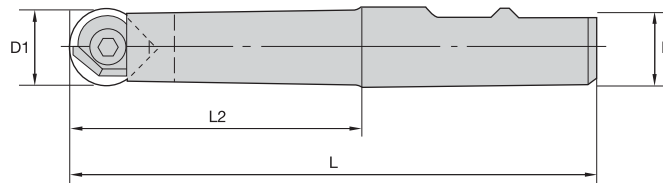

order number	catalogue number	D1	D	L	L2	Z	Z U	insert	max RPM	coolant supply	kg
2243618	M270BD010B12L90	10	12	90	45	1	2	M270B.10	57000	No	0,10
2243619	M270BD012B12L95	12	12	95	50	1	2	M270B.12	55000	No	0,10
2243620	M270BD016B16L105	16	16	105	57	1	2	M270B.16	53000	No	0,10
2243621	M270BD020B20L120	20	20	120	70	1	2	M270B.20	52000	No	0,20
2243622	M270BD025B25L145	25	25	145	89	1	2	M270B.25	50000	No	0,40
2243623	M270BD032B32L155	32	32	155	95	1	2	M270B.32	46000	No	0,80

NOTE: ZU = Effective teeth

Z = number of pocket seats

NOTE: All spare parts except the insert screws must be ordered separately.

FOR SPARE PARTS, PLEASE VISIT WIDIA.COM OR WIDIANOVO.COM.

MOUNTING SCREWS ARE NOT INCLUDED IN STANDARD PACKAGING.

M270 Ball Nose • Cylindrical Shank • Metric

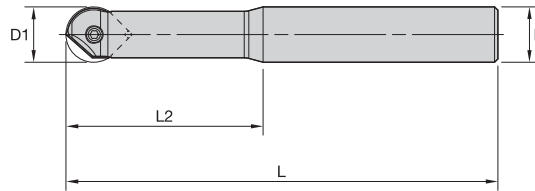

order number	catalogue number	D1	D	L	L2	Z	Z U	insert	max RPM	coolant supply	kg
2243613	M270BD010A12L140	10	12	140	45	1	2	M270B.10	57000	No	0,10
2243614	M270BD012A12L145	12	12	145	50	1	2	M270B.12	55000	No	0,10
2067470	M270BD016A16L155	16	16	155	57	1	2	M270B.16	53000	No	0,20
2243615	M270BD020A20L170	20	20	170	70	1	2	M270B.20	52000	No	0,40
2243616	M270BD025A25L195	25	25	195	89	1	2	M270B.25	50000	No	0,60
2243617	M270BD032A32L205	32	32	205	95	1	2	M270B.32	46000	No	1,10

NOTE: ZU = Effective teeth.

Z = number of pocket seats.

NOTE: All spare parts except the insert screws must be ordered separately.

M270 Ball Nose • Carbide Cylindrical Shank • Metric

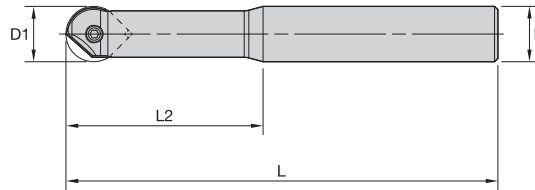

order number	catalogue number	D1	D	L	L2	Z	Z U	insert	max RPM	coolant supply	kg
2424550	M270BD010A12L140C	10	12	140	45	1	2	M270B.10	57000	Yes	0,20
2424587	M270BD012A12L145C	12	12	145	50	1	2	M270B.12	55000	Yes	0,20
2424634	M270BD016A16L155C	16	16	155	57	1	2	M270B.16	53000	Yes	0,40
2639257	M270BD020A20L170C	20	20	170	70	1	2	M270B.20	52000	Yes	0,65

NOTE: ZU = Effective teeth.

Z = number of pocket seats.

NOTE: All spare parts except the insert screws must be ordered separately.

INDEXABLE MILLING

SOLID END MILLING

HOLEMAKING

TAPPING

TURNING

M270 Ball Nose • BF MM

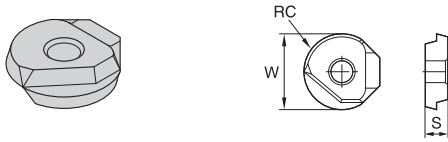

- first choice
- alternate choice

P	●	○	●	●	●	●
M	●	○	●	●	●	●
K	●	○	○	○	○	●
N	●	○	○	○	○	○
S	●	○	○	○	○	○
H	●	○	○	○	○	○

catalogue number	W	S	RC	hm	TN2505	TN6525	TN6540	WP35CM	WU10PM
M270BF10	10,00	2,38	5,00	0,08	●	○	○	○	○
M270BF10	10,00	2,38	5,00	—	○	○	○	○	●
M270BF12	12,00	3,18	6,00	0,08	●	○	○	○	○
M270BF12	12,00	3,18	6,00	—	○	○	○	○	●
M270BF16	16,00	4,76	8,00	0,08	●	○	○	○	○
M270BF16	16,00	4,76	8,00	—	○	○	○	○	●
M270BF20	20,00	4,76	10,00	0,10	●	○	○	○	○
M270BF20	20,00	4,76	10,00	—	○	○	○	○	●
M270BF25	25,00	4,76	12,50	0,10	●	○	○	○	○
M270BF25	25,00	4,76	12,50	—	○	○	○	○	●
M270BF32	32,00	4,76	16,00	0,10	●	○	○	○	○
M270BF32	32,00	4,76	16,00	—	○	○	○	○	●

M270 Ball Nose • BR MM

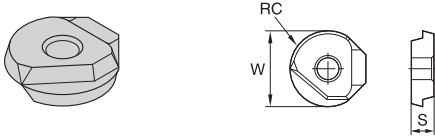

● first choice
○ alternate choice

P	●	○	●	●	●	●
M	●	○	○	○	○	○
K	●	○	○	○	○	○
N	●	○	○	○	○	○
S	●	○	○	○	○	○
H	●	○	○	○	○	○

catalogue number	W	S	RC	hm	TN2505	TN6525	TN6540	WP35CM	WU10PM
M270BR10	10,00	2,38	5,00	—	●	○	○	○	○
M270BR12	12,00	3,18	6,00	0,08	●	○	○	○	○
M270BR12	12,00	3,18	6,00	—	●	○	○	○	○
M270BR16	16,00	4,76	8,00	0,08	●	○	○	○	○
M270BR16	16,00	4,76	8,00	—	●	○	○	○	○
M270BR20	20,00	4,76	10,00	0,10	●	○	○	○	○
M270BR20	20,00	4,76	10,00	—	●	○	○	○	○
M270BR25	25,00	4,76	12,50	—	●	○	○	○	○
M270BR32	32,00	4,76	16,00	—	●	○	○	○	○

INDEXABLE MILLING

SOLID END MILLING

HOLEMAKING

TAPPING

TURNING

M270 Ball Nose • B10 • Insert Selection Guide

Material Group	Light Machining		General Purpose		Heavy Machining	
	Geometry	Grade	Geometry	Grade	Geometry	Grade
P1-P2	BF	TN2505	BR	WP35CM	BR	WP35CM
P3-P4	BF	TN2505	BR	WP35CM	BR	WP35CM
P5-P6	BF	TN2505	BR	WP35CM	BR	WP35CM
M1-M2	BR	WP35CM	BR	WP35CM	BR	WP35CM
M3	BR	WP35CM	BR	WP35CM	BR	WP35CM
K1-K2	BF	TN2505	BF	WU10PM	BF	WU10PM
K3	BF	TN2505	BF	WU10PM	BF	WU10PM
N1-N2	-	-	-	-	-	-
N3	-	-	-	-	-	-
S1-S2	-	-	-	-	-	-
S3	-	-	-	-	-	-
S4	-	-	-	-	-	-
H1	BF	TN2505	BF	TN2505	BF	TN2505

M270 Ball Nose • B12 • Insert Selection Guide

Material Group	Light Machining		General Purpose		Heavy Machining	
	Geometry	Grade	Geometry	Grade	Geometry	Grade
P1-P2	BF	TN2505	BR	WP35CM	BR	WP35CM
P3-P4	BF	TN2505	BR	WP35CM	BR	WP35CM
P5-P6	BF	TN2505	BR	WP35CM	BR	WP35CM
M1-M2	BR	WP35CM	BR	WP35CM	BR	WP35CM
M3	BR	WP35CM	BR	WP35CM	BR	WP35CM
K1-K2	BF	TN2505	BF	WU10PM	BF	WU10PM
K3	BF	TN2505	BF	WU10PM	BF	WU10PM
N1-N2	-	-	-	-	-	-
N3	-	-	-	-	-	-
S1-S2	-	-	-	-	-	-
S3	-	-	-	-	-	-
S4	-	-	-	-	-	-
H1	BF	TN2505	BF	TN2505	BF	TN2505

M270 Ball Nose • B16 • Insert Selection Guide

Material Group	Light Machining		General Purpose		Heavy Machining	
	Geometry	Grade	Geometry	Grade	Geometry	Grade
P1-P2	BF	TN6525	BR	TN6540	BR	WP35CM
P3-P4	BF	TN6525	BR	TN6540	BR	WP35CM
P5-P6	BF	TN6525	BR	TN6540	BR	WP35CM
M1-M2	BF	TN6525	BF	TN6525	BR	WP35CM
M3	BF	TN6525	BF	TN6525	BR	WP35CM
K1-K2	BF	TN2505	BF	WU10PM	BF	WU10PM
K3	BF	TN2505	BF	WU10PM	BF	WU10PM
N1-N2	-	-	-	-	-	-
N3	-	-	-	-	-	-
S1-S2	-	-	-	-	-	-
S3	-	-	-	-	-	-
S4	BF	TN2505	-	-	-	-
H1	BF	TN2505	BF	TN2505	BF	TN2505

M270 Ball Nose • B20 • Insert Selection Guide

Material Group	Light Machining		General Purpose		Heavy Machining	
	Geometry	Grade	Geometry	Grade	Geometry	Grade
P1-P2	BR	TN6540	BF	TN6540	BF	TN6540
P3-P4	BR	TN6540	BF	TN6540	BR	WP35CM
P5-P6	BR	TN6540	BR	WP35CM	BR	WP35CM
M1-M2	BR	TN6540	BR	TN6540	BR	TN6540
M3	BR	TN6540	BR	TN6540	BR	TN6540
K1-K2	BR	TN2505	BR	TN2505	-	-
K3	BR	TN2505	BR	TN2505	-	-
N1-N2	-	-	-	-	-	-
N3	-	-	-	-	-	-
S1-S2	-	-	BR	TN6540	-	-
S3	-	-	BR	TN6540	-	-
S4	-	-	BR	TN6540	-	-
H1	-	-	BR	TN2505	-	-

M270 Ball Nose • B25 • Insert Selection Guide

Material Group	Light Machining		General Purpose		Heavy Machining	
	Geometry	Grade	Geometry	Grade	Geometry	Grade
P1-P2	BR	WP35CM	BR	WP35CM	BR	WP35CM
P3-P4	BR	WP35CM	BR	WP35CM	BR	WP35CM
P5-P6	BR	WP35CM	BR	WP35CM	BR	WP35CM
M1-M2	BR	WP35CM	BR	WP35CM	BR	WP35CM
M3	BR	WP35CM	BR	WP35CM	BR	WP35CM
K1-K2	BF	TN2505	BF	TN2505	BF	TN2505
K3	BF	TN2505	BF	TN2505	BF	TN2505
N1-N2	-	-	-	-	-	-
N3	-	-	-	-	-	-
S1-S2	BR	WP35CM	-	-	-	-
S3	BR	WP35CM	-	-	-	-
S4	BF	TN2505	BR	WP35CM	-	-
H1	BF	TN2505	BR	WP35CM	BR	WP35CM

M270 Ball Nose • B32 • Insert Selection Guide

Material Group	Light Machining		General Purpose		Heavy Machining	
	Geometry	Grade	Geometry	Grade	Geometry	Grade
P1-P2	BR	WP35CM	BR	WP35CM	BR	WP35CM
P3-P4	BR	WP35CM	BR	WP35CM	BR	WP35CM
P5-P6	BR	WP35CM	BR	WP35CM	BR	WP35CM
M1-M2	BR	WP35CM	BR	WP35CM	BR	WP35CM
M3	BR	WP35CM	BR	WP35CM	BR	WP35CM
K1-K2	BF	TN2505	BF	TN2505	BF	TN2505
K3	BF	TN2505	BF	TN2505	BF	TN2505
N1-N2	-	-	-	-	-	-
N3	-	-	-	-	-	-
S1-S2	BR	WP35CM	-	-	-	-
S3	BR	WP35CM	-	-	-	-
S4	BR	WP35CM	BR	WP35CM	-	-
H1	BF	TN2505	BF	TN2505	BF	TN2505

M270 Ball Nose • Recommended Starting Speeds [m/min]

Material Group		TN2505			TN6525			TN6540			WP35CM			WU10PM		
P	1	550	420	360	410	320	280	360	280	240	455	395	370	-	-	-
	2	320	240	205	320	250	215	250	190	170	280	255	230	-	-	-
	3	320	240	205	280	215	185	215	170	140	255	230	205	-	-	-
	4	-	-	-	235	170	145	180	130	110	190	175	160	-	-	-
	5	-	-	-	310	235	200	240	180	150	260	230	210	-	-	-
	6	-	-	-	205	160	130	160	120	100	160	135	110	-	-	-
M	1	-	-	-	190	120	80	130	80	60	205	185	155	-	-	-
	2	-	-	-	120	80	50	80	50	40	185	160	140	-	-	-
	3	-	-	-	125	80	55	85	50	40	145	130	115	-	-	-
K	1	400	300	250	275	245	220	220	205	180	295	265	240	295	265	240
	2	540	365	280	215	190	180	175	155	140	235	210	190	230	205	190
	3	310	190	155	180	160	145	155	145	125	195	175	160	195	175	160
N	1	-	-	-	-	-	-	-	-	-	-	-	-	-	-	-
	2	-	-	-	-	-	-	-	-	-	-	-	-	-	-	-
	3	-	-	-	-	-	-	-	-	-	-	-	-	-	-	-
S	1	-	-	-	-	-	-	50	35	30	-	-	-	-	-	-
	2	-	-	-	-	-	-	25	20	10	-	-	-	-	-	-
	3	-	-	-	-	-	-	70	40	30	-	-	-	-	-	-
	4	-	-	-	-	-	-	60	30	25	66	50	33	-	-	-
H	1	175	140	95	-	-	-	-	-	-	-	-	-	160	130	90
	2	175	140	95	-	-	-	-	-	-	-	-	-	-	-	-
	3	140	115	80	-	-	-	-	-	-	-	-	-	-	-	-

NOTE: FIRST choice starting speeds are in **bold** type.
As the average chip thickness increases, the speed should be decreased.

INDEXABLE MILLING

SOLID END MILLING

HOLEMAKING

TAPPING

TURNING

M270 Ball Nose • B10 • Recommended Starting Feeds [mm]

Light Machining	General Purpose	Heavy Machining
-----------------	-----------------	-----------------

At 4,76mm Axial Depth of Cut (ap)

Insert Geometry	Programmed Feed per Tooth (fz) as a % of Radial Depth of Cut (ae)															Insert Geometry
	5%			10%			20%			30%			40-100%			
BF	0,12	0,23	0,42	0,08	0,16	0,29	0,06	0,12	0,21	0,05	0,10	0,18	0,05	0,10	0,17	BF
BR	0,19	0,29	0,51	0,14	0,20	0,35	0,10	0,15	0,25	0,09	0,13	0,22	0,08	0,12	0,20	BR

At 2,38mm Axial Depth of Cut (ap)

Insert Geometry	Programmed Feed per Tooth (fz) as a % of Radial Depth of Cut (ae)															Insert Geometry
	5%			10%			20%			30%			40-100%			
BF	0,14	0,27	0,49	0,10	0,19	0,34	0,07	0,14	0,25	0,06	0,12	0,21	0,06	0,11	0,19	BF
BR	0,22	0,34	0,61	0,16	0,24	0,40	0,12	0,17	0,29	0,10	0,15	0,25	0,09	0,14	0,23	BR

At 1,19mm Axial Depth of Cut (ap)

Insert Geometry	Programmed Feed per Tooth (fz) as a % of Radial Depth of Cut (ae)															Insert Geometry
	5%			10%			20%			30%			40-100%			
BF	0,18	0,36	0,68	0,13	0,25	0,45	0,09	0,18	0,32	0,08	0,16	0,28	0,08	0,15	0,25	BF
BR	0,29	0,46	0,84	0,21	0,31	0,54	0,15	0,23	0,39	0,13	0,20	0,33	0,12	0,18	0,30	BR

At 0,60mm Axial Depth of Cut (ap)

Insert Geometry	Programmed Feed per Tooth (fz) as a % of Radial Depth of Cut (ae)															Insert Geometry
	5%			10%			20%			30%			40-100%			
BF	0,25	0,51	1,02	0,18	0,34	0,63	0,13	0,25	0,44	0,11	0,22	0,38	0,10	0,20	0,35	BF
BR	0,41	0,66	1,34	0,28	0,44	0,76	0,21	0,31	0,53	0,18	0,27	0,45	0,17	0,25	0,41	BR

NOTE: Use "Light Machining" value as starting feed rate.

M270 Ball Nose • B12 • Recommended Starting Feeds [mm]

Light Machining	General Purpose	Heavy Machining
-----------------	-----------------	-----------------

At 5,00mm Axial Depth of Cut (ap)

Insert Geometry	Programmed Feed per Tooth (fz) as a % of Radial Depth of Cut (ae)															Insert Geometry
	5%			10%			20%			30%			40-100%			
BR	0,13	0,29	0,43	0,09	0,20	0,30	0,07	0,15	0,22	0,06	0,13	0,19	0,06	0,12	0,18	BR
BF	0,21	0,39	0,58	0,15	0,27	0,40	0,11	0,20	0,29	0,10	0,18	0,25	0,09	0,16	0,23	BF

At 2,50mm Axial Depth of Cut (ap)

Insert Geometry	Programmed Feed per Tooth (fz) as a % of Radial Depth of Cut (ae)															Insert Geometry
	5%			10%			20%			30%			40-100%			
BR	0,15	0,33	0,50	0,11	0,24	0,35	0,08	0,17	0,26	0,07	0,15	0,22	0,06	0,14	0,20	BR
BF	0,24	0,46	0,69	0,17	0,32	0,47	0,13	0,23	0,34	0,11	0,20	0,29	0,10	0,18	0,27	BF

At 1,25mm Axial Depth of Cut (ap)

Insert Geometry	Programmed Feed per Tooth (fz) as a % of Radial Depth of Cut (ae)															Insert Geometry
	5%			10%			20%			30%			40-100%			
BR	0,20	0,45	0,68	0,14	0,31	0,46	0,11	0,23	0,34	0,09	0,20	0,29	0,08	0,18	0,27	BR
BF	0,32	0,61	0,94	0,23	0,42	0,62	0,17	0,31	0,45	0,15	0,26	0,38	0,13	0,24	0,35	BF

At 0,63mm Axial Depth of Cut (ap)

Insert Geometry	Programmed Feed per Tooth (fz) as a % of Radial Depth of Cut (ae)															Insert Geometry
	5%			10%			20%			30%			40-100%			
BR	0,28	0,63	0,99	0,20	0,43	0,64	0,15	0,31	0,46	0,13	0,27	0,40	0,12	0,25	0,36	BR
BF	0,45	0,89	1,42	0,31	0,58	0,87	0,23	0,42	0,61	0,20	0,36	0,53	0,18	0,33	0,48	BF

NOTE: Use "Light Machining" value as starting feed rate.

M270 Ball Nose • B16 • Recommended Starting Feeds [mm]

Light Machining	General Purpose	Heavy Machining
-----------------	-----------------	-----------------

At 8,00mm Axial Depth of Cut (ap)

Insert Geometry	Programmed Feed per Tooth (fz) as a % of Radial Depth of Cut (ae)															Insert Geometry
	5%			10%			20%			30%			40-100%			
BF	0,14	0,28	0,45	0,10	0,20	0,31	0,08	0,15	0,23	0,07	0,13	0,20	0,06	0,12	0,18	BF
BR	0,21	0,38	0,59	0,15	0,27	0,41	0,11	0,20	0,30	0,10	0,17	0,26	0,09	0,16	0,24	BR

At 4,00mm Axial Depth of Cut (ap)

Insert Geometry	Programmed Feed per Tooth (fz) as a % of Radial Depth of Cut (ae)															Insert Geometry
	5%			10%			20%			30%			40-100%			
BF	0,16	0,33	0,52	0,12	0,23	0,36	0,09	0,17	0,27	0,08	0,15	0,23	0,07	0,14	0,21	BF
BR	0,24	0,45	0,69	0,17	0,31	0,48	0,13	0,23	0,35	0,11	0,20	0,30	0,10	0,18	0,28	BR

At 2,00mm Axial Depth of Cut (ap)

Insert Geometry	Programmed Feed per Tooth (fz) as a % of Radial Depth of Cut (ae)															Insert Geometry
	5%			10%			20%			30%			40-100%			
BF	0,21	0,44	0,70	0,15	0,31	0,48	0,11	0,23	0,35	0,10	0,20	0,30	0,09	0,18	0,28	BF
BR	0,32	0,60	0,94	0,23	0,42	0,63	0,17	0,31	0,46	0,15	0,26	0,40	0,13	0,24	0,36	BR

At 1,00mm Axial Depth of Cut (ap)

Insert Geometry	Programmed Feed per Tooth (fz) as a % of Radial Depth of Cut (ae)															Insert Geometry
	5%			10%			20%			30%			40-100%			
BF	0,29	0,61	0,99	0,21	0,43	0,66	0,16	0,31	0,48	0,14	0,27	0,42	0,12	0,25	0,38	BF
BR	0,44	0,85	1,38	0,31	0,57	0,88	0,23	0,42	0,63	0,20	0,36	0,54	0,18	0,33	0,50	BR

NOTE: Use "Light Machining" value as starting feed rate.

M270 Ball Nose • B20 • Recommended Starting Feeds [mm]

Light Machining	General Purpose	Heavy Machining
-----------------	-----------------	-----------------

At 10,00mm Axial Depth of Cut (ap)

Insert Geometry	Programmed Feed per Tooth (fz) as a % of Radial Depth of Cut (ae)															Insert Geometry
	5%			10%			20%			30%			40-100%			
BF	0,19	0,24	0,40	0,13	0,17	0,28	0,10	0,13	0,21	0,09	0,11	0,18	0,08	0,10	0,17	BF
BR	0,24	0,38	0,65	0,17	0,27	0,46	0,13	0,20	0,34	0,11	0,17	0,30	0,10	0,16	0,27	BR

At 5,00mm Axial Depth of Cut (ap)

Insert Geometry	Programmed Feed per Tooth (fz) as a % of Radial Depth of Cut (ae)															Insert Geometry
	5%			10%			20%			30%			40-100%			
BF	0,22	0,28	0,46	0,15	0,20	0,33	0,12	0,15	0,24	0,10	0,13	0,21	0,09	0,12	0,19	BF
BR	0,27	0,44	0,76	0,20	0,31	0,53	0,15	0,23	0,39	0,13	0,20	0,34	0,12	0,18	0,31	BR

At 2,50mm Axial Depth of Cut (ap)

Insert Geometry	Programmed Feed per Tooth (fz) as a % of Radial Depth of Cut (ae)															Insert Geometry
	5%			10%			20%			30%			40-100%			
BF	0,28	0,37	0,61	0,20	0,27	0,43	0,15	0,20	0,32	0,13	0,17	0,28	0,12	0,16	0,25	BF
BR	0,36	0,58	1,01	0,26	0,41	0,70	0,19	0,30	0,52	0,17	0,26	0,45	0,15	0,24	0,41	BR

At 1,25mm Axial Depth of Cut (ap)

Insert Geometry	Programmed Feed per Tooth (fz) as a % of Radial Depth of Cut (ae)															Insert Geometry
	5%			10%			20%			30%			40-100%			
BF	0,39	0,51	0,85	0,28	0,36	0,59	0,21	0,27	0,44	0,18	0,23	0,38	0,17	0,21	0,35	BF
BR	0,50	0,81	1,44	0,36	0,56	0,97	0,26	0,42	0,71	0,23	0,36	0,61	0,21	0,33	0,56	BR

NOTE: Use "Light Machining" value as starting feed rate.

M270 Ball Nose • B25 • Recommended Starting Feeds [mm]

Light Machining	General Purpose	Heavy Machining
-----------------	-----------------	-----------------

At 12,50mm Axial Depth of Cut (ap)

Insert Geometry	Programmed Feed per Tooth (fz) as a % of Radial Depth of Cut (ae)															Insert Geometry
	5%			10%			20%			30%			40-100%			
BF	0,17	0,31	0,50	0,13	0,22	0,36	0,09	0,16	0,26	0,08	0,14	0,23	0,08	0,13	0,21	BF
BR	0,24	0,38	0,65	0,17	0,27	0,46	0,13	0,20	0,34	0,11	0,17	0,30	0,10	0,16	0,27	BR

At 6,25mm Axial Depth of Cut (ap)

Insert Geometry	Programmed Feed per Tooth (fz) as a % of Radial Depth of Cut (ae)															Insert Geometry
	5%			10%			20%			30%			40-100%			
BF	0,20	0,35	0,58	0,15	0,25	0,41	0,11	0,19	0,30	0,09	0,16	0,27	0,09	0,15	0,24	BF
BR	0,27	0,44	0,76	0,20	0,31	0,53	0,15	0,23	0,39	0,13	0,20	0,34	0,12	0,18	0,31	BR

At 3,13mm Axial Depth of Cut (ap)

Insert Geometry	Programmed Feed per Tooth (fz) as a % of Radial Depth of Cut (ae)															Insert Geometry
	5%			10%			20%			30%			40-100%			
BF	0,27	0,47	0,77	0,19	0,33	0,54	0,14	0,25	0,40	0,12	0,21	0,35	0,11	0,20	0,32	BF
BR	0,36	0,58	1,02	0,26	0,41	0,70	0,19	0,30	0,52	0,17	0,26	0,45	0,15	0,24	0,41	BR

At 1,56mm Axial Depth of Cut (ap)

Insert Geometry	Programmed Feed per Tooth (fz) as a % of Radial Depth of Cut (ae)															Insert Geometry
	5%			10%			20%			30%			40-100%			
BF	0,37	0,65	1,09	0,26	0,46	0,75	0,19	0,34	0,55	0,17	0,29	0,47	0,15	0,27	0,43	BF
BR	0,50	0,81	1,44	0,36	0,56	0,97	0,26	0,42	0,71	0,23	0,36	0,61	0,21	0,33	0,56	BR

NOTE: Use "Light Machining" value as starting feed rate.

M270 Ball Nose • B32 • Recommended Starting Feeds [mm]

Light Machining	General Purpose	Heavy Machining
-----------------	-----------------	-----------------

At 16,00mm Axial Depth of Cut (ap)

Insert Geometry	Programmed Feed per Tooth (fz) as a % of Radial Depth of Cut (ae)															Insert Geometry
	5%			10%			20%			30%			40-100%			
BF	0,17	0,30	0,47	0,13	0,22	0,34	0,09	0,16	0,25	0,08	0,14	0,22	0,08	0,13	0,20	BF
BR	0,23	0,38	0,59	0,17	0,27	0,42	0,13	0,20	0,31	0,11	0,17	0,27	0,10	0,16	0,25	BR

At 8,00mm Axial Depth of Cut (ap)

Insert Geometry	Programmed Feed per Tooth (fz) as a % of Radial Depth of Cut (ae)															Insert Geometry
	5%			10%			20%			30%			40-100%			
BF	0,20	0,35	0,55	0,15	0,25	0,39	0,11	0,19	0,29	0,09	0,16	0,25	0,09	0,15	0,23	BF
BR	0,27	0,43	0,69	0,19	0,31	0,49	0,14	0,23	0,36	0,13	0,20	0,32	0,12	0,18	0,29	BR

At 4,00mm Axial Depth of Cut (ap)

Insert Geometry	Programmed Feed per Tooth (fz) as a % of Radial Depth of Cut (ae)															Insert Geometry
	5%			10%			20%			30%			40-100%			
BF	0,26	0,46	0,72	0,19	0,33	0,51	0,14	0,25	0,38	0,12	0,21	0,33	0,11	0,20	0,30	BF
BR	0,35	0,57	0,92	0,25	0,41	0,64	0,19	0,30	0,48	0,17	0,26	0,41	0,15	0,24	0,38	BR



At 2,00mm Axial Depth of Cut (ap)

Insert Geometry	Programmed Feed per Tooth (fz) as a % of Radial Depth of Cut (ae)															Insert Geometry
	5%			10%			20%			30%			40-100%			
BF	0,36	0,64	1,01	0,26	0,45	0,71	0,19	0,34	0,52	0,17	0,29	0,45	0,15	0,27	0,41	BF
BR	0,49	0,80	1,28	0,35	0,56	0,89	0,26	0,42	0,65	0,23	0,36	0,57	0,21	0,33	0,52	BR

NOTE: Use "Light Machining" value as starting feed rate.

Selecting the Correct Insert and Cutting Conditions for Your Application

1. Insert Style: Considerations for Selecting the Correct Insert

Best Choices for Insert and Grade Selection	BR Geometry		BF Geometry
			
Grade	WP35CM	WU10PM	TN2505
● First choice ○ Alternate choice			
Roughing Operation	●	○	
Finishing Operation		○	●
Low RPM Machine	●	○	
Flat Areas or Face Milling (≤10° inclination)	●	○	
Hard Machining		○	●
Unstable and/or Long Overhangs	●	○	
HSM or 5-Axis Machining (smaller ap/ae values)	●	○	

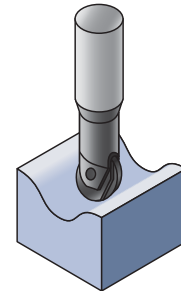

2. Calculating effective diameter and resulting surface speed

It is important to consider the effective diameter (Deff) when using light depths of cut in order to properly calculate RPM values. Use the following formula when machining flat surfaces or inclinations of 10° or less to find the Deff value, and then use this for RPM calculations as opposed to using the overall insert diameter (D1).

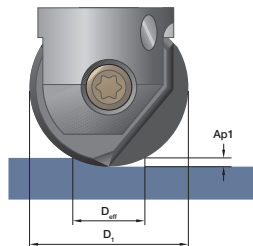

When machining inclinations between 11° and 55°, further modification of vc is required. Apply factor “k” from the given formula to calculate the correct vc (vceff). This corrected value is then used to calculate the proper RPM for the tool.

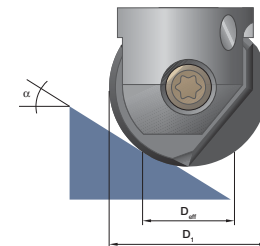

$$D_{eff} = \sqrt{D1^2 - (D1 - 2Ap1)^2}$$

Deff

$$k = \frac{1}{\sin [\alpha + \arccos (1 - (2 (Ap1/D1)))]}$$

$$v_{c\text{ eff}} = v_c \times k$$

Starting Values for Semi-Finishing in Common Material Types (L/D ratio <3 x D1)

M270 is usually applied for semi-finishing and finishing operations; Ap1/ae conditions depend on the operation. As a general rule: Ap1/ae ≤0,05D.

Material	Tool Diameter																	
	Ø10		Ø12		Ø16		Ø20		Ø25		Ø32							
	max rec. (mm)	fz (mm/tooth)	max rec. (mm)	fz (mm/tooth)	max rec. (mm)	fz (mm/tooth)	max rec. (mm)	fz (mm/tooth)	max rec. (mm)	fz (mm/tooth)	max rec. (mm)	fz (mm/tooth)						
Soft Steel <250 HB	0,7	0,7	0,2	0,8	0,8	0,2	1,1	1,1	0,27	1,3	1,3	0,27	1,7	1,7	0,3	2,1	2,1	0,3
High-Strength Steel 33-44 HRC	0,5	0,5	0,15	0,6	0,6	0,2	0,8	0,8	0,25	1	1	0,25	1,3	1,3	0,25	1,6	1,6	0,25
Hardened Steel 44-55 HRC	0,3	0,3	0,15	0,4	0,4	0,2	0,5	0,5	0,22	0,7	0,7	0,22	0,8	0,8	0,25	1,1	1,1	0,25
Gray Cast Iron GG25...	1	1	0,2	1,2	1,2	0,25	1,6	1,6	0,25	2	2	0,25	2,5	2,5	0,3	3,2	3,2	0,3
Nodular Cast Iron GGG60...	0,7	0,7	0,2	0,8	0,8	0,25	1,1	1,1	0,25	1,3	1,3	0,25	1,7	1,7	0,3	2,1	2,1	0,3

M270 Toroidal • Screw-On • Metric

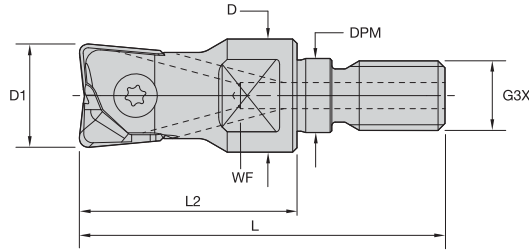

order number	catalogue number	D1	D	DPM	G3X	L	L2	WF	Z	Z U	inserts	max RPM	coolant supply	kg
3926546	M270TD012M08	12	13	8,5	M8	42	25	10	1	2	M270TF12R..	55000	Yes	0,02
3926547	M270TD016M08	16	13	8,5	M8	47	30	10	1	2	M270TF16R..	53000	Yes	0,09
3926548	M270TD020M10	20	18	10,5	M10	59	40	14	1	2	M270TF20R..	52000	Yes	0,07

NOTE: ZU = Effective teeth.

Z = number of pocket seats.

NOTE: All spare parts except the insert screws must be ordered separately.

M270 Toroidal • Cylindrical Shank • Metric

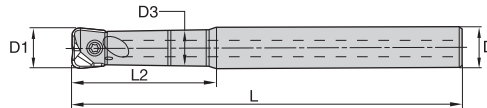

order number	catalogue number	D1	D	D3	L	L2	Z	Z U	inserts	max RPM	coolant supply	kg
3926514	M270TD010A10L120	10	10	9	120	45	1	2	M270TF10R..	57000	Yes	0,06
3926515	M270TD012A12L140	12	12	11	140	50	1	2	M270TF12R..	55000	Yes	0,09
3926516	M270TD016A16L160	16	16	14	160	57	1	2	M270TF16R..	53000	Yes	0,19
3926517	M270TD020A20L180	20	20	18	180	70	1	2	M270TF20R..	52000	Yes	0,35

NOTE: ZU = Effective teeth.

Z = number of pocket seats.

NOTE: All spare parts except the insert screws must be ordered separately.

M270 Toroidal • Carbide Cylindrical Shank • Metric

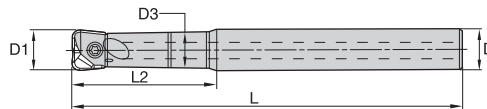

order number	catalogue number	D1	D	D3	L	L2	Z	Z U	inserts	max RPM	coolant supply	kg
3926518	M270TD010A10L120C	10	10	9	120	45	1	2	M270TF10R..	57000	Yes	0,11
3926519	M270TD010A10L150C	10	10	9	150	45	1	2	M270TF10R..	57000	Yes	0,14
3926520	M270TD012A12L120C	12	12	11	120	50	1	2	M270TF12R..	55000	Yes	0,15
3926521	M270TD012A12L160C	12	12	11	160	50	1	2	M270TF12R..	55000	Yes	0,22
3926522	M270TD016A16L140C	16	16	14	140	57	1	2	M270TF16R..	53000	Yes	0,32
3926543	M270TD016A16L180C	16	16	14	180	57	1	2	M270TF16R..	53000	Yes	0,44
3926544	M270TD020A20L150C	20	20	18	150	70	1	2	M270TF20R..	52000	Yes	0,52
3926545	M270TD020A20L200C	20	20	18	200	70	1	2	M270TF20R..	52000	Yes	0,74

NOTE: ZU = Effective teeth.

Z = number of pocket seats.

NOTE: All spare parts except the insert screws must be ordered separately.

FOR SPARE PARTS, PLEASE VISIT WIDIA.COM OR WIDIANOVO.COM.

MOUNTING SCREWS ARE NOT INCLUDED IN STANDARD PACKAGING.

INDEXABLE MILLING

SOLID END MILLING

HOLE/MAKING

TAPPING

TURNING

M270 Toroidal • TF

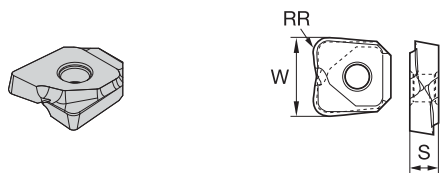

- first choice
- alternate choice

P	●	○	●	●	●
M	●	○	●	●	●
K	●	○	○	○	●
N	●	○	○	○	●
S	○	○	○	○	○
H	●	○	○	○	○

catalogue number	W	S	RR	hm	TN2505	TN6525	TN6540	WP35CM	WU10PM
M270TF10R05	10,00	2,38	0,50	—	●	●	●	●	6724706
M270TF10R1	10,00	2,38	1,00	0,08	○	○	○	○	2095682
M270TF12R05	12,00	3,18	0,50	—	●	●	●	●	6724705
M270TF12R1	12,00	3,18	1,01	—	○	○	○	○	6724710
M270TF12R2	12,00	3,18	2,01	0,08	○	○	○	○	2095640
M270TF16R05	16,00	4,76	0,50	—	●	●	●	●	6724703
M270TF16R1	16,00	4,76	1,01	—	○	○	○	○	6724744
M270TF20R05	20,00	4,76	0,50	—	●	●	●	●	6724708

M270 Toroidal • Insert Selection Guide

Material Group	Light Machining		General Purpose		Heavy Machining	
	Geometry	Grade	Geometry	Grade	Geometry	Grade
P1-P2	TF	WU10PM	TF	WU10PM	TF	WU10PM
P3-P4	TF	WU10PM	TF	WU10PM	TF	WU10PM
P5-P6	TF	WU10PM	TF	WU10PM	-	-
M1-M2	TF	WU10PM	-	-	-	-
M3	TF	WU10PM	-	-	-	-
K1-K2	TF	WU10PM	TF	WU10PM	-	-
K3	TF	WU10PM	TF	WU10PM	-	-
N1-N2	-	-	-	-	-	-
N3	-	-	-	-	-	-
S1-S2	TF	WU10PM	-	-	-	-
S3	TF	WU10PM	-	-	-	-
S4	TF	WU10PM	-	-	-	-
H1	TF	TN2505	TF	WU10PM	-	-

M270 Toroidal • Recommended Starting Speeds [m/min]

Material Group		TN2505			TN6525			TN6540			WP35CM			WU10PM			
P	1	550	420	360	410	320	280	360	280	240	455	395	370	-	-	-	-
	2	320	240	205	320	250	215	250	190	170	280	255	230	-	-	-	-
	3	320	240	205	280	215	185	215	170	140	255	230	205	-	-	-	-
	4	-	-	-	235	170	145	180	130	110	190	175	160	-	-	-	-
	5	-	-	-	310	235	200	240	180	150	260	230	210	-	-	-	-
	6	-	-	-	205	160	130	160	120	100	160	135	110	-	-	-	-
M	1	-	-	-	190	120	80	130	80	60	205	185	155	-	-	-	-
	2	-	-	-	120	80	50	80	50	40	185	160	140	-	-	-	-
	3	-	-	-	125	80	55	85	50	40	145	130	115	-	-	-	-
K	1	400	300	250	275	245	220	220	205	180	295	265	240	295	265	240	-
	2	540	365	280	215	190	180	175	155	140	235	210	190	230	205	190	-
	3	310	190	155	180	160	145	155	145	125	195	175	160	195	175	160	-
N	1	-	-	-	-	-	-	-	-	-	-	-	-	-	-	-	-
	2	-	-	-	-	-	-	-	-	-	-	-	-	-	-	-	-
	3	-	-	-	-	-	-	-	-	-	-	-	-	-	-	-	-
S	1	-	-	-	-	-	-	50	35	30	-	-	-	-	-	-	-
	2	-	-	-	-	-	-	25	20	10	-	-	-	-	-	-	-
	3	-	-	-	-	-	-	70	40	30	-	-	-	-	-	-	-
	4	-	-	-	-	-	-	60	30	25	66	50	33	-	-	-	-
H	1	175	140	95	-	-	-	-	-	-	-	-	-	160	130	90	-
	2	175	140	95	-	-	-	-	-	-	-	-	-	-	-	-	-
	3	140	115	80	-	-	-	-	-	-	-	-	-	-	-	-	-

NOTE: FIRST choice starting speeds are in **bold** type.
As the average chip thickness increases, the speed should be decreased.

M270 Toroidal • Recommended Starting Feeds [mm]

Light Machining	General Purpose	Heavy Machining
-----------------	-----------------	-----------------

Insert Geometry	Programmed Feed per Tooth (fz) as a % of Radial Depth of Cut (ae)															Insert Geometry
	5%			10%			20%			30%			40-100%			
TF	0,12	0,37	0,62	0,09	0,26	0,43	0,06	0,19	0,31	0,06	0,17	0,27	0,05	0,15	0,25	TF

NOTE: Use "Light Machining" value as starting feed rate.

M270 High Feed • Cylindrical Shank • Metric

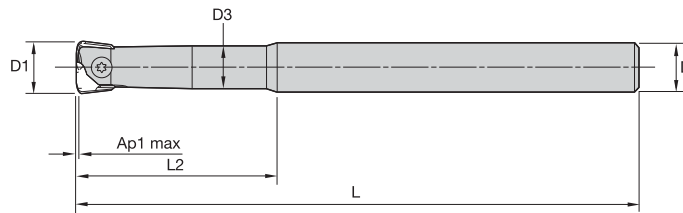

order number	catalogue number	D1	D	D3	L	L2	Ap1 max	Z	Z U	insert 1	max RPM	coolant supply	kg
3926514	M270TD010A10L120	10	10	9	120	45	0,6	1	2	M270HF10	57000	Yes	0,06
3926515	M270TD012A12L140	12	12	11	140	50	0,6	1	2	M270HF12	55000	Yes	0,09
3926516	M270TD016A16L160	16	16	14	160	57	0,9	1	2	M270HF16	53000	Yes	0,19

NOTE: ZU = Effective teeth.

Z = number of pocket seats.

NOTE: All spare parts except the insert screws must be ordered separately.

M270 High Feed • Carbide Cylindrical Shank • Metric

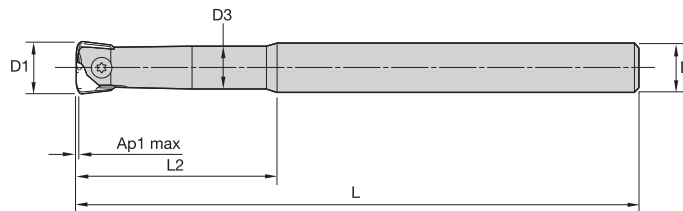

order number	catalogue number	D1	D	D3	L	L2	Ap1 max	Z	Z U	insert 1	max RPM	coolant supply	kg
3926518	M270TD010A10L120C	10	10	9	120	45	0,6	1	2	M270HF10	57000	Yes	0,11
3926519	M270TD010A10L150C	10	10	9	150	45	0,6	1	2	M270HF10	57000	Yes	0,14
3926520	M270TD012A12L120C	12	12	11	120	50	0,6	1	2	M270HF12	55000	Yes	0,15
3926521	M270TD012A12L160C	12	12	11	160	50	0,6	1	2	M270HF12	55000	Yes	0,22
3926522	M270TD016A16L140C	16	16	14	140	57	0,9	1	2	M270HF16	53000	Yes	0,32
3926543	M270TD016A16L180C	16	16	14	180	57	0,9	1	2	M270HF16	53000	Yes	0,44

NOTE: ZU = Effective teeth.

Z = number of pocket seats.

NOTE: All spare parts except the insert screws must be ordered separately.

M270 High Feed • Toroidal • Screw-On • Metric

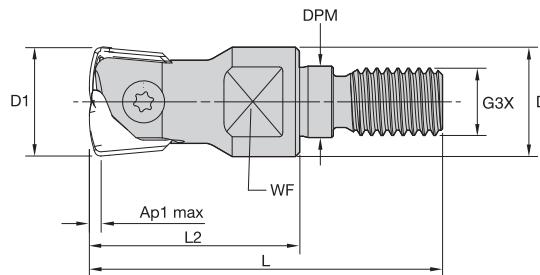

order number	catalogue number	D1	D	DPM	G3X	L	L2	WF	Ap1 max	Z	Z U	insert 1	max RPM	coolant supply	kg
3926546	M270TD012M08	12	13	8,5	M8	42	25	10	0,6	1	2	M270HF12	55000	Yes	0,02
3926547	M270TD016M08	16	13	8,5	M8	47	30	10	0,9	1	2	M270HF16	53000	Yes	0,09

NOTE: ZU = Effective teeth.

Z = number of pocket seats.

NOTE: All spare parts except the insert screws must be ordered separately.

M270 High Feed • HF

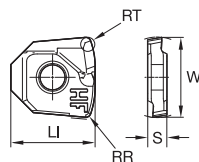
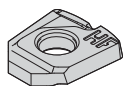

- first choice
- alternate choice

P	●	○	●	●	●	●
M	●	○	○	○	○	○
K	●	○	○	○	○	○
N	○	○	○	○	○	○
S	○	○	○	○	○	○
H	○	○	○	○	○	○

catalogue number	W	LI	S	RR	RT	hm	TN2505	TN6525	TN6540	WP35CM	WU10PM
M270HF10	10,00	10,50	2,38	0,63	1,15	0,08	●	○	○	○	○
M270HF12	12,00	12,40	3,18	0,75	1,40	0,08	○	○	○	○	○
M270HF16	16,00	16,70	4,76	1,00	1,90	0,08	○	○	○	○	○

M270 High Feed • Insert Selection Guide

Material Group	Light Machining		General Purpose		Heavy Machining	
	Geometry	Grade	Geometry	Grade	Geometry	Grade
P1-P2	HF	TN6525	HF	TN6540	HF	TN6540
P3-P4	HF	TN6525	HF	TN6540	HF	TN6540
P5-P6	HF	TN6525	HF	TN6540	HF	TN6540
M1-M2	HF	TN6525	HF	TN6540	HF	TN6540
M3	HF	TN6525	HF	TN6540	HF	TN6540
K1-K2	HF	TN2505	HF	TN6525	-	-
K3	HF	TN2505	HF	TN6525	-	-
N1-N2	-	-	-	-	-	-
N3	-	-	-	-	-	-
S1-S2	HF	TN6525	HF	TN6540	-	-
S3	HF	TN6525	HF	TN6540	-	-
S4	HF	TN6525	HF	TN6540	HF	TN6540
H1	HF	TN2505	HF	TN2505	HF	TN6525

FOR SPARE PARTS, PLEASE VISIT WIDIA.COM OR WIDIANOVO.COM.
MOUNTING SCREWS ARE NOT INCLUDED IN STANDARD PACKAGING.

M270 High Feed • Recommended Starting Speeds [m/min]

Material Group		TN2505			TN6525			TN6540			WP35CM			WU10PM		
P	1	550	420	360	410	320	280	360	280	240	455	395	370	-	-	-
	2	320	240	205	320	250	215	250	190	170	280	255	230	-	-	-
	3	320	240	205	280	215	185	215	170	140	255	230	205	-	-	-
	4	-	-	-	235	170	145	180	130	110	190	175	160	-	-	-
	5	-	-	-	310	235	200	240	180	150	260	230	210	-	-	-
	6	-	-	-	205	160	130	160	120	100	160	135	110	-	-	-
M	1	-	-	-	190	120	80	130	80	60	205	185	155	-	-	-
	2	-	-	-	120	80	50	80	50	40	185	160	140	-	-	-
	3	-	-	-	125	80	55	85	50	40	145	130	115	-	-	-
K	1	400	300	250	275	245	220	220	205	180	295	265	240	295	265	240
	2	540	365	280	215	190	180	175	155	140	235	210	190	230	205	190
	3	310	190	155	180	160	145	155	145	125	195	175	160	195	175	160
N	1	-	-	-	-	-	-	-	-	-	-	-	-	-	-	-
	2	-	-	-	-	-	-	-	-	-	-	-	-	-	-	-
	3	-	-	-	-	-	-	-	-	-	-	-	-	-	-	-
S	1	-	-	-	-	-	-	50	35	30	-	-	-	-	-	-
	2	-	-	-	-	-	-	25	20	10	-	-	-	-	-	-
	3	-	-	-	-	-	-	70	40	30	-	-	-	-	-	-
	4	-	-	-	-	-	-	60	30	25	66	50	33	-	-	-
H	1	175	140	95	-	-	-	-	-	-	-	-	-	160	130	90
	2	175	140	95	-	-	-	-	-	-	-	-	-	-	-	-
	3	140	115	80	-	-	-	-	-	-	-	-	-	-	-	-

NOTE: FIRST choice starting speeds are in **bold** type.
As the average chip thickness increases, the speed should be decreased.

M270 High Feed • HF10 • Recommended Starting Feeds [mm]

Light Machining	General Purpose	Heavy Machining
-----------------	-----------------	-----------------

Insert Geometry	Programmed Feed per Tooth (fz) as a % of Radial Depth of Cut (ae)														Insert Geometry	
	5%			10%			20%			30%			40-100%			
HF	1,01	1,57	-	0,67	0,97	1,41	0,48	0,69	0,97	0,42	0,59	0,83	0,38	0,54	0,75	HF

NOTE: Use "Light Machining" value as starting feed rate.

M270 High Feed • HF12 • Recommended Starting Feeds [mm]

Light Machining	General Purpose	Heavy Machining
-----------------	-----------------	-----------------

Insert Geometry	Programmed Feed per Tooth (fz) as a % of Radial Depth of Cut (ae)														Insert Geometry	
	5%			10%			20%			30%			40-100%			
HF	0,91	1,53	2,81	0,61	0,96	1,43	0,45	0,69	0,99	0,39	0,59	0,85	0,35	0,54	0,77	HF

NOTE: Use "Light Machining" value as starting feed rate.

M270 High Feed • HF16 • Recommended Starting Feeds [mm]

Light Machining	General Purpose	Heavy Machining
-----------------	-----------------	-----------------

Insert Geometry	Programmed Feed per Tooth (fz) as a % of Radial Depth of Cut (ae)														Insert Geometry	
	5%			10%			20%			30%			40-100%			
HF	1,03	1,60	3,34	0,69	1,00	1,50	0,50	0,71	1,03	0,43	0,61	0,88	0,39	0,56	0,80	HF

NOTE: Use "Light Machining" value as starting feed rate.

INDEXABLE MILLING

SOLID END MILLING

HOLEMAKING

TAPPING

TURNING

Applying High-Feed Tools

The high-feed concept bases its strategy in small depth of cut and high fz values, which results in a higher MRR and productivity with low radial forces.

Recommended when long overhang is necessary due to lower radial forces. Maximum L/D ratio of 10 x D.

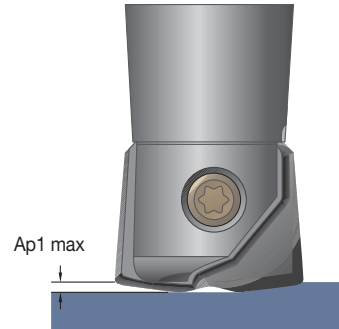
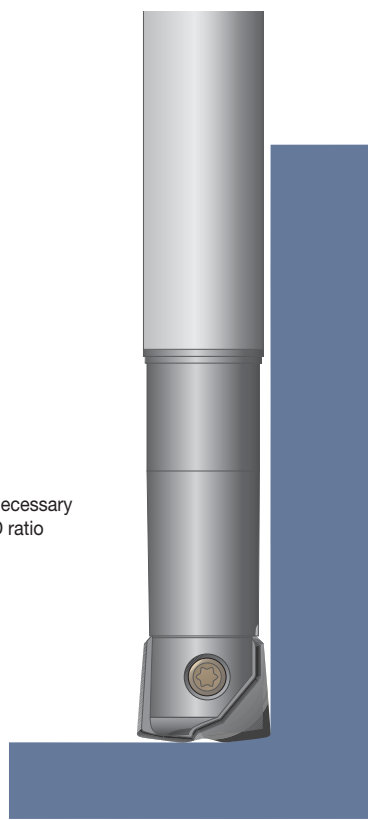

Small Ap1 values and higher feed rate generate lower cutting forces versus traditional milling strategies.

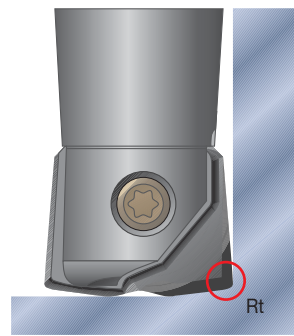

For CAM programming, the tools can be programmed as a toroidal tool type by using the Rt value as the insert radius.

L/D ratio	% of Ap1 max to reduce	% of vc to reduce
<4	0%	0%
4<L/D<7	55-65%	10-15%
>8	65-75%	20-30%

General Programming Information for Applying M270 High Feed

tool diameter	Ø10	Ø12	Ø13	Ø16	Ø17	Ø20
recommended starting Ap1 (mm)	0,40	0,40	0,40	0,60	0,60	0,75
Rt CAM programming	1,15	1,40	1,40	1,90	1,90	2,30
fz recommended for general purpose	0,45	0,55	0,55	0,60	0,60	0,70
fz recommended for 45 HRC (approx.)	0,40	0,45	0,45	0,55	0,55	0,65
fz recommended for 55 HRC (approx.)	0,30	0,35	0,35	0,45	0,45	0,50

NOTE: Use two effective teeth for feed calculations.
 For materials above 45 HRC, we recommend adjusting the ae max to 55% of cutting diameter and using no more than 50% of Ap1 max.
 While center cutting is possible, we recommend using a ramp angle of 0.5°-1.0° to ensure smooth operation.

General Milling and ISO Inserts

Additional Inserts

Use general milling and ISO inserts in the latest WIDIA™ grades as an economical solution for improved productivity in face milling, shoulder milling, and copy milling applications.

Inserts offered in pressed and sintered to size (PSTS) and ground versions for economical and precise solutions.

Available in the latest Victory™ grades: WK15CM, WP35CM, and WU20PM.

Inserts can be used in existing tool bodies for lower tooling costs.

Materials include all types of steel, stainless steel, cast iron, and nodular iron.

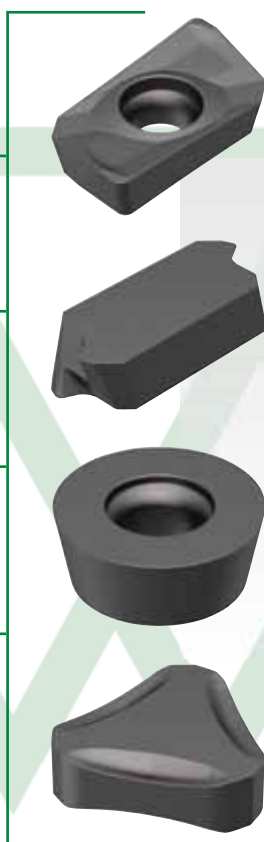

The general milling and ISO inserts are cost-effective inserts that provide higher performance for applications in automotive, heavy equipment, railroad components, and general engineering parts.

WK15CM



WK15CM is a wear-resistant grade with balanced toughness for general milling of cast irons. Best results in dry machining, but can also be used wet.

WP35CM



WP35CM has a wide range of applications in general and rough milling of steels and cast iron. Performs best in dry, but can also be used under wet conditions.

WU20PM



WU20PM is a universal grade for machining of steel, stainless steel, and high-temperature alloys. Also suitable for machining of gray and nodular irons. Resists breakage and offers improved wear resistance and increased strength. Can be used for both dry and wet machining.

HIGHER PERFORMANCE AT LOWER COST

PRODUCT

SERIES
General Milling/
ISO Inserts

INDUSTRY



APPLICATIONS



FACE
MILLING



SIDE MILLING/
SHOULDER
MILLING

PERFORMANCE

Using proven WIDIA™ grades, improve productivity in all types of steel, stainless steel, cast iron, and nodular iron workpiece materials.

COST EFFECTIVE

Inserts can be used in existing cutter bodies reducing tooling costs.



INDEXABLE MILLING

Indexable Milling • Face Milling ISO Inserts • LNCX

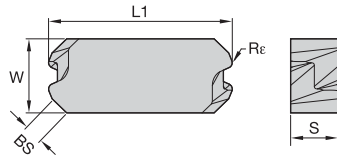

- first choice
- alternate choice

P	●	●
M	●	●
K	○	●
N	○	●
S	○	○
H	○	○

SOLID END MILLING

ISO catalogue number	cutting edges	W	S	BS	R ϵ	hm	WP35CM	WK15CM
LNCX1806AZR11	4	10,00	6,40	2,16	0,75	0,05	•	5343199
LNCX1806AZR11	4	10,00	6,40	2,16	0,75	0,06	6852433	•

HOLEMAKING

TAPPING

Indexable Milling • Face Milling ISO Inserts • SEAN-1 • SE1203..

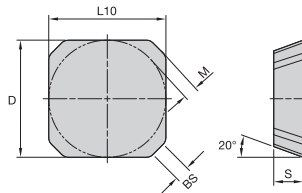
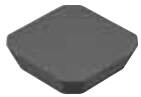

- first choice
- alternate choice

P	●	●
M	○	○
K	○	○
N	○	●
S	○	○
H	○	○

TURNING

catalogue number	cutting edges	D	L10	M	S	BS	hm	TT125	THM
SEAN1203AFN1	4	12,70	12,70	1,66	3,18	1,65	0,10	2028344	•
SEAN1203AFN	4	12,70	12,70	1,43	3,18	1,57	0,02	6870582	•

Indexable Milling • Face Milling ISO Inserts • SEKN-1 • SE1203..

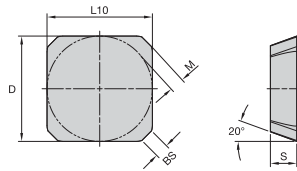

- first choice
- alternate choice

P	●	●	●	●	●	●	●
M	●	●	●	●	●	●	●
K	●	○	○	○	○	○	○
N	●	●	●	●	●	●	●
S	●	●	●	●	●	●	●
H	●	●	●	●	●	●	●

catalogue number	cutting edges	D	L10	M	S	BS	hm	TN6540	TTI25	THM	WP35CM	WK15CM
SEKN1203AFN1	4	12,70	12,70	1,66	3,18	1,65	0,14	3065464	2028349	2028350	6923425	5427318
SEKN1203AFN1	4	12,70	12,70	1,66	3,18	1,65	—	—	—	—	—	—
SEKN1203AFN	4	12,70	12,70	1,66	3,18	1,65	0,02	—	—	2562668	—	—
SEKN1203AFN	4	12,70	12,70	1,66	3,18	1,65	0,05	—	—	—	6877205	—

INDEXABLE MILLING

SOLID END MILLING

HOLEMAKING

TAPPING

TURNING

Indexable Milling • Face Milling ISO Inserts • SEKR-MS • SE1203....

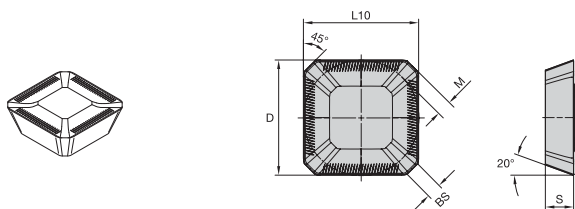

- first choice
- alternate choice

P	●	●	●
M	●	●	●
K	○	○	○
N	○	○	○
S	○	○	○
H	○	○	○

catalogue number	cutting edges	D	L10	M	S	BS	hm	THR	WU20PM	WP35CM
SEKR1203AFNMS	4	12,70	12,70	1,66	3,10	1,65	0,14	2012927	●	●
SEKR1203AFNMS	4	12,70	12,70	1,66	3,10	1,65	0,04	●	●	6901194
SEKR1203AFNMS	4	12,70	12,70	1,66	3,10	1,65	0,05	●	2415793	●
SEKR1204AFNMS	4	12,70	12,70	1,66	4,76	1,65	—	●	●	6858937
SEKR1504AFNMS	4	15,88	15,88	2,25	4,76	1,90	0,13	●	●	6901200

Indexable Milling • Face Milling ISO Inserts • SEPT

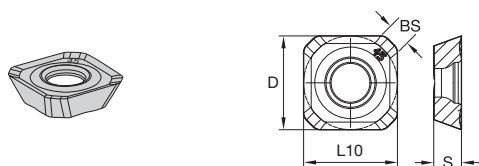

- first choice
- alternate choice

P	●	●	●
M	○	○	○
K	○	○	○
N	○	○	○
S	○	○	○
H	○	○	○

catalogue number	cutting edges	D	L10	S	BS	TN6525	TN6540
SEPT13T3AGENMM	4	13,41	13,41	3,96	2,50	4072174	4072175

Indexable Milling • Face Milling ISO Inserts • SP..

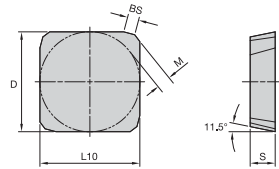

- first choice
- alternate choice

P	●	○	○	○	○	○	○	○	○
M	○	○	○	○	○	○	○	○	○
K	○	○	○	○	○	○	○	○	○
N	○	○	○	○	○	○	○	○	○
S	○	○	○	○	○	○	○	○	○
H	○	○	○	○	○	○	○	○	○

catalogue number	cutting edges	D	L10	M	S	BS	hm	THM	WP35CM	WK15CM	WU20PM
SPKN1203EDL_WK15CM	4	12,70	12,70	0,90	3,18	1,42	0,06	•	•	•	•
SPKN1203EDL	4	12,70	12,70	1,80	3,18	1,03	0,02	○	○	○	○
SPKN1203EDL	4	12,70	12,70	1,80	3,18	1,03	0,05	•	•	•	•
SPKN1203EDR_WK15CM	4	12,70	12,70	0,90	3,18	1,42	0,06	•	•	•	•
SPKN1203EDR	4	12,70	12,70	1,80	3,18	1,03	0,02	○	○	○	○
SPKN1203EDR THM	4	12,70	12,70	0,90	3,18	1,42	0,06	•	•	•	•
SPKN1203EDR	4	12,70	12,70	1,80	3,18	1,03	0,05	○	○	○	○
SPKN1203EDTR	4	12,70	12,70	0,90	3,17	1,43	—	•	•	•	•
SPKN1504EDL	4	15,88	15,88	2,48	4,76	0,94	0,02	○	○	○	○
SPKN1504EDL	4	15,88	15,88	2,48	4,76	0,94	0,06	•	•	•	•
SPKN1504EDR	4	15,88	15,88	2,48	4,76	0,94	0,02	○	○	○	○
SPKN1504EDR	4	15,88	15,88	1,25	4,76	1,42	0,08	•	•	•	•
SPKN1504EDR	4	15,88	15,88	2,48	4,76	0,94	0,05	○	○	○	○
SPKN1504EDR	4	15,88	15,88	2,48	4,76	0,94	0,07	•	•	•	•

INDEXABLE MILLING

Indexable Milling • Face Milling ISO Inserts • SPAN

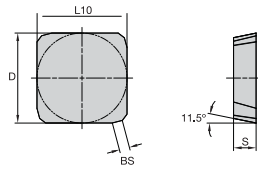

- first choice
- alternate choice

P	●	●
M	●	●
K	○	○
N	○	○
S	○	○
H	○	○

SOLID END MILLING

ISO catalogue number	cutting edges	D	L10	S	BS	hm	WP35CM	WU20PM
SPAN1203EDL	4	13	12,70	3,18	1,03	0,05	9997503	
SPAN1203EDR	4	13	12,70	3,18	1,03	0,05	6877203	
SPAN1203EDR	4	13	12,70	3,18	1,03	0,06	2557457	

HOLEMAKING

TAPPING

Indexable Milling • Face Milling ISO Inserts • SPCX

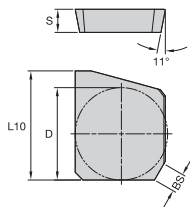

- first choice
- alternate choice

P	●	●
M	●	●
K	○	○
N	○	○
S	○	○
H	○	○

TURNING

ISO catalogue number	cutting edges	D	L10	S	hm	THM-F
SPCX1203EDL	1	13	15,00	3,18	0,02	2557024
SPCX1203EDR	1	13	15,00	3,18	0,02	2557061

Indexable Milling • Face Milling ISO Inserts • SPKR

- first choice
- alternate choice

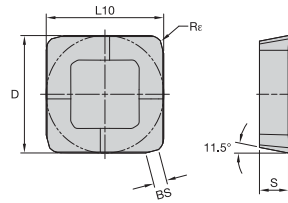
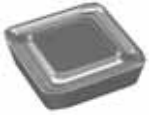

P	●
M	●
K	○
N	○
S	○
H	○

ISO catalogue number	cutting edges	D	L10	S	BS	R ϵ	hm	
SPKR1203EDLMS	4	13	12,70	3,18	1,40	1,60	0,05	WU20PM
SPKR1203EDRMS	4	13	12,70	3,18	1,40	1,60	0,05	2561005

Indexable Milling • Face Milling ISO Inserts • TNHF

- first choice
- alternate choice

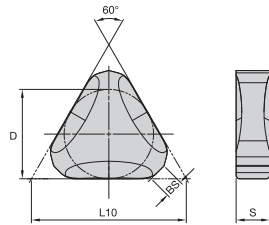

P	●
M	●
K	○
N	○
S	○
H	○

ISO catalogue number	cutting edges	D	L10	S	BS	hm	
TNHF1204ANCA	6	13	22,00	4,76	2,58	0,05	WK15CM
							6008686

Indexable Milling • Face Milling ISO Inserts • TPAN

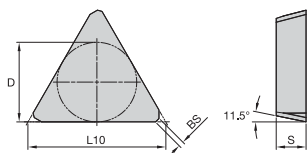

- first choice
- alternate choice

P	●	●
M	●	●
K	○	○
N	○	○
S	○	○
H	○	○

ISO catalogue number	cutting edges	D	L10	S	BS	hm	WP35CM	WU20PM
TPAN1103PPN	3	6	10,96	3,18	0,71	0,04	6877241	2557715
TPAN1603PDR	3	10	16,45	3,18	0,03	0,05	6877242	2568655
TPAN1603PPN	3	10	16,45	3,18	1,17	0,05	6877204	2557665
TPAN2204PPN	3	13	21,96	4,76	1,24	0,06	6877210	6869240
TPAN2204PDR	3	13	21,96	4,76	1,35	0,06	6801236	-
TPAN2204PDR	3	13	21,96	4,76	1,35	0,07	-	2557789
TPAN22T3AER	3	13	22,49	3,97	2,11	0,06	6877243	-

INDEXABLE MILLING

SOLID END MILLING

HOLEMAKING

TAPPING

TURNING

Indexable Milling • Face Milling ISO Inserts • TPKN

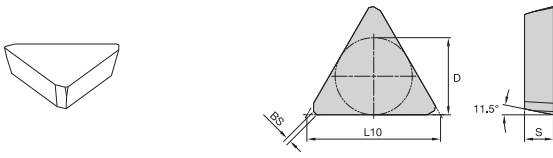

- first choice
- alternate choice

P	●	●	●
M	●	●	●
K	○	●	○
N	○	○	○
S	○	○	○
H	○	○	○

ISO catalogue number	cutting edges	D	L10	S	BS	Rε	hm	WP35CM	WK15CM	WU20PM
TPKN1603PDR	3	10	16,45	3,18	1,29	—	0,05	—	—	3869253
TPKN1603PPN	3	10	16,50	3,18	1,20	—	0,05	6877208	—	—
TPKN1603PDR	3	10	16,50	3,18	1,22	1,10	0,13	6901195	—	—
TPKN2204PDL	3	13	21,95	4,76	0,72	—	0,05	—	—	2557538
TPKN2204PDR	3	13	21,95	4,76	0,72	—	0,05	—	—	2557571
TPKN2204PDR	3	13	21,95	4,76	0,72	—	0,06	6873002	—	—
TPKN2204PDL	3	13	21,95	4,76	0,72	—	0,06	6877209	—	—
TPKN2204PDR	3	13	21,95	4,76	0,72	—	0,18	—	5427377	—

INDEXABLE MILLING

SOLID END MILLING

HOLEMAKING

TAPPING

TURNING

INDEXABLE MILLING

SOLID END MILLING

HOLEMAKING

TAPPING

TURNING

Indexable Milling • Face Milling ISO Inserts • TPKR-MS

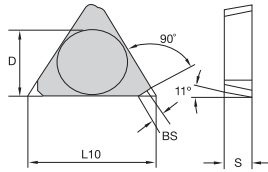
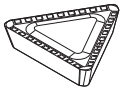

- first choice
- alternate choice

P	●	●	●	●	●
M	●	●	●	●	●
K	○	○	○	○	○
N	○	○	○	○	○
S	○	○	○	○	○
H	○	○	○	○	○

ISO catalogue number	cutting edges	D	L10	S	BS	hm	THM	TTM08	WP35CM	WU20PM
TPKR1603PDRMS	3	10	16,50	3,18	1,40	0,04	5107759	-	6901196	-
TPKR1603PDRMS	3	10	16,50	3,18	1,40	0,05	-	-	-	4120195
TPKR1603PDRMS	3	10	16,50	3,18	1,40	0,10	2014885	-	-	-

Indexable Milling • Shoulder Milling ISO Inserts • ADPT

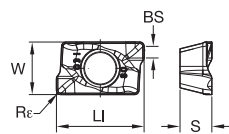
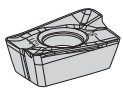

- first choice
- alternate choice

P	●	●	●	●	●
M	●	●	●	●	●
K	○	○	○	○	○
N	○	○	○	○	○
S	○	○	○	○	○
H	○	○	○	○	○

catalogue number	cutting edges	W	LI	S	BS	Rε	TTN6540
ADPT150508ERMM	2	9,65	16,12	5,84	2,13	0,79	4071302

Indexable Milling • Shoulder Milling ISO Inserts • APMT

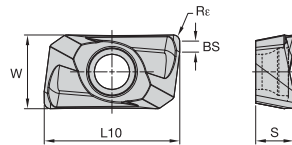

- first choice
- alternate choice

P	●
M	●
K	○
N	○
S	○
H	○
	○

ISO catalogue number	cutting edges	L10	W	S	BS	Re	hm	WU20PM
APMT1135PDR	2	11,20	5,95	3,50	—	0,80	0,05	6196890
APMT1604PDR	2	17,00	9,24	4,76	1,38	0,80	0,05	6196891

Indexable Milling • Shoulder Milling ISO Inserts • APPT

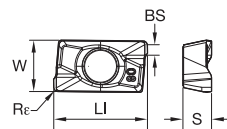
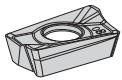

- first choice
- alternate choice

P	●
M	●
K	○
N	○
S	●
H	○
	○

catalogue number	cutting edges	W	LI	S	BS	Re	TN6540
APPT160408PDERMM	2	9,43	17,24	5,26	1,47	0,79	4071254
APPT160408PDSRMM	2	9,41	17,20	5,26	1,49	0,79	4071257
APPT160416PDERMM	2	9,43	17,22	5,27	1,43	1,59	4071259
APPT160432PDERMM	2	9,44	16,87	5,26	—	3,18	4071265

Indexable Milling • Shoulder Milling ISO Inserts • APPT-MM

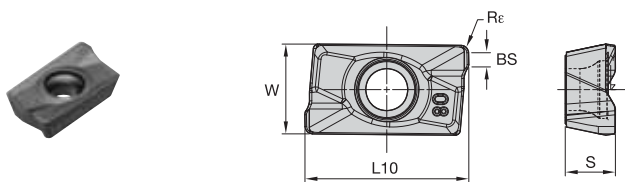

- first choice
- alternate choice

P	●
M	●
K	○
N	○
S	○
H	○

ISO catalogue number	cutting edges	L10	W	S	BS	R ϵ	hm	WU20PM
APPT100308PDSRMM	2	11,10	6,70	3,56	—	0,80	0,07	6820930
APPT160408PDSRMM	2	—	9,41	5,26	1,49	0,79	0,06	6443662

Indexable Milling • Copy Milling ISO Inserts • RDMX

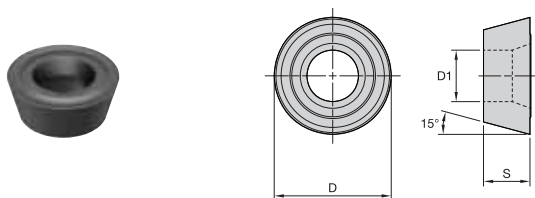

- first choice
- alternate choice

P	●
M	●
K	○
N	○
S	○
H	○

ISO catalogue number	cutting edges	D1	D	S	hm	WU20PM
RDMX10T3M0	1	4,40	10	3,97	0,05	2567081
RDMX1604M0T	1	5,50	16	4,76	0,06	4147744

Indexable Milling • Copy Milling ISO Inserts • RPMT

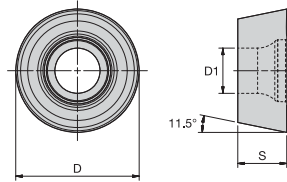

- first choice
- alternate choice

P	●
M	●
K	○
N	○
S	○
H	○

ISO catalogue number	cutting edges	D1	D	S	hm	WU20PM
RPMT1204M0	1	4,40	12	4,76	0,05	4144073

Indexable Milling • Copy Milling ISO Inserts • RPMW

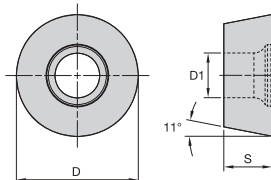

- first choice
- alternate choice

P	●
M	●
K	○
N	○
S	○
H	○

























ISO catalogue number	cutting edges	D1	D	S	hm	WU20PM
RPMW1003M0	1	4,60	10	3,18	0,05	3367756
RPMW1204M0	1	4,40	12	4,76	0,05	3350976



Solid End Milling

WIDIA Multi-Purpose End Mills	B4–B63
Selection Guide.....	B4–B15
WCE End Mill • 4 Flute	B16–B24
GP End Mills • 2 Flute, 3 Flute, and 4 Flute.....	B26–B54
NINA.....	B56–B63
Hanita High-Performance Solid Carbide End Mills	B68–B199
Selection Guide.....	B68–B83
VariMill XTREME	B84–B92
VariMill I.....	B94–B104
VariMill II.....	B106–B118
VariMill III ER.....	B120–B124
Roughers.....	B126–B138
Finishers.....	B140–B149
ALUFLASH.....	B150–B160
X-Feed	B162–B167
Vision Plus.....	B168–B192
HSS End Mills	B194–B199

Multi-Purpose End Mills • Selection Guide • Metric

	WIDIA Solid End Milling Portfolio					
	WCE4	WCE4	WCE4	WCE4	WCE4	WCE4
						
UOM	Metric	Metric	Metric	Metric	Metric	Metric
Series	W401	W401	W401	W401	W4N1	W411
Page	B18	B18	B19	B19	B20	B21
Flute	4	4	4	4	4	4
Diameter D1	3–20mm	3–20mm	3–20mm	3–20mm	3–20mm	6–20mm
Shank						
Length of Cut	Regular	Regular	Regular	Regular	Regular	Long
Corner Style						
Chamfer Size	–	–	0,40–0,50mm	0,40–0,50mm	–	0,40–0,50mm
Radius Sizes	–	–	–	–	0,2–3mm	–
Helix Angle	37° / 39°	37° / 39°	37° / 39°	37° / 39°	37° / 39°	37° / 39°
Center Cutting	Yes	Yes	Yes	Yes	Yes	Yes
Neck	No	No	No	No	Yes	No
Materials						

INDEXABLE MILLING

SOLID END MILLING





HOLEMAKING

TAPPING

TURNING

Multi-Purpose End Mills • Selection Guide • Metric



UOM	Metric	Metric
Series	W4NB	W4NB
Page	B21	B22
Flute	4	4
Diameter D1	5–20mm	5–20mm
Shank		
Length of Cut	Regular	Regular
Corner Style		
Chamfer Size	–	–
Radius Sizes	–	–
Helix Angle	38°	38°
Center Cutting	Yes	Yes
Neck	Yes	Yes
Materials	P M K S H	P M K S H

INDEXABLE MILLING

























SOLID END MILLING

HOLEMAKING

TAPPING

TURNING

Multi-Purpose End Mills • Selection Guide • Metric

WIDIA Solid End Milling Portfolio						
	GP	GP	GP	GP	GP	GP
						
UOM	Metric	Metric	Metric	Metric	Metric	Metric
Series	4002	4002	4012	4012	D002	D002
Page	B28–B29	B28–B29	B28–B29	B28–B29	B30	B30
Flute	2	2	2	2	2	2
Diameter D1	1–20mm	1–20mm	1–20mm	1–20mm	2–20mm	2–20mm
Shank						
Length of Cut	Regular	Regular	Long	Long	Regular	Regular
Corner Style						
Chamfer Size	–	0,1–0,3mm	–	0,1–0,3mm	–	0,1–0,3mm
Radius Sizes	–	–	–	–	–	–
Helix Angle	30°	30°	30°	30°	30°	30°
Center Cutting	Yes	Yes	Yes	Yes	Yes	Yes
Neck	No	No	No	No	No	No
Materials						

INDEXABLE MILLING





























SOLID END MILLING

HOLEMAKING





























TAPPING

TURNING

Multi-Purpose End Mills • Selection Guide • Metric

WIDIA Solid End Milling Portfolio							
	GP	GP	GP	GP	GP	GP	GP
							
UOM	Metric	Metric	Metric	Metric	Metric	Metric	Metric
Series	D002	D002	D002	D002	D002	D002	2819
Page	B30	B30	B30	B30	B30	B30	B31
Flute	2	2	2	2	2	2	2
Diameter D1	12–20mm	12–20mm	2,5–20mm	2,5–20mm	2,5–20mm	2,5–20mm	3–20mm
Shank							
Length of Cut	Regular	Regular	Regular	Regular	Regular	Regular	Regular
Corner Style							
Chamfer Size	–	0,1–0,3mm	–	0,1–0,3mm	–	0,1–0,3mm	–
Radius Sizes	–	–	–	–	–	–	–
Helix Angle	30°	30°	30°	30°	30°	30°	30°
Center Cutting	Yes	Yes	Yes	Yes	Yes	Yes	Yes
Neck	No	No	No	No	No	No	No
Materials							

Multi-Purpose End Mills • Selection Guide • Metric

WIDIA Solid End Milling Portfolio							
	GP	GP	GP	GP	GP	GP	GP
							
UOM	Metric	Metric	Metric	Metric	Metric	Metric	Metric
Series	2819	4001	4011	4021	D001	D011	2838
Page	B31	B32	B32	B32	B33	B33	B33
Flute	2	2	2	2	2	2	2
Diameter D1	3–20mm	1–20mm	1–20mm	1–20mm	2–20mm	3–20mm	2–16mm
Shank							
Length of Cut	Regular	Regular	Long	Extended	Regular	Long	Regular
Corner Style							
Chamfer Size	0,1–0,3mm	–	–	–	–	–	–
Radius Sizes	–	–	–	–	–	–	–
Helix Angle	30°	30°	30°	30°	30°	30°	30°
Center Cutting	Yes	Yes	Yes	Yes	Yes	Yes	Yes
Neck	No	No	No	No	No	No	No
Materials							

INDEXABLE MILLING





























SOLID END MILLING

HOLEMAKING

TAPPING

TURNING

Multi-Purpose End Mills • Selection Guide • Metric

WIDIA Solid End Milling Portfolio							
	GP	GP	GP	GP	GP	GP	GP
							
UOM	Metric	Metric	Metric	Metric	Metric	Metric	Metric
Series	4003..S	4003..S	4013..S	4013..S	4003	4003	4013
Page	B34	B34	B34	B34	B35	B35	B35
Flute	3	3	3	3	3	3	3
Diameter D1	1–20mm	6–16mm	3–20mm	3–20mm	4–16mm	6–16mm	4–20mm
Shank							
Length of Cut	Regular	Regular	Regular	Regular	Regular	Regular	Long
Corner Style							
Chamfer Size	–	–	–	–	–	–	–
Radius Sizes	–	–	–	–	–	–	–
Helix Angle	30°	30°	30°	30°	30°	30°	30°
Center Cutting	Yes	Yes	Yes	Yes	Yes	Yes	Yes
Neck	No	No	No	No	No	No	No
Materials							

INDEXABLE MILLING





























SOLID END MILLING

HOLEMAKING

TAPPING

TURNING

Multi-Purpose End Mills • Selection Guide • Metric

WIDIA Solid End Milling Portfolio							
	GP	GP	GP	GP	GP	GP	GP
							
UOM	Metric	Metric	Metric	Metric	Metric	Metric	Metric
Series	4013	D003..S	D003..S	D013..S	D013..S	D003	D003
Page	B35	B36	B36	B36	B36	B37	B37
Flute	3	3	3	3	3	3	3
Diameter D1	5–20mm	2–20mm	2–20mm	2–20mm	2–20mm	4–20mm	4–20mm
Shank							
Length of Cut	Long	Regular	Regular	Long	Long	Regular	Regular
Corner Style							
Chamfer Size	–	–	–	–	–	0,1–0,3mm	0,1–0,3mm
Radius Sizes	–	–	–	–	–	–	–
Helix Angle	30°	30°	30°	30°	30°	30°	30°
Center Cutting	Yes	Yes	Yes	Yes	Yes	Yes	Yes
Neck	No	No	No	No	No	No	No
Materials							

INDEXABLE MILLING





























SOLID END MILLING

HOLEMAKING

TAPPING

TURNING

Multi-Purpose End Mills • Selection Guide • Metric

WIDIA Solid End Milling Portfolio							
	GP	GP	GP	GP	GP	GP	GP
							
UOM	Metric	Metric	Metric	Metric	Metric	Metric	Metric
Series	D013	D013	4004	4004	4004	4014	4014
Page	B37	B37	B38-B39	B38-B39	B40	B40	B40
Flute	3	3	4	4	4	4	4
Diameter D1	4-20mm	4-20mm	1-20mm	1-20mm	2-20mm	3-20mm	3-20mm
Shank							
Length of Cut	Long	Long	Regular	Regular	Regular	Long	Long
Corner Style							
Chamfer Size	0,1-0,3mm	0,1-0,3mm	—	0,1-0,3mm	—	—	0,1-0,3mm
Radius Sizes	—	—	—	—	0,5-1mm	—	—
Helix Angle	30°	30°	30°	30°	30°	30°	30°
Center Cutting	Yes	Yes	Yes	Yes	Yes	Yes	Yes
Neck	No	No	No	No	No	No	No
Materials							

INDEXABLE MILLING





























SOLID END MILLING

HOLEMAKING

TAPPING

TURNING

Multi-Purpose End Mills • Selection Guide • Metric

WIDIA Solid End Milling Portfolio							
	GP	GP	GP	GP	GP	GP	GP
							
UOM	Metric	Metric	Metric	Metric	Metric	Metric	Metric
Series	4014	4024	4024	4024	D004	D004	D004
Page	B40	B40	B40	B40	B41-B42	B41-B42	B41-B42
Flute	4	4	4	4	4	4	4
Diameter D1	3-20mm	3-20mm	3-20mm	3-20mm	2-20mm	4-20mm	12-20mm
Shank							
Length of Cut	Long	Extended	Extended	Extended	Regular	Regular	Regular
Corner Style							
Chamfer Size	-	-	0,1-0,3mm	-	-	0,1-0,3mm	-
Radius Sizes	0,5-1mm	-	-	0,5-1mm	-	-	-
Helix Angle	30°	30°	30°	30°	30°	30°	30°
Center Cutting	Yes	Yes	Yes	Yes	Yes	Yes	Yes
Neck	No	No	No	No	No	No	No
Materials							

INDEXABLE MILLING





























SOLID END MILLING

HOLEMAKING

TAPPING

TURNING

Multi-Purpose End Mills • Selection Guide • Metric

WIDIA Solid End Milling Portfolio							
	GP	GP	GP	GP	GP	GP	GP
							
UOM	Metric	Metric	Metric	Metric	Metric	Metric	Metric
Series	D004	D014	D014	D014	D014	2528	2528
Page	B41-B42	B41-B42	B41-B42	B41-B42	B41-B42	B43	B43
Flute	4	4	4	4	4	4	4
Diameter D1	12-20mm	2-20mm	4-20mm	12-20mm	12-20mm	4-20mm	4-20mm
Shank							
Length of Cut	Regular	Long	Long	Long	Long	Regular	Regular
Corner Style							
Chamfer Size	0,1-0,3mm	-	0,1-0,3mm	-	0,1-0,3mm	-	0,1-0,3mm
Radius Sizes	-	-	-	-	-	-	-
Helix Angle	30°	30°	30°	30°	30°	30°	30°
Center Cutting	Yes	Yes	Yes	Yes	Yes	Yes	Yes
Neck	No	No	No	No	No	No	No
Materials							

INDEXABLE MILLING

















SOLID END MILLING

HOLEMAKING

TAPPING

TURNING

Multi-Purpose End Mills • Selection Guide • Metric

WIDIA Solid End Milling Portfolio				
	GP	GP	GP	GP
				
UOM	Metric	Metric	Metric	Metric
Series	4000	4010	D010	2848
Page	B44	B44	B45	B46
Flute	4	4	4	4
Diameter D1	2–20mm	3–20mm	3–20mm	4–20mm
Shank				
Length of Cut	Regular	Long	Regular	Regular
Corner Style				
Chamfer Size	–	–	–	–
Radius Sizes	–	–	–	–
Helix Angle	30°	30°	30°	30°
Center Cutting	Yes	Yes	Yes	Yes
Neck	No	No	No	No
Materials				

INDEXABLE MILLING









SOLID END MILLING

HOLEMAKING

TAPPING

TURNING

Multi-Purpose End Mills • Selection Guide • Metric

WIDIA Solid End Milling Portfolio					
	NINA™	NINA	NINA	NINA	NINA
					
UOM	Metric	Metric	Metric	Metric	Metric
Series	423002	423004	423048	423039	423036
Page	B58	B58	B59	B59	B60
Flute	3	4	2	2	4
Diameter D1	2–12mm	4–12mm	3–4mm	2–12mm	6–10mm
Shank					
Length of Cut	Regular	Regular	Regular	Regular	Regular
Corner Style					
Chamfer Size	—	0,4–0,5mm	—	—	—
Radius Sizes	—	—	0.5	—	—
Helix Angle	30°	30°	30°	30°	30°
Center Cutting	Yes	Yes	Yes	Yes	Yes
Neck	No	No	No	No	No
Materials					

INDEXABLE MILLING

SOLID END MILLING

HOLEMAKING

TAPPING

TURNING

WCE End Mill

Versatile Solid Carbide End Mills • Roughing/Finishing

The WCE solid end milling line features an advanced geometry to enable material versatility for end users seeking a cost-effective solution while machining small batches.



WCE4, 4-flute geometry combines the asymmetrical index and variable helix features at an affordable price while ensuring material and application versatility, including demanding operations like full slots and heavy cuts.

VERSATILE

Designed for use on multiple materials, including steel, stainless steel, and cast iron.

RELIABLE

Advanced design, coating, and geometry — including asymmetrical index and variable helix — combined to improve performance and offer consistent tool life.

AFFORDABLE

Attractively priced for small-to-medium shops that change machine setup often and need to know they can count on the tool without worrying about specific geometries or grades.

AFFORDABLE PERFORMANCE

PRODUCT

GRADE

WU20PD

FLUTES

4

DIAMETER RANGE

3–20mm

CORNER CONDITIONS

Sharp Edges
Chamfered
Radiused
Ball Nose

INDUSTRY



MATERIALS

FIRST CHOICE



SECOND CHOICE



APPLICATIONS



SIDE/
SHOULDER
MILLING
ROUGHING



SLOTTING
SQUARE
END



HELICAL
MILLING



RAMPING
BLANK



PLUNGE
MILLING



3D
PROFILING

VARIABLE HELIX

to reduce vibrations and
increase overall cutting stability.

ECCENTRIC RELIEF

to provide vibration dampening and
increase tool life on stainless steels.

CORE TAPER

for improved chip evacuation
and tool stability.



WCE4 • Series W401 • Sharp Edge • 4 Flute • Cylindrical Shank • Metric

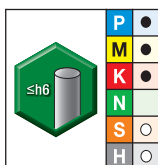
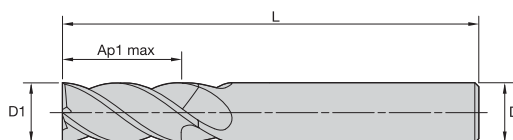

● first choice
○ alternate choice

WU20PE

order #	catalogue #	D1	D	length of cut Ap1 max	length L	Z U
6945502	W401M03003SZT	3,0	6	8,00	57	4
6945503	W401M04003SZT	4,0	6	11,00	57	4
6945504	W401M05003SZT	5,0	6	13,00	57	4
6945505	W401M06003SZT	6,0	6	13,00	57	4
6945548	W401M08004SZT	8,0	8	19,00	63	4
6945549	W401M10005SZT	10,0	10	22,00	72	4
6945684	W401M12006SZT	12,0	12	26,00	83	4
6945685	W401M16008SZT	16,0	16	32,00	92	4
6945686	W401M20009SZT	20,0	20	38,00	104	4

WCE4 • Series W401 • Sharp Edge • 4 Flute • Weldon® Shank • Metric

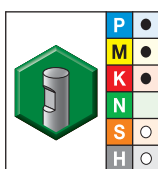
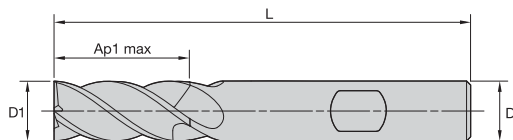

● first choice
○ alternate choice

WU20PE

order #	catalogue #	D1	D	length of cut Ap1 max	length L	Z U
6945510	W401M03003SZW	3,0	6	8,00	57	4
6945541	W401M04003SZW	4,0	6	11,00	57	4
6945542	W401M05003SZW	5,0	6	13,00	57	4
6945543	W401M06003SZW	6,0	6	13,00	57	4
6945562	W401M08004SZW	8,0	8	19,00	63	4
6945563	W401M10005SZW	10,0	10	22,00	72	4
6945690	W401M12006SZW	12,0	12	26,00	83	4
6945691	W401M16008SZW	16,0	16	32,00	92	4
6945692	W401M20009SZW	20,0	20	38,00	104	4

WCE4 • Series W401 • Chamfered • 4 Flute • Cylindrical Shank • Metric

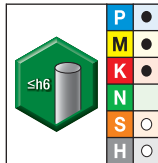
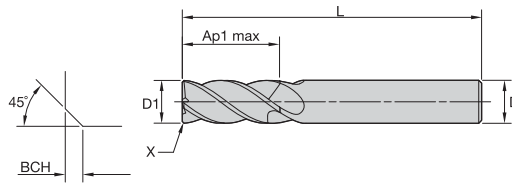

WU20PE

● first choice
○ alternate choice

order #	catalogue #	D1	D	length of cut Ap1 max	length L	BCH	Z U
6945506	W401M03003CAT	3,0	6	8,00	57	0,20	4
6945507	W401M04003CAT	4,0	6	11,00	57	0,20	4
6945508	W401M05003CAT	5,0	6	13,00	57	0,30	4
6945509	W401M06003CAT	6,0	6	13,00	57	0,40	4
6945550	W401M08004CAT	8,0	8	19,00	63	0,40	4
6945561	W401M10005CET	10,0	10	22,00	72	0,50	4
6945687	W401M12006CET	12,0	12	26,00	83	0,50	4
6945688	W401M16008CET	16,0	16	32,00	92	0,50	4
6945689	W401M20009CET	20,0	20	38,00	104	0,50	4

WCE4 • Series W401 • Chamfered • 4 Flute • Weldon® Shank • Metric

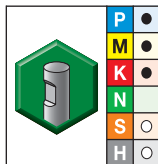
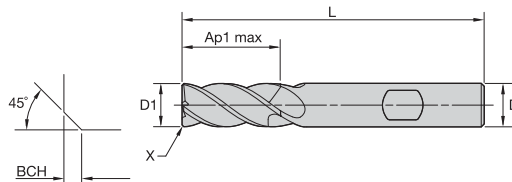

WU20PE

● first choice
○ alternate choice

order #	catalogue #	D1	D	length of cut Ap1 max	length L	BCH	Z U
6945544	W401M03003CAW	3,0	6	8,00	57	0,20	4
6945545	W401M04003CAW	4,0	6	11,00	57	0,20	4
6945546	W401M05003CAW	5,0	6	13,00	57	0,30	4
6945547	W401M06003CAW	6,0	6	13,00	57	0,40	4
6945564	W401M08004CAW	8,0	8	19,00	63	0,40	4
6945565	W401M10005CEW	10,0	10	22,00	72	0,50	4
6945693	W401M12006CEW	12,0	12	26,00	83	0,50	4
6945694	W401M16008CEW	16,0	16	32,00	92	0,50	4
6945695	W401M20009CEW	20,0	20	38,00	104	0,50	4

WCE4 • Series W4N1 • Radiused • 4 Flute • Necked • Cylindrical Shank • Metric

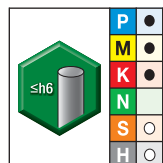
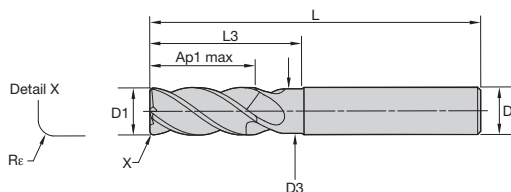

● first choice
○ alternate choice

WU20PE

order #	catalogue #	D1	D	D3	length of cut Ap1 max	length L	L3	Re	Z U
6945620	W4N1M03003RAT	3,0	6	2,82	8,00	57	15,00	0,20	4
6945631	W4N1M04003RAT	4,0	6	3,76	11,00	57	16,00	0,20	4
6945632	W4N1M04003RET	4,0	6	3,76	11,00	57	16,00	0,50	4
6945633	W4N1M05003RAT	5,0	6	4,70	13,00	57	18,00	0,20	4
6945634	W4N1M05003RET	5,0	6	4,70	13,00	57	18,00	0,50	4
6945635	W4N1M05003RJT	5,0	6	4,70	13,00	57	18,00	1,00	4
6945636	W4N1M06003RET	6,0	6	5,64	13,00	57	21,00	0,50	4
6945638	W4N1M06003RHT	6,0	6	5,64	13,00	57	21,00	1,50	4
6945637	W4N1M06003RJT	6,0	6	5,64	13,00	57	21,00	1,00	4
6945640	W4N1M08004RET	8,0	8	7,52	19,00	63	27,00	0,50	4
6945642	W4N1M08004RHT	8,0	8	7,52	19,00	63	27,00	1,50	4
6945641	W4N1M08004RJT	8,0	8	7,52	19,00	63	27,00	1,00	4
6945643	W4N1M08004RKT	8,0	8	7,52	19,00	63	27,00	2,00	4
6945644	W4N1M10005RET	10,0	10	9,40	22,00	72	32,00	0,50	4
6945646	W4N1M10005RHT	10,0	10	9,40	22,00	72	32,00	1,50	4
6945645	W4N1M10005RJT	10,0	10	9,40	22,00	72	32,00	1,00	4
6945647	W4N1M10005RKT	10,0	10	9,40	22,00	72	32,00	2,00	4
6945128	W4N1M12006RET	12,0	12	11,28	26,00	83	38,00	0,50	4
6945130	W4N1M12006RHT	12,0	12	11,28	26,00	83	38,00	1,50	4
6945129	W4N1M12006RJT	12,0	12	11,28	26,00	83	38,00	1,00	4
6945481	W4N1M12006RKT	12,0	12	11,28	26,00	83	38,00	2,00	4
6945482	W4N1M12006RQT	12,0	12	11,28	26,00	83	38,00	4,00	4
6945483	W4N1M16008RJT	16,0	16	15,04	32,00	92	44,00	1,00	4
6945484	W4N1M16008RKT	16,0	16	15,04	32,00	92	44,00	2,00	4
6945485	W4N1M16008RPT	16,0	16	15,04	32,00	92	44,00	3,00	4
6945486	W4N1M16008RQT	16,0	16	15,04	32,00	92	44,00	4,00	4
6945487	W4N1M20009RJT	20,0	20	18,80	38,00	104	53,00	1,00	4
6945488	W4N1M20009RKT	20,0	20	18,80	38,00	104	53,00	2,00	4
6945489	W4N1M20009RPT	20,0	20	18,80	38,00	104	53,00	3,00	4
6945490	W4N1M20009RQT	20,0	20	18,80	38,00	104	53,00	4,00	4

INDEXABLE MILLING

SOLID END MILLING

HOLEMAKING

TAPPING

TURNING

WCE4 • Series W411 • Chamfered • 4 Flute • Long Length • Cylindrical Shank • Metric

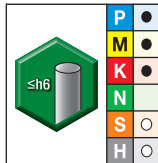
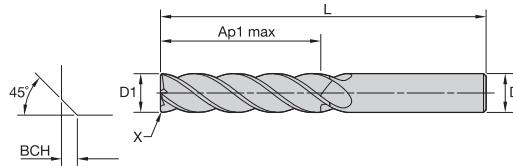

WU20PE

● first choice
○ alternate choice

order #	catalogue #	D1	D	length of cut Ap1 max	length L	BCH	Z U
6946013	W411M06013CAT	6,0	6	32,00	76	0,40	4
6946014	W411M08014CAT	8,0	8	32,00	87	0,40	4
6946015	W411M10015CET	10,0	10	38,00	89	0,50	4
6946046	W411M12016CET	12,0	12	51,00	100	0,50	4
6946047	W411M16018CET	16,0	16	57,00	125	0,50	4
6946048	W411M20019CET	20,0	20	57,00	125	0,50	4

WCE4 • Series W4NB • Ball Nose • 4 Flute • Cylindrical Shank • Metric

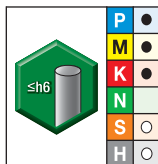
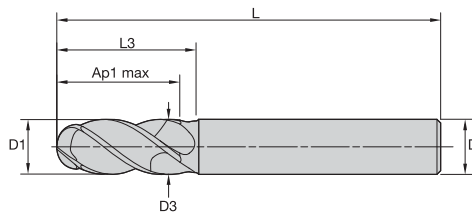

WU20PE

● first choice
○ alternate choice

order #	catalogue #	D1	D	D3	length of cut Ap1 max	length L	L3	Z U
6945882	W4NBM05003RBT	5,0	6	4,70	13,00	57	18,00	4
6945883	W4NBM06003RBT	6,0	6	5,64	13,00	57	21,00	4
6945886	W4NBM08004RBT	8,0	8	7,52	19,00	63	27,00	4
6945887	W4NBM10005RBT	10,0	10	9,40	22,00	72	32,00	4
6945895	W4NBM12006RBT	12,0	12	11,28	26,00	83	30,00	4
6945896	W4NBM16008RBT	16,0	16	15,04	32,00	92	38,00	4
6945897	W4NBM20009RBT	20,0	20	18,80	38,00	104	50,00	4

WCE4 • Series W4NB • Ball Nose • 4 Flute • Weldon® Shank • Metric

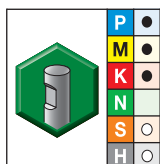
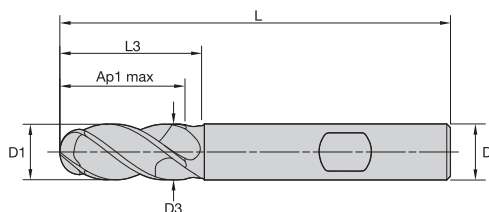

WU20PE

● first choice
○ alternate choice

order #	catalogue #	D1	D	D3	length of cut Ap1 max	length L	L3	Z U
6945884	W4NBM05003RBW	5,0	6	4,70	13,00	57	18,00	4
6945885	W4NBM06003RBW	6,0	6	5,64	13,00	57	21,00	4
6945888	W4NBM08004RBW	8,0	8	7,52	19,00	63	27,00	4
6945889	W4NBM10005RBW	10,0	10	9,40	22,00	72	32,00	4
6945898	W4NBM12006RBW	12,0	12	11,28	26,00	83	30,00	4
6945899	W4NBM16008RBW	16,0	16	15,04	32,00	92	38,00	4
6945900	W4NBM20009RBW	20,0	20	18,80	38,00	104	50,00	4

INDEXABLE MILLING



SOLID END MILLING

HOLEMAKING



TAPPING

TURNING

Application Data • WCE Side Milling • Slotting • Metric

Material Group																				
	Side Milling		Slotting		WU20PE			Recommended feed per tooth (fz = mm/th) for side milling (A). For slotting (B), reduce fz by 20%.												
					Cutting Speed – Vc m/min			D1 – Diameter												
	ap	ae	ap	min	Start	max	mm	3,0	4,0	5,0	6,0	8,0	10,0	12,0	14,0	16,0	18,0	20,0	25,0	
P	0	ap1max	0,4 x D1	1,0 x D1	150	175	200	fz	0,021	0,028	0,036	0,044	0,060	0,072	0,083	0,092	0,101	0,108	0,114	0,124
	1	ap1max	0,4 x D1	1,0 x D1	150	175	200	fz	0,021	0,028	0,036	0,044	0,060	0,072	0,083	0,092	0,101	0,108	0,114	0,124
	2	ap1max	0,4 x D1	1,0 x D1	140	165	190	fz	0,021	0,028	0,036	0,044	0,060	0,072	0,083	0,092	0,101	0,108	0,114	0,124
	3	ap1max	0,4 x D1	1,0 x D1	120	140	160	fz	0,017	0,023	0,030	0,036	0,050	0,061	0,070	0,079	0,087	0,095	0,101	0,114
	4	ap1max	0,4 x D1	0,75 x D1	90	120	150	fz	0,016	0,021	0,027	0,033	0,045	0,054	0,062	0,070	0,077	0,083	0,088	0,098
	5	ap1max	0,4 x D1	1,0 x D1	60	80	100	fz	0,014	0,019	0,024	0,029	0,040	0,048	0,056	0,063	0,070	0,076	0,081	0,091
M	1	ap1max	0,4 x D1	1,0 x D1	90	100	115	fz	0,017	0,023	0,030	0,036	0,050	0,061	0,070	0,079	0,087	0,095	0,101	0,114
	2	ap1max	0,4 x D1	1,0 x D1	60	70	80	fz	0,014	0,019	0,024	0,029	0,040	0,048	0,056	0,063	0,070	0,076	0,081	0,091
	3	ap1max	0,4 x D1	1,0 x D1	60	65	70	fz	0,012	0,016	0,020	0,025	0,034	0,040	0,047	0,052	0,057	0,061	0,065	0,071
K	1	ap1max	0,4 x D1	1,0 x D1	120	135	150	fz	0,021	0,028	0,036	0,044	0,060	0,072	0,083	0,092	0,101	0,108	0,114	0,124
	2	ap1max	0,4 x D1	1,0 x D1	110	125	140	fz	0,017	0,023	0,030	0,036	0,050	0,061	0,070	0,079	0,087	0,095	0,101	0,114
	3	ap1max	0,4 x D1	1,0 x D1	110	120	130	fz	0,014	0,019	0,024	0,029	0,040	0,048	0,056	0,063	0,070	0,076	0,081	0,091
S	1	ap1max	0,4 x D1	0,3 x D1	50	70	90	fz	0,017	0,023	0,030	0,036	0,050	0,061	0,070	0,079	0,087	0,095	0,101	0,114
	2	ap1max	0,4 x D1	0,3 x D1	25	30	40	fz	0,009	0,013	0,016	0,019	0,026	0,032	0,037	0,042	0,046	0,050	0,054	0,061
	3	ap1max	0,4 x D1	1,0 x D1	25	30	40	fz	0,009	0,013	0,016	0,019	0,026	0,032	0,037	0,042	0,046	0,050	0,054	0,061
	4	ap1max	0,4 x D1	1,0 x D1	50	55	60	fz	0,011	0,016	0,021	0,026	0,037	0,045	0,052	0,058	0,064	0,069	0,074	0,084
H	1	ap1max	0,4 x D1	0,75 x D1	80	110	140	fz	0,016	0,021	0,027	0,033	0,045	0,054	0,062	0,070	0,077	0,083	0,088	0,098
	2	ap1max	0,4 x D1	0,5 x D1	70	90	120	fz	0,012	0,016	0,020	0,025	0,034	0,040	0,047	0,052	0,057	0,061	0,065	0,071

Application Data • WCE Side Milling • Slotting BN • Metric

Material Group																				
	Side Milling		Slotting		WU20PE			Recommended feed per tooth (fz = mm/th) for side milling (A). For slotting (B), reduce fz by 20%.												
					Cutting Speed – Vc m/min			D1 – Diameter												
	ap	ae	ap	min	Start	max	mm	3,0	4,0	5,0	6,0	8,0	10,0	12,0	14,0	16,0	18,0	20,0	25,0	
P	0	ap1max	0,4 x D1	1,0 x D1	150	175	200	fz	0,021	0,028	0,036	0,044	0,060	0,072	0,083	0,092	0,101	0,108	0,114	0,124
	1	ap1max	0,4 x D1	1,0 x D1	150	175	200	fz	0,021	0,028	0,036	0,044	0,060	0,072	0,083	0,092	0,101	0,108	0,114	0,124
	2	ap1max	0,4 x D1	1,0 x D1	140	165	190	fz	0,021	0,028	0,036	0,044	0,060	0,072	0,083	0,092	0,101	0,108	0,114	0,124
	3	ap1max	0,4 x D1	1,0 x D1	120	140	160	fz	0,017	0,023	0,030	0,036	0,050	0,061	0,070	0,079	0,087	0,095	0,101	0,114
	4	ap1max	0,4 x D1	0,75 x D1	90	120	150	fz	0,016	0,021	0,027	0,033	0,045	0,054	0,062	0,070	0,077	0,083	0,088	0,098
	5	ap1max	0,4 x D1	1,0 x D1	60	80	100	fz	0,014	0,019	0,024	0,029	0,040	0,048	0,056	0,063	0,070	0,076	0,081	0,091
M	1	ap1max	0,4 x D1	1,0 x D1	90	100	115	fz	0,017	0,023	0,030	0,036	0,050	0,061	0,070	0,079	0,087	0,095	0,101	0,114
	2	ap1max	0,4 x D1	1,0 x D1	60	70	80	fz	0,014	0,019	0,024	0,029	0,040	0,048	0,056	0,063	0,070	0,076	0,081	0,091
	3	ap1max	0,4 x D1	1,0 x D1	60	65	70	fz	0,012	0,016	0,020	0,025	0,034	0,040	0,047	0,052	0,057	0,061	0,065	0,071
K	1	ap1max	0,4 x D1	1,0 x D1	120	135	150	fz	0,021	0,028	0,036	0,044	0,060	0,072	0,083	0,092	0,101	0,108	0,114	0,124
	2	ap1max	0,4 x D1	1,0 x D1	110	125	140	fz	0,017	0,023	0,030	0,036	0,050	0,061	0,070	0,079	0,087	0,095	0,101	0,114
	3	ap1max	0,4 x D1	1,0 x D1	110	120	130	fz	0,014	0,019	0,024	0,029	0,040	0,048	0,056	0,063	0,070	0,076	0,081	0,091
S	1	ap1max	0,4 x D1	0,3 x D1	50	70	90	fz	0,017	0,023	0,030	0,036	0,050	0,061	0,070	0,079	0,087	0,095	0,101	0,114
	2	ap1max	0,4 x D1	0,3 x D1	25	30	40	fz	0,009	0,013	0,016	0,019	0,026	0,032	0,037	0,042	0,046	0,050	0,054	0,061
	3	ap1max	0,4 x D1	1,0 x D1	25	30	40	fz	0,009	0,013	0,016	0,019	0,026	0,032	0,037	0,042	0,046	0,050	0,054	0,061
	4	ap1max	0,4 x D1	1,0 x D1	50	55	60	fz	0,011	0,016	0,021	0,026	0,037	0,045	0,052	0,058	0,064	0,069	0,074	0,084
H	1	ap1max	0,4 x D1	0,75 x D1	80	110	140	fz	0,016	0,021	0,027	0,033	0,045	0,054	0,062	0,070	0,077	0,083	0,088	0,098
	2	ap1max	0,4 x D1	0,5 x D1	70	90	120	fz	0,012	0,016	0,020	0,025	0,034	0,040	0,047	0,052	0,057	0,061	0,065	0,071

Application Data • WCE Side Milling • Long • Metric

Material Group	Side Milling		Recommended feed per tooth (fz = mm/z) for side milling. No Slotting operations recommended.																	
			WU20PE			D1 – Diameter														
			Cutting Speed – Vc m/min			mm														
			ap	ae	min		Start	max	3,0	4,0	5,0	6,0	8,0	10,0	12,0	14,0	16,0	18,0	20,0	25,0
P	0	ap1max	0,2xD1	150	175	200	fz	0,021	0,028	0,036	0,044	0,060	0,072	0,083	0,092	0,101	0,108	0,114	0,124	
	1	ap1max	0,2xD1	150	175	200	fz	0,021	0,028	0,036	0,044	0,060	0,072	0,083	0,092	0,101	0,108	0,114	0,124	
	2	ap1max	0,2xD1	140	165	190	fz	0,021	0,028	0,036	0,044	0,060	0,072	0,083	0,092	0,101	0,108	0,114	0,124	
	3	ap1max	0,2xD1	120	140	160	fz	0,017	0,023	0,030	0,036	0,050	0,061	0,070	0,079	0,087	0,095	0,101	0,114	
	4	ap1max	0,2xD1	90	120	150	fz	0,016	0,021	0,027	0,033	0,045	0,054	0,062	0,070	0,077	0,083	0,088	0,098	
	5	ap1max	0,2xD1	60	80	100	fz	0,014	0,019	0,024	0,029	0,040	0,048	0,056	0,063	0,070	0,076	0,081	0,091	
M	6	ap1max	0,15xD1	50	65	75	fz	0,012	0,016	0,020	0,025	0,034	0,040	0,047	0,052	0,057	0,061	0,065	0,071	
	1	ap1max	0,2xD1	90	100	115	fz	0,017	0,023	0,030	0,036	0,050	0,061	0,070	0,079	0,087	0,095	0,101	0,114	
	2	ap1max	0,2xD1	60	70	80	fz	0,014	0,019	0,024	0,029	0,040	0,048	0,056	0,063	0,070	0,076	0,081	0,091	
K	3	ap1max	0,2xD1	60	65	70	fz	0,012	0,016	0,020	0,025	0,034	0,040	0,047	0,052	0,057	0,061	0,065	0,071	
	1	ap1max	0,2xD1	120	135	150	fz	0,021	0,028	0,036	0,044	0,060	0,072	0,083	0,092	0,101	0,108	0,114	0,124	
	2	ap1max	0,2xD1	110	125	140	fz	0,017	0,023	0,030	0,036	0,050	0,061	0,070	0,079	0,087	0,095	0,101	0,114	
S	3	ap1max	0,2xD1	110	120	130	fz	0,014	0,019	0,024	0,029	0,040	0,048	0,056	0,063	0,070	0,076	0,081	0,091	
	1	ap1max	0,1xD1	50	70	90	fz	0,017	0,023	0,030	0,036	0,050	0,061	0,070	0,079	0,087	0,095	0,101	0,114	
	2	ap1max	0,1xD1	25	30	40	fz	0,009	0,013	0,016	0,019	0,026	0,032	0,037	0,042	0,046	0,050	0,054	0,061	
	3	ap1max	0,15xD1	25	30	40	fz	0,009	0,013	0,016	0,019	0,026	0,032	0,037	0,042	0,046	0,050	0,054	0,061	
H	4	ap1max	0,15xD1	50	55	60	fz	0,011	0,016	0,021	0,026	0,037	0,045	0,052	0,058	0,064	0,069	0,074	0,084	
	1	ap1max	0,15xD1	80	110	140	fz	0,016	0,021	0,027	0,033	0,045	0,054	0,062	0,070	0,077	0,083	0,088	0,098	
H	2	ap1max	0,15xD1	70	90	120	fz	0,012	0,016	0,020	0,025	0,034	0,040	0,047	0,052	0,057	0,061	0,065	0,071	

WCE • Adjustment Factor Table for Feed Calculation

To calculate application-specific cutting data, please use Kv coefficient table to the right for adaptation of cutting speed and KFz for feed, respectively.

$$Vc_{new} = Vc \cdot Kv$$

$$Fz_{new} = IPT \cdot KFz$$

Calculation example:

Application: D = 20mm; M2 material group;
Ae = 2mm
Cutting data recommendation: Vc = 80 m/min;
Fz = 0,089 mm/th
Adjustment coefficients: Ae = 2mm equals 10,0%;
Kv = 1,35; KFz = 1,7

Final cutting data recommendation:

$$Vc_{new} = 80 \cdot 1,35 = 108 \text{ m/min}$$

$$Fz_{new} = 0,089 \cdot 1,7 = 0,15 \text{ mm/min}$$

Metric

	Ae/D	2%	4%	5%	8%	10%	20%	30%	40%	50%
Speed factor	Kv	2	1,5	1,45	1,4	1,35	1,25	1,2	1	1
Feed factor	KFz	2,4	2,3	2,2	2	1,7	1,25	1,02	1	1



GP End Mills

General-Purpose Solid Carbide End Mills

The GP solid end milling line is a group of highly versatile end mills created for small shop customers to manage inventory effectively by reducing the initial tooling investment and increasing the value to recondition.

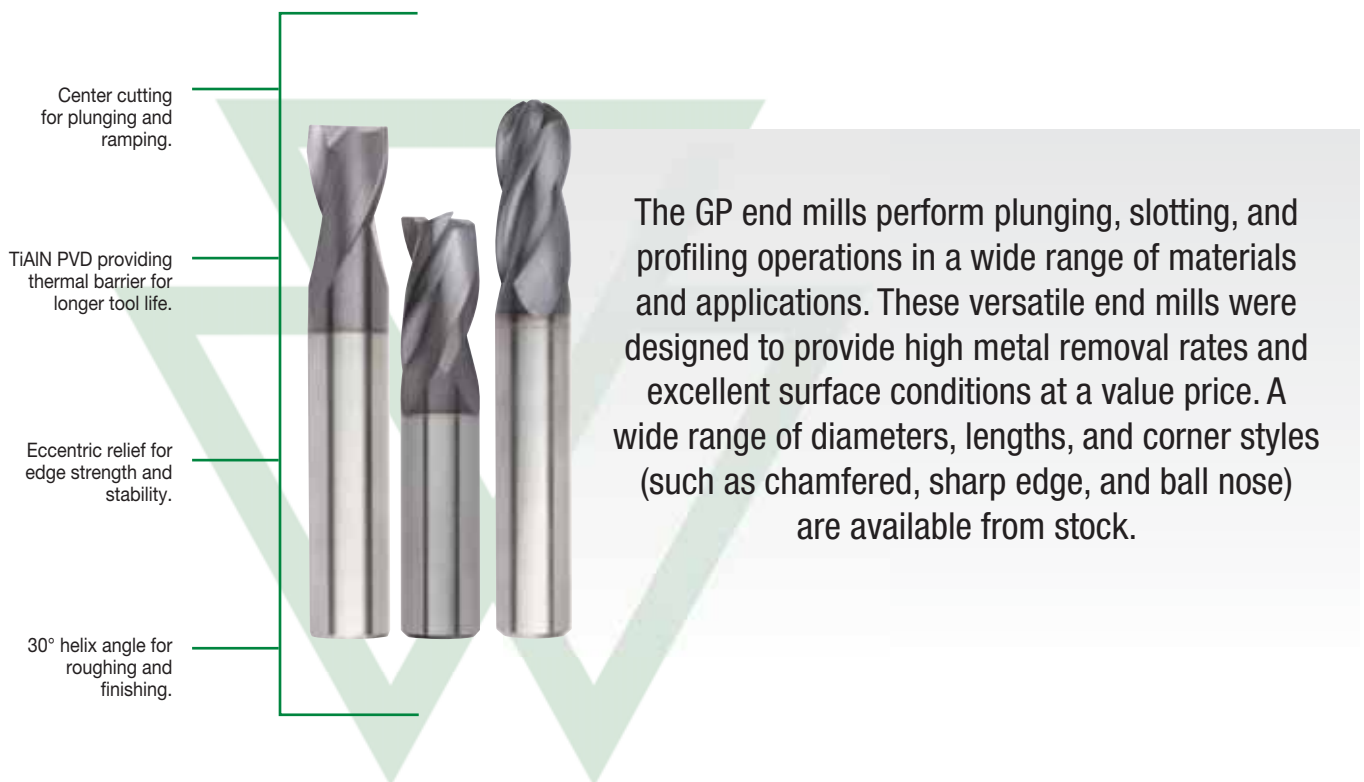

VERSATILE

One design and grade to machine a wide range of materials.

RELIABLE

Mid-level performance and productivity in all machine conditions, including unstable setups.

VALUABLE

Low initial investment with simple regrind capability.

VALUABLE VERSATILITY

PRODUCT

GRADE

TiAIN, UNCOATED

FLUTES

2-4

DIAMETER RANGE

1-20mm

CORNER CONDITIONS

Sharp Edges
Chamfered
Radiused
Ball Nose

INDUSTRY



MATERIALS

FIRST CHOICE



APPLICATIONS



SIDE/
SHOULDER
MILLING
ROUGHING



SLOTING
SQUARE
END



HELICAL
MILLING



RAMPING
BLANK



3D
PROFILING

ECCENTRIC RELIEF

for edge strength and stability.

30° HELIX ANGLE

for high versatility.

CYLINDRICAL AND WELDON® SHANK

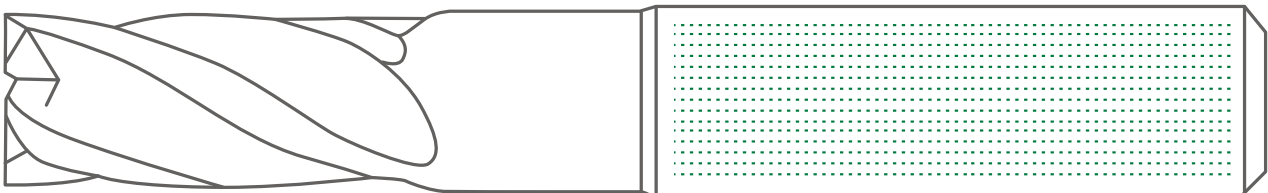

General-Purpose Solid Carbide End Mills

GP End Mills • Series 4002 4012 • Square End • 2 Flute • Metric

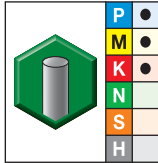
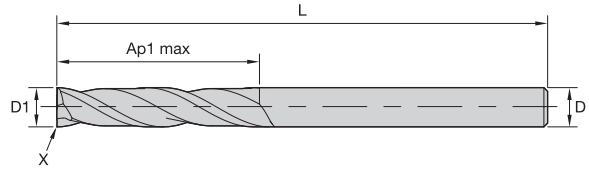
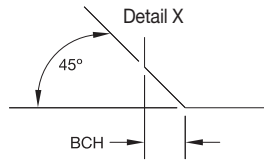

● first choice
○ alternate choice

TiAlN		D1	D	length of cut Ap1 max	length L	BCH	Z U
5873484	40020100T004	1,0	3	4,00	38	—	2
5873485	40020150T004	1,5	3	4,00	38	—	2
5873486	40020180T004	1,8	3	4,00	38	—	2
5873487	40020200T006	2,0	3	6,30	38	—	2
5873488	40020250T006	2,5	3	6,30	38	—	2
5873489	40020300T009	3,0	3	9,50	38	—	2
5873490	40020300T019	3,0	3	19,00	63	—	2
5873491	40120300T025	3,0	3	25,00	75	—	2
5873492	40020350T012	3,5	4	12,00	54	—	2
5873493	40020400T012	4,0	4	12,00	50	0,10	2
6092621	40020400T012S	4,0	4	12,00	50	—	2
5873494	40020400T019	4,0	4	19,00	63	0,10	2
6092622	40020400T019S	4,0	4	19,00	63	—	2
6092623	40120400T031S	4,0	4	31,00	75	—	2
5873495	40120400T031	4,0	4	31,00	75	0,10	2
6092624	40020450T014S	4,5	6	14,00	50	—	2
5873496	40020450T014	4,5	6	14,00	50	0,10	2
5873498	40020500T014	5,0	5	14,00	50	0,10	2
6092627	40020500T014S	5,0	5	14,00	50	—	2
5873499	40020500T020	5,0	5	20,00	63	0,10	2
6092628	40020500T020S	5,0	5	20,00	63	—	2
6092631	40120500T031S	5,0	5	31,00	100	—	2
5873500	40120500T031	5,0	5	31,00	100	0,10	2
5873501	40020550T014	5,5	6	14,00	50	0,10	2
6092632	40020550T014S	5,5	6	14,00	50	—	2
6092633	40020600T016S	6,0	6	16,00	50	—	2
5873502	40020600T016	6,0	6	16,00	50	0,10	2
5873503	40020600T028	6,0	6	28,00	76	0,10	2
6092634	40020600T028S	6,0	6	28,00	76	—	2
6092636	40120600T038S	6,0	6	38,00	100	—	2
5873504	40120600T038	6,0	6	38,00	100	0,10	2
5873505	40020700T020	7,0	7	20,00	63	0,10	2
6092637	40020700T020S	7,0	7	20,00	63	—	2
5873506	40020800T020	8,0	8	20,00	63	0,20	2
6092638	40020800T020S	8,0	8	20,00	63	—	2
6092639	40020800T028S	8,0	8	28,00	76	—	2
5873507	40020800T028	8,0	8	28,00	76	0,20	2
6092640	40120800T041S	8,0	8	41,00	100	—	2
5873508	40120800T041	8,0	8	41,00	100	0,20	2
5873509	40020900T020	9,0	9	20,00	63	0,20	2
6092641	40020900T020S	9,0	9	20,00	63	—	2
5873510	40021000T022	10,0	10	22,00	72	0,20	2
6092643	40021000T022S	10,0	10	22,00	72	—	2
6092644	40021000T032S	10,0	10	32,00	89	—	2
5873511	40021000T032	10,0	10	32,00	89	0,20	2
6092645	40121000T045S	10,0	10	45,00	100	—	2
5873512	40121000T045	10,0	10	45,00	100	0,20	2
6092646	40021100T025S	11,0	11	25,00	76	—	2
5873513	40021100T025	11,0	11	25,00	76	0,30	2
5873514	40021200T025	12,0	12	25,00	76	0,30	2
6092647	40021200T025S	12,0	12	25,00	76	—	2
5873515	40021200T045	12,0	12	45,00	100	0,30	2
6092648	40021200T045S	12,0	12	45,00	100	—	2
6092650	40121200T075S	12,0	12	75,00	150	—	2
5873516	40121200T075	12,0	12	75,00	150	0,30	2
6092651	40021400T032S	14,0	14	32,00	83	—	2

GP End Mills • Series 4002 4012 • Square End • 2 Flute • Metric

(continued)

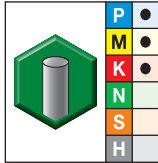
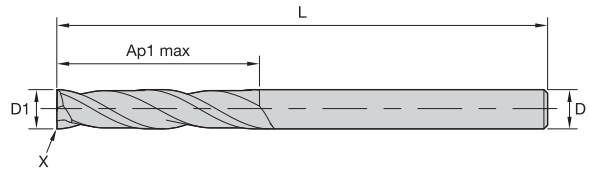
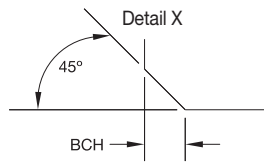

- first choice
- alternate choice

TiAlN		D1	D	length of cut Ap1 max	length L	BCH	Z U
order #	catalogue #						
5873517	40021400T032	14,0	14	32,00	83	0,30	2
6092653	40021400T050S	14,0	14	50,00	100	—	2
5873518	40021400T050	14,0	14	50,00	100	0,30	2
6092654	40121400T075S	14,0	14	75,00	150	—	2
5873519	40121400T075	14,0	14	75,00	150	0,30	2
5873520	40021600T032	16,0	16	32,00	89	0,30	2
6092657	40021600T032S	16,0	16	32,00	89	—	2
6092658	40021600T056S	16,0	16	56,00	110	—	2
5873531	40021600T056	16,0	16	56,00	110	0,30	2
6092659	40121600T075S	16,0	16	75,00	150	—	2
5873532	40121600T075	16,0	16	75,00	150	0,30	2
5873533	40021800T038	18,0	18	38,00	100	0,30	2
6092660	40021800T038S	18,0	18	38,00	100	—	2
5873536	40022000T038	20,0	20	38,00	104	0,30	2
6092683	40022000T038S	20,0	20	38,00	104	—	2
5873537	40022000T056	20,0	20	56,00	125	0,30	2
6092684	40022000T056S	20,0	20	56,00	125	—	2
6092685	40122000T075S	20,0	20	75,00	150	—	2
5873538	40122000T075	20,0	20	75,00	150	0,30	2

NOTE: For application data, please see pages B47–B49.

General-Purpose Solid Carbide End Mills

GP End Mills • Series D002 D012 • Square End • 2 Flute • Metric

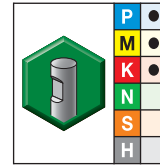
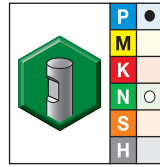
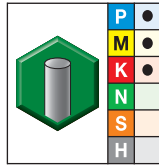
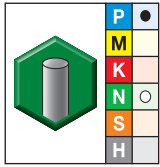
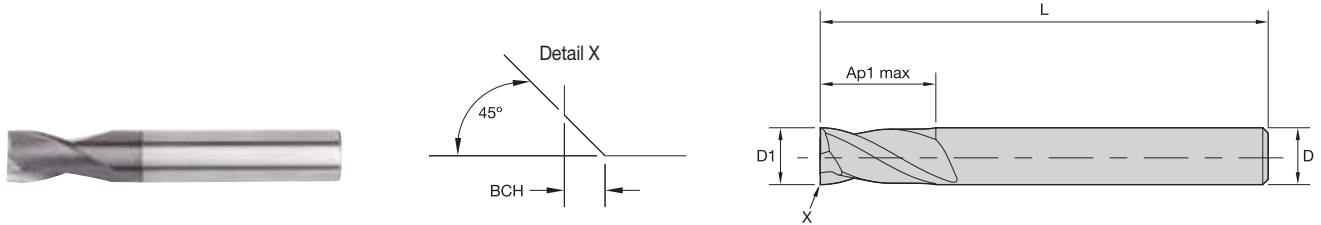

- first choice
- alternate choice

UNCOATED		TiAlN		UNCOATED		TiAlN		D1	D	length of cut Ap1 max	length L	BCH	Z U
order #	catalogue #	order #	catalogue #	order #	catalogue #	order #	catalogue #						
5877567	D0020200T003	5877330	D0020200T003	—	—	—	—	2,0	6	3,00	50	—	2
—	—	5877501	D0020250T003	—	—	—	—	2,5	6	3,00	50	—	2
5877569	D0120250T007	5877502	D0120250T007	—	—	—	—	2,5	6	7,00	57	—	2
5877571	D0020300T004	5877503	D0020300T004	—	—	—	—	3,0	6	4,00	50	—	2
5877572	D0120300T007	5877504	D0120300T007	—	—	—	—	3,0	6	7,00	57	—	2
5877573	D0020350T004	5877505	D0020350T004	—	—	—	—	3,5	6	4,00	50	—	2
—	—	5877506	D0020400T005	—	—	—	—	4,0	6	5,00	54	0,10	2
—	—	6092298	D0020400T005S	—	—	—	—	4,0	6	5,00	54	—	2
6092392	D0120400T008S	6092299	D0120400T008S	—	—	—	—	4,0	6	8,00	57	—	2
5877575	D0120400T008	5877507	D0120400T008	—	—	—	—	4,0	6	8,00	57	0,10	2
—	—	6092300	D0020450T005S	—	—	—	—	4,5	6	5,00	54	—	2
—	—	5877509	D0020450T005	—	—	—	—	4,5	6	5,00	54	0,10	2
—	—	6092301	D0120450T008S	—	—	—	—	4,5	6	8,00	57	—	2
—	—	5877510	D0120450T008	—	—	—	—	4,5	6	8,00	57	0,10	2
6092397	D0020500T006S	6092302	D0020500T006S	—	—	—	—	5,0	6	6,00	54	—	2
—	—	5877511	D0020500T006	—	—	—	—	5,0	6	6,00	54	0,10	2
6092398	D0120500T010S	6092303	D0120500T010S	—	—	—	—	5,0	6	10,00	57	—	2
5877579	D0120500T010	5877512	D0120500T010	—	—	—	—	5,0	6	10,00	57	0,10	2
6092399	D0020600T007S	6092304	D0020600T007S	—	—	—	—	6,0	6	7,00	54	—	2
5877581	D0020600T007	5877513	D0020600T007	—	—	—	—	6,0	6	7,00	54	0,10	2
6092411	D0120600T010S	6092305	D0120600T010S	—	—	—	—	6,0	6	10,00	57	—	2
5877582	D0120600T010	5877514	D0120600T010	—	—	—	—	6,0	6	10,00	57	0,10	2
6092412	D0020700T008S	6092306	D0020700T008S	—	—	—	—	7,0	8	8,00	58	—	2
—	—	5877515	D0020700T008	—	—	—	—	7,0	8	8,00	58	0,10	2
6092414	D0120700T013S	6092307	D0120700T013S	—	—	—	—	7,0	8	13,00	63	—	2
5877584	D0120700T013	5877516	D0120700T013	—	—	—	—	7,0	8	13,00	63	0,10	2
6092415	D0020800T009S	6092308	D0020800T009S	—	—	—	—	8,0	8	9,00	58	—	2
—	—	5877517	D0020800T009	—	—	—	—	8,0	8	9,00	58	0,20	2
6092416	D0120800T016S	6092309	D0120800T016S	—	—	—	—	8,0	8	16,00	63	—	2
5877586	D0120800T016	5877518	D0120800T016	—	—	—	—	8,0	8	16,00	63	0,20	2
6092418	D0020900T010S	6092310	D0020900T010S	—	—	—	—	9,0	10	10,00	66	—	2
5877588	D0020900T010	—	—	—	—	—	—	9,0	10	10,00	66	0,20	2
—	—	6092321	D0120900T016S	—	—	—	—	9,0	10	16,00	72	—	2
—	—	5877521	D0120900T016	—	—	—	—	9,0	10	16,00	72	0,20	2
6092421	D0021000T011S	6092322	D0021000T011S	—	—	—	—	10,0	10	11,00	66	—	2
5877590	D0021000T011	5877522	D0021000T011	—	—	—	—	10,0	10	11,00	66	0,20	2
6092422	D0121000T019S	6092323	D0121000T019S	—	—	—	—	10,0	10	19,00	72	—	2
—	—	5877523	D0121000T019	—	—	—	—	10,0	10	19,00	72	0,20	2
6092423	D0021200T012S	6092324	D0021200T012S	—	—	6092334	D0021200W012S	12,0	12	12,00	73	—	2
5877592	D0021200T012	5877524	D0021200T012	—	—	5877535	D0021200W012	12,0	12	12,00	73	0,30	2
6092424	D0121200T022S	6092325	D0121200T022S	—	—	6092335	D0121200W022S	12,0	12	22,00	83	—	2
—	—	5877525	D0121200T022	—	—	5877537	D0121200W022	12,0	12	22,00	83	0,30	2
6092426	D0021400T014S	6092326	D0021400T014S	—	—	6092336	D0021400W014S	14,0	14	14,00	75	—	2
—	—	5877526	D0021400T014	—	—	5877538	D0021400W014	14,0	14	14,00	75	0,30	2
—	—	6092327	D0121400T022S	—	—	6092337	D0121400W022S	14,0	14	22,00	83	—	2
5877595	D0121400T022	5877527	D0121400T022	—	—	5877539	D0121400W022	14,0	14	22,00	83	0,30	2
—	—	6092328	D0021600T016S	—	—	6092338	D0021600W016S	16,0	16	16,00	82	—	2
—	—	5877529	D0021600T016	—	—	5877540	D0021600W016	16,0	16	16,00	82	0,30	2
—	—	6092329	D0121600T026S	6092350	D0121600W026S	6092339	D0121600W026S	16,0	16	26,00	92	—	2
—	—	5877530	D0121600T026	—	—	5877551	D0121600W026	16,0	16	26,00	92	0,30	2
—	—	6092330	D0021800T018S	—	—	6092340	D0021800W018S	18,0	18	18,00	84	—	2
—	—	5877531	D0021800T018	—	—	5877552	D0021800W018	18,0	18	18,00	84	0,30	2
—	—	6092331	D0121800T026S	—	—	6092341	D0121800W026S	18,0	18	26,00	92	—	2
—	—	5877532	D0121800T026	—	—	5877553	D0121800W026	18,0	18	26,00	92	0,30	2
—	—	6092332	D0022000T020S	—	—	6092342	D0022000W020S	20,0	20	20,00	92	—	2
—	—	5877533	D0022000T020	—	—	5877554	D0022000W020	20,0	20	20,00	92	0,30	2
—	—	6092333	D0122000T032S	—	—	6092344	D0122000W032S	20,0	20	32,00	104	—	2
5877602	D0122000T032	5877534	D0122000T032	—	—	5877555	D0122000W032	20,0	20	32,00	104	0,30	2

NOTE: For application data, please see page B47–B49.

GP End Mills • Series 2819 • Square End • 2 Flute • Metric DIN 6528

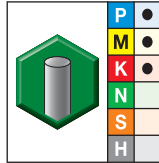
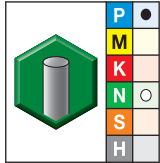
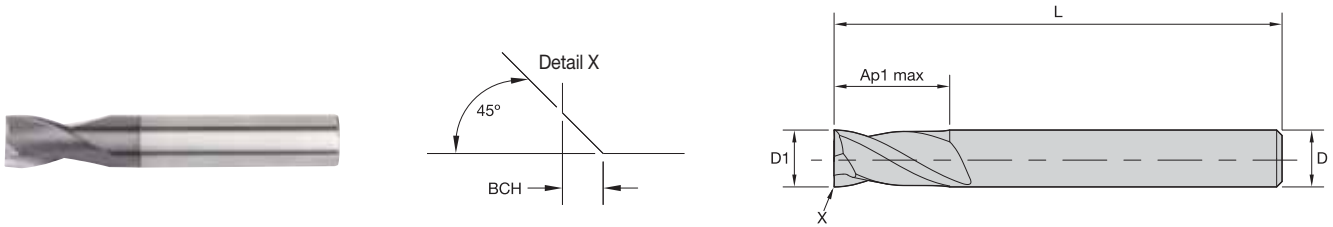

- first choice
- alternate choice

UNCOATED		TiAlN		D1	D	length of cut Ap1 max	length L	BCH	Z U
order #	catalogue #	order #	catalogue #						
—	—	5877603	28190300T007	3,0	3	8,00	50	—	2
6092573	28190400T008S	6092528	28190400T008S	4,0	4	8,00	50	—	2
—	—	5877604	28190400T008	4,0	4	8,00	50	0,10	2
—	—	6092529	28190500T010S	5,0	5	10,00	50	—	2
—	—	5877605	28190500T010	5,0	5	10,00	50	0,10	2
—	—	6092530	28190600T010S	6,0	6	10,00	57	—	2
—	—	5877606	28190600T010	6,0	6	10,00	57	0,10	2
—	—	6092562	28190800T016S	8,0	8	16,00	63	—	2
—	—	5877608	28190800T016	8,0	8	16,00	63	0,20	2
—	—	6092563	28190900T016S	9,0	9	16,00	67	—	2
—	—	5877609	28190900T016	9,0	9	16,00	67	0,20	2
—	—	6092565	28191000T019S	10,0	10	19,00	72	—	2
—	—	5877610	28191000T019	10,0	10	19,00	72	0,20	2
—	—	6092566	28191200T022S	12,0	12	22,00	83	—	2
—	—	5877611	28191200T022	12,0	12	22,00	83	0,30	2
—	—	6092567	28191400T022S	14,0	14	22,00	83	—	2
—	—	5877612	28191400T022	14,0	14	22,00	83	0,30	2
—	—	6092568	28191500T026S	15,0	15	26,00	92	—	2
—	—	5877613	28191500T026	15,0	15	26,00	92	0,30	2
—	—	6092569	28191600T026S	16,0	16	26,00	92	—	2
—	—	5877614	28191600T026	16,0	16	26,00	92	0,30	2
—	—	6092571	28192000T032S	20,0	20	32,00	104	—	2
—	—	5877616	28192000T032	20,0	20	32,00	104	0,30	2

NOTE: For application data, please see pages B47.

General-Purpose Solid Carbide End Mills

GP End Mills • Series 4001 4011 4021 • Ball Nose • 2 Flute • Metric

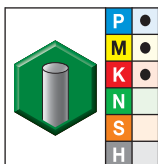
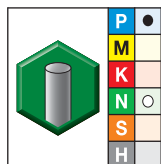
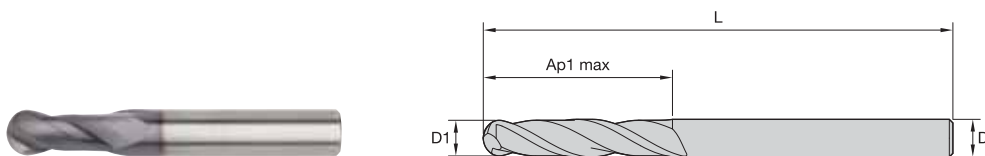

● first choice
○ alternate choice

UNCOATED		TiAlN		D1	D	length of cut Ap1 max	length L	Z U
order #	catalogue #	order #	catalogue #					
5880425	40010100T004	5880387	40010100T004	1,0	3	4,00	38	2
5880426	40010150T005	5880388	40010150T005	1,5	3	5,00	38	2
5880427	40010200T006	5880389	40010200T006	2,0	3	6,30	38	2
—	—	5880390	40010250T007	2,5	3	7,00	38	2
5880429	40010300T009	5880391	40010300T009	3,0	3	9,50	38	2
—	—	6232631	40110300T019	3,0	3	19,00	63	2
—	—	6232632	40210300T025	3,0	3	25,00	75	2
—	—	5880392	40010350T012	3,5	4	12,00	50	2
5880430	40010400T012	5880393	40010400T012	4,0	4	12,00	50	2
—	—	5880395	40110400T019	4,0	4	19,00	63	2
5880432	40210400T031	5880396	40210400T031	4,0	4	31,00	75	2
5880433	40010500T014	6209446	40010500T014	5,0	5	14,00	50	2
—	—	6209447	40110500T020	5,0	5	20,00	63	2
—	—	5880397	40210500T014	5,0	6	14,00	50	2
5880435	40010600T020	5880398	40010600T020	6,0	6	20,00	63	2
5880436	40110600T028	5880399	40110600T028	6,0	6	28,00	76	2
5880437	40210600T038	5880400	40210600T038	6,0	6	38,00	100	2
5880438	40010800T020	5880401	40010800T020	8,0	8	20,00	63	2
5880439	40110800T028	5880402	40110800T028	8,0	8	28,00	76	2
5880440	40210800T040	5880403	40210800T040	8,0	8	40,00	100	2
5880441	40011000T022	5880404	40011000T022	10,0	10	22,00	76	2
5880442	40111000T032	5880405	40111000T032	10,0	10	32,00	89	2
5880443	40211000T045	5880406	40211000T045	10,0	10	45,00	100	2
5880444	40011200T025	5880407	40011200T025	12,0	12	25,00	75	2
5880445	40111200T045	5880408	40111200T045	12,0	12	45,00	100	2
5880446	40211200T075	5880409	40211200T075	12,0	12	75,00	150	2
—	—	5880410	40011400T032	14,0	14	32,00	89	2
5880448	40011600T032	5880411	40011600T032	16,0	16	32,00	89	2
—	—	6209448	40111600T056	16,0	16	56,00	110	2
—	—	6209449	40211600T075	16,0	16	75,00	150	2
5880449	40012000T038	5880412	40012000T038	20,0	20	38,00	100	2
5880450	40112000T075	5880413	40112000T075	20,0	20	75,00	150	2

NOTE: For application data, please see pages B47–B49.

INDEXABLE MILLING

SOLID END MILLING

HOLEMAKING

TAPPING

TURNING

GP End Mills • Series D001 D011 • Ball Nose • 2 Flute • Metric

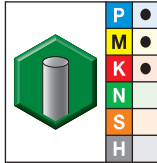
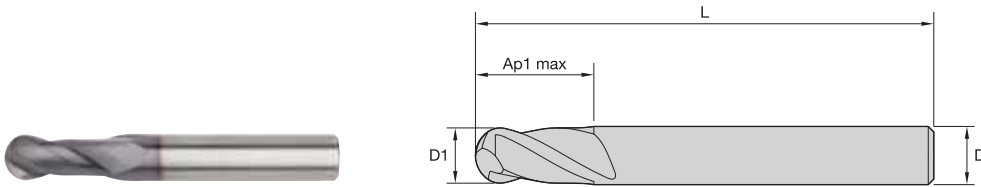

- first choice
- alternate choice

TiAlN		D1	D	length of cut Ap1 max	length L	Z U
5880362	D0110200T006	2,0	6	6,00	57	2
5880363	D0010300T004	3,0	6	4,00	50	2
5880364	D0110300T007	3,0	6	7,00	57	2
5880365	D0010400T005	4,0	6	5,00	54	2
5880366	D0110400T008	4,0	6	8,00	57	2
5880367	D0110500T010	5,0	6	10,00	57	2
5880368	D0110600T010	6,0	6	10,00	57	2
5880369	D0110700T013	7,0	8	13,00	63	2
5880370	D0110800T016	8,0	8	16,00	63	2
5880381	D0111000T019	10,0	10	19,00	72	2
5880382	D0111200T022	12,0	12	22,00	83	2
5880383	D0111400T022	14,0	14	22,00	83	2
5880384	D0111600T026	16,0	16	26,00	92	2
5880385	D0012000T020	20,0	20	20,00	92	2
5880386	D0112000T032	20,0	20	32,00	104	2

NOTE: For application data, please see pages B48 and B50.

GP End Mills • Series 2838 • Ball Nose • 2 Flute • Metric

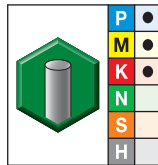
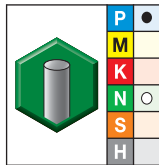
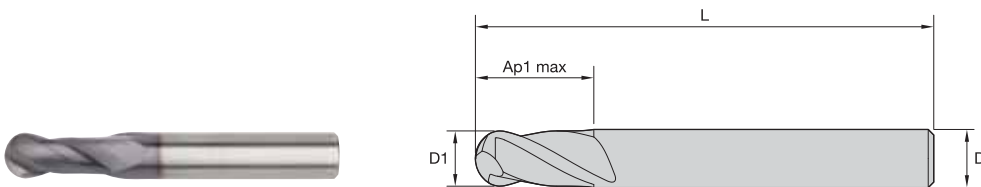

- first choice
- alternate choice

UNCOATED		TiAlN		D1	D	length of cut Ap1 max	length L	Z U
—	—	5880451	28380200T007	2,0	2	7,00	50	2
—	—	5880452	28380300T007	3,0	3	7,00	50	2
—	—	5880453	28380400T008	4,0	4	8,00	50	2
—	—	5880454	28380500T010	5,0	5	10,00	50	2
5880465	28380600T010	5880455	28380600T010	6,0	6	10,00	57	2
—	—	5880456	28380800T016	8,0	8	16,00	63	2
—	—	5880457	28381000T019	10,0	10	19,00	72	2
—	—	5880458	28381200T022	12,0	12	22,00	83	2
—	—	5880459	28381400T022	14,0	14	22,00	83	2
—	—	5880460	28381600T026	16,0	16	26,00	92	2

NOTE: For application data, please see page B50.

General-Purpose Solid Carbide End Mills

GP End Mills • Series 4003 4013 • Sharp Edge • 3 Flute • Metric

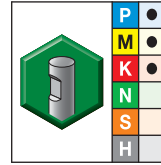
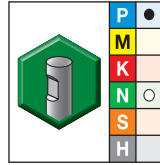
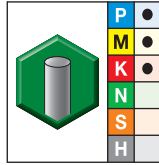
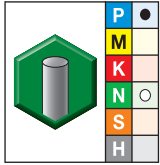
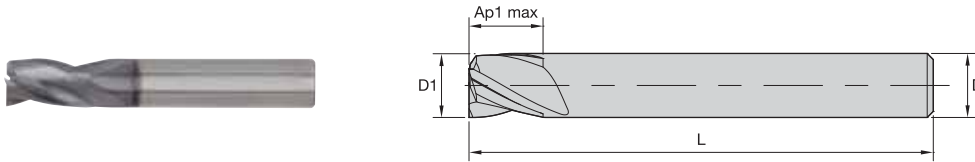

- first choice
- alternate choice

UNCOATED		TiAlN		UNCOATED		TiAlN		D1	D	length of cut Ap1 max	length L	Z U
order #	catalogue #	order #	catalogue #	order #	catalogue #	order #	catalogue #					
6144570	40030100T004S	6144056	40030100T004S	—	—	—	—	1,0	3	4,00	38	3
6144651	40030150T004S	6144057	40030150T004S	—	—	—	—	1,5	3	4,00	38	3
6144652	40030200T006S	6144058	40030200T006S	—	—	—	—	2,0	3	6,30	38	3
6144653	40030250T006S	6144059	40030250T006S	—	—	—	—	2,5	3	6,30	38	3
6144654	40030300T009S	6144060	40030300T009S	—	—	—	—	3,0	3	9,50	38	3
6145303	40130300T019S	6145199	40130300T019S	6145319	40130300W019S	6145243	40130300W019S	3,0	6	19,00	63	3
6144655	40030400T012S	6144551	40030400T012S	—	—	—	—	4,0	4	12,00	50	3
6145305	40130400T019S	6145200	40130400T019S	—	—	—	—	4,0	4	19,00	63	3
6144656	40030500T014S	6144552	40030500T014S	—	—	—	—	5,0	6	14,00	50	3
—	—	6145231	40130500T020S	—	—	6145247	40130500W020S	5,0	6	20,00	63	3
6144657	40030600T016S	6144553	40030600T016S	—	—	6144565	40030600W016S	6,0	6	16,00	50	3
6145309	40130600T028S	6145232	40130600T028S	—	—	—	—	6,0	6	28,00	75	3
6144658	40030800T019S	6144554	40030800T019S	—	—	6144566	40030800W019S	8,0	8	19,00	63	3
6145311	40130800T028S	6145233	40130800T028S	—	—	—	—	8,0	8	28,00	75	3
6144659	40031000T022S	6144555	40031000T022S	—	—	6144567	40031000W022S	10,0	10	22,00	76	3
6145313	40131000T032S	6145234	40131000T032S	—	—	—	—	10,0	10	32,00	89	3
6144660	40031200T025S	6144556	40031200T025S	—	—	6144568	40031200W025S	12,0	12	25,00	75	3
6145315	40131200T045S	6145235	40131200T045S	—	—	6145255	40131200W045S	12,0	12	45,00	100	3
6144661	40031600T032S	6144557	40031600T032S	—	—	6144569	40031600W032S	16,0	16	32,00	89	3
6145317	40131600T056S	6145238	40131600T056S	—	—	6145257	40131600W056S	16,0	16	56,00	110	3
6145318	40132000T064S	6145241	40132000T064S	—	—	6145259	40132000W064S	20,0	20	64,00	125	3

NOTE: For application data, please see pages B50–B52.

INDEXABLE MILLING

SOLID END MILLING

HOLEMAKING

TAPPING

TURNING

GP End Mills • Series 4003 4013 • Chamfered • 3 Flute • Metric

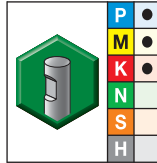
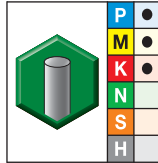
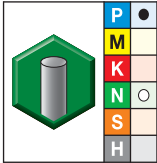
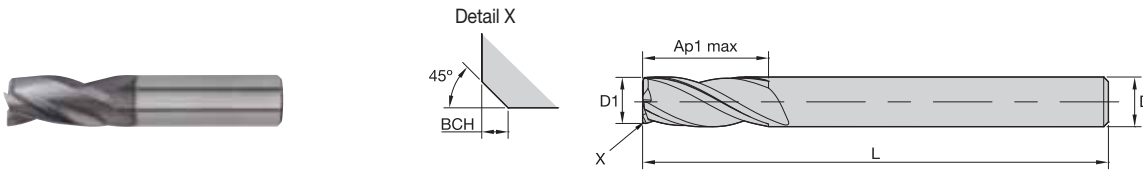

● first choice
○ alternate choice

UNCOATED		TiAlN		TiAlN		D1	D	length of cut Ap1 max	length L	BCH	Z U
order #	catalogue #	order #	catalogue #	order #	catalogue #						
—	—	6145107	40030400T012	—	—	4,0	4	12,00	50	0,10	3
—	—	6145181	40130400T019	—	—	4,0	4	19,00	63	0,10	3
6145275	40130500T020	6145182	40130500T020	6145190	40130500W020	5,0	6	20,00	63	0,10	3
6145242	40030600T016	6145109	40030600T016	6145176	40030600W016	6,0	6	16,00	50	0,10	3
6145276	40130600T028	6145183	40130600T028	—	—	6,0	6	28,00	75	0,10	3
—	—	6145110	40030800T019	—	—	8,0	8	19,00	63	0,20	3
6145277	40130800T028	6145184	40130800T028	—	—	8,0	8	28,00	75	0,20	3
—	—	6145171	40031000T022	6145178	40031000W022	10,0	10	22,00	76	0,20	3
6145278	40131000T032	6145185	40131000T032	—	—	10,0	10	32,00	89	0,20	3
6145248	40031200T025	6145172	40031200T025	6145179	40031200W025	12,0	12	25,00	75	0,30	3
6145279	40131200T045	6145186	40131200T045	6145194	40131200W045	12,0	12	45,00	100	0,30	3
6145250	40031600T032	6145173	40031600T032	6145180	40031600W032	16,0	16	32,00	89	0,30	3
—	—	6145187	40131600T056	6145195	40131600W056	16,0	16	56,00	110	0,30	3
—	—	6145188	40132000T064	6145196	40132000W064	20,0	20	64,00	125	0,30	3

NOTE: For application data, please see pages B50–B52.

General-Purpose Solid Carbide End Mills

GP End Mills • Series D003 D013 • Sharp Edge • 3 Flute • Metric

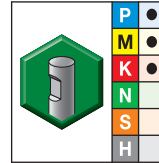
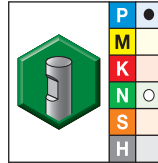
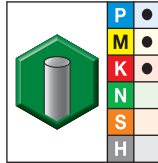
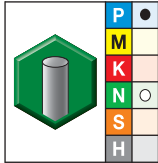
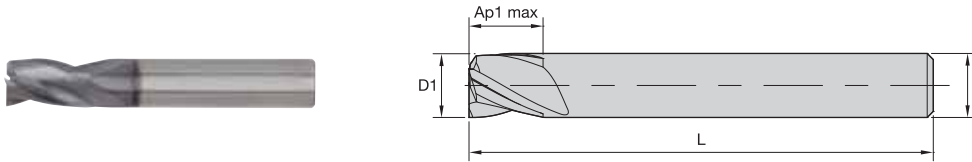

- first choice
- alternate choice

UNCOATED		TiAlN		UNCOATED		TiAlN		D1	D	length of cut Ap1 max	length L	Z U
order #	catalogue #	order #	catalogue #	order #	catalogue #	order #	catalogue #					
6144450	D0030200T003S	6144351	D0030200T003S	—	—	6144388	D0030200W003S	2,0	6	3,00	50	3
6143764	D0130200T006S	6144441	D0130200T006S	6143831	D0130200W006S	6144467	D0130200W006S	2,0	6	6,00	57	3
6143765	D0130250T007S	6144352	D0030250T003S	—	—	6144390	D0030250W003S	2,5	6	3,00	50	3
6144454	D0030300T004S	6144442	D0130250T007S	6143832	D0130250W007S	6144469	D0130250W007S	2,5	6	7,00	57	3
6143766	D0130300T007S	6144353	D0030300T004S	6144488	D0030300W004S	6144392	D0030300W004S	3,0	6	4,00	50	3
6144456	D0030350T004S	6144443	D0130300T007S	6143833	D0130300W007S	6144471	D0130300W007S	3,0	6	7,00	57	3
—	—	6144354	D0030350T004S	—	—	6144394	D0030350W004S	3,5	6	4,00	50	3
—	—	6144444	D0130350T007S	6143834	D0130350W007S	6144473	D0130350W007S	3,5	6	7,00	57	3
6143768	D0130400T008S	6144355	D0030400T005S	6144492	D0030400W005S	6144396	D0030400W005S	4,0	6	5,00	54	3
—	—	6144445	D0130400T008S	6143835	D0130400W008S	6144475	D0130400W008S	4,0	6	8,00	57	3
—	—	6144446	D0130450T008S	6143836	D0130450W008S	—	—	4,5	6	8,00	57	3
—	—	6144357	D0030500T006S	—	—	6144400	D0030500W006S	5,0	6	6,00	54	3
6143770	D0130500T010S	6144447	D0130500T010S	6143837	D0130500W010S	—	—	5,0	6	10,00	57	3
—	—	6144358	D0030550T007S	—	—	—	—	5,5	6	7,00	54	3
—	—	6144448	D0130550T010S	—	—	6144481	D0130550W010S	5,5	6	10,00	57	3
—	—	6144360	D0030600T007S	—	—	6144404	D0030600W007S	6,0	6	7,00	54	3
6143822	D0130600T010S	6144449	D0130600T010S	6143839	D0130600W010S	6144483	D0130600W010S	6,0	6	10,00	57	3
6144468	D0030700T008S	6144372	D0030700T008S	—	—	6144406	D0030700W008S	7,0	8	8,00	58	3
—	—	6144451	D0130700T013S	—	—	6144485	D0130700W013S	7,0	8	13,00	63	3
—	—	6144374	D0030800T009S	—	—	6144408	D0030800W009S	8,0	8	9,00	58	3
—	—	6144453	D0130800T016S	—	—	6144487	D0130800W016S	8,0	8	16,00	63	3
—	—	6144376	D0031000T011S	—	—	6144410	D0031000W011S	10,0	10	11,00	66	3
—	—	—	—	6143842	D0131000W019S	6144489	D0131000W019S	10,0	10	19,00	72	3
—	—	6144378	D0031200T012S	—	—	6144412	D0031200W012S	12,0	12	12,00	73	3
—	—	6144457	D0131200T022S	—	—	6144491	D0131200W022S	12,0	12	22,00	83	3
—	—	6144380	D0031400T014S	—	—	6144414	D0031400W014S	14,0	14	14,00	75	3
6143827	D0131400T022S	6144459	D0131400T022S	—	—	6144493	D0131400W022S	14,0	14	22,00	83	3
—	—	6144382	D0031600T016S	—	—	6144416	D0031600W016S	16,0	16	16,00	82	3
—	—	6144461	D0131600T026S	—	—	6144495	D0131600W026S	16,0	16	26,00	92	3
—	—	6144384	D0031800T018S	—	—	6144418	D0031800W018S	18,0	18	18,00	84	3
—	—	6144463	D0131800T026S	—	—	6144497	D0131800W026S	18,0	18	26,00	92	3
6144482	D0032000T020S	6144386	D0032000T020S	—	—	6144420	D0032000W020S	20,0	20	20,00	92	3
—	—	6144465	D0132000T032S	—	—	6144499	D0132000W032S	20,0	20	32,00	104	3

NOTE: For application data, please see pages B51–B52.

INDEXABLE MILLING

SOLID END MILLING

HOLEMAKING

TAPPING

TURNING

GP End Mills • Series D003 D013 • Chamfered • 3 Flute • Metric

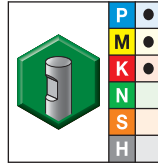
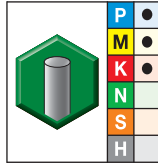
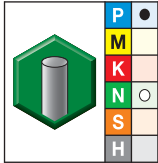
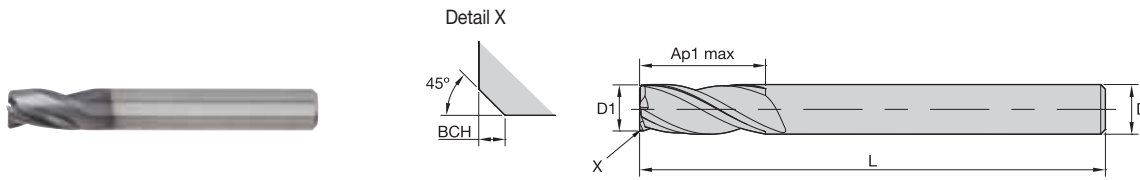

● first choice
○ alternate choice

UNCOATED		TiAlN		TiAlN		D1	D	length of cut Ap1 max	length L	BCH	Z U
order #	catalogue #	order #	catalogue #	order #	catalogue #						
—	—	6144295	D0030400T005	6144318	D0030400W005	4,0	6	5,00	54	0,10	3
—	—	6144359	D0130400T008	6144395	D0130400W008	4,0	6	8,00	57	0,10	3
—	—	6144296	D0030450T005	6144319	D0030450W005	4,5	6	5,00	54	0,10	3
—	—	6144371	D0130450T008	6144397	D0130450W008	4,5	6	8,00	57	0,10	3
6145044	D0030500T006	6144297	D0030500T006	6144320	D0030500W006	5,0	6	6,00	54	0,10	3
—	—	6144373	D0130500T010	6144399	D0130500W010	5,0	6	10,00	57	0,10	3
—	—	6144298	D0030550T007	6144331	D0030550W007	5,5	6	7,00	54	0,10	3
—	—	6144375	D0130550T010	6144401	D0130550W010	5,5	6	10,00	57	0,10	3
—	—	6144299	D0030600T007	6144332	D0030600W007	6,0	6	7,00	54	0,10	3
—	—	6144377	D0130600T010	6144403	D0130600W010	6,0	6	10,00	57	0,10	3
—	—	6144300	D0030700T008	6144333	D0030700W008	7,0	8	8,00	58	0,10	3
—	—	6144379	D0130700T013	6144405	D0130700W013	7,0	8	13,00	63	0,10	3
—	—	6144311	D0030800T009	6144334	D0030800W009	8,0	8	9,00	58	0,20	3
6145087	D0130800T016	6144381	D0130800T016	6144407	D0130800W016	8,0	8	16,00	63	0,20	3
—	—	6144312	D0031000T011	6144335	D0031000W011	10,0	10	11,00	66	0,20	3
—	—	6144383	D0131000T019	6144409	D0131000W019	10,0	10	19,00	72	0,20	3
—	—	6144313	D0031200T012	6144336	D0031200W012	12,0	12	12,00	73	0,30	3
—	—	6144385	D0131200T022	6144411	D0131200W022	12,0	12	22,00	83	0,30	3
—	—	6144314	D0031400T014	6144337	D0031400W014	14,0	14	14,00	75	0,30	3
—	—	6144387	D0131400T022	6144413	D0131400W022	14,0	14	22,00	83	0,30	3
—	—	6144315	D0031600T016	6144338	D0031600W016	16,0	16	16,00	82	0,30	3
—	—	6144389	D0131600T026	—	—	16,0	16	26,00	92	0,30	3
—	—	6144316	D0031800T018	6144339	D0031800W018	18,0	18	18,00	84	0,30	3
—	—	6144391	D0131800T026	6144417	D0131800W026	18,0	18	26,00	92	0,30	3
—	—	6144317	D0032000T020	—	—	20,0	20	20,00	92	0,30	3
—	—	6144393	D0132000T032	6144419	D0132000W032	20,0	20	32,00	104	0,30	3

NOTE: For application data, please see pages B51–B52.

General-Purpose Solid Carbide End Mills

GP End Mills • Series 4004 4014 4024 • Square End • 4 Flute • Metric

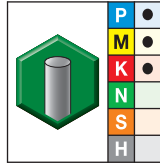
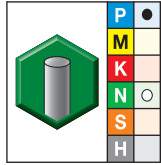
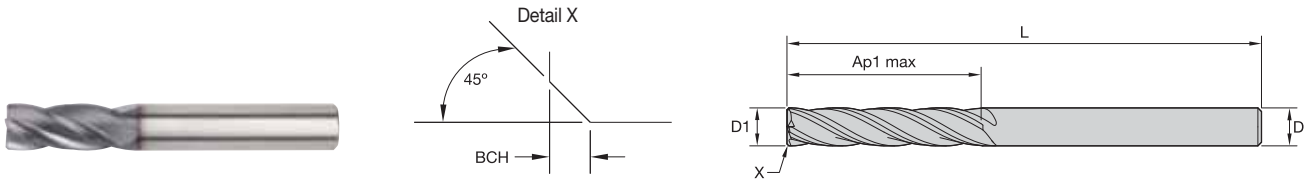

● first choice
○ alternate choice

UNCOATED		TiAlN		D1	D	length of cut Ap1 max	length L	BCH	Z U
order #	catalogue #	order #	catalogue #						
5826085	40040100T004	5826016	40040100T004	1,0	3	4,00	38	—	4
5826086	40040150T004	5826017	40040150T004	1,5	3	4,00	38	—	4
5826087	40040200T006	5826018	40040200T006	2,0	3	6,30	38	—	4
5826088	40040250T006	5826019	40040250T006	2,5	3	6,30	38	—	4
5826089	40040300T009	5826020	40040300T009	3,0	3	9,50	38	—	4
5826090	40140300T019	5826021	40140300T019	3,0	3	19,00	63	—	4
5826101	40240300T025	5826022	40240300T025	3,0	3	25,00	75	—	4
5826102	40040350T012	5826023	40040350T012	3,5	4	12,00	50	—	4
5826103	40040400T011	5826024	40040400T011	4,0	4	11,00	50	0,10	4
6085522	40040400T011S	6085576	40040400T011S	4,0	4	11,00	50	—	4
—	—	6085577	40140400T019S	4,0	4	19,00	63	—	4
—	—	5826025	40140400T019	4,0	4	19,00	63	0,10	4
—	—	6085578	40240400T031S	4,0	4	31,00	75	—	4
—	—	5826026	40240400T031	4,0	4	31,00	75	0,10	4
—	—	6085579	40040450T014S	4,5	5	14,00	50	—	4
5826104	40040450T014	5826027	40040450T014	4,5	5	14,00	50	0,10	4
—	—	6085580	40040500T013S	5,0	5	13,00	50	—	4
—	—	5826028	40040500T013	5,0	5	13,00	50	0,10	4
—	—	6085581	40040500T020S	5,0	5	20,00	63	—	4
5826105	40040500T020	5826029	40040500T020	5,0	5	20,00	63	0,10	4
—	—	6085582	40140500T030S	5,0	5	30,00	75	—	4
—	—	5826030	40140500T030	5,0	5	30,00	75	0,10	4
—	—	6085583	40240500T031S	5,0	5	31,00	100	—	4
—	—	5826031	40240500T031	5,0	5	31,00	100	0,10	4
6085525	40040600T016S	6085584	40040600T016S	6,0	6	16,00	50	—	4
5826106	40040600T016	5826032	40040600T016	6,0	6	16,00	50	0,10	4
6085526	40140600T028S	6085585	40140600T028S	6,0	6	28,00	75	—	4
5826107	40140600T028	5826033	40140600T028	6,0	6	28,00	75	0,10	4
6085527	40240600T038S	6085586	40240600T038S	6,0	6	38,00	100	—	4
5826108	40240600T038	5826034	40240600T038	6,0	6	38,00	100	0,10	4
—	—	6085587	40040700T020S	7,0	8	20,00	63	—	4
—	—	5826035	40040700T020	7,0	8	20,00	63	0,10	4
—	—	6200965	40040800T021S	8,0	8	20,00	63	—	4
6085528	40040800T020S	6085588	40040800T020S	8,0	8	20,00	50	—	4
5826109	40040800T020	5826036	40040800T020	8,0	8	20,00	50	0,20	4
6085529	40140800T028S	6085589	40140800T028S	8,0	8	28,00	75	—	4
5826110	40140800T028	5826037	40140800T028	8,0	8	28,00	75	0,20	4
6085530	40240800T041S	6085590	40240800T041S	8,0	8	41,00	100	—	4
5826111	40240800T041	5826038	40240800T041	8,0	8	41,00	100	0,20	4
—	—	6085591	40040900T020S	9,0	9	20,00	63	—	4
—	—	5826039	40040900T020	9,0	9	20,00	63	0,20	4
5826113	40041000T022	5826040	40041000T022	10,0	10	22,00	72	0,20	4
6085531	40041000T022S	6085592	40041000T022S	10,0	10	22,00	72	—	4
6085532	40141000T032S	6085593	40141000T032S	10,0	10	32,00	89	—	4
5826114	40141000T032	5826041	40141000T032	10,0	10	32,00	89	0,20	4
6085533	40241000T045S	6085594	40241000T045S	10,0	10	45,00	100	—	4
5826115	40241000T045	5826042	40241000T045	10,0	10	45,00	100	0,20	4
5826141	40041200W025	—	—	12,0	12	25,00	75	0,30	4
6085534	40041200T025S	6085610	40041200W025S	12,0	12	25,00	75	—	4
—	—	5826043	40041200T025	12,0	12	25,00	89	0,30	4
—	—	6085595	40041200T025S	12,0	12	25,00	89	—	4
5826116	40041200T025	5826070	40041200W025	12,0	12	25,00	75	0,30	4

GP End Mills • Series 4004 4014 4024 • Square End • 4 Flute • Metric

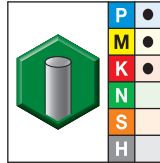
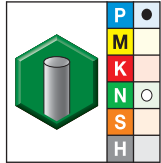
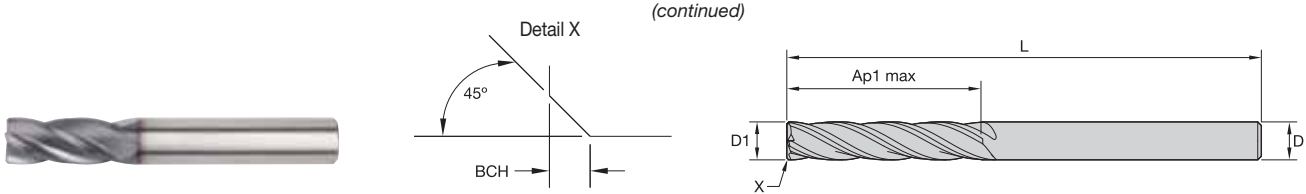

- first choice
- alternate choice

UNCOATED		TiAlN		D1	D	length of cut Ap1 max	length L	BCH	Z U
order #	catalogue #	order #	catalogue #						
6085549	40041200W025S	—	—	12,0	12	25,00	75	—	4
6085535	40141200T045S	6085596	40141200T045S	12,0	12	45,00	100	—	4
5826117	40141200T045	5826044	40141200T045	12,0	12	45,00	100	0,30	4
—	—	6085611	40141200W045S	12,0	12	45,00	100	—	4
—	—	5826071	40141200W045	12,0	12	45,00	100	0,30	4
6085536	40241200T075S	6085597	40241200T075S	12,0	12	75,00	150	—	4
5826118	40241200T075	5826045	40241200T075	12,0	12	75,00	150	0,30	4
—	—	6085612	40241200W075S	12,0	12	75,00	150	—	4
—	—	5826072	40241200W075	12,0	12	75,00	150	0,30	4
—	—	6085613	40041400W032S	14,0	14	32,00	83	—	4
—	—	5826073	40041400W032	14,0	14	32,00	83	0,30	4
6085537	40041400T032S	6085598	40041400T032S	14,0	14	32,00	83	—	4
5826119	40041400T032	5826046	40041400T032	14,0	14	32,00	83	0,30	4
—	—	6085599	40141400T050S	14,0	14	50,00	100	—	4
—	—	5826047	40141400T050	14,0	14	50,00	100	0,30	4
—	—	6085614	40141400W050S	14,0	14	50,00	100	—	4
—	—	5826074	40141400W050	14,0	14	50,00	100	0,30	4
—	—	6085600	40241400T075S	14,0	14	75,00	150	—	4
—	—	5826049	40241400T075	14,0	14	75,00	150	0,30	4
—	—	6085615	40241400W075S	14,0	14	75,00	150	—	4
—	—	5826075	40241400W075	14,0	14	75,00	150	0,30	4
—	—	6085616	40041600W032S	16,0	16	32,00	92	—	4
—	—	5826076	40041600W032	16,0	16	32,00	92	0,30	4
6085540	40041600T032S	6085601	40041600T032	16,0	16	32,00	92	—	4
5826122	40041600T032	5826061	40041600T032	16,0	16	32,00	92	0,30	4
5826123	40141600T056	5826062	40141600T056	16,0	16	56,00	110	0,30	4
—	—	6102465	40141600W056S	16,0	16	56,00	110	—	4
—	—	5826077	40141600W056	16,0	16	56,00	110	0,30	4
6085541	40141600T056S	6085602	40141600T056S	16,0	16	56,00	110	—	4
6085542	40241600T075S	6085603	40241600T075S	16,0	16	75,00	150	—	4
5826124	40241600T075	5826063	40241600T075	16,0	16	75,00	150	0,30	4
—	—	6085427	40241600W075S	16,0	16	75,00	150	—	4
—	—	5826078	40241600W075	16,0	16	75,00	150	0,30	4
6086533	40041800W038S	6085428	40041800W038S	18,0	18	38,00	100	—	4
6085543	40041800T038S	6085604	40041800T038S	18,0	18	38,00	100	—	4
5826125	40041800T038	5826064	40041800T038	18,0	18	38,00	100	0,30	4
—	—	6085605	40141800T060S	18,0	18	60,00	125	—	4
—	—	5826065	40141800T060	18,0	18	60,00	125	0,30	4
—	—	6085606	40241800T075S	18,0	18	75,00	150	—	4
—	—	5826066	40241800T075	18,0	18	75,00	150	0,30	4
6085546	40042000T038S	6085607	40042000T038S	20,0	20	38,00	104	—	4
—	—	5826082	40042000W038	20,0	20	38,00	104	0,30	4
5826128	40042000T038	5826067	40042000T038	20,0	20	38,00	104	0,30	4
—	—	6085511	40042000W038S	20,0	20	38,00	104	—	4
—	—	5826083	40142000W056	20,0	20	56,00	125	0,30	4
—	—	5826068	40142000T056	20,0	20	56,00	125	0,30	4
6085547	40142000T056S	6085608	40142000T056S	20,0	20	56,00	125	—	4
—	—	6085512	40142000W056S	20,0	20	56,00	125	—	4
6085548	40242000T075S	6085609	40242000T075S	20,0	20	75,00	150	—	4
—	—	5826069	40242000T075	20,0	20	75,00	150	0,30	4
—	—	6085513	40242000W075S	20,0	20	75,00	150	—	4
—	—	5826084	40242000W075	20,0	20	75,00	150	0,30	4

NOTE: For application data, please see pages B52–B54.

General-Purpose Solid Carbide End Mills

GP End Mills • Series 4004 4014 4024 • Radiused • 4 Flute • Metric

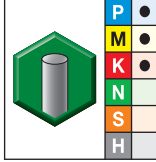
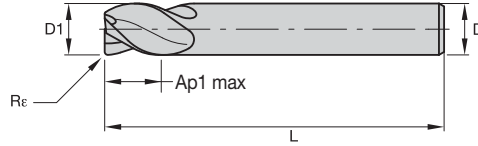

- first choice
- alternate choice

TiAlN		D1	D	length of cut Ap1 max	length L	Re	Z U
6337590	40040200T006R050	2,0	3	6,30	38	0,50	4
6337731	40040300T009R050	3,0	3	9,50	38	0,50	4
6337732	40040300T009R100	3,0	3	9,50	38	1,00	4
6337892	40140300T019R050	3,0	3	19,00	63	0,50	4
6338335	40240300T025R050	3,0	3	25,00	75	0,50	4
6337733	40040400T011R050	4,0	4	11,00	50	0,50	4
6337734	40040400T011R100	4,0	4	11,00	50	1,00	4
6337893	40140400T019R050	4,0	4	19,00	63	0,50	4
6337894	40140400T019R100	4,0	4	19,00	63	1,00	4
6338336	40240400T031R050	4,0	4	31,00	75	0,50	4
6338337	40240400T031R100	4,0	4	31,00	75	1,00	4
6337735	40040500T013R050	5,0	5	13,00	50	0,50	4
6337895	40140500T030R050	5,0	5	30,00	75	0,50	4
6337896	40140500T030R100	5,0	5	30,00	75	1,00	4
6337737	40040600T016R100	6,0	6	16,00	50	1,00	4
6337736	40040600T016R050	6,0	6	16,00	50	0,50	4
6337897	40140600T028R050	6,0	6	28,00	75	0,50	4
6337898	40140600T028R100	6,0	6	28,00	75	1,00	4
6338338	40240600T038R050	6,0	6	38,00	100	0,50	4
6338339	40240600T038R100	6,0	6	38,00	100	1,00	4
6337739	40040800T020R100	8,0	8	20,00	50	1,00	4
6337738	40040800T020R050	8,0	8	20,00	50	0,50	4
6337899	40140800T028R050	8,0	8	28,00	75	0,50	4
6337900	40140800T028R100	8,0	8	28,00	75	1,00	4
6338340	40240800T041R050	8,0	8	41,00	100	0,50	4
6338341	40240800T041R100	8,0	8	41,00	100	1,00	4
6337740	40041000T022R050	10,0	10	22,00	72	0,50	4
6337741	40041000T022R100	10,0	10	22,00	72	1,00	4
6337912	40141000T032R100	10,0	10	32,00	89	1,00	4
6337911	40141000T032R050	10,0	10	32,00	89	0,50	4
6338342	40241000T045R050	10,0	10	45,00	100	0,50	4
6338343	40241000T045R100	10,0	10	45,00	100	1,00	4
6337742	40041200T025R050	12,0	12	25,00	89	0,50	4
6337743	40041200T025R100	12,0	12	25,00	89	1,00	4
6337914	40141200T045R100	12,0	12	45,00	100	1,00	4
6337913	40141200T045R050	12,0	12	45,00	100	0,50	4
6338344	40241200T075R050	12,0	12	75,00	150	0,50	4
6338345	40241200T075R100	12,0	12	75,00	150	1,00	4
6337744	40041600T032R050	16,0	16	32,00	92	0,50	4
6337745	40041600T032R100	16,0	16	32,00	92	1,00	4
6337915	40141600T056R050	16,0	16	56,00	110	0,50	4
6338346	40241600T075R050	16,0	16	75,00	150	0,50	4
6338347	40241600T075R100	16,0	16	75,00	150	1,00	4
6338349	40242000T075R050	20,0	20	75,00	150	0,50	4

NOTE: Refer to the NOVO™ app for the complete GP end mill offering.

GP End Mills • Series D004 D014 • Square End • 4 Flute • Metric DIN 6527

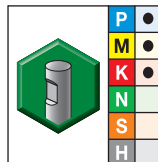
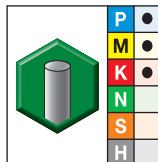
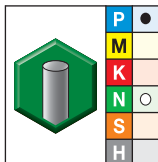
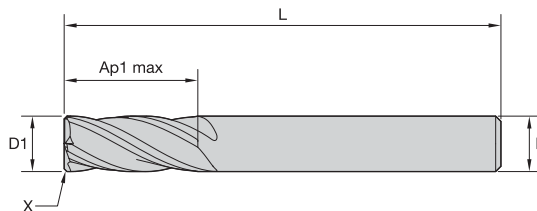
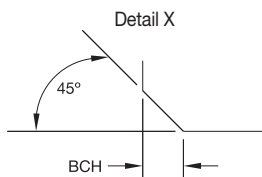

- first choice
- alternate choice

TiAlN		UNCOATED		TiAlN		D1	D	length of cut Ap1 max	length L	BCH	Z U
order #	catalogue #	order #	catalogue #	order #	catalogue #						
5825894	D0040200T004	—	—	—	—	2,0	6	4,00	50	—	4
5825895	D0140200T007	—	—	—	—	2,0	6	7,00	57	—	4
5825896	D0140250T008	—	—	—	—	2,5	6	8,00	57	—	4
5825897	D0040300T005	—	—	—	—	3,0	6	5,00	50	—	4
5825898	D0140300T008	—	—	—	—	3,0	6	8,00	57	—	4
5825899	D0140350T010	—	—	—	—	3,5	6	10,00	57	—	4
5825900	D0040400T008	—	—	—	—	4,0	6	8,00	54	0,10	4
6085348	D0040400T008S	—	—	—	—	4,0	6	8,00	54	—	4
6085349	D0140400T011S	—	—	—	—	4,0	6	11,00	57	—	4
5825931	D0140400T011	—	—	—	—	4,0	6	11,00	57	0,10	4
6085350	D0140450T011S	—	—	—	—	4,5	6	11,00	57	—	4
5825932	D0140450T011	—	—	—	—	4,5	6	11,00	57	0,10	4
6085361	D0040500T009S	—	—	—	—	5,0	6	9,00	54	—	4
5825933	D0040500T009	—	—	—	—	5,0	6	9,00	54	0,10	4
6085362	D0140500T013S	—	—	—	—	5,0	6	13,00	57	—	4
5825934	D0140500T013	—	—	—	—	5,0	6	13,00	57	0,10	4
6085363	D0140550T013S	—	—	—	—	5,5	6	13,00	57	—	4
5825935	D0140550T013	—	—	—	—	5,5	6	13,00	57	0,10	4
6085364	D0040600T010S	—	—	—	—	6,0	6	10,00	54	—	4
5825936	D0040600T010	—	—	—	—	6,0	6	10,00	54	0,10	4
6085365	D0140600T013S	—	—	—	—	6,0	6	13,00	57	—	4
5825937	D0140600T013	—	—	—	—	6,0	6	13,00	57	0,10	4
6085366	D0140650T016S	—	—	—	—	6,5	8	16,00	63	—	4
5825938	D0140650T016	—	—	—	—	6,5	8	16,00	63	0,10	4
6085367	D0040700T011S	—	—	—	—	7,0	8	11,00	58	—	4
5825939	D0040700T011	—	—	—	—	7,0	8	11,00	58	0,10	4
6085368	D0140700T016S	—	—	—	—	7,0	8	16,00	63	—	4
5825940	D0140700T016	—	—	—	—	7,0	8	16,00	63	0,10	4
6085369	D0140750T019S	—	—	—	—	7,5	8	19,00	63	—	4
5825941	D0140750T019	—	—	—	—	7,5	8	19,00	63	0,10	4
6085370	D0040800T012S	—	—	—	—	8,0	8	12,00	58	—	4
5825942	D0040800T012	—	—	—	—	8,0	8	12,00	58	0,20	4
6085371	D0140800T019S	—	—	—	—	8,0	8	19,00	63	—	4
5825943	D0140800T019	—	—	—	—	8,0	8	19,00	63	0,20	4
6085372	D0040900T013S	—	—	—	—	9,0	10	13,00	66	—	4
5825944	D0040900T013	—	—	—	—	9,0	10	13,00	66	0,20	4
6085373	D0140900T019S	—	—	—	—	9,0	10	19,00	72	—	4
5825945	D0140900T019	—	—	—	—	9,0	10	19,00	72	0,20	4
6085374	D0041000T014S	—	—	—	—	10,0	10	14,00	66	—	4
5825946	D0041000T014	—	—	—	—	10,0	10	14,00	66	0,20	4
6085375	D0141000T022S	—	—	—	—	10,0	10	22,00	72	—	4
5825947	D0141000T022	—	—	—	—	10,0	10	22,00	72	0,20	4
6085376	D0041200T016S	6085406	D0041200W016S	6085396	D0041200W016S	12,0	12	16,00	73	—	4
5825948	D0041200T016	—	—	5825958	D0041200W016	12,0	12	16,00	73	0,30	4
6085377	D0141200T026S	—	—	6085397	D0141200W026S	12,0	12	26,00	83	—	4
5825949	D0141200T026	5825969	D0141200W026	5825959	D0141200W026	12,0	12	26,00	83	0,30	4
—	—	—	—	6085407	D0141200W026S	12,0	12	26,00	83	—	4
6085378	D0041400T018S	—	—	—	—	14,0	14	18,00	75	—	4
5825950	D0041400T018	5825970	D0041400W018	5825960	D0041400W018	14,0	14	18,00	75	0,30	4
6085379	D0141400T026S	—	—	6085399	D0141400W026S	14,0	14	26,00	83	—	4
5825951	D0141400T026	—	—	5825961	D0141400W026	14,0	14	26,00	83	0,30	4
—	—	—	—	6085409	D0141400W026S	14,0	14	26,00	83	—	4

General-Purpose Solid Carbide End Mills

GP End Mills • Series D004 D014 • Square End • 4 Flute • Metric DIN 6527

INDEXABLE MILLING

SOLID END MILLING

HOLEMAKING

TAPPING

TURNING

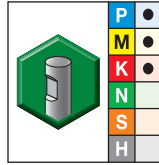
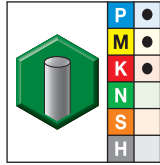
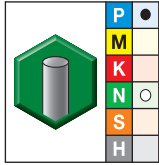
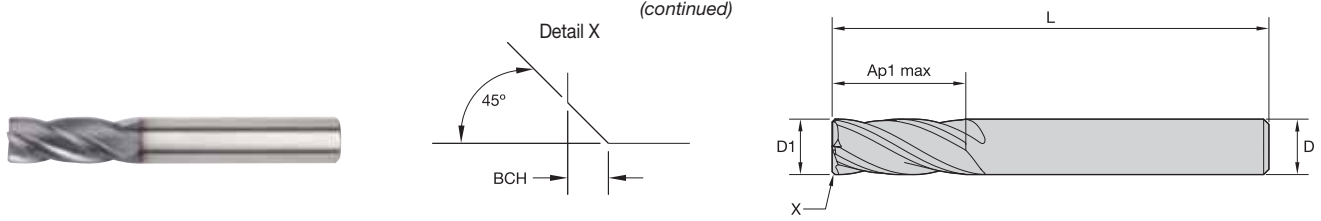

- first choice
- alternate choice

TiAlN		UNCOATED		TiAlN		D1	D	length of cut Ap1 max	length L	BCH	Z U
order #	catalogue #	order #	catalogue #	order #	catalogue #						
6085380	D0041600T022S	6085410	D0041600W022S	6085400	D0041600W022S	16,0	16	22,00	82	—	4
5825952	D0041600T022	5825972	D0041600W022	5825962	D0041600W022	16,0	16	22,00	82	0,30	4
6085391	D0141600T032S	6085421	D0141600W032S	6085401	D0141600W032S	16,0	16	32,00	92	—	4
5825953	D0141600T032	5825973	D0141600W032	5825963	D0141600W032	16,0	16	32,00	92	0,30	4
6085392	D0041800T024S	6086478	D0041800W024S	6085402	D0041800W024S	18,0	18	24,00	84	—	4
5825954	D0041800T024	—	—	5825964	D0041800W024	18,0	18	24,00	84	0,30	4
6085393	D0141800T032S	—	—	6085403	D0141800W032S	18,0	18	32,00	92	—	4
5825955	D0141800T032	—	—	5825965	D0141800W032	18,0	18	32,00	92	0,30	4
6085394	D0042000T026S	—	—	6085404	D0042000W026S	20,0	20	26,00	92	—	4
5825956	D0042000T026	5825976	D0042000W026	5825966	D0042000W026	20,0	20	26,00	92	0,30	4
6085395	D0142000T038S	6086491	D0142000W038S	6085405	D0142000W038S	20,0	20	38,00	104	—	4
5825957	D0142000T038	5825977	D0142000W038	5825967	D0142000W038	20,0	20	38,00	104	0,30	4

NOTE: For application data, please see pages B52–B54.

GP End Mills • Series 2528 • Square End • 4 Flute • Metric DIN 6528

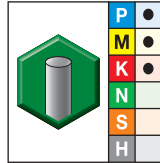
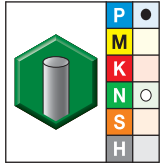
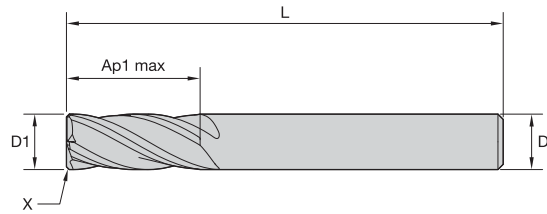
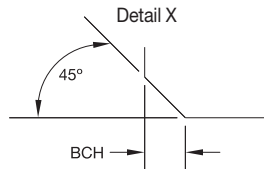

- first choice
- alternate choice

UNCOATED		TiAlN		D1	D	length of cut Ap1 max	length L	BCH	Z U
order #	catalogue #	order #	catalogue #						
—	—	6086492	25280400T011S	4,0	4	11,00	50	—	4
—	—	5825978	25280400T011	4,0	4	11,00	50	0,10	4
—	—	6086493	25280500T013S	5,0	5	13,00	50	—	4
—	—	5825979	25280500T013	5,0	5	13,00	50	0,10	4
6086509	25280600T013S	6086494	25280600T013S	6,0	6	13,00	57	—	4
—	—	5825980	25280600T013	6,0	6	13,00	57	0,10	4
—	—	6086495	25280800T019S	8,0	8	19,00	63	—	4
—	—	5825981	25280800T019	8,0	8	19,00	63	0,20	4
—	—	6086496	25281000T022S	10,0	10	22,00	72	—	4
—	—	5825982	25281000T022	10,0	10	22,00	72	0,20	4
—	—	6086497	25281200T026S	12,0	12	26,00	83	—	4
—	—	5825983	25281200T026	12,0	12	26,00	83	0,30	4
—	—	6086498	25281400T026S	14,0	14	26,00	83	—	4
—	—	5825984	25281400T026	14,0	14	26,00	83	0,30	4
—	—	6086499	25281600T032S	16,0	16	32,00	92	—	4
—	—	5825985	25281600T032	16,0	16	32,00	92	0,30	4
—	—	6086500	25281800T032S	18,0	18	32,00	92	—	4
—	—	5825986	25281800T032	18,0	18	32,00	92	0,30	4
—	—	6086501	25282000T038S	20,0	20	38,00	104	—	4
—	—	5825987	25282000T038	20,0	20	38,00	104	0,30	4

NOTE: For application data, please see pages B52–B54.

General-Purpose Solid Carbide End Mills

GP End Mills • Series 4000 4010 • Ball Nose • 4 Flute • Metric

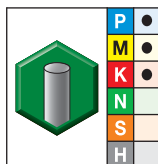
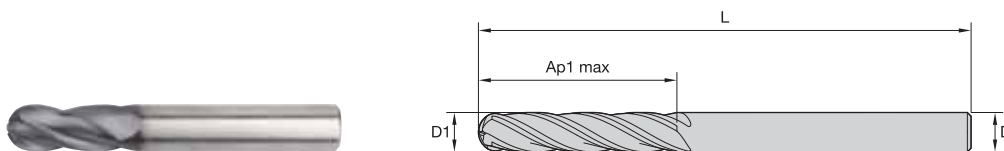

- first choice
- alternate choice

TIAlN		D1	D	length of cut Ap1 max	length L	Z U
5825555	40000200T006	2,0	3	6,30	38	4
6231685	40000300T009	3,0	3	9,50	38	4
6232637	40100300T019	3,0	3	19,00	63	4
5825556	40000300T020	3,0	3	20,00	75	4
5825557	40000400T014	4,0	4	14,00	50	4
5825558	40100400T025	4,0	4	25,00	75	4
5825559	40000500T016	5,0	5	16,00	50	4
5825560	40100500T030	5,0	5	30,00	75	4
5825573	40000600T016	6,0	6	16,00	50	4
5825574	40100600T019	6,0	6	19,00	63	4
5825575	40100600T030	6,0	6	30,00	75	4
5825576	40000800T019	8,0	8	19,00	63	4
6232638	40100800T028	8,0	8	28,00	76	4
5825577	40100800T040	8,0	8	40,00	100	4
5825578	40001000T022	10,0	10	22,00	72	4
6232639	40101000T032	10,0	10	32,00	89	4
5825579	40101000T040	10,0	10	40,00	100	4
5825580	40001200T025	12,0	12	25,00	75	4
5825581	40101200T045	12,0	12	45,00	150	4
6232640	40101200T046	12,0	12	46,00	100	4
6232671	40101200T075	12,0	12	75,00	150	4
5825583	40001400T032	14,0	14	32,00	83	4
5825584	40101400T050	14,0	14	50,00	100	4
5825585	40001600T032	16,0	16	32,00	89	4
5825586	40101600T065	16,0	16	65,00	150	4
5825588	40102000T056	20,0	20	56,00	125	4
6232672	40102000T075	20,0	20	75,00	150	4

NOTE: For application data, please see pages B53–B54.

INDEXABLE MILLING

SOLID END MILLING

HOLEMAKING

TAPPING

TURNING

GP End Mills • Series D010 • Ball Nose • 4 Flute • Metric DIN 6527

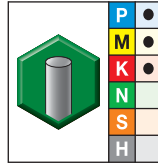
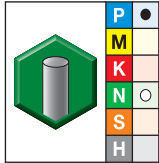
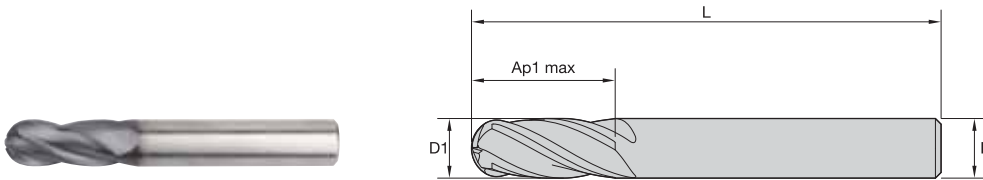

- first choice
- alternate choice

UNCOATED		TiAlN		D1	D	length of cut Ap1 max	length L	Z U
order #	catalogue #	order #	catalogue #					
5825604	D0100300T008	5825527	D0100300T008	3,0	6	8,00	57	4
5825605	D0100400T011	5825528	D0100400T011	4,0	6	11,00	57	4
5825607	D0100600T013	5825529	D0100500T013	5,0	6	13,00	57	4
5825608	D0100800T019	5825530	D0100600T013	6,0	6	13,00	57	4
5825609	D0101000T022	5825531	D0100800T019	8,0	8	19,00	63	4
5825610	D0101200T026	5825532	D0101000T022	10,0	10	22,00	72	4
5825589	D0101200W026	5825533	D0101200T026	12,0	12	26,00	83	4
5825611	D0101400T026	5825540	D0101200W026	12,0	12	26,00	83	4
5825590	D0101400W026	5825534	D0101400T026	14,0	14	26,00	83	4
5825612	D0101600T032	5825541	D0101400W026	14,0	14	26,00	83	4
5825613	D0101800T032	5825536	D0101600T032	16,0	16	32,00	92	4
5825593	D0102000W038	5825542	D0101600W032	16,0	16	32,00	92	4
5825614	D0102000T038	5825538	D0101800T032	18,0	18	32,00	92	4
5825593	D0102000W038	5825543	D0101800W032	18,0	18	32,00	92	4
		5825539	D0102000T038	20,0	20	38,00	104	4
		5825544	D0102000W038	20,0	20	38,00	104	4

NOTE: For application data, please see page B53.

General-Purpose Solid Carbide End Mills

GP End Mills • Series 2848 • Ball Nose • 4 Flute • Metric DIN 6528

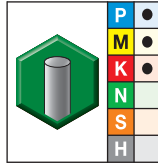
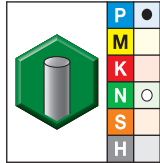
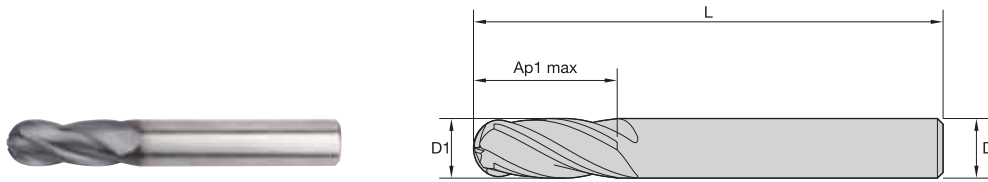

● first choice
○ alternate choice

UNCOATED		TiAlN		D1	D	length of cut Ap1 max	length L	Z U
order #	catalogue #	order #	catalogue #					
—	—	5825545	28480400T011	4,0	4	11,00	50	4
—	—	5825546	28480500T013	5,0	5	13,00	50	4
—	—	5825547	28480600T013	6,0	6	13,00	57	4
5825597	28480800T019	5825548	28480800T019	8,0	8	19,00	63	4
—	—	5825549	28481000T022	10,0	10	22,00	72	4
—	—	5825550	28481200T026	12,0	12	26,00	83	4
—	—	5825551	28481400T026	14,0	14	26,00	83	4
—	—	5825552	28481600T032	16,0	16	32,00	92	4
—	—	5825553	28481800T032	18,0	18	32,00	92	4
—	—	5825554	28482000T038	20,0	20	38,00	104	4

NOTE: For application data, please see pages B53.

INDEXABLE MILLING

SOLID END MILLING

HOLEMAKING

TAPPING

TURNING

GP End Mills • Series D002 4002 • Application Data • Uncoated • Metric

Material Group	Side Milling (A) and Slotting (B)		Uncoated		Recommended feed per tooth (fz = mm/th) for side milling (A). For slotting (B), reduce fz by 20%.													
	A		B		Cutting Speed – vc m/min		D1 – Diameter											
	ap	ae	ap	min	max	mm	2,0	3,0	4,0	6,0	8,0	10,0	12,0	16,0	20,0			
P	0	0,1 x D	0,1 x D	0,5 x D	120	–	160	fz	0,014	0,021	0,028	0,044	0,060	0,072	0,083	0,101	0,114	
	1	0,1 x D	0,1 x D	0,5 x D	120	–	160	fz	0,014	0,021	0,028	0,044	0,060	0,072	0,083	0,101	0,114	
	2	0,1 x D	0,1 x D	0,5 x D	112	–	152	fz	0,014	0,021	0,028	0,044	0,060	0,072	0,083	0,101	0,114	
N	1	Ap1 max	0,1 x D	0,5 x D	400	–	1600	fz	0,020	0,030	0,040	0,060	0,080	0,100	0,120	0,160	0,200	
	2	Ap1 max	0,1 x D	0,5 x D	400	–	1200	fz	0,016	0,024	0,032	0,048	0,064	0,080	0,096	0,128	0,160	
	4	Ap1 max	0,1 x D	0,5 x D	320	–	600	fz	0,014	0,021	0,028	0,042	0,056	0,070	0,084	0,112	0,140	

NOTE: Lower value of cutting speed is used for high stock removal applications or for higher hardness (machinability) within group.
Higher value of cutting speed is used for finishing applications or for lower hardness (machinability) within group.
Above parameters are based on ideal conditions. For smaller taper machining centers, please adjust parameters accordingly on >12mm diameters.

GP End Mills • Series 4011 4021 • Application Data • Uncoated • Metric

Material Group	Side Milling (A)		Uncoated		Recommended feed per tooth (fz = mm/th) for side milling (A).										
	A		Cutting Speed – vc m/min		D1 – Diameter										
	ap	ae	min	max	mm	3,0	4,0	6,0	8,0	10,0	12,0	16,0	20,0		
P	0	Ap1 max	0,1 x D	120	–	160	fz	0,021	0,028	0,044	0,060	0,072	0,083	0,101	0,114
	1	Ap1 max	0,1 x D	120	–	160	fz	0,021	0,028	0,044	0,060	0,072	0,083	0,101	0,114
	2	Ap1 max	0,1 x D	112	–	152	fz	0,021	0,028	0,044	0,060	0,072	0,083	0,101	0,114
N	1	Ap1 max	0,1 x D	400	–	1600	fz	0,030	0,040	0,060	0,080	0,100	0,120	0,160	0,200
	2	Ap1 max	0,1 x D	400	–	1200	fz	0,024	0,032	0,048	0,064	0,080	0,096	0,128	0,160
	4	Ap1 max	0,1 x D	320	–	600	fz	0,021	0,028	0,042	0,056	0,070	0,084	0,112	0,140

NOTE: Lower value of cutting speed is used for high stock removal applications or for higher hardness (machinability) within group.
Higher value of cutting speed is used for finishing applications or for lower hardness (machinability) within group.
Above parameters are based on ideal conditions.
For smaller taper machining centers, please adjust parameters accordingly on >12mm diameters.

GP End Mills • Series D012 2819 4012 4022 • Application Data • Uncoated • Metric

Material Group	Side Milling (A)		Uncoated		Recommended feed per tooth (fz = mm/th) for side milling (A).										
	A		Cutting Speed – vc m/min		D1 – Diameter										
	ap	ae	min	max	mm	3,0	4,0	6,0	8,0	10,0	12,0	16,0	20,0		
P	0	Ap1 max	0,1 x D	120	–	160	fz	0,021	0,028	0,044	0,060	0,072	0,083	0,101	0,114
	1	Ap1 max	0,1 x D	120	–	160	fz	0,021	0,028	0,044	0,060	0,072	0,083	0,101	0,114
	2	Ap1 max	0,1 x D	112	–	152	fz	0,021	0,028	0,044	0,060	0,072	0,083	0,101	0,114
N	1	Ap1 max	0,1 x D	400	–	1600	fz	0,030	0,040	0,060	0,080	0,100	0,120	0,160	0,200
	2	Ap1 max	0,1 x D	400	–	1200	fz	0,024	0,032	0,048	0,064	0,080	0,096	0,128	0,160
	4	Ap1 max	0,1 x D	320	–	600	fz	0,021	0,028	0,042	0,056	0,070	0,084	0,112	0,140

NOTE: Lower value of cutting speed is used for high stock removal applications or for higher hardness (machinability) within group.
Higher value of cutting speed is used for finishing applications or for lower hardness (machinability) within group.
Above parameters are based on ideal conditions. For smaller taper machining centers, please adjust parameters accordingly on >12mm diameters.

GP End Mills • Series D001 4001 • Application Data • Uncoated • Metric

Material Group	Side Milling (A) and Slotting (B)		Uncoated		Recommended feed per tooth (fz = mm/th) for side milling (A). For slotting (B), reduce fz by 20%.																
	A		B		Cutting Speed – vc m/min			D1 – Diameter													
	ap	ae	ap	min	max	mm	1,0	2,0	3,0	4,0	6,0	8,0	10,0	12,0	16,0	20,0					
	P	0	Ap1 max	0,1 x D	0,5 x D	120	–	160	fz	0,007	0,014	0,021	0,028	0,044	0,060	0,072	0,083	0,101	0,114		
	1	Ap1 max	0,1 x D	0,5 x D	120	–	160	fz	0,007	0,014	0,021	0,028	0,044	0,060	0,072	0,083	0,101	0,114			
	2	Ap1 max	0,1 x D	0,5 x D	112	–	152	fz	0,007	0,014	0,021	0,028	0,044	0,060	0,072	0,083	0,101	0,114			
N	1	Ap1 max	0,1 x D	0,5 x D	400	–	1600	fz	0,010	0,020	0,030	0,040	0,060	0,080	0,100	0,120	0,160	0,200			
	2	Ap1 max	0,1 x D	0,5 x D	400	–	1200	fz	0,008	0,016	0,024	0,032	0,048	0,064	0,080	0,096	0,128	0,160			
	4	Ap1 max	0,1 x D	0,5 x D	320	–	600	fz	0,007	0,014	0,021	0,028	0,042	0,056	0,070	0,084	0,112	0,140			

NOTE: Lower value of cutting speed is used for high stock removal applications or for higher hardness (machinability) within group.
Higher value of cutting speed is used for finishing applications or for lower hardness (machinability) within group.
Above parameters are based on ideal conditions.
For smaller taper machining centers, please adjust parameters accordingly on >12mm diameters.

GP End Mills • Series D002 4002 • Application Data • TiAlN • Metric

Material Group	Side Milling (A) and Slotting (B)		TiAlN		Recommended feed per tooth (fz = mm/th) for side milling (A). For slotting (B), reduce fz by 20%.																
	A		B		Cutting Speed – vc m/min			D1 – Diameter													
	ap	ae	ap	min	max	mm	1,0	2,0	3,0	4,0	5,0	6,0	8,0	10,0	12,0	14,0	16,0	18,0	20,0		
	P	0	Ap1 max	0,1 x D	0,5 x D	150	–	200	fz	0,007	0,014	0,021	0,028	0,036	0,044	0,060	0,072	0,083	0,092	0,101	0,108
	1	Ap1 max	0,1 x D	0,5 x D	150	–	200	fz	0,007	0,014	0,021	0,028	0,036	0,044	0,060	0,072	0,083	0,092	0,101	0,108	0,114
	2	Ap1 max	0,1 x D	0,5 x D	140	–	190	fz	0,007	0,014	0,021	0,028	0,036	0,044	0,060	0,072	0,083	0,092	0,101	0,108	0,114
	3	Ap1 max	0,1 x D	0,5 x D	120	–	160	fz	0,006	0,011	0,017	0,023	0,030	0,036	0,050	0,061	0,070	0,079	0,087	0,095	0,101
	4	Ap1 max	0,1 x D	0,5 x D	90	–	150	fz	0,005	0,010	0,016	0,021	0,027	0,033	0,045	0,054	0,062	0,070	0,077	0,083	0,088
M	1	Ap1 max	0,1 x D	0,5 x D	90	–	115	fz	0,006	0,011	0,017	0,023	0,030	0,036	0,050	0,061	0,070	0,079	0,087	0,095	0,101
	2	Ap1 max	0,1 x D	0,5 x D	60	–	80	fz	0,005	0,009	0,014	0,019	0,024	0,029	0,040	0,048	0,056	0,063	0,070	0,076	0,081
K	1	Ap1 max	0,1 x D	0,5 x D	120	–	150	fz	0,007	0,014	0,021	0,028	0,036	0,044	0,060	0,072	0,083	0,092	0,101	0,108	0,114
	2	Ap1 max	0,1 x D	0,5 x D	110	–	140	fz	0,006	0,011	0,017	0,023	0,030	0,036	0,050	0,061	0,070	0,079	0,087	0,095	0,101

NOTE: Lower value of cutting speed is used for high stock removal applications or for higher hardness (machinability) within group.
Higher value of cutting speed is used for finishing applications or for lower hardness (machinability) within group.
Above parameters are based on ideal conditions. For smaller taper machining centers, please adjust parameters accordingly on >12mm diameters.

GP End Mills • Series 4011 4021 • Application Data • TiAlN • Metric

Material Group	Side Milling (A)		TiAlN		Recommended feed per tooth (fz = mm/th) for side milling (A).																
	A		Cutting Speed – vc m/min			mm	D1 – Diameter														
	ap	ae	min	max	2,0		3,0	4,0	5,0	6,0	8,0	10,0	12,0	14,0	16,0	18,0	20,0				
	0	1	2	3	4	1	2	1	2	1	2	1	2	1	2	1	2				
P	0	Ap1 max	0,1 x D	150	–	200	fz	0,014	0,021	0,028	0,036	0,044	0,060	0,072	0,083	0,092	0,101	0,108	0,114		
	1	Ap1 max	0,1 x D	150	–	200	fz	0,014	0,021	0,028	0,036	0,044	0,060	0,072	0,083	0,092	0,101	0,108	0,114		
	2	Ap1 max	0,1 x D	140	–	190	fz	0,014	0,021	0,028	0,036	0,044	0,060	0,072	0,083	0,092	0,101	0,108	0,114		
	3	Ap1 max	0,1 x D	120	–	160	fz	0,011	0,017	0,023	0,030	0,036	0,050	0,061	0,070	0,079	0,087	0,095	0,101		
	4	Ap1 max	0,1 x D	90	–	150	fz	0,010	0,016	0,021	0,027	0,033	0,045	0,054	0,062	0,070	0,077	0,083	0,088		
M	1	Ap1 max	0,1 x D	90	–	115	fz	0,011	0,017	0,023	0,030	0,036	0,050	0,061	0,070	0,079	0,087	0,095	0,101		
	2	Ap1 max	0,1 x D	60	–	80	fz	0,009	0,014	0,019	0,024	0,029	0,040	0,048	0,056	0,063	0,070	0,076	0,081		
K	1	Ap1 max	0,1 x D	120	–	150	fz	0,014	0,021	0,028	0,036	0,044	0,060	0,072	0,083	0,092	0,101	0,108	0,114		
	2	Ap1 max	0,1 x D	110	–	140	fz	0,011	0,017	0,023	0,030	0,036	0,050	0,061	0,070	0,079	0,087	0,095	0,101		

NOTE: Lower value of cutting speed is used for high stock removal applications or for higher hardness (machinability) within group.

Higher value of cutting speed is used for finishing applications or for lower hardness (machinability) within group.

Above parameters are based on ideal conditions.

For smaller taper machining centers, please adjust parameters accordingly on >12mm diameters.

GP End Mills • Series D012 4012 • Application Data • TiAlN • Metric

Material Group	Side Milling (A)		TiAlN		Recommended feed per tooth (fz = mm/th) for side milling (A).																
	A		Cutting Speed – vc m/min			mm	D1 – Diameter														
	ap	ae	min	max	2,0		3,0	4,0	5,0	6,0	8,0	10,0	12,0	14,0	16,0	18,0	20,0				
	0	1	2	3	4	1	2	1	2	1	2	1	2	1	2	1	2				
P	0	Ap1 max	0,1 x D	150	–	200	fz	0,014	0,021	0,028	0,036	0,044	0,060	0,072	0,083	0,092	0,101	0,108	0,114		
	1	Ap1 max	0,1 x D	150	–	200	fz	0,014	0,021	0,028	0,036	0,044	0,060	0,072	0,083	0,092	0,101	0,108	0,114		
	2	Ap1 max	0,1 x D	140	–	190	fz	0,014	0,021	0,028	0,036	0,044	0,060	0,072	0,083	0,092	0,101	0,108	0,114		
	3	Ap1 max	0,1 x D	120	–	160	fz	0,011	0,017	0,023	0,030	0,036	0,050	0,061	0,070	0,079	0,087	0,095	0,101		
	4	Ap1 max	0,1 x D	90	–	150	fz	0,010	0,016	0,021	0,027	0,033	0,045	0,054	0,062	0,070	0,077	0,083	0,088		
M	1	Ap1 max	0,1 x D	90	–	115	fz	0,011	0,017	0,023	0,030	0,036	0,050	0,061	0,070	0,079	0,087	0,095	0,101		
	2	Ap1 max	0,1 x D	60	–	80	fz	0,009	0,014	0,019	0,024	0,029	0,040	0,048	0,056	0,063	0,070	0,076	0,081		
K	1	Ap1 max	0,1 x D	120	–	150	fz	0,014	0,021	0,028	0,036	0,044	0,060	0,072	0,083	0,092	0,101	0,108	0,114		
	2	Ap1 max	0,1 x D	110	–	140	fz	0,011	0,017	0,023	0,030	0,036	0,050	0,061	0,070	0,079	0,087	0,095	0,101		

NOTE: Lower value of cutting speed is used for high stock removal applications or for higher hardness (machinability) within group.

Higher value of cutting speed is used for finishing applications or for lower hardness (machinability) within group.

Above parameters are based on ideal conditions. For smaller taper machining centers, please adjust parameters accordingly on >12mm diameters.

General-Purpose Solid Carbide End Mills

INDEXABLE MILLING

SOLID END MILLING

HOLEMAKING

TAPPING

TURNING

GP End Mills • Series D001 D011 2838 4001 • Application Data • TiAlN • Metric

Material Group	Side Milling (A) and Slotting (B)		TiAlN		Recommended feed per tooth (fz = mm/th) for side milling (A). For slotting (B), reduce fz by 20%.																
	A		B		Cutting Speed – vc m/min		D1 – Diameter														
	ap	ae	ap		min	max	mm	1,0	2,0	3,0	4,0	5,0	6,0	8,0	10,0	12,0	14,0	16,0	18,0	20,0	
P	0	Ap1 max	0,1 x D	0,5 x D	150	–	200	fz	0,007	0,014	0,021	0,028	0,036	0,044	0,060	0,072	0,083	0,092	0,101	0,108	0,114
	1	Ap1 max	0,1 x D	0,5 x D	150	–	200	fz	0,007	0,014	0,021	0,028	0,036	0,044	0,060	0,072	0,083	0,092	0,101	0,108	0,114
	2	Ap1 max	0,1 x D	0,5 x D	140	–	190	fz	0,007	0,014	0,021	0,028	0,036	0,044	0,060	0,072	0,083	0,092	0,101	0,108	0,114
	3	Ap1 max	0,1 x D	0,5 x D	120	–	160	fz	0,006	0,011	0,017	0,023	0,030	0,036	0,050	0,061	0,070	0,079	0,087	0,095	0,101
M	4	Ap1 max	0,1 x D	0,5 x D	90	–	150	fz	0,005	0,010	0,016	0,021	0,027	0,033	0,045	0,054	0,062	0,070	0,077	0,083	0,088
	1	Ap1 max	0,1 x D	0,5 x D	90	–	115	fz	0,006	0,011	0,017	0,023	0,030	0,036	0,050	0,061	0,070	0,079	0,087	0,095	0,101
K	2	Ap1 max	0,1 x D	0,5 x D	60	–	80	fz	0,005	0,009	0,014	0,019	0,024	0,029	0,040	0,048	0,056	0,063	0,070	0,076	0,081
	1	Ap1 max	0,1 x D	0,5 x D	120	–	150	fz	0,007	0,014	0,021	0,028	0,036	0,044	0,060	0,072	0,083	0,092	0,101	0,108	0,114
	2	Ap1 max	0,1 x D	0,5 x D	110	–	140	fz	0,006	0,011	0,017	0,023	0,030	0,036	0,050	0,061	0,070	0,079	0,087	0,095	0,101



NOTE: Lower value of cutting speed is used for high stock removal applications or for higher hardness (machinability) within group.
Higher value of cutting speed is used for finishing applications or for lower hardness (machinability) within group.
Above parameters are based on ideal conditions.
For smaller taper machining centers, please adjust parameters accordingly on >12mm diameters.

GP End Mills • Series 4013..S 4013 • Application Data • Uncoated • Metric

Material Group	Side Milling (A)		Uncoated		Recommended feed per tooth (fz = mm/th) for side milling (A).														
	A		Cutting Speed – vc m/min		D1 – Diameter														
	ap	ae	min	max	mm	3,0	4,0	6,0	8,0	10,0	12,0	16,0	20,0						
P	0	Ap1 max	0,1 x D	120	–	160	fz	0,021	0,028	0,044	0,060	0,072	0,083	0,101	0,114				
	1	Ap1 max	0,1 x D	120	–	160	fz	0,021	0,028	0,044	0,060	0,072	0,083	0,101	0,114				
	2	Ap1 max	0,1 x D	112	–	152	fz	0,021	0,028	0,044	0,060	0,072	0,083	0,101	0,114				
N	1	Ap1 max	0,1 x D	400	–	1600	fz	0,030	0,040	0,060	0,080	0,100	0,120	0,160	0,200				
	2	Ap1 max	0,1 x D	400	–	1200	fz	0,024	0,032	0,048	0,064	0,080	0,096	0,128	0,160				
	4	Ap1 max	0,1 x D	320	–	600	fz	0,021	0,028	0,042	0,056	0,070	0,084	0,112	0,140				



NOTE: Lower value of cutting speed is used for high stock removal applications or for higher hardness (machinability) within group.
Higher value of cutting speed is used for finishing applications or for lower hardness (machinability) within group.
Above parameters are based on ideal conditions. For smaller taper machining centers, please adjust parameters accordingly on diameters >12mm.

GP End Mills • Series D003..S D013..S D003 D013 4003..S 4003 • Application Data • Uncoated • Metric

																				
		Side Milling (A)	Uncoated			Recommended feed per tooth (fz = mm/th) for side milling (A).														
Material Group		A	Cutting Speed – vc m/min			mm	D1 – Diameter													
			ap	ae	min		max	3,0	4,0	6,0	8,0	10,0	12,0	16,0	20,0					
P	0	Ap1 max	0,1 x D	120	–	160	fz	0,021	0,028	0,044	0,060	0,072	0,083	0,101	0,114					
	1	Ap1 max	0,1 x D	120	–	160	fz	0,021	0,028	0,044	0,060	0,072	0,083	0,101	0,114					
	2	Ap1 max	0,1 x D	112	–	152	fz	0,021	0,028	0,044	0,060	0,072	0,083	0,101	0,114					
N	1	Ap1 max	0,1 x D	400	–	1600	fz	0,030	0,040	0,060	0,080	0,100	0,120	0,160	0,200					
	2	Ap1 max	0,1 x D	400	–	1200	fz	0,024	0,032	0,048	0,064	0,080	0,096	0,128	0,160					
	4	Ap1 max	0,1 x D	320	–	600	fz	0,021	0,028	0,042	0,056	0,070	0,084	0,112	0,140					

NOTE: Lower value of cutting speed is used for high stock removal applications or for higher hardness (machinability) within group.
Higher value of cutting speed is used for finishing applications or for lower hardness (machinability) within group.
Above parameters are based on ideal conditions. For smaller taper machining centers, please adjust parameters accordingly on diameters >12mm.

GP End Mills • Series 4013..S 4013 • Application Data • TiAlN • Metric

																				
		Side Milling (A)	TiAlN			Recommended feed per tooth (fz = mm/th) for side milling (A).														
Material Group		A	Cutting Speed – vc m/min			mm	D1 – Diameter													
			ap	ae	min		max	1,0	2,0	3,0	4,0	5,0	6,0	8,0	10,0	12,0	14,0	16,0	18,0	20,0
P	0	Ap1 max	0,1 x D	150	–	200	fz	0,007	0,014	0,021	0,028	0,036	0,044	0,060	0,072	0,083	0,092	0,101	0,108	0,114
	1	Ap1 max	0,1 x D	150	–	200	fz	0,007	0,014	0,021	0,028	0,036	0,044	0,060	0,072	0,083	0,092	0,101	0,108	0,114
	2	Ap1 max	0,1 x D	140	–	190	fz	0,007	0,014	0,021	0,028	0,036	0,044	0,060	0,072	0,083	0,092	0,101	0,108	0,114
	3	Ap1 max	0,1 x D	120	–	160	fz	0,006	0,011	0,017	0,023	0,030	0,036	0,050	0,061	0,070	0,079	0,087	0,095	0,101
M	1	Ap1 max	0,1 x D	90	–	150	fz	0,005	0,010	0,016	0,021	0,027	0,033	0,045	0,054	0,062	0,070	0,077	0,083	0,088
	2	Ap1 max	0,1 x D	60	–	80	fz	0,005	0,009	0,014	0,019	0,024	0,029	0,040	0,048	0,056	0,063	0,070	0,076	0,081
K	1	Ap1 max	0,1 x D	120	–	150	fz	0,007	0,014	0,021	0,028	0,036	0,044	0,060	0,072	0,083	0,092	0,101	0,108	0,114
	2	Ap1 max	0,1 x D	110	–	140	fz	0,006	0,011	0,017	0,023	0,030	0,036	0,050	0,061	0,070	0,079	0,087	0,095	0,101

NOTE: Lower value of cutting speed is used for high stock removal applications or for higher hardness (machinability) within group.
Higher value of cutting speed is used for finishing applications or for lower hardness (machinability) within group.
Above parameters are based on ideal conditions. For smaller taper machining centers, please adjust parameters accordingly on diameters >12mm.

General-Purpose Solid Carbide End Mills

GP End Mills • Series D003..S D013..S D003 D013 4003..S 4003 • Application Data • TiAlN • Metric

Material Group	Side Milling (A) and Slotting (B)		TiAlN		Recommended feed per tooth (fz = mm/th) for side milling (A). For slotting (B), reduce fz by 20%.																
	A		B		Cutting Speed – vc m/min			D1 – Diameter													
	ap	ae	ap		min	max	mm	1,0	2,0	3,0	4,0	5,0	6,0	8,0	10,0	12,0	14,0	16,0	18,0	20,0	
	P	0	Ap1 max 0,1 x D	0,5 x D		150	–	200	fz	0,007	0,014	0,021	0,028	0,036	0,044	0,060	0,072	0,083	0,092	0,101	0,108
	1	Ap1 max 0,1 x D	0,5 x D		150	–	200	fz	0,007	0,014	0,021	0,028	0,036	0,044	0,060	0,072	0,083	0,092	0,101	0,108	0,114
	2	Ap1 max 0,1 x D	0,5 x D		140	–	190	fz	0,007	0,014	0,021	0,028	0,036	0,044	0,060	0,072	0,083	0,092	0,101	0,108	0,114
	3	Ap1 max 0,1 x D	0,5 x D		120	–	160	fz	0,006	0,011	0,017	0,023	0,030	0,036	0,050	0,061	0,070	0,079	0,087	0,095	0,101
	4	Ap1 max 0,1 x D	0,5 x D		90	–	150	fz	0,005	0,010	0,016	0,021	0,027	0,033	0,045	0,054	0,062	0,070	0,077	0,083	0,088
M	1	Ap1 max 0,1 x D	0,5 x D		90	–	115	fz	0,006	0,011	0,017	0,023	0,030	0,036	0,050	0,061	0,070	0,079	0,087	0,095	0,101
	2	Ap1 max 0,1 x D	0,5 x D		60	–	80	fz	0,005	0,009	0,014	0,019	0,024	0,029	0,040	0,048	0,056	0,063	0,070	0,076	0,081
K	1	Ap1 max 0,1 x D	0,5 x D		120	–	150	fz	0,007	0,014	0,021	0,028	0,036	0,044	0,060	0,072	0,083	0,092	0,101	0,108	0,114
	2	Ap1 max 0,1 x D	0,5 x D		110	–	140	fz	0,006	0,011	0,017	0,023	0,030	0,036	0,050	0,061	0,070	0,079	0,087	0,095	0,101

NOTE: Lower value of cutting speed is used for high stock removal applications or for higher hardness (machinability) within group.
Higher value of cutting speed is used for finishing applications or for lower hardness (machinability) within group.
Above parameters are based on ideal conditions. For smaller taper machining centers, please adjust parameters accordingly on diameters >12mm.

GP End Mills • Series 4004 4014 4024 • Application Data • Uncoated • Metric

Material Group	Side Milling (A) and Slotting (B)		Uncoated		Recommended feed per tooth (fz = mm/th) for side milling (A). For slotting (B), reduce fz by 20%.																
	A		B		Cutting Speed – vc m/min			D1 – Diameter													
	ap	ae	ap		min	max	mm	1,0	2,0	3,0	4,0	6,0	8,0	10,0	12,0	16,0	20,0				
	P	0	Ap1 max 0,1 x D	0,5 x D		120	–	160	fz	0,007	0,014	0,021	0,028	0,044	0,060	0,072	0,083	0,101	0,114		
	1	Ap1 max 0,1 x D	0,5 x D		120	–	160	fz	0,007	0,014	0,021	0,028	0,044	0,060	0,072	0,083	0,101	0,114			
	2	Ap1 max 0,1 x D	0,5 x D		112	–	152	fz	0,007	0,014	0,021	0,028	0,044	0,060	0,072	0,083	0,101	0,114			
N	1	Ap1 max 0,1 x D	0,5 x D		400	–	1600	fz	0,010	0,020	0,030	0,040	0,060	0,080	0,100	0,120	0,160	0,200			
	2	Ap1 max 0,1 x D	0,5 x D		400	–	1200	fz	0,008	0,016	0,024	0,032	0,048	0,064	0,080	0,096	0,128	0,160			
	4	Ap1 max 0,1 x D	0,5 x D		320	–	600	fz	0,007	0,014	0,021	0,028	0,042	0,056	0,070	0,084	0,112	0,140			

NOTE: Lower value of cutting speed is used for high stock removal applications or for higher hardness (machinability) within group.
Higher value of cutting speed is used for finishing applications or for lower hardness (machinability) within group.
Above parameters are based on ideal conditions. For smaller taper machining centers, please adjust parameters accordingly on >12mm diameters.

GP End Mills • Series D014 2528 4014 4024 • Application Data • Uncoated • Metric

Material Group	Side Milling (A)		Uncoated		Recommended feed per tooth (fz = mm/th) for side milling (A).									
	A		Cutting Speed – vc m/min		D1 – Diameter									
	ap	ae	min	max	mm	3,0	4,0	6,0	8,0	10,0	12,0	16,0	20,0	
	P	0	Ap1 max 0,1 x D	120	–	160	fz	0,021	0,028	0,044	0,060	0,072	0,083	0,101
	1	Ap1 max 0,1 x D	120	–	160	fz	0,021	0,028	0,044	0,060	0,072	0,083	0,101	0,114
	2	Ap1 max 0,1 x D	112	–	152	fz	0,021	0,028	0,044	0,060	0,072	0,083	0,101	0,114
N	1	Ap1 max 0,1 x D	400	–	1600	fz	0,030	0,040	0,060	0,080	0,100	0,120	0,160	0,200
	2	Ap1 max 0,1 x D	400	–	1200	fz	0,024	0,032	0,048	0,064	0,080	0,096	0,128	0,160
	4	Ap1 max 0,1 x D	320	–	600	fz	0,021	0,028	0,042	0,056	0,070	0,084	0,112	0,140

NOTE: Lower value of cutting speed is used for high stock removal applications or for higher hardness (machinability) within group.
Higher value of cutting speed is used for finishing applications or for lower hardness (machinability) within group.
Above parameters are based on ideal conditions. For smaller taper machining centers, please adjust parameters accordingly on >12mm diameters.

INDEXABLE MILLING



SOLID END MILLING

HOLEMAKING

TAPPING



TURNING

GP End Mills • Series D010 2848 4010 • Application Data • Uncoated • Metric

Material Group																				
	Side Milling (A) and Slotting (B)			Uncoated			Recommended feed per tooth (fz = mm/th) for side milling (A). For slotting (B), reduce fz by 20%.													
	A		B	Cutting Speed – vc m/min			D1 – Diameter													
	ap	ae	ap	min	–	max	mm	1,0	2,0	3,0	4,0	6,0	8,0	10,0	12,0	16,0	20,0			
P	0	Ap1 max	0,1 x D	0,5 x D	120	–	160	fz	0,007	0,014	0,021	0,028	0,044	0,060	0,072	0,083	0,101	0,114		
	1	Ap1 max	0,1 x D	0,5 x D	120	–	160	fz	0,007	0,014	0,021	0,028	0,044	0,060	0,072	0,083	0,101	0,114		
N	1	Ap1 max	0,1 x D	0,5 x D	400	–	1600	fz	0,010	0,020	0,030	0,040	0,060	0,080	0,100	0,120	0,160	0,200		
	2	Ap1 max	0,1 x D	0,5 x D	400	–	1200	fz	0,008	0,016	0,024	0,032	0,048	0,064	0,080	0,096	0,128	0,160		
	4	Ap1 max	0,1 x D	0,5 x D	320	–	600	fz	0,007	0,014	0,021	0,028	0,042	0,056	0,070	0,084	0,112	0,140		

NOTE: Lower value of cutting speed is used for high stock removal applications or for higher hardness (machinability) within group.
Higher value of cutting speed is used for finishing applications or for lower hardness (machinability) within group.
Above parameters are based on ideal conditions. For smaller taper machining centers, please adjust parameters accordingly on >12mm diameters.

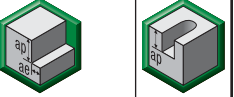
GP End Mills • Series 4004 4014 4024 • Application Data • TiAlN • Metric

Material Group																					
	Side Milling (A) and Slotting (B)			TiAlN			Recommended feed per tooth (fz = mm/th) for side milling (A). For slotting (B), reduce fz by 20%.														
	A		B	Cutting Speed – Vc m/min			D1 – Diameter														
	ap	ae	ap	min	–	max	mm	1,0	2,0	3,0	4,0	5,0	6,0	8,0	10,0	12,0	14,0	16,0	18,0	20,0	
P	0	Ap1 max	0,1 x D	0,5 x D	150	–	200	fz	0,007	0,014	0,021	0,028	0,036	0,044	0,060	0,072	0,083	0,092	0,101	0,108	0,114
	1	Ap1 max	0,1 x D	0,5 x D	150	–	200	fz	0,007	0,014	0,021	0,028	0,036	0,044	0,060	0,072	0,083	0,092	0,101	0,108	0,114
	2	Ap1 max	0,1 x D	0,5 x D	140	–	190	fz	0,007	0,014	0,021	0,028	0,036	0,044	0,060	0,072	0,083	0,092	0,101	0,108	0,114
	3	Ap1 max	0,1 x D	0,5 x D	120	–	160	fz	0,006	0,011	0,017	0,023	0,030	0,036	0,050	0,061	0,070	0,079	0,087	0,095	0,101
	4	Ap1 max	0,1 x D	0,5 x D	90	–	150	fz	0,005	0,010	0,016	0,021	0,027	0,033	0,045	0,054	0,062	0,070	0,077	0,083	0,088
M	1	Ap1 max	0,1 x D	0,5 x D	90	–	115	fz	0,006	0,011	0,017	0,023	0,030	0,036	0,050	0,061	0,070	0,079	0,087	0,095	0,101
	2	Ap1 max	0,1 x D	0,5 x D	60	–	80	fz	0,005	0,009	0,014	0,019	0,024	0,029	0,040	0,048	0,056	0,063	0,070	0,076	0,081
K	1	Ap1 max	0,1 x D	0,5 x D	120	–	150	fz	0,007	0,014	0,021	0,028	0,036	0,044	0,060	0,072	0,083	0,092	0,101	0,108	0,114
	2	Ap1 max	0,1 x D	0,5 x D	110	–	140	fz	0,006	0,011	0,017	0,023	0,030	0,036	0,050	0,061	0,070	0,079	0,087	0,095	0,101

NOTE: Lower value of cutting speed is used for high stock removal applications or for higher hardness (machinability) within group.
Higher value of cutting speed is used for finishing applications or for lower hardness (machinability) within group.
Above parameters are based on ideal conditions. For smaller taper machining centers, please adjust parameters accordingly on greater than 12mm diameters.

General-Purpose Solid Carbide End Mills

GP End Mills • Series 4000 4010 • Application Data • TiAlN • Metric

Material Group	Side Milling (A) and Slotting (B)		TiAlN			Recommended feed per tooth (fz = mm/th) for side milling (A). For slotting (B), reduce fz by 20%.														
	A		B		Cutting Speed – vc m/min	mm	D1 – Diameter													
	ap	ae	ap	min			max	3,0	4,0	5,0	6,0	8,0	10,0	12,0	14,0	16,0	18,0	20,0		
	ap	ae	ap	min	max	fz	0,021	0,028	0,036	0,044	0,060	0,072	0,083	0,092	0,101	0,108	0,114			
P	0	Ap1 max	0,1 x D	0,5 x D	150	–	200	fz	0,021	0,028	0,036	0,044	0,060	0,072	0,083	0,092	0,101	0,108	0,114	
	1	Ap1 max	0,1 x D	0,5 x D	150	–	200	fz	0,021	0,028	0,036	0,044	0,060	0,072	0,083	0,092	0,101	0,108	0,114	
	2	Ap1 max	0,1 x D	0,5 x D	140	–	190	fz	0,021	0,028	0,036	0,044	0,060	0,072	0,083	0,092	0,101	0,108	0,114	
	3	Ap1 max	0,1 x D	0,5 x D	120	–	160	fz	0,017	0,023	0,030	0,036	0,050	0,061	0,070	0,079	0,087	0,095	0,101	
M	1	Ap1 max	0,1 x D	0,5 x D	90	–	150	fz	0,016	0,021	0,027	0,033	0,045	0,054	0,062	0,070	0,077	0,083	0,088	
	2	Ap1 max	0,1 x D	0,5 x D	90	–	115	fz	0,017	0,023	0,030	0,036	0,050	0,061	0,070	0,079	0,087	0,095	0,101	
K	1	Ap1 max	0,1 x D	0,5 x D	60	–	80	fz	0,014	0,019	0,024	0,029	0,040	0,048	0,056	0,063	0,070	0,076	0,081	
	2	Ap1 max	0,1 x D	0,5 x D	120	–	150	fz	0,021	0,028	0,036	0,044	0,060	0,072	0,083	0,092	0,101	0,108	0,114	
K	1	Ap1 max	0,1 x D	0,5 x D	120	–	150	fz	0,021	0,028	0,036	0,044	0,060	0,072	0,083	0,092	0,101	0,108	0,114	
	2	Ap1 max	0,1 x D	0,5 x D	110	–	140	fz	0,017	0,023	0,030	0,036	0,050	0,061	0,070	0,079	0,087	0,095	0,101	

NOTE: Lower value of cutting speed is used for high stock removal applications or for higher hardness (machinability) within group.
Higher value of cutting speed is used for finishing applications or for lower hardness (machinability) within group.
Above parameters are based on ideal conditions. For smaller taper machining centers, please adjust parameters accordingly on >12mm diameters.
Refer to NOVO for slotting application information.

GP End Mills • Series D014 2528 4014 4024 • Application Data • TiAlN • Metric

Material Group	Side Milling (A)		TiAlN			Recommended feed per tooth (fz = mm/th) for side milling (A).													
	A		Cutting Speed – vc m/min		mm	D1 – Diameter													
	ap	ae	min	max		2,0	3,0	4,0	5,0	6,0	8,0	10,0	12,0	14,0	16,0	18,0	20,0		
	ap	ae	min	max	fz	0,014	0,021	0,028	0,036	0,044	0,060	0,072	0,083	0,092	0,101	0,108	0,114		
P	0	Ap1 max	0,1 x D	150	–	200	fz	0,014	0,021	0,028	0,036	0,044	0,060	0,072	0,083	0,092	0,101	0,108	0,114
	1	Ap1 max	0,1 x D	150	–	200	fz	0,014	0,021	0,028	0,036	0,044	0,060	0,072	0,083	0,092	0,101	0,108	0,114
	2	Ap1 max	0,1 x D	140	–	190	fz	0,014	0,021	0,028	0,036	0,044	0,060	0,072	0,083	0,092	0,101	0,108	0,114
	3	Ap1 max	0,1 x D	120	–	160	fz	0,011	0,017	0,023	0,030	0,036	0,050	0,061	0,070	0,079	0,087	0,095	0,101
M	1	Ap1 max	0,1 x D	90	–	150	fz	0,010	0,016	0,021	0,027	0,033	0,045	0,054	0,062	0,070	0,077	0,083	0,088
	2	Ap1 max	0,1 x D	90	–	115	fz	0,011	0,017	0,023	0,030	0,036	0,050	0,061	0,070	0,079	0,087	0,095	0,101
K	1	Ap1 max	0,1 x D	60	–	80	fz	0,009	0,014	0,019	0,024	0,029	0,040	0,048	0,056	0,063	0,070	0,076	0,081
	2	Ap1 max	0,1 x D	120	–	150	fz	0,014	0,021	0,028	0,036	0,044	0,060	0,072	0,083	0,092	0,101	0,108	0,114
K	1	Ap1 max	0,1 x D	120	–	150	fz	0,014	0,021	0,028	0,036	0,044	0,060	0,072	0,083	0,092	0,101	0,108	0,114
	2	Ap1 max	0,1 x D	110	–	140	fz	0,011	0,017	0,023	0,030	0,036	0,050	0,061	0,070	0,079	0,087	0,095	0,101

NOTE: Lower value of cutting speed is used for high stock removal applications or for higher hardness (machinability) within group.
Higher value of cutting speed is used for finishing applications or for lower hardness (machinability) within group.
Above parameters are based on ideal conditions. For smaller taper machining centers, please adjust parameters accordingly on >12mm diameters.

INDEXABLE MILLING

SOLID END MILLING

HOLEMAKING

TAPPING

TURNING

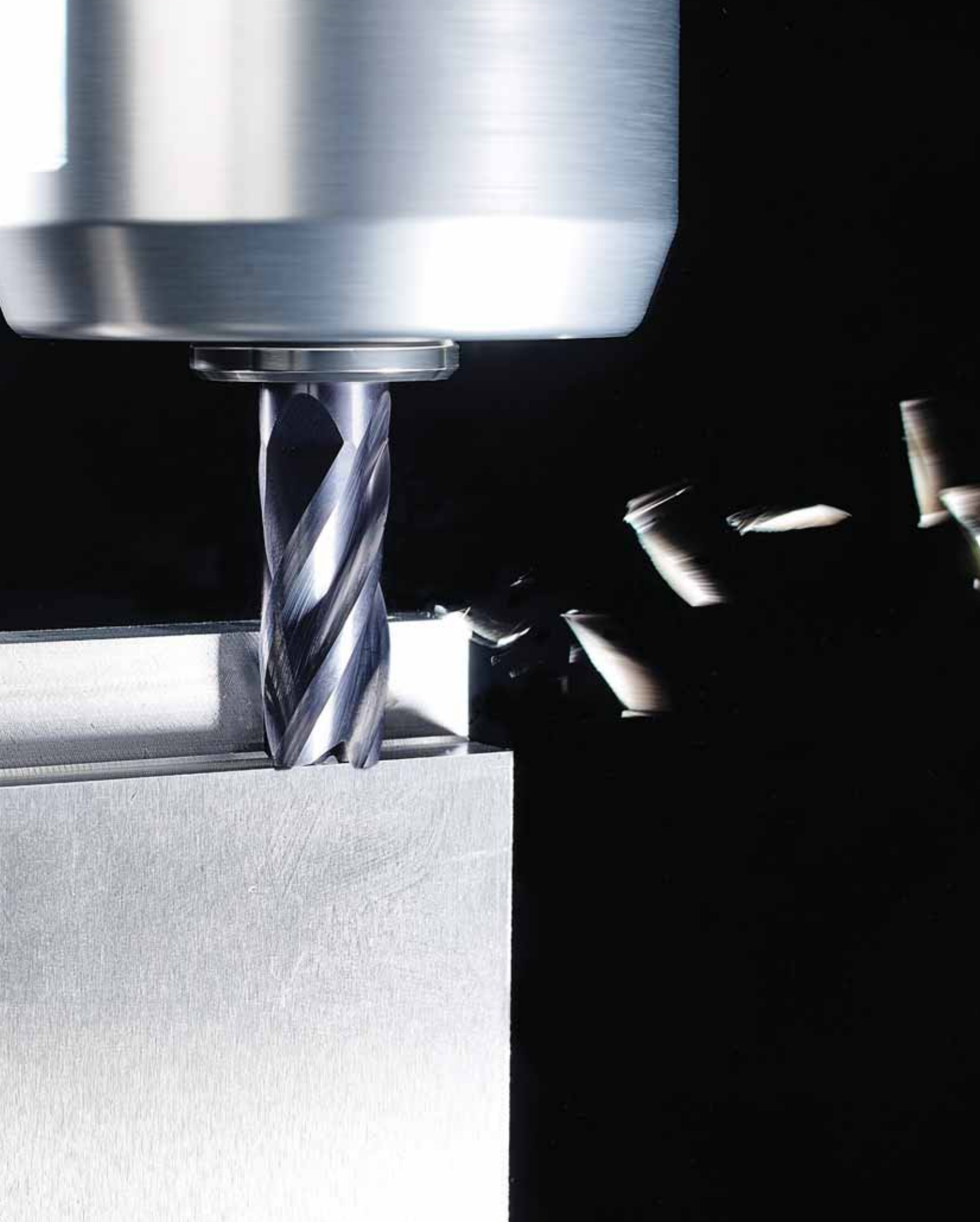

NINA end mills are designed to minimize tool costs for short length-of-cut applications. This end mill is an economical choice for high-quality and performance when regrinding is not justified.



SHORT

The NINA series is designed to perform a maximum depth of cut of 1 x D.

STABLE

The overall design of the NINA cutters is shorter vs regular end mills, providing more stability under high radial force conditions.

ECONOMIC

With the shorter design less carbide is used to make the tool a more economical option.

SHORT, AFFORDABLE STABILITY

PRODUCT

GRADE

TiAIN, ALTiN, K30F-DCHP

FLUTES

2-4

DIAMETER RANGE

2-12mm

CORNER CONDITIONS

Sharp Edges

Chamfer

Ball Nose

INDUSTRY



MATERIALS

FIRST CHOICE



APPLICATIONS



SIDE/
SHOULDER
MILLING
ROUGHING



SLOTING
SQUARE END



HELICAL
MILLING



RAMPING
BLANK



3D
PROFILING

CENTER CUTTING

for maximum flexibility.

30° HELIX ANGLE

for high versatility.

CYLINDRICAL AND WELDON® SHANK



NINA • Series 423002 423001 323001

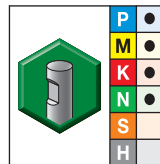
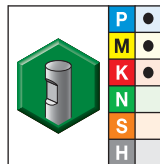
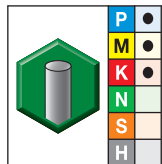
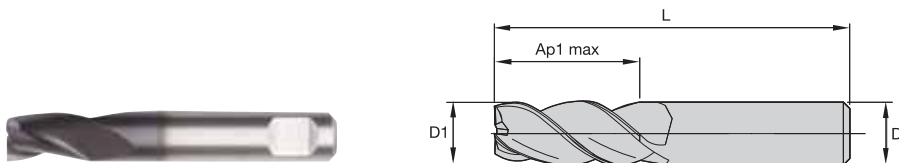

● first choice
○ alternate choice

TiAlN		TiAlN		TiCN-CW		D1	D	length of cut Ap1 max	length L	Z U
order #	catalogue #	order #	catalogue #	order #	catalogue #					
2627990	423002-000020	2343352	423001-000020	2336740	323001-000020	2,0	6	4,00	38	3
2628043	423002-000030	2343354	423001-000030	2336747	323001-000030	3,0	6	5,00	38	3
2628044	423002-000040	2343356	423001-000040	2336753	323001-000040	4,0	6	7,00	38	3
2628045	423002-000050	2343358	423001-000050	2336759	323001-000050	5,0	6	8,00	38	3
2628046	423002-000060	2343360	423001-000060	2336765	323001-000060	6,0	6	8,00	38	3
2628047	423002-000080	2343362	423001-000080	2336771	323001-000080	8,0	8	11,00	43	3
2628048	423002-000100	2343364	423001-000100	2336777	323001-000100	10,0	10	13,00	50	3
2628049	423002-000120	2343366	423001-000120	2336783	323001-000120	12,0	12	15,00	55	3

NOTE: For application data, please see page B61.

NINA • Series 423004 423003

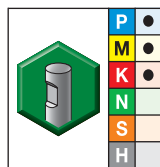
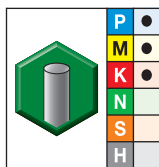
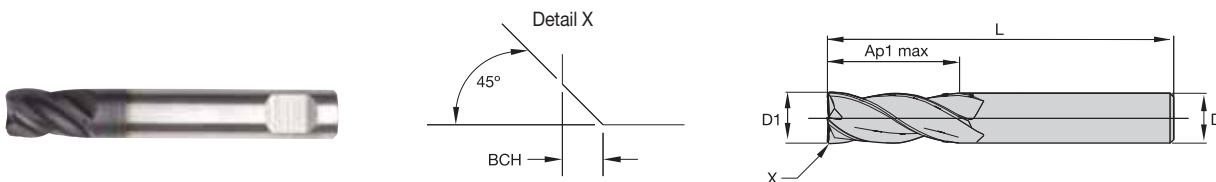

● first choice
○ alternate choice

AiTiN-MT		AiTiN-MW		D1	D	length of cut Ap1 max	length L	BCH	Z U
order #	catalogue #	order #	catalogue #						
3657761	423004-000040	—	—	4,0	6	7,00	38	0,40	4
3657762	423004-000060	3657757	423003-000060	6,0	6	8,00	38	0,40	4
3657763	423004-000080	3657758	423003-000080	8,0	8	11,00	43	0,40	4
3657764	423004-000100	3657759	423003-000100	10,0	10	13,00	50	0,50	4
3657765	423004-000120	3657760	423003-000120	12,0	12	15,00	55	0,50	4

NOTE: For application data, please see page B61.

NINA • Series 423048

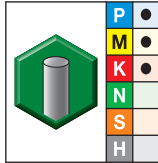
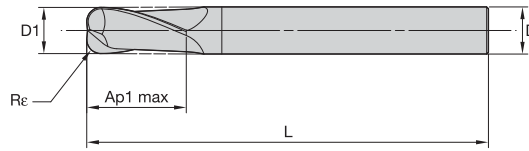

AITiN-MT

- first choice
- alternate choice

order #	catalogue #	D1	D	length of cut Ap1 max	length L	Re	Z U
2343566	423048-000030	3,0	6	5,00	38	0,50	2
2343568	423048-000040	4,0	6	7,00	38	0,50	2

NOTE: For application data, please see page B62.

NINA • Series 423039 423038

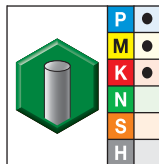
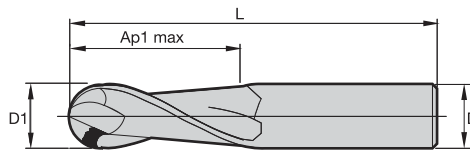

AITiN-MT

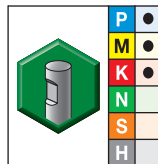

AITiN-MW

- first choice
- alternate choice

order #	catalogue #	order #	catalogue #	D1	D	length of cut Ap1 max	length L	Z U
—	—	2343514	423038-000020	2,0	6	4,00	38	2
2343533	423039-000030	2343516	423038-000030	3,0	6	5,00	38	2
—	—	2343519	423038-000040	4,0	6	7,00	38	2
—	—	2343521	423038-000050	5,0	6	8,00	38	2
2343539	423039-000060	2343523	423038-000060	6,0	6	8,00	38	2
—	—	2343525	423038-000080	8,0	8	11,00	43	2
—	—	2343527	423038-000100	10,0	10	13,00	50	2
—	—	2343529	423038-000120	12,0	12	15,00	55	2

NOTE: For application data, please see page B62.

NINA • Series 423036 423037

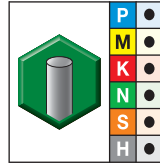
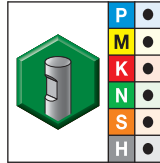
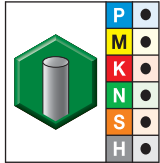
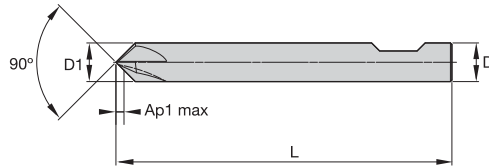



● first choice
○ alternate choice

TiAlN		TiAlN		AlTiN		D1	D	length of cut Ap1 max	length L	Z U
order #	catalogue #	order #	catalogue #	order #	catalogue #					
2628498	423037-000060	2343508	423036-000060	—	—	6,0	6	1,00	38	4
—	—	2343510	423036-000080	—	—	6,0	6	1,00	83	4
2628499	423037-000080	—	—	—	—	8,0	8	1,50	43	4
—	—	2343512	423036-000100	—	—	8,0	8	1,50	104	4
—	—	—	—	2628500	423037-000100	10,0	10	2,00	50	4
—	—	—	—	—	—	10,0	10	2,00	125	4

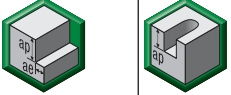

NOTE: For application data, please see page B63.

NINA • Series 423002 323002 423001 323001 • Application Data • K30F-DCF • Metric

Material Group																			
	Side Milling (A) and Slotting (B)			K30F-TiCN			K30F-DCF			Recommended feed per tooth (fz = mm/th) for side milling (A). For slotting (B), reduce fz by 20%.									
	A		B	TiCN			TiAlN			D1 – Diameter									
	ap	ae	ap	Cutting Speed – vc m/min			Cutting Speed – vc m/min			mm	2,0	3,0	4,0	5,0	6,0	8,0	10,0	12,0	
P	0	0,75 x D	0,5 x D	0,5 x D	150	–	200	150	–	200	fz	0,014	0,021	0,028	0,036	0,044	0,060	0,072	0,083
	1	0,75 x D	0,5 x D	0,5 x D	150	–	200	150	–	200	fz	0,014	0,021	0,028	0,036	0,044	0,060	0,072	0,083
	2	0,75 x D	0,5 x D	0,5 x D	140	–	190	140	–	190	fz	0,014	0,021	0,028	0,036	0,044	0,060	0,072	0,083
	3	0,75 x D	0,5 x D	0,5 x D	120	–	160	120	–	160	fz	0,011	0,017	0,023	0,030	0,036	0,050	0,061	0,070
M	1	0,75 x D	0,5 x D	0,5 x D	90	–	150	90	–	150	fz	0,010	0,016	0,021	0,027	0,033	0,045	0,054	0,062
	2	0,75 x D	0,5 x D	0,5 x D	90	–	115	90	–	115	fz	0,011	0,017	0,023	0,030	0,036	0,050	0,061	0,070
K	1	0,75 x D	0,5 x D	0,5 x D	60	–	80	60	–	80	fz	0,009	0,014	0,019	0,024	0,029	0,040	0,048	0,056
	2	0,75 x D	0,5 x D	0,5 x D	120	–	150	120	–	150	fz	0,014	0,021	0,028	0,036	0,044	0,060	0,072	0,083
N	1	0,75 x D	0,5 x D	0,5 x D	110	–	140	110	–	140	fz	0,011	0,017	0,023	0,030	0,036	0,050	0,061	0,070
	2	0,75 x D	0,5 x D	0,5 x D	500	–	2000	500	–	2000	fz	0,020	0,030	0,040	0,050	0,060	0,080	0,100	0,120
	5	0,75 x D	0,5 x D	0,5 x D	500	–	1500	500	–	1500	fz	0,018	0,027	0,036	0,045	0,054	0,072	0,090	0,108

NOTE: Lower value of cutting speed is used for high stock removal applications or for higher hardness (machinability) within group. Higher value of cutting speed is used for finishing applications or for lower hardness (machinability) within group.

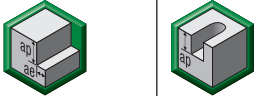
NINA • Series 423004 423003 • Application Data • K30F-DCHP • Metric

Material Group																			
	Side Milling (A) and Slotting (B)			K30F-DCHP			Recommended feed per tooth (fz = mm/th) for side milling (A). For slotting (B), reduce fz by 20%.												
	A		B	AlTiN			D1 – Diameter												
	ap	ae	ap	Cutting Speed – vc m/min			mm	4,0	5,0	6,0	8,0	10,0	12,0						
P	0	1 x D	0,5 x D	1 x D	150	–	200	fz	0,028	0,036	0,044	0,060	0,072	0,083					
	1	1 x D	0,5 x D	1 x D	150	–	200	fz	0,028	0,036	0,044	0,060	0,072	0,083					
	2	1 x D	0,5 x D	1 x D	140	–	190	fz	0,028	0,036	0,044	0,060	0,072	0,083					
	3	1 x D	0,5 x D	1 x D	120	–	160	fz	0,023	0,030	0,036	0,050	0,061	0,070					
M	1	1 x D	0,5 x D	1 x D	90	–	150	fz	0,021	0,027	0,033	0,045	0,054	0,062					
	2	1 x D	0,5 x D	1 x D	90	–	115	fz	0,023	0,030	0,036	0,050	0,061	0,070					
K	1	1 x D	0,5 x D	1 x D	60	–	80	fz	0,019	0,024	0,029	0,040	0,048	0,056					
	2	1 x D	0,5 x D	1 x D	120	–	150	fz	0,028	0,036	0,044	0,060	0,072	0,083					
N	1	1 x D	0,5 x D	1 x D	110	–	140	fz	0,023	0,030	0,036	0,050	0,061	0,070					
	2	1 x D	0,5 x D	1 x D	110	–	130	fz	0,019	0,024	0,029	0,040	0,048	0,056					
	3	1 x D	0,5 x D	1 x D	500	–	2000	fz	0,040	0,050	0,060	0,080	0,100	0,120					

NOTE: Lower value of cutting speed is used for high stock removal applications or for higher hardness (machinability) within group. Higher value of cutting speed is used for finishing applications or for lower hardness (machinability) within group.

NINA • Series 423048 423047 • Application Data • K30F-DCHP • Metric

		Side Milling (A) and Slotting (B)			K30F-DCHP AlTiN			Recommended feed per tooth (fz = mm/th) for side milling (A). For slotting (B), reduce fz by 20%.						
Material Group		A		B	Cutting Speed – vc m/min			mm	D1 – Diameter					
		ap	ae	ap	min	–	max		4,0	5,0	6,0	8,0	10,0	12,0
P	0	0,75 x D	0,5 x D	0,5 x D	150	–	200	fz	0,028	0,036	0,044	0,060	0,072	0,083
	1	0,75 x D	0,5 x D	0,5 x D	150	–	200	fz	0,028	0,036	0,044	0,060	0,072	0,083
	2	0,75 x D	0,5 x D	0,5 x D	140	–	190	fz	0,028	0,036	0,044	0,060	0,072	0,083
	3	0,75 x D	0,5 x D	0,5 x D	120	–	160	fz	0,023	0,030	0,036	0,050	0,061	0,070
M	1	0,75 x D	0,5 x D	0,5 x D	90	–	150	fz	0,021	0,027	0,033	0,045	0,054	0,062
	2	0,75 x D	0,5 x D	0,5 x D	90	–	115	fz	0,023	0,030	0,036	0,050	0,061	0,070
K	1	0,75 x D	0,5 x D	0,5 x D	60	–	80	fz	0,019	0,024	0,029	0,040	0,048	0,056
	2	0,75 x D	0,5 x D	0,5 x D	120	–	150	fz	0,028	0,036	0,044	0,060	0,072	0,083
N	1	0,75 x D	0,5 x D	0,5 x D	110	–	140	fz	0,023	0,030	0,036	0,050	0,061	0,070
	2	0,75 x D	0,5 x D	0,5 x D	500	–	2000	fz	0,040	0,050	0,060	0,080	0,100	0,120
	5	0,75 x D	0,5 x D	0,5 x D	500	–	1500	fz	0,036	0,045	0,054	0,072	0,090	0,108
	5	0,75 x D	0,5 x D	0,5 x D	250	–	1000	fz	0,036	0,045	0,054	0,072	0,090	0,108

NOTE: Lower value of cutting speed is used for high stock removal applications or for higher hardness (machinability) within group.
Higher value of cutting speed is used for finishing applications or for lower hardness (machinability) within group.

NINA • Series 423039 423038 • Application Data • K30F-DCHP • Metric

		Side Milling (A) and Slotting (B)			K30F-DCHP AlTiN			Recommended feed per tooth (fz = mm/th) for 3D milling/profiling (A)						
Material Group		A		B	Cutting Speed – vc m/min			mm	D1 – Diameter					
		ap	ae	ap	min	–	max		4,0	5,0	6,0	8,0	10,0	12,0
P	0	0,75 x D	0,5 x D	0,5 x D	150	–	200	fz	0,028	0,036	0,044	0,060	0,072	0,083
	1	0,75 x D	0,5 x D	0,5 x D	150	–	200	fz	0,028	0,036	0,044	0,060	0,072	0,083
	2	0,75 x D	0,5 x D	0,5 x D	140	–	190	fz	0,028	0,036	0,044	0,060	0,072	0,083
	3	0,75 x D	0,5 x D	0,5 x D	120	–	160	fz	0,023	0,030	0,036	0,050	0,061	0,070
M	1	0,75 x D	0,5 x D	0,5 x D	90	–	150	fz	0,021	0,027	0,033	0,045	0,054	0,062
	2	0,75 x D	0,5 x D	0,5 x D	90	–	115	fz	0,023	0,030	0,036	0,050	0,061	0,070
K	1	0,75 x D	0,5 x D	0,5 x D	60	–	80	fz	0,019	0,024	0,029	0,040	0,048	0,056
	2	0,75 x D	0,5 x D	0,5 x D	120	–	150	fz	0,028	0,036	0,044	0,060	0,072	0,083
N	1	0,75 x D	0,5 x D	0,5 x D	110	–	140	fz	0,023	0,030	0,036	0,050	0,061	0,070
	2	0,75 x D	0,5 x D	0,5 x D	500	–	2000	fz	0,040	0,050	0,060	0,080	0,100	0,120
	5	0,75 x D	0,5 x D	0,5 x D	500	–	1500	fz	0,036	0,045	0,054	0,072	0,090	0,108
	5	0,75 x D	0,5 x D	0,5 x D	250	–	1000	fz	0,036	0,045	0,054	0,072	0,090	0,108

NOTE: Lower value of cutting speed is used for high stock removal applications or for higher hardness (machinability) within group.
Higher value of cutting speed is used for finishing applications or for lower hardness (machinability) within group.

NINA • Series 423036 423037 • Application Data • K30F-DCHP • Metric

Material Group	Chamfer Milling		K30F-DCF TiAlN			K30F-DCHP AlTiN			Recommended feed per tooth (fz = mm/th) for chamfering (A)				
	A		Cutting Speed – vc m/min			Cutting Speed – vc m/min			mm	D1 – Diameter			
	ap	ae	min	–	max	min	–	max		6,0	8,0	10,0	
	0	0,35 x D	0,35 x D	150	–	200	150	–	200	fz	0,035	0,048	0,058
P	1	0,35 x D	0,35 x D	150	–	200	150	–	200	fz	0,035	0,048	0,058
	2	0,35 x D	0,35 x D	140	–	190	140	–	190	fz	0,035	0,048	0,058
	3	0,35 x D	0,35 x D	120	–	160	120	–	160	fz	0,029	0,040	0,048
	4	0,35 x D	0,35 x D	90	–	150	90	–	150	fz	0,026	0,036	0,043
	5	0,35 x D	0,35 x D	60	–	100	60	–	100	fz	0,024	0,032	0,039
	6	0,35 x D	0,35 x D	50	–	75	50	–	75	fz	0,020	0,027	0,032
M	1	0,35 x D	0,35 x D	90	–	115	90	–	115	fz	0,029	0,040	0,048
	2	0,35 x D	0,35 x D	60	–	80	60	–	80	fz	0,024	0,032	0,039
	3	0,35 x D	0,35 x D	60	–	70	60	–	70	fz	0,020	0,027	0,032
K	1	0,35 x D	0,35 x D	120	–	150	120	–	150	fz	0,035	0,048	0,058
	2	0,35 x D	0,35 x D	110	–	140	110	–	140	fz	0,029	0,040	0,048
	3	0,35 x D	0,35 x D	110	–	130	110	–	130	fz	0,024	0,032	0,039
N	1	0,35 x D	0,35 x D	500	–	2000	500	–	2000	fz	0,048	0,064	0,080
	2	0,35 x D	0,35 x D	500	–	1500	500	–	1500	fz	0,043	0,058	0,072
	3	0,35 x D	0,35 x D	500	–	1500	500	–	1500	fz	0,034	0,045	0,056
	4	0,35 x D	0,35 x D	400	–	750	400	–	750	fz	0,0038	0,051	0,064
	5	0,35 x D	0,35 x D	250	–	1000	250	–	1000	fz	0,043	0,058	0,072
	6	0,35 x D	0,35 x D	100	–	750	100	–	750	fz	0,048	0,064	0,080
	7	0,35 x D	0,35 x D	100	–	750	100	–	750	fz	0,034	0,045	0,056
S	1	0,35 x D	0,35 x D	50	–	90	50	–	90	fz	0,036	0,050	0,061
	2	0,35 x D	0,35 x D	25	–	40	25	–	40	fz	0,019	0,026	0,032
	3	0,35 x D	0,35 x D	25	–	40	25	–	40	fz	0,019	0,026	0,032
	4	0,35 x D	0,35 x D	50	–	60	50	–	60	fz	0,026	0,037	0,045
H	1	0,35 x D	0,35 x D	80	–	140	80	–	140	fz	0,026	0,036	0,043

INDEXABLE MILLING

SOLID END MILLING

HOLEMAKING

TAPPING

TURNING



HANITA™

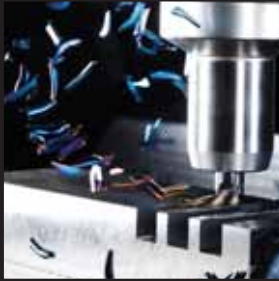

PRODUCTIVITY

Solid end mills in the Hanita™ portfolio achieve exceptional levels of productivity in complex operations at increased cutting parameters.



DURABILITY

End mills in the Hanita portfolio feature optimized geometries capable of peak performance in high-demand machining strategies.



INNOVATION

Hanita is a brand for innovation enthusiasts who are searching for precision-engineered solid carbide end mill solutions.

Hanita **high-performance solid carbide end mill solutions** are developed for customers who have a passion for performance.

Offering a comprehensive range of standard and custom end mills spanning a broad range of diameters and lengths, all boasting **unparalleled metal removal rates** through **innovative geometries**, Hanita delivers not only the tool for the job but **the experience** to develop a solution for the customer.

Hanita solutions are available through WIDIA™ channel partners.



Solid End Milling

Hanita High-Performance Solid Carbide End Mills	B68–B199
VariMill XTREME	B84–B92
VariMill I.....	B94–B104
VariMill II.....	B106–B118
VariMill III ER.....	B120–B124
Roughers.....	B126–B138
Finishers.....	B140–B149
ALUFLASH.....	B150–B160
X-Feed	B162–B167
Vision Plus.....	B168–B192
HSS End Mills	B194–B199

Hanita™ High-Performance Solid Carbide End Mills • Selection Guide • Metric





















INDEXABLE MILLING

SOLID END MILLING

HOLEMAKING





















TAPPING

TURNING

		Hanita Solid End Milling Portfolio						
		VariMill™ XTREME™	VariMill XTREME	VariMill XTREME	VariMill XTREME	VariMill XTREME	VariMill XTREME	VariMill XTREME
								
● first choice ○ alternate choice								
UOM		Metric	Metric	Metric	Metric	Metric	Metric	Metric
Series		4X0E	4X0E	4X0E	4XNE	4XNE	4XNE	4XNE
Page		B86	B86	B87	B87	B88	B88	B89
Flute		4	4	4	4	4	4	4
Diameter D1		3–25mm	4–12mm	25mm	4–20mm	16mm	4–20mm	16mm
Shank								
Length of Cut		Regular	Regular	Regular	Regular	Regular	Regular	Regular
Corner Style								
Chamfer Size		–	0,10–0,30mm	–	–	0,30mm	0,10–0,30mm	–
Radius Sizes		0,20–3,00mm	–	1,00mm	–	–	–	0,20–5,00mm
Helix Angle		37° / 39°	37° / 39°	37° / 39°	37° / 39°	37° / 39°	37° / 39°	37° / 39°
Center Cutting		Yes	Yes	Yes	Yes	Yes	Yes	Yes
Neck		No	No	No	Yes	Yes	Yes	Yes
Materials								
P	0	●	●	●	●	●	●	●
	1	●	●	●	●	●	●	●
	2	●	●	●	●	●	●	●
	3	●	●	●	●	●	●	●
	4	●	●	●	●	●	●	●
	5	●	●	●	●	●	●	●
M	1	●	●	●	●	●	●	●
	2	●	●	●	●	●	●	●
	3	●	●	●	●	●	●	●
K	1	●	●	●	●	●	●	●
	2	●	●	●	●	●	●	●
	3	●	●	●	●	●	●	●
N	1							
	2							
	3							
	4							
	5							
S	1	○	○	○	○	○	○	○
	2	○	○	○	○	○	○	○
	3	○	○	○	○	○	○	○
	4	○	○	○	○	○	○	○
H	1	○	○	○	○	○	○	○
	2	○	○	○	○	○	○	○
	3							
	4							

Hanita™ High-Performance Solid Carbide End Mills • Selection Guide • Metric

● first choice
○ alternate choice

		Hanita Solid End Milling Portfolio						
		VariMill™ XTREME™	VariMill I™	VariMill I	VariMill I	VariMill I	VariMill I	VariMill I
								
UOM		Metric	Metric	Metric	Metric	Metric	Metric	Metric
Series		4XNE	4777	4777	4777	4777	4717	4727
Page		B89	B96	B96	B96	B96	B97	B97
Flute		4	4	4	4	4	4	4
Diameter D1		12–20mm	4–20mm	4–25mm	4–25mm	4–25mm	6–20mm	12–20mm
Shank								
Length of Cut		Regular	Regular	Regular	Regular	Regular	Long	Extended
Corner Style								
Chamfer Size		–	–	0,40–0,50mm	–	0,40–0,50mm	0,40–0,50mm	0,50mm
Radius Sizes		1,00mm	–	–	0,20–5,00mm	–	–	–
Helix Angle		37° / 39°	38°	38°	38°	38°	38°	38°
Center Cutting		Yes	Yes	Yes	Yes	Yes	Yes	Yes
Neck		Yes	No	No	No	No	No	No
Materials								
P	0	●	●	●	●	●	●	●
	1	●	●	●	●	●	●	●
	2	●	●	●	●	●	●	●
	3	●	●	●	●	●	●	●
	4	●	●	●	●	●	●	●
	5	●	●	●	●	●	●	●
M	1	●	○	○	○	○	○	○
	2	●	○	○	○	○	○	○
	3	●	○	○	○	○	○	○
K	1	●	●	●	●	●	●	●
	2	●	●	●	●	●	●	●
	3	●	●	●	●	●	●	●
N	1							
	2							
	3							
	4							
	5							
S	1	○	○	○	○	○	○	○
	2	○	○	○	○	○	○	○
	3	○	○	○	○	○	○	○
	4	○	○	○	○	○	○	○
H	1	○	○	○	○	○	○	○
	2	○	○	○	○	○	○	○
	3							
	4							

INDEXABLE MILLING

SOLID END MILLING

HOLEMAKING

TAPPING

TURNING

SEM Selection Table

Hanita™ High-Performance Solid Carbide End Mills • Selection Guide • Metric

INDEXABLE MILLING





















SOLID END MILLING

HOLEMAKING

TAPPING





















TURNING

- first choice
- alternate choice

		Hanita Solid End Milling Portfolio						
		VariMill I™	VariMill I	VariMill I	VariMill I	VariMill I	VariMill II™	VariMill II
								
UOM		Metric	Metric	Metric	Metric	Metric	Metric	Metric
Series		4778	47N7	47N7	47N6	47N0	5777	5777
Page		B98	B99	B99	B100	B100	B108	B108
Flute		4	4	4	4	4	5	5
Diameter D1		4–25mm	4–20mm	6–20mm	6–20mm	5–20mm	4–20mm	4–25mm
Shank								
Length of Cut		Regular	Regular	Regular	Extended	Regular	Regular	Regular
Corner Style								
Chamfer Size		–	–	0,40–0,50mm	0,40–0,50mm	–	–	–
Radius Sizes		0,20–0,30mm	0,40–5,00mm	–	–	–	–	0,25–5,00mm
Helix Angle		38°	38°	38°	38°	38°	38°	38°
Center Cutting		Yes	Yes	Yes	Yes	Yes	No	No
Neck		No	Yes	Yes	Yes	Yes	No	No
Materials								
P	0	○	●	●	●	●	●	●
	1	○	●	●	●	●	●	●
	2	○	●	●	●	●	●	●
	3	○	●	●	●	●	●	●
	4	○	●	●	●	●	●	●
	5	○	●	●	●	●	●	●
M	1	●	○	○	○	○	○	○
	2	●	○	○	○	○	○	○
	3	●	○	○	○	○	○	○
K	1		●	●	●	●	●	●
	2		●	●	●	●	●	●
	3		●	●	●	●	●	●
N	1							
	2							
	3							
	4							
	5							
S	1	●	○	○	○	○	○	○
	2	●	○	○	○	○	○	○
	3	●	○	○	○	○	○	○
	4	●	○	○	○	○	○	○
H	1		○	○	○	○	○	○
	2		○	○	○	○	○	○
	3							
	4							

Hanita™ High-Performance Solid Carbide End Mills • Selection Guide • Metric

- first choice
- alternate choice

		Hanita Solid End Milling Portfolio						
		VariMill II™	VariMill II	VariMill II	VariMill II	VariMill II	VariMill II	VariMill II
								
UOM		Metric	Metric	Metric	Metric	Metric	Metric	Metric
Series		5777	577C	577C	577C	57N8	57N8	57N8
Page		B108	B109	B109	B109	B110	B110	B110
Flute		5	5	5	5	5	5	5
Diameter D1		16,00mm	4–20mm	4–25mm	4–25mm	6–16mm	6–25mm	16–20mm
Shank								
Length of Cut		Regular	Regular	Regular	Regular	Regular	Regular	Regular
Corner Style								
Chamfer Size		–	–	–	–	–	–	–
Radius Sizes		0,75mm	–	0,25–5,00mm	0,25–0,75mm	–	0,5–5,00mm	0,5–3,00mm
Helix Angle		38°	38°	38°	38°	38°	38°	38°
Center Cutting		No	Yes	Yes	Yes	No	No	No
Neck		No	No	No	No	Yes	Yes	Yes
Materials								
P	0	●	●	●	●	○	○	○
	1	●	●	●	●	○	○	○
	2	●	●	●	●	○	○	○
	3	●	●	●	●	○	○	○
	4	●	●	●	●	○	○	○
	5	●	●	●	●	○	○	○
M	1	○	○	○	○	●	●	●
	2	○	○	○	○	●	●	●
	3	○	○	○	○	●	●	●
K	1	●	●	●	●			
	2	●	●	●	●			
	3	●	●	●	●			
N	1							
	2							
	3							
	4							
	5							
S	1	○	○	○	○	●	●	●
	2	○	○	○	○	●	●	●
	3	○	○	○	○	●	●	●
	4	○	○	○	○	●	●	●
H	1	○	○	○	○			
	2	○	○	○	○			
	3							
	4							

INDEXABLE MILLING

SOLID END MILLING

HOLEMAKING

TAPPING

TURNING

SEM Selection Table

Hanita™ High-Performance Solid Carbide End Mills • Selection Guide • Metric

INDEXABLE MILLING





















SOLID END MILLING

HOLEMAKING

TAPPING





















TURNING

- first choice
- alternate choice

		Hanita Solid End Milling Portfolio						
		VariMill II™	VariMill II	VariMill II	VariMill II	VariMill II	VariMill II	VariMill II
								
UOM		Metric	Metric	Metric	Metric	Metric	Metric	Metric
Series		57NC	57NC	57NC	577E	577E	577E	577E
Page		B111	B111	B111	B112	B112	B112	B112
Flute		5	5	5	5	5	5	5
Diameter D1		6–25mm	6–25mm	6–25mm	10mm	12–20mm	16–20mm	16–25mm
Shank								
Length of Cut		Regular	Regular	Regular	Regular	Regular	Regular	Regular
Corner Style								
Chamfer Size		–	–	–	–	–	–	–
Radius Sizes		–	0,25–4,00mm	0,50–3,00mm	–	0,75mm	–	0,75mm
Helix Angle		38°	38°	38°	38°	38°	38°	38°
Center Cutting		Yes	Yes	Yes	Yes	Yes	Yes	Yes
Neck		Yes	Yes	Yes	No	No	No	No
Materials								
P	0	○	○	○				
	1	○	○	○				
	2	○	○	○				
	3	○	○	○				
	4	○	○	○				
	5	○	○	○	●	●	●	●
M	1	●	●	●	●	●	●	●
	2	●	●	●	●	●	●	●
	3	●	●	●	●	●	●	●
K	1							
	2							
	3							
N	1							
	2							
	3							
	4							
	5							
S	1	●	●	●	●	●	●	●
	2	●	●	●	●	●	●	●
	3	●	●	●	●	●	●	●
	4	●	●	●	●	●	●	●
H	1							
	2							
	3							
	4							

Hanita™ High-Performance Solid Carbide End Mills • Selection Guide • Metric

● first choice
○ alternate choice

		Hanita Solid End Milling Portfolio						
		VariMill II™	VariMill II	VariMill II	VariMill II	VariMill II	VariMill II	VariMill II
								
UOM		Metric	Metric	Metric	Metric	Metric	Metric	Metric
Series		57NE	57NE	57NE	57NE	57NE	5718	5718
Page		B113	B113	B113	B113	B113	B114	B114
Flute		5	5	5	5	5	5	5
Diameter D1		10mm	10mm	10–20mm	12–25mm	12–25mm	6–25mm	6–25mm
Shank								
Length of Cut		Regular	Regular	Regular	Regular	Regular	X-Long	X-Long
Corner Style								
Chamfer Size		–	–	–	–	–	–	–
Radius Sizes		–	0,50–2,00mm	0,50–4,00mm	–	0,50–4,00mm	–	0,5–4,00mm
Helix Angle		38°	38°	38°	38°	38°	43°	43°
Center Cutting		Yes	Yes	Yes	Yes	Yes	No	No
Neck		Yes	Yes	Yes	Yes	Yes	No	No
Materials								
P	0						●	●
	1						●	●
	2						●	●
	3						●	●
	4						●	●
	5	●	●	●	●	●	●	●
M	1	●	●	●	●	●	●	●
	2	●	●	●	●	●	●	●
	3	●	●	●	●	●	●	●
K	1						●	●
	2						●	●
	3						●	●
N	1							
	2							
	3							
	4							
	5							
S	1	●	●	●	●	●	●	●
	2	●	●	●	●	●	●	●
	3	●	●	●	●	●	●	●
	4	●	●	●	●	●	●	●
H	1						●	●
	2						●	●
	3						●	●
	4						●	●

INDEXABLE MILLING

SOLID END MILLING

HOLEMAKING

TAPPING

TURNING

Hanita™ High-Performance Solid Carbide End Mills • Selection Guide • Metric





















INDEXABLE MILLING

SOLID END MILLING

HOLEMAKING





















TAPPING

TURNING

		Hanita Solid End Milling Portfolio						
		VariMill III™	VariMill III	VariMill III	VariMill III	VariMill III	VariMill III	VariMill III
								
● first choice ○ alternate choice								
UOM		Metric	Metric	Metric	Metric	Metric	Metric	Metric
Series		771E	771E	772E	772E	772E	772E	77NE
Page		B122	B122	B122	B122	B122	B122	B122
Flute		7	7	7	7	7	7	7
Diameter D1		10–20mm	10–20mm	10–20mm	10–20mm	12–20mm	12–20mm	10–20mm
Shank								
Length of Cut		Regular	Regular	X-Long	X-Long	X-Long	X-Long	Regular
Corner Style								
Chamfer Size		0,5mm	—	0,5mm	—	0,5mm	—	0,5mm
Radius Sizes		—	0,5mm	—	0,5mm	—	0,5mm	—
Helix Angle		38°	38°	38°	38°	38°	38°	38°
Center Cutting		Yes	Yes	Yes	Yes	Yes	Yes	Yes
Neck		No	No	No	No	No	No	Yes
Materials								
P	0							
	1							
	2							
	3							
	4							
	5	●	●	●	●	●	●	●
M	6	●	●	●	●	●	●	●
	1	●	●	●	●	●	●	●
	2	●	●	●	●	●	●	●
K	3	●	●	●	●	●	●	●
	1							
	2							
N	3							
	1							
	2							
	3							
	4							
S	5							
	1	●	●	●	●	●	●	●
	2	●	●	●	●	●	●	●
	3	●	●	●	●	●	●	●
H	4	●	●	●	●	●	●	●
	1							
	2							
	3							
	4							

Hanita™ High-Performance Solid Carbide End Mills • Selection Guide • Metric

- first choice
- alternate choice

		Hanita Solid End Milling Portfolio						
		VariMill III™	Roughers	Roughers	Roughers	Roughers	Roughers	Roughers
								
UOM		Metric	Metric	Metric	Metric	Metric	Metric	Metric
Series		77NE	4906	4906	4976	49N6	4U50	4U80
Page		B122	B128	B128	B129	B129	B130	B130
Flute		7	3 - 4	3 - 4 - 5	3 - 4	3 - 5	4 - 6	4 - 6
Diameter D1		10–20mm	4–20mm	4–25mm	4–20mm	6–20mm	6–25mm	6–25mm
Shank								
Length of Cut		Regular	Regular	Regular	Regular	Regular	Short	Regular
Corner Style								
Chamfer Size		–	0,30–0,50mm	0,30–0,50mm	0,30–0,50mm	0,30–0,50mm	–	–
Radius Sizes		0,5mm	–	–	–	–	0,30–1,00mm	0,30–1,00mm
Helix Angle		38°	30°	30°	30°	30°	45°	45°
Center Cutting		Yes	Yes	Yes	Yes	Yes	Yes	Yes
Neck		Yes	No	No	No	Yes	Yes	No
Materials								
P	0		●	●	●	●		
	1		●	●	●	●		
	2		●	●	●	●		
	3		●	●	●	●		
	4		●	●	●	●		
	5	●	●	●	●	●	●	●
M	1	●	○	○	○	○	●	●
	2	●	○	○	○	○	●	●
	3	●	○	○	○	○	●	●
K	1		●	●	●	●		
	2		●	●	●	●		
	3		●	●	●	●		
N	1							
	2							
	3							
	4							
	5							
S	1	●	○	○	○	○	●	●
	2	●	○	○	○	○	●	●
	3	●	○	○	○	○	●	●
	4	●	○	○	○	○	●	●
H	1		○	○	○	○		
	2		○	○	○	○		
	3							
	4							

INDEXABLE MILLING

SOLID END MILLING

HOLEMAKING

TAPPING

TURNING

SEM Selection Table

Hanita™ High-Performance Solid Carbide End Mills • Selection Guide • Metric





















INDEXABLE MILLING

SOLID END MILLING

HOLEMAKING





















TAPPING

TURNING

		Hanita Solid End Milling Portfolio						
		Roughers	Roughers	Roughers	Roughers	Roughers	Roughers	Roughers
								
		● first choice ○ alternate choice						
UOM		Metric	Metric	Metric	Metric	Metric	Metric	Metric
Series		4U80	4U40	4U70	4U70	DQ13	DQ13	49H6
Page		B130	B131	B131	B131	B132	B132	B132
Flute		4 - 6	4	4 - 6	4 - 6	3	3	4
Diameter D1		6–16mm	8mm	6–20mm	6–16mm	3–4mm	3–18mm	10–16mm
Shank								
Length of Cut		Regular	Short	Regular	Regular	Regular	Regular	Regular
Corner Style								
Chamfer Size		–	–	0,50–1,00mm	0,30–0,60mm	–	–	–
Radius Sizes		0,30–0,50mm	0,75mm	–	–	0,25mm	0,25–0,45mm	0,50mm
Helix Angle		45°	45°	45°	45°	30°	30°	30°
Center Cutting		Yes	Yes	Yes	Yes	Yes	Yes	Yes
Neck		No	Yes	No	No	No	No	No
Materials								
P	0					●	●	●
	1					●	●	●
	2					●	●	●
	3					●	●	●
	4					●	●	●
	5	●	●	●	●	●	●	●
M	1	●	●	●	●	○	○	○
	2	●	●	●	●	○	○	○
	3	●	●	●	●	○	○	○
K	1					●	●	●
	2					●	●	●
	3					●	●	●
N	1							
	2							
	3							
	4							
	5							
S	1	●	●	●	●	○	○	○
	2	●	●	●	●	○	○	○
	3	●	●	●	●	○	○	○
	4	●	●	●	●	○	○	○
H	1					○	○	○
	2					○	○	○
	3							
	4							

Hanita™ High-Performance Solid Carbide End Mills • Selection Guide • Metric

● first choice
○ alternate choice

		Hanita Solid End Milling Portfolio						
		Roughers	Finishers	Finisher	Finisher	Finisher	Finisher	Finisher
								
UOM		Metric	Metric	Metric	Metric	Metric	Metric	Metric
Series		4940	DC03	4603	D503	D513	D507	D517
Page		B133	B142	B142	B143	B143	B144	B144
Flute		4 - 6	3	3	3	3	6	6
Diameter D1		6–16mm	3–12mm	3–16mm	2–12mm	3–10mm	6–20mm	6–20mm
Shank								
Length of Cut		Short	Regular	Regular	Regular	Regular	Regular	Regular
Corner Style								
Chamfer Size		–	–	–	–	–	–	–
Radius Sizes		0,75–1,00mm	0,25–0,45mm	–	–	–	–	–
Helix Angle		45°	35°	60°	45°	45°	45°	45°
Center Cutting		Yes	Yes	Yes	Yes	Yes	Yes	Yes
Neck		No	No	No	No	No	No	No
Materials								
P	0	●	●	●	●	●	●	●
	1	●	●	●	●	●	●	●
	2	●	●	●	●	●	●	●
	3	●	●	●	●	●	●	●
	4	●	●	●	●	●	●	●
	5	●	●	●	●	●	●	●
M	1	○	●	●	●	●	●	●
	2	○	●	●	●	●	●	●
	3	○	●	●	●	●	●	●
K	1	●	●	●	●	●	●	●
	2	●	●	●	●	●	●	●
	3	●	●	●	●	●	●	●
N	1							
	2							
	3							
	4							
	5							
S	1	○	●	●	●	●	●	●
	2	○	●	●	●	●	●	●
	3	○	●	●	●	●	●	●
	4	○	●	●	●	●	●	●
H	1	○	●	●	●	●	●	●
	2	○	●	●	●	●	●	●
	3		●	●	●	●	●	●
	4		●	●	●	●	●	●

INDEXABLE MILLING

SOLID END MILLING

HOLEMAKING

TAPPING

TURNING

SEM Selection Table

Hanita™ High-Performance Solid Carbide End Mills • Selection Guide • Metric





















INDEXABLE MILLING

SOLID END MILLING

HOLEMAKING





















TAPPING

TURNING

		Hanita Solid End Milling Portfolio						
		Finisher	Finisher	ALUFLASH™	ALUFLASH	ALUFLASH	ALUFLASH	ALUFLASH
								
		● first choice ○ alternate choice						
UOM		Metric	Metric	Metric	Metric	Metric	Metric	Metric
Series		4503 JJ	4001 JJ	2A09	2A09	3A09	3A09	3AN9
Page		B145	B145	B152	B152	B153	B153	B154
Flute		3	2	2	2	3	3	3
Diameter D1		1–20mm	1–16mm	1–20mm	1–20mm	3mm	3–4mm	4–20mm
Shank								
Length of Cut		Regular	Regular	Regular	Regular	Regular	Regular	Regular
Corner Style								
Chamfer Size		–	–	–	–	–	–	–
Radius Sizes		–	–	–	0,20–1,00mm	–	0,20–0,50mm	–
Helix Angle		45°	30°	37° / 39°	37° / 39°	37° / 39°	37° / 39°	37° / 39°
Center Cutting		Yes	Yes	Yes	Yes	Yes	Yes	Yes
Neck		No	Yes	No	No	No	No	Yes
Materials								
P	0	●	●					
	1	●	●					
	2	●	●					
	3	●	●					
	4	●	●					
	5	●	●					
M	1	●	●					
	2	●	●					
	3	●	●					
K	1	●	●					
	2	●	●					
	3	●	●					
N	1			●	●	●	●	●
	2			●	●	●	●	●
	3			●	●	●	●	●
	4			●	●	●	●	●
	5			●	●	●	●	●
S	1	●	●					
	2	●	●					
	3	●	●					
	4	●	●					
H	1	●	●					
	2	●	●					
	3	●	●					
	4	●	●					

Hanita™ High-Performance Solid Carbide End Mills • Selection Guide • Metric

- first choice
- alternate choice

		Hanita Solid End Milling Portfolio						
		ALUFLASH™	ALUFLASH	ALUFLASH	X-Feed™	X-Feed	X-Feed	X-Feed
								
UOM		Metric	Metric	Metric	Metric	Metric	Metric	Metric
Series		3AN9	3AP9	3AP9	70N6	71N6	70NS	70N7
Page		B155	B156	B156	B164	B164	B165	B165
Flute		3	3	3	6	6	6	6
Diameter D1		4–20mm	12mm	4–20mm	6–12mm	6–20mm	6–25mm	6–20mm
Shank								
Length of Cut		Regular	Long	Long	Long	Regular	Regular	Regular
Corner Style								
Chamfer Size		–	–	–	–	–	–	–
Radius Sizes		0,20–5,00mm	–	0,20–4,00mm	–	–	–	–
Helix Angle		37° / 39°	37° / 39°	37° / 39°	20°	20°	20°	20°
Center Cutting		Yes	Yes	Yes	Yes	Yes	Yes	Yes
Neck		Yes	Yes	Yes	Yes	Yes	Yes	Yes
Materials								
P	0				●	●		
	1				●	●		
	2				●	●		
	3				●	●		
	4				●	●		
	5						●	
M	1						●	
	2						●	
	3						●	
K	1							
	2							
	3							
N	1	●	●	●				
	2	●	●	●				
	3	●	●	●				
	4	●	●	●				
	5	●	●	●				
S	1						●	
	2						●	
	3				●	●	●	
	4				●	●	●	
H	1							●
	2							●
	3							●
	4							●

INDEXABLE MILLING

SOLID END MILLING

HOLEMAKING

TAPPING

TURNING

SEM Selection Table

Hanita™ High-Performance Solid Carbide End Mills • Selection Guide • Metric





















INDEXABLE MILLING

SOLID END MILLING

HOLEMAKING

TAPPING





















TURNING

		Hanita Solid End Milling Portfolio						
		Vision Plus™	Vision Plus	Vision Plus	Vision Plus	Vision Plus	Vision Plus	Vision Plus
								
● first choice ○ alternate choice								
UOM		Metric	Metric	Metric	Metric	Metric	Metric	Metric
Series		7505	7515	7525	7545	7585	7595	75N2
Page		B170	B170	B170	B170	B171	B171	B172
Flute		4	4 - 6	4 - 5 - 6	4	4	4	3
Diameter D1		3–12mm	6–25mm	6–25mm	3–16mm	6–16mm	3–20mm	3–6mm
Shank								
Length of Cut		Regular	Long	Extended	Short	Short	Long	Regular
Corner Style								
Chamfer Size		–	–	–	–	–	–	–
Radius Sizes		–	–	–	–	0,25–1,00mm	0,25–2,00mm	0,30–1,00mm
Helix Angle		50°	50°	50°	50°	50°	50°	30°
Center Cutting		Yes	Yes	Yes	Yes	Yes	Yes	Yes
Neck		No	No	No	No	No	No	Yes
Materials								
P	0							
	1							
	2							
	3							
	4							
	5							
M	1							
	2							
	3							
K	1							
	2							
	3							
N	1							
	2							
	3							
	4							
	5							
S	1							
	2							
	3							
	4							
H	1	•	•	•	•	•	•	•
	2	•	•	•	•	•	•	•
	3	•	•	•	•	•	•	•
	4	•	•	•	•	•	•	•



Hanita™ High-Performance Solid Carbide End Mills • Selection Guide • Metric

- first choice
- alternate choice

		Hanita Solid End Milling Portfolio						
		Vision Plus™	Vision Plus	Vision Plus	Vision Plus	Vision Plus	Vision Plus	Vision Plus
								
UOM		Metric	Metric	Metric	Metric	Metric	Metric	Metric
Series		75N5	7670	D518	D618	7050	7060	7061
Page		B172	B173	B173	B174	B174	B174	B175
Flute		4	6	4 - 6 - 8	4 - 6	4	4	2
Diameter D1		3–20mm	16mm	4–25mm	3–20mm	2–16mm	6–10mm	1–8mm
Shank								
Length of Cut		Regular	Short	Regular	Long	Regular	Regular	Regular
Corner Style								
Chamfer Size		–	–	–	–	–	–	–
Radius Sizes		0,25–2,00mm	1mm	–	–	–	–	–
Helix Angle		50°	45°	50°	50°	15°	15°	15°
Center Cutting		Yes	Yes	Yes	Yes	Yes	Yes	Yes
Neck		Yes	Yes	No	No	No	No	No
Materials								
P	0							
	1							
	2							
	3							
	4							
	5							
M	1							
	2							
	3							
K	1							
	2							
	3							
N	1							
	2							
	3							
	4							
	5							
S	1							
	2							
	3							
	4							
H	1	●	●	●	●	●	●	●
	2	●	●	●	●	●	●	●
	3	●	●	●	●	●	●	●
	4	●	●	●	●	●	●	●

INDEXABLE MILLING

SOLID END MILLING

HOLEMAKING

TAPPING

TURNING

Hanita™ High-Performance Solid Carbide End Mills • Selection Guide • Metric

INDEXABLE MILLING





















SOLID END MILLING

HOLEMAKING

TAPPING



















TURNING

- first choice
- alternate choice

		Hanita Solid End Milling Portfolio						
		Vision Plus™	Vision Plus	Vision Plus	Vision Plus Micro	Vision Plus Micro	Vision Plus Micro	Vision Plus Micro
								
UOM		Metric	Metric	Metric	Metric	Metric	Metric	Metric
Series		7150	7151	70N1	7N02	7N12	7N22	7N01
Page		B175	B176	B176	B177-B178	B177-B178	B177-B178	B179
Flute		4	2	2	2	2	2	2
Diameter D1		3–12mm	1–12mm	1–12mm	0,3–2mm	1–4mm	0,4–3,05mm	0,3–6mm
Shank								
Length of Cut		Regular	Regular	–	Regular	Long	Extended	Regular
Corner Style								
Chamfer Size		–	–	–	–	–	–	–
Radius Sizes		–	–	–	–	–	–	–
Helix Angle		15°	15°	30°	30°	30°	30°	30°
Center Cutting		Yes	Yes	Yes	Yes	Yes	Yes	Yes
Neck		No	No	Yes	Yes	Yes	Yes	Yes
Materials								
P	0							
	1							
	2							
	3							
	4							
	5							
M	1							
	2							
	3							
K	1							
	2							
	3							
N	1							
	2							
	3							
	4							
	5							
S	1							
	2							
	3							
	4							
H	1	●	●	●	●	●	●	●
	2	●	●	●	●	●	●	●
	3	●	●	●	●	●	●	●
	4	●	●	●	●	●	●	●

Hanita™ High-Performance Solid Carbide End Mills • Selection Guide • Metric

- first choice
- alternate choice

		Hanita Solid End Milling Portfolio					
		Vision Plus™ Micro	HSS Roughers	HSS Roughers	WavCut I™	WavCut I	WavCut I
							
UOM		Metric	Metric	Metric	Metric	Metric	Metric
Series		7N21	60N6	6LN6	660W	661W	664W
Page		B179	B196	B196	B197	B197	B197
Flute		2	4-5	4-5	5-6	6-8	5-6
Diameter D1		0,5-3mm	6-30mm	12-25mm	25-50mm	25-50mm	25-50mm
Shank							
Length of Cut		Regular	Regular	Regular	Regular	Long	Short
Corner Style							
Chamfer Size		—	0,25-0,50mm	0,35-0,5mm	1mm	1mm	1mm
Radius Sizes		—	—	—	—	—	—
Helix Angle		30°	30°	30°	35°	35°	35°
Center Cutting		Yes	Yes	Yes	Yes	Yes	Yes
Neck		Yes	No	Yes	No	No	No
Materials							
P	0		●	●			
	1		●	●			
	2		●	●			
	3		●	●			
	4		●	●			
	5		●	●			
M	1		●	●	●	●	●
	2		●	●	●	●	●
	3		●	●	●	●	●
K	1		●	●			
	2		●	●			
	3		●	●			
N	1						
	2						
	3						
	4						
	5						
S	1		●	●	●	●	●
	2		●	●	●	●	●
	3		●	●	●	●	●
	4		●	●	●	●	●
H	1	●					
	2	●					
	3	●					
	4	●					

INDEXABLE MILLING

SOLID END MILLING

HOLEMAKING

TAPPING

TURNING

VariMill™ XTREME™

High-Performance Solid End Milling

VariMill XTREME is for CNC machining companies seeking a versatile solution capable of machining a broad range of materials while ensuring a high productivity output to reduce manufacturing costs through aggressive machining conditions.

Built-in features to enable aggressive versatility.

Twisted end face to improve edge stability, which enables aggressive ramping angles and helical capability.

Non-linear chip gashes for improved chip evacuation, enabling the ramping function and z-axis machining.

Asymmetrical divided flute and variable helix angle for reduced vibrations.

Parabolic core for increased tool stability and reduced deflection and risk of breakage.



VariMill XTREME will dominate the shop floor through productive output due to its versatile offering and ability to machine a broad range of materials in aggressive cutting conditions.

AGGRESSIVE

Exceeds expectations in aggressive cutting parameters.

PRODUCTIVE

Improved chip evacuation and increased edge/corner strength to reduce any risk of breakage while pushing the cutting parameters to the limit.

VERSATILE

Capable of machining a broad range of materials (steel, stainless steel, cast iron, super alloys), provides high-performance and tool life in a variety of operations including ramping, slotting, plunging, drilling, helical interpolation, and dynamic milling.

AGGRESSIVE VERSATILITY

PRODUCT

SOLID CARBIDE END MILL

GRADE

WS15PE

FLUTE

4

DIAMETER RANGE

METRIC

3–25mm

INDUSTRY



APPLICATIONS

MATERIALS

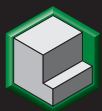

SIDE
MILLING



SLOTING



HELICAL
INTERPOLATION



RAMPING



DYNAMIC MILLING



PLUNGING



DRILLING

VariMill XTREME • Series 4XOE • Radiused • 4 Flute • Cylindrical Shank • Metric

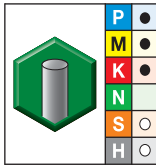
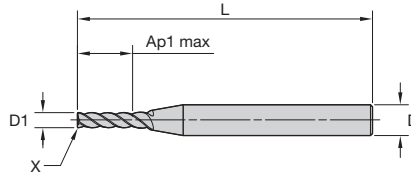
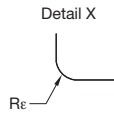

WS15PE

● first choice
○ alternate choice

order #	catalogue #	D1	D	length of cut Ap1 max	length L	Re	ZU
6829314	4X0EM03002RAT	3,0	6	9,50	57	0,20	4
6830480	4X0EM25008RKT	25,0	25	50,00	121	1,50	4
6830671	4X0EM25008RPT	25,0	25	50,00	121	3,00	4

VariMill XTREME • Series 4XOE • Chamfered • 4 Flute • Cylindrical Shank • Metric

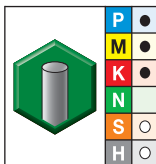
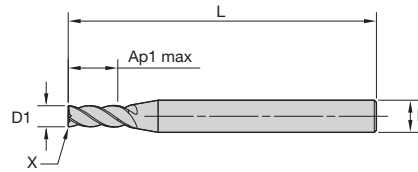
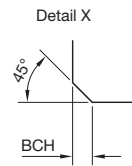

WS15PE

● first choice
○ alternate choice

order #	catalogue #	D1	D	length of cut Ap1 max	length L	BCH	ZU
6829315	4X0EM04002CST	4,0	6	8,00	57	0,10	4
6829320	4X0EM05002CST	5,0	6	10,00	57	0,10	4
6829695	4X0EM06002CST	6,0	6	12,00	57	0,10	4
6829881	4X0EM08003CAT	8,0	8	16,00	63	0,20	4
6829888	4X0EM10004CAT	10,0	10	20,00	72	0,20	4
6830075	4X0EM12005CCT	12,0	12	24,00	83	0,30	4

VariMill XTREME • Series 4X0E • Radiused • 4 Flute • Safe-Lock™ Shank • Metric

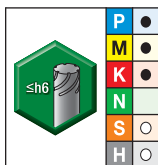
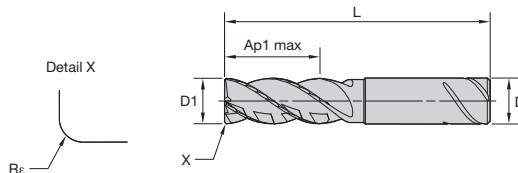

- first choice
- alternate choice

WS15PE

order #	catalogue #	D1	D	length of cut Ap1 max	length L	Re	ZU
6830479	4X0EM25018RJV	25,0	25	50,00	135	1,00	4

INDEXABLE MILLING

SOLID END MILLING

HOLEMAKING

TAPPING

TURNING

VariMill XTREME • Series 4XNE • Square End • 4 Flute • Necked • Cylindrical Shank • Metric

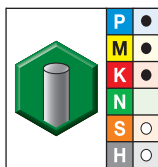
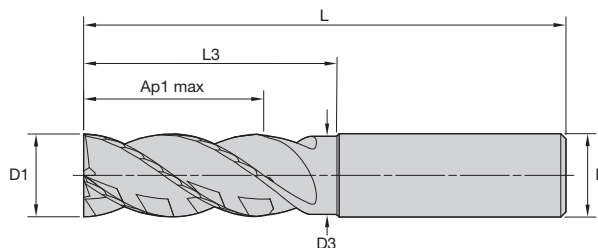

- first choice
- alternate choice

WS15PE

order #	catalogue #	D1	D	D3	length of cut Ap1 max	L3	length L	ZU
6829316	4XNEM04002SZT	4,0	6	3,76	8,00	12,00	57	4
6829691	4XNEM05002SZT	5,0	6	4,70	10,00	15,00	57	4
6829696	4XNEM06002SZT	6,0	6	5,64	12,00	18,00	57	4
6829882	4XNEM08003SZT	8,0	8	7,52	16,00	24,00	63	4
6829889	4XNEM10004SZT	10,0	10	9,40	20,00	30,00	72	4
6830076	4XNEM12005SZT	12,0	12	11,28	24,00	36,00	83	4
6830284	4XNEM16006SZT	16,0	16	15,04	32,00	48,00	92	4
6830472	4XNEM20007SZT	20,0	20	18,80	40,00	60,00	115	4

VariMill XTREME • Series 4XNE • Chamfered • 4 Flute • Cylindrical Shank • Metric

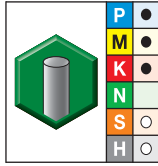
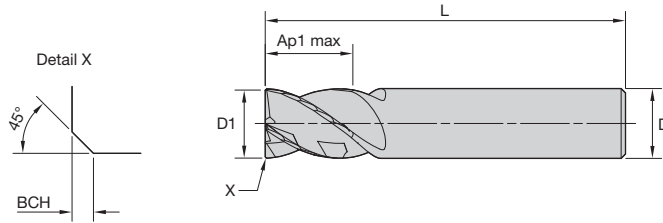

WS15PE

- first choice
- alternate choice

order #	catalogue #	D1	D	length of cut Ap1 max	length L	BCH	ZU
6830283	4X0EM16006CCT	16,0	16	18,00	82	0,30	4

VariMill XTREME • Series 4XNE • Chamfered • 4 Flute • Necked • Weldon® Shank • Metric

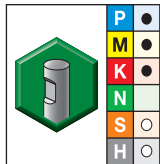
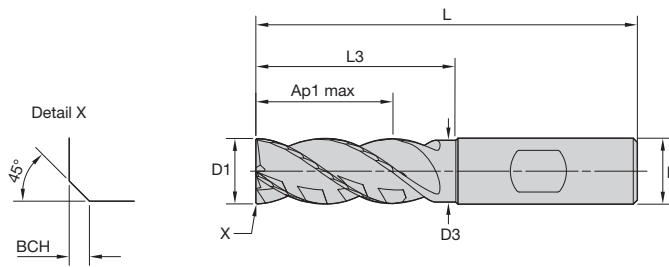

WS15PE

- first choice
- alternate choice

order #	catalogue #	D1	D	D3	length of cut Ap1 max	L3	length L	BCH	ZU
6829319	4XNEM04002CSW	4,0	6	3,76	12,00	16,00	57	0,10	4
6829694	4XNEM05002CSW	5,0	6	4,70	13,00	18,00	57	0,10	4
6829700	4XNEM06002CSW	6,0	6	5,64	13,00	21,00	57	0,10	4
6829887	4XNEM08003CAW	8,0	8	7,52	16,00	27,00	63	0,20	4
6830074	4XNEM10004CAW	10,0	10	9,40	22,00	32,00	72	0,20	4
6830282	4XNEM12005CCW	12,0	12	11,28	26,00	36,00	83	0,30	4
6830285	4XNEM16006CCW	16,0	16	15,04	32,00	48,00	92	0,30	4
6830473	4XNEM20007CCW	20,0	20	18,80	40,00	60,00	115	0,30	4

VariMill XTREME • Series 4XNE • Radiused • 4 Flute • Necked • Cylindrical Shank • Metric

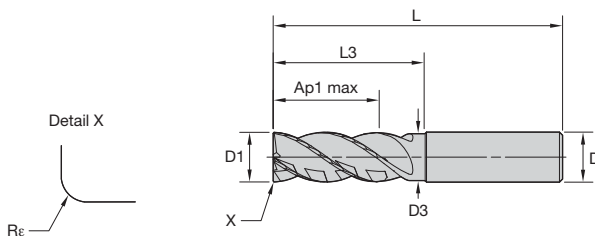
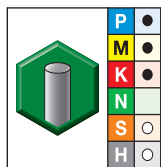

● first choice
○ alternate choice

WS15PE

order #	catalogue #	D1	D	D3	length of cut Ap1 max	L3	length L	Re	ZU
6829317	4XNEM04002RAT	4,0	6	3,76	8,00	12,00	57	0,20	4
6829318	4XNEM04002RET	4,0	6	3,76	8,00	12,00	57	0,50	4
6829692	4XNEM05002RAT	5,0	6	4,70	10,00	15,00	57	0,20	4
6829693	4XNEM05002RET	5,0	6	4,70	10,00	15,00	57	0,50	4
6829697	4XNEM06002RAT	6,0	6	5,64	12,00	18,00	57	0,20	4
6829698	4XNEM06002RET	6,0	6	5,64	12,00	18,00	57	0,50	4
6829699	4XNEM06002RJT	6,0	6	5,64	12,00	18,00	57	1,00	4
6829883	4XNEM08003RAT	8,0	8	7,52	16,00	24,00	63	0,20	4
6829884	4XNEM08003RET	8,0	8	7,52	16,00	24,00	63	0,50	4
6829885	4XNEM08003RJT	8,0	8	7,52	16,00	24,00	63	1,00	4
6829886	4XNEM08003RKT	8,0	8	7,52	16,00	24,00	63	1,50	4
6829890	4XNEM10004RCT	10,0	10	9,40	20,00	30,00	72	0,30	4
6830071	4XNEM10004RET	10,0	10	9,40	20,00	30,00	72	0,50	4
6830072	4XNEM10004RJT	10,0	10	9,40	20,00	30,00	72	1,00	4
6830073	4XNEM10004RKT	10,0	10	9,40	20,00	30,00	72	1,50	4
6830077	4XNEM12005RET	12,0	12	11,28	24,00	36,00	83	0,50	4
6830079	4XNEM12005RKT	12,0	12	11,28	24,00	36,00	83	1,50	4
6830080	4XNEM12005RMT	12,0	12	11,28	24,00	36,00	83	2,00	4
6830281	4XNEM12005RPT	12,0	12	11,28	24,00	36,00	83	3,00	4
6830286	4XNEM16006RET	16,0	16	15,04	32,00	48,00	92	0,50	4
6830288	4XNEM16006RKT	16,0	16	15,04	32,00	48,00	92	1,50	4
6830289	4XNEM16006RPT	16,0	16	15,04	32,00	48,00	92	3,00	4
6830471	4XNEM16006RQT	16,0	16	15,04	32,00	48,00	92	4,00	4
6830474	4XNEM20007RET	20,0	20	18,80	40,00	60,00	115	0,50	4
6830476	4XNEM20007RKT	20,0	20	18,80	40,00	60,00	115	1,50	4
6830477	4XNEM20007RPT	20,0	20	18,80	40,00	60,00	115	3,00	4
6830478	4XNEM20007RRT	20,0	20	18,80	40,00	60,00	115	5,00	4

VariMill XTREME • Series 4XNE • Radiused • 4 Flute • Necked • Safe-Lock™ Shank • Metric

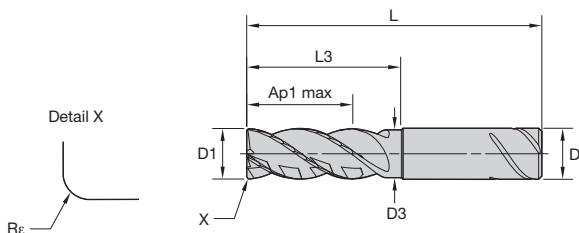
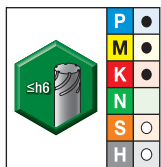



● first choice
○ alternate choice

WS15PE



order #	catalogue #	D1	D	D3	length of cut Ap1 max	L3	length L	Re	ZU
6830078	4XNEM12005RJV	12,0	12	11,28	24,00	36,00	83	1,00	4
6830287	4XNEM16006RJV	16,0	16	15,04	32,00	48,00	92	1,00	4
6830475	4XNEM20007RJV	20,0	20	18,80	40,00	60,00	115	1,00	4

VariMill XTREME • Side Milling and Slotting • Application Data • WS15PE • Metric

Material Group																				
	Side Milling (A) and Slotting (B)			Recommended feed per tooth (fz = mm/th) for side milling (A). For slotting (B), reduce fz by 20%.																
	A		B	WS15PE Cutting Speed – vc m/min			D1 – Diameter													
	ap	ae	ap	min	Start	max	mm	3,0	4,0	5,0	6,0	8,0	10,0	12,0	14,0	16,0	18,0	20,0	25,0	
P	0	1,5 x D1	0,5 x D1	1,25 x D1	150	175	200	fz	0,023	0,031	0,040	0,048	0,066	0,079	0,091	0,102	0,111	0,119	0,125	0,136
	1	1,5 x D1	0,5 x D1	1,25 x D1	150	175	200	fz	0,023	0,031	0,040	0,048	0,066	0,079	0,091	0,102	0,111	0,119	0,125	0,136
	2	1,5 x D1	0,5 x D1	1,25 x D1	140	165	190	fz	0,023	0,031	0,040	0,048	0,066	0,079	0,091	0,102	0,111	0,119	0,125	0,136
	3	1,5 x D1	0,5 x D1	1,25 x D1	120	140	160	fz	0,019	0,026	0,033	0,040	0,055	0,067	0,077	0,087	0,096	0,104	0,111	0,125
	4	1,5 x D1	0,5 x D1	1,25 x D1	90	120	150	fz	0,018	0,024	0,030	0,036	0,049	0,059	0,069	0,077	0,084	0,091	0,097	0,107
	5	1,5 x D1	0,5 x D1	1,25 x D1	60	80	100	fz	0,016	0,021	0,027	0,032	0,044	0,053	0,062	0,070	0,077	0,083	0,089	0,100
M	1	1,5 x D1	0,5 x D1	1,25 x D1	50	65	75	fz	0,013	0,018	0,022	0,027	0,037	0,044	0,051	0,057	0,063	0,067	0,071	0,078
	2	1,5 x D1	0,5 x D1	1,25 x D1	90	100	115	fz	0,019	0,026	0,033	0,040	0,055	0,067	0,077	0,087	0,096	0,104	0,111	0,125
	3	1,5 x D1	0,5 x D1	1,0 x D1	60	65	70	fz	0,013	0,018	0,022	0,027	0,037	0,044	0,051	0,057	0,063	0,067	0,071	0,078
K	1	1,5 x D1	0,5 x D1	1,0 x D1	120	135	150	fz	0,023	0,031	0,040	0,048	0,066	0,079	0,091	0,102	0,111	0,119	0,125	0,136
	2	1,5 x D1	0,5 x D1	1,0 x D1	110	125	140	fz	0,019	0,026	0,033	0,040	0,055	0,067	0,077	0,087	0,096	0,104	0,111	0,125
	3	1,5 x D1	0,5 x D1	1,0 x D1	110	120	130	fz	0,016	0,021	0,027	0,032	0,044	0,053	0,062	0,070	0,077	0,083	0,089	0,100
S	1	1,5 x D1	0,5 x D1	0,75 x D1	50	70	90	fz	0,017	0,023	0,030	0,036	0,050	0,061	0,070	0,079	0,087	0,095	0,101	0,114
	2	1,5 x D1	0,5 x D1	0,75 x D1	25	30	40	fz	0,009	0,013	0,016	0,019	0,026	0,032	0,037	0,042	0,046	0,050	0,054	0,061
	3	1,5 x D1	0,5 x D1	0,5 x D1	25	30	40	fz	0,009	0,013	0,016	0,019	0,026	0,032	0,037	0,042	0,046	0,050	0,054	0,061
	4	1,5 x D1	0,5 x D1	1,25 x D1	50	55	60	fz	0,011	0,016	0,021	0,026	0,037	0,045	0,052	0,058	0,064	0,069	0,074	0,084
H	1	1,5 x D1	0,5 x D1	1,0 x D1	80	110	140	fz	0,018	0,024	0,030	0,036	0,049	0,059	0,069	0,077	0,084	0,091	0,097	0,107
	2	1,5 x D1	0,5 x D1	1,0 x D1	70	90	120	fz	0,013	0,018	0,022	0,027	0,037	0,044	0,051	0,057	0,063	0,067	0,071	0,078

NOTE: See page B92 for more information on VARIMILL XTREME adjustment factors for feed calculations.

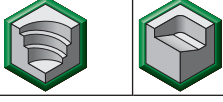
VariMill XTREME • Ramping • Application Data • WS15PE • Metric

Material Group	Helical Interpolation/Ramping 0°-15°																				
		WS15PE			Recommended feed per tooth (fz = mm/z) for helical interpolation and ramping – fz x 2																
		Cutting Speed – vc m/min			Diameter – D1 [Ømin – Ømax]																
		Max Depth	min	Start	max	mm min-max	3,0-5,7	4,0-7,6	5,0-9,5	6,0-11,4	8,0-15,2	10,0-19,0	12,0-22,8	14,0-26,6	16,0-30,4	18,0-34,2	20,0-38,0	25,0-47,5			
P	0	1,25 x D1	150	175	200	fz	0,023	0,031	0,040	0,048	0,066	0,079	0,091	0,102	0,111	0,119	0,125	0,136			
	1	1,25 x D1	150	175	200	fz	0,023	0,031	0,040	0,048	0,066	0,079	0,091	0,102	0,111	0,119	0,125	0,136			
	2	1,25 x D1	140	165	190	fz	0,023	0,031	0,040	0,048	0,066	0,079	0,091	0,102	0,111	0,119	0,125	0,136			
	3	1,25 x D1	120	140	160	fz	0,019	0,026	0,033	0,040	0,055	0,067	0,077	0,087	0,096	0,104	0,111	0,125			
	4	1,25 x D1	90	120	150	fz	0,018	0,024	0,030	0,036	0,049	0,059	0,069	0,077	0,084	0,091	0,097	0,107			
	5	1,25 x D1	60	80	100	fz	0,016	0,021	0,027	0,032	0,044	0,053	0,062	0,070	0,077	0,083	0,089	0,100			
M	1	1,25 x D1	90	100	115	fz	0,019	0,026	0,033	0,040	0,055	0,067	0,077	0,087	0,096	0,104	0,111	0,125			
	2	1,25 x D1	60	70	80	fz	0,016	0,021	0,027	0,032	0,044	0,053	0,062	0,070	0,077	0,083	0,089	0,100			
	3	1,0 x D1	60	65	70	fz	0,013	0,018	0,022	0,027	0,037	0,044	0,051	0,057	0,063	0,067	0,071	0,078			
K	1	1,0 x D1	120	135	150	fz	0,023	0,031	0,040	0,048	0,066	0,079	0,091	0,102	0,111	0,119	0,125	0,136			
	2	1,0 x D1	110	125	140	fz	0,019	0,026	0,033	0,040	0,055	0,067	0,077	0,087	0,096	0,104	0,111	0,125			
	3	1,0 x D1	110	120	130	fz	0,016	0,021	0,027	0,032	0,044	0,053	0,062	0,070	0,077	0,083	0,089	0,100			
S	1	0,75 x D1	50	70	90	fz	0,017	0,023	0,030	0,036	0,050	0,061	0,070	0,079	0,087	0,095	0,101	0,114			
	2	0,75 x D1	25	30	40	fz	0,009	0,013	0,016	0,019	0,026	0,032	0,037	0,042	0,046	0,050	0,054	0,061			
	3	0,5 x D1	25	30	40	fz	0,009	0,013	0,016	0,019	0,026	0,032	0,037	0,042	0,046	0,050	0,054	0,061			
	4	1,25 x D1	50	55	60	fz	0,011	0,016	0,021	0,026	0,037	0,045	0,052	0,058	0,064	0,069	0,074	0,084			
H	1	1,0 x D1	80	110	140	fz	0,018	0,024	0,030	0,036	0,049	0,059	0,069	0,077	0,084	0,091	0,097	0,107			
	2	1,0 x D1	70	90	120	fz	0,013	0,018	0,022	0,027	0,037	0,044	0,051	0,057	0,063	0,067	0,071	0,078			

VariMill XTREME • Ramping • Application Data • WS15PE • Metric

Material Group	Max Depth	Helical Interpolation/Ramping			Recommended feed per tooth (fz = mm/z) for helical interpolation and ramping – fz x 2													
		15°–30°			Diameter – D1 [Ømin – Ømax]													
		Cutting Speed – vc m/min			mm min-max	3,0	4,0	5,0	6,0	8,0	10,0	12,0	14,0	16,0	18,0	20,0	25,0	
		min	Start	max	3,5–5,7	4,6–7,6	5,8–9,5	6,9–11,4	9,2–15,2	11,5–19,0	13,8–22,8	16,1–26,6	18,4–30,4	20,7–34,2	23,0–38,0	28,8–47,5		
P	0	1,25 x D1	150	165	175	fz	0,017	0,023	0,030	0,036	0,050	0,059	0,068	0,076	0,083	0,089	0,094	0,102
	1	1,25 x D1	150	165	175	fz	0,017	0,023	0,030	0,036	0,050	0,059	0,068	0,076	0,083	0,089	0,094	0,102
	2	1,25 x D1	140	155	165	fz	0,017	0,023	0,030	0,036	0,050	0,059	0,068	0,076	0,083	0,089	0,094	0,102
	3	1,25 x D1	120	130	140	fz	0,014	0,019	0,025	0,030	0,041	0,050	0,058	0,065	0,072	0,078	0,083	0,094
	4	1,25 x D1	90	105	120	fz	0,013	0,018	0,022	0,027	0,037	0,045	0,051	0,058	0,063	0,068	0,073	0,080
	5	1,25 x D1	60	70	80	fz	0,012	0,016	0,020	0,024	0,033	0,040	0,046	0,052	0,058	0,062	0,067	0,075
M	6	1,25 x D1	50	55	65	fz	0,010	0,013	0,017	0,020	0,028	0,033	0,038	0,043	0,047	0,050	0,053	0,059
	1	1,25 x D1	90	95	100	fz	0,014	0,019	0,025	0,030	0,041	0,050	0,058	0,065	0,072	0,078	0,083	0,094
	2	1,25 x D1	60	65	70	fz	0,012	0,016	0,020	0,024	0,033	0,040	0,046	0,052	0,058	0,062	0,067	0,075
K	3	1,0 x D1	60	62	65	fz	0,010	0,013	0,017	0,020	0,028	0,033	0,038	0,043	0,047	0,050	0,053	0,059
	1	1,0 x D1	120	130	135	fz	0,017	0,023	0,030	0,036	0,050	0,059	0,068	0,076	0,083	0,089	0,094	0,102
	2	1,0 x D1	110	120	125	fz	0,014	0,019	0,025	0,030	0,041	0,050	0,058	0,065	0,072	0,078	0,083	0,094
S	3	1,0 x D1	110	115	120	fz	0,012	0,016	0,020	0,024	0,033	0,040	0,046	0,052	0,058	0,062	0,067	0,075
	1	0,75 x D1	50	60	70	fz	0,014	0,019	0,025	0,030	0,041	0,050	0,058	0,065	0,072	0,078	0,083	0,094
	2	0,75 x D1	25	27	30	fz	0,008	0,010	0,013	0,016	0,022	0,026	0,031	0,035	0,038	0,042	0,045	0,051
	3	0,5 x D1	25	27	30	fz	0,008	0,010	0,013	0,016	0,022	0,026	0,031	0,035	0,038	0,042	0,045	0,051
H	4	1,25 x D1	50	52	55	fz	0,009	0,013	0,017	0,021	0,030	0,037	0,043	0,048	0,053	0,057	0,061	0,069
	1	1,0 x D1	80	95	110	fz	0,013	0,018	0,022	0,027	0,037	0,045	0,051	0,058	0,063	0,068	0,073	0,080
	2	1,0 x D1	70	80	90	fz	0,010	0,013	0,017	0,020	0,028	0,033	0,038	0,043	0,047	0,050	0,053	0,059

Material Group	Max Depth	Helical Interpolation/Ramping			Recommended feed per tooth (fz = mm/z) for helical interpolation and ramping – fz x 2													
		30°–45°			Diameter – D1 [Ømin – Ømax]													
		Cutting Speed – vc m/min			mm min-max	3,0	4,0	5,0	6,0	8,0	10,0	12,0	14,0	16,0	18,0	20,0	25,0	
		min	Start	max	3,5–5,7	4,6–7,6	5,8–9,5	6,9–11,4	9,2–15,2	11,5–19,0	13,8–22,8	16,1–26,6	18,4–30,4	20,7–34,2	23,0–38,0	28,8–47,5		
P	0	1,25 x D1	140	150	165	fz	0,014	0,019	0,024	0,029	0,040	0,048	0,055	0,061	0,067	0,071	0,075	0,082
	1	1,25 x D1	140	150	165	fz	0,014	0,019	0,024	0,029	0,040	0,048	0,055	0,061	0,067	0,071	0,075	0,082
	2	1,25 x D1	140	150	165	fz	0,014	0,019	0,024	0,029	0,040	0,048	0,055	0,061	0,067	0,071	0,075	0,082
	3	1,25 x D1	105	115	120	fz	0,011	0,015	0,020	0,024	0,033	0,040	0,046	0,052	0,058	0,062	0,067	0,075
	4	1,25 x D1	90	100	110	fz	0,011	0,014	0,018	0,022	0,030	0,036	0,041	0,046	0,051	0,055	0,058	0,064
	5	1,25 x D1	70	75	80	fz	0,009	0,013	0,016	0,019	0,026	0,032	0,037	0,042	0,046	0,050	0,053	0,060
M	6	1,25 x D1	55	60	65	fz	0,008	0,011	0,013	0,016	0,022	0,027	0,031	0,034	0,038	0,040	0,043	0,047
	1	1,25 x D1	75	85	90	fz	0,011	0,015	0,020	0,024	0,033	0,040	0,046	0,052	0,058	0,062	0,067	0,075
	2	1,25 x D1	50	55	60	fz	0,009	0,013	0,016	0,019	0,026	0,032	0,037	0,042	0,046	0,050	0,053	0,060
K	3	1,0 x D1	45	50	55	fz	0,008	0,011	0,013	0,016	0,022	0,027	0,031	0,034	0,038	0,040	0,043	0,047
	1	1,0 x D1	110	120	130	fz	0,014	0,019	0,024	0,029	0,040	0,048	0,055	0,061	0,067	0,071	0,075	0,082
	2	1,0 x D1	100	110	120	fz	0,011	0,015	0,020	0,024	0,033	0,040	0,046	0,052	0,058	0,062	0,067	0,075
S	3	1,0 x D1	90	100	110	fz	0,009	0,013	0,016	0,019	0,026	0,032	0,037	0,042	0,046	0,050	0,053	0,060
	1	0,75 x D1	80	85	90	fz	0,011	0,015	0,020	0,024	0,033	0,040	0,046	0,052	0,058	0,062	0,067	0,075
	2	0,75 x D1	20	25	28	fz	0,006	0,008	0,011	0,013	0,017	0,021	0,025	0,028	0,031	0,033	0,036	0,040
	3	0,5 x D1	20	25	28	fz	0,006	0,008	0,011	0,013	0,017	0,021	0,025	0,028	0,031	0,033	0,036	0,040
H	4	1,25 x D1	35	40	45	fz	0,008	0,010	0,014	0,017	0,024	0,029	0,034	0,038	0,042	0,046	0,049	0,055
	1	1,0 x D1	75	80	85	fz	0,011	0,014	0,018	0,022	0,030	0,036	0,041	0,046	0,051	0,055	0,058	0,064
	2	1,0 x D1	65	70	75	fz	0,008	0,011	0,013	0,016	0,022	0,027	0,031	0,034	0,038	0,040	0,043	0,047

VariMill XTREME • Plunging/Drilling • Application Data • WS15PE • Metric

Material Group	Max Depth	Applicable	Coolant	Recommended feed per revolution (fn =mm/rev) for plunging and drilling																
				WS15PE Cutting Speed – vc m/min			D1 – Diameter													
				min	Start	max	mm	3,0	4,0	5,0	6,0	8,0	10,0	12,0	14,0	16,0	18,0	20,0	25,0	
P	0	1,5 x D	●	Preferred	140	150	165	fn	0,033	0,040	0,045	0,055	0,065	0,080	0,095	0,110	0,120	0,140	0,160	0,180
	1	1,5 x D	●	Required	140	150	165	fn	0,033	0,040	0,045	0,055	0,065	0,080	0,095	0,110	0,120	0,140	0,160	0,180
	2	1,5 x D	●	Required	140	150	165	fn	0,033	0,040	0,045	0,055	0,065	0,080	0,095	0,110	0,120	0,140	0,160	0,180
	3	1 x D	●	Required	105	115	120	fn	0,020	0,028	0,033	0,040	0,050	0,060	0,070	0,085	0,100	0,110	0,125	0,150
	4	1 x D	●	Required	90	100	110	fn	0,020	0,028	0,033	0,040	0,050	0,060	0,070	0,085	0,100	0,110	0,125	0,150
	5	0,5 x D	●	Required	70	75	80	fn	0,014	0,018	0,020	0,025	0,035	0,040	0,050	0,055	0,065	0,075	0,085	0,100
M	1	0,75 x D	●	Required	75	85	90	fn	0,020	0,028	0,033	0,040	0,050	0,060	0,070	0,085	0,100	0,110	0,125	0,150
	2	0,5 x D	●	Required	50	55	60	fn	0,014	0,018	0,020	0,025	0,035	0,040	0,050	0,055	0,065	0,075	0,085	0,100
	3	0,5 x D	●	Required	45	50	55	fn	0,014	0,018	0,020	0,025	0,035	0,040	0,050	0,055	0,065	0,075	0,085	0,100
K	1	1,5 x D	●	Preferred	110	120	130	fn	0,033	0,040	0,045	0,055	0,065	0,080	0,095	0,110	0,120	0,140	0,160	0,180
	2	1 x D	●	Required	100	110	120	fn	0,020	0,028	0,033	0,040	0,050	0,060	0,070	0,085	0,100	0,110	0,125	0,150
	3	1 x D	●	Required	90	100	110	fn	0,020	0,028	0,033	0,040	0,050	0,060	0,070	0,085	0,100	0,110	0,125	0,150
S	1	0,3 x D	○	Required	80	85	90	fn	0,020	0,028	0,033	0,040	0,050	0,060	0,070	0,085	0,100	0,110	0,125	0,150
	2	0,1 x D	○	Required	20	25	28	fn	0,010	0,012	0,015	0,018	0,022	0,028	0,033	0,040	0,045	0,050	0,060	0,070
	3	0,1 x D	○	Required	20	25	28	fn	0,010	0,012	0,015	0,018	0,022	0,028	0,033	0,040	0,045	0,050	0,060	0,070
	4	0,2 x D	○	Required	35	40	45	fn	0,014	0,018	0,020	0,025	0,035	0,040	0,050	0,055	0,065	0,075	0,085	0,100
H	1	0,3 x D	○	Required	75	80	85	fn	0,020	0,028	0,033	0,040	0,050	0,060	0,070	0,085	0,100	0,110	0,125	0,150
	2	0,2 x D	○	Required	65	70	75	fn	0,014	0,018	0,020	0,025	0,035	0,040	0,050	0,055	0,065	0,075	0,085	0,100

VariMill XTREME • Adjustment Factor Table for Feed Calculation

Metric

	Ae/D	2%	4%	5%	8%	10%	20%	30%	40%	50%
Speed factor	Kv	2	1,5	1,45	1,4	1,35	1,25	1,2	1	1
Feed factor	KFz	2,4	2,3	2,2	2	1,7	1,25	1,02	1	1

To calculate application-specific cutting data, please use Kv coefficient table to the right for adaptation of cutting speed and KFz for feed, respectively.

$$Vc_{new} = Vc * Kv$$

$$Fz_{new} = IPT * KFz$$

Calculation example:

Application: D = 20mm; M2 material group;

Ae = 2mm

Cutting data recommendation: Vc = 80 m/min;

Fz = 0,089 mm/th

Adjustment coefficients: Ae = 2mm equals 10,0%;

Kv = 1,35; KFz = 1,7

Final cutting data recommendation:

Vc_{new} = 80 * 1,35 = 108 m/min

Fz_{new} = 0,089 * 1,7 = 0,15 mm/min

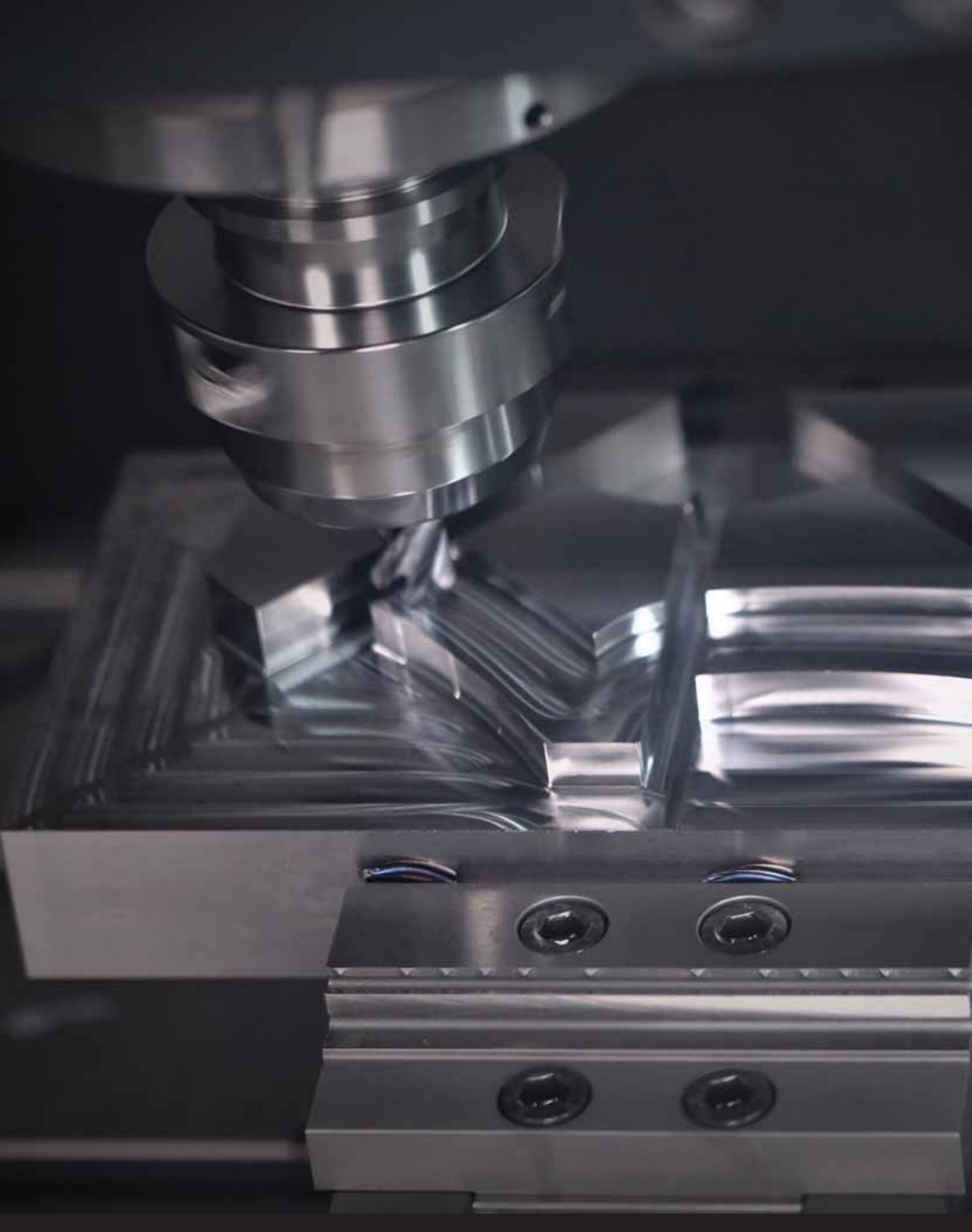

The VariMill I end mill family is for CNC machine shops looking for an all-around tool with a wide standard product range capable of machining multiple materials, covering configurations from a long length-of-cut through a ball nose profile for 3D machining applications.

Features and Benefits

Unequal flute spacing to cut harmonics and reduce the development of vibrations during cutting.

Center cutting for improved ramping capabilities and plunging.

38° helix angle to provide the best combination between a roughing and a finishing tool.

Unique core design to offer maximum room for chip evacuation while keeping the tool design stable.



VariMill I offers plunging, slotting, and profiling at the highest possible feed rates for a wide range of materials. It is designed to provide maximum metal removal rates (MRR) and to achieve superior surface conditions. A wide range of diameters and corner configurations, such as chamfer, radii, and sharp edges, are available from stock.

STABLE

Unequal flute spacing design to ensure low vibrations and high cutting stability.

EASY

With its advanced geometry, machinist will be able to apply VariMill I with confidence.

VERSATILE

Roughing and finishing operations in one single tool with the capability to work on multiple materials.

CHATTER-FREE VERSATILITY

PRODUCT

SOLID CARBIDE END MILL

GRADE

WP15PE
WS15PE
TiAlN

FLUTE

4

DIAMETER RANGE

METRIC

4–25mm

INDUSTRY



GENERAL
ENGINEERING



AEROSPACE



ENERGY



TRANSPORTATION

APPLICATIONS

MATERIALS

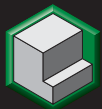

SIDE MILLING

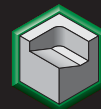

RAMPING



HELICAL
INTERPOLATION



SLOTTING



DYNAMIC MILLING



PLUNGING

VariMill I • Series 4777 • Square End • 4 Flute • Metric

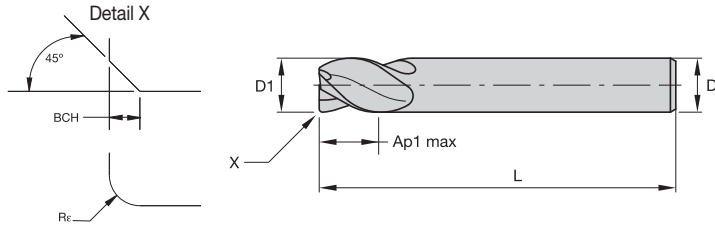
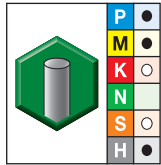

● first choice
○ alternate choice

WP15PE

order #	catalogue #	D1	D	length of cut Ap1 max	length L	R _ε	BCH	ZU
5576753	477704001T	4,0	6	12,00	55	0,20	—	4
5576751	477704002T	4,0	6	12,00	55	—	0,40	4
5576754	4777040Z2T	4,0	6	12,00	55	—	—	4
5576755	477705002T	5,0	6	13,00	57	—	0,40	4
5576757	477705012T	5,0	6	13,00	57	0,20	—	4
5576758	4777050Z2T	5,0	6	13,00	57	—	—	4
5576759	477706002T	6,0	6	13,00	57	—	0,40	4
5576760	477706002W	6,0	6	13,00	57	—	0,40	4
5576761	477706012T	6,0	6	13,00	57	0,20	—	4
6471861	4777060R2TE	6,0	6	13,00	57	0,50	—	4
6471862	4777060R2TJ	6,0	6	13,00	57	1,00	—	4
5576762	4777060Z2T	6,0	6	13,00	57	—	—	4
5576763	477707003T	7,0	8	16,00	63	—	0,40	4
5576765	477707013T	7,0	8	16,00	63	0,20	—	4
5576766	4777070Z3T	7,0	8	16,00	63	—	—	4
5576767	477708003T	8,0	8	16,00	63	—	0,40	4
5576768	477708003W	8,0	8	16,00	63	—	0,40	4
5576769	477708013T	8,0	8	16,00	63	0,20	—	4
6471863	4777080R3TE	8,0	8	16,00	63	0,50	—	4
6471864	4777080R3TJ	8,0	8	16,00	63	1,00	—	4
6471865	4777080R3TK	8,0	8	16,00	63	1,50	—	4
6471866	4777080R3TM	8,0	8	16,00	63	2,00	—	4
5576770	4777080Z3T	8,0	8	16,00	63	—	—	4
5576771	477709004T	9,0	10	19,00	72	—	0,50	4
5576773	477709014T	9,0	10	19,00	72	0,20	—	4
5576774	4777090Z4T	9,0	10	19,00	72	—	—	4
5576775	477710004T	10,0	10	22,00	72	—	0,50	4
5576776	477710004W	10,0	10	22,00	72	—	0,50	4
5576777	477710024T	10,0	10	22,00	72	0,30	—	4
6471867	4777100R4TE	10,0	10	22,00	72	0,50	—	4
6471868	4777100R4TJ	10,0	10	22,00	72	1,00	—	4
6471869	4777100R4TK	10,0	10	22,00	72	1,50	—	4
6471870	4777100R4TM	10,0	10	22,00	72	2,00	—	4
6471871	4777100R4TN	10,0	10	22,00	72	2,50	—	4
5576778	4777100Z4T	10,0	10	22,00	72	—	—	4
5576779	4777110Z5T	11,0	12	26,00	83	—	—	4
5576790	477712005T	12,0	12	26,00	83	—	0,50	4
5576791	477712005W	12,0	12	26,00	83	—	0,50	4
5576792	4777120Z5T	12,0	12	26,00	83	0,30	—	4
6471872	4777120R5TE	12,0	12	26,00	83	0,50	—	4
6471873	4777120R5TJ	12,0	12	26,00	83	1,00	—	4
6471874	4777120R5TK	12,0	12	26,00	83	1,50	—	4
6471875	4777120R5TM	12,0	12	26,00	83	2,00	—	4
6471876	4777120R5TN	12,0	12	26,00	83	2,50	—	4
6471877	4777120R5TP	12,0	12	26,00	83	3,00	—	4
5576793	4777120Z5T	12,0	12	26,00	83	—	—	4
5576795	477714014W	14,0	14	26,00	83	—	0,50	4
5576794	477714015T	14,0	14	26,00	83	—	0,50	4
5576796	477716006T	16,0	16	32,00	92	—	0,50	4
5576797	477716006W	16,0	16	32,00	92	—	0,50	4
5576798	4777160Z6T	16,0	16	32,00	92	0,30	—	4
6471878	4777160R6TJ	16,0	16	32,00	92	1,00	—	4
6471879	4777160R6TM	16,0	16	32,00	92	2,00	—	4
6471880	4777160R6TP	16,0	16	32,00	92	3,00	—	4
6471891	4777160R6TQ	16,0	16	32,00	92	4,00	—	4
5576799	4777160Z6T	16,0	16	32,00	92	—	—	4
5576810	477718018T	18,0	18	32,00	92	—	0,50	4
5576812	477720007T	20,0	20	38,00	104	—	0,50	4
5576813	477720007W	20,0	20	38,00	104	—	0,50	4
5576814	47772002T	20,0	20	38,00	104	0,30	—	4
6471892	4777200R7TP	20,0	20	38,00	104	3,00	—	4
5576816	477725008T	25,0	25	45,00	121	—	0,50	4
5576817	477725008W	25,0	25	45,00	121	—	0,50	4
6471893	4777250R8TR	25,0	25	45,00	121	5,00	—	4

VariMill I • Series 4717 • Square End • Long Length • 4 Flute • Metric

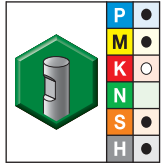
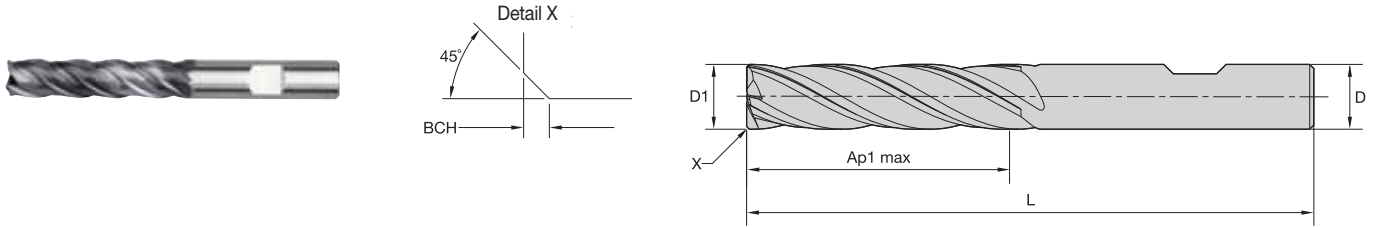

TIAIN-LW

● first choice
○ alternate choice

order #	catalogue #	D1	D	length of cut Ap1 max	length L	BCH	ZU
3641112	471706002LW	6,0	6	32,00	76	0,40	4
3641113	471708003LW	8,0	8	32,00	87	0,40	4
3641114	471710004LW	10,0	10	38,00	89	0,50	4
3641115	471712005LW	12,0	12	51,00	100	0,50	4
3641116	471716006LW	16,0	16	57,00	125	0,50	4
3641117	471720007LW	20,0	20	57,00	125	0,50	4

VariMill I • Series 4727 • Square End • Extended Length • 4 Flute • Metric

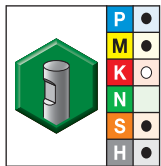
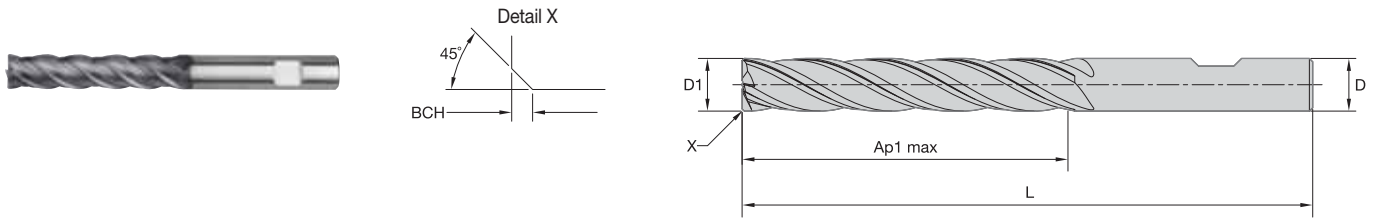

TIAIN-LW

● first choice
○ alternate choice

order #	catalogue #	D1	D	length of cut Ap1 max	length L	BCH	ZU
3641118	472712005LW	12,0	12	76,00	125	0,50	4
3641119	472716006LW	16,0	16	76,00	150	0,50	4
3641120	472720007LW	20,0	20	102,00	175	0,50	4

VariMill I • Series 4778 • Square End • 4 Flute • Metric

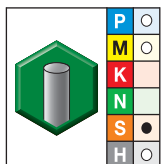
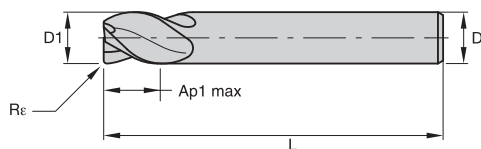

WS15PE

- first choice
- alternate choice

order #	catalogue #	D1	D	length of cut Ap1 max	length L	Re	ZU
2545563	477804002MT	4,0	6	12,00	55	0,20	4
2545564	477805002MT	5,0	6	13,00	57	0,20	4
2545565	477806002MT	6,0	6	13,00	57	0,20	4
2545570	477807003MT	7,0	8	16,00	63	0,20	4
2545603	477808003MT	8,0	8	16,00	63	0,20	4
2601245	477810004MT	10,0	10	22,00	72	0,30	4
2601246	477812005MT	12,0	12	26,00	83	0,30	4
2601248	477814014MT	14,0	14	26,00	83	0,30	4
2601249	477816006MT	16,0	16	32,00	92	0,30	4
2601251	477820007MT	20,0	20	38,00	104	0,30	4

INDEXABLE MILLING

SOLID END MILLING

HOLEMAKING

TAPPING

TURNING

VariMill I • Series 47N7 • Square End • Neck • 4 Flute • Metric

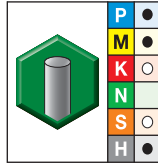
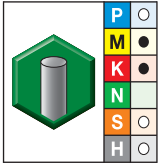
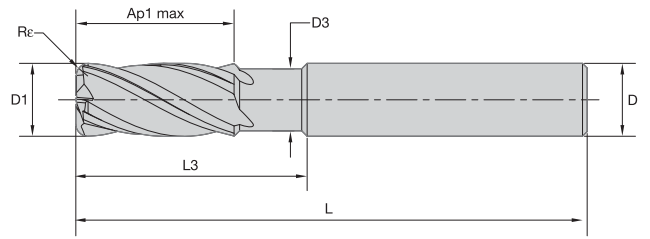
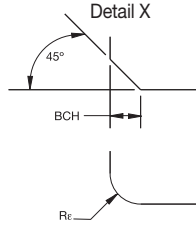

● first choice
○ alternate choice

WP15PE		TiAIN-LT		D1	D	D3	length of cut		length				ZU
order #	catalogue #	order #	catalogue #				Ap1 max	L3	L	Re	BCH		
—	—	3462450	47N704002LT	4,0	6	3,60	12,00	16,00	55	0,40	—	—	4
—	—	3462451	47N704012LT	4,0	6	3,60	12,00	16,00	55	0,50	—	—	4
—	—	3462453	47N704022LT	4,0	6	3,60	12,00	16,00	55	1,00	—	—	4
—	—	3462454	47N705002LT	5,0	6	4,60	13,00	18,00	57	0,50	—	—	4
—	—	3462455	47N705012LT	5,0	6	4,60	13,00	18,00	57	1,00	—	—	4
—	—	3462457	47N706002LT	6,0	6	5,50	13,00	21,00	57	0,50	—	—	4
—	—	3462459	47N706012LT	6,0	6	5,50	13,00	21,00	57	1,00	—	—	4
6522659	47N7060R2TK	3462461	47N706022LT	6,0	6	5,50	13,00	21,00	57	1,50	—	—	4
6522658	47N7060C2W	—	—	6,0	6	5,50	13,00	21,00	57	—	0,40	—	4
—	—	3462462	47N708003LT	8,0	8	7,50	16,00	27,00	63	0,50	—	—	4
—	—	3462464	47N708013LT	8,0	8	7,50	16,00	27,00	63	1,00	—	—	4
6522681	47N7080R3TK	3462466	47N708023LT	8,0	8	7,50	16,00	27,00	63	1,50	—	—	4
—	—	3462467	47N708033LT	8,0	8	7,50	16,00	27,00	63	2,00	—	—	4
6522660	47N7080C3W	—	—	8,0	8	7,50	16,00	27,00	63	—	0,40	—	4
—	—	3462468	47N710004LT	10,0	10	9,50	22,00	32,00	72	0,50	—	—	4
—	—	3462470	47N710014LT	10,0	10	9,50	22,00	32,00	72	1,00	—	—	4
6522683	47N7100R4TK	3462472	47N710024LT	10,0	10	9,50	22,00	32,00	72	1,50	—	—	4
—	—	3462473	47N710034LT	10,0	10	9,50	22,00	32,00	72	2,00	—	—	4
6522682	47N7100C4W	—	—	10,0	10	9,50	22,00	32,00	72	—	0,50	—	4
—	—	3462475	47N712005LT	12,0	12	11,50	26,00	38,00	83	0,50	—	—	4
—	—	3462477	47N712015LT	12,0	12	11,50	26,00	38,00	83	1,00	—	—	4
6522685	47N7120R5TK	3462479	47N712025LT	12,0	12	11,50	26,00	38,00	83	1,50	—	—	4
—	—	3462480	47N712035LT	12,0	12	11,50	26,00	38,00	83	2,00	—	—	4
—	—	3462482	47N712045LT	12,0	12	11,50	26,00	38,00	83	4,00	—	—	4
6522684	47N7120C5W	—	—	12,0	12	11,50	26,00	38,00	83	—	0,50	—	4
6522686	47N7120R5TP	—	—	12,0	12	11,50	26,00	38,00	83	3,00	—	—	4
—	—	3462484	47N716006LT	16,0	16	15,00	32,00	44,00	92	1,00	—	—	4
—	—	3462486	47N716016LT	16,0	16	15,00	32,00	44,00	92	2,00	—	—	4
—	—	3462488	47N716026LT	16,0	16	15,00	32,00	44,00	92	4,00	—	—	4
6522687	47N7160C6W	—	—	16,0	16	15,00	32,00	44,00	92	—	0,50	—	4
6522688	47N7160R6TE	—	—	16,0	16	15,00	32,00	44,00	92	0,50	—	—	4
6522689	47N7160R6TP	—	—	16,0	16	15,00	32,00	44,00	92	3,00	—	—	4
3462491	47N720007MT	3462490	47N720007LT	20,0	20	19,00	38,00	55,00	104	1,00	—	—	4
—	—	3462492	47N720017LT	20,0	20	19,00	38,00	55,00	104	2,00	—	—	4
6522690	47N7200C7W	—	—	20,0	20	19,00	38,00	55,00	104	—	0,50	—	4
6522701	47N7200R7TE	—	—	20,0	20	19,00	38,00	55,00	104	0,50	—	—	4
6522702	47N7200R7TP	—	—	20,0	20	19,00	38,00	55,00	104	3,00	—	—	4
6522703	47N7200R7TR	—	—	20,0	20	19,00	38,00	55,00	104	5,00	—	—	4

INDEXABLE MILLING

SOLID END MILLING

HOLEMAKING

TAPPING

TURNING

INDEXABLE MILLING

SOLID END MILLING

HOLEMAKING

TAPPING

TURNING

VariMill I • Series 47N6 • Square End • Long Neck • 4 Flute • Metric

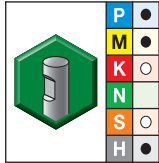
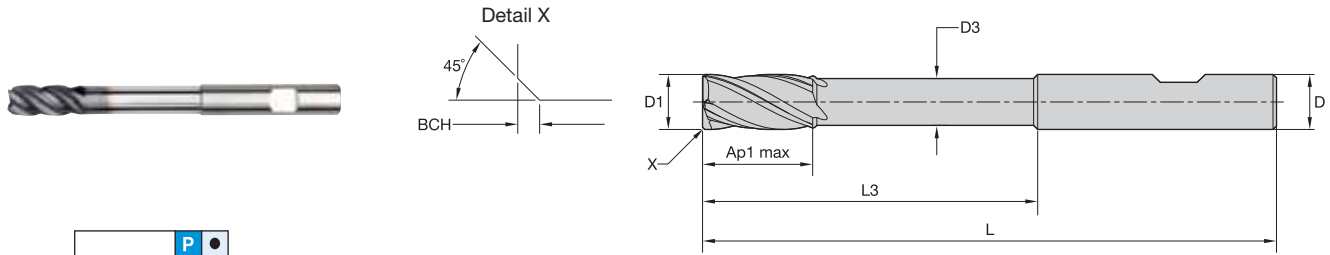

TiAlN-LW

● first choice
○ alternate choice

order #	catalogue #	D1	D	D3	length of cut Ap1 max	L3	length L	BCH	ZU
4067705	47N606002LW	6,0	6	5,50	12,00	42,00	100	0,40	4
4067706	47N608003LW	8,0	8	7,30	16,00	62,00	100	0,40	4
4067707	47N610004LW	10,0	10	9,10	20,00	60,00	100	0,50	4
4067708	47N612005LW	12,0	12	11,00	24,00	73,00	125	0,50	4
4067709	47N616006LW	16,0	16	14,56	32,00	100,00	150	0,50	4
4067710	47N620007LW	20,0	20	18,20	40,00	98,00	175	0,50	4

VariMill I • Series 47N0 • Ball Nose • Neck • 4 Flute • Metric

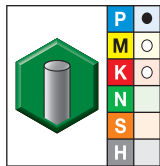
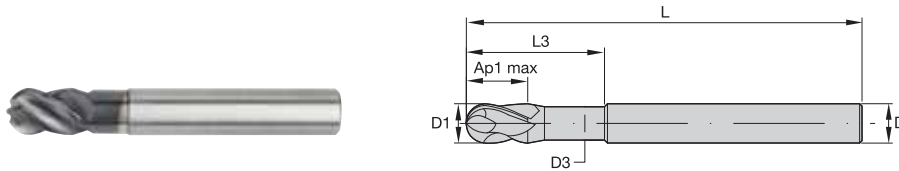

WP15PE

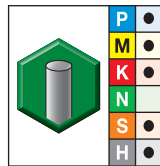

TiAlN-LT

● first choice
○ alternate choice

order #	catalogue #	order #	catalogue #	D1	D	D3	length of cut Ap1 max	L3	length L	ZU
5576818	47N005002T	2605589	47N005002LT	5,0	6	4,70	9,00	15,00	57	4
5576819	47N006002T	2605590	47N006002LT	6,0	6	5,64	10,00	15,00	57	4
5576820	47N008003T	2605591	47N008003LT	8,0	8	7,52	12,00	20,00	63	4
5576821	47N010004T	2605592	47N010004LT	10,0	10	9,40	14,00	25,00	72	4
5576822	47N012005T	2605593	47N012005LT	12,0	12	11,28	16,00	30,00	83	4
5576823	47N016006T	—	—	16,0	16	15,04	22,00	38,00	92	4
5576824	47N020007T	—	—	20,0	20	18,80	26,00	50,00	104	4

VariMill I • Series 4777 • Application Data • WP15PE • Metric

Material Group	Side Milling (A) and Slotting (B)			WP15PE		Recommended feed per tooth (fz = mm/th) for side milling (A). For slotting (B), reduce fz by 20%.														
	A		B	Cutting Speed – vc m/min		mm	D1 – Diameter													
	ap	ae	ap	min	max		4,0	5,0	6,0	8,0	10,0	12,0	14,0	16,0	18,0	20,0	25,0			
	1,5 x D	0,5 x D	1 x D																	
P	0	1,5 x D	0,5 x D	1 x D	150	–	200	fz	0,028	0,036	0,044	0,060	0,072	0,083	0,092	0,101	0,108	0,114	0,124	
	1	1,5 x D	0,5 x D	1 x D	150	–	200	fz	0,028	0,036	0,044	0,060	0,072	0,083	0,092	0,101	0,108	0,114	0,124	
	2	1,5 x D	0,5 x D	1 x D	140	–	190	fz	0,028	0,036	0,044	0,060	0,072	0,083	0,092	0,101	0,108	0,114	0,124	
	3	1,5 x D	0,5 x D	1 x D	120	–	160	fz	0,023	0,030	0,036	0,050	0,061	0,070	0,079	0,087	0,095	0,101	0,114	
	4	1,5 x D	0,5 x D	0,75 x D	90	–	150	fz	0,021	0,027	0,033	0,045	0,054	0,062	0,070	0,077	0,083	0,088	0,098	
	5	1,5 x D	0,5 x D	1 x D	60	–	100	fz	0,019	0,024	0,029	0,040	0,048	0,056	0,063	0,070	0,076	0,081	0,091	
M	1	1,5 x D	0,5 x D	1 x D	90	–	115	fz	0,023	0,030	0,036	0,050	0,061	0,070	0,079	0,087	0,095	0,101	0,114	
	2	1,5 x D	0,5 x D	1 x D	60	–	80	fz	0,019	0,024	0,029	0,040	0,048	0,056	0,063	0,070	0,076	0,081	0,091	
	3	1,5 x D	0,5 x D	1 x D	60	–	70	fz	0,016	0,020	0,025	0,034	0,040	0,047	0,052	0,057	0,061	0,065	0,071	
K	1	1,5 x D	0,5 x D	1 x D	120	–	150	fz	0,028	0,036	0,044	0,060	0,072	0,083	0,092	0,101	0,108	0,114	0,124	
	2	1,5 x D	0,5 x D	1 x D	110	–	140	fz	0,023	0,030	0,036	0,050	0,061	0,070	0,079	0,087	0,095	0,101	0,114	
	3	1,5 x D	0,5 x D	1 x D	110	–	130	fz	0,019	0,024	0,029	0,040	0,048	0,056	0,063	0,070	0,076	0,081	0,091	
S	1	1,5 x D	0,3 x D	0,3 x D	50	–	90	fz	0,023	0,030	0,036	0,050	0,061	0,070	0,079	0,087	0,095	0,101	0,114	
	2	1,5 x D	0,3 x D	0,3 x D	25	–	40	fz	0,013	0,016	0,019	0,026	0,032	0,037	0,042	0,046	0,050	0,054	0,061	
	3	1,5 x D	0,5 x D	1 x D	25	–	40	fz	0,013	0,016	0,019	0,026	0,032	0,037	0,042	0,046	0,050	0,054	0,061	
	4	1,5 x D	0,5 x D	1 x D	50	–	60	fz	0,016	0,021	0,026	0,037	0,045	0,052	0,058	0,064	0,069	0,074	0,084	
H	1	1,5 x D	0,5 x D	0,75 x D	80	–	140	fz	0,021	0,027	0,033	0,045	0,054	0,062	0,070	0,077	0,083	0,088	0,098	



NOTE: Lower value of cutting speed is used for high stock removal applications or for higher hardness (machinability) within group.
Higher value of cutting speed is used for finishing applications or for lower hardness (machinability) within group.
Above parameters are based on ideal conditions. For smaller taper machining centers, please adjust parameters accordingly on >12mm diameters.

VariMill I • Series 4717 • Application Data • TiAlN-LW • Metric

Material Group	Side Milling (A)								Recommended feed per tooth (fz = mm/th) for side milling (A).									
	Finishing				Roughing				D1 – Diameter									
	A		TiAlN Cutting Speed – vc m/min		A		TiAlN Cutting Speed – vc m/min		mm	6,0	8,0	10,0	12,0	16,0	20,0			
	ap	ae	min	max	ap	ae	min	max										
P	1	Ap1 max	0,05 x D*	300	–	400	Ap1 max	0,2 x D	150	–	200	fz	0,044	0,060	0,072	0,083	0,092	0,114
	2	Ap1 max	0,05 x D*	280	–	380	Ap1 max	0,2 x D	140	–	190	fz	0,044	0,060	0,072	0,083	0,092	0,114
	3	Ap1 max	0,05 x D*	240	–	320	Ap1 max	0,2 x D	120	–	160	fz	0,036	0,050	0,061	0,070	0,079	0,101
	4	Ap1 max	0,05 x D*	180	–	300	Ap1 max	0,2 x D	90	–	150	fz	0,033	0,045	0,054	0,062	0,070	0,088
	5	Ap1 max	0,05 x D*	120	–	200	Ap1 max	0,2 x D	60	–	100	fz	0,029	0,040	0,048	0,056	0,063	0,081
	6	Ap1 max	0,05 x D*	100	–	150	Ap1 max	0,2 x D	50	–	75	fz	0,025	0,034	0,040	0,047	0,052	0,065
M	1	Ap1 max	0,05 x D*	180	–	230	Ap1 max	0,2 x D	90	–	115	fz	0,036	0,050	0,061	0,070	0,079	0,101
	2	Ap1 max	0,05 x D*	120	–	160	Ap1 max	0,2 x D	60	–	80	fz	0,029	0,040	0,048	0,056	0,063	0,081
	3	Ap1 max	0,05 x D*	120	–	140	Ap1 max	0,2 x D	60	–	70	fz	0,025	0,034	0,040	0,047	0,052	0,065
K	1	Ap1 max	0,05 x D*	240	–	300	Ap1 max	0,2 x D	120	–	150	fz	0,044	0,060	0,072	0,083	0,092	0,114
	2	Ap1 max	0,05 x D*	220	–	260	Ap1 max	0,2 x D	110	–	130	fz	0,036	0,050	0,061	0,070	0,079	0,101
	3	Ap1 max	0,05 x D*	200	–	260	Ap1 max	0,2 x D	100	–	130	fz	0,029	0,040	0,048	0,056	0,063	0,081
S	1	Ap1 max	0,05 x D*	50	–	90	Ap1 max	0,2 x D	50	–	90	fz	0,036	0,050	0,061	0,070	0,087	0,101
	2	Ap1 max	0,05 x D*	25	–	40	Ap1 max	0,2 x D	25	–	40	fz	0,019	0,026	0,032	0,037	0,046	0,054
	3	Ap1 max	0,05 x D*	25	–	40	Ap1 max	0,2 x D	25	–	40	fz	0,019	0,026	0,032	0,037	0,046	0,054
	4	Ap1 max	0,05 x D*	50	–	60	Ap1 max	0,2 x D	50	–	60	fz	0,026	0,037	0,045	0,052	0,064	0,074
H	1	Ap1 max	0,05 x D*	160	–	280	Ap1 max	0,2 x D	80	–	140	fz	0,033	0,045	0,054	0,062	0,070	0,088

*For cutting data above, use ae ≤ 0,8mm.
NOTE: Lower value of cutting speed is used for high stock removal applications or for higher hardness (machinability) within group.
Higher value of cutting speed is used for finishing applications or for lower hardness (machinability) within group.
Above parameters are based on ideal conditions. For smaller taper machining centers, please adjust parameters accordingly on >12mm diameters.
For finishing, increase feed per tooth by 20%.

VariMill I • Series 4727 • Application Data • TiAlN-LW • Metric

															
		Side Milling (A)										Recommended feed per tooth (fz = mm/th) for side milling (A).			
Material Group	1	Finishing				Roughing				mm	D1 – Diameter				
		A		TiAlN		A		TiAlN			12,0	16,0	20,0		
		ap	ae	min	max	ap	ae	min	max		fz				
P	1	Ap1 max	0,05 x D*	300	–	400	Ap1 max	0,2 x D	150	–	200	fz	0,083	0,101	0,114
	2	Ap1 max	0,05 x D*	280	–	380	Ap1 max	0,2 x D	140	–	190	fz	0,083	0,101	0,114
	3	Ap1 max	0,05 x D*	240	–	320	Ap1 max	0,2 x D	120	–	160	fz	0,070	0,087	0,101
	4	Ap1 max	0,05 x D*	180	–	300	Ap1 max	0,2 x D	90	–	150	fz	0,062	0,077	0,088
	5	Ap1 max	0,05 x D*	120	–	200	Ap1 max	0,2 x D	60	–	100	fz	0,056	0,070	0,081
	6	Ap1 max	0,05 x D*	100	–	150	Ap1 max	0,2 x D	50	–	75	fz	0,047	0,057	0,065
M	1	Ap1 max	0,05 x D*	180	–	230	Ap1 max	0,2 x D	90	–	115	fz	0,070	0,087	0,101
	2	Ap1 max	0,05 x D*	120	–	160	Ap1 max	0,2 x D	60	–	80	fz	0,056	0,070	0,081
	3	Ap1 max	0,05 x D*	120	–	140	Ap1 max	0,2 x D	60	–	70	fz	0,047	0,057	0,065
K	1	Ap1 max	0,05 x D*	240	–	300	Ap1 max	0,2 x D	120	–	150	fz	0,083	0,101	0,114
	2	Ap1 max	0,05 x D*	220	–	260	Ap1 max	0,2 x D	110	–	130	fz	0,070	0,087	0,101
	3	Ap1 max	0,05 x D*	200	–	260	Ap1 max	0,2 x D	100	–	130	fz	0,056	0,070	0,081
S	1	Ap1 max	0,05 x D*	50	–	90	Ap1 max	0,2 x D	50	–	90	fz	0,070	0,087	0,101
	2	Ap1 max	0,05 x D*	25	–	40	Ap1 max	0,2 x D	25	–	40	fz	0,037	0,046	0,054
	3	Ap1 max	0,05 x D*	25	–	40	Ap1 max	0,2 x D	25	–	40	fz	0,037	0,046	0,054
	4	Ap1 max	0,05 x D*	50	–	60	Ap1 max	0,2 x D	50	–	60	fz	0,052	0,064	0,074
H	1	Ap1 max	0,05 x D*	160	–	280	Ap1 max	0,2 x D	80	–	140	fz	0,062	0,077	0,088

*For cutting data above, use ae ≤ 0,8mm.



NOTE: Lower value of cutting speed is used for high stock removal applications or for higher hardness (machinability) within group.

Higher value of cutting speed is used for finishing applications or for lower hardness (machinability) within group.

Above parameters are based on ideal conditions. For smaller taper machining centers, please adjust parameters accordingly on >12mm diameters.

For finishing, increase feed per tooth by 20%.

VariMill I • Series 4778 • Application Data • WS15PE • Metric

																
		Side Milling (A) and Slotting (B)				WS15PE		Recommended feed per tooth (fz = mm/th) for side milling (A). For slotting (B), reduce fz by 20%.								
Material Group	1	A		B	Cutting Speed – vc m/min		mm	D1 – Diameter								
		ap	ae	ap	min	max		4,0	6,0	8,0	10,0	12,0	16,0	20,0	25,0	
P	1	1,5 x D	0,5 x D	1 x D	150	–	200	fz	0,028	0,044	0,060	0,072	0,083	0,101	0,114	0,124
	2	1,5 x D	0,5 x D	1 x D	140	–	190	fz	0,028	0,044	0,060	0,072	0,083	0,101	0,114	0,124
	3	1,5 x D	0,5 x D	1 x D	120	–	160	fz	0,023	0,036	0,050	0,061	0,070	0,087	0,101	0,114
	4	1,5 x D	0,5 x D	0,75 x D	90	–	150	fz	0,021	0,033	0,045	0,054	0,062	0,077	0,088	0,098
	5	1,5 x D	0,5 x D	1 x D	60	–	100	fz	0,019	0,029	0,040	0,048	0,056	0,070	0,081	0,091
	6	1,5 x D	0,5 x D	0,75 x D	50	–	75	fz	0,016	0,025	0,034	0,040	0,047	0,057	0,065	0,071
M	1	1,5 x D	0,5 x D	1 x D	90	–	115	fz	0,023	0,036	0,050	0,061	0,070	0,087	0,101	0,114
	2	1,5 x D	0,5 x D	1 x D	60	–	80	fz	0,019	0,029	0,040	0,048	0,056	0,070	0,081	0,091
	3	1,5 x D	0,5 x D	1 x D	60	–	70	fz	0,016	0,025	0,034	0,040	0,047	0,057	0,065	0,071
K	1	1,5 x D	0,5 x D	1 x D	120	–	150	fz	0,028	0,044	0,060	0,072	0,083	0,101	0,114	0,124
	2	1,5 x D	0,5 x D	1 x D	110	–	130	fz	0,023	0,036	0,050	0,061	0,070	0,087	0,101	0,114
	3	1,5 x D	0,5 x D	1 x D	100	–	130	fz	0,019	0,029	0,040	0,048	0,056	0,070	0,081	0,091
S	1	1,5 x D	0,3 x D	0,3 x D	50	–	90	fz	0,023	0,036	0,050	0,061	0,070	0,087	0,101	0,114
	2	1,5 x D	0,3 x D	0,3 x D	25	–	40	fz	0,013	0,019	0,026	0,032	0,037	0,046	0,054	0,061
	3	1,5 x D	0,5 x D	1 x D	25	–	40	fz	0,013	0,019	0,026	0,032	0,037	0,046	0,054	0,061
	4	1,5 x D	0,5 x D	1 x D	50	–	60	fz	0,016	0,026	0,037	0,045	0,052	0,064	0,074	0,084
H	1	1,5 x D	0,5 x D	0,75 x D	80	–	140	fz	0,021	0,033	0,045	0,054	0,062	0,077	0,088	0,098

NOTE: Lower value of cutting speed is used for high stock removal applications or for higher hardness (machinability) within group.

Higher value of cutting speed is used for finishing applications or for lower hardness (machinability) within group.

Above parameters are based on ideal conditions. For smaller taper machining centers, please adjust parameters accordingly on >12mm diameters.

VariMill I • Series 47N7 • Application Data • WP15PE • Metric

Material Group	Side Milling (A) and Slotting (B)			WP15PE		Recommended feed per tooth (fz = mm/th) for side milling (A). For slotting (B), reduce fz by 20%.									
	A		B	Cutting Speed – vc m/min			mm	D1 – Diameter							
	ap	ae	ap	min	–	max		4,0	6,0	8,0	10,0	12,0	16,0	20,0	
							fz								
P	1	1,5 x D	0,5 x D	1 x D	150	–	200	fz	0,028	0,044	0,060	0,072	0,083	0,101	0,114
	2	1,5 x D	0,5 x D	1 x D	140	–	190	fz	0,028	0,044	0,060	0,072	0,083	0,101	0,114
	3	1,5 x D	0,5 x D	1 x D	120	–	160	fz	0,023	0,036	0,050	0,061	0,070	0,087	0,101
	4	1,5 x D	0,5 x D	0,75 x D	90	–	150	fz	0,021	0,033	0,045	0,054	0,062	0,077	0,088
	5	1,5 x D	0,5 x D	1 x D	60	–	100	fz	0,019	0,029	0,040	0,048	0,056	0,070	0,081
	6	1,5 x D	0,5 x D	0,75 x D	50	–	75	fz	0,016	0,025	0,034	0,040	0,047	0,057	0,065
M	1	1,5 x D	0,5 x D	1 x D	90	–	115	fz	0,023	0,036	0,050	0,061	0,070	0,087	0,101
	2	1,5 x D	0,5 x D	1 x D	60	–	80	fz	0,019	0,029	0,040	0,048	0,056	0,070	0,081
	3	1,5 x D	0,5 x D	1 x D	60	–	70	fz	0,016	0,025	0,034	0,040	0,047	0,057	0,065
K	1	1,5 x D	0,5 x D	1 x D	120	–	150	fz	0,028	0,044	0,060	0,072	0,083	0,101	0,114
	2	1,5 x D	0,5 x D	1 x D	110	–	130	fz	0,023	0,036	0,050	0,061	0,070	0,087	0,101
	3	1,5 x D	0,5 x D	1 x D	100	–	130	fz	0,019	0,029	0,040	0,048	0,056	0,070	0,081
S	1	1,5 x D	0,3 x D	0,3 x D	50	–	90	fz	0,023	0,036	0,050	0,061	0,070	0,087	0,101
	2	1,5 x D	0,3 x D	0,3 x D	25	–	40	fz	0,013	0,019	0,026	0,032	0,037	0,046	0,054
	3	1,5 x D	0,5 x D	1 x D	25	–	40	fz	0,013	0,019	0,026	0,032	0,037	0,046	0,054
	4	1,5 x D	0,5 x D	1 x D	50	–	60	fz	0,016	0,026	0,037	0,045	0,052	0,064	0,074
H	1	1,5 x D	0,5 x D	0,75 x D	80	–	140	fz	0,021	0,033	0,045	0,054	0,062	0,077	0,088

NOTE: Lower value of cutting speed is used for high stock removal applications or for higher hardness (machinability) within group.
 Higher value of cutting speed is used for finishing applications or for lower hardness (machinability) within group.
 Above parameters are based on ideal conditions. For smaller taper machining centers, please adjust parameters accordingly on >12mm diameters.

VariMill I • Series 47N7 • Application Data • TiAlN • Metric

Material Group	Side Milling (A) and Slotting (B)			TiAlN			Recommended feed per tooth (fz = mm/th) for side milling (A). For slotting (B), reduce fz by 20%.									
	A		B	Cutting Speed – vc m/min			mm	D1 – Diameter								
	ap	ae	ap	min	–	max		4,0	6,0	8,0	10,0	12,0	16,0	20,0		
							fz									
P	1	1,5 x D	0,5 x D	1 x D	150	–	200	fz	0,028	0,044	0,060	0,072	0,083	0,101	0,114	
	2	1,5 x D	0,5 x D	1 x D	140	–	190	fz	0,028	0,044	0,060	0,072	0,083	0,101	0,114	
	3	1,5 x D	0,5 x D	1 x D	120	–	160	fz	0,023	0,036	0,050	0,061	0,070	0,087	0,101	
	4	1,5 x D	0,5 x D	0,75 x D	90	–	150	fz	0,021	0,033	0,045	0,054	0,062	0,077	0,088	
	5	1,5 x D	0,5 x D	1 x D	60	–	100	fz	0,019	0,029	0,040	0,048	0,056	0,070	0,081	
	6	1,5 x D	0,5 x D	0,75 x D	50	–	75	fz	0,016	0,025	0,034	0,040	0,047	0,057	0,065	
M	1	1,5 x D	0,5 x D	1 x D	90	–	115	fz	0,023	0,036	0,050	0,061	0,070	0,087	0,101	
	2	1,5 x D	0,5 x D	1 x D	60	–	80	fz	0,019	0,029	0,040	0,048	0,056	0,070	0,081	
	3	1,5 x D	0,5 x D	1 x D	60	–	70	fz	0,016	0,025	0,034	0,040	0,047	0,057	0,065	
K	1	1,5 x D	0,5 x D	1 x D	120	–	150	fz	0,028	0,044	0,060	0,072	0,083	0,101	0,114	
	2	1,5 x D	0,5 x D	1 x D	110	–	130	fz	0,023	0,036	0,050	0,061	0,070	0,087	0,101	
	3	1,5 x D	0,5 x D	1 x D	100	–	130	fz	0,019	0,029	0,040	0,048	0,056	0,070	0,081	
S	1	1,5 x D	0,3 x D	0,3 x D	50	–	90	fz	0,023	0,036	0,050	0,061	0,070	0,087	0,101	
	2	1,5 x D	0,3 x D	0,3 x D	25	–	40	fz	0,013	0,019	0,026	0,032	0,037	0,046	0,054	
	3	1,5 x D	0,5 x D	1 x D	25	–	40	fz	0,013	0,019	0,026	0,032	0,037	0,046	0,054	
	4	1,5 x D	0,5 x D	1 x D	50	–	60	fz	0,016	0,026	0,037	0,045	0,052	0,064	0,074	
H	1	1,5 x D	0,5 x D	0,75 x D	80	–	140	fz	0,021	0,033	0,045	0,054	0,062	0,077	0,088	

NOTE: Lower value of cutting speed is used for high stock removal applications or for higher hardness (machinability) within group.
 Higher value of cutting speed is used for finishing applications or for lower hardness (machinability) within group.
 Above parameters are based on ideal conditions. For smaller taper machining centers, please adjust parameters accordingly on >12mm diameters.

VariMill I • Series 47N6 • Application Data • TiAlN-LW • Metric

Material Group	Side Milling (A) and Slotting (B)			TiAlN			Recommended feed per tooth (fz = mm/th) for side milling (A). For slotting (B), reduce fz by 20%.							
	A		B	Cutting Speed – vc m/min			mm	D1 – Diameter						
	ap	ae	ap	min	max	6,0		8,0	10,0	12,0	16,0	20,0		
	ap	ae	ap	min	max	fz	fz	fz	fz	fz	fz	fz		
P	0	1,5 x D	0,2 x D	0,5 x D	150	–	200	fz	0,044	0,060	0,072	0,083	0,101	0,114
	1	1,5 x D	0,2 x D	0,5 x D	150	–	200	fz	0,044	0,060	0,072	0,083	0,101	0,114
	2	1,5 x D	0,2 x D	0,5 x D	140	–	190	fz	0,044	0,060	0,072	0,083	0,101	0,114
	3	1,5 x D	0,2 x D	0,5 x D	120	–	160	fz	0,036	0,050	0,061	0,070	0,087	0,101
	4	1,5 x D	0,2 x D	0,5 x D	90	–	150	fz	0,033	0,045	0,054	0,062	0,077	0,088
	5	1,5 x D	0,2 x D	0,5 x D	60	–	100	fz	0,029	0,040	0,048	0,056	0,070	0,081
M	1	1,5 x D	0,2 x D	0,5 x D	90	–	115	fz	0,036	0,050	0,061	0,070	0,087	0,101
	2	1,5 x D	0,2 x D	0,5 x D	60	–	80	fz	0,029	0,040	0,048	0,056	0,070	0,081
	3	1,5 x D	0,2 x D	0,5 x D	60	–	70	fz	0,025	0,034	0,040	0,047	0,057	0,065
K	1	1,5 x D	0,2 x D	0,5 x D	120	–	150	fz	0,044	0,060	0,072	0,083	0,101	0,114
	2	1,5 x D	0,2 x D	0,5 x D	110	–	130	fz	0,036	0,050	0,061	0,070	0,087	0,101
	3	1,5 x D	0,2 x D	0,5 x D	110	–	130	fz	0,029	0,040	0,048	0,056	0,070	0,081
S	1	1,5 x D	0,2 x D	0,5 x D	50	–	90	fz	0,036	0,050	0,061	0,070	0,087	0,101
	2	1,5 x D	0,1 x D	0,3 x D	25	–	40	fz	0,019	0,026	0,032	0,037	0,046	0,054
	3	1,5 x D	0,2 x D	0,5 x D	25	–	40	fz	0,019	0,026	0,032	0,037	0,046	0,054
	4	1,5 x D	0,2 x D	0,5 x D	50	–	60	fz	0,026	0,037	0,045	0,052	0,064	0,074
H	1	1,5 x D	0,1 x D	0,3 x D	80	–	140	fz	0,033	0,045	0,054	0,062	0,077	0,088

NOTE: Lower value of cutting speed is used for high stock removal applications or for higher hardness (machinability) within group.
Higher value of cutting speed is used for finishing applications or for lower hardness (machinability) within group.
Above parameters are based on ideal conditions. For smaller taper machining centers, please adjust parameters accordingly on >12mm diameters.

VariMill I • Series 47N0 • Application Data • WP15PE/TiAlN-LT • Metric

Material Group	Side Milling (A) and Slotting (B)			WP15PE/TiAlN			Recommended feed per tooth (fz = mm/th) for side milling (A). For slotting (B), reduce fz by 20%.										
	A		B	Cutting Speed – vc m/min			mm	D1 – Diameter									
	ap	ae	ap	min	max	5,0		6,0	8,0	10,0	12,0	14,0	16,0	18,0	20,0		
	ap	ae	ap	min	max	fz	fz	fz	fz	fz	fz	fz	fz	fz	fz		
P	0	1,25 x D	0,5 x D	1 x D	150	–	200	fz	0,036	0,044	0,060	0,072	0,083	0,092	0,101	0,108	0,114
	1	1,25 x D	0,5 x D	1 x D	150	–	200	fz	0,036	0,044	0,060	0,072	0,083	0,092	0,101	0,108	0,114
	2	1,25 x D	0,5 x D	1 x D	140	–	190	fz	0,036	0,044	0,060	0,072	0,083	0,092	0,101	0,108	0,114
	3	1,25 x D	0,5 x D	1 x D	120	–	160	fz	0,030	0,036	0,050	0,061	0,070	0,079	0,087	0,095	0,101
	4	1,25 x D	0,5 x D	0,75 x D	90	–	150	fz	0,027	0,033	0,045	0,054	0,062	0,070	0,077	0,083	0,088
	5	1,25 x D	0,5 x D	1 x D	60	–	100	fz	0,024	0,029	0,040	0,048	0,056	0,063	0,070	0,076	0,081
M	1	1,25 x D	0,5 x D	1 x D	90	–	115	fz	0,030	0,036	0,050	0,061	0,070	0,079	0,087	0,095	0,101
	2	1,25 x D	0,5 x D	1 x D	60	–	80	fz	0,024	0,029	0,040	0,048	0,056	0,063	0,070	0,076	0,081
	3	1,25 x D	0,5 x D	1 x D	60	–	70	fz	0,020	0,025	0,034	0,040	0,047	0,052	0,057	0,061	0,065
K	1	1,25 x D	0,5 x D	1 x D	120	–	150	fz	0,036	0,044	0,060	0,072	0,083	0,092	0,101	0,108	0,114
	2	1,25 x D	0,5 x D	1 x D	110	–	140	fz	0,030	0,036	0,050	0,061	0,070	0,079	0,087	0,095	0,101
	3	1,25 x D	0,5 x D	1 x D	110	–	130	fz	0,024	0,029	0,040	0,048	0,056	0,063	0,070	0,076	0,081
S	1	1 x D	0,3 x D	0,3 x D	50	–	90	fz	0,030	0,036	0,050	0,061	0,070	0,079	0,087	0,095	0,101
	2	1 x D	0,3 x D	0,3 x D	25	–	40	fz	0,016	0,019	0,026	0,032	0,037	0,042	0,046	0,050	0,054
	3	1,25 x D	0,5 x D	1 x D	25	–	40	fz	0,016	0,019	0,026	0,032	0,037	0,042	0,046	0,050	0,054
	4	1,25 x D	0,5 x D	1 x D	50	–	60	fz	0,021	0,026	0,037	0,045	0,052	0,058	0,064	0,069	0,074
H	1	1,25 x D	0,5 x D	0,75 x D	80	–	140	fz	0,027	0,033	0,045	0,054	0,062	0,070	0,077	0,083	0,088

NOTE: Lower value of cutting speed is used for high stock removal applications or for higher hardness (machinability) within group.
Higher value of cutting speed is used for finishing applications or for lower hardness (machinability) within group.
Above parameters are based on ideal conditions. For smaller taper machining centers, please adjust parameters accordingly on >12mm diameters.



The VariMill II 5-flute solid carbide end mill family is a proven leader in high-performance milling, achieving supreme surface finishes in multiple materials through various milling operations, including full slotting up to a depth of cut of 1 x D.

Features and Benefits

Unequal flute spacing to cut harmonics and reduce the development of vibrations during cutting.

Center cutting for improved ramping capabilities and plunging.

38° helix angle to provide the best combination between a roughing and a finishing tool.

Unique core design to offer maximum room for chip evacuation while keeping the tool design stable.



VariMill II carbide end mills utilize a proprietary design driven by a unique relief style and unequal flute spacing.

STABLE

Unequal flute spacing design to ensure low vibrations and high cutting stability.

PRODUCTIVE

5 flute to increase feed-rate per revolution and exceed metal removal expectations.

VERSATILE

Maximum performance in multiple operations and the best choice to remove great volumes of chips in difficult-to-machine materials.

ADVANCED PRODUCTIVITY

PRODUCT

SOLID CARBIDE END MILL

GRADE

WP15PE
WS15PE

FLUTE

5

DIAMETER RANGE

METRIC

4-25mm

INDUSTRY



GENERAL
ENGINEERING



AEROSPACE



ENERGY



TRANSPORTATION

APPLICATIONS

MATERIALS

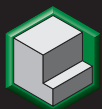

SIDE MILLING



RAMPING



HELICAL
INTERPOLATION



SLOTING

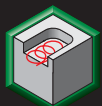

DYNAMIC
MILLING



PLUNGING

VariMill II • Series 5777 • Square End • Non-Center Cutting • 5 Flute • Metric

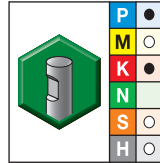
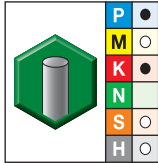
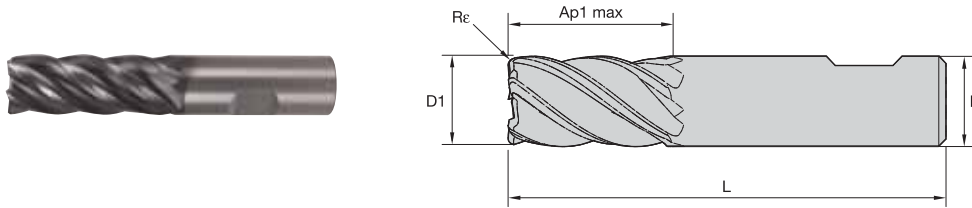

● first choice
○ alternate choice

WP15PE		WP15PE		D1	D	length of cut Ap1 max	length L	Re	ZU
order #	catalogue #	order #	catalogue #						
3524587	577704002MT	—	—	4,0	6	11,00	55	0,25	5
3524586	577704012MT	—	—	4,0	6	11,00	55	—	5
3524588	577705002MT	—	—	5,0	6	13,00	57	0,25	5
6525049	577706002ET	—	—	6,0	6	13,00	57	0,50	5
6525050	577706002JT	—	—	6,0	6	13,00	57	1,00	5
3524590	577706002MT	—	—	6,0	6	13,00	57	0,40	5
3524589	577706012MT	—	—	6,0	6	13,00	57	—	5
6525181	577708003JT	—	—	8,0	8	19,00	63	1,00	5
6525182	577708003KT	—	—	8,0	8	19,00	63	1,50	5
3524593	577708003MT	—	—	8,0	8	19,00	63	0,50	5
3524592	577708013MT	—	—	8,0	8	19,00	63	—	5
6525183	577710004JT	—	—	10,0	10	22,00	72	1,00	5
6525184	577710004KT	—	—	10,0	10	22,00	72	1,50	5
3524596	577710004MT	—	—	10,0	10	22,00	72	0,50	5
3524595	577710014MT	—	—	10,0	10	22,00	72	—	5
3524598	577712005MT	—	—	12,0	12	26,00	83	0,75	5
6525185	577712015ET	—	—	12,0	12	26,00	73	0,50	5
6525186	577712015JT	—	—	12,0	12	26,00	73	1,00	5
6525187	577712015KT	—	—	12,0	12	26,00	73	1,50	5
3524597	577712015MT	—	—	12,0	12	26,00	83	—	5
6525188	577712015NT	—	—	12,0	12	26,00	73	2,50	5
6525189	577716006JT	—	—	16,0	16	32,00	92	1,00	5
3524601	577716006MT	3524620	577716006MW	16,0	16	32,00	92	0,75	5
6525190	577716006PT	—	—	16,0	16	32,00	92	3,00	5
6525201	577716006QT	—	—	16,0	16	32,00	92	4,00	5
3524600	577716016MT	—	—	16,0	16	32,00	92	—	5
3524605	577720007MT	—	—	20,0	20	38,00	104	0,75	5
6525202	577720007PT	—	—	20,0	20	38,00	104	3,00	5
3524603	577720017MT	—	—	20,0	20	38,00	104	—	5
3524606	577725008MT	—	—	25,0	25	45,00	121	0,75	5
6525203	577725008RT	—	—	25,0	25	45,00	121	5,00	5

INDEXABLE MILLING

SOLID END MILLING

HOLEMAKING

TAPPING

TURNING

VariMill II • Series 577C • Square End • Center Cutting • 5 Flute • Metric

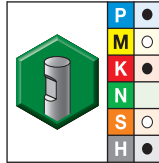
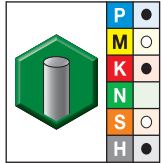
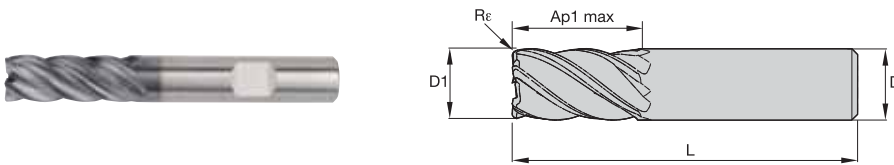

● first choice
○ alternate choice

WP15PE		WP15PE		D1	D	length of cut Ap1 max	length L	Rε	ZU
5578866	577C04002T	5578867	577C04002W	4,0	6	11,00	55	0,25	5
5578868	577C04012T	—	—	4,0	6	11,00	55	—	5
5578990	577C05002T	5578991	577C05002W	5,0	6	13,00	57	0,25	5
6519448	577C050R2TE	—	—	5,0	6	13,00	57	0,50	5
5578992	577C06002T	5578993	577C06002W	6,0	6	13,00	57	0,40	5
5578994	577C06012T	—	—	6,0	6	13,00	57	—	5
6519449	577C060R2TE	—	—	6,0	6	13,00	57	0,50	5
6519450	577C060R2TJ	—	—	6,0	6	13,00	57	1,00	5
5578995	577C07003T	—	—	7,0	8	16,00	63	0,40	5
5578997	577C08003T	5578998	577C08003W	8,0	8	19,00	63	0,50	5
5578999	577C08013T	—	—	8,0	8	19,00	63	—	5
6519481	577C080R3TJ	—	—	8,0	8	19,00	63	1,00	5
6519482	577C080R3TK	—	—	8,0	8	19,00	63	1,50	5
5579021	577C09004T	—	—	9,0	10	19,00	72	0,50	5
5579023	577C10004T	5579024	577C10004W	10,0	10	22,00	72	0,50	5
5579025	577C10014T	—	—	10,0	10	22,00	72	—	5
6519483	577C100R4TJ	—	—	10,0	10	22,00	72	1,00	5
6519484	577C100R4TK	—	—	10,0	10	22,00	72	1,50	5
6519485	577C100R4TM	—	—	10,0	10	22,00	72	2,00	5
5579026	577C12005T	5579027	577C12005W	12,0	12	26,00	83	0,75	5
5579028	577C12015T	—	—	12,0	12	26,00	83	—	5
6519486	577C120R5TE	—	—	12,0	12	26,00	83	0,50	5
6519487	577C120R5TJ	—	—	12,0	12	26,00	83	1,00	5
6519488	577C120R5TK	—	—	12,0	12	26,00	83	1,50	5
6519489	577C120R5TM	—	—	12,0	12	26,00	83	2,00	5
6519490	577C120R5TN	—	—	12,0	12	26,00	83	2,50	5
6519491	577C120R5TP	—	—	12,0	12	26,00	83	3,00	5
5579029	577C14004T	5579040	577C14004W	14,0	14	26,00	83	0,75	5
5579041	577C14014T	—	—	14,0	14	26,00	83	—	5
5579042	577C16006T	5579043	577C16006W	16,0	16	32,00	92	0,75	5
5579044	577C16016T	—	—	16,0	16	32,00	92	—	5
6519492	577C160R6TE	—	—	16,0	16	32,00	92	0,50	5
6519493	577C160R6TJ	—	—	16,0	16	32,00	92	1,00	5
6519497	577C160R6TM	—	—	16,0	16	32,00	92	2,00	5
6519499	577C160R6TP	—	—	16,0	16	32,00	92	3,00	5
6519500	577C160R6TQ	—	—	16,0	16	32,00	92	4,00	5
5579045	577C18008T	—	—	18,0	18	32,00	92	0,75	5
5579047	577C20007T	5579048	577C20007W	20,0	20	38,00	104	0,75	5
5579049	577C20017T	—	—	20,0	20	38,00	104	—	5
6519501	577C200R7TJ	—	—	20,0	20	38,00	104	1,00	5
6519502	577C200R7TM	—	—	20,0	20	38,00	104	2,00	5
6519503	577C200R7TP	—	—	20,0	20	38,00	104	3,00	5
6519504	577C200R7TQ	—	—	20,0	20	38,00	104	4,00	5
6519505	577C200R7TR	—	—	20,0	20	38,00	104	5,00	5
5579060	577C25008T	5579061	577C25008W	25,0	25	45,00	121	0,75	5
6519506	577C250R8TM	—	—	25,0	25	45,00	121	2,00	5
6519507	577C250R8TP	—	—	25,0	25	45,00	121	3,00	5
6519508	577C250R8TQ	—	—	25,0	25	45,00	121	4,00	5
6519509	577C250R8TR	—	—	25,0	25	45,00	121	5,00	5

VariMill II • Series 57N8 • Square End • Non-Center Cutting • Neck • 5 Flute • Metric

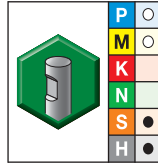
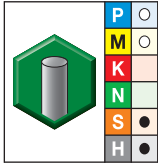
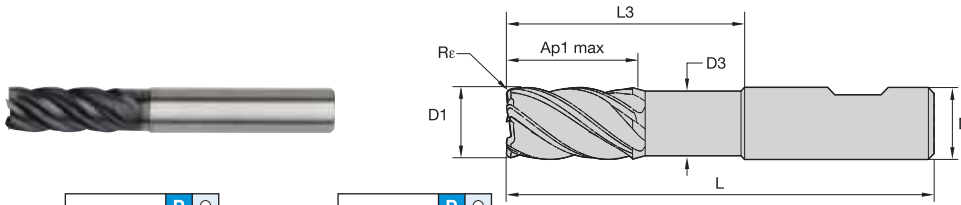

● first choice
○ alternate choice

WS15PE		WS15PE		D1	D	D3	length of cut Ap1 max	L3	length L	Re	ZU
order #	catalogue #	order #	catalogue #								
3524626	57N806002MT	—	—	6,0	6	5,60	13,00	18,00	63	—	5
3524627	57N806022MT	—	—	6,0	6	5,60	13,00	18,00	63	0,50	5
6492821	57N8060R2MTG	—	—	6,0	6	5,64	13,00	18,00	63	0,75	5
3524629	57N808003MT	—	—	8,0	8	7,50	19,00	24,00	76	—	5
3524631	57N808023MT	—	—	8,0	8	7,50	19,00	24,00	76	0,50	5
6492822	57N8080R3MTG	—	—	8,0	8	7,52	19,00	24,00	76	0,75	5
6492825	57N8080R3MTK	—	—	8,0	8	7,52	19,00	24,00	76	1,50	5
3524632	57N810004MT	—	—	10,0	10	9,40	22,00	30,00	76	—	5
3524643	57N810024MT	—	—	10,0	10	9,40	22,00	30,00	76	0,50	5
3524644	57N810034MT	—	—	10,0	10	9,40	22,00	30,00	76	1,00	5
3524645	57N810054MT	—	—	10,0	10	9,40	22,00	30,00	76	2,00	5
6492823	57N8100R4MTG	—	—	10,0	10	9,40	22,00	30,00	76	0,75	5
6492826	57N8100R4MTK	—	—	10,0	10	9,40	22,00	30,00	76	1,50	5
3524647	57N812025MT	—	—	12,0	12	11,28	26,00	36,00	83	0,50	5
3524648	57N812035MT	—	—	12,0	12	11,28	26,00	36,00	83	1,00	5
3524649	57N812055MT	—	—	12,0	12	11,28	26,00	36,00	83	2,00	5
6492827	57N8120R5MTK	—	—	12,0	12	11,28	26,00	36,00	83	1,50	5
6492829	57N8120R5MTN	—	—	12,0	12	11,28	26,00	36,00	83	2,50	5
6492830	57N8120R5MTP	—	—	12,0	12	11,28	26,00	36,00	83	3,00	5
3524650	57N816006MT	—	—	16,0	16	15,05	32,00	48,00	100	—	5
3524651	57N816026MT	3562867	57N816026MW	16,0	16	15,05	32,00	48,00	100	0,50	5
3524652	57N816036MT	—	—	16,0	16	15,05	32,00	48,00	100	1,00	5
3524654	57N816076MT	3524692	57N816076MW	16,0	16	15,05	32,00	48,00	100	3,00	5
6492832	57N8160R6MTQ	—	—	16,0	16	15,04	32,00	48,00	100	4,00	5
—	—	3524693	57N820027MW	20,0	20	18,80	38,00	60,00	115	0,50	5
6492824	57N8200R7MTJ	—	—	20,0	20	18,80	38,00	60,00	115	1,00	5
6492833	57N8200R7MTR	—	—	20,0	20	18,80	38,00	60,00	115	5,00	5
6492831	57N8250R8MTP	—	—	25,0	25	23,50	45,00	75,00	135	3,00	5
6492834	57N8250R8MTR	—	—	25,0	25	23,50	45,00	75,00	135	5,00	5

INDEXABLE MILLING

SOLID END MILLING

HOLEMAKING

TAPPING

TURNING

VariMill II • Series 57NC • Square End • Center Cutting • Neck • 5 Flute • Metric

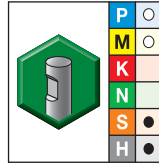
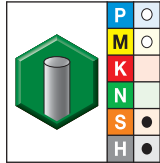
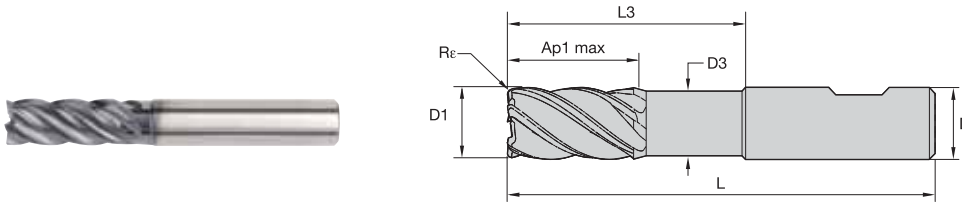

● first choice
○ alternate choice

WS15PE		WS15PE		D1	D	D3	length of cut Ap1 max	L3	length L	Re	ZU
5598906	57NC06002T	—	—	6,0	6	5,64	13,00	18,00	63	—	5
5598907	57NC06022T	—	—	6,0	6	5,64	13,00	18,00	63	0,50	5
5598909	57NC06032T	—	—	6,0	6	5,64	13,00	18,00	63	1,00	5
—	—	5599071	57NC06042W	6,0	6	5,64	13,00	18,00	63	1,50	5
6569491	57NC060R2TK	—	—	6,0	6	5,64	13,00	17,82	63	1,50	5
5599072	57NC08003T	—	—	8,0	8	7,52	19,00	24,00	76	—	5
5599073	57NC08023T	5599074	57NC08023W	8,0	8	7,52	19,00	24,00	76	0,50	5
5599075	57NC08033T	5599076	57NC08033W	8,0	8	7,52	19,00	24,00	76	1,00	5
6569493	57NC080R3TK	5599077	57NC08053W	8,0	8	7,52	19,00	24,00	76	2,00	5
6569492	57NC080R3TK	—	—	8,0	8	7,52	19,00	24,00	76	1,50	5
5599078	57NC10004T	—	—	10,0	10	9,40	22,00	30,00	76	—	5
5599079	57NC10024T	5599080	57NC10024W	10,0	10	9,40	22,00	30,00	76	0,50	5
5599081	57NC10034T	5599082	57NC10034W	10,0	10	9,40	22,00	30,00	76	1,00	5
5599083	57NC10054T	—	—	10,0	10	9,40	22,00	30,00	76	2,00	5
6569494	57NC100R4TK	—	—	10,0	10	9,40	22,00	30,00	76	1,50	5
5599085	57NC12005T	—	—	12,0	12	11,28	26,00	36,00	83	—	5
5599086	57NC12025T	5599087	57NC12025W	12,0	12	11,28	26,00	36,00	83	0,50	5
5599088	57NC12035T	—	—	12,0	12	11,28	26,00	36,00	83	1,00	5
5599090	57NC12055T	5599091	57NC12055W	12,0	12	11,28	26,00	36,00	83	2,00	5
6569495	57NC120R5TK	—	—	12,0	12	11,28	26,00	36,00	83	1,50	5
6569496	57NC120R5TK	—	—	12,0	12	11,28	26,00	36,00	83	3,00	5
5599092	57NC16006T	—	—	16,0	16	15,04	32,00	48,00	100	—	5
5599093	57NC16026T	5598905	57NC16026W	16,0	16	15,04	32,00	48,00	100	0,50	5
5599094	57NC16036T	5599095	57NC16036W	16,0	16	15,04	32,00	48,00	100	1,00	5
5599096	57NC16056T	—	—	16,0	16	15,04	32,00	48,00	100	2,00	5
5599098	57NC16076T	5599099	57NC16076W	16,0	16	15,04	32,00	48,00	100	3,00	5
6569497	57NC160R6TK	—	—	16,0	16	15,04	32,00	48,00	100	4,00	5
5599100	57NC20007T	—	—	20,0	20	18,80	38,00	60,00	115	—	5
5599101	57NC20027T	5599102	57NC20027W	20,0	20	18,80	38,00	60,00	115	0,50	5
5599103	57NC20037T	5599104	57NC20037W	20,0	20	18,80	38,00	60,00	115	1,00	5
5599105	57NC20057T	—	—	20,0	20	18,80	38,00	60,00	115	2,00	5
5599107	57NC20077T	5599108	57NC20077W	20,0	20	18,80	38,00	60,00	115	3,00	5
5599109	57NC20087T	—	—	20,0	20	18,80	38,00	60,00	115	4,00	5
6569498	57NC200R7TK	—	—	20,0	20	18,80	38,00	60,00	115	5,00	5
5599111	57NC25008T	—	—	25,0	25	23,50	45,00	75,00	135	—	5
5599112	57NC25028T	—	—	25,0	25	23,50	45,00	75,00	135	0,50	5
5599114	57NC25038T	5599115	57NC25038W	25,0	25	23,50	45,00	75,00	135	1,00	5
5599116	57NC25058T	—	—	25,0	25	23,50	45,00	75,00	135	2,00	5
5599118	57NC25078T	—	—	25,0	25	23,50	45,00	75,00	135	3,00	5
5599120	57NC25088T	—	—	25,0	25	23,50	45,00	75,00	135	4,00	5

VariMill II ER • Series 577E • Square End • Eccentric Relief • 5 Flute • Metric

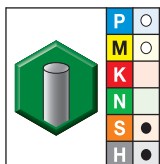
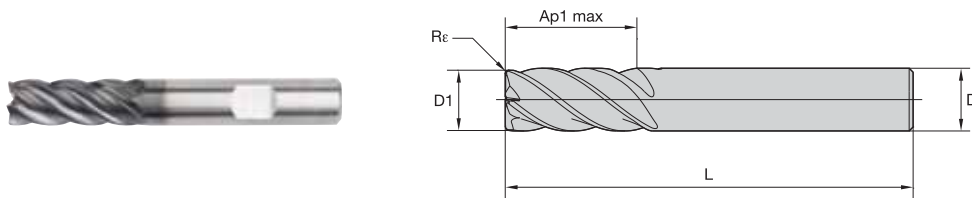

WS15PE



WS15PE

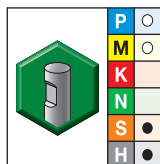

WS15PE

● first choice
○ alternate choice

WS15PE		WS15PE		WS15PE		D1	D	length of cut Ap1 max	length L	Re	ZU
order #	catalogue #	order #	catalogue #	order #	catalogue #						
5599171	577E10004T	-	-	5599176	577E12015W	10,0	10	22,00	72	-	5
-	-	5599177	577E16006V	-	-	16,0	16	32,00	92	-	5
-	-	5599178	577E16016V	5599179	577E16016W	16,0	16	32,00	92	0,75	5
-	-	5599180	577E20007V	-	-	20,0	20	38,00	104	-	5
-	-	5599181	577E20017V	5599182	577E20017W	20,0	20	38,00	104	0,75	5
-	-	5599183	577E25018V	-	-	25,0	25	45,00	121	0,75	5

INDEXABLE MILLING

SOLID END MILLING

HOLEMAKING

TAPPING

TURNING

VariMill II ER • Series 57NE • Square End • Eccentric Relief • Neck • 5 Flute • Metric

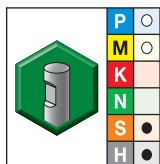
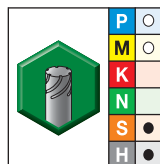
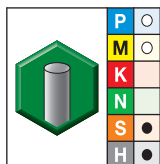
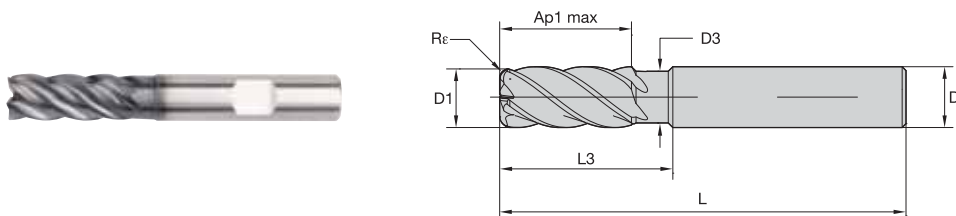

● first choice
○ alternate choice

WS15PE		WS15PE		WS15PE		D1	D	D3	length of cut		length			ZU
order #	catalogue #	order #	catalogue #	order #	catalogue #				Ap1 max	L3	L	Re		
5599122	57NE10004T	—	—	5599124	57NE10024W	10,0	10	9,40	22,00	30,00	76	—	5	
5599123	57NE10024T	—	—	5599126	57NE10034W	10,0	10	9,40	22,00	30,00	76	1,00	5	
5599125	57NE10034T	—	—	5599128	57NE10054W	10,0	10	9,40	22,00	30,00	76	2,00	5	
5599127	57NE10054T	—	—	—	—	—	—	—	—	—	—	—	—	
—	—	5599129	57NE12005V	—	—	12,0	12	11,28	26,00	36,00	83	—	5	
—	—	5599130	57NE12025V	5599131	57NE12025W	12,0	12	11,28	26,00	36,00	83	0,50	5	
—	—	5599132	57NE12035V	5599133	57NE12035W	12,0	12	11,28	26,00	36,00	83	1,00	5	
—	—	5599134	57NE12055V	5599135	57NE12055W	12,0	12	11,28	26,00	36,00	83	2,00	5	
—	—	5599136	57NE16006V	—	—	16,0	16	15,04	32,00	48,00	100	—	5	
—	—	5599137	57NE16026V	5599138	57NE16026W	16,0	16	15,04	32,00	48,00	100	0,50	5	
—	—	5599139	57NE16036V	5599140	57NE16036W	16,0	16	15,04	32,00	48,00	100	1,00	5	
—	—	5599141	57NE16056V	5599142	57NE16056W	16,0	16	15,04	32,00	48,00	100	2,00	5	
—	—	5599143	57NE20007V	—	—	20,0	20	18,80	38,00	60,00	115	—	5	
—	—	5599144	57NE20027V	5599145	57NE20027W	20,0	20	18,80	38,00	60,00	115	0,50	5	
—	—	5599146	57NE20037V	5599147	57NE20037W	20,0	20	18,80	38,00	60,00	115	1,00	5	
—	—	5599148	57NE20057V	5599149	57NE20057W	20,0	20	18,80	38,00	60,00	115	2,00	5	
—	—	5599160	57NE20087V	5599161	57NE20087W	20,0	20	18,80	38,00	60,00	115	4,00	5	
—	—	5599162	57NE25008V	—	—	25,0	25	23,50	45,00	75,00	135	—	5	
—	—	5599163	57NE25028V	—	—	25,0	25	23,50	45,00	75,00	135	0,50	5	
—	—	5599165	57NE25038V	—	—	25,0	25	23,50	45,00	75,00	135	1,00	5	
—	—	5599167	57NE25058V	—	—	25,0	25	23,50	45,00	75,00	135	2,00	5	
—	—	5599169	57NE25088V	—	—	25,0	25	23,50	45,00	75,00	135	4,00	5	

VariMill II Long • Series 5718 • Square End • Long Length • 5 Flute • Metric

INDEXABLE MILLING

SOLID END MILLING

HOLEMAKING

TAPPING

TURNING

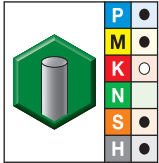
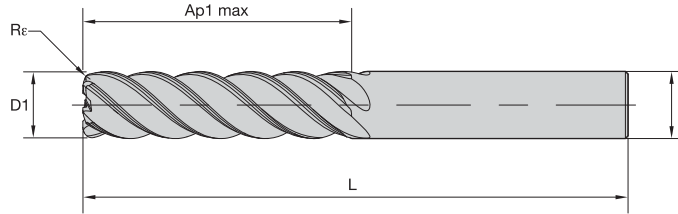



AITIN-MT

● first choice
○ alternate choice



order #	catalogue #	D1	D	length of cut Ap1 max	length L	Re	Z U
5096566	571806002MT	6,0	6	24,00	76	—	5
5096567	571806012MT	6,0	6	24,00	76	0,50	5
5096568	571806022MT	6,0	6	24,00	76	1,00	5
5096569	571808003MT	8,0	8	32,00	76	—	5
5096660	571808013MT	8,0	8	32,00	76	0,50	5
5096661	571808023MT	8,0	8	32,00	76	1,00	5
4124297	571810004MT	10,0	10	40,00	100	—	5
5096662	571810014MT	10,0	10	40,00	100	0,50	5
5096664	571810034MT	10,0	10	40,00	100	2,00	5
5096665	571810044MT	10,0	10	40,00	100	2,50	5
4124298	571812005MT	12,0	12	48,00	125	—	5
5096666	571812015MT	12,0	12	48,00	125	0,50	5
5096667	571812025MT	12,0	12	48,00	125	1,00	5
5096668	571812035MT	12,0	12	48,00	125	2,00	5
5096669	571812045MT	12,0	12	48,00	125	2,50	5
4124299	571814014MT	14,0	14	56,00	120	—	5
5096752	571814024MT	14,0	14	56,00	120	1,00	5
5096755	571814054MT	14,0	14	56,00	120	4,00	5
4124300	571816006MT	16,0	16	64,00	141	—	5
5096756	571816016MT	16,0	16	64,00	141	0,50	5
5096757	571816026MT	16,0	16	64,00	141	1,00	5
5096758	571816036MT	16,0	16	64,00	141	2,00	5
5096759	571816046MT	16,0	16	64,00	141	3,00	5
5096800	571816056MT	16,0	16	64,00	141	4,00	5
4124301	571818018MT	18,0	18	72,00	150	—	5
4124302	571820007MT	20,0	20	80,00	150	—	5
5096805	571820017MT	20,0	20	80,00	150	0,50	5
5096806	571820027MT	20,0	20	80,00	150	1,00	5
5096807	571820037MT	20,0	20	80,00	150	2,00	5
5096808	571820047MT	20,0	20	80,00	150	3,00	5
5096809	571820057MT	20,0	20	80,00	150	4,00	5
4124323	571825008MT	25,0	25	100,00	170	—	5
5096860	571825018MT	25,0	25	100,00	170	0,50	5
5096861	571825028MT	25,0	25	100,00	170	1,00	5
5096862	571825038MT	25,0	25	100,00	170	2,00	5
5096863	571825048MT	25,0	25	100,00	170	3,00	5

VariMill II • Series 5777 • Application Data • WP15PE • Metric

Material Group	 				Recommended feed per tooth (fz = mm/th) for side milling (A). For slotting (B), reduce fz by 20%.											
	Side Milling (A) and Slotting (B)			WP15PE		D1 – Diameter										
	A		B	Cutting Speed – vc m/min		mm	4,0	6,0	8,0	10,0	12,0	16,0	20,0	25,0		
	ap	ae	ap	min	max	fz										
P	1	1,5 x D	0,5 x D	1 x D	150	–	200	fz	0,028	0,044	0,060	0,072	0,083	0,101	0,114	0,124
	2	1,5 x D	0,5 x D	1 x D	140	–	190	fz	0,028	0,044	0,060	0,072	0,083	0,101	0,114	0,124
	3	1,5 x D	0,5 x D	1 x D	120	–	160	fz	0,023	0,036	0,050	0,061	0,070	0,087	0,101	0,114
	4	1,5 x D	0,5 x D	0,75 x D	90	–	150	fz	0,021	0,033	0,045	0,054	0,062	0,077	0,088	0,098
	5	1,5 x D	0,5 x D	1 x D	60	–	100	fz	0,019	0,029	0,040	0,048	0,056	0,070	0,081	0,091
	6	1,5 x D	0,5 x D	0,75 x D	50	–	75	fz	0,016	0,025	0,034	0,040	0,047	0,057	0,065	0,071
M	1	1,5 x D	0,5 x D	1 x D	90	–	115	fz	0,023	0,036	0,050	0,061	0,070	0,087	0,101	0,114
	2	1,5 x D	0,5 x D	1 x D	60	–	80	fz	0,019	0,029	0,040	0,048	0,056	0,070	0,081	0,091
	3	1,5 x D	0,5 x D	1 x D	60	–	70	fz	0,016	0,025	0,034	0,040	0,047	0,057	0,065	0,071
K	1	1,5 x D	0,5 x D	1 x D	120	–	150	fz	0,028	0,044	0,060	0,072	0,083	0,101	0,114	0,124
	2	1,5 x D	0,5 x D	1 x D	110	–	130	fz	0,023	0,036	0,050	0,061	0,070	0,087	0,101	0,114
	3	1,5 x D	0,5 x D	1 x D	100	–	130	fz	0,019	0,029	0,040	0,048	0,056	0,070	0,081	0,091
S	1	1,5 x D	0,3 x D	0,3 x D	50	–	90	fz	0,023	0,036	0,050	0,061	0,070	0,087	0,101	0,114
	2	1,5 x D	0,3 x D	0,3 x D	25	–	40	fz	0,013	0,019	0,026	0,032	0,037	0,046	0,054	0,061
	3	1,5 x D	0,5 x D	1 x D	25	–	40	fz	0,013	0,019	0,026	0,032	0,037	0,046	0,054	0,061
	4	1,5 x D	0,5 x D	1 x D	50	–	60	fz	0,016	0,026	0,037	0,045	0,052	0,064	0,074	0,084
H	1	1,5 x D	0,5 x D	0,75 x D	80	–	140	fz	0,021	0,033	0,045	0,054	0,062	0,077	0,088	0,098



NOTE: Lower value of cutting speed is used for high-stock removal applications or for higher hardness (machinability) within group.
 Higher value of cutting speed is used for finishing applications or for lower hardness (machinability) within group.
 Above parameters are based on ideal conditions. For smaller taper machining centers, please adjust parameters accordingly on > 12mm diameters.

VariMill II • Series 577C • Application Data • WP15PE • Metric

Material Group	 				Recommended feed per tooth (fz = mm/th) for side milling (A). For slotting (B), reduce fz by 20%.														
	Side Milling (A) and Slotting (B)			WP15PE		D1 – Diameter													
	A		B	Cutting Speed – vc m/min		mm	4,0	5,0	6,0	8,0	10,0	12,0	14,0	16,0	18,0	20,0	25,0		
	ap	ae	ap	min	max	fz													
P	0	1,5 x D	0,5 x D	1 x D	150	–	200	fz	0,028	0,036	0,044	0,060	0,072	0,083	0,092	0,101	0,108	0,114	0,124
	1	1,5 x D	0,5 x D	1 x D	150	–	200	fz	0,028	0,036	0,044	0,060	0,072	0,083	0,092	0,101	0,108	0,114	0,124
	2	1,5 x D	0,5 x D	1 x D	140	–	190	fz	0,028	0,036	0,044	0,060	0,072	0,083	0,092	0,101	0,108	0,114	0,124
	3	1,5 x D	0,5 x D	1 x D	120	–	160	fz	0,023	0,030	0,036	0,050	0,061	0,070	0,079	0,087	0,095	0,101	0,114
	4	1,5 x D	0,5 x D	0,75 x D	90	–	150	fz	0,021	0,027	0,033	0,045	0,054	0,062	0,070	0,077	0,083	0,088	0,098
	5	1,5 x D	0,5 x D	1 x D	60	–	100	fz	0,019	0,024	0,029	0,040	0,048	0,056	0,063	0,070	0,076	0,081	0,091
6	1,5 x D	0,5 x D	0,75 x D	50	–	75	fz	0,016	0,020	0,025	0,034	0,040	0,047	0,052	0,057	0,061	0,065	0,071	
M	1	1,5 x D	0,5 x D	1 x D	90	–	115	fz	0,023	0,030	0,036	0,050	0,061	0,070	0,079	0,087	0,095	0,101	0,114
	2	1,5 x D	0,5 x D	1 x D	60	–	80	fz	0,019	0,024	0,029	0,040	0,048	0,056	0,063	0,070	0,076	0,081	0,091
	3	1,5 x D	0,5 x D	1 x D	60	–	70	fz	0,016	0,020	0,025	0,034	0,040	0,047	0,052	0,057	0,061	0,065	0,071
K	1	1,5 x D	0,5 x D	1 x D	120	–	150	fz	0,028	0,036	0,044	0,060	0,072	0,083	0,092	0,101	0,108	0,114	0,124
	2	1,5 x D	0,5 x D	1 x D	110	–	140	fz	0,023	0,030	0,036	0,050	0,061	0,070	0,079	0,087	0,095	0,101	0,114
	3	1,5 x D	0,5 x D	1 x D	110	–	130	fz	0,019	0,024	0,029	0,040	0,048	0,056	0,063	0,070	0,076	0,081	0,091
S	1	1,5 x D	0,3 x D	0,3 x D	50	–	90	fz	0,023	0,030	0,036	0,050	0,061	0,070	0,079	0,087	0,095	0,101	0,114
	2	1,5 x D	0,3 x D	0,3 x D	25	–	40	fz	0,013	0,016	0,019	0,026	0,032	0,037	0,042	0,046	0,050	0,054	0,061
	3	1,5 x D	0,5 x D	1 x D	25	–	40	fz	0,013	0,016	0,019	0,026	0,032	0,037	0,042	0,046	0,050	0,054	0,061
	4	1,5 x D	0,5 x D	1 x D	50	–	60	fz	0,016	0,021	0,026	0,037	0,045	0,052	0,058	0,064	0,069	0,074	0,084
H	1	1,5 x D	0,5 x D	0,75 x D	80	–	140	fz	0,021	0,027	0,033	0,045	0,054	0,062	0,070	0,077	0,083	0,088	0,098
	2	1,5 x D	0,2 x D	0,5 x D	70	–	120	fz	0,016	0,020	0,025	0,034	0,040	0,047	0,052	0,057	0,061	0,065	0,071



NOTE: Lower value of cutting speed is used for high stock removal applications or for higher hardness (machinability) within group.
 Higher value of cutting speed is used for finishing applications or for lower hardness (machinability) within group.
 Above parameters are based on ideal conditions. For smaller taper machining centers, please adjust parameters accordingly on >12mm diameters.

VariMill II • Series 57N8 • Application Data • WS15PE • Metric

																
		Side Milling (A) and Slotting (B)			WS15PE			Recommended feed per tooth (fz = mm/th) for side milling (A). For slotting (B), reduce fz by 20%.								
Material Group		A		B	Cutting Speed – vc m/min			mm	D1 – Diameter							
		ap	ae	ap	min	–	max		6,0	8,0	10,0	12,0	16,0	20,0	25,0	
P	1	1,5 x D	0,5 x D	1 x D	150	–	200	fz	0,044	0,060	0,072	0,083	0,101	0,114	0,124	
	2	1,5 x D	0,5 x D	1 x D	140	–	190	fz	0,044	0,060	0,072	0,083	0,101	0,114	0,124	
	3	1,5 x D	0,5 x D	1 x D	120	–	160	fz	0,036	0,050	0,061	0,070	0,087	0,101	0,114	
	4	1,5 x D	0,5 x D	0,75 x D	90	–	150	fz	0,033	0,045	0,054	0,062	0,077	0,088	0,098	
	5	1,5 x D	0,5 x D	1 x D	60	–	100	fz	0,029	0,040	0,048	0,056	0,070	0,081	0,091	
	6	1,5 x D	0,5 x D	0,75 x D	50	–	75	fz	0,025	0,034	0,040	0,047	0,057	0,065	0,071	
M	1	1,5 x D	0,5 x D	1 x D	90	–	115	fz	0,036	0,050	0,061	0,070	0,087	0,101	0,114	
	2	1,5 x D	0,5 x D	1 x D	60	–	80	fz	0,029	0,040	0,048	0,056	0,070	0,081	0,091	
K	3	1,5 x D	0,5 x D	1 x D	60	–	70	fz	0,025	0,034	0,040	0,047	0,057	0,065	0,071	
	1	1,5 x D	0,5 x D	1 x D	120	–	150	fz	0,044	0,060	0,072	0,083	0,101	0,114	0,124	
	2	1,5 x D	0,5 x D	1 x D	110	–	130	fz	0,036	0,050	0,061	0,070	0,087	0,101	0,114	
S	3	1,5 x D	0,5 x D	1 x D	100	–	130	fz	0,029	0,040	0,048	0,056	0,070	0,081	0,091	
	1	1,5 x D	0,3 x D	0,3 x D	50	–	90	fz	0,036	0,050	0,061	0,070	0,087	0,101	0,114	
	2	1,5 x D	0,3 x D	0,3 x D	25	–	40	fz	0,019	0,026	0,032	0,037	0,046	0,054	0,061	
	3	1,5 x D	0,5 x D	1 x D	25	–	40	fz	0,019	0,026	0,032	0,037	0,046	0,054	0,061	
H	4	1,5 x D	0,5 x D	1 x D	50	–	60	fz	0,026	0,037	0,045	0,052	0,064	0,074	0,084	
	1	1,5 x D	0,5 x D	0,75 x D	80	–	140	fz	0,033	0,045	0,054	0,062	0,077	0,088	0,098	

NOTE: Lower value of cutting speed is used for high-stock removal applications or for higher hardness (machinability) within group.
Higher value of cutting speed is used for finishing applications or for lower hardness (machinability) within group.
Above parameters are based on ideal conditions. For smaller taper machining centers, please adjust parameters accordingly on diameters >12mm diameters.

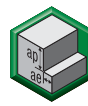
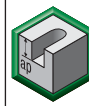
VariMill II • Series 57NC • Application Data • WS15PE • Metric

																	
		Side Milling (A) and Slotting (B)			WS15PE			Recommended feed per tooth (fz = mm/th) for side milling (A). For slotting (B), reduce fz by 20%.									
Material Group		A		B	Cutting Speed – vc m/min			mm	D1 – Diameter								
		ap	ae	ap	min	–	max		6,0	8,0	10,0	12,0	14,0	16,0	18,0	20,0	25,0
P	5	1,5 x D	0,5 x D	1 x D	60	–	100	fz	0,029	0,040	0,048	0,056	0,063	0,070	0,076	0,081	0,091
	6	1,5 x D	0,5 x D	0,75 x D	50	–	75	fz	0,025	0,034	0,040	0,047	0,052	0,057	0,061	0,065	0,071
M	1	1,5 x D	0,5 x D	1 x D	90	–	115	fz	0,036	0,050	0,061	0,070	0,079	0,087	0,095	0,101	0,114
	2	1,5 x D	0,5 x D	1 x D	60	–	80	fz	0,029	0,040	0,048	0,056	0,063	0,070	0,076	0,081	0,091
K	3	1,5 x D	0,5 x D	1 x D	60	–	70	fz	0,025	0,034	0,040	0,047	0,052	0,057	0,061	0,065	0,071
	1	1,5 x D	0,5 x D	1 x D	120	–	150	fz	0,044	0,060	0,072	0,083	0,092	0,101	0,108	0,114	0,124
	2	1,5 x D	0,5 x D	1 x D	110	–	140	fz	0,036	0,050	0,061	0,070	0,079	0,087	0,095	0,101	0,114
S	3	1,5 x D	0,5 x D	1 x D	110	–	130	fz	0,029	0,040	0,048	0,056	0,063	0,070	0,076	0,081	0,091
	1	1,5 x D	0,3 x D	0,3 x D	50	–	90	fz	0,036	0,050	0,061	0,070	0,079	0,087	0,095	0,101	0,114
	2	1,5 x D	0,3 x D	0,3 x D	25	–	40	fz	0,019	0,026	0,032	0,037	0,042	0,046	0,050	0,054	0,061
	3	1,5 x D	0,5 x D	1 x D	25	–	40	fz	0,019	0,026	0,032	0,037	0,042	0,046	0,050	0,054	0,061
H	4	1,5 x D	0,5 x D	1 x D	50	–	60	fz	0,026	0,037	0,045	0,052	0,058	0,064	0,069	0,074	0,084
	1	1,5 x D	0,5 x D	0,75 x D	80	–	140	fz	0,033	0,045	0,054	0,062	0,070	0,077	0,083	0,088	0,098
	2	1,5 x D	0,2 x D	0,5 x D	70	–	120	fz	0,025	0,034	0,040	0,047	0,052	0,057	0,061	0,065	0,071

NOTE: Lower value of cutting speed is used for high stock removal applications or for higher hardness (machinability) within group.
Higher value of cutting speed is used for finishing applications or for lower hardness (machinability) within group.
Above parameters are based on ideal conditions. For smaller taper machining centers, please adjust parameters accordingly on >12mm diameters.

INDEXABLE MILLING

SOLID END MILLING

HOLEMAKING

TAPPING

TURNING

VariMill II ER • Series 577E • Application Data • WS15PE • Metric

Material Group	Side Milling (A) and Slotting (B)			WS15PE			Recommended feed per tooth (fz = mm/th) for side milling (A). For slotting (B), reduce fz by 20%.								
	A		B	Cutting Speed – vc m/min			mm	D1 – Diameter							
	ap	ae	ap	min	–	max		10,0	12,0	14,0	16,0	18,0	20,0	25,0	
	4	1,5 x D	0,5 x D	0,75 x D	90	–	150	fz	0,054	0,062	0,070	0,077	0,083	0,088	0,098
P	5	1,5 x D	0,5 x D	1 x D	60	–	100	fz	0,048	0,056	0,063	0,070	0,076	0,081	0,091
	6	1,5 x D	0,5 x D	0,75 x D	50	–	75	fz	0,040	0,047	0,052	0,057	0,061	0,065	0,071
	1	1,5 x D	0,5 x D	1 x D	90	–	115	fz	0,061	0,070	0,079	0,087	0,095	0,101	0,114
M	2	1,5 x D	0,5 x D	1 x D	60	–	80	fz	0,048	0,056	0,063	0,070	0,076	0,081	0,091
	3	1,5 x D	0,5 x D	1 x D	60	–	70	fz	0,040	0,047	0,052	0,057	0,061	0,065	0,071
	1	1,5 x D	0,3 x D	0,3 x D	50	–	90	fz	0,061	0,070	0,079	0,087	0,095	0,101	0,114
S	2	1,5 x D	0,3 x D	0,3 x D	25	–	40	fz	0,032	0,037	0,042	0,046	0,050	0,054	0,061
	3	1,5 x D	0,5 x D	1 x D	25	–	40	fz	0,032	0,037	0,042	0,046	0,050	0,054	0,061
	4	1,5 x D	0,5 x D	1 x D	50	–	60	fz	0,045	0,052	0,058	0,064	0,069	0,074	0,084
H	1	1,5 x D	0,5 x D	0,75 x D	80	–	140	fz	0,054	0,062	0,070	0,077	0,083	0,088	0,098
	2	1,5 x D	0,2 x D	0,5 x D	70	–	120	fz	0,040	0,047	0,052	0,057	0,061	0,065	0,071

NOTE: Lower value of cutting speed is used for high stock removal applications or for higher hardness (machinability) within group.
Higher value of cutting speed is used for finishing applications or for lower hardness (machinability) within group.
Above parameters are based on ideal conditions. For smaller taper machining centers, please adjust parameters accordingly on >12mm diameters.

VariMill II ER • Series 57NE • Application Data • WS15PE • Metric

Material Group	Side Milling (A) and Slotting (B)			WS15PE			Recommended feed per tooth (fz = mm/th) for side milling (A). For slotting (B), reduce fz by 20%.								
	A		B	Cutting Speed – vc m/min			mm	D1 – Diameter							
	ap	ae	ap	min	–	max		10,0	12,0	14,0	16,0	18,0	20,0	25,0	
	4	1,5 x D	0,5 x D	0,75 x D	90	–	150	fz	0,054	0,062	0,070	0,077	0,083	0,088	0,098
P	5	1,5 x D	0,5 x D	1 x D	60	–	100	fz	0,048	0,056	0,063	0,070	0,076	0,081	0,091
	6	1,5 x D	0,5 x D	0,75 x D	50	–	75	fz	0,040	0,047	0,052	0,057	0,061	0,065	0,071
	1	1,5 x D	0,5 x D	1 x D	90	–	115	fz	0,061	0,070	0,079	0,087	0,095	0,101	0,114
M	2	1,5 x D	0,5 x D	1 x D	60	–	80	fz	0,048	0,056	0,063	0,070	0,076	0,081	0,091
	3	1,5 x D	0,5 x D	1 x D	60	–	70	fz	0,040	0,047	0,052	0,057	0,061	0,065	0,071
	1	1,5 x D	0,3 x D	0,3 x D	50	–	90	fz	0,061	0,070	0,079	0,087	0,095	0,101	0,114
S	2	1,5 x D	0,3 x D	0,3 x D	25	–	40	fz	0,032	0,037	0,042	0,046	0,050	0,054	0,061
	3	1,5 x D	0,5 x D	1 x D	25	–	40	fz	0,032	0,037	0,042	0,046	0,050	0,054	0,061
	4	1,5 x D	0,5 x D	1 x D	50	–	60	fz	0,045	0,052	0,058	0,064	0,069	0,074	0,084
H	1	1,5 x D	0,5 x D	0,75 x D	80	–	140	fz	0,054	0,062	0,070	0,077	0,083	0,088	0,098
	2	1,5 x D	0,2 x D	0,5 x D	70	–	120	fz	0,040	0,047	0,052	0,057	0,061	0,065	0,071

NOTE: Lower value of cutting speed is used for high stock removal applications or for higher hardness (machinability) within group.
Higher value of cutting speed is used for finishing applications or for lower hardness (machinability) within group.
Above parameters are based on ideal conditions. For smaller taper machining centers, please adjust parameters accordingly on >12mm diameters.

VariMill II Long • Series 5718 • Application Data • AlTiN-MT • Metric

INDEXABLE MILLING

SOLID END MILLING

HOLEMAKING

TAPPING

TURNING

		Side Milling (A)		AlTiN			Recommended feed per tooth (fz = mm/th) for side milling (A).									
Material Group	A	A		Cutting Speed – vc m/min			mm	D1 – Diameter								
		ap	ae	min	max	6,0		8,0	10,0	12,0	14,0	16,0	18,0	20,0	25,0	
P	0	Ap1 max	0,05 x D*	300	–	400	fz	0,053	0,072	0,086	0,099	0,111	0,121	0,130	0,137	0,149
	1	Ap1 max	0,05 x D*	300	–	400	fz	0,053	0,072	0,086	0,099	0,111	0,121	0,130	0,137	0,149
	2	Ap1 max	0,05 x D*	280	–	380	fz	0,053	0,072	0,086	0,099	0,111	0,121	0,130	0,137	0,149
	3	Ap1 max	0,05 x D*	240	–	320	fz	0,044	0,060	0,073	0,084	0,095	0,105	0,113	0,121	0,137
	4	Ap1 max	0,05 x D*	180	–	300	fz	0,039	0,054	0,065	0,075	0,084	0,092	0,099	0,106	0,117
	5	Ap1 max	0,05 x D*	120	–	200	fz	0,035	0,048	0,058	0,067	0,076	0,084	0,091	0,097	0,109
M	6	Ap1 max	0,05 x D*	100	–	150	fz	0,030	0,040	0,048	0,056	0,062	0,068	0,073	0,078	0,085
	1	Ap1 max	0,05 x D*	180	–	230	fz	0,044	0,060	0,073	0,084	0,095	0,105	0,113	0,121	0,137
	2	Ap1 max	0,05 x D*	120	–	160	fz	0,035	0,048	0,058	0,067	0,076	0,084	0,091	0,097	0,109
K	3	Ap1 max	0,05 x D*	120	–	140	fz	0,030	0,040	0,048	0,056	0,062	0,068	0,073	0,078	0,085
	1	Ap1 max	0,05 x D*	240	–	300	fz	0,053	0,072	0,086	0,099	0,111	0,121	0,130	0,137	0,149
	2	Ap1 max	0,05 x D*	220	–	280	fz	0,044	0,060	0,073	0,084	0,095	0,105	0,113	0,121	0,137
S	3	Ap1 max	0,05 x D*	220	–	260	fz	0,035	0,048	0,058	0,067	0,076	0,084	0,091	0,097	0,109
	1	Ap1 max	0,05 x D*	50	–	90	fz	0,036	0,050	0,061	0,070	0,079	0,087	0,095	0,101	0,114
	2	Ap1 max	0,05 x D*	25	–	40	fz	0,019	0,026	0,032	0,037	0,042	0,046	0,050	0,054	0,061
H	3	Ap1 max	0,05 x D*	25	–	40	fz	0,019	0,026	0,032	0,037	0,042	0,046	0,050	0,054	0,061
	4	Ap1 max	0,05 x D*	50	–	60	fz	0,026	0,037	0,045	0,052	0,058	0,064	0,069	0,074	0,084
	1	Ap1 max	0,05 x D*	160	–	280	fz	0,039	0,054	0,065	0,075	0,084	0,092	0,099	0,106	0,117
H	2	Ap1 max	0,06 x D*	140	–	240	fz	0,030	0,040	0,048	0,056	0,062	0,068	0,073	0,078	0,085

* For the above cutting data, do not exceed an overall ae of 0,8mm.

NOTE: Lower value of cutting speed is used for high stock removal applications or for higher hardness (machinability) within group.

Higher value of cutting speed is used for finishing applications or for lower hardness (machinability) within group.

Above parameters are based on ideal conditions. For smaller taper machining centers, please adjust parameters accordingly on >0,5mm diameters.

ALL-STAR PRODUCTS FROM WIDIA™

The All-Star program provides proven solutions that are always available to order for next-day shipping if ordered before 6pm EST or 4pm CET



 ALL-STAR

WIDIA ™
widia.com

VariMill III™ ER

High-Performance Solid End Milling

VariMill III ER is a 7-flute solid carbide end mill engineered to provide the highest metal removal rates in difficult-to-machine workpiece materials, providing extended tool life in semi-finishing, finishing, and dynamic milling operations.

Features and Benefits



FAST

The 7-flute geometry ensures highest feed-rates in side milling operations.

DYNAMIC

The flute and core design enables high performance and productivity in high-speed and dynamic milling applications.

SPECIFIC

VariMill III ER is particularly engineered to tackle all milling applications on difficult-to-cut materials such as heat-resistant superalloys and stainless steels.

DYNAMICALLY PRODUCTIVE

PRODUCT

SOLID CARBIDE END MILL

GRADE

WS15PE

FLUTE

7

DIAMETER RANGE

METRIC

10–20mm

INDUSTRY



GENERAL
ENGINEERING



ENERGY



AEROSPACE

APPLICATIONS

MATERIALS

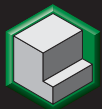

SIDE MILLING



DYNAMIC
MILLING



HELICAL
INTERPOLATION



RAMPING

VariMill III ER • Series 771E 772E • Square End • 7 Flute • Metric

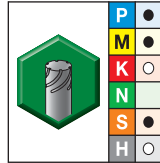
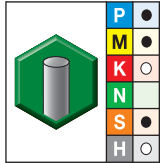
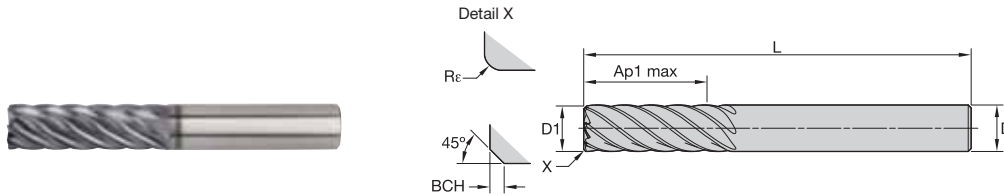

● first choice
○ alternate choice

WS15PE		WS15PE		D1	D	length of cut Ap1 max	length L	Rε	BCH	Z U
5978092	771E10004T	—	—	10,0	10	30,00	76	—	0,50	7
5978093	771E10024T	—	—	10,0	10	30,00	76	0,50	—	7
5978094	772E10004T	—	—	10,0	10	50,00	100	—	0,50	7
5978095	772E10024T	—	—	10,0	10	50,00	100	0,50	—	7
5978098	771E12005T	—	—	12,0	12	36,00	100	—	0,50	7
5978099	771E12025T	—	—	12,0	12	36,00	100	0,50	—	7
5978100	772E12005T	5978102	772E12005V	12,0	12	60,00	125	—	0,50	7
5978101	772E12025T	5978103	772E12025V	12,0	12	60,00	125	0,50	—	7
5978106	771E16006T	—	—	16,0	16	48,00	110	—	0,50	7
5978107	771E16026T	—	—	16,0	16	48,00	110	0,50	—	7
5978108	772E16006T	5978110	772E16006V	16,0	16	80,00	141	—	0,50	7
5978109	772E16026T	5978111	772E16026V	16,0	16	80,00	141	0,50	—	7
5978114	771E20007T	—	—	20,0	20	60,00	125	—	0,50	7
5978115	771E20027T	—	—	20,0	20	60,00	125	0,50	—	7
5978116	772E20007T	5978118	772E20007V	20,0	20	100,00	166	—	0,50	7
5978117	772E20027T	5978119	772E20027V	20,0	20	100,00	166	0,50	—	7

VariMill III ER • Series 77NE • Square End • Neck • 7 Flute • Metric

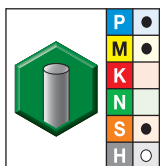
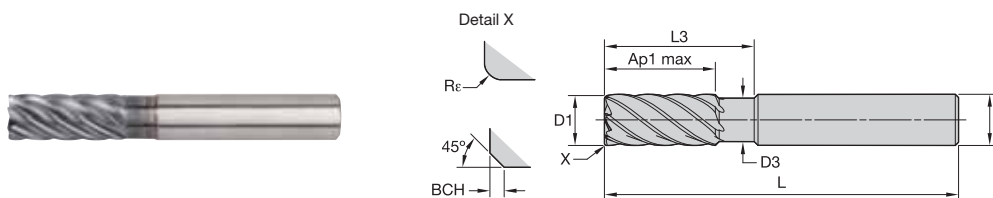

● first choice
○ alternate choice

WS15PE		D1	D	D3	length of cut Ap1 max	L3	length L	Rε	BCH	Z U
5978039	77NE10004T	10,0	10	9,40	22,00	30,00	76	—	0,50	7
5978040	77NE10024T	10,0	10	9,40	22,00	30,00	76	0,50	—	7
5978096	77NE12005T	12,0	12	11,28	26,00	36,00	83	—	0,50	7
5978097	77NE12025T	12,0	12	11,28	26,00	36,00	83	0,50	—	7
5978104	77NE16006T	16,0	16	15,04	32,00	48,00	100	—	0,50	7
5978105	77NE16026T	16,0	16	15,04	32,00	48,00	100	0,50	—	7
5978112	77NE20007T	20,0	20	18,80	38,00	60,00	115	—	0,50	7
5978113	77NE20027T	20,0	20	18,80	38,00	60,00	115	0,50	—	7

VariMill III ER • Series 771E • Finishing • Application Data • WS15PE • Metric

Material Group		Side Milling (A)		WS15PE			Recommended feed per tooth (fz = mm/th) for side milling (A).							
		A		Cutting Speed – vc m/min			mm	D1 – Diameter						
		ap	ae	min	max	10,0		12,0	14,0	16,0	18,0	20,0	25,0	
		4	5	1	2	3	1	2	3	4	1	2		
P	4	Ap1 max	0,1 x D	90	-	150	fz	0,054	0,062	0,070	0,077	0,083	0,088	0,098
	5	Ap1 max	0,1 x D	60	-	100	fz	0,048	0,056	0,063	0,070	0,076	0,081	0,091
M	1	Ap1 max	0,1 x D	90	-	115	fz	0,061	0,070	0,079	0,087	0,095	0,101	0,114
	2	Ap1 max	0,1 x D	60	-	80	fz	0,048	0,056	0,063	0,070	0,076	0,081	0,091
S	3	Ap1 max	0,1 x D	60	-	70	fz	0,040	0,047	0,052	0,057	0,061	0,065	0,071
	1	Ap1 max	0,1 x D	50	-	90	fz	0,061	0,070	0,079	0,087	0,095	0,101	0,114
	2	Ap1 max	0,1 x D	25	-	40	fz	0,032	0,037	0,042	0,046	0,050	0,054	0,061
H	3	Ap1 max	0,1 x D	25	-	40	fz	0,032	0,037	0,042	0,046	0,050	0,054	0,061
	4	Ap1 max	0,1 x D	50	-	60	fz	0,045	0,052	0,058	0,064	0,069	0,074	0,084
H	1	Ap1 max	0,1 x D	80	-	140	fz	0,054	0,062	0,070	0,077	0,083	0,088	0,098
	2	Ap1 max	0,1 x D	70	-	120	fz	0,040	0,047	0,052	0,057	0,061	0,065	0,071

NOTE: Lower value of cutting speed is used for high stock removal applications or for higher hardness (machinability) within group.
Higher value of cutting speed is used for finishing applications or for lower hardness (machinability) within group.
Above parameters are based on ideal conditions. For smaller taper machining centers, please adjust parameters accordingly on >12mm diameters.

VariMill III ER • Series 771E • Semi-Finishing • Application Data • WS15PE • Metric

Material Group		Side Milling (A)		WS15PE			Recommended feed per tooth (fz = mm/th) for side milling (A).							
		A		Cutting Speed – vc m/min			mm	D1 – Diameter						
		ap	ae	min	max	10,0		12,0	14,0	16,0	18,0	20,0	25,0	
		4	5	1	2	3	1	2	3	4	1	2		
P	4	Ap1 max	0,06 x D	180	-	300	fz	0,065	0,075	0,084	0,092	0,099	0,106	0,117
	5	Ap1 max	0,06 x D	120	-	200	fz	0,058	0,067	0,076	0,084	0,091	0,097	0,109
M	1	Ap1 max	0,06 x D	180	-	230	fz	0,073	0,084	0,095	0,105	0,113	0,121	0,137
	2	Ap1 max	0,06 x D	120	-	160	fz	0,058	0,067	0,076	0,084	0,091	0,097	0,109
S	3	Ap1 max	0,06 x D	120	-	140	fz	0,048	0,056	0,062	0,068	0,073	0,078	0,085
	1	Ap1 max	0,06 x D	50	-	90	fz	0,061	0,070	0,079	0,087	0,095	0,101	0,114
	2	Ap1 max	0,06 x D	25	-	40	fz	0,032	0,037	0,042	0,046	0,050	0,054	0,061
H	3	Ap1 max	0,06 x D	25	-	40	fz	0,032	0,037	0,042	0,046	0,050	0,054	0,061
	4	Ap1 max	0,06 x D	50	-	60	fz	0,045	0,052	0,058	0,064	0,069	0,074	0,084
H	1	Ap1 max	0,06 x D	160	-	280	fz	0,065	0,075	0,084	0,092	0,099	0,106	0,117
	2	Ap1 max	0,06 x D	140	-	240	fz	0,048	0,056	0,062	0,068	0,073	0,078	0,085

NOTE: Lower value of cutting speed is used for high stock removal applications or for higher hardness (machinability) within group.
Higher value of cutting speed is used for finishing applications or for lower hardness (machinability) within group.
Above parameters are based on ideal conditions. For smaller taper machining centers, please adjust parameters accordingly on >12mm diameters.

VariMill III ER • Series 772E • Application Data • WS15PE • Metric

Material Group	Side Milling (A)		WS15PE			Recommended feed per tooth (fz = mm/th) for side milling (A).						
	A		Cutting Speed – vc m/min			mm	D1 – Diameter					
	ap	ae	min	max	10,0		12,0	14,0	16,0	18,0	20,0	
P	0	Ap1 max, 0,05 x D	300	–	400	fz	0,086	0,099	0,111	0,121	0,130	0,137
	1	Ap1 max, 0,05 x D	300	–	400	fz	0,086	0,099	0,111	0,121	0,130	0,137
	2	Ap1 max, 0,05 x D	280	–	380	fz	0,086	0,099	0,111	0,121	0,130	0,137
	3	Ap1 max, 0,05 x D	240	–	320	fz	0,073	0,084	0,095	0,105	0,113	0,121
	4	Ap1 max, 0,05 x D	180	–	300	fz	0,065	0,075	0,084	0,092	0,099	0,106
	5	Ap1 max, 0,05 x D	120	–	200	fz	0,058	0,067	0,076	0,084	0,091	0,097
M	6	Ap1 max, 0,05 x D	100	–	150	fz	0,048	0,056	0,062	0,068	0,073	0,078
	1	Ap1 max, 0,05 x D	180	–	230	fz	0,073	0,084	0,095	0,105	0,113	0,121
	2	Ap1 max, 0,05 x D	120	–	160	fz	0,058	0,067	0,076	0,084	0,091	0,097
K	3	Ap1 max, 0,05 x D	120	–	140	fz	0,048	0,056	0,062	0,068	0,073	0,078
	1	Ap1 max, 0,05 x D	240	–	300	fz	0,086	0,099	0,111	0,121	0,130	0,137
	2	Ap1 max, 0,05 x D	220	–	280	fz	0,073	0,084	0,095	0,105	0,113	0,121
S	3	Ap1 max, 0,05 x D	220	–	260	fz	0,058	0,067	0,076	0,084	0,091	0,097
	1	Ap1 max, 0,05 x D	50	–	90	fz	0,061	0,070	0,079	0,087	0,095	0,101
	2	Ap1 max, 0,05 x D	25	–	40	fz	0,032	0,037	0,042	0,046	0,050	0,054
	3	Ap1 max, 0,05 x D	25	–	40	fz	0,032	0,037	0,042	0,046	0,050	0,054
H	4	Ap1 max, 0,05 x D	50	–	60	fz	0,045	0,052	0,058	0,064	0,069	0,074
	1	Ap1 max, 0,05 x D	160	–	280	fz	0,065	0,075	0,084	0,092	0,099	0,106
	2	Ap1 max, 0,06 x D	140	–	240	fz	0,048	0,056	0,062	0,068	0,073	0,078

NOTE: Lower value of cutting speed is used for high stock removal applications or for higher hardness (machinability) within group.
Higher value of cutting speed is used for finishing applications or for lower hardness (machinability) within group.
Above parameters are based on ideal conditions. For smaller taper machining centers, please adjust parameters accordingly on >12mm diameters.

VariMill III ER • Series 77NE • Application Data • WS15PE • Metric

Material Group	Side Milling (A)		WS15PE			Recommended feed per tooth (fz = mm/th) for side milling (A).						
	A		Cutting Speed – vc m/min			mm	D1 – Diameter					
	ap	ae	min	max	10,0		12,0	14,0	16,0	18,0	20,0	
P	4	1 x D, 0,15 x D	90	–	150	fz	0,054	0,062	0,070	0,077	0,083	0,088
	5	1 x D, 0,15 x D	60	–	100	fz	0,048	0,056	0,063	0,070	0,076	0,081
M	1	1 x D, 0,15 x D	90	–	115	fz	0,061	0,070	0,079	0,087	0,095	0,101
	2	1 x D, 0,15 x D	60	–	80	fz	0,048	0,056	0,063	0,070	0,076	0,081
	3	1 x D, 0,15 x D	60	–	70	fz	0,040	0,047	0,052	0,057	0,061	0,065
S	1	1 x D, 0,15 x D	50	–	90	fz	0,061	0,070	0,079	0,087	0,095	0,101
	2	1 x D, 0,15 x D	25	–	40	fz	0,032	0,037	0,042	0,046	0,050	0,054
	3	1 x D, 0,15 x D	25	–	40	fz	0,032	0,037	0,042	0,046	0,050	0,054
	4	1 x D, 0,15 x D	50	–	60	fz	0,045	0,052	0,058	0,064	0,069	0,074
H	1	1 x D, 0,15 x D	80	–	140	fz	0,054	0,062	0,070	0,077	0,083	0,088
	2	1 x D, 0,15 x D	70	–	120	fz	0,040	0,047	0,052	0,057	0,061	0,065

NOTE: Lower value of cutting speed is used for high stock removal applications or for higher hardness (machinability) within group.
Higher value of cutting speed is used for finishing applications or for lower hardness (machinability) within group.
Above parameters are based on ideal conditions. For smaller taper machining centers, please adjust parameters accordingly on >12mm diameters.

INDEXABLE MILLING

SOLID END MILLING

HOLEMAKING

TAPPING

TURNING



Roughers

High-Performance Solid End Milling

The High-Performance Roughers group of products includes numerous end mills with chip breaker profiles to operate on multiple materials and in multiple end markets, providing effective chip control to reduce the spindle power and efficiently machine components when a high quantity of material needs to be removed. This group is designed with chip breaker profiles to operate on low-power machines or when the cutting conditions are not stable.

Features and Benefits

Chipbreaker profiles generate small and easy-to-evacuate chips.

Center cut for improved plunging and ramping applications.

Different helix angles to ensure the best performance and cutting actions on different materials categories.



The chip breaker profile on Rougher end mills helps reduce cutting forces and temperature increases, allowing the tool to perform operations longer. With different available shapes, the roughing profiles ensure the formation of small chips which are easier to evacuate from the cutting area on different workpiece materials.

SMOOTH

The chipbreaker profile helps to reduce cutting forces and the generation of high temperatures.

EASY

Small chips are easy to evacuate from the cutting area, increasing productivity and reducing machine downtime.

FIRM

The Roughers' end mills are the perfect tool when full slotting operations are the daily job.

ROUGHING BEYOND THE LIMITS

PRODUCT

SOLID CARBIDE END MILL

GRADE

WP15PE
WS15PE
TiAlN

FLUTE

3-6

DIAMETER RANGE

METRIC

3-25mm

INDUSTRY



GENERAL
ENGINEERING



AEROSPACE



ENERGY



TRANSPORTATION

APPLICATIONS

MATERIALS

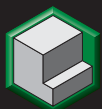

SIDE MILLING



RAMPING



HELICAL INTERPOLATION



SLOTTING



DYNAMIC MILLING



PLUNGING

Roughers • Series 4906 • Chamfer • Metric

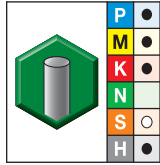
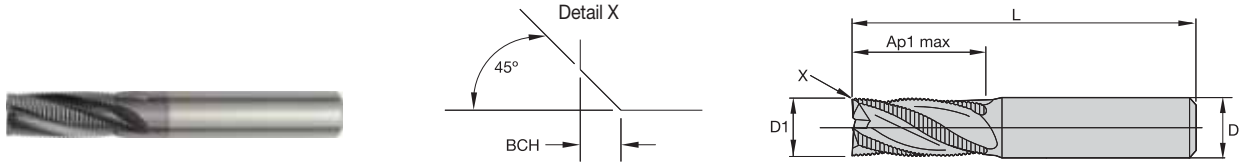

WP15PE

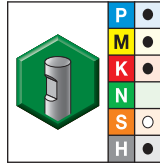

WP15PE

● first choice
○ alternate choice

order #	catalogue #	order #	catalogue #	D1	D	length of cut Ap1 max	length L	BCH	ZU
1657001	490604002RT	1657002	490604002RW	4,0	6	11,00	55	0,30	3
1657009	490605002RT	1657010	490605002RW	5,0	6	13,00	57	0,30	3
1657018	490606002RT	1657019	490606002RW	6,0	6	13,00	57	0,30	3
3133084	490607003RT	1657025	490607003RW	7,0	8	16,00	63	0,30	3
1657033	490608003RT	1657034	490608003RW	8,0	8	16,00	63	0,30	3
1657050	490610004RT	1657051	490610004RW	10,0	10	22,00	72	0,50	4
3133086	490611005RT	—	—	11,0	12	26,00	83	0,50	4
1657063	490612005RT	1657064	490612005RW	12,0	12	26,00	83	0,50	4
—	—	1657085	490614014RW	14,0	14	26,00	83	0,50	4
1657096	490616006RT	1657097	490616006RW	16,0	16	32,00	92	0,50	4
1657112	490620007RT	1657113	490620007RW	20,0	20	38,00	104	0,50	4
—	—	1657121	490625008RW	25,0	25	45,00	121	0,50	5

INDEXABLE MILLING

SOLID END MILLING

HOLEMAKING

TAPPING

TURNING

Roughers • Series 4976 • Chamfer • Metric

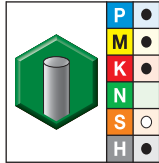
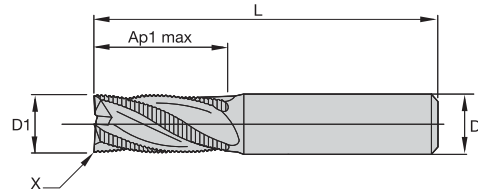
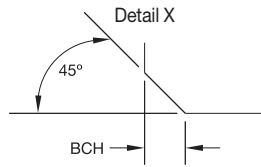

WP15PE

● first choice
○ alternate choice

order #	catalogue #	D1	D	length of cut		BCH	ZU
				Ap1 max	L		
5560708	497604002T	4,0	6	8,00	57	0,30	3
5560709	497605002T	5,0	6	13,00	57	0,30	3
5560710	497606002T	6,0	6	13,00	57	0,30	3
5560711	497608003T	8,0	8	16,00	63	0,30	3
5560712	497610004T	10,0	10	22,00	72	0,50	4
5560713	497612005T	12,0	12	26,00	83	0,50	4
5560714	497614014T	14,0	14	26,00	83	0,50	4
5560715	497616006T	16,0	16	32,00	92	0,50	4
5560717	497620007T	20,0	20	38,00	104	0,50	4

Roughers • Series 49N6 • Chamfer • Neck • Metric

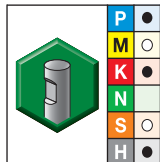
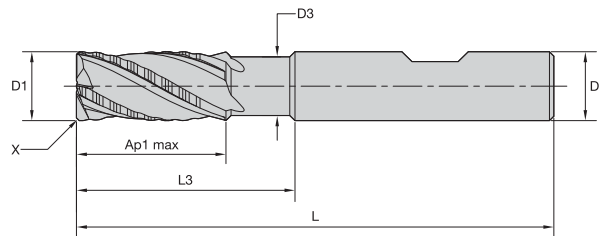
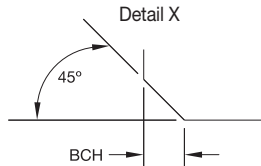

WP15PE

● first choice
○ alternate choice

order #	catalogue #	D1	D	D3	length of cut		L	BCH	ZU
					Ap1 max	L3			
3474585	49N606002MW	6,0	6	5,50	13,00	21,00	57	0,30	3
3474587	49N608003MW	8,0	8	7,50	16,00	27,00	63	0,30	3
3474589	49N610004MW	10,0	10	9,50	22,00	32,00	72	0,50	4
3474591	49N612005MW	12,0	12	11,00	26,00	38,00	83	0,50	4
3474594	49N616006MW	16,0	16	15,00	32,00	44,00	92	0,50	4
3474597	49N625008MW	25,0	25	24,00	45,00	65,00	121	0,50	5

Roughers • Series 4U50 • Radius • Metric

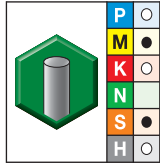
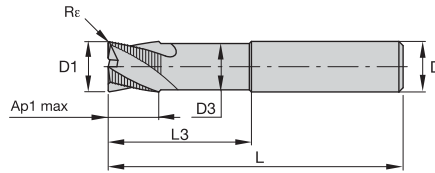

WS15PE

● first choice
○ alternate choice

order #	catalogue #	D1	D	D3	length of cut		length			ZU
					Ap1 max	L3	L	Re		
6431403	4U50M060R2TC	6,0	6	5,64	6,00	18,00	57	0,30	4	
6431404	4U50M080R3TC	8,0	8	7,52	8,00	24,00	63	0,30	4	
6431405	4U50M100R4TE	10,0	10	9,40	10,00	30,00	72	0,50	4	
6431406	4U50M120R5TE	12,0	12	11,28	12,00	36,00	83	0,50	4	
6431407	4U50M160R6TE	16,0	16	15,04	16,00	48,00	92	0,50	6	
6431408	4U50M200R7TG	20,0	20	18,80	20,00	60,00	104	1,00	6	
6431409	4U50M250R8TG	25,0	25	23,50	25,00	75,00	121	1,00	6	

Roughers • Series 4U80 • Radius • Metric

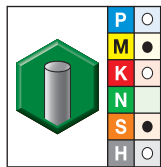
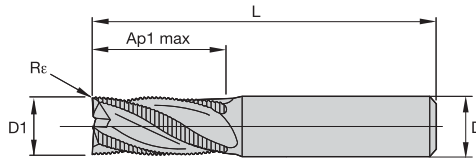

WS15PE

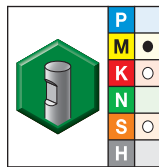

AITiN-MW

● first choice
○ alternate choice

order #	catalogue #	order #	catalogue #	D1	D	length of cut		length			ZU
						Ap1 max	L	Re			
6431246	4U80M060R2TC	6652714	4U80M060R2WC	6,0	6	13,00	57	0,30	4		
6431247	4U80M080R3TC	6652715	4U80M080R3WC	8,0	8	16,00	63	0,30	4		
6431248	4U80M100R4TE	6652716	4U80M100R4WE	10,0	10	22,00	72	0,50	4		
6431249	4U80M120R5TE	6652717	4U80M120R5WE	12,0	12	26,00	83	0,50	4		
6431250	4U80M160R6TE	6652718	4U80M160R6WE	16,0	16	32,00	92	0,50	6		
6431401	4U80M200R7TG	—	—	20,0	20	38,00	104	1,00	6		
6431402	4U80M250R8TG	—	—	25,0	25	45,00	121	1,00	6		

Roughers • Series 4U40 • Radius • Metric

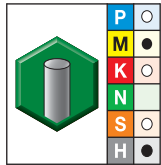
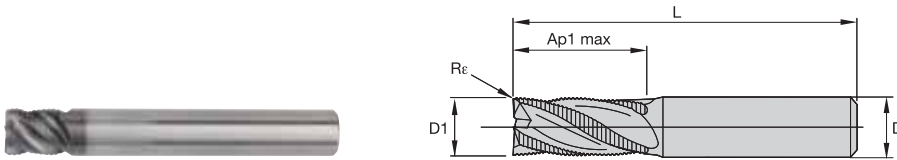

WP15PE

● first choice
○ alternate choice

order #	catalogue #	D1	D	length of cut Ap1 max	length L	Re	ZU
5583420	4U4008003T	8,0	8	8,00	63	0,75	4

Roughers • Series 4U70 • Radius • Metric

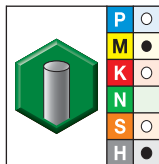
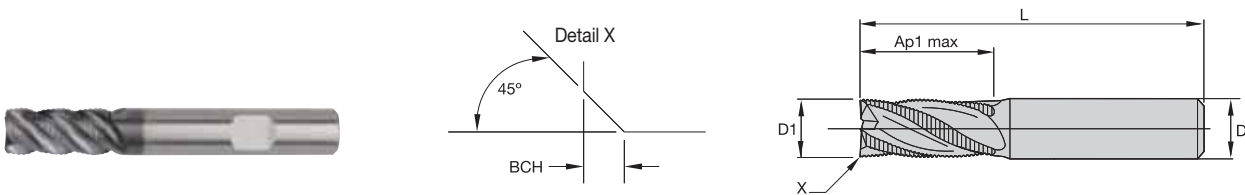

WP15PE

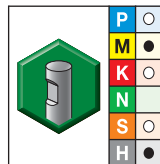

WP15PE

● first choice
○ alternate choice

order #	catalogue #	order #	catalogue #	D1	D	length of cut Ap1 max	length L	BCH	ZU
—	—	5583436	4U7006002W	6,0	6	13,00	57	0,30	4
—	—	5583437	4U7008003W	8,0	8	16,00	63	0,40	4
—	—	5583439	4U7012005W	12,0	12	26,00	83	0,60	4
—	—	5583440	4U7016006W	16,0	16	32,00	92	0,60	6
5583431	4U7016046T	—	—	16,0	16	32,00	92	0,60	4
5583433	4U7020047T	—	—	20,0	20	38,00	104	1,00	4

Roughers • Series DQ13 • Radius • Metric

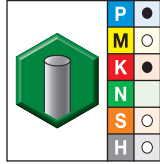
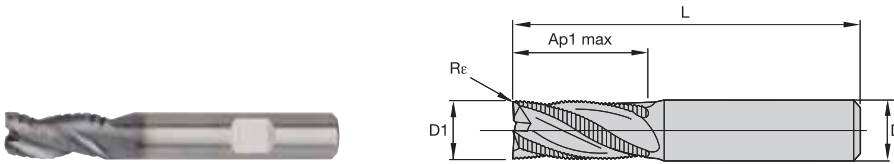

WP15PE

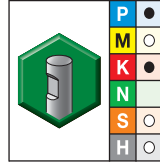

WP15PE

● first choice
○ alternate choice

order #	catalogue #	order #	catalogue #	D1	D	length of cut Ap1 max	length L	R _ε	ZU
5560534	DQ1303002T	5560536	DQ1303002W	3,0	6	7,00	54	0,25	3
5560535	DQ1304002T	-	-	4,0	6	8,00	57	0,25	3
-	-	5560538	DQ1305002W	5,0	6	10,00	57	0,25	3
-	-	5560539	DQ1306002W	6,0	6	10,00	57	0,45	3
-	-	5560701	DQ1308003W	8,0	8	16,00	63	0,45	3
-	-	5560702	DQ1310004W	10,0	10	19,00	72	0,45	3
-	-	5560703	DQ1312005W	12,0	12	22,00	83	0,45	3
-	-	5560704	DQ1314014W	14,0	14	22,00	83	0,45	3
-	-	5560705	DQ1316006W	16,0	16	32,00	92	0,45	3
-	-	5560706	DQ1318018W	18,0	18	32,00	92	0,45	3

Roughers • Series 49H6 • Chamfer • Internal Coolant • Metric

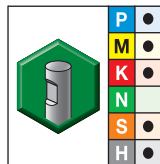
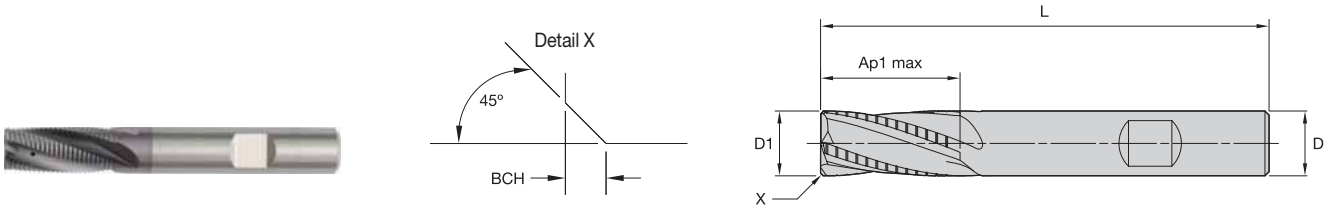

TiAlN-LW

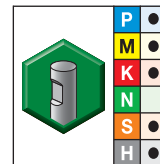

WP15PE

● first choice
○ alternate choice

order #	catalogue #	order #	catalogue #	D1	D	length of cut Ap1 max	length L	BCH	ZU
-	-	1657264	49H610004RW	10,0	10	22,00	72	0,50	4
-	-	1657268	49H612005RW	12,0	12	26,00	83	0,50	4
1968206	49H614014LW	-	-	14,0	14	26,00	83	0,50	4
-	-	1657274	49H616006RW	16,0	16	32,00	92	0,50	4

Roughers • Series 4940 • Radius • Metric

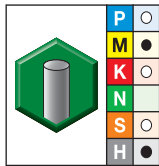
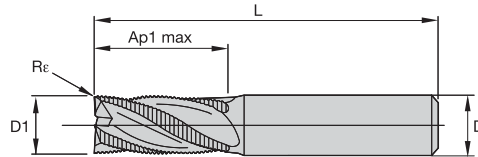

TiAlN-LT

● first choice
○ alternate choice

order #	catalogue #	D1	D	length of cut Ap1 max	length L	Re	ZU
1846543	494006002LT	6,0	6	6,00	57	0,75	4
1846544	494008003LT	8,0	8	8,00	63	0,75	4
1846545	494010004LT	10,0	10	10,00	72	0,75	4
1846546	494012005LT	12,0	12	12,00	83	1,00	4
1846547	494016006LT	16,0	16	16,00	92	1,00	6

INDEXABLE MILLING

SOLID END MILLING

HOLEMAKING

TAPPING

TURNING

Roughers • Series 4906 • Application Data • WP15PE • Metric

Material Group	Side Milling (A) and Slotting (B)			WP15PE		Recommended feed per tooth (fz = mm/th) for side milling (A). For slotting (B), reduce fz by 20%.														
	A		B	Cutting Speed – vc m/min		mm	D1 – Diameter													
	ap	ae	ap	min	max		4,0	5,0	6,0	8,0	10,0	12,0	14,0	16,0	18,0	20,0	25,0			
	1,5 x D	0,5 x D	1 x D			fz														
P	0	1,5 x D	0,5 x D	1 x D	150	–	200	fz	0,024	0,031	0,037	0,051	0,061	0,070	0,079	0,086	0,092	0,097	0,105	
	1	1,5 x D	0,5 x D	1 x D	150	–	200	fz	0,024	0,031	0,037	0,051	0,061	0,070	0,079	0,086	0,092	0,097	0,105	
	2	1,5 x D	0,5 x D	1 x D	140	–	190	fz	0,024	0,031	0,037	0,051	0,061	0,070	0,079	0,086	0,092	0,097	0,105	
	3	1,5 x D	0,4 x D	0,75 x D	120	–	160	fz	0,020	0,025	0,031	0,043	0,051	0,060	0,067	0,074	0,080	0,086	0,097	
	4	1,5 x D	0,3 x D	0,3 x D	90	–	150	fz	0,018	0,023	0,028	0,038	0,046	0,053	0,060	0,065	0,070	0,075	0,083	
M	1	1,5 x D	0,4 x D	0,75 x D	60	–	100	fz	0,016	0,021	0,025	0,034	0,041	0,048	0,054	0,059	0,064	0,069	0,077	
	2	1,5 x D	0,4 x D	0,75 x D	90	–	115	fz	0,020	0,025	0,031	0,043	0,051	0,060	0,067	0,074	0,080	0,086	0,097	
K	1	1,5 x D	0,4 x D	0,75 x D	60	–	80	fz	0,016	0,021	0,025	0,034	0,041	0,048	0,054	0,059	0,064	0,069	0,077	
	2	1,5 x D	0,4 x D	1 x D	110	–	140	fz	0,020	0,025	0,031	0,043	0,051	0,060	0,067	0,074	0,080	0,086	0,097	
	3	1,5 x D	0,4 x D	1 x D	110	–	130	fz	0,016	0,021	0,025	0,034	0,041	0,048	0,054	0,059	0,064	0,069	0,077	
S	1	1,5 x D	0,4 x D	0,75 x D	50	–	90	fz	0,023	0,030	0,036	0,050	0,061	0,070	0,079	0,087	0,095	0,101	0,114	
	3	1,5 x D	0,3 x D	0,3 x D	25	–	40	fz	0,013	0,016	0,019	0,026	0,032	0,037	0,042	0,046	0,050	0,054	0,061	
H	1	1,5 x D	0,3 x D	0,3 x D	80	–	140	fz	0,018	0,023	0,028	0,038	0,046	0,053	0,060	0,065	0,070	0,075	0,083	

NOTE: Lower value of cutting speed is used for high stock removal applications or for higher hardness (machinability) within group.
Higher value of cutting speed is used for finishing applications or for lower hardness (machinability) within group.
Above parameters are based on ideal conditions. For smaller taper machining centers, please adjust parameters accordingly on >12mm diameters.

Roughers • Series 4976 • Application Data • WP15PE • Metric

Material Group	Side Milling (A) and Slotting (B)			WP15PE		Recommended feed per tooth (fz = mm/th) for side milling (A). For slotting (B), reduce fz by 20%.														
	A		B	Cutting Speed – vc m/min		mm	D1 – Diameter													
	ap	ae	ap	min	max		4,0	5,0	6,0	8,0	10,0	12,0	14,0	16,0	18,0	20,0	25,0			
	1,5 x D	0,5 x D	1 x D			fz														
P	0	1,5 x D	0,5 x D	1 x D	150	–	200	fz	0,028	0,036	0,044	0,060	0,072	0,083	0,092	0,101	0,108	0,114	0,124	
	1	1,5 x D	0,5 x D	1 x D	150	–	200	fz	0,028	0,036	0,044	0,060	0,072	0,083	0,092	0,101	0,108	0,114	0,124	
	2	1,5 x D	0,5 x D	1 x D	140	–	190	fz	0,028	0,036	0,044	0,060	0,072	0,083	0,092	0,101	0,108	0,114	0,124	
	3	1,5 x D	0,4 x D	0,75 x D	120	–	160	fz	0,023	0,030	0,036	0,050	0,061	0,070	0,079	0,087	0,095	0,101	0,114	
	4	1,5 x D	0,4 x D	0,75 x D	90	–	150	fz	0,021	0,027	0,033	0,045	0,054	0,062	0,070	0,077	0,083	0,088	0,098	
M	1	1,5 x D	0,4 x D	0,75 x D	60	–	100	fz	0,019	0,024	0,029	0,040	0,048	0,056	0,063	0,070	0,076	0,081	0,091	
	2	1,5 x D	0,4 x D	0,75 x D	90	–	115	fz	0,023	0,030	0,036	0,050	0,061	0,070	0,079	0,087	0,095	0,101	0,114	
K	1	1,5 x D	0,4 x D	0,75 x D	60	–	80	fz	0,019	0,024	0,029	0,040	0,048	0,056	0,063	0,070	0,076	0,081	0,091	
	2	1,5 x D	0,4 x D	1 x D	110	–	140	fz	0,023	0,030	0,036	0,050	0,061	0,070	0,079	0,087	0,095	0,101	0,114	
	3	1,5 x D	0,4 x D	1 x D	110	–	130	fz	0,019	0,024	0,029	0,040	0,048	0,056	0,063	0,070	0,076	0,081	0,091	
S	1	1,5 x D	0,3 x D	0,75 x D	50	–	90	fz	0,023	0,030	0,036	0,050	0,061	0,070	0,079	0,087	0,095	0,101	0,114	
	2	1,5 x D	0,3 x D	0,3 x D	25	–	40	fz	0,013	0,016	0,019	0,026	0,032	0,037	0,042	0,046	0,050	0,054	0,061	
H	1	1,5 x D	0,3 x D	0,75 x D	50	–	60	fz	0,016	0,021	0,026	0,037	0,045	0,052	0,058	0,064	0,069	0,074	0,084	
	3	1,5 x D	0,3 x D	0,3 x D	25	–	40	fz	0,013	0,016	0,019	0,026	0,032	0,037	0,042	0,046	0,050	0,054	0,061	

NOTE: Lower value of cutting speed is used for high stock removal applications or for higher hardness (machinability) within group.
Higher value of cutting speed is used for finishing applications or for lower hardness (machinability) within group.
Above parameters are based on ideal conditions. For smaller taper machining centers, please adjust parameters accordingly on >12mm diameters.

Roughers • Series 49N6 • Application Data • WP15PE • Metric

Material Group		Side Milling (A) and Slotting (B)		WP15PE		Recommended feed per tooth (fz = mm/th) for side milling (A). For slotting (B), reduce fz by 20%.															
		A		B		Cutting Speed – vc m/min		D1 – Diameter													
		ap	ae	ap	min	max	mm	4,0	5,0	6,0	8,0	10,0	12,0	14,0	16,0	18,0	20,0	25,0			
		ap	ae	ap	min	max	mm	4,0	5,0	6,0	8,0	10,0	12,0	14,0	16,0	18,0	20,0	25,0			
P	0	1,5 x D	0,5 x D	1 x D	150	–	200	fz	0,024	0,031	0,037	0,051	0,061	0,070	0,079	0,086	0,092	0,097	0,105		
	1	1,5 x D	0,5 x D	1 x D	150	–	200	fz	0,024	0,031	0,037	0,051	0,061	0,070	0,079	0,086	0,092	0,097	0,105		
	2	1,5 x D	0,5 x D	1 x D	140	–	190	fz	0,024	0,031	0,037	0,051	0,061	0,070	0,079	0,086	0,092	0,097	0,105		
	3	1,5 x D	0,4 x D	0,75 x D	120	–	160	fz	0,020	0,025	0,031	0,043	0,051	0,060	0,067	0,074	0,080	0,086	0,097		
	4	1,5 x D	0,3 x D	0,5 x D	90	–	150	fz	0,018	0,023	0,028	0,038	0,046	0,053	0,060	0,065	0,070	0,075	0,083		
M	1	1,5 x D	0,4 x D	0,75 x D	60	–	100	fz	0,016	0,021	0,025	0,034	0,041	0,048	0,054	0,059	0,064	0,069	0,077		
	2	1,5 x D	0,4 x D	0,75 x D	60	–	80	fz	0,016	0,021	0,025	0,034	0,041	0,048	0,054	0,059	0,064	0,069	0,077		
	3	1,5 x D	0,4 x D	0,75 x D	60	–	80	fz	0,014	0,017	0,021	0,029	0,034	0,040	0,044	0,048	0,052	0,055	0,060		
K	1	1,5 x D	0,5 x D	1 x D	120	–	160	fz	0,024	0,031	0,037	0,051	0,061	0,070	0,079	0,086	0,092	0,097	0,105		
	2	1,5 x D	0,4 x D	1 x D	110	–	140	fz	0,020	0,025	0,031	0,043	0,051	0,060	0,067	0,074	0,080	0,086	0,097		
	3	1,5 x D	0,4 x D	1 x D	100	–	130	fz	0,016	0,021	0,025	0,034	0,041	0,048	0,054	0,059	0,064	0,069	0,077		
S	1	1,5 x D	0,4 x D	0,75 x D	50	–	90	fz	0,023	0,030	0,036	0,050	0,061	0,070	0,079	0,087	0,095	0,101	0,114		
	3	1,5 x D	0,4 x D	0,75 x D	25	–	40	fz	0,013	0,016	0,019	0,026	0,032	0,037	0,042	0,046	0,050	0,054	0,061		
H	1	1,5 x D	0,3 x D	0,3 x D	80	–	140	fz	0,018	0,023	0,028	0,038	0,046	0,053	0,060	0,065	0,070	0,075	0,083		



NOTE: Lower value of cutting speed is used for high stock removal applications or for higher hardness (machinability) within group.
Higher value of cutting speed is used for finishing applications or for lower hardness (machinability) within group.
Above parameters are based on ideal conditions. For smaller taper machining centers, please adjust parameters accordingly on >12mm diameters.

Roughers • Series 4U50 • Application Data • WS15PE • Metric

Material Group		Side Milling (A) and Slotting (B)		WS15PE		Recommended feed per tooth (fz = mm/th) for side milling (A). For slotting (B), reduce fz by 20%.											
		A		B		Cutting Speed – Vc m/min		D1 – Diameter									
		ap	ae	ap	min	max	mm	6,0	8,0	10,0	12,0	14,0	16,0	18,0	20,0	25,0	
		ap	ae	ap	min	max	mm	6,0	8,0	10,0	12,0	14,0	16,0	18,0	20,0	25,0	
M	1	0,8 x D	0,5 x D	0,75 x D	90	–	115	fz	0,036	0,050	0,061	0,070	0,079	0,087	0,095	0,101	0,114
	2	0,8 x D	0,4 x D	0,75 x D	60	–	80	fz	0,029	0,040	0,048	0,056	0,063	0,070	0,076	0,081	0,091
	3	0,8 x D	0,4 x D	0,75 x D	60	–	70	fz	0,025	0,034	0,040	0,047	0,052	0,057	0,061	0,065	0,071
S	1	0,8 x D	0,4 x D	0,75 x D	50	–	90	fz	0,036	0,050	0,061	0,070	0,079	0,087	0,095	0,101	0,114
	2	0,8 x D	0,25 x D	0,3 x D	25	–	40	fz	0,019	0,026	0,032	0,037	0,042	0,046	0,050	0,054	0,061
	3	0,8 x D	0,4 x D	0,75 x D	25	–	40	fz	0,019	0,026	0,032	0,037	0,042	0,046	0,050	0,054	0,061
	4	0,8 x D	0,3 x D	0,3 x D	50	–	60	fz	0,026	0,037	0,045	0,052	0,058	0,064	0,069	0,074	0,084



NOTE: Lower value of cutting speed is used for high stock removal applications or for higher hardness (machinability) within group.
Higher value of cutting speed is used for finishing applications or for lower hardness (machinability) within group.
Above parameters are based on ideal conditions. For smaller taper machining centers, please adjust parameters accordingly on diameters greater than 12mm.

Roughers • Series 4U80 • Application Data • WS15PE/AlTiN-MW • Metric

																					
		Side Milling (A) and Slotting (B)			WS15PE/AlTiN-MW			Recommended feed per tooth (fz = mm/th) for side milling (A). For slotting (B), reduce fz by 20%.													
Material Group		A		B	Cutting Speed – Vc m/min			D1 – Diameter													
		ap	ae	ap	min	max	mm	6,0	8,0	10,0	12,0	14,0	16,0	18,0	20,0	25,0					
M	1	1 x D	0,5 x D	0,75 x D	90	–	115	fz	0,036	0,050	0,061	0,070	0,079	0,087	0,095	0,101	0,114				
	2	1 x D	0,5 x D	0,75 x D	60	–	80	fz	0,029	0,040	0,048	0,056	0,063	0,070	0,076	0,081	0,091				
	3	1 x D	0,5 x D	0,75 x D	60	–	70	fz	0,025	0,034	0,040	0,047	0,052	0,057	0,061	0,065	0,071				
S	1	1 x D	0,3 x D	0,75 x D	50	–	90	fz	0,036	0,050	0,061	0,070	0,079	0,087	0,095	0,101	0,114				
	2	1 x D	0,3 x D	0,3 x D	25	–	40	fz	0,019	0,026	0,032	0,037	0,042	0,046	0,050	0,054	0,061				
	3	1 x D	0,4 x D	0,75 x D	25	–	40	fz	0,019	0,026	0,032	0,037	0,042	0,046	0,050	0,054	0,061				
	4	1 x D	0,4 x D	0,75 x D	50	–	60	fz	0,026	0,037	0,045	0,052	0,058	0,064	0,069	0,074	0,084				

NOTE: Lower value of cutting speed is used for high stock removal applications or for higher hardness (machinability) within group.
Higher value of cutting speed is used for finishing applications or for lower hardness (machinability) within group.
Above parameters are based on ideal conditions. For smaller taper machining centers, please adjust parameters accordingly on diameters greater than 12mm.

Roughers • Series 4U40 • Application Data • WP15PE • Metric

																					
		Side Milling (A) and Slotting (B)			WP15PE			Recommended feed per tooth (fz = mm/th) for side milling (A). For slotting (B), reduce fz by 20%.													
Material Group		A		B	Cutting Speed – vc m/min			D1 – Diameter													
		ap	ae	ap	min	max	mm	6,0	8,0	10,0	12,0	16,0	20,0	25,0							
P	3	0,8 x D	0,5 x D	0,75 x D	120	–	160	fz	0,036	0,050	0,061	0,070	0,087	0,101	0,114						
	4	0,8 x D	0,4 x D	0,5 x D	90	–	150	fz	0,033	0,045	0,054	0,062	0,077	0,088	0,098						
	5	0,8 x D	0,5 x D	0,75 x D	60	–	100	fz	0,029	0,040	0,048	0,056	0,070	0,081	0,091						
M	6	0,8 x D	0,4 x D	0,5 x D	50	–	75	fz	0,025	0,034	0,040	0,047	0,057	0,065	0,071						
	1	0,8 x D	0,5 x D	0,75 x D	90	–	115	fz	0,036	0,050	0,061	0,070	0,087	0,101	0,114						
	2	0,8 x D	0,4 x D	0,75 x D	60	–	80	fz	0,029	0,040	0,048	0,056	0,070	0,081	0,091						
K	3	0,8 x D	0,4 x D	0,75 x D	60	–	70	fz	0,025	0,034	0,040	0,047	0,057	0,065	0,071						
	1	0,8 x D	0,5 x D	0,75 x D	120	–	150	fz	0,044	0,060	0,072	0,083	0,101	0,114	0,124						
	2	0,8 x D	0,5 x D	0,75 x D	110	–	140	fz	0,036	0,050	0,061	0,070	0,087	0,101	0,114						
S	3	0,8 x D	0,4 x D	0,75 x D	110	–	130	fz	0,029	0,040	0,048	0,056	0,070	0,081	0,091						
	1	0,8 x D	0,4 x D	0,75 x D	50	–	90	fz	0,036	0,050	0,061	0,070	0,087	0,101	0,114						
	2	0,8 x D	0,25 x D	0,3 x D	25	–	40	fz	0,019	0,026	0,032	0,037	0,046	0,054	0,061						
	3	0,8 x D	0,4 x D	0,75 x D	25	–	40	fz	0,019	0,026	0,032	0,037	0,046	0,054	0,061						
H	4	0,8 x D	0,3 x D	0,5 x D	50	–	60	fz	0,026	0,037	0,045	0,052	0,064	0,074	0,084						
	1	0,8 x D	0,5 x D	0,5 x D	80	–	140	fz	0,033	0,045	0,054	0,062	0,077	0,088	0,098						
	2	0,8 x D	0,2 x D	0,3 x D	70	–	120	fz	0,025	0,034	0,040	0,047	0,057	0,065	0,071						
3	0,8 x D	0,15 x D	0,2 x D	60	–	90	fz	0,019	0,026	0,032	0,037	0,046	0,054	0,061							

NOTE: Lower value of cutting speed is used for high stock removal applications or for higher hardness (machinability) within group.
Higher value of cutting speed is used for finishing applications or for lower hardness (machinability) within group.
For rougher tool with 6 flutes, use ap in slotting 60% of table value.
Above parameters are based on ideal conditions. For smaller taper machining centers, please adjust parameters accordingly on >12mm diameters.

Roughers • Series 4U70 • Application Data • WP15PE • Metric

Material Group	Side Milling (A) and Slotting (B)			WP15PE			Recommended feed per tooth (fz = mm/th) for side milling (A). For slotting (B), reduce fz by 20%.								
	A		B	Cutting Speed – vc			mm	D1 – Diameter							
	ap	ae	ap	min	m/min	max		6,0	8,0	10,0	12,0	16,0	20,0	25,0	
	1 x D	0,5 x D	0,75 x D				fz	fz	fz	fz	fz	fz	fz	fz	
P	3	1 x D	0,5 x D	0,75 x D	120	–	160	fz	0,036	0,050	0,061	0,070	0,087	0,101	0,114
	4	1 x D	0,3 x D	0,75 x D	90	–	150	fz	0,033	0,045	0,054	0,062	0,077	0,088	0,098
	5	1 x D	0,5 x D	0,75 x D	60	–	100	fz	0,029	0,040	0,048	0,056	0,070	0,081	0,091
	6	1 x D	0,3 x D	0,3 x D	50	–	75	fz	0,025	0,034	0,040	0,047	0,057	0,065	0,071
M	1	1 x D	0,5 x D	0,75 x D	90	–	115	fz	0,036	0,050	0,061	0,070	0,087	0,101	0,114
	2	1 x D	0,5 x D	0,75 x D	60	–	80	fz	0,029	0,040	0,048	0,056	0,070	0,081	0,091
	3	1 x D	0,5 x D	0,75 x D	60	–	70	fz	0,025	0,034	0,040	0,047	0,057	0,065	0,071
K	1	1 x D	0,5 x D	1 x D	120	–	150	fz	0,044	0,060	0,072	0,083	0,101	0,114	0,124
	2	1 x D	0,5 x D	1 x D	110	–	140	fz	0,036	0,050	0,061	0,070	0,087	0,101	0,114
	3	1 x D	0,5 x D	1 x D	110	–	130	fz	0,029	0,040	0,048	0,056	0,070	0,081	0,091
S	1	1 x D	0,3 x D	0,75 x D	50	–	90	fz	0,036	0,050	0,061	0,070	0,087	0,101	0,114
	2	1 x D	0,3 x D	0,3 x D	25	–	40	fz	0,019	0,026	0,032	0,037	0,046	0,054	0,061
	3	1 x D	0,4 x D	0,75 x D	25	–	40	fz	0,019	0,026	0,032	0,037	0,046	0,054	0,061
	4	1 x D	0,4 x D	0,75 x D	50	–	60	fz	0,026	0,037	0,045	0,052	0,064	0,074	0,084
H	1	1 x D	0,3 x D	0,3 x D	80	–	140	fz	0,033	0,045	0,054	0,062	0,077	0,088	0,098
	2	1 x D	0,2 x D	0,2 x D	70	–	120	fz	0,025	0,034	0,040	0,047	0,057	0,065	0,071
	3	1 x D	0,2 x D	0,2 x D	60	–	90	fz	0,019	0,026	0,032	0,037	0,046	0,054	0,061

NOTE: Lower value of cutting speed is used for high stock removal applications or for higher hardness (machinability) within group.
 Higher value of cutting speed is used for finishing applications or for lower hardness (machinability) within group.
 For rougher tool with 6 flutes, use ap in slotting 60% of table value.
 Above parameters are based on ideal conditions. For smaller taper machining centers, please adjust parameters accordingly on >12mm diameters.

Roughers • Series DQ13 • Application Data • WP15PE • Metric

Material Group	Side Milling (A) and Slotting (B)			WP15PE			Recommended feed per tooth (fz = mm/th) for side milling (A). For slotting (B), reduce fz by 20%.												
	A		B	Cutting Speed – vc			mm	D1 – Diameter											
	ap	ae	ap	min	m/min	max		3,0	4,0	5,0	6,0	8,0	10,0	12,0	14,0	16,0	18,0	20,0	
	1 x D	0,5 x D	0,75 x D				fz	fz	fz	fz	fz	fz	fz	fz	fz	fz	fz	fz	
P	0	1 x D	0,5 x D	0,75 x D	150	–	200	fz	0,021	0,028	0,036	0,044	0,060	0,072	0,083	0,092	0,101	0,108	0,114
	1	1 x D	0,5 x D	0,75 x D	150	–	200	fz	0,021	0,028	0,036	0,044	0,060	0,072	0,083	0,092	0,101	0,108	0,114
	2	1 x D	0,5 x D	0,75 x D	140	–	190	fz	0,021	0,028	0,036	0,044	0,060	0,072	0,083	0,092	0,101	0,108	0,114
	3	1 x D	0,5 x D	0,75 x D	120	–	160	fz	0,017	0,023	0,030	0,036	0,050	0,061	0,070	0,079	0,087	0,095	0,101
	4	1 x D	0,5 x D	0,5 x D	90	–	150	fz	0,016	0,021	0,027	0,033	0,045	0,054	0,062	0,070	0,077	0,083	0,088
	5	1 x D	0,5 x D	0,75 x D	60	–	100	fz	0,014	0,019	0,024	0,029	0,040	0,048	0,056	0,063	0,070	0,076	0,081
M	1	1 x D	0,5 x D	0,75 x D	50	–	75	fz	0,012	0,016	0,020	0,025	0,034	0,040	0,047	0,052	0,057	0,061	0,065
	1	1 x D	0,5 x D	0,75 x D	90	–	115	fz	0,017	0,023	0,030	0,036	0,050	0,061	0,070	0,079	0,087	0,095	0,101
	2	1 x D	0,4 x D	0,75 x D	60	–	80	fz	0,014	0,019	0,024	0,029	0,040	0,048	0,056	0,063	0,070	0,076	0,081
K	1	1 x D	0,4 x D	0,75 x D	60	–	70	fz	0,012	0,016	0,020	0,025	0,034	0,040	0,047	0,052	0,057	0,061	0,065
	1	1 x D	0,5 x D	0,75 x D	120	–	150	fz	0,021	0,028	0,036	0,044	0,060	0,072	0,083	0,092	0,101	0,108	0,114
	2	1 x D	0,5 x D	0,75 x D	110	–	140	fz	0,017	0,023	0,030	0,036	0,050	0,061	0,070	0,079	0,087	0,095	0,101
S	1	1 x D	0,4 x D	0,75 x D	110	–	130	fz	0,014	0,019	0,024	0,029	0,040	0,048	0,056	0,063	0,070	0,076	0,081
	1	1 x D	0,3 x D	0,4 x D	50	–	90	fz	0,017	0,023	0,030	0,036	0,050	0,061	0,070	0,079	0,087	0,095	0,101
	2	1 x D	0,3 x D	0,3 x D	25	–	40	fz	0,009	0,013	0,016	0,019	0,026	0,032	0,037	0,042	0,046	0,050	0,054
H	1	1 x D	0,4 x D	0,75 x D	25	–	40	fz	0,009	0,013	0,016	0,019	0,026	0,032	0,037	0,042	0,046	0,050	0,054
	1	1 x D	0,2 x D	0,3 x D	80	–	140	fz	0,011	0,016	0,021	0,026	0,037	0,045	0,052	0,058	0,064	0,069	0,074

NOTE: Lower value of cutting speed is used for high stock removal applications or for higher hardness (machinability) within group.
 Higher value of cutting speed is used for finishing applications or for lower hardness (machinability) within group.
 Above parameters are based on ideal conditions. For smaller taper machining centers, please adjust parameters accordingly on >12mm diameters.

Roughers • Series 49H6 • Application Data • WP15PE/TiAlN-LW • Metric

Material Group																
	Side Milling (A) and Slotting (B)			WP15PE/TiAlN			Recommended feed per tooth (fz = mm/th) for side milling (A). For slotting (B), reduce fz by 20%.									
	A		B	Cutting Speed – vc m/min			D1 – Diameter									
	ap	ae	ap	min	max	mm	8,0	10,0	12,0	14,0	16,0	18,0	20,0			
P	0	1,5 x D	0,5 x D	1 x D	150	–	200	fz	0,048	0,058	0,066	0,074	0,081	0,086	0,091	
	1	1,5 x D	0,5 x D	1 x D	150	–	200	fz	0,048	0,058	0,066	0,074	0,081	0,086	0,091	
	2	1,5 x D	0,5 x D	1 x D	140	–	190	fz	0,048	0,058	0,066	0,074	0,081	0,086	0,091	
	3	1,0 x D	0,4 x D	0,75 x D	120	–	160	fz	0,040	0,048	0,056	0,063	0,070	0,076	0,081	
	4	1,0 x D	0,3 x D	0,5 x D	90	–	150	fz	0,036	0,043	0,050	0,056	0,061	0,066	0,070	
M	1	1,0 x D	0,4 x D	0,75 x D	90	–	115	fz	0,040	0,048	0,056	0,063	0,070	0,076	0,081	
	2	1,0 x D	0,4 x D	0,75 x D	60	–	80	fz	0,032	0,039	0,045	0,051	0,056	0,060	0,065	
	3	1,0 x D	0,4 x D	0,75 x D	60	–	70	fz	0,027	0,032	0,037	0,042	0,046	0,049	0,052	
K	1	1,5 x D	0,5 x D	1 x D	120	–	150	fz	0,048	0,058	0,066	0,074	0,081	0,086	0,091	
	2	1,5 x D	0,4 x D	1 x D	110	–	140	fz	0,040	0,048	0,056	0,063	0,070	0,076	0,081	
	3	1,5 x D	0,4 x D	1 x D	110	–	130	fz	0,032	0,039	0,045	0,051	0,056	0,060	0,065	
S	1	1,5 x D	0,5 x D	0,75 x D	50	–	90	fz	0,050	0,061	0,070	0,079	0,087	0,095	0,101	
	3	1,5 x D	0,5 x D	0,75 x D	25	–	40	fz	0,026	0,032	0,037	0,042	0,046	0,050	0,054	
H	1	1,0 x D	0,3 x D	0,5 x D	80	–	140	fz	0,036	0,043	0,050	0,056	0,061	0,066	0,070	

NOTE: Lower value of cutting speed is used for high-stock removal applications or for higher hardness (machinability) within group.
Higher value of cutting speed is used for finishing applications or for lower hardness (machinability) within group.
Above parameters are based on ideal conditions. For smaller taper machining centers, please adjust parameters accordingly on >12mm diameters.

Roughers • Series 4940 • Application Data • TiAlN-LT • Metric

Material Group																
	A			B	TiAlN			Recommended feed per tooth (fz = mm/th) for side milling (A). For slotting (B), reduce fz by 20%.								
	ap		ae	ap	Cutting Speed – vc m/min			D1 – Diameter								
	ap	ae	ap	min	max	mm	6,0	8,0	10,0	12,0	16,0	20,0	25,0			
P	3	0,8 x D	0,5 x D	0,75 x D	120	–	160	Fz	0,031	0,043	0,051	0,063	0,078	0,101	0,114	
	4	0,8 x D	0,4 x D	0,5 x D	90	–	150	Fz	0,028	0,038	0,046	0,056	0,069	0,088	0,098	
	5	0,8 x D	0,5 x D	0,75 x D	60	–	100	Fz	0,025	0,034	0,041	0,051	0,063	0,081	0,091	
	6	0,8 x D	0,4 x D	0,5 x D	50	–	75	Fz	0,021	0,029	0,034	0,042	0,051	0,065	0,071	
M	1	0,8 x D	0,5 x D	0,75 x D	80	–	100	Fz	0,031	0,043	0,051	0,063	0,078	0,101	0,114	
	2	0,8 x D	0,4 x D	0,75 x D	60	–	80	Fz	0,025	0,034	0,041	0,051	0,063	0,081	0,091	
	3	0,8 x D	0,4 x D	0,75 x D	60	–	80	Fz	0,021	0,029	0,034	0,042	0,051	0,065	0,071	
K	1	0,8 x D	0,5 x D	0,75 x D	120	–	160	Fz	0,037	0,051	0,061	0,075	0,091	0,114	0,124	
	2	0,8 x D	0,5 x D	0,75 x D	110	–	140	Fz	0,031	0,043	0,051	0,063	0,078	0,101	0,114	
	3	0,8 x D	0,4 x D	0,75 x D	100	–	130	Fz	0,025	0,034	0,041	0,051	0,063	0,081	0,091	
S	1	0,8 x D	0,4 x D	0,75 x D	50	–	90	Fz	0,036	0,050	0,061	0,070	0,087	0,101	0,114	
	2	0,8 x D	0,25 x D	0,3 x D	25	–	40	Fz	0,019	0,026	0,032	0,037	0,046	0,054	0,061	
	3	0,8 x D	0,4 x D	0,75 x D	25	–	40	Fz	0,019	0,026	0,032	0,037	0,046	0,054	0,061	
	4	0,8 x D	0,3 x D	0,5 x D	50	–	60	Fz	0,026	0,037	0,045	0,052	0,064	0,074	0,084	
H	1	0,8 x D	0,5 x D	0,5 x D	80	–	140	Fz	0,028	0,038	0,046	0,056	0,069	0,088	0,098	
	2	0,8 x D	0,2 x D	0,3 x D	70	–	120	Fz	0,021	0,029	0,034	0,042	0,051	0,065	0,071	
	3	0,8 x D	0,2 x D	0,2 x D	60	–	90	Fz	0,017	0,023	0,027	0,034	0,041	0,052	0,057	

NOTE: Lower value of cutting speed is used for high-stock removal applications or for higher hardness (machinability) within group.
Higher value of cutting speed is used for finishing applications or for lower hardness (machinability) within group.
For rougher tool with 6 flutes, use ap in slotting 60% of table value.
Above parameters are based on ideal conditions. For smaller taper machining centers, please adjust parameters accordingly on diameters greater than 12mm.



Finishers

High-Performance Solid End Milling

Use the Finishers end mill range to perform precise finishes (in both surface quality and dimension) to the final stages of component machining.

Features and Benefits

Center cutting for improved floor finishing.

Designed profiles with multiple flutes and higher helix for super finishing applications.

Unique geometries designed to be material specific.



The Finishers end mill range was designed using carbide substrates with market-leading geometries and advanced surface technologies, delivering precise movements and smooth floor finishes to a range of components.

PRECISE

The Finishers end mill line will help CNC companies achieve optimal finishes in both surface quality and dimensions.

COMPLETE

From steel to cast iron and stainless steels, the Finishers offer material-specific end mills to complete component jobs.

READY

The Finishers end mill range is ready to make the final pass on critical finishing operations using specialized designs with a higher number of flutes and increased helix angles for super finishing applications.

MIRROR FINISH

PRODUCT

SOLID CARBIDE END MILL

GRADE

WP15PE
TiAIN

FLUTE

2-8

DIAMETER RANGE

METRIC

1-25mm

INDUSTRY



GENERAL
ENGINEERING



AEROSPACE



ENERGY



TRANSPORTATION

APPLICATIONS

MATERIALS

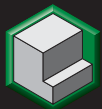

SIDE MILLING



3D PROFILING

Finishers • Series DC03 • Radius • Metric

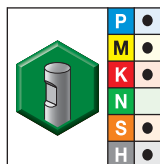
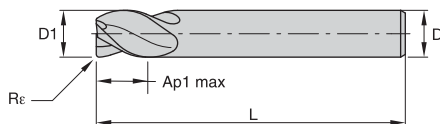

TiAlN-LW

● first choice
○ alternate choice

order #	catalogue #	D1	D	length of cut Ap1 max	length L	Re	ZU
1661856	DC0303002LW	3,0	6	4,00	50	0,25	3
1661858	DC0304002LW	4,0	6	5,00	54	0,25	3
1661862	DC0306002LW	6,0	6	7,00	54	0,45	3
1661866	DC0308003LW	8,0	8	9,00	58	0,45	3
1661868	DC0310004LW	10,0	10	11,00	66	0,45	3
1661870	DC0312005LW	12,0	12	12,00	73	0,45	3

Finishers • Series 4603 • Sharp Edge • Metric

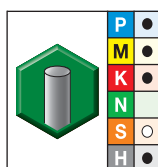
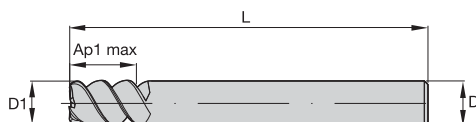

WP15PE

● first choice
○ alternate choice

order #	catalogue #	D1	D	length of cut Ap1 max	length L	ZU
1656750	460303002RT	3,0	6	8,00	57	3
1656758	460304002RT	4,0	6	11,00	57	3
1656773	460306002RT	6,0	6	13,00	57	3
1656781	460308003RT	8,0	8	19,00	63	3
1656791	460310004RT	10,0	10	22,00	72	3
1656799	460312005RT	12,0	12	26,00	83	3
1656807	460316006RT	16,0	16	32,00	92	3

Finishers • Series D503 D513 • Square End • Metric

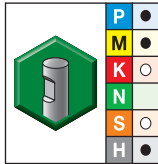
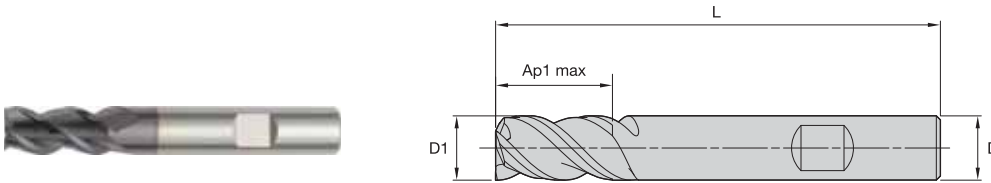

● first choice
○ alternate choice

TiAlN		D1	D	length of cut Ap1 max	length L	Z U
1661574	D50302002RW	2,0	6	3,00	50	3
6613012	D503025C2W	2,5	6	3,00	50	3
1661578	D50303002RW	3,0	6	4,00	50	3
6613013	D503030C2W	3,0	6	4,00	50	3
1661680	D51303002RW	3,0	6	7,00	57	3
6613014	D513035C2W	3,5	6	7,00	57	3
1661583	D50304002RW	4,0	6	5,00	54	3
6613015	D503040C2W	4,0	6	5,00	54	3
1661684	D51304002RW	4,0	6	8,00	57	3
1661588	D50305002RW	5,0	6	6,00	54	3
1661688	D51305002RW	5,0	6	10,00	57	3
1661593	D50306002RW	6,0	6	7,00	54	3
6613016	D503060C2W	6,0	6	7,00	54	3
1661692	D51306002RW	6,0	6	10,00	57	3
6613017	D503080C3W	8,0	8	9,00	58	3
1661603	D50308003RW	8,0	8	9,00	58	3
1661701	D51308003RW	8,0	8	16,00	63	3
6613018	D503100C4W	10,0	10	11,00	66	3
1661710	D51310004RW	10,0	10	19,00	72	3
6613019	D503120C5W	12,0	12	12,00	73	3
1661715	D51312005RW	12,0	12	22,00	83	3
1661720	D51314014RW	14,0	14	22,00	83	3
1661725	D51316006RW	16,0	16	26,00	92	3

INDEXABLE MILLING

SOLID END MILLING

HOLEMAKING

TAPPING

TURNING

Finishers • Series D507 D517 • Sharp Edge • Metric

INDEXABLE MILLING

SOLID END MILLING

HOLEMAKING

TAPPING

TURNING

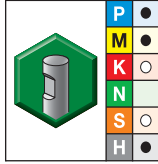
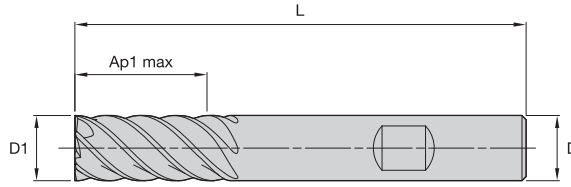

WP15PE

● first choice
○ alternate choice

order #	catalogue #	D1	D	length of cut Ap1 max	length L	ZU
5559100	D50706002W	6,0	6	10,00	54	6
5559108	D51706002W	6,0	6	13,00	57	6
5559101	D50708003W	8,0	8	12,00	58	6
5559109	D51708003W	8,0	8	19,00	63	6
5559102	D50710004W	10,0	10	14,00	66	6
5559110	D51710004W	10,0	10	22,00	72	6
5559103	D50712005W	12,0	12	16,00	73	6
5559111	D51712005W	12,0	12	26,00	83	6
5559112	D51714014W	14,0	14	26,00	83	6
5559105	D50716006W	16,0	16	22,00	82	6
5559113	D51716006W	16,0	16	32,00	92	6
5559114	D51718018W	18,0	18	32,00	92	6
5559107	D50720007W	20,0	20	26,00	92	6
5559115	D51720007W	20,0	20	38,00	104	6

Finishers • Series 4503 JJ • Sharp Edge • JIS

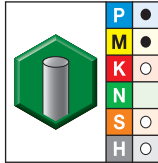
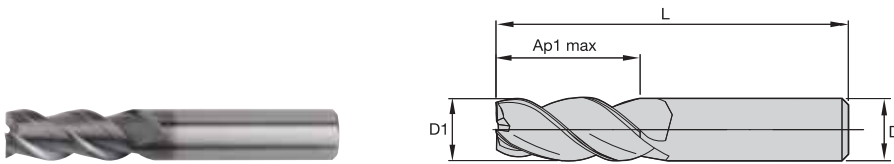

● first choice
○ alternate choice

WP15PE		D1	D	length of cut Ap1 max	length L	ZU
5559170	450301001T	1,0	4	3,00	50	3
5559171	450301501T	1,5	4	3,00	50	3
5559172	450302001T	2,0	4	3,00	50	3
5559173	450302501T	2,5	4	4,00	50	3
5559174	450302511T	2,5	4	5,00	50	3
5559175	450303002T	3,0	6	8,00	50	3
5559176	450303502T	3,5	6	12,00	50	3
5559177	450304002T	4,0	6	12,00	50	3
5559178	450304502T	4,5	6	14,00	50	3
5559179	450305002T	5,0	6	14,00	50	3
5559180	450306002T	6,0	6	16,00	50	3
5559181	450308003T	8,0	8	20,00	63	3
5559182	450310004T	10,0	10	22,00	76	3
5559183	450312005T	12,0	12	25,00	76	3
5559184	450316006T	16,0	16	32,00	89	3
5559185	450320007T	20,0	20	38,00	104	3

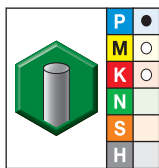
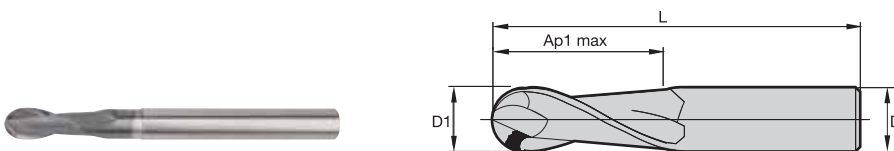

Finishers • Series 4001 JJ • Ball Nose • JIS



● first choice
○ alternate choice

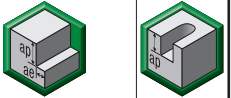

WP15PE		D1	D	length of cut Ap1 max	length L	ZU
5559146	400101001T	1,0	4	3,00	50	2
5559147	400101501T	1,5	4	3,00	50	2
5559148	400102001T	2,0	4	3,00	50	2
5559149	400103002T	3,0	6	9,50	58	2
5559160	400104002T	4,0	6	12,00	76	2
5559161	400105002T	5,0	6	14,00	76	2
5559162	400106002T	6,0	6	16,00	100	2
5559163	400108003T	8,0	8	20,00	100	2
5559164	400110004T	10,0	10	22,00	100	2
5559165	400112005T	12,0	12	25,00	125	2
5559167	400116006T	16,0	16	32,00	150	2

Finishers • Series DC03 • Application Data • TiAlN-LW • Metric

Material Group	 			TiAlN		Recommended feed per tooth (fz = mm/th) for side milling (A). For slotting (B), reduce fz by 20%.													
	Side Milling (A) and Slotting (B)			Cutting Speed – vc m/min		D1 – Diameter													
	A		B	min	max	mm	3,0	4,0	5,0	6,0	8,0	10,0	12,0	14,0	16,0	18,0	20,0		
	ap	ae	ap																
P	0	0,75 x D	0,4 x D	0,5 x D	150	–	200	fz	0,021	0,028	0,028	0,028	0,028	0,044	0,060	0,072	0,083	0,101	0,114
	1	0,75 x D	0,4 x D	0,5 x D	150	–	200	fz	0,021	0,028	0,028	0,028	0,028	0,044	0,060	0,072	0,083	0,101	0,114
	2	0,75 x D	0,4 x D	0,5 x D	140	–	190	fz	0,018	0,023	0,023	0,023	0,023	0,036	0,050	0,061	0,070	0,087	0,101
	3	0,75 x D	0,4 x D	0,5 x D	120	–	160	fz	0,016	0,021	0,021	0,021	0,021	0,033	0,045	0,054	0,062	0,077	0,088
	4	0,75 x D	0,4 x D	0,3 x D	90	–	150	fz	0,014	0,019	0,019	0,019	0,019	0,029	0,040	0,048	0,056	0,070	0,081
	5	0,75 x D	0,4 x D	0,5 x D	60	–	100	fz	0,014	0,019	0,019	0,019	0,019	0,029	0,040	0,048	0,056	0,070	0,081
M	6	0,75 x D	0,4 x D	0,3 x D	50	–	75	fz	0,012	0,016	0,016	0,016	0,016	0,025	0,034	0,040	0,047	0,057	0,065
	1	0,75 x D	0,4 x D	0,5 x D	90	–	115	fz	0,018	0,023	0,023	0,023	0,023	0,036	0,050	0,061	0,070	0,087	0,101
	2	0,75 x D	0,4 x D	0,5 x D	60	–	80	fz	0,014	0,019	0,019	0,019	0,019	0,029	0,040	0,048	0,056	0,070	0,081
K	3	0,75 x D	0,4 x D	0,5 x D	60	–	70	fz	0,012	0,016	0,016	0,016	0,016	0,025	0,034	0,040	0,047	0,057	0,065
	1	0,75 x D	0,4 x D	0,5 x D	120	–	150	fz	0,021	0,028	0,028	0,028	0,028	0,044	0,060	0,072	0,083	0,101	0,114
	2	0,75 x D	0,4 x D	0,5 x D	110	–	140	fz	0,018	0,023	0,023	0,023	0,023	0,036	0,050	0,061	0,070	0,087	0,101
S	3	0,75 x D	0,4 x D	0,5 x D	110	–	130	fz	0,014	0,019	0,019	0,019	0,019	0,029	0,040	0,048	0,056	0,070	0,081
	1	0,75 x D	0,4 x D	0,3 x D	50	–	90	fz	0,017	0,023	0,030	0,036	0,050	0,061	0,070	0,079	0,087	0,095	0,101
	2	0,75 x D	0,4 x D	0,3 x D	25	–	40	fz	0,009	0,013	0,016	0,019	0,026	0,032	0,037	0,042	0,046	0,050	0,054
	3	0,75 x D	0,4 x D	0,3 x D	25	–	40	fz	0,009	0,013	0,016	0,019	0,026	0,032	0,037	0,042	0,046	0,050	0,054
H	4	0,75 x D	0,4 x D	0,5 x D	50	–	60	fz	0,011	0,016	0,021	0,026	0,037	0,045	0,052	0,058	0,064	0,069	0,074
	1	0,75 x D	0,4 x D	0,3 x D	80	–	140	fz	0,016	0,021	0,021	0,021	0,021	0,033	0,045	0,054	0,062	0,077	0,088



NOTE: Lower value of cutting speed is used for high stock removal applications or for higher hardness (machinability) within group.
Higher value of cutting speed is used for finishing applications or for lower hardness (machinability) within group.
Above parameters are based on ideal conditions. For smaller taper machining centers, please adjust parameters accordingly on >12mm diameters.

Finishers • Series 4603 • Application Data • WP15PE • Metric

Material Group	 			WP15PE/TiAlN		Recommended feed per tooth (fz = mm/th) for side milling (A). For slotting (B), reduce fz by 20%.													
	Side Milling (A) and Slotting (B)			Cutting Speed – vc m/min		D1 – Diameter													
	A		B	min	max	mm	3,0	4,0	5,0	6,0	8,0	10,0	12,0	16,0	18,0	20,0			
	ap	ae	ap																
P	0	1,5 x D	0,3 x D	0,5 x D	150	–	200	fz	0,017	0,023	0,029	0,035	0,048	0,058	0,066	0,081	0,086	0,091	
	1	1,5 x D	0,3 x D	0,5 x D	150	–	200	fz	0,017	0,023	0,029	0,035	0,048	0,058	0,066	0,081	0,086	0,091	
	2	1,5 x D	0,3 x D	0,5 x D	140	–	190	fz	0,017	0,023	0,029	0,035	0,048	0,058	0,066	0,081	0,086	0,091	
	3	1,5 x D	0,3 x D	0,5 x D	120	–	160	fz	0,014	0,019	0,024	0,029	0,040	0,048	0,056	0,070	0,076	0,081	
	4	1,5 x D	0,3 x D	0,3 x D	90	–	150	fz	0,013	0,017	0,022	0,026	0,036	0,043	0,050	0,061	0,066	0,070	
	5	1,5 x D	0,3 x D	0,5 x D	60	–	100	fz	0,011	0,015	0,019	0,024	0,032	0,039	0,045	0,056	0,060	0,065	
M	6	1,5 x D	0,3 x D	0,3 x D	50	–	75	fz	0,010	0,013	0,016	0,020	0,027	0,032	0,037	0,046	0,049	0,052	
	1	1,5 x D	0,3 x D	0,5 x D	90	–	115	fz	0,014	0,019	0,024	0,029	0,040	0,048	0,056	0,070	0,076	0,081	
	2	1,5 x D	0,3 x D	0,5 x D	60	–	80	fz	0,011	0,015	0,019	0,024	0,032	0,039	0,045	0,056	0,060	0,065	
K	3	1,5 x D	0,3 x D	0,5 x D	60	–	70	fz	0,010	0,013	0,016	0,020	0,027	0,032	0,037	0,046	0,049	0,052	
	1	1,5 x D	0,3 x D	0,5 x D	120	–	150	fz	0,017	0,023	0,029	0,035	0,048	0,058	0,066	0,081	0,086	0,091	
	2	1,5 x D	0,3 x D	0,5 x D	110	–	140	fz	0,014	0,019	0,024	0,029	0,040	0,048	0,056	0,070	0,076	0,081	
S	3	1,5 x D	0,3 x D	0,5 x D	110	–	130	fz	0,011	0,015	0,019	0,024	0,032	0,039	0,045	0,056	0,060	0,065	
	1	1,5 x D	0,3 x D	0,3 x D	50	–	90	fz	0,017	0,023	0,030	0,036	0,050	0,061	0,070	0,087	0,095	0,101	
	2	1,5 x D	0,3 x D	0,3 x D	25	–	40	fz	0,009	0,013	0,016	0,019	0,026	0,032	0,037	0,046	0,050	0,054	
	3	1,5 x D	0,3 x D	0,3 x D	25	–	40	fz	0,009	0,013	0,016	0,019	0,026	0,032	0,037	0,046	0,050	0,054	
H	4	1,5 x D	0,3 x D	0,5 x D	50	–	60	fz	0,011	0,016	0,021	0,026	0,037	0,045	0,052	0,064	0,069	0,074	
	1	1,5 x D	0,3 x D	0,3 x D	80	–	140	fz	0,013	0,017	0,022	0,026	0,036	0,043	0,050	0,061	0,066	0,070	

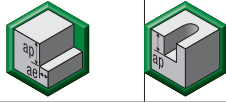

NOTE: Lower value of cutting speed is used for high stock removal applications or for higher hardness (machinability) within group.
Higher value of cutting speed is used for finishing applications or for lower hardness (machinability) within group.
Above parameters are based on ideal conditions. For smaller taper machining centers, please adjust parameters accordingly on >12mm diameters.

Finishers • Series D503 • Application Data • TiAlN • Metric

Material Group																					
	Side Milling (A) and Slotting (B)			TiAlN		Recommended feed per tooth (fz = mm/th) for side milling (A). For slotting (B), reduce fz by 20%.															
	A		B	Cutting Speed – vc m/min		D1 – Diameter															
	ap	ae	ap	min	max	mm	3,0	4,0	5,0	6,0	8,0	10,0	12,0	14,0	16,0	18,0	20,0				
P	0	0,75 x D	0,4 x D	0,5 x D	150	–	200	fz	0,021	0,028	0,036	0,044	0,060	0,072	0,083	0,092	0,101	0,108	0,114		
	1	0,75 x D	0,4 x D	0,5 x D	150	–	200	fz	0,021	0,028	0,036	0,044	0,060	0,072	0,083	0,092	0,101	0,108	0,114		
	2	0,75 x D	0,4 x D	0,5 x D	140	–	190	fz	0,021	0,028	0,036	0,044	0,060	0,072	0,083	0,092	0,101	0,108	0,114		
	3	0,75 x D	0,4 x D	0,5 x D	120	–	160	fz	0,017	0,023	0,030	0,036	0,050	0,061	0,070	0,079	0,087	0,095	0,101		
	4	0,75 x D	0,4 x D	0,3 x D	90	–	150	fz	0,016	0,021	0,027	0,033	0,045	0,054	0,062	0,070	0,077	0,083	0,088		
	5	0,75 x D	0,4 x D	0,5 x D	60	–	100	fz	0,014	0,019	0,024	0,029	0,040	0,048	0,056	0,063	0,070	0,076	0,081		
M	6	0,75 x D	0,4 x D	0,3 x D	50	–	75	fz	0,012	0,016	0,020	0,025	0,034	0,040	0,047	0,052	0,057	0,061	0,065		
	1	0,75 x D	0,4 x D	0,5 x D	90	–	115	fz	0,017	0,023	0,030	0,036	0,050	0,061	0,070	0,079	0,087	0,095	0,101		
	2	0,75 x D	0,4 x D	0,5 x D	60	–	80	fz	0,014	0,019	0,024	0,029	0,040	0,048	0,056	0,063	0,070	0,076	0,081		
K	3	0,75 x D	0,4 x D	0,5 x D	60	–	70	fz	0,012	0,016	0,020	0,025	0,034	0,040	0,047	0,052	0,057	0,061	0,065		
	1	0,75 x D	0,4 x D	0,5 x D	120	–	150	fz	0,021	0,028	0,036	0,044	0,060	0,072	0,083	0,092	0,101	0,108	0,114		
	2	0,75 x D	0,4 x D	0,5 x D	110	–	140	fz	0,017	0,023	0,030	0,036	0,050	0,061	0,070	0,079	0,087	0,095	0,101		
S	3	0,75 x D	0,4 x D	0,5 x D	110	–	130	fz	0,014	0,019	0,024	0,029	0,040	0,048	0,056	0,063	0,070	0,076	0,081		
	1	0,75 x D	0,4 x D	0,3 x D	50	–	90	fz	0,017	0,023	0,030	0,036	0,050	0,061	0,070	0,079	0,087	0,095	0,101		
	2	0,75 x D	0,4 x D	0,3 x D	25	–	40	fz	0,009	0,013	0,016	0,019	0,026	0,032	0,037	0,042	0,046	0,050	0,054		
	3	0,75 x D	0,4 x D	0,3 x D	25	–	40	fz	0,009	0,013	0,016	0,019	0,026	0,032	0,037	0,042	0,046	0,050	0,054		
H	4	0,75 x D	0,4 x D	0,5 x D	50	–	60	fz	0,011	0,016	0,021	0,026	0,037	0,045	0,052	0,058	0,064	0,069	0,074		
	1	0,75 x D	0,4 x D	0,3 x D	80	–	140	fz	0,016	0,021	0,027	0,033	0,045	0,054	0,062	0,070	0,077	0,083	0,088		

NOTE: Lower value of cutting speed is used for high stock removal applications or for higher hardness (machinability) within group.
 Higher value of cutting speed is used for finishing applications or for lower hardness (machinability) within group.
 Above parameters are based on ideal conditions. For smaller taper machining centers, please adjust parameters accordingly on greater than 12mm diameters.

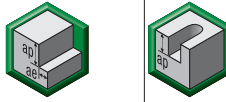
Finishers • Series D513 • Application Data • TiAlN • Metric

Material Group																					
	Side Milling (A) and Slotting (B)			TiAlN		Recommended feed per tooth (fz = mm/th) for side milling (A). For slotting (B), reduce fz by 20%.															
	A		B	Cutting Speed – vc m/min		D1 – Diameter															
	ap	ae	ap	min	max	mm	3,0	4,0	5,0	6,0	8,0	10,0	12,0	14,0	16,0	18,0	20,0				
P	0	1,25 x D	0,2 x D	0,25 x D	150	–	200	fz	0,021	0,028	0,036	0,044	0,060	0,072	0,083	0,092	0,101	0,108	0,114		
	1	1,25 x D	0,2 x D	0,25 x D	150	–	200	fz	0,021	0,028	0,036	0,044	0,060	0,072	0,083	0,092	0,101	0,108	0,114		
	2	1,25 x D	0,2 x D	0,25 x D	140	–	190	fz	0,021	0,028	0,036	0,044	0,060	0,072	0,083	0,092	0,101	0,108	0,114		
	3	1,25 x D	0,2 x D	0,25 x D	120	–	160	fz	0,017	0,023	0,030	0,036	0,050	0,061	0,070	0,079	0,087	0,095	0,101		
	4	1,25 x D	0,2 x D	0,25 x D	90	–	150	fz	0,016	0,021	0,027	0,033	0,045	0,054	0,062	0,070	0,077	0,083	0,088		
	5	1,25 x D	0,2 x D	0,25 x D	60	–	100	fz	0,014	0,019	0,024	0,029	0,040	0,048	0,056	0,063	0,070	0,076	0,081		
M	6	1,25 x D	0,2 x D	0,25 x D	50	–	75	fz	0,012	0,016	0,020	0,025	0,034	0,040	0,047	0,052	0,057	0,061	0,065		
	1	1,25 x D	0,2 x D	0,25 x D	90	–	115	fz	0,017	0,023	0,030	0,036	0,050	0,061	0,070	0,079	0,087	0,095	0,101		
	2	1,25 x D	0,2 x D	0,25 x D	60	–	80	fz	0,014	0,019	0,024	0,029	0,040	0,048	0,056	0,063	0,070	0,076	0,081		
K	3	1,25 x D	0,2 x D	0,25 x D	60	–	70	fz	0,012	0,016	0,020	0,025	0,034	0,040	0,047	0,052	0,057	0,061	0,065		
	1	1,25 x D	0,2 x D	0,25 x D	120	–	150	fz	0,021	0,028	0,036	0,044	0,060	0,072	0,083	0,092	0,101	0,108	0,114		
	2	1,25 x D	0,2 x D	0,25 x D	110	–	140	fz	0,017	0,023	0,030	0,036	0,050	0,061	0,070	0,079	0,087	0,095	0,101		
S	3	1,25 x D	0,2 x D	0,25 x D	110	–	130	fz	0,014	0,019	0,024	0,029	0,040	0,048	0,056	0,063	0,070	0,076	0,081		
	1	1,25 x D	0,2 x D	0,25 x D	50	–	90	fz	0,017	0,023	0,030	0,036	0,050	0,061	0,070	0,079	0,087	0,095	0,101		
	2	1,25 x D	0,2 x D	0,25 x D	25	–	40	fz	0,009	0,013	0,016	0,019	0,026	0,032	0,037	0,042	0,046	0,050	0,054		
	3	1,25 x D	0,2 x D	0,25 x D	25	–	40	fz	0,009	0,013	0,016	0,019	0,026	0,032	0,037	0,042	0,046	0,050	0,054		
H	4	1,25 x D	0,2 x D	0,25 x D	50	–	60	fz	0,011	0,016	0,021	0,026	0,037	0,045	0,052	0,058	0,064	0,069	0,074		
	1	1,25 x D	0,2 x D	0,25 x D	80	–	140	fz	0,016	0,021	0,027	0,033	0,045	0,054	0,062	0,070	0,077	0,083	0,088		

NOTE: Lower value of cutting speed is used for high stock removal applications or for higher hardness (machinability) within group.
 Higher value of cutting speed is used for finishing applications or for lower hardness (machinability) within group.
 Above parameters are based on ideal conditions. For smaller taper machining centers, please adjust parameters accordingly on >12mm diameters.

Finishers • Series D507 • Application Data • WP15PE • Metric

Material Group	Side Milling (A)		WP15PE		Recommended feed per tooth (fz = mm/th) for side milling (A).											
	A		Cutting Speed — vc			mm	D1 — Diameter									
	ap	ae	min	m/min	max		4,0	6,0	8,0	10,0	12,0	14,0	16,0	18,0	20,0	
						fz										
P	0	1,0 x D	0,2 x D	150	–	200	fz	0,028	0,044	0,060	0,072	0,083	0,092	0,101	0,108	0,114
	1	1,0 x D	0,2 x D	150	–	200	fz	0,028	0,044	0,060	0,072	0,083	0,092	0,101	0,108	0,114
	2	1,0 x D	0,2 x D	140	–	190	fz	0,028	0,044	0,060	0,072	0,083	0,092	0,101	0,108	0,114
	3	1,0 x D	0,1 x D	120	–	160	fz	0,023	0,036	0,050	0,061	0,070	0,079	0,087	0,095	0,101
	4	1,0 x D	0,1 x D	90	–	150	fz	0,021	0,033	0,045	0,054	0,062	0,070	0,077	0,083	0,088
	5	1,0 x D	0,1 x D	60	–	100	fz	0,019	0,029	0,040	0,048	0,056	0,063	0,070	0,076	0,081
M	6	1,0 x D	0,1 x D	50	–	75	fz	0,016	0,025	0,034	0,040	0,047	0,052	0,057	0,061	0,065
	1	1,0 x D	0,1 x D	90	–	115	fz	0,023	0,036	0,050	0,061	0,070	0,079	0,087	0,095	0,101
	2	1,0 x D	0,1 x D	60	–	80	fz	0,019	0,029	0,040	0,048	0,056	0,063	0,070	0,076	0,081
K	3	1,0 x D	0,1 x D	60	–	70	fz	0,016	0,025	0,034	0,040	0,047	0,052	0,057	0,061	0,065
	1	1,0 x D	0,1 x D	120	–	150	fz	0,028	0,044	0,060	0,072	0,083	0,092	0,101	0,108	0,114
	2	1,0 x D	0,1 x D	110	–	140	fz	0,023	0,036	0,050	0,061	0,070	0,079	0,087	0,095	0,101
S	3	1,0 x D	0,1 x D	110	–	130	fz	0,019	0,029	0,040	0,048	0,056	0,063	0,070	0,076	0,081
	1	1,0 x D	0,1 x D	50	–	90	fz	0,023	0,036	0,050	0,061	0,070	0,079	0,087	0,095	0,101
	2	1,0 x D	0,1 x D	25	–	40	fz	0,013	0,019	0,026	0,032	0,037	0,042	0,046	0,050	0,054
	3	1,0 x D	0,15 x D	25	–	40	fz	0,013	0,019	0,026	0,032	0,037	0,042	0,046	0,050	0,054
H	4	1,0 x D	0,15 x D	50	–	60	fz	0,016	0,026	0,037	0,045	0,052	0,058	0,064	0,069	0,074
	1	1,0 x D	0,1 x D	80	–	140	fz	0,021	0,033	0,045	0,054	0,062	0,070	0,077	0,083	0,088

NOTE: Lower value of cutting speed is used for high stock removal applications or for higher hardness (machinability) within group.
Higher value of cutting speed is used for finishing applications or for lower hardness (machinability) within group.
Above parameters are based on ideal conditions. For smaller taper machining centers, please adjust parameters accordingly on diameters >12mm.

Finishers • Series D517 • Application Data • WP15PE • Metric

Material Group	Side Milling (A)		WP15PE		Recommended feed per tooth (fz = mm/th) for side milling (A).											
	A		Cutting Speed — vc			mm	D1 — Diameter									
	ap	ae	min	m/min	max		4,0	6,0	8,0	10,0	12,0	14,0	16,0	18,0	20,0	
						fz										
P	0	Ap1 max	0,05 x D	150	–	200	fz	0,028	0,044	0,060	0,072	0,083	0,092	0,101	0,108	0,114
	1	Ap1 max	0,05 x D	150	–	200	fz	0,028	0,044	0,060	0,072	0,083	0,092	0,101	0,108	0,114
	2	Ap1 max	0,05 x D	140	–	190	fz	0,028	0,044	0,060	0,072	0,083	0,092	0,101	0,108	0,114
	3	Ap1 max	0,05 x D	120	–	160	fz	0,023	0,036	0,050	0,061	0,070	0,079	0,087	0,095	0,101
	4	Ap1 max	0,05 x D	90	–	150	fz	0,021	0,033	0,045	0,054	0,062	0,070	0,077	0,083	0,088
	5	Ap1 max	0,05 x D	60	–	100	fz	0,019	0,029	0,040	0,048	0,056	0,063	0,070	0,076	0,081
M	6	Ap1 max	0,05 x D	50	–	75	fz	0,016	0,025	0,034	0,040	0,047	0,052	0,057	0,061	0,065
	1	Ap1 max	0,05 x D	90	–	115	fz	0,023	0,036	0,050	0,061	0,070	0,079	0,087	0,095	0,101
	2	Ap1 max	0,05 x D	60	–	80	fz	0,019	0,029	0,040	0,048	0,056	0,063	0,070	0,076	0,081
K	3	Ap1 max	0,05 x D	60	–	70	fz	0,016	0,025	0,034	0,040	0,047	0,052	0,057	0,061	0,065
	1	Ap1 max	0,05 x D	120	–	150	fz	0,028	0,044	0,060	0,072	0,083	0,092	0,101	0,108	0,114
	2	Ap1 max	0,05 x D	110	–	140	fz	0,023	0,036	0,050	0,061	0,070	0,079	0,087	0,095	0,101
S	3	Ap1 max	0,05 x D	110	–	130	fz	0,019	0,029	0,040	0,048	0,056	0,063	0,070	0,076	0,081
	1	Ap1 max	0,04 x D	50	–	90	fz	0,023	0,036	0,050	0,061	0,070	0,079	0,087	0,095	0,101
	2	Ap1 max	0,04 x D	25	–	40	fz	0,013	0,019	0,026	0,032	0,037	0,042	0,046	0,050	0,054
	3	Ap1 max	0,05 x D	25	–	40	fz	0,013	0,019	0,026	0,032	0,037	0,042	0,046	0,050	0,054
H	4	Ap1 max	0,05 x D	50	–	60	fz	0,016	0,026	0,037	0,045	0,052	0,058	0,064	0,069	0,074
	1	Ap1 max	0,04 x D	80	–	140	fz	0,021	0,033	0,045	0,054	0,062	0,070	0,077	0,083	0,088

NOTE: Lower value of cutting speed is used for high stock removal applications or for higher hardness (machinability) within group.
Higher value of cutting speed is used for finishing applications or for lower hardness (machinability) within group.
For better surface finish, reduce feed per tooth.
Above parameters are based on ideal conditions. For smaller taper machining centers, please adjust parameters accordingly on diameters >12mm.

INDEXABLE MILLING



SOLID END MILLING

HOLEMAKING

TAPPING

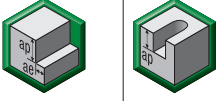

TURNING

Finishers • Series 4503 JJ • Application Data • WP15PE • Metric

																						
		Side Milling (A) and Slotting (B)			WP15PE			Recommended feed per tooth (fz = mm/th) for side milling (A). For slotting (B), reduce fz by 20%.														
Material Group		A		B	Cutting Speed – vc m/min			D1 – Diameter														
		ap	ae	ap	min	max	mm	3,0	4,0	5,0	6,0	8,0	10,0	12,0	16,0	18,0	20,0					
P	0	1,5 x D	0,3 x D	0,5 x D	150	–	200	fz	0,021	0,028	0,036	0,044	0,060	0,072	0,083	0,101	0,108	0,114				
	1	1,5 x D	0,3 x D	0,5 x D	150	–	200	fz	0,021	0,028	0,036	0,044	0,060	0,072	0,083	0,101	0,108	0,114				
	2	1,5 x D	0,3 x D	0,5 x D	140	–	190	fz	0,021	0,028	0,036	0,044	0,060	0,072	0,083	0,101	0,108	0,114				
	3	1,5 x D	0,3 x D	0,5 x D	120	–	160	fz	0,017	0,023	0,030	0,036	0,050	0,061	0,070	0,087	0,095	0,101				
	4	1,5 x D	0,3 x D	0,3 x D	90	–	150	fz	0,016	0,021	0,027	0,033	0,045	0,054	0,062	0,077	0,083	0,088				
	5	1,5 x D	0,3 x D	0,5 x D	60	–	100	fz	0,014	0,019	0,024	0,029	0,040	0,048	0,056	0,070	0,076	0,081				
M	1	1,5 x D	0,3 x D	0,5 x D	90	–	115	fz	0,017	0,023	0,030	0,036	0,050	0,061	0,070	0,087	0,095	0,101				
	2	1,5 x D	0,3 x D	0,5 x D	60	–	80	fz	0,014	0,019	0,024	0,029	0,040	0,048	0,056	0,070	0,076	0,081				
	3	1,5 x D	0,3 x D	0,5 x D	60	–	70	fz	0,012	0,016	0,020	0,025	0,034	0,040	0,047	0,057	0,061	0,065				
K	1	1,5 x D	0,3 x D	0,5 x D	120	–	150	fz	0,021	0,028	0,036	0,044	0,060	0,072	0,083	0,101	0,108	0,114				
	2	1,5 x D	0,3 x D	0,5 x D	110	–	140	fz	0,017	0,023	0,030	0,036	0,050	0,061	0,070	0,087	0,095	0,101				
	3	1,5 x D	0,3 x D	0,5 x D	110	–	130	fz	0,014	0,019	0,024	0,029	0,040	0,048	0,056	0,070	0,076	0,081				
S	1	1,5 x D	0,3 x D	0,3 x D	50	–	90	fz	0,017	0,023	0,030	0,036	0,050	0,061	0,070	0,087	0,095	0,101				
	2	1,5 x D	0,3 x D	0,3 x D	25	–	40	fz	0,009	0,013	0,016	0,019	0,026	0,032	0,037	0,046	0,050	0,054				
	3	1,5 x D	0,3 x D	0,5 x D	25	–	40	fz	0,009	0,013	0,016	0,019	0,026	0,032	0,037	0,046	0,050	0,054				
	4	1,5 x D	0,3 x D	0,5 x D	50	–	60	fz	0,011	0,016	0,021	0,026	0,037	0,045	0,052	0,064	0,069	0,074				
H	1	1,5 x D	0,3 x D	0,3 x D	80	–	140	fz	0,016	0,021	0,027	0,033	0,045	0,054	0,062	0,077	0,083	0,088				

NOTE: Lower value of cutting speed is used for high stock removal applications or for higher hardness (machinability) within group.
Higher value of cutting speed is used for finishing applications or for lower hardness (machinability) within group.
Above parameters are based on ideal conditions. For smaller taper machining centers, please adjust parameters accordingly on >12mm diameters.

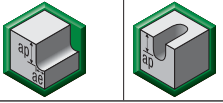
Finishers • Series 4001 JJ • Application Data • WP15PE • Metric

																						
		Side Milling (A) and Slotting (B)			WP15PE			Recommended feed per tooth (fz = mm/th) for side milling (A). For slotting (B), reduce fz by 20%.														
Material Group		A		B	Cutting Speed – vc m/min			D1 – Diameter														
		ap	ae	ap	min	max	mm	2,0	3,0	4,0	5,0	6,0	8,0	10,0	12,0	14,0	16,0	18,0	20,0	25,0		
P	0	1,25 x D	0,25 x D	0,5 x D	150	–	200	fz	0,012	0,019	0,026	0,032	0,039	0,054	0,065	0,075	0,083	0,091	0,097	0,103	0,111	
	1	1,25 x D	0,25 x D	0,5 x D	150	–	200	fz	0,012	0,019	0,026	0,032	0,039	0,054	0,065	0,075	0,083	0,091	0,097	0,103	0,111	
	2	1,25 x D	0,25 x D	0,5 x D	140	–	190	fz	0,012	0,019	0,026	0,032	0,039	0,054	0,065	0,075	0,083	0,091	0,097	0,103	0,111	
	3	1,25 x D	0,25 x D	0,5 x D	120	–	160	fz	0,010	0,016	0,021	0,027	0,033	0,045	0,054	0,063	0,071	0,078	0,085	0,091	0,102	
M	1	1,25 x D	0,25 x D	0,3 x D	90	–	150	fz	0,009	0,014	0,019	0,024	0,030	0,040	0,049	0,056	0,063	0,069	0,075	0,079	0,088	
	2	1,25 x D	0,25 x D	0,5 x D	90	–	115	fz	0,010	0,016	0,021	0,027	0,033	0,045	0,054	0,063	0,071	0,078	0,085	0,091	0,102	
K	1	1,25 x D	0,25 x D	0,5 x D	60	–	80	fz	0,008	0,013	0,017	0,022	0,026	0,036	0,044	0,051	0,057	0,063	0,068	0,073	0,082	
	2	1,25 x D	0,25 x D	0,5 x D	120	–	150	fz	0,012	0,019	0,026	0,032	0,039	0,054	0,065	0,075	0,083	0,091	0,097	0,103	0,111	
N	1	1,25 x D	0,25 x D	0,5 x D	110	–	140	fz	0,010	0,016	0,021	0,027	0,033	0,045	0,054	0,063	0,071	0,078	0,085	0,091	0,102	
	2	1,25 x D	0,25 x D	0,5 x D	500	–	2000	fz	0,018	0,027	0,036	0,045	0,054	0,072	0,090	0,108	0,126	0,144	0,162	0,180	0,225	
	3	1,25 x D	0,25 x D	0,5 x D	500	–	1500	fz	0,016	0,024	0,032	0,041	0,049	0,065	0,081	0,097	0,113	0,130	0,146	0,162	0,203	
	4	1,25 x D	0,25 x D	0,5 x D	250	–	1000	fz	0,016	0,024	0,032	0,041	0,049	0,065	0,081	0,097	0,113	0,130	0,146	0,162	0,203	
N	1	1,25 x D	0,25 x D	0,5 x D	100	–	750	fz	0,018	0,027	0,036	0,045	0,054	0,072	0,090	0,108	0,126	0,144	0,162	0,180	0,225	

NOTE: Lower value of cutting speed is used for high stock removal applications or for higher hardness (machinability) within group.
Higher value of cutting speed is used for finishing applications or for lower hardness (machinability) within group.
Above parameters are based on ideal conditions. For smaller taper machining centers, please adjust parameters accordingly on >12mm diameters.

ALUFLASH end mills are for machining companies seeking a vibration-free tool capable of achieving advanced milling applications at accelerated RPMs.

Features and Benefits

Balanced by design to significantly limit vibrations at high RPMs.

“W” flute shape form evacuates chips to increase process security.

Parabolic core for increased tool stability and reduced deflection and risk of breakage.

Double rake gashing for improved chip evacuation and higher ramping capabilities and Z-axis machining.



ALUFLASH end mills will drill into the full material and execute advanced ramping angles at high-feed rates without RPM limitations.

SAFE

The ALUFLASH end mills' balanced design obliterates any apprehension of spindle damage.

ADVANCED

ALUFLASH provides advanced milling capabilities with steep ramping angles, drilling into the full material and cornering without vibration marks.

ACCELERATED

The ALUFLASH end mills enable machinists to increase cutting speeds to the machine capacity, creating limitless performance in any aluminum application.

ACCELERATED ALUMINUM MACHINING

PRODUCT

SOLID CARBIDE END MILL

GRADE

UNCOATED

FLUTE

2 & 3

DIAMETER RANGE

METRIC

3-20mm

INDUSTRY



GENERAL
ENGINEERING



AEROSPACE

APPLICATIONS

MATERIALS

N

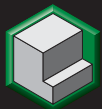

SIDE MILLING



SLOTTING



HELICAL INTERPOLATION



RAMPING



DYNAMIC MILLING



PLUNGING



DRILLING

ALUFLASH • Series 2A09 • Square End • 2 Flute • Regular Length • Cylindrical Shank • Metric

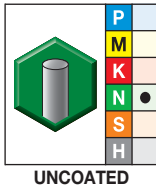
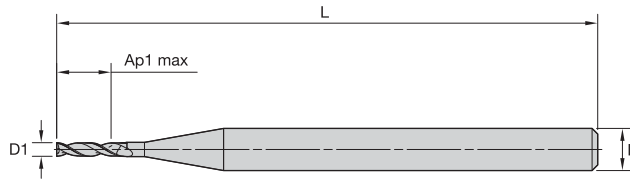

- first choice
- alternate choice

order #	catalogue #	D1	D	length of cut Ap1 max	length L	Z U
6853514	2A09M01000SZT	1,0	3	4,00	38	2
6853515	2A09M01500SZT	1,5	3	6,00	38	2
6853517	2A09M02000SZT	2,0	3	8,00	38	2
6853519	2A09M02500SZT	2,5	3	9,00	38	2
6853542	2A09M04001SZT	4,0	4	12,00	50	2
6853544	2A09M05002SZT	5,0	5	14,00	50	2
6853547	2A09M06003SZT	6,0	6	16,00	50	2
6853549	2A09M08004SZT	8,0	8	20,00	63	2
6853552	2A09M12006SZT	12,0	12	25,00	76	2
6853554	2A09M16008SZT	16,0	16	32,00	89	2
6853556	2A09M20009SZT	20,0	20	40,00	104	2

ALUFLASH • Series 2A09 • Radius • 2 Flute • Regular Length • Cylindrical Shank • Metric

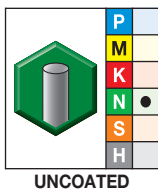
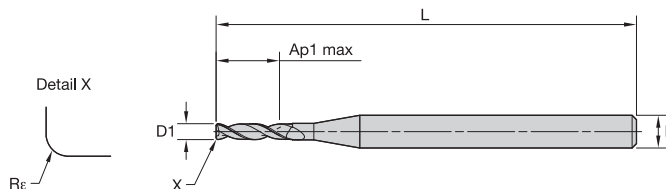

- first choice
- alternate choice

order #	catalogue #	D1	D	length of cut Ap1 max	length L	Rε	Z U
6853516	2A09M01500RAT	1,5	3	6,00	38	0,20	2
6853518	2A09M02000RAT	2,0	3	8,00	38	0,20	2
6853520	2A09M02500RAT	2,5	3	9,00	38	0,20	2
6853541	2A09M03000RAT	3,0	3	12,00	38	0,20	2
6853543	2A09M04001RAT	4,0	4	12,00	50	0,20	2
6853546	2A09M05002RAT	5,0	5	14,00	50	0,20	2
6853548	2A09M06003RET	6,0	6	16,00	50	0,50	2
6853550	2A09M08004RET	8,0	8	20,00	63	0,50	2
6853551	2A09M10005RJT	10,0	10	22,00	76	1,00	2
6853553	2A09M12006RJT	12,0	12	25,00	76	1,00	2
6853555	2A09M16008RJT	16,0	16	32,00	89	1,00	2
6853557	2A09M20009RJT	20,0	20	40,00	104	1,00	2

ALUFLASH • Series 3A09 • Square End • 3 Flute • Regular Length • Cylindrical Shank • Metric

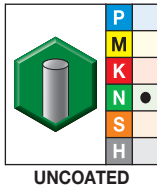
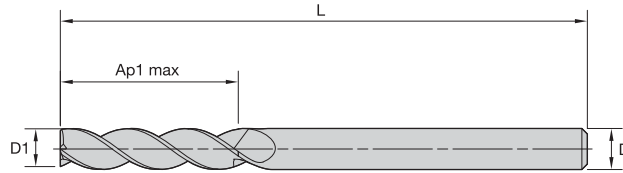

- first choice
- alternate choice

order #	catalogue #	D1	D	length of cut Ap1 max	length L	Z U
6853511	3A09M03000SZT	3,0	3	12,00	38	3

ALUFLASH • Series 3A09 • Radius • 3 Flute • Regular Length • Cylindrical Shank • Metric

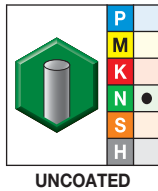
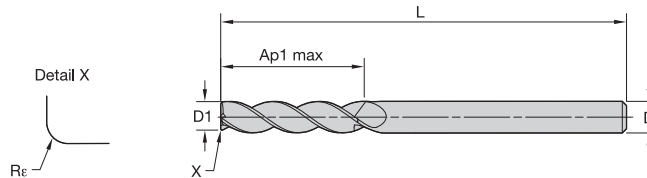

- first choice
- alternate choice

order #	catalogue #	D1	D	length of cut Ap1 max	length L	Re	Z U
6853512	3A09M03000RAT	3,0	3	12,00	38	0,20	3
6853513	3A09M04001RET	4,0	4	12,00	63	0,50	3

INDEXABLE MILLING

SOLID END MILLING

HOLE/MAKING

TAPPING

TURNING

ALUFLASH • Series 3AN9 • Square End • 3 Flute • Regular Length • Regular Neck • Cylindrical Shank • Metric

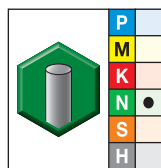
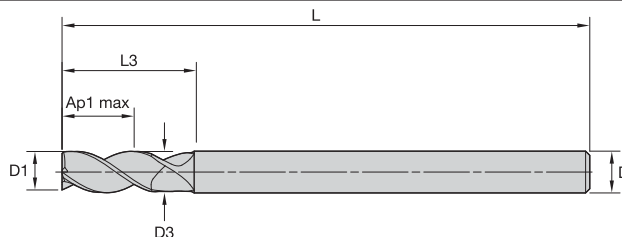

UNCOATED

- first choice
- alternate choice

order #	catalogue #	D1	D	D3	length of cut	length	L3	Z U
					Ap1 max	L		
6853460	3AN9M04001SZT	4,0	4	3,76	8,00	50	12,00	3
6853462	3AN9M05002SZT	5,0	5	4,70	10,00	63	15,00	3
6853465	3AN9M06003SZT	6,0	6	5,64	13,00	63	18,00	3
6853469	3AN9M08004SZT	8,0	8	7,52	18,00	76	24,00	3
6853474	3AN9M10005SZT	10,0	10	9,40	22,00	76	30,00	3
6853479	3AN9M12006SZT	12,0	12	11,28	25,00	76	36,00	3
6853486	3AN9M16008SZT	16,0	16	15,04	32,00	89	48,00	3
6853494	3AN9M20009SZT	20,0	20	18,80	40,00	115	60,00	3

INDEXABLE MILLING

SOLID END MILLING

HOLEMAKING

TAPPING

TURNING

ALUFLASH • Series 3AN9 • Radius • 3 Flute • Regular Length • Regular Neck • Cylindrical Shank • Metric

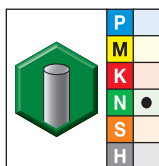

UNCOATED

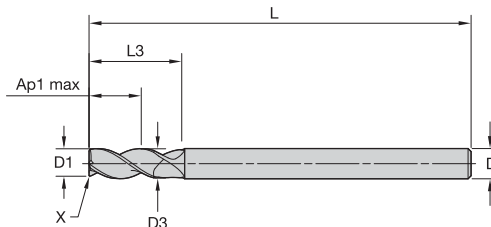
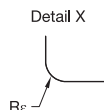

● first choice

○ alternate choice

order #	catalogue #	D1	D	D3	length of cut	length	L3	Re	Z U
					Ap1 max	L			
6853461	3AN9M04001RAT	4,0	4	3,76	8,00	50	12,00	0,20	3
6853463	3AN9M05002RAT	5,0	5	4,70	10,00	63	15,00	0,20	3
6853464	3AN9M05002RET	5,0	5	4,70	10,00	63	15,00	0,50	3
6853466	3AN9M06003RAT	6,0	6	5,64	13,00	63	18,00	0,20	3
6853467	3AN9M06003RET	6,0	6	5,64	13,00	63	18,00	0,50	3
6853468	3AN9M06003RJT	6,0	6	5,64	13,00	63	18,00	1,00	3
6853470	3AN9M08004RAT	8,0	8	7,52	18,00	76	24,00	0,20	3
6853471	3AN9M08004RET	8,0	8	7,52	18,00	76	24,00	0,50	3
6853473	3AN9M08004RHT	8,0	8	7,52	18,00	76	24,00	1,50	3
6853472	3AN9M08004RJT	8,0	8	7,52	18,00	76	24,00	1,00	3
6853475	3AN9M10005RAT	10,0	10	9,40	22,00	76	30,00	0,20	3
6853476	3AN9M10005RET	10,0	10	9,40	22,00	76	30,00	0,50	3
6853478	3AN9M10005RHT	10,0	10	9,40	22,00	76	30,00	1,50	3
6853477	3AN9M10005RJT	10,0	10	9,40	22,00	76	30,00	1,00	3
6853480	3AN9M12006RAT	12,0	12	11,28	25,00	76	36,00	0,20	3
6853481	3AN9M12006RET	12,0	12	11,28	25,00	76	36,00	0,50	3
6853483	3AN9M12006RHT	12,0	12	11,28	25,00	76	36,00	1,50	3
6853482	3AN9M12006RJT	12,0	12	11,28	25,00	76	36,00	1,00	3
6853484	3AN9M12006RKT	12,0	12	11,28	25,00	76	36,00	2,00	3
6853485	3AN9M12006RPT	12,0	12	11,28	25,00	76	36,00	3,00	3
6853487	3AN9M16008RAT	16,0	16	15,04	32,00	89	48,00	0,20	3
6853488	3AN9M16008RET	16,0	16	15,04	32,00	89	48,00	0,50	3
6853490	3AN9M16008RHT	16,0	16	15,04	32,00	89	48,00	1,50	3
6853489	3AN9M16008RJT	16,0	16	15,04	32,00	89	48,00	1,00	3
6853491	3AN9M16008RMT	16,0	16	15,04	32,00	89	48,00	2,50	3
6853492	3AN9M16008RPT	16,0	16	15,04	32,00	89	48,00	3,00	3
6853493	3AN9M16008RQT	16,0	16	15,04	32,00	89	48,00	4,00	3
6853495	3AN9M20009RAT	20,0	20	18,80	40,00	115	60,00	0,20	3
6853496	3AN9M20009RHT	20,0	20	18,80	40,00	115	60,00	1,50	3
6853497	3AN9M20009RKT	20,0	20	18,80	40,00	115	60,00	2,00	3
6853498	3AN9M20009RPT	20,0	20	18,80	40,00	115	60,00	3,00	3
6853499	3AN9M20009RQT	20,0	20	18,80	40,00	115	60,00	4,00	3
6853500	3AN9M20009RRT	20,0	20	18,80	40,00	115	60,00	5,00	3

ALUFLASH • Series 3AP9 • Radius • 3 Flute • Long Length • Regular Neck • Cylindrical Shank • Metric

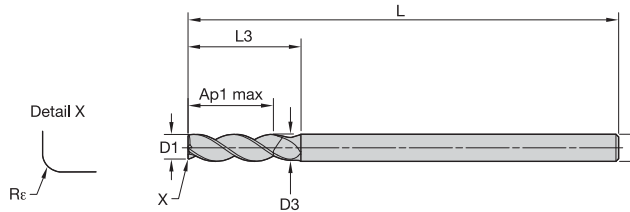
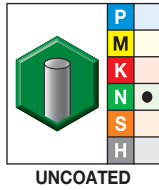

- first choice
- alternate choice

order #	catalogue #	D1	D	D3	length of cut	length	L3	R _ε	Z U
					Ap1 max	L			
6853439	3AP9M04011RAT	4,0	4	3,76	12,00	63	16,00	0,20	3
6853440	3AP9M05002RAT	5,0	5	4,70	15,00	63	20,00	0,20	3
6853441	3AP9M06013RET	6,0	6	5,64	18,00	76	24,00	0,50	3
6853442	3AP9M06013RJT	6,0	6	5,64	18,00	76	24,00	1,00	3
6853443	3AP9M08014RET	8,0	8	7,52	24,00	76	32,00	0,50	3
6853444	3AP9M08014RJT	8,0	8	7,52	24,00	76	32,00	1,00	3
6853445	3AP9M10015RET	10,0	10	9,40	30,00	89	40,00	0,50	3
6853446	3AP9M10015RHT	10,0	10	9,40	30,00	89	40,00	1,50	3
6853447	3AP9M10015RKT	10,0	10	9,40	30,00	89	40,00	2,00	3
6853449	3AP9M12016RET	12,0	12	11,28	36,00	100	48,00	0,50	3
6853450	3AP9M12016RHT	12,0	12	11,28	36,00	100	48,00	1,50	3
6853451	3AP9M12016RPT	12,0	12	11,28	36,00	100	48,00	3,00	3
6853452	3AP9M16018RET	16,0	16	15,04	48,00	110	64,00	0,50	3
6853453	3AP9M16018RHT	16,0	16	15,04	48,00	110	64,00	1,50	3
6853454	3AP9M16018RPT	16,0	16	15,04	48,00	110	64,00	3,00	3
6853455	3AP9M20019RET	20,0	20	18,80	60,00	150	80,00	0,50	3
6853456	3AP9M20019RHT	20,0	20	18,80	60,00	150	80,00	1,50	3
6853457	3AP9M20019RKT	20,0	20	18,80	60,00	150	80,00	2,00	3
6853458	3AP9M20019RPT	20,0	20	18,80	60,00	150	80,00	3,00	3
6853459	3AP9M20019RQT	20,0	20	18,80	60,00	150	80,00	4,00	3

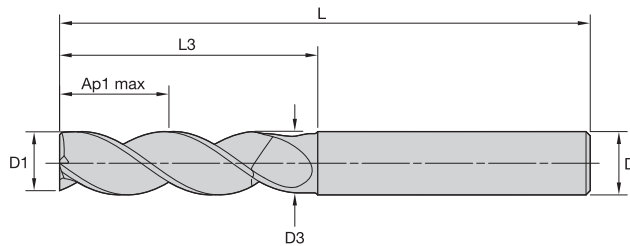
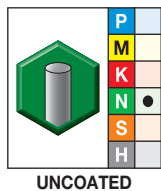

ALUFLASH • Series 3AP9 • Square End • 3 Flute • Long Length • Regular Neck • Cylindrical Shank • Metric



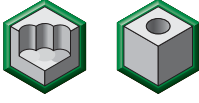

- first choice
- alternate choice

order #	catalogue #	D1	D	D3	length of cut Ap1 max	length L	L3	Z U
6853448	3AP9M12016SZT	12,0	12	11,28	36,00	100	48,00	3

ALUFLASH • Plunging • Application Data • Metric

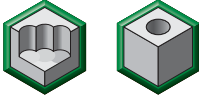
																					
		Plunging/Drilling			UNCOATED			Recommended feed per revolution (fn =mm/rev) for plunging 2-flute end mills													
					Cutting Speed – Vc m/min			D1 – Diameter													
Material Group	Max Depth	Applicable	Coolant	min	Start	max	mm	2,0	4,0	5,0	6,0	8,0	10,0	12,0	14,0	16,0	18,0	20,0	25,0		
N	1	1,5 x D	●	Required	120	260	400	fn	0,080	0,120	0,135	0,150	0,160	0,200	0,220	0,235	0,250	0,265	0,280	0,300	
	2	1,5 x D	●	Required	120	250	280	fn	0,080	0,120	0,135	0,150	0,160	0,200	0,220	0,235	0,250	0,265	0,280	0,300	
	3	1,5 x D	●	Required	100	200	260	fn	0,080	0,120	0,135	0,150	0,160	0,200	0,220	0,235	0,250	0,265	0,280	0,300	
	4	1 x D	●	Required	60	150	260	fn	0,060	0,080	0,100	0,120	0,140	0,160	0,200	0,210	0,220	0,235	0,250	0,280	
	5	1,5 x D	●	Required	60	200	400	fn	0,080	0,120	0,135	0,150	0,160	0,200	0,220	0,235	0,250	0,265	0,280	0,300	

																					
		Plunging/Drilling			UNCOATED			Recommended feed per revolution (fn =mm/rev) for plunging 3-flute end mills													
					Cutting Speed – Vc m/min			D1 – Diameter													
Material Group	Max Depth	Applicable	Coolant	min	Start	max	mm	2,0	4,0	5,0	6,0	8,0	10,0	12,0	14,0	16,0	18,0	20,0	25,0		
N	1	1,5 x D	●	Required	120	260	400	fn	0,056	0,084	0,095	0,105	0,112	0,140	0,154	0,165	0,175	0,186	0,196	0,210	
	2	1,5 x D	●	Required	120	250	280	fn	0,056	0,084	0,095	0,105	0,112	0,140	0,154	0,165	0,175	0,186	0,196	0,210	
	3	1,5 x D	●	Required	100	200	260	fn	0,056	0,084	0,095	0,105	0,112	0,140	0,154	0,165	0,175	0,186	0,196	0,210	
	4	1 x D	●	Required	60	150	260	fn	0,042	0,056	0,070	0,084	0,098	0,112	0,140	0,147	0,154	0,165	0,175	0,196	
	5	1,5 x D	●	Required	60	200	400	fn	0,056	0,084	0,095	0,105	0,112	0,140	0,154	0,165	0,175	0,186	0,196	0,210	

INDEXABLE MILLING

SOLID END MILLING

HOLEMAKING

TAPPING

TURNING

ALUFLASH • Ramping 2 Flute • Application Data • Metric

INDEXABLE MILLING

SOLID END MILLING

HOLEMAKING

TAPPING



TURNING



Material Group	Max Depth	Helical Interpolation / Ramping 0° - 15°																
		UNCOATED			Recommended feed per tooth (fz = mm/z) for helical interpolation and ramping													
		Cutting Speed – Vc m/min			Diameter – D1 [Ømin-Ømax]													
		min	Start	max	mm	3,0	4,0	5,0	6,0	8,0	10,0	12,0	14,0	16,0	18,0	20,0	25,0	
N	1	1,25 x D1	500	600	2000	fz	0,022	0,044	0,055	0,066	0,088	0,110	0,132	0,153	0,176	0,198	0,220	0,275
	2	1,25 x D1	500	600	1500	fz	0,020	0,040	0,048	0,059	0,079	0,099	0,119	0,138	0,158	0,178	0,198	0,247
	3	1,25 x D1	500	600	1500	fz	0,015	0,031	0,038	0,046	0,062	0,077	0,092	0,107	0,123	0,138	0,154	0,192
	4	1,25 x D1	400	450	750	fz	0,015	0,031	0,038	0,046	0,062	0,077	0,092	0,107	0,123	0,138	0,154	0,192
	5	1,25 x D1	250	400	1000	fz	0,020	0,040	0,050	0,059	0,079	0,099	0,119	0,138	0,158	0,178	0,198	0,247



Material Group	Max Depth	Helical Interpolation / Ramping 15° - 30°																
		UNCOATED			Recommended feed per tooth (fz = mm/z) for helical interpolation and ramping													
		Cutting Speed – Vc m/min			Diameter – D1 [Ømin-Ømax]													
		min	Start	max	mm	3,0	4,0	5,0	6,0	8,0	10,0	12,0	14,0	16,0	18,0	20,0	25,0	
N	1	1,25 x D1	500	600	1600	fz	0,017	0,033	0,041	0,050	0,066	0,082	0,099	0,115	0,132	0,148	0,165	0,206
	2	1,25 x D1	500	600	1200	fz	0,015	0,030	0,036	0,045	0,059	0,074	0,089	0,104	0,119	0,134	0,148	0,185
	3	1,25 x D1	500	600	1200	fz	0,012	0,023	0,029	0,035	0,046	0,058	0,069	0,080	0,092	0,104	0,115	0,144
	4	1,25 x D1	400	450	600	fz	0,012	0,023	0,029	0,035	0,046	0,058	0,069	0,080	0,092	0,104	0,115	0,144
	5	1,25 x D1	250	400	800	fz	0,015	0,030	0,038	0,045	0,059	0,074	0,089	0,104	0,119	0,134	0,148	0,185

Material Group	Max Depth	Helical Interpolation / Ramping 30° - 45°																
		UNCOATED			Recommended feed per tooth (fz = mm/z) for helical interpolation and ramping													
		Cutting Speed – Vc m/min			Diameter – D1 [Ømin-Ømax]													
		min	Start	max	mm	3,0	4,0	5,0	6,0	8,0	10,0	12,0	14,0	16,0	18,0	20,0	25,0	
N	1	1,25 x D1	420	500	800	fz	0,013	0,026	0,033	0,040	0,053	0,066	0,079	0,092	0,106	0,119	0,132	0,165
	2	1,25 x D1	420	500	800	fz	0,012	0,024	0,029	0,036	0,048	0,059	0,071	0,083	0,095	0,107	0,119	0,148
	3	1,25 x D1	420	500	800	fz	0,009	0,018	0,023	0,028	0,037	0,046	0,055	0,064	0,074	0,083	0,092	0,115
	4	1,25 x D1	340	380	450	fz	0,009	0,018	0,023	0,028	0,037	0,046	0,055	0,064	0,074	0,083	0,092	0,115
	5	1,25 x D1	210	340	600	fz	0,012	0,024	0,030	0,036	0,048	0,059	0,071	0,083	0,095	0,107	0,119	0,148

ALUFLASH • Ramping 3 Flute • Application Data • Metric

Material Group	Helical Interpolation / Ramping 0° - 15°																	
		UNCOATED			Recommended feed per tooth (fz = mm/z) for helical interpolation and ramping – fz x 1													
		Cutting Speed – Vc m/min			Diameter – D1 [Ømin-Ømax]													
		Max Depth	min	Start	max	mm	3,0	4,0	5,0	6,0	8,0	10,0	12,0	14,0	16,0	18,0	20,0	25,0
N	1	1,25 x D1	500	600	2000	fz	0,022	0,044	0,055	0,066	0,088	0,110	0,132	0,153	0,176	0,198	0,220	0,275
	2	1,25 x D1	500	600	1500	fz	0,020	0,040	0,048	0,059	0,079	0,099	0,119	0,138	0,158	0,178	0,198	0,247
	3	1,25 x D1	500	600	1500	fz	0,015	0,031	0,038	0,046	0,062	0,077	0,092	0,107	0,123	0,138	0,154	0,192
	4	1,25 x D1	400	450	750	fz	0,015	0,031	0,038	0,046	0,062	0,077	0,092	0,107	0,123	0,138	0,154	0,192
	5	1,25 x D1	250	400	1000	fz	0,020	0,040	0,050	0,059	0,079	0,099	0,119	0,138	0,158	0,178	0,198	0,247



Material Group	Helical Interpolation / Ramping 15° - 30°																	
		UNCOATED			Recommended feed per tooth (fz = mm/z) for helical interpolation and ramping – fz x 1													
		Cutting Speed – Vc m/min			Diameter – D1 [Ømin-Ømax]													
		Max Depth	min	Start	max	mm	3,0	4,0	5,0	6,0	8,0	10,0	12,0	14,0	16,0	18,0	20,0	25,0
N	1	1,25 x D1	500	600	1600	fz	0,017	0,033	0,041	0,050	0,066	0,082	0,099	0,115	0,132	0,148	0,165	0,206
	2	1,25 x D1	500	600	1200	fz	0,015	0,030	0,036	0,045	0,059	0,074	0,089	0,104	0,119	0,134	0,148	0,185
	3	1,25 x D1	500	600	1200	fz	0,012	0,023	0,029	0,035	0,046	0,058	0,069	0,080	0,092	0,104	0,115	0,144
	4	1,25 x D1	400	450	600	fz	0,012	0,023	0,029	0,035	0,046	0,058	0,069	0,080	0,092	0,104	0,115	0,144
	5	1,25 x D1	250	400	800	fz	0,015	0,030	0,038	0,045	0,059	0,074	0,089	0,104	0,119	0,134	0,148	0,185

Material Group	Helical Interpolation / Ramping 30° - 45°																	
		UNCOATED			Recommended feed per tooth (fz = mm/z) for helical interpolation and ramping – fz x 1													
		Cutting Speed – Vc m/min			Diameter – D1 [Ømin-Ømax]													
		Max Depth	min	Start	max	mm	3,0	4,0	5,0	6,0	8,0	10,0	12,0	14,0	16,0	18,0	20,0	25,0
N	1	1,25 x D1	420	500	800	fz	0,013	0,026	0,033	0,040	0,053	0,066	0,079	0,092	0,106	0,119	0,132	0,165
	2	1,25 x D1	420	500	800	fz	0,012	0,024	0,029	0,036	0,048	0,059	0,071	0,083	0,095	0,107	0,119	0,148
	3	1,25 x D1	420	500	800	fz	0,009	0,018	0,023	0,028	0,037	0,046	0,055	0,064	0,074	0,083	0,092	0,115
	4	1,25 x D1	340	380	450	fz	0,009	0,018	0,023	0,028	0,037	0,046	0,055	0,064	0,074	0,083	0,092	0,115
	5	1,25 x D1	210	340	600	fz	0,012	0,024	0,030	0,036	0,048	0,059	0,071	0,083	0,095	0,107	0,119	0,148

ALUFLASH • Side Milling and Slotting • Application Data • Metric

INDEXABLE MILLING

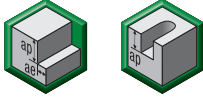

SOLID END MILLING

																					
		Side Milling (A) and Slotting (B)			UNCOATED			Recommended feed per tooth ($f_z = \text{mm/z}$) for side milling (A). For slotting (B), reduce f_z by 20%.													
		A		B	Cutting Speed – V_c m/min			D1 – Diameter													
Material Group	a_p	a_e	a_p	min	Start	max	mm	2,0	4,0	5,0	6,0	8,0	10,0	12,0	14,0	16,0	18,0	20,0	25,0		
N	1	Ap1 max	0,5 x D1	1 x D	500	600	2000	fz	0,022	0,044	0,055	0,066	0,088	0,110	0,132	0,153	0,176	0,198	0,220	0,275	
	2	Ap1 max	0,5 x D1	1 x D	500	600	1500	fz	0,020	0,040	0,048	0,059	0,079	0,099	0,119	0,138	0,158	0,178	0,198	0,247	
	3	Ap1 max	0,5 x D1	1 x D	500	600	1500	fz	0,015	0,031	0,038	0,046	0,062	0,077	0,092	0,107	0,123	0,138	0,154	0,192	
	4	Ap1 max	0,5 x D1	1 x D	400	450	750	fz	0,015	0,031	0,038	0,046	0,062	0,077	0,092	0,107	0,123	0,138	0,154	0,192	
	5	Ap1 max	0,5 x D1	1 x D	250	400	1000	fz	0,020	0,040	0,050	0,059	0,079	0,099	0,119	0,138	0,158	0,178	0,198	0,247	

HOLEMAKING

TAPPING

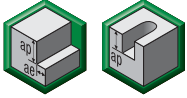
TURNING

																					
		Side Milling (A) and Slotting (B)			UNCOATED			Recommended feed per tooth ($f_z = \text{mm/z}$) for side milling (A). For slotting (B), reduce f_z by 20%.													
		A		B	Cutting Speed – V_c m/min			D1 – Diameter													
Material Group	a_p	a_e	a_p	min	Start	max	mm	2,0	4,0	5,0	6,0	8,0	10,0	12,0	14,0	16,0	18,0	20,0	25,0		
N	1	Ap1 max	0,5 x D1	1 x D	500	600	2000	fz	0,022	0,044	0,055	0,066	0,088	0,110	0,132	0,153	0,176	0,198	0,220	0,275	
	2	Ap1 max	0,5 x D1	1 x D	500	600	1500	fz	0,020	0,040	0,048	0,059	0,079	0,099	0,119	0,138	0,158	0,178	0,198	0,247	
	3	Ap1 max	0,5 x D1	1 x D	500	600	1500	fz	0,015	0,031	0,038	0,046	0,062	0,077	0,092	0,107	0,123	0,138	0,154	0,192	
	4	Ap1 max	0,5 x D1	1 x D	400	450	750	fz	0,015	0,031	0,038	0,046	0,062	0,077	0,092	0,107	0,123	0,138	0,154	0,192	
	5	Ap1 max	0,5 x D1	1 x D	250	400	1000	fz	0,020	0,040	0,050	0,059	0,079	0,099	0,119	0,138	0,158	0,178	0,198	0,247	



The X-Feed Solid End Mill is for machining companies looking for a reliable high-feed solution that can operate on all kind of steels with a hardness above 60 HRC or on heat-resistant alloys like titanium, INCONEL®, and stainless steels.

Features and Benefits

Low lead angle for high speed applications.

6 flute across the entire diameter range.

Long neck to reach the bottom of the deepest cavities.

Different Edge preparations to machine ISO P and H material or ISO S and M categories.



The X-Feed milling line will deliver high feed-rates in multiple applications, from hardened steels up to 60 HRC to the most demanding superalloys such as titanium or PH steels.

FAST

Constant 6-flute design to provide the high feed-rate on the entire diameter range.

LONG

With its 3 x D long neck, the X-Feed makes possible to machine deep cavities with ease.

VERSATILE

The X-Feed range includes different geometries to machine steels, hardened steels, plus stainless steel and superalloys.

HIGH SPEED

PRODUCT

SOLID CARBIDE END MILL

GRADE

AITIN

FLUTE

6

DIAMETER RANGE

METRIC

6-25mm

INDUSTRY



APPLICATIONS

MATERIALS

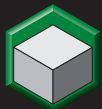

FACING



RAMPING



HELICAL INTERPOLATION



SLOTTING



3D PROFILING



PLUNGING

X-Feed • Series 70N6 71N6 • 37–52 HRC • High Feed • 6 Flute • Cylindrical Shank • Metric

INDEXABLE MILLING

SOLID END MILLING

HOLEMAKING

TAPPING

TURNING

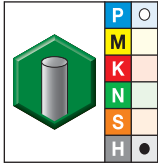
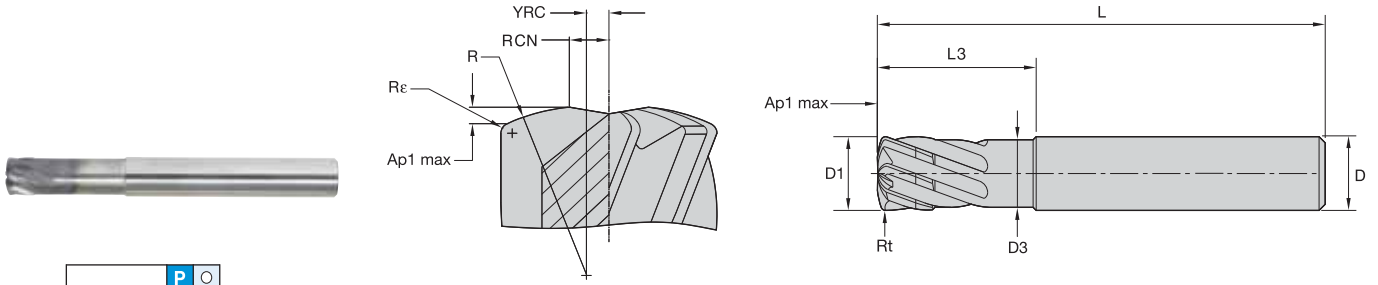

AITiN-MT1

- first choice
- alternate choice

order #	catalogue #	D1	D	D3	length of cut		length		R _ε	R _t	Z U
					Ap1 max	L3	L	L			
3745400	71N606002MT	6,0	6	5,50	0,32	9,00	57	0,38	0,62	6	
3341346	70N606002MT	6,0	6	5,50	0,32	18,00	63	0,38	0,62	6	
3745401	71N608003MT	8,0	8	7,50	0,42	12,00	63	0,50	0,83	6	
3341348	70N608003MT	8,0	8	7,50	0,42	24,00	76	0,50	0,83	6	
3745402	71N610004MT	10,0	10	9,00	0,53	15,00	72	0,63	1,04	6	
3101466	70N610004MT	10,0	10	9,00	0,53	30,00	89	0,63	1,04	6	
3745413	71N612005MT	12,0	12	11,00	0,63	18,00	83	0,75	1,24	6	
3101467	70N612005MT	12,0	12	11,00	0,63	36,00	100	0,75	1,24	6	
3484748	70N616006MT	16,0	16	15,00	0,84	48,00	110	1,00	1,66	6	
3484749	70N620007MT	20,0	20	19,00	1,05	60,00	125	1,25	2,07	6	

NOTE: YRC = distance from center line to the crown of the R radius.
 RCN = distance from center line to the start of the cutting edge. This dimension can also help determine the minimum circle size when helical ramping.
 R = the head radius size.
 R_ε = the shoulder radius or radius at the corner of the cutter.

X-Feed • Series 70NS • Stainless Steel/High-Temp • High Feed • 6 Flute • Cylindrical Shank • Metric

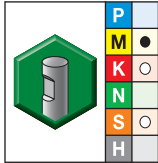
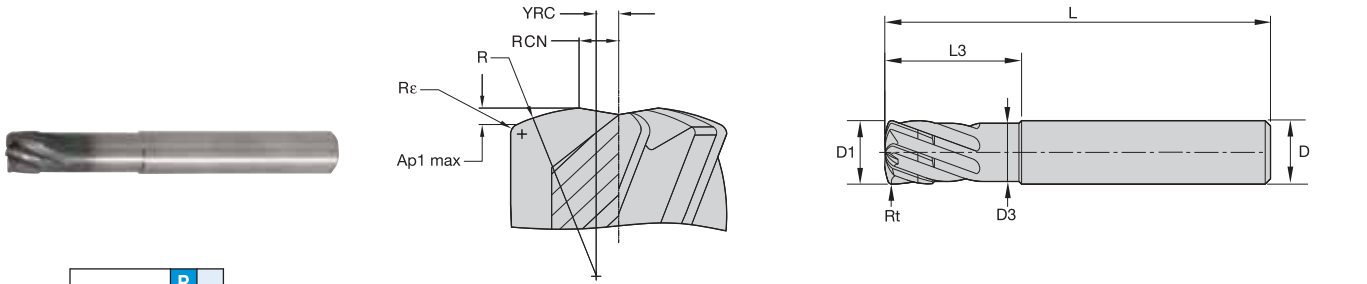

AITiN-MT

- first choice
- alternate choice

order #	catalogue #	D1	D	D3	length of cut Ap1 max	L3	length L	Re	Z	U
6441882	70NS06002	6,0	6	5,50	0,32	17,75	63	0,38	6	6
6441883	70NS08003	8,0	8	7,50	0,42	23,75	76	0,50	6	6
6441884	70NS10004	10,0	10	9,00	0,53	29,50	89	0,63	6	6
6441885	70NS12005	12,0	12	11,00	0,63	35,50	100	0,75	6	6
6441886	70NS16006	16,0	16	15,00	0,84	47,50	110	1,00	6	6
6441887	70NS20007	20,0	20	19,00	1,05	59,50	125	1,25	6	6
6441888	70NS25008	25,0	25	23,50	1,31	74,25	150	1,56	6	6

NOTE: YRC = distance from center line to the crown of the R radius.
 RCN = distance from center line to the start of the cutting edge. This dimension can also help determine the minimum circle size when helical ramping.
 R = the head radius size.
 Rt = the shoulder radius or radius at the corner of the cutter.

X-Feed • Series 70N7 • >52 HRC • High Feed • 6 Flute • Cylindrical Shank • Metric

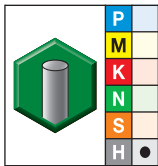
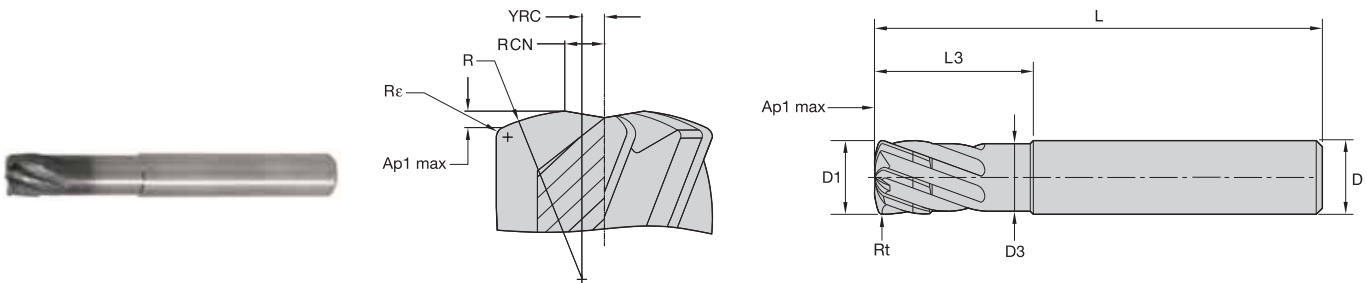



AITiN-MT1

- first choice
- alternate choice

order #	catalogue #	D1	D	D3	length of cut Ap1 max	L3	length L	Re	Rt	Z	U
3484756	70N706002MT	6,0	6	5,50	0,20	18,00	63	0,38	0,58	6	6
3484757	70N708003MT	8,0	8	7,50	0,27	24,00	76	0,50	0,77	6	6
3484758	70N710004MT	10,0	10	9,00	0,33	30,00	89	0,63	0,96	6	6
3403492	70N712005MT	12,0	12	11,00	0,40	36,00	100	0,75	1,15	6	6
3477329	70N716006MT	16,0	16	15,00	0,54	48,00	110	1,00	1,54	6	6
3484759	70N720007MT	20,0	20	19,00	0,67	60,00	125	1,25	1,92	6	6

NOTE: YRC = distance from center line to the crown of the R radius.
 RCN = distance from center line to the start of the cutting edge. This dimension can also help determine the minimum circle size when helical ramping.
 R = the head radius size.
 Re = the shoulder radius or radius at the corner of the cutter.



X-Feed • Lists 70N6 71N6 • Application Data • AlTiN-MT1 • Metric

													
		Profile Milling		AlTiN			Recommended feed per tooth (fz = mm/th) for 3D milling/profiling (A)						
Material Group	A	A		Cutting Speed – vc m/min			mm	D1 – Diameter					
		ap	ae	min		max		6,0	8,0	10,0	12,0	16,0	20,0
P	4	0,05 x D	0,55 x D	160	–	180	fz	0,300	0,500	0,500	0,500	0,600	0,700
H	1	0,05 x D	0,55 x D	140	–	160	fz	0,300	0,500	0,500	0,500	0,600	0,700
	2	0,05 x D	0,55 x D	100	–	120	fz	0,200	0,300	0,300	0,400	0,500	0,600

Tool List 70N6																
Geometrical Parameters										Ramping Guide for Circular and Linear Interpolation						
										Circular Interpolation		Linear Interpolation				
Tool										Allowed Range of Hole Diameter		Calculated Length (mm) per Ramp Angle				
												Ramp Angle (degree)				
diameter	ap max	Rfm	Rt	Rc	Xfm	Yfm	YD	Number	flutes	Smallest	Largest	1	2	3	4	5
[mm]	[mm]	[mm]	[mm]	[mm]	[mm]	[mm]	[mm]	[mm]								
70N606003MT	6	0,32	6	0,62	0,375	0,32	0,75	1,32	6	8,64	12	18,12	9,06	6,03	4,52	3,61
70N608003MT	8	0,42	8	0,83	0,500	0,42	1,00	1,76	6	11,52	16	24,16	12,08	8,05	6,03	4,82
70N610004MT	10	0,53	10	1,04	0,625	0,53	1,25	2,20	6	14,4	20	30,20	15,09	10,06	7,54	6,02
70N612005MT	12	0,63	12	1,24	0,750	0,63	1,50	2,64	6	17,28	24	36,24	18,11	12,07	9,05	7,23
70N616006MT	16	0,84	16	1,66	1,000	0,84	2,00	3,52	6	23,04	32	48,31	24,15	16,09	12,06	9,64
70N620007MT	20	1,05	20	2,07	1,250	1,05	2,50	4,40	6	28,8	40	60,39	30,19	20,11	15,08	12,05
												100%	70%	50%	30%	10%

NOTE: Above parameters are based on ideal conditions. For smaller taper machining centers, please adjust parameters on diameters >12mm.

X-Feed • Series 70NS • Application Data • AlTiN-MT • Metric

Material Group														
	Profile Milling		AlTiN-MT			Recommended feed per tooth (fz = mm/th) for 3D milling/profiling (A)								
	A		Cutting Speed – Vc m/min			D1 – Diameter								
	ap	ae	min	max	mm	6,0	8,0	10,0	12,0	16,0	20,0	25,0		
M	1	0,05 x D	0,55 x D	90	–	115	fz	0,300	0,400	0,500	0,540	0,720	0,900	1,125
	2	0,05 x D	0,55 x D	60	–	80	fz	0,240	0,320	0,400	0,480	0,640	0,800	1,000
	3	0,05 x D	0,55 x D	60	–	70	fz	0,240	0,320	0,400	0,480	0,640	0,800	1,000
S	1	0,05 x D	0,55 x D	50	–	90	fz	0,270	0,360	0,450	0,500	0,650	0,800	1,000
	2	0,05 x D	0,55 x D	25	–	40	fz	0,240	0,320	0,400	0,480	0,600	0,700	0,900
	3	0,05 x D	0,55 x D	25	–	40	fz	0,180	0,240	0,300	0,350	0,430	0,500	0,600
4	0,05 x D	0,55 x D	50	–	60	fz	0,210	0,280	0,350	0,420	0,560	0,700	0,875	

70NS Metric																
Geometrical Parameters									Ramping Guide for Circular and Linear Interpolation							
									Circular Interpolation		Linear Interpolation					
diameter									Allowed Range of Hole Diameter		Calculated Length (mm) per Ramp Angle					
											Ramp Angle (degree)					
Ap1 max	Rfm	Rt	Rc	Xfm	Yfm	YD	Number	flutes	Smallest	Largest	1	2	3	4	5	
[mm]	[mm]	[mm]	[mm]	[mm]	[mm]	[mm]	[mm]	[mm]	[mm]	[mm]	[mm]	[mm]	[mm]	[mm]	[mm]	[mm]
6	0,32	6	0,67	0,375	0,338	0,75	1,26	6	8,52	12	18,12	9,06	6,03	4,52	3,61	
8	0,42	8	0,89	0,500	0,450	1,00	1,68	6	11,36	16	24,16	12,08	8,05	6,03	4,82	
10	0,53	10	1,12	0,625	0,562	1,25	2,10	6	14,2	20	30,20	15,09	10,06	7,54	6,02	
12	0,63	12	1,34	0,750	0,674	1,50	2,52	6	17,04	24	36,24	18,11	12,07	9,05	7,23	
16	0,84	16	1,79	1,000	0,915	2,00	3,36	6	22,72	32	48,31	24,15	16,09	12,06	9,64	
20	1,05	20	2,23	1,250	1,124	2,50	4,20	6	28,4	40	60,39	30,19	20,11	15,08	12,05	
25	1,25	25	2,90	1,5625	1,405	3,1250	5,25	6	35,5	50	70,61	35,80	23,85	17,88	14,29	
Recommended Feed											30%	30%	30%	30%	10%	

NOTE: Lower value of cutting speed is used for high stock removal applications or for higher hardness (machinability) within group.
Higher value of cutting speed is used for finishing applications or for lower hardness (machinability) within group.
Above parameters are based on ideal conditions. For smaller taper machining centers, please adjust parameters accordingly on diameters greater than 12mm.

X-Feed • Series 70N7 • Application Data • AlTiN-MT1 • Metric

Material Group													
	Profile Milling		AlTiN			Recommended feed per tooth (fz = mm/th) for 3D milling/profiling (A)							
	A		Cutting Speed – vc m/min			D1 – Diameter							
	ap	ae	min	max	mm	6,0	8,0	10,0	12,0	16,0	20,0		
H	2	0,03 x D	0,55 x D	100	–	120	fz	0,200	0,300	0,300	0,400	0,500	0,600
	3	0,03 x D	0,55 x D	80	–	100	fz	0,200	0,300	0,300	0,400	0,500	0,600
	4	0,03 x D	0,55 x D	50	–	70	fz	0,150	0,200	0,250	0,300	0,400	0,500

Tool List 70N7															
Geometrical Parameters									Ramping Guide for Circular and Linear Interpolation						
									Circular Interpolation		Linear Interpolation				
diameter									Allowed Range of Hole Diameter		Calculated Length (mm) per Ramp Angle				
											Ramp Angle (degree)				
Ap1 max	Rfm	Rt	Rc	Xfm	Yfm	YD	Number	flutes	Smallest	Largest	1	2	3	4	5
[mm]	[mm]	[mm]	[mm]	[mm]	[mm]	[mm]	[mm]	[mm]	[mm]	[mm]	[mm]	[mm]	[mm]	[mm]	[mm]
6	0,20	9	0,58	0,375	0,20	0,75	1,26	6	8,52	12	11,51	5,75	3,83	2,87	2,30
8	0,27	12	0,77	0,500	0,27	1,00	1,68	6	11,36	16	15,34	7,67	5,11	3,83	3,06
10	0,33	15	0,96	0,625	0,33	1,25	2,10	6	14,2	20	19,18	9,58	6,39	4,79	3,83
12	0,40	18	1,15	0,750	0,40	1,50	2,52	6	17,04	24	23,01	11,50	7,66	5,74	4,59
16	0,54	24	1,54	1,000	0,54	2,00	3,36	6	22,72	32	30,68	15,34	10,22	7,66	6,12
20	0,67	30	1,92	1,250	0,67	2,50	4,20	6	28,4	40	38,35	19,17	12,77	9,57	7,65
Recommended Feed											100%	70%	50%	30%	10%

NOTE: Above parameters are based on ideal conditions. For smaller taper machining centers, please adjust parameters accordingly on diameters >12mm.

Vision Plus end mills are focused on delivering productivity in primarily the die and mold industry, in roughing or finishing operations for hardened steel up to 67 HRC.

Features and Benefits

Negative rakes to make the cutting edge robust.

High helix angles to reduce chip thickness and guarantee wall straightness in finishing operations.

Specific substrate engineered to perform on high hardness steels.



The Vision Plus series offers a variety of tools to machine the most complex components including various end face geometries.

ROBUST

Dedicated design to attack all types of hardened steels up to 67 HRC.

SPECIFIC

Specifically engineered design to compete in the die and mold industry, in all applications on hardened steels and high alloyed steels.

PRODUCTIVE

Vision Plus end mills include geometries and edge preparations designed to increase feed-rates and achieve higher metal removal rates.

HARD MACHINING MADE EASY

PRODUCT

SOLID CARBIDE END MILL

GRADE

WU10PE
AT1N

FLUTE

2-6

DIAMETER RANGE

METRIC

0,3-25mm

INDUSTRY



APPLICATIONS

MATERIALS

P

H

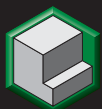

SIDE MILLING



3D PROFILING



HELICAL
INTERPOLATION



RAMPING

Vision Plus • Series 7505 7515 7525 7545 • Sharp Edge • Cylindrical Shank • Metric

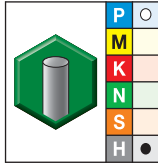
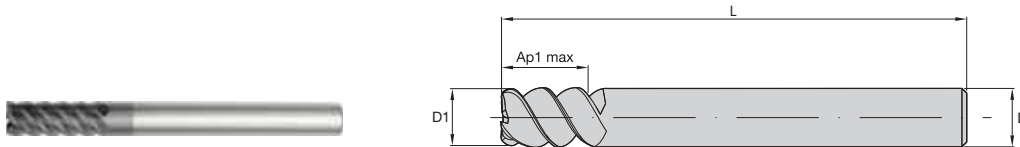

TiAlN-LT1

- first choice
- alternate choice

order #	catalogue #	D1	D	length of cut Ap1 max	length L	ZU
2499570	754503002LT	3,0	6	4,50	50	4
2499567	750503002LT	3,0	6	4,50	57	4
2499571	754504002LT	4,0	6	6,00	50	4
2499568	750504002LT	4,0	6	6,00	57	4
2499572	754505002LT	5,0	6	7,50	50	4
2499569	750505002LT	5,0	6	7,50	76	4
1848805	754506002LT	6,0	6	9,00	50	4
1724462	750506002LT	6,0	6	9,00	76	4
1724468	751506002LT	6,0	6	15,00	76	4
1724487	752506002LT	6,0	6	21,00	76	4
1860603	754508003LT	8,0	8	12,00	63	4
1724463	750508003LT	8,0	8	12,00	100	4
1724469	751508003LT	8,0	8	20,00	100	4
1724489	752508003LT	8,0	8	28,00	100	4
1860604	754510004LT	10,0	10	15,00	76	4
1724464	750510004LT	10,0	10	15,00	100	4
1724481	751510004LT	10,0	10	25,00	100	5
1724490	752510004LT	10,0	10	35,00	100	5
1860605	754512005LT	12,0	12	18,00	76	4
1724465	750512005LT	12,0	12	18,00	125	4
1724482	751512005LT	12,0	12	30,00	125	6
1724531	752512005LT	12,0	12	42,00	125	6
1860606	754516006LT	16,0	16	24,00	89	4
1724483	751516006LT	16,0	16	40,00	125	6
1724533	752516006LT	16,0	16	56,00	125	6
1724484	751520007LT	20,0	20	50,00	150	6
1724536	752520007LT	20,0	20	70,00	150	6
1747878	751525008LT	25,0	25	63,00	150	6
1747931	752525008LT	25,0	25	88,00	150	6

INDEXABLE MILLING

SOLID END MILLING

HOLEMAKING

TAPPING

TURNING

Vision Plus • Series 7585 7595 • Radius • Cylindrical Shank • Metric

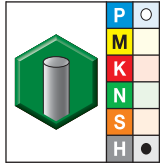
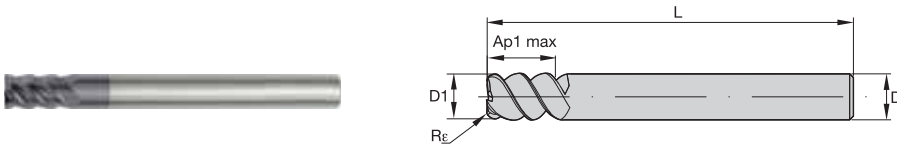

TiAlN-LT1

● first choice
○ alternate choice

order #	catalogue #	D1	D	length of cut Ap1 max	length L	Re	ZU
2540317	759503002LT	3,0	6	4,50	50	0,25	4
2540318	759503012LT	3,0	6	4,50	50	0,50	4
2540319	759504002LT	4,0	6	6,00	50	0,25	4
2540320	759504012LT	4,0	6	6,00	50	0,50	4
2540321	759505002LT	5,0	6	7,50	50	0,25	4
2540322	759505012LT	5,0	6	7,50	50	0,50	4
1862105	759506002LT	6,0	6	9,00	50	0,25	4
1862106	759506012LT	6,0	6	9,00	50	0,50	4
2541273	759506022LT	6,0	6	9,00	50	0,75	4
2541274	759506032LT	6,0	6	9,00	50	1,00	4
1860609	758506002LT	6,0	6	9,00	76	0,25	4
1860610	758506012LT	6,0	6	9,00	76	0,50	4
1862107	759508003LT	8,0	8	12,00	63	0,50	4
2541275	759508023LT	8,0	8	12,00	63	0,75	4
1862108	759508013LT	8,0	8	12,00	63	1,00	4
2541276	759508033LT	8,0	8	12,00	63	1,50	4
1860611	758508003LT	8,0	8	12,00	100	0,50	4
1860612	758508013LT	8,0	8	12,00	100	1,00	4
1862109	759510004LT	10,0	10	15,00	76	0,50	4
1862110	759510014LT	10,0	10	15,00	76	1,00	4
2541277	759510024LT	10,0	10	15,00	76	1,50	4
2541278	759510034LT	10,0	10	15,00	76	2,00	4
1860623	758510004LT	10,0	10	15,00	100	0,50	4
1860624	758510014LT	10,0	10	15,00	100	1,00	4
1862111	759512005LT	12,0	12	18,00	76	0,50	4
2541279	759512025LT	12,0	12	18,00	76	1,00	4
2541280	759512035LT	12,0	12	18,00	76	2,00	4
1860625	758512005LT	12,0	12	18,00	125	0,50	4
1862113	759516006LT	16,0	16	24,00	89	0,50	4
1860628	758516016LT	16,0	16	24,00	125	1,50	4
2541293	759520027LT	20,0	20	30,00	104	1,00	4

INDEXABLE MILLING

SOLID END MILLING

HOLEMAKING

TAPPING

Vision Plus • Series 75N2 • Radius • Cylindrical Shank • Metric

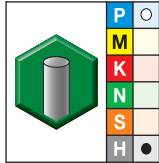
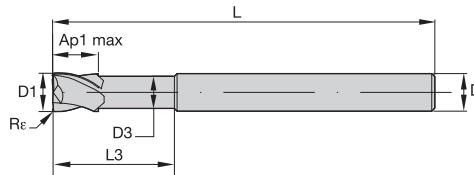

WU10PE

● first choice
○ alternate choice

order #	catalogue #	D1	D	D3	length of cut		length L	Re	ZU
					Ap1 max	L3			
2544530	75N203022RT	3,0	6	2,80	3,00	9,00	75	0,30	2
2544737	75N204022RT	4,0	6	3,70	4,00	12,00	75	0,30	2
2545166	75N206062RT	6,0	6	5,50	6,00	18,00	75	1,00	2

Vision Plus • Series 75N5 • Neck • Cylindrical Shank • Metric

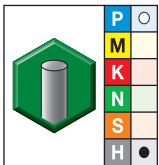
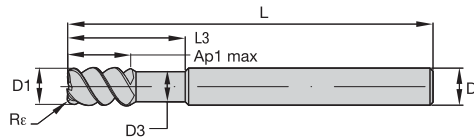

TiAIN-LT1

● first choice
○ alternate choice

order #	catalogue #	D1	D	D3	length of cut		length L	Re	ZU
					Ap1 max	L3			
2544367	75N503022LT	3,0	6	2,7	4,50	9,00	57	0,25	4
2544368	75N503042LT	3,0	6	2,7	4,50	9,00	57	0,50	4
2544369	75N504022LT	4,0	6	3,7	6,00	12,00	57	0,25	4
2544370	75N504042LT	4,0	6	3,7	6,00	12,00	57	0,50	4
2544371	75N505022LT	5,0	6	4,6	7,50	15,00	76	0,25	4
2544372	75N505042LT	5,0	6	4,6	7,50	15,00	76	0,50	4
1862119	75N506002LT	6,0	6	5,4	9,00	18,00	76	—	4
2544443	75N506022LT	6,0	6	5,4	9,00	18,00	76	0,25	4
2544444	75N506042LT	6,0	6	5,4	9,00	18,00	76	0,50	4
2544446	75N506082LT	6,0	6	5,4	9,00	18,00	76	1,00	4
1862120	75N508003LT	8,0	8	7,4	12,00	24,00	100	—	4
2544447	75N508023LT	8,0	8	7,4	12,00	24,00	100	0,50	4
2544448	75N508033LT	8,0	8	7,4	12,00	24,00	100	1,00	4
2544449	75N508043LT	8,0	8	7,4	12,00	24,00	100	1,50	4
2544450	75N508053LT	8,0	8	7,4	12,00	24,00	100	2,00	4
1862121	75N510004LT	10,0	10	9,4	15,00	30,00	100	—	4
2544452	75N510024LT	10,0	10	9,2	15,00	30,00	100	0,50	4
2544483	75N510034LT	10,0	10	9,2	15,00	30,00	100	1,00	4
2544484	75N510044LT	10,0	10	9,2	15,00	30,00	100	1,50	4
2544485	75N510054LT	10,0	10	9,2	15,00	30,00	100	2,00	4
1862122	75N512005LT	12,0	12	11,4	18,00	36,00	125	—	4
2544486	75N512025LT	12,0	12	11,0	18,00	36,00	125	0,50	4
2544487	75N512035LT	12,0	12	11,0	18,00	36,00	125	1,00	4
2544489	75N512055LT	12,0	12	11,0	18,00	36,00	125	2,00	4
1862123	75N516006LT	16,0	16	15,4	24,00	48,00	125	—	4
2544490	75N516026LT	16,0	16	15,0	24,00	48,00	125	0,50	4
1862124	75N520007LT	20,0	20	19,4	30,00	60,00	150	—	4
2544523	75N520047LT	20,0	20	19,0	30,00	60,00	150	2,00	4

Vision Plus • Series 7670 • Radius • Cylindrical Shank • Metric

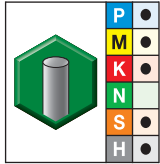
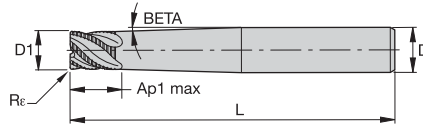

TiAlN-LT1

- first choice
- alternate choice

order #	catalogue #	D1	D	D3	length of cut Ap1 max	length L	Rε	ZU
1724621	767016006LT	16,0	16	15,00	16,00	125	1,00	6

Vision Plus • Series D518 • Sharp Edge • Weldon® • Metric

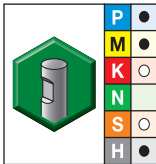
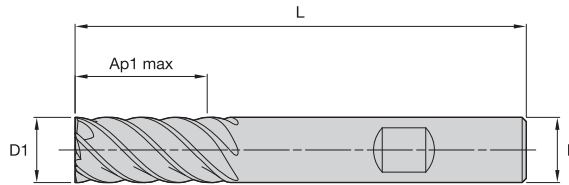

WP15PE

- first choice
- alternate choice

order #	catalogue #	D1	D	length of cut Ap1 max	length L	ZU
5559116	D51804002W	4,0	6	11,00	57	4
5559117	D51805002W	5,0	6	13,00	57	4
5559118	D51806002W	6,0	6	13,00	57	6
5559120	D51808003W	8,0	8	19,00	63	6
5559122	D51810004W	10,0	10	22,00	72	6
5559123	D51812005W	12,0	12	26,00	83	6
5559124	D51814014W	14,0	14	26,00	83	6
5559125	D51816006W	16,0	16	32,00	92	8
5559127	D51820007W	20,0	20	38,00	104	8
5559128	D51825008W	25,0	25	45,00	121	8

INDEXABLE MILLING

SOLID END MILLING

HOLEMAKING

TAPPING

TURNING

Vision Plus • Series D618 • Sharp Edge • Cylindrical Shank • Metric

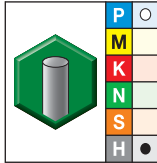
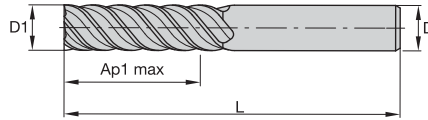

WU10PE

- first choice
- alternate choice

order #	catalogue #	D1	D	length of cut Ap1 max	length L	ZU
2256338	D61803002RJ	3,0	4	8,00	50	4
2257304	D61804002RJ	4,0	6	12,00	57	4
2256340	D61805002RJ	5,0	6	13,00	57	4
2256341	D61806002RJ	6,0	6	15,00	60	6
2256353	D61808003RJ	8,0	8	20,00	75	6
2256354	D61810004RJ	10,0	10	25,00	80	6
2256355	D61812005RJ	12,0	12	30,00	100	6
2256356	D61816006RJ	16,0	16	40,00	110	6
2256357	D61820007RJ	20,0	20	45,00	120	6

Vision Plus • Series 7050 7060 • Ball Nose • Cylindrical Shank • Metric

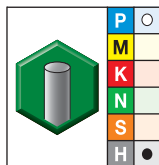
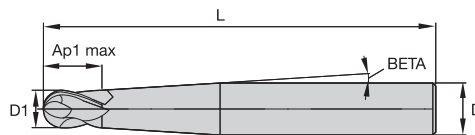

WU10PE

- first choice
- alternate choice

order #	catalogue #	D1	D	length of cut Ap1 max	length L	BETA	ZU
1724321	705002001RT	2,0	4	2,00	63	2.5	4
1724323	705003002RT	3,0	6	3,00	75	2.5	4
1724324	705004002RT	4,0	6	4,00	75	2.5	4
2495916	706004002RT	4,0	6	4,00	75	1.5	4
1724325	705005002RT	5,0	6	5,00	75	2.5	4
1724326	705006004RT	6,0	10	6,00	100	2.5	4
2495918	706006004RT	6,0	10	6,00	100	1.5	4
1724327	705008004RT	8,0	10	8,00	100	2.5	4
1724328	705010005RT	10,0	12	10,00	125	2.5	4
1724330	705016006RT	16,0	16	16,00	125	—	4

Vision Plus • Series 7061 • Ball Nose • Cylindrical Shank • Metric

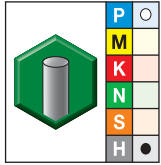
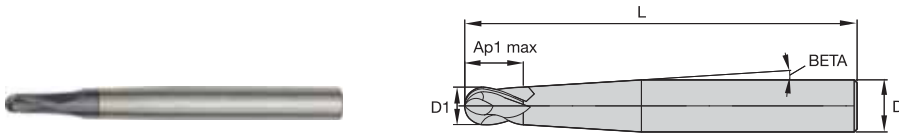

WU10PE

- first choice
- alternate choice

order #	catalogue #	D1	D	length of cut Ap1 max	length L	BETA	ZU
2495994	706101001RT	1,0	4	1,00	63	3.5	2
2495995	706102001RT	2,0	4	2,00	63	3.5	2
2495997	706103002RT	3,0	6	3,00	75	1.5	2
2495998	706104002RT	4,0	6	4,00	75	1.5	2
2496000	706106004RT	6,0	10	6,00	100	1.5	2
2496001	706108004RT	8,0	10	8,00	100	1.5	2

Vision Plus • Series 7150 • Ball Nose • Cylindrical Shank • Metric

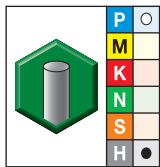
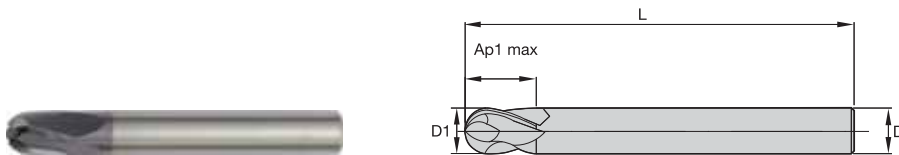

WU10PE

- first choice
- alternate choice

order #	catalogue #	D1	D	length of cut Ap1 max	length L	ZU
1859882	715003000RT	3,0	3	3,00	38	4
1859904	715004001RT	4,0	4	4,00	50	4
1859906	715005001RT	5,0	5	5,00	50	4
1859907	715006002RT	6,0	6	6,00	50	4
1859908	715008003RT	8,0	8	8,00	63	4
1859909	715010004RT	10,0	10	10,00	76	4
1859910	715012005RT	12,0	12	12,00	76	4

Vision Plus • Series 7151 • Ball Nose • Cylindrical Shank • Metric

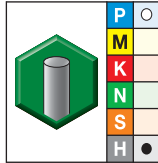
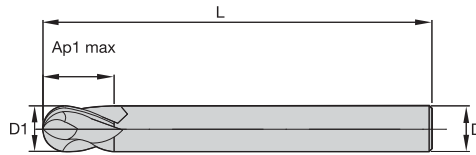

WU10PE

- first choice
- alternate choice

order #	catalogue #	D1	D	length of cut Ap1 max	length L	ZU
1860036	715101000RT	1,0	3	3,00	38	2
1860090	715102000RT	2,0	3	3,00	38	2
1860106	715103000RT	3,0	3	3,00	38	2
1860109	715104001RT	4,0	4	4,00	50	2
1860111	715105001RT	5,0	5	5,00	50	2
1860112	715106002RT	6,0	6	6,00	50	2
1860133	715108003RT	8,0	8	8,00	63	2
1860134	715110004RT	10,0	10	10,00	76	2
1860135	715112005RT	12,0	12	12,00	76	2

Vision Plus • Series 70N1 • Ball Nose • Neck • Cylindrical Shank • Metric

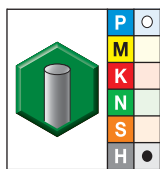
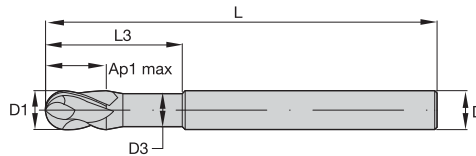

WU10PE

- first choice
- alternate choice

order #	catalogue #	D1	D	D3	length of cut Ap1 max	length L	ZU
2545190	70N101001RT	1,0	4	0,80	1,00	63	2
2545191	70N101501RT	1,5	4	1,30	1,50	63	2
2545192	70N102002RT	2,0	6	1,80	2,00	76	2
2545213	70N103002RT	3,0	6	2,80	3,00	76	2
2545214	70N104002RT	4,0	6	3,70	4,00	76	2
2545215	70N105002RT	5,0	6	4,60	5,00	76	2
2545216	70N106002RT	6,0	6	5,50	6,00	76	2
2545217	70N108003RT	8,0	8	7,50	8,00	100	2
2545218	70N110004RT	10,0	10	9,50	10,00	100	2
2545219	70N112005RT	12,0	12	11,50	12,00	125	2

Vision Plus Micro • Series 7N02 7N12 7N22 • Sharp Edge • Cylindrical Shank • Metric

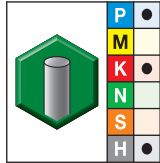
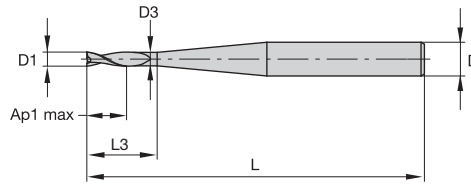

● first choice
○ alternate choice

WU10PE

order #	catalogue #	D1	D	D3	length of cut Ap1 max	L3	length L	ZU
2256390	7N0200302RJ	0,3	6	0,24	0,40	0,40	50	2
2256438	7N2200400RJ	0,4	3	0,34	0,60	2,00	38	2
2256439	7N2200410RJ	0,4	3	0,34	0,60	4,00	38	2
2256391	7N0200402RJ	0,4	6	0,34	0,60	0,60	50	2
2256440	7N2200500RJ	0,5	3	0,44	0,70	2,00	38	2
2256441	7N2200510RJ	0,5	3	0,44	0,70	4,00	38	2
2256442	7N2200520RJ	0,5	3	0,44	0,70	6,00	38	2
2256392	7N0200502RJ	0,5	6	0,44	0,70	1,50	50	2
2256443	7N2200600RJ	0,6	3	0,54	0,90	2,00	38	2
2256444	7N2200610RJ	0,6	3	0,54	0,90	4,00	38	2
2256445	7N2200620RJ	0,6	3	0,54	0,90	6,00	38	2
2256393	7N0200602RJ	0,6	6	0,54	0,90	1,80	50	2
2256447	7N2200711RJ	0,7	4	0,64	1,00	4,00	50	2
2256448	7N2200721RJ	0,7	4	0,64	1,00	6,00	50	2
2256449	7N2200801RJ	0,8	4	0,74	1,20	4,00	50	2
2256450	7N2200811RJ	0,8	4	0,74	1,20	6,00	50	2
2256451	7N2200821RJ	0,8	4	0,74	1,20	8,00	50	2
2256394	7N0200802RJ	0,8	6	0,74	1,20	2,40	50	2
2256455	7N2201001RJ	1,0	4	0,94	1,50	6,00	50	2
2256456	7N2201011RJ	1,0	4	0,94	1,50	8,00	50	2
2256457	7N2201021RJ	1,0	4	0,94	1,50	10,00	50	2
2256458	7N2201031RJ	1,0	4	0,94	1,50	12,00	50	2
2256395	7N0201002RJ	1,0	6	0,94	1,50	2,50	50	2
2256406	7N1201002RJ	1,0	6	0,94	1,50	5,00	60	2
2256459	7N2201201RJ	1,2	4	1,14	1,50	6,00	50	2
2256460	7N2201211RJ	1,2	4	1,14	1,80	8,00	50	2
2256462	7N2201231RJ	1,2	4	1,14	1,80	12,00	50	2
2256396	7N0201202RJ	1,2	6	1,14	1,80	3,00	50	2
2256407	7N1201202RJ	1,2	6	1,14	1,80	6,00	60	2
2256463	7N2201401RJ	1,4	4	1,34	2,10	6,00	50	2
2256464	7N2201411RJ	1,4	4	1,34	2,10	8,00	50	2
2256465	7N2201421RJ	1,4	4	1,35	2,10	10,00	50	2
2256467	7N2201441RJ	1,4	4	1,34	2,10	16,00	50	2
2256397	7N0201402RJ	1,4	6	1,34	2,10	3,50	50	2
2256468	7N2201501RJ	1,5	4	1,44	2,30	6,00	50	2
2256469	7N2201511RJ	1,5	4	1,44	2,30	10,00	50	2
2256470	7N2201521RJ	1,5	4	1,44	2,30	12,00	50	2
2256471	7N2201531RJ	1,5	4	1,44	2,30	16,00	50	2
2256472	7N2201541RJ	1,5	4	1,44	2,30	18,00	63	2
2256473	7N2201551RJ	1,5	4	1,44	2,30	20,00	63	2
2256398	7N0201502RJ	1,5	6	1,44	2,30	3,80	50	2
2256409	7N1201502RJ	1,5	6	1,44	2,30	7,50	60	2
3454428	7N2201571RJ	1,6	4	1,54	2,80	11,70	50	2
2256479	7N2201701RJ	1,7	4	1,64	2,60	6,00	50	2
2256481	7N2201721RJ	1,7	4	1,64	2,60	12,00	50	2
2256484	7N2201801RJ	1,8	4	1,74	2,70	6,00	50	2
2256485	7N2201811RJ	1,8	4	1,74	2,70	10,00	50	2
2256486	7N2201821RJ	1,8	4	1,74	2,70	12,00	50	2
2256487	7N2201831RJ	1,8	4	1,74	2,70	16,00	50	2
2256400	7N0201802RJ	1,8	6	1,74	2,70	4,50	50	2
2256489	7N2201901RJ	1,9	4	1,84	2,80	6,00	50	2
2256494	7N2202001RJ	2,0	4	1,96	3,00	6,00	50	2

Vision Plus Micro • Series 7N02 7N12 7N22 • Sharp Edge • Cylindrical Shank • Metric

(continued)

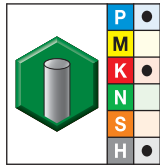
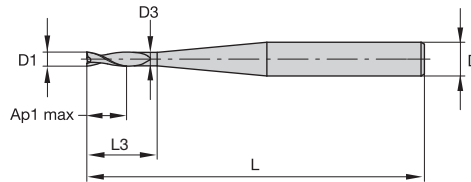

- first choice
- alternate choice

WU10PE

order #	catalogue #	D1	D	D3	length of cut Ap1 max	L3	length L	ZU
2256495	7N2202011RJ	2,0	4	1,96	3,00	10,00	50	2
2256496	7N2202021RJ	2,0	4	1,96	3,00	16,00	50	2
2256497	7N2202031RJ	2,0	4	1,96	3,00	20,00	63	2
2256498	7N2202041RJ	2,0	4	1,96	3,00	20,00	75	2
2256401	7N0202002RJ	2,0	6	1,94	3,00	5,00	50	2
2256412	7N1202002RJ	2,0	6	1,96	3,00	10,00	60	2
3454429	7N2202051RJ	2,1	4	2,00	3,00	8,00	50	2
2256499	7N2202501RJ	2,5	4	2,40	3,70	8,00	50	2
2256500	7N2202511RJ	2,5	4	2,40	3,70	10,00	50	2
2256501	7N2202521RJ	2,5	4	2,44	3,70	16,00	63	2
2256502	7N2202531RJ	2,5	4	2,44	3,70	20,00	63	2
2256503	7N2202541RJ	2,5	4	2,44	3,70	30,00	80	2
2256402	7N0202502RJ	2,5	6	2,44	3,70	5,00	50	2
2256504	7N2203002RJ	3,0	6	2,94	4,50	8,00	50	2
2256505	7N2203012RJ	3,0	6	2,94	4,50	10,00	50	2
2256506	7N2203022RJ	3,0	6	2,94	4,50	16,00	63	2
2256507	7N2203032RJ	3,0	6	2,94	4,50	20,00	63	2
2256508	7N2203042RJ	3,0	6	2,94	4,50	20,00	80	2
3454434	7N2203062RJ	3,1	6	3,00	4,50	25,00	76	2

INDEXABLE MILLING

SOLID END MILLING

HOLEMAKING

TAPPING

TURNING

Vision Plus Micro • Series 7N01 • Ball Nose • Cylindrical Shank • Metric

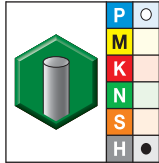
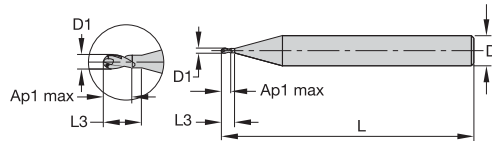

● first choice
○ alternate choice

WU10PE

order #	catalogue #	D1	D	length of cut Ap1 max	length L	ZU
2256358	7N0100302RJ	0,3	6	0,30	50	2
2256359	7N0100402RJ	0,4	6	0,40	50	2
2256360	7N0100502RJ	0,5	6	0,50	50	2
2256361	7N0100602RJ	0,6	6	0,60	50	2
2256362	7N0100802RJ	0,8	6	0,80	50	2
2256363	7N0101002RJ	1,0	6	2,50	50	2
2256364	7N0101202RJ	1,2	6	1,20	50	2
2256366	7N0101502RJ	1,5	6	1,50	50	2
2256369	7N0102002RJ	2,0	6	2,00	50	2
2256370	7N0102502RJ	2,5	6	2,50	50	2
2256371	7N0103002RJ	3,0	6	3,00	50	2
2256372	7N0104002RJ	4,0	6	4,00	50	2
2256373	7N0106002RJ	6,0	6	6,00	50	2

Vision Plus Micro • Series 7N21 • Ball Nose • Cylindrical Shank • Metric

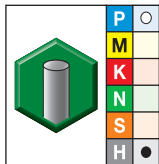
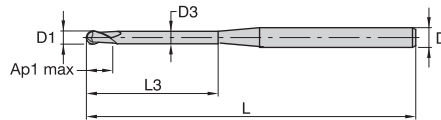

● first choice
○ alternate choice

WU10PE

order #	catalogue #	D1	D	D3	length of cut Ap1 max	L3	length L	ZU
3665122	7N2100501RT	0,5	4	0,44	1,00	5,00	63	2
3665141	7N2100801RT	0,8	4	0,74	1,30	8,00	63	2
3665142	7N2101001RT	1,0	4	0,94	1,60	10,00	63	2
3665164	7N2101501RT	1,5	4	1,44	2,40	16,00	63	2
3665166	7N2102001RT	2,0	4	1,94	3,20	20,00	63	2
3665168	7N2103001RT	3,0	4	2,90	4,50	30,00	63	2

Vision Plus • Series 7505 7545 7515 7525 • Application Data • TiAlN-LT1 • Metric

Material Group	Side Milling (A) and Slotting (B)		TiAlN			Recommended feed per tooth (fz = mm/th) for side milling (A). For slotting (B), reduce fz by 20%.														
	A		B		Cutting Speed – vc m/min			mm	D1 – Diameter											
	ap	ae	ap	min	max															
	ap	ae	ap	min	max	4,0	5,0	6,0	8,0	10,0	12,0	14,0	16,0	18,0	20,0	25,0				
P	3	1 x D	0,4 x D	1 x D	120	–	160	fz	0,026	0,033	0,040	0,055	0,067	0,077	0,087	0,096	0,104	0,111	0,125	
	4	1 x D	0,4 x D	0,75 x D	90	–	150	fz	0,024	0,030	0,036	0,049	0,059	0,069	0,077	0,084	0,091	0,097	0,107	
H	1	1 x D	0,4 x D	0,75 x D	80	–	140	fz	0,024	0,030	0,036	0,049	0,059	0,069	0,077	0,084	0,091	0,097	0,107	
	2	1 x D	0,3 x D	0,5 x D	70	–	120	fz	0,018	0,022	0,027	0,037	0,044	0,051	0,057	0,063	0,067	0,071	0,078	
	3	1 x D	0,15 x D	0,3 x D	60	–	90	fz	0,014	0,018	0,021	0,029	0,035	0,041	0,046	0,051	0,055	0,059	0,067	
	4	1 x D	0,1 x D	0,15 x D	50	–	70	fz	0,009	0,012	0,014	0,019	0,023	0,027	0,031	0,034	0,037	0,039	0,044	

NOTE: Lower value of cutting speed is used for high stock removal applications or for higher hardness (machinability) within group.
Higher value of cutting speed is used for finishing applications or for lower hardness (machinability) within group.
For better surface finish, reduce feed per tooth.

Vision Plus • Series 7515 • Application Data • TiAlN-LT1 • Metric

Material Group	Side Milling (A) and Slotting (B)		TiAlN			Recommended feed per tooth (fz = mm/th) for side milling (A). For slotting (B), reduce fz by 20%.														
	A		B		Cutting Speed – vc m/min			mm	D1 – Diameter											
	ap	ae	ap	min	max															
	ap	ae	ap	min	max	3,0	4,0	5,0	6,0	8,0	10,0	12,0	16,0	20,0	25,0					
P	3	2 x D	0,3 x D	0,75 x D	160	–	180	fz	0,019	0,026	0,033	0,040	0,055	0,067	0,077	0,096	0,111	0,125		
	4	2 x D	0,25 x D	0,5 x D	140	–	160	fz	0,017	0,024	0,030	0,036	0,049	0,059	0,069	0,084	0,097	0,107		
H	1	2 x D	0,25 x D	0,5 x D	120	–	140	fz	0,017	0,024	0,030	0,036	0,049	0,059	0,069	0,084	0,097	0,107		
	2	2 x D	0,2 x D	0,4 x D	80	–	130	fz	0,013	0,018	0,022	0,027	0,037	0,044	0,051	0,063	0,071	0,078		
	3	2 x D	0,1 x D	0,2 x D	70	–	100	fz	0,010	0,014	0,018	0,021	0,029	0,035	0,041	0,051	0,059	0,067		
	4	2 x D	0,05 x D	0,05 x D	50	–	70	fz	0,007	0,009	0,012	0,014	0,019	0,023	0,027	0,034	0,039	0,044		

NOTE: Lower value of cutting speed is used for high stock removal applications or for higher hardness (machinability) within group.
Higher value of cutting speed is used for finishing applications or for lower hardness (machinability) within group.
For better surface finish, reduce feed per tooth.

Vision Plus • Series 7525 • Application Data • TiAlN-LT1 • Metric

Material Group	Side Milling (A) and Slotting (B)		TiAlN			Recommended feed per tooth (fz = mm/th) for side milling (A). For slotting (B), reduce fz by 20%.														
	A		B		Cutting Speed – vc m/min			mm	D1 – Diameter											
	ap	ae	ap	min	max															
	ap	ae	ap	min	max	3,0	4,0	5,0	6,0	8,0	10,0	12,0	16,0	20,0	25,0					
P	3	3 x D	0,2 x D	0,5 x D	160	–	180	fz	0,019	0,026	0,033	0,040	0,055	0,067	0,077	0,096	0,111	0,125		
	4	3 x D	0,2 x D	0,3 x D	140	–	160	fz	0,017	0,024	0,030	0,036	0,049	0,059	0,069	0,084	0,097	0,107		
H	1	3 x D	0,2 x D	0,3 x D	120	–	140	fz	0,017	0,024	0,030	0,036	0,049	0,059	0,069	0,084	0,097	0,107		
	2	3 x D	0,15 x D	0,2 x D	80	–	130	fz	0,013	0,018	0,022	0,027	0,037	0,044	0,051	0,063	0,071	0,078		
	3	3 x D	0,05 x D	–	70	–	100	fz	0,010	0,014	0,018	0,021	0,029	0,035	0,041	0,051	0,059	0,067		
	4	3 x D	0,03 x D	–	50	–	70	fz	0,007	0,009	0,012	0,014	0,019	0,023	0,027	0,034	0,039	0,044		

NOTE: Lower value of cutting speed is used for high stock removal applications or for higher hardness (machinability) within group.
Higher value of cutting speed is used for finishing applications or for lower hardness (machinability) within group.
For better surface finish, reduce feed per tooth.

Vision Plus • Series 7585 7595 • Application Data • TiAlN-LT1 • Metric

Material Group	Side Milling (A) and Slotting (B)		TiAlN			Recommended feed per tooth (fz = mm/th) for side milling (A). For slotting (B), reduce fz by 20%.																
	A		B		Cutting Speed – vc m/min			mm	D1 – Diameter													
	ap	ae	ap	min	max	4,0	5,0		6,0	8,0	10,0	12,0	14,0	16,0	18,0	20,0	25,0					
	1 x D	0,4 x D	1 x D			fz																
P	3	1 x D	0,4 x D	1 x D	120	–	160	fz	0,019	0,033	0,040	0,055	0,067	0,077	0,077	0,096	0,096	0,111	0,125			
	4	1 x D	0,4 x D	0,75 x D	90	–	150	fz	0,017	0,030	0,036	0,049	0,059	0,069	0,069	0,084	0,084	0,097	0,107			
H	1	1 x D	0,4 x D	0,75 x D	80	–	140	fz	0,017	0,030	0,036	0,049	0,059	0,069	0,069	0,084	0,084	0,097	0,107			
	2	1 x D	0,3 x D	0,5 x D	70	–	120	fz	0,013	0,022	0,027	0,037	0,044	0,051	0,051	0,063	0,063	0,071	0,078			
	3	1 x D	0,15 x D	0,3 x D	60	–	90	fz	0,010	0,018	0,021	0,029	0,035	0,041	0,041	0,051	0,051	0,059	0,067			
	4	1 x D	0,1 x D	0,15 x D	50	–	70	fz	0,007	0,012	0,014	0,019	0,023	0,027	0,027	0,034	0,034	0,039	0,044			

NOTE: Lower value of cutting speed is used for high stock removal applications or for higher hardness (machinability) within group.
Higher value of cutting speed is used for finishing applications or for lower hardness (machinability) within group.
For better surface finish, reduce feed per tooth.

Vision Plus • Series 75N2 • Application Data • WU10PE • Metric

Material Group	Side Milling (A) and Slotting (B)		WU10PE			Recommended feed per tooth (fz = mm/th) for side milling (A). For slotting (B), reduce fz by 20%.									
	A		B		Cutting Speed – vc m/min			mm	D1 – Diameter						
	ap	ae	ap	min	max	3,0	4,0		5,0	6,0	8,0	10,0	12,0		
	0,75 x D	0,1 x D	0,4 x D			fz									
P	3	0,75 x D	0,1 x D	0,4 x D	160	–	180	fz	0,017	0,023	0,030	0,036	0,050	0,061	0,070
	4	0,75 x D	0,1 x D	0,4 x D	140	–	160	fz	0,016	0,021	0,027	0,033	0,045	0,054	0,062
H	1	0,75 x D	0,1 x D	0,4 x D	120	–	140	fz	0,016	0,021	0,027	0,033	0,045	0,054	0,062
	2	0,75 x D	0,05 x D	0,3 x D	100	–	130	fz	0,016	0,020	0,025	0,029	0,034	0,037	0,040
	3	0,75 x D	0,03 x D	0,2 x D	70	–	100	fz	0,013	0,016	0,019	0,023	0,026	0,029	0,032
	4	0,75 x D	0,01 x D	0,1 x D	50	–	70	fz	0,008	0,011	0,013	0,015	0,018	0,019	0,021



NOTE: Lower value of cutting speed is used for high stock removal applications or for higher hardness (machinability) within group.
Higher value of cutting speed is used for finishing applications or for lower hardness (machinability) within group.

Vision Plus • Series 75N2 • Application Data • TiAlN-LT1 • Metric

Material Group	Side Milling (A) and Slotting (B)		TiAlN			Recommended feed per tooth (IPT = inch/th) for side milling (A). For slotting (B), reduce IPT by 20%.																
	A		B		Cutting Speed – vc SFM			mm	D1 – Diameter													
	ap	ae	ap	min	max	3.0	4.0		5.0	6.0	8.0	10.0	12.0	14.0	16.0	18.0	20.0	25.0				
	0.75 x D	0.1 x D	0.4 x D			IPT																
P	3	0.75 x D	0.1 x D	0.4 x D	390	–	520	IPT	.0007	.0009	.0012	.0014	.0020	.0024	.0028	.0031	.0034	.0037	.0040	.0045		
	4	0.75 x D	0.1 x D	0.4 x D	300	–	490	IPT	.0006	.0008	.0011	.0013	.0018	.0021	.0025	.0028	.0030	.0033	.0035	.0038		
H	1	0.75 x D	0.1 x D	0.4 x D	260	–	460	IPT	.0006	.0008	.0011	.0013	.0018	.0021	.0025	.0028	.0030	.0033	.0035	.0038		
	2	0.75 x D	0.05 x D	0.3 x D	230	–	390	IPT	.0005	.0006	.0008	.0010	.0013	.0016	.0018	.0021	.0022	.0024	.0026	.0028		
	3	0.75 x D	0.03 x D	0.2 x D	200	–	300	IPT	.0004	.0005	.0006	.0008	.0010	.0013	.0015	.0017	.0018	.0020	.0021	.0024		
	4	0.75 x D	0.01 x D	0.1 x D	160	–	230	IPT	.0002	.0003	.0004	.0005	.0007	.0008	.0010	.0011	.0012	.0013	.0014	.0016		



NOTE: Lower value of cutting speed is used for high stock removal applications or for higher hardness (machinability) within group.
Higher value of cutting speed is used for finishing applications or for lower hardness (machinability) within group.

Vision Plus • Series 75N5 Finishing • Application Data • WU10PE • Metric

																					
		Side Milling (A) and Slotting (B)			TiAlN			Recommended feed per tooth (fz = mm/th) for side milling (A). For slotting (B), reduce fz by 20%.													
Material Group		A		B	Cutting Speed – vc m/min			D1 – Diameter													
		ap	ae	ap	min	max	mm	4,0	5,0	6,0	8,0	10,0	12,0	14,0	16,0	18,0	20,0	25,0			
P	3	1 x D	0,4 x D	1 x D	120	–	160	fz	0,026	0,033	0,040	0,055	0,067	0,077	0,087	0,096	0,104	0,111	0,125		
	4	1 x D	0,4 x D	0,75 x D	90	–	150	fz	0,024	0,030	0,036	0,049	0,059	0,069	0,077	0,084	0,091	0,097	0,107		
H	1	1 x D	0,4 x D	0,75 x D	80	–	140	fz	0,024	0,030	0,036	0,049	0,059	0,069	0,077	0,084	0,091	0,097	0,107		
	2	1 x D	0,3 x D	0,5 x D	70	–	120	fz	0,018	0,022	0,027	0,037	0,044	0,051	0,057	0,063	0,067	0,071	0,078		
	3	1 x D	0,15 x D	0,3 x D	60	–	90	fz	0,014	0,018	0,021	0,029	0,035	0,041	0,046	0,051	0,055	0,059	0,067		
	4	1 x D	0,1 x D	0,15 x D	50	–	70	fz	0,009	0,012	0,014	0,019	0,023	0,027	0,031	0,034	0,037	0,039	0,044		

NOTE: Lower value of cutting speed is used for high stock removal applications or for higher hardness (machinability) within group.
Higher value of cutting speed is used for finishing applications or for lower hardness (machinability) within group.
For better surface finish, reduce feed per tooth.

Vision Plus • Series 7670 • Application Data • TiAlN-LT1 • Metric

																					
		Side Milling (A) and Slotting (B)			TiAlN			Recommended feed per tooth (fz = mm/th) for side milling (A). For slotting (B), reduce fz by 10%.													
Material Group		A		B	Cutting Speed – vc m/min			D1 – Diameter													
		ap	ae	ap	min	max	mm	4,0	5,0	6,0	8,0	10,0	12,0	16,0	20,0	25,0					
P	3	0,8 x D	0,5 x D	0,75 x D	160	–	180	fz	0,020	0,025	0,031	0,043	0,051	0,063	0,078	0,101	0,114				
	4	0,8 x D	0,4 x D	0,5 x D	140	–	160	fz	0,018	0,023	0,028	0,038	0,046	0,056	0,069	0,088	0,098				
	5	0,8 x D	0,5 x D	0,75 x D	60	–	100	fz	0,016	0,021	0,025	0,034	0,041	0,051	0,063	0,081	0,091				
	6	0,8 x D	0,4 x D	0,5 x D	50	–	80	fz	0,014	0,017	0,021	0,029	0,034	0,042	0,051	0,065	0,071				
M	1	0,8 x D	0,5 x D	0,75 x D	80	–	100	fz	0,020	0,025	0,031	0,043	0,051	0,063	0,078	0,101	0,114				
	2	0,8 x D	0,4 x D	0,75 x D	60	–	80	fz	0,016	0,021	0,025	0,034	0,041	0,051	0,063	0,081	0,091				
	3	0,8 x D	0,4 x D	0,75 x D	60	–	80	fz	0,014	0,017	0,021	0,029	0,034	0,042	0,051	0,065	0,071				
K	1	0,8 x D	0,5 x D	0,75 x D	120	–	160	fz	0,024	0,031	0,037	0,051	0,061	0,075	0,091	0,114	0,124				
	2	0,8 x D	0,5 x D	0,75 x D	110	–	140	fz	0,020	0,025	0,031	0,043	0,051	0,063	0,078	0,101	0,114				
	3	0,8 x D	0,4 x D	0,75 x D	100	–	130	fz	0,016	0,021	0,025	0,034	0,041	0,051	0,063	0,081	0,091				
S	1	0,8 x D	0,4 x D	0,75 x D	50	–	90	fz	0,023	0,030	0,036	0,050	0,061	0,070	0,087	0,101	0,114				
	2	0,8 x D	0,25 x D	0,3 x D	25	–	40	fz	0,013	0,016	0,019	0,026	0,032	0,037	0,046	0,054	0,061				
	3	0,8 x D	0,4 x D	0,75 x D	25	–	40	fz	0,013	0,016	0,019	0,026	0,032	0,037	0,046	0,054	0,061				
	4	0,8 x D	0,3 x D	0,5 x D	50	–	60	fz	0,016	0,021	0,026	0,037	0,045	0,052	0,064	0,074	0,084				
H	1	0,8 x D	0,5 x D	0,5 x D	120	–	140	fz	0,018	0,023	0,028	0,038	0,046	0,056	0,069	0,088	0,098				
	2	0,8 x D	0,2 x D	0,3 x D	80	–	130	fz	0,014	0,017	0,021	0,029	0,034	0,042	0,051	0,065	0,071				
	3	0,8 x D	0,15 x D	0,2 x D	70	–	100	fz	0,011	0,014	0,017	0,023	0,027	0,034	0,041	0,052	0,057				

NOTE: Lower value of cutting speed is used for high stock removal applications or for higher hardness (machinability) within group.
Higher value of cutting speed is used for finishing applications or for lower hardness (machinability) within group.
For rougher tool with 6 flutes, use ap in slotting 60% of table value.
Above parameters are based on ideal conditions. For smaller taper machining centers, please adjust parameters on diameters >12mm.

Vision Plus • Series D518 • Application Data • WP15PE • Metric

Material Group	Side Milling (A)		WP15PE			Recommended feed per tooth (fz = mm/th) for side milling (A).												
	A		Cutting Speed – vc m/min			mm	D1 – Diameter											
	ap	ae	min	–	max		4,0	5,0	6,0	8,0	10,0	12,0	14,0	16,0	18,0	20,0	25,0	
						fz												
P	0	Ap1 max	0,05 x D	150	–	200	fz	0,028	0,036	0,044	0,060	0,072	0,083	0,092	0,101	0,108	0,114	0,124
	1	Ap1 max	0,05 x D	150	–	200	fz	0,028	0,036	0,044	0,060	0,072	0,083	0,092	0,101	0,108	0,114	0,124
	2	Ap1 max	0,05 x D	140	–	190	fz	0,028	0,036	0,044	0,060	0,072	0,083	0,092	0,101	0,108	0,114	0,124
	3	Ap1 max	0,05 x D	120	–	160	fz	0,023	0,030	0,036	0,050	0,061	0,070	0,079	0,087	0,095	0,101	0,114
	4	Ap1 max	0,05 x D	90	–	150	fz	0,021	0,027	0,033	0,045	0,054	0,062	0,070	0,077	0,083	0,088	0,098
	5	Ap1 max	0,05 x D	60	–	100	fz	0,019	0,024	0,029	0,040	0,048	0,056	0,063	0,070	0,076	0,081	0,091
M	6	Ap1 max	0,04 x D	50	–	75	fz	0,016	0,020	0,025	0,034	0,040	0,047	0,052	0,057	0,061	0,065	0,071
	1	Ap1 max	0,05 x D	90	–	115	fz	0,023	0,030	0,036	0,050	0,061	0,070	0,079	0,087	0,095	0,101	0,114
	2	Ap1 max	0,05 x D	60	–	80	fz	0,019	0,024	0,029	0,040	0,048	0,056	0,063	0,070	0,076	0,081	0,091
K	3	Ap1 max	0,05 x D	60	–	70	fz	0,016	0,020	0,025	0,034	0,040	0,047	0,052	0,057	0,061	0,065	0,071
	1	Ap1 max	0,05 x D	120	–	150	fz	0,028	0,036	0,044	0,060	0,072	0,083	0,092	0,101	0,108	0,114	0,124
	2	Ap1 max	0,05 x D	110	–	140	fz	0,023	0,030	0,036	0,050	0,061	0,070	0,079	0,087	0,095	0,101	0,114
S	3	Ap1 max	0,05 x D	110	–	130	fz	0,019	0,024	0,029	0,040	0,048	0,056	0,063	0,070	0,076	0,081	0,091
	1	Ap1 max	0,04 x D	50	–	90	fz	0,023	0,030	0,036	0,050	0,061	0,070	0,079	0,087	0,095	0,101	0,114
	2	Ap1 max	0,04 x D	25	–	40	fz	0,013	0,016	0,019	0,026	0,032	0,037	0,042	0,046	0,050	0,054	0,061
	3	Ap1 max	0,05 x D	25	–	40	fz	0,013	0,016	0,019	0,026	0,032	0,037	0,042	0,046	0,050	0,054	0,061
H	4	Ap1 max	0,05 x D	50	–	60	fz	0,016	0,021	0,026	0,037	0,045	0,052	0,058	0,064	0,069	0,074	0,084
	1	Ap1 max	0,04 x D	80	–	140	fz	0,021	0,027	0,033	0,045	0,054	0,062	0,070	0,077	0,083	0,088	0,098
	2	Ap1 max	0,05 x D	70	–	120	fz	0,016	0,020	0,025	0,034	0,040	0,047	0,052	0,057	0,061	0,065	0,071

NOTE: Lower value of cutting speed is used for high stock removal applications or for higher hardness (machinability) within group.
Higher value of cutting speed is used for finishing applications or for lower hardness (machinability) within group.
For better surface finish, reduce feed per tooth.

Vision Plus • Series D618 • Application Data • WU10PE • Metric

Material Group	Side Milling (A)		WU10PE			Recommended feed per tooth (fz = mm/th) for side milling (A).										
	A		Cutting Speed – vc m/min			mm	D1 – Diameter									
	ap	ae	min	–	max		3,0	4,0	5,0	6,0	8,0	10,0	12,0	16,0	20,0	
						fz										
P	3	2 x D	0,15 x D	120	–	160	fz	0,019	0,026	0,033	0,040	0,055	0,067	0,077	0,096	0,111
	4	2 x D	0,15 x D	90	–	150	fz	0,017	0,024	0,030	0,036	0,049	0,059	0,069	0,084	0,097
H	1	2 x D	0,15 x D	80	–	140	fz	0,017	0,024	0,030	0,036	0,049	0,059	0,069	0,084	0,097
	2	2 x D	0,15 x D	70	–	120	fz	0,013	0,018	0,022	0,027	0,037	0,044	0,051	0,063	0,071
	3	2 x D	0,1 x D	60	–	90	fz	0,010	0,014	0,018	0,021	0,029	0,035	0,041	0,051	0,059
	4	2 x D	0,05 x D	50	–	70	fz	0,007	0,009	0,012	0,014	0,019	0,023	0,027	0,034	0,039

NOTE: Lower value of cutting speed is used for high stock removal applications or for higher hardness (machinability) within group.
Higher value of cutting speed is used for finishing applications or for lower hardness (machinability) within group.
For better surface finish, reduce feed per tooth.
Above parameters are based on ideal conditions. For smaller taper machining centers, please adjust parameters accordingly on diameters >12mm.

Vision Plus • Series 7050 7060 Roughing • Application Data • WU10PE • Metric

Material Group	A		WU10PE		Recommended feed per tooth (Fz=mm/th) for 3D milling/profiling (A) - roughing											
	ap	ae	Cutting Speed – vc m/min		mm	D1 - Diameter										
			Min	Max		2,0	3,0	4,0	6,0	8,0	10,0	12,0	16,0	20,0		
	3	4	3	4	3	4	3	4	3	4	3	4	3	4	3	4
P	0,2 x D	0,1 x D	208	–	234	Fz	0,015	0,023	0,031	0,049	0,067	0,081	0,094	0,117	0,136	
	0,2 x D	0,1 x D	182	–	208	Fz	0,014	0,021	0,029	0,044	0,060	0,073	0,084	0,103	0,118	
H	0,15 x D	0,1 x D	140	–	196	Fz	0,021	0,032	0,043	0,066	0,090	0,109	0,125	0,154	0,177	
	0,1 x D	0,075 x D	119	–	204	Fz	0,024	0,036	0,048	0,074	0,101	0,121	0,140	0,171	0,194	
	0,05 x D	0,05 x D	138	–	207	Fz	0,027	0,041	0,055	0,084	0,114	0,138	0,161	0,200	0,233	
	0,05 x D	0,05 x D	115	–	161	Fz	0,018	0,027	0,037	0,056	0,076	0,092	0,107	0,133	0,154	

NOTE: Please use the reference table to optimize your cutting speed based on the average cutting angle of the application. See page B192.

Vision Plus • Series 7050 7060 Semi-Finishing • Application Data • WU10PE • Metric

Material Group	A		WU10PE		Recommended feed per th (fz) chamfering											
	ap	ae	Cutting Speed – vc m/min		mm	D1 – Diameter										
			min	max		1,0	2,0	2,5	3,0	4,0	5,0	6,0	8,0	10,0	12,0	
	3	4	3	4	3	4	3	4	3	4	3	4	3	4	3	4
P	0,1 x D	0,1 x D	240	–	320	fz	0,017	0,034	0,043	0,052	0,070	0,089	0,109	0,150	0,182	0,211
	0,1 x D	0,1 x D	180	–	300	fz	0,016	0,031	0,040	0,048	0,064	0,081	0,099	0,134	0,162	0,187
H	0,1 x D	0,1 x D	160	–	280	fz	0,016	0,031	0,040	0,048	0,064	0,081	0,099	0,134	0,162	0,187
	0,1 x D	0,1 x D	140	–	240	fz	0,012	0,024	0,030	0,036	0,048	0,061	0,074	0,101	0,121	0,140
	0,1 x D	0,1 x D	120	–	180	fz	0,009	0,019	0,024	0,028	0,038	0,048	0,058	0,079	0,096	0,112
	0,1 x D	0,1 x D	100	–	140	fz	0,006	0,012	0,016	0,019	0,025	0,032	0,039	0,053	0,064	0,074

NOTE: Please use the reference table to optimize your cutting speed based on the average cutting angle of the application. See page B192.

Vision Plus • Series 7050 7060 Finishing • Application Data • WU10PE • Metric

Material Group	A		WU10PE		Recommended feed per tooth (Fz=mm/th) for 3D milling/profiling (A) - finishing											
	ap	ae	Cutting Speed – vc m/min		mm	D1 - Diameter										
			Min	Max		2,0	3,0	4,0	6,0	8,0	10,0	12,0	16,0	20,0		
	3	4	3	4	3	4	3	4	3	4	3	4	3	4	3	4
P	0,04 x D	0,04 x D	416	–	468	Fz	0,052	0,080	0,108	0,168	0,231	0,279	0,324	0,403	0,466	
	0,04 x D	0,04 x D	364	–	416	Fz	0,048	0,073	0,099	0,152	0,207	0,249	0,288	0,355	0,406	
H	0,03 x D	0,03 x D	290	–	406	Fz	0,052	0,078	0,106	0,162	0,221	0,266	0,308	0,379	0,434	
	0,03 x D	0,03 x D	203	–	348	Fz	0,039	0,059	0,080	0,122	0,166	0,199	0,230	0,281	0,320	
	0,02 x D	0,02 x D	216	–	324	Fz	0,033	0,050	0,067	0,102	0,139	0,168	0,196	0,244	0,284	
	0,02 x D	0,02 x D	180	–	252	Fz	0,022	0,033	0,045	0,068	0,093	0,112	0,130	0,162	0,187	

NOTE: Please use the reference table to optimize your cutting speed based on the average cutting angle of the application. See page B192.

Vision Plus • Series 7061 Roughing • Application Data • WU10PE • Metric

Material Group	A		Recommended feed per tooth (Fz=mm/th) for 3D milling/profiling (A) - roughing													
	A		WU10PE Cutting Speed – vc m/min		mm	D1 - Diameter										
	ap	ae	Min	Max		2,0	3,0	4,0	6,0	8,0	10,0	12,0	16,0	20,0		
P	3	0,2D	0,1D	208	–	234	Fz	0,015	0,023	0,031	0,049	0,067	0,081	0,094	0,117	0,136
	4	0,2D	0,1D	182	–	208	Fz	0,014	0,021	0,029	0,044	0,060	0,073	0,084	0,103	0,118
H	1	0,15D	0,1D	140	–	196	Fz	0,021	0,032	0,043	0,066	0,090	0,109	0,125	0,154	0,177
	2	0,1D	0,075D	119	–	204	Fz	0,024	0,036	0,048	0,074	0,101	0,121	0,140	0,171	0,194
	3	0,05D	0,05D	138	–	207	Fz	0,027	0,041	0,055	0,084	0,114	0,138	0,161	0,200	0,233
	4	0,05D	0,05D	115	–	161	Fz	0,018	0,027	0,037	0,056	0,076	0,092	0,107	0,133	0,154

NOTE: Please use the reference table to optimize your cutting speed based on the average cutting angle of the application. See page B192.

Vision Plus • Series 7061 Semi-Finishing • Application Data • WU10PE • Metric

Material Group	A		WU10PE Cutting Speed – vc m/min		mm	Recommended feed per th (fz) chamfering											
	ap	ae	min	max		D1 – Diameter											
	ap	ae	min	max	1,0	2,0	2,5	3,0	4,0	5,0	6,0	8,0	10,0	12,0			
P	3	0,1 x D	0,05 x D	240	–	320	fz	0,017	0,034	0,043	0,052	0,070	0,089	0,109	0,150	0,182	0,211
	4	0,1 x D	0,1 x D	180	–	300	fz	0,016	0,031	0,040	0,048	0,064	0,081	0,099	0,134	0,162	0,187
H	1	0,1 x D	0,1 x D	160	–	280	fz	0,016	0,031	0,040	0,048	0,064	0,081	0,099	0,134	0,162	0,187
	2	0,1 x D	0,1 x D	140	–	240	fz	0,012	0,024	0,030	0,036	0,048	0,061	0,074	0,101	0,121	0,140
	3	0,1 x D	0,1 x D	120	–	180	fz	0,009	0,019	0,024	0,028	0,038	0,048	0,058	0,079	0,096	0,112
	4	0,1 x D	0,1 x D	100	–	140	fz	0,006	0,012	0,016	0,019	0,025	0,032	0,039	0,053	0,064	0,074

NOTE: Please use the reference table to optimize your cutting speed based on the average cutting angle of the application. See page B192.

Vision Plus • Series 7061 Finishing • Application Data • WU10PE • Metric

Material Group	A		WU10PE Cutting Speed – vc m/min		mm	Recommended feed per tooth (Fz=mm/th) for 3D milling/profiling (A) - finishing										
	ap	ae	Min	Max		D1 - Diameter										
	ap	ae	Min	Max	2,0	3,0	4,0	6,0	8,0	10,0	12,0	16,0	20,0			
P	3	0,04 x D	0,04 x D	416	–	468	Fz	0,052	0,080	0,108	0,168	0,231	0,279	0,324	0,403	0,466
	4	0,04 x D	0,04 x D	364	–	416	Fz	0,048	0,073	0,099	0,152	0,207	0,249	0,288	0,355	0,406
H	1	0,03 x D	0,03 x D	290	–	406	Fz	0,052	0,078	0,106	0,162	0,221	0,266	0,308	0,379	0,434
	2	0,03 x D	0,03 x D	203	–	348	Fz	0,039	0,059	0,080	0,122	0,166	0,199	0,230	0,281	0,320
	3	0,02 x D	0,02 x D	216	–	324	Fz	0,033	0,050	0,067	0,102	0,139	0,168	0,196	0,244	0,284
	4	0,02 x D	0,02 x D	180	–	252	Fz	0,022	0,033	0,045	0,068	0,093	0,112	0,130	0,162	0,187

NOTE: Please use the reference table to optimize your cutting speed based on the average cutting angle of the application. See page B192.

Vision Plus • Series 7150 Roughing • Application Data • WU10PE • Metric

Material Group	A		WU10PE Cutting Speed – vc m/min		mm	Recommended feed per tooth (Fz=mm/th) for 3D milling/profiling (A) - roughing										
	ap	ae	Min	Max		D1 - Diameter										
						2,0	3,0	4,0	6,0	8,0	10,0	12,0	16,0	20,0		
P	3	0,2 x D	0,1 x D	208	–	234	Fz	0,015	0,023	0,031	0,049	0,067	0,081	0,094	0,117	0,136
	4	0,2 x D	0,1 x D	182	–	208	Fz	0,014	0,021	0,029	0,044	0,060	0,073	0,084	0,103	0,118
H	1	0,15 x D	0,1 x D	140	–	196	Fz	0,021	0,032	0,043	0,066	0,090	0,109	0,125	0,154	0,177
	2	0,1 x D	0,075 x D	119	–	204	Fz	0,024	0,036	0,048	0,074	0,101	0,121	0,140	0,171	0,194
	3	0,05 x D	0,05 x D	138	–	207	Fz	0,027	0,041	0,055	0,084	0,114	0,138	0,161	0,200	0,233
	4	0,05 x D	0,05 x D	115	–	161	Fz	0,018	0,027	0,037	0,056	0,076	0,092	0,107	0,133	0,154

NOTE: Please use the reference table to optimize your cutting speed based on the average cutting angle of the application. See page B192.

Vision Plus • Series 7150 Semi-Finishing • Application Data • WU10PE • Metric

Material Group	A		WU10PE Cutting Speed – vc m/min		mm	Recommended feed per th (fz) chamfering											
	ap	ae	min	max		D1 – Diameter											
						1,0	2,0	2,5	3,0	4,0	5,0	6,0	8,0	10,0	12,0		
P	3	0,1 x D	0,1 x D	240	–	320	fz	0,017	0,034	0,043	0,052	0,070	0,089	0,109	0,150	0,182	0,211
	4	0,1 x D	0,1 x D	180	–	300	fz	0,016	0,031	0,040	0,048	0,064	0,081	0,099	0,134	0,162	0,187
H	1	0,1 x D	0,1 x D	160	–	280	fz	0,016	0,031	0,040	0,048	0,064	0,081	0,099	0,134	0,162	0,187
	2	0,1 x D	0,1 x D	140	–	240	fz	0,012	0,024	0,030	0,036	0,048	0,061	0,074	0,101	0,121	0,140
	3	0,1 x D	0,1 x D	120	–	180	fz	0,009	0,019	0,024	0,028	0,038	0,048	0,058	0,079	0,096	0,112
	4	0,1 x D	0,1 x D	100	–	140	fz	0,006	0,012	0,016	0,019	0,025	0,032	0,039	0,053	0,064	0,074

NOTE: Please use the reference table to optimize your cutting speed based on the average cutting angle of the application. See page B192.

Vision Plus • Series 7150 Finishing • Application Data • WU10PE • Metric

Material Group	A		WU10PE Cutting Speed – vc m/min		mm	Recommended feed per tooth (Fz=mm/th) for 3D milling/profiling (A) - finishing										
	ap	ae	Min	Max		D1 - Diameter										
						2,0	3,0	4,0	6,0	8,0	10,0	12,0	16,0	20,0		
P	3	0,04 x D	0,04 x D	416	–	468	Fz	0,052	0,080	0,108	0,168	0,231	0,279	0,324	0,403	0,466
	4	0,04 x D	0,04 x D	364	–	416	Fz	0,048	0,073	0,099	0,152	0,207	0,249	0,288	0,355	0,406
H	1	0,03 x D	0,03 x D	290	–	406	Fz	0,052	0,078	0,106	0,162	0,221	0,266	0,308	0,379	0,434
	2	0,03 x D	0,03 x D	203	–	348	Fz	0,039	0,059	0,080	0,122	0,166	0,199	0,230	0,281	0,320
	3	0,02 x D	0,02 x D	216	–	324	Fz	0,033	0,050	0,067	0,102	0,139	0,168	0,196	0,244	0,284
	4	0,02 x D	0,02 x D	180	–	252	Fz	0,022	0,033	0,045	0,068	0,093	0,112	0,130	0,162	0,187

NOTE: Please use the reference table to optimize your cutting speed based on the average cutting angle of the application. See page B192.

Vision Plus • Series 7151 Roughing • Application Data • WU10PE • Metric

Material Group	A		WU10PE Cutting Speed – vc m/min		mm	Recommended feed per tooth (Fz=mm/th) for 3D milling/profiling (A) - roughing										
	ap	ae	Min	Max		D1 - Diameter										
						2,0	3,0	4,0	6,0	8,0	10,0	12,0	16,0	20,0		
P	3	0,2 x D	0,1 x D	208	–	234	Fz	0,015	0,023	0,031	0,049	0,067	0,081	0,094	0,117	0,136
	4	0,2 x D	0,1 x D	182	–	208	Fz	0,014	0,021	0,029	0,044	0,060	0,073	0,084	0,103	0,118
H	1	0,15 x D	0,1 x D	140	–	196	Fz	0,021	0,032	0,043	0,066	0,090	0,109	0,125	0,154	0,177
	2	0,1 x D	0,075 x D	119	–	204	Fz	0,024	0,036	0,048	0,074	0,101	0,121	0,140	0,171	0,194
	3	0,05 x D	0,05 x D	138	–	207	Fz	0,027	0,041	0,055	0,084	0,114	0,138	0,161	0,200	0,233
	4	0,05 x D	0,05 x D	115	–	161	Fz	0,018	0,027	0,037	0,056	0,076	0,092	0,107	0,133	0,154

NOTE: Please use the reference table to optimize your cutting speed based on the average cutting angle of the application. See page B192.

Vision Plus • Series 7151 Semi-Finishing • Application Data • WU10PE • Metric

Material Group	A		WU10PE Cutting Speed – vc m/min		mm	Recommended feed per th (fz) chamfering											
	ap	ae	min	max		D1 – Diameter											
						1,0	2,0	2,5	3,0	4,0	5,0	6,0	8,0	10,0	12,0		
P	3	0,1 x D	0,05 x D	240	–	320	fz	0,017	0,034	0,043	0,052	0,070	0,089	0,109	0,150	0,182	0,211
	4	0,1 x D	0,1 x D	180	–	300	fz	0,016	0,031	0,040	0,048	0,064	0,081	0,099	0,134	0,162	0,187
H	1	0,1 x D	0,1 x D	160	–	280	fz	0,016	0,031	0,040	0,048	0,064	0,081	0,099	0,134	0,162	0,187
	2	0,1 x D	0,1 x D	140	–	240	fz	0,012	0,024	0,030	0,036	0,048	0,061	0,074	0,101	0,121	0,140
	3	0,1 x D	0,1 x D	120	–	180	fz	0,009	0,019	0,024	0,028	0,038	0,048	0,058	0,079	0,096	0,112
	4	0,1 x D	0,1 x D	100	–	140	fz	0,006	0,012	0,016	0,019	0,025	0,032	0,039	0,053	0,064	0,074

NOTE: Please use the reference table to optimize your cutting speed based on the average cutting angle of the application. See page B192.

Vision Plus • Series 7151 Finishing • Application Data • WU10PE • Metric

Material Group	A		WU10PE Cutting Speed – vc m/min		mm	Recommended feed per tooth (Fz=mm/th) for 3D milling/profiling (A) - finishing										
	ap	ae	Min	Max		D1 - Diameter										
						2,0	3,0	4,0	6,0	8,0	10,0	12,0	16,0	20,0		
P	3	0,04 x D	0,04 x D	416	–	468	Fz	0,052	0,080	0,108	0,168	0,231	0,279	0,324	0,403	0,466
	4	0,04 x D	0,04 x D	364	–	416	Fz	0,048	0,073	0,099	0,152	0,207	0,249	0,288	0,355	0,406
H	1	0,03 x D	0,03 x D	290	–	406	Fz	0,052	0,078	0,106	0,162	0,221	0,266	0,308	0,379	0,434
	2	0,03 x D	0,03 x D	203	–	348	Fz	0,039	0,059	0,080	0,122	0,166	0,199	0,230	0,281	0,320
	3	0,02 x D	0,02 x D	216	–	324	Fz	0,033	0,050	0,067	0,102	0,139	0,168	0,196	0,244	0,284
	4	0,02 x D	0,02 x D	180	–	252	Fz	0,022	0,033	0,045	0,068	0,093	0,112	0,130	0,162	0,187

NOTE: Please use the reference table to optimize your cutting speed based on the average cutting angle of the application. See page B192.

Vision Plus • Series 70N1 Roughing • Application Data • WU10PE • Metric

Material Group	A		WU10PE													
	A		Cutting Speed – vc m/min			Recommended feed per tooth (Fz=mm/th) for 3D milling/profiling (A) - roughing										
	ap	ae	Min	Max	mm	D1 - Diameter										
						2,0	3,0	4,0	6,0	8,0	10,0	12,0	16,0	20,0		
P	3	0,2 x D	0,1 x D	208	–	234	Fz	0,015	0,023	0,031	0,049	0,067	0,081	0,094	0,117	0,136
	4	0,2 x D	0,1 x D	182	–	208	Fz	0,014	0,021	0,029	0,044	0,060	0,073	0,084	0,103	0,118
H	1	0,15 x D	0,1 x D	140	–	196	Fz	0,021	0,032	0,043	0,066	0,090	0,109	0,125	0,154	0,177
	2	0,1 x D	0,075 x D	119	–	204	Fz	0,024	0,036	0,048	0,074	0,101	0,121	0,140	0,171	0,194
	3	0,05 x D	0,05 x D	138	–	207	Fz	0,027	0,041	0,055	0,084	0,114	0,138	0,161	0,200	0,233
	4	0,05 x D	0,05 x D	115	–	161	Fz	0,018	0,027	0,037	0,056	0,076	0,092	0,107	0,133	0,154

NOTE: Please use the reference table to optimize your cutting speed based on the average cutting angle of the application. See page B192.

Vision Plus • Series 70N1 Semi-Finishing • Application Data • WU10PE • Metric

Material Group	A		WU10PE				Recommended feed per th (fz) chamfering										
	A		Cutting Speed – vc m/min			mm	D1 – Diameter										
	ap	ae	min	max	1,0		2,0	2,5	3,0	4,0	5,0	6,0	8,0	10,0	12,0		
P	3	0,1 x D	0,1 x D	240	–	320	fz	0,017	0,034	0,043	0,052	0,070	0,089	0,109	0,150	0,182	0,211
	4	0,1 x D	0,1 x D	180	–	300	fz	0,016	0,031	0,040	0,048	0,064	0,081	0,099	0,134	0,162	0,187
H	1	0,1 x D	0,1 x D	160	–	280	fz	0,016	0,031	0,040	0,048	0,064	0,081	0,099	0,134	0,162	0,187
	2	0,1 x D	0,1 x D	140	–	240	fz	0,012	0,024	0,030	0,036	0,048	0,061	0,074	0,101	0,121	0,140
	3	0,1 x D	0,1 x D	120	–	180	fz	0,009	0,019	0,024	0,028	0,038	0,048	0,058	0,079	0,096	0,112
	4	0,1 x D	0,1 x D	100	–	140	fz	0,006	0,012	0,016	0,019	0,025	0,032	0,039	0,053	0,064	0,074

NOTE: Please use the reference table to optimize your cutting speed based on the average cutting angle of the application. See page B192.

Vision Plus • Series 70N1 Finishing • Application Data • WU10PE • Metric

Material Group	A		WU10PE			Recommended feed per tooth (Fz=mm/th) for 3D milling/profiling (A) - finishing										
	A		Cutting Speed – vc m/min			mm	D1 - Diameter									
	ap	ae	Min	Max	2,0		3,0	4,0	6,0	8,0	10,0	12,0	16,0	20,0		
P	3	0,04 x D	0,04 x D	416	–	468	Fz	0,052	0,080	0,108	0,168	0,231	0,279	0,324	0,403	0,466
	4	0,04 x D	0,04 x D	364	–	416	Fz	0,048	0,073	0,099	0,152	0,207	0,249	0,288	0,355	0,406
H	1	0,03 x D	0,03 x D	290	–	406	Fz	0,052	0,078	0,106	0,162	0,221	0,266	0,308	0,379	0,434
	2	0,03 x D	0,03 x D	203	–	348	Fz	0,039	0,059	0,080	0,122	0,166	0,199	0,230	0,281	0,320
	3	0,02 x D	0,02 x D	216	–	324	Fz	0,033	0,050	0,067	0,102	0,139	0,168	0,196	0,244	0,284
	4	0,02 x D	0,02 x D	180	–	252	Fz	0,022	0,033	0,045	0,068	0,093	0,112	0,130	0,162	0,187

NOTE: Please use the reference table to optimize your cutting speed based on the average cutting angle of the application. See page B192.

Vision Plus • Series 7N02 7N12 7N22 • Application Data • WU10PE • Metric

Material Group	Side Milling (A) and Slotting (B)			WU10PE		Recommended feed per tooth (fz = mm/th) for side milling (A). For slotting (B), reduce fz by 20%.												
	A		B	Cutting Speed – vc m/min		mm	D1 – Diameter											
	ap	ae	ap	min	max		0,3	0,4	0,5	0,6	0,8	1,0	1,5	2,0	2,5	3,0		
	ap	ae	ap	min	max	fz	fz	fz	fz	fz	fz	fz	fz	fz	fz	fz		
P	0	1,25 x D	0,25 x D	0,75 x D	150	–	200	fz	0,002	0,003	0,003	0,004	0,005	0,007	0,010	0,014	0,017	0,021
	1	1,25 x D	0,25 x D	0,75 x D	150	–	200	fz	0,002	0,003	0,003	0,004	0,005	0,007	0,010	0,014	0,017	0,021
	2	1,25 x D	0,25 x D	0,75 x D	140	–	190	fz	0,002	0,003	0,003	0,004	0,005	0,007	0,010	0,014	0,017	0,021
	3	1,25 x D	0,25 x D	0,75 x D	120	–	160	fz	0,002	0,002	0,003	0,003	0,004	0,006	0,008	0,011	0,014	0,017
	4	1,25 x D	0,25 x D	0,5 x D	90	–	150	fz	0,002	0,002	0,003	0,003	0,004	0,005	0,008	0,010	0,013	0,016
K	1	1,25 x D	0,25 x D	0,75 x D	60	–	100	fz	0,001	0,002	0,002	0,003	0,004	0,005	0,007	0,009	0,012	0,014
	2	1,25 x D	0,25 x D	0,5 x D	120	–	150	fz	0,002	0,003	0,003	0,004	0,005	0,007	0,010	0,014	0,017	0,021
H	1	1,25 x D	0,25 x D	0,5 x D	80	–	140	fz	0,002	0,002	0,003	0,003	0,004	0,005	0,008	0,010	0,013	0,016
	2	1,25 x D	0,25 x D	0,3 x D	70	–	120	fz	0,001	0,002	0,002	0,002	0,003	0,004	0,006	0,008	0,010	0,012
	3	1,25 x D	0,25 x D	0,25 x D	60	–	90	fz	0,001	0,001	0,002	0,002	0,002	0,003	0,005	0,006	0,008	0,009

Material Group	Side Milling (A) and Slotting (B)			WU10PE		Recommended feed per tooth (IPT = inch/th) for side milling (A). For slotting (B), reduce IPT by 20%.												
	A		B	Cutting Speed – vc SFM		mm	D1 – Diameter											
	ap	ae	ap	min	max		0,3	0,4	0,5	0,6	0,8	1,0	1,5	2,0	2,5	3,0		
	ap	ae	ap	min	max	IPT	IPT	IPT	IPT	IPT	IPT	IPT	IPT	IPT	IPT	IPT		
P	0	1.25 x D	0.25 x D	0.75 x D	492	–	656	IPT	.0001	.0001	.0001	.0002	.0002	.0003	.0004	.0005	.0007	.0008
	1	1.25 x D	0.25 x D	0.75 x D	492	–	656	IPT	.0001	.0001	.0001	.0002	.0002	.0003	.0004	.0005	.0007	.0008
	2	1.25 x D	0.25 x D	0.75 x D	459	–	623	IPT	.0001	.0001	.0001	.0002	.0002	.0003	.0004	.0005	.0007	.0008
	3	1.25 x D	0.25 x D	0.75 x D	394	–	525	IPT	.0001	.0001	.0001	.0001	.0002	.0002	.0003	.0004	.0006	.0007
	4	1.25 x D	0.25 x D	0.5 x D	295	–	492	IPT	.0001	.0001	.0001	.0001	.0002	.0002	.0003	.0004	.0005	.0006
K	1	1.25 x D	0.25 x D	0.75 x D	197	–	328	IPT	.0001	.0001	.0001	.0001	.0001	.0002	.0003	.0004	.0005	.0006
	2	1.25 x D	0.25 x D	0.5 x D	394	–	492	IPT	.0001	.0001	.0001	.0002	.0002	.0003	.0004	.0005	.0007	.0008
H	1	1.25 x D	0.25 x D	0.5 x D	361	–	459	IPT	.0001	.0001	.0001	.0001	.0002	.0002	.0003	.0004	.0006	.0007
	1	1.25 x D	0.25 x D	0.5 x D	262	–	459	IPT	.0001	.0001	.0001	.0001	.0002	.0002	.0003	.0004	.0005	.0006
	2	1.25 x D	0.25 x D	0.3 x D	230	–	394	IPT	.0000	.0001	.0001	.0001	.0001	.0002	.0002	.0003	.0004	.0005
3	1.25 x D	0.25 x D	0.25 x D	197	–	295	IPT	.0000	.0000	.0001	.0001	.0001	.0001	.0002	.0002	.0003	.0004	

NOTE: Lower value of cutting speed is used for high stock removal applications or for higher hardness (machinability) within group.
Higher value of cutting speed is used for finishing applications or for lower hardness (machinability) within group.
For tools with reach > 3 x D, reduce fz by 20%.
For tools with reach > 5 x D, reduce fz by 30%.

Vision Plus • Series 7N01 • Application Data • WU10PE • Metric

Material Group	A		Cutting Speed – vc m/min			mm	Recommended feed per tooth (fz = mm/th) for 3D milling/profiling (A) – finishing								
	ap	ae	min	m/min			D1 – Diameter								
				0,5	0,6		0,8	1,0	1,5	2,0	2,5	3,0			
	A		m/min												
P	3	0,04 x D	0,04 x D	432	–	576	fz	0,012	0,015	0,020	0,025	0,038	0,051	0,064	0,078
	4	0,04 x D	0,04 x D	324	–	540	fz	0,012	0,014	0,019	0,023	0,035	0,047	0,059	0,072
H	1	0,03 x D	0,03 x D	288	–	504	fz	0,012	0,014	0,019	0,023	0,035	0,047	0,059	0,072
	2	0,03 x D	0,03 x D	252	–	432	fz	0,009	0,011	0,014	0,018	0,027	0,036	0,045	0,054
	3	0,02 x D	0,02 x D	216	–	324	fz	0,007	0,008	0,011	0,014	0,021	0,028	0,035	0,043
	4	0,02 x D	0,02 x D	180	–	252	fz	0,005	0,006	0,007	0,009	0,014	0,019	0,024	0,028

Material Group	A		Cutting Speed – vc m/min			mm	Recommended feed per th (fz) chamfering								
	ap	ae	min	m/min			D1 – Diameter								
				0,5	0,6		0,8	1,0	1,5	2,0	2,5	3,0			
	A		m/min												
P	3	0,1 x D	0,05 x D	300	-	400	fz	0,008	0,010	0,013	0,017	0,025	0,034	0,043	0,052
	4	0,1 x D	0,05 x D	225	-	375	fz	0,008	0,009	0,012	0,016	0,023	0,031	0,040	0,048
H	1	0,07 x D	0,1 x D	200	-	350	fz	0,008	0,009	0,012	0,016	0,023	0,031	0,040	0,048
	2	0,05 x D	0,04 x D	175	-	300	fz	0,006	0,007	0,009	0,012	0,018	0,024	0,030	0,036
	3	0,03 x D	0,03 x D	150	-	225	fz	0,005	0,006	0,007	0,009	0,014	0,019	0,024	0,028
	4	0,03 x D	0,03 x D	125	-	175	fz	0,003	0,004	0,005	0,006	0,009	0,012	0,016	0,019

Material Group	A		Cutting Speed – vc m/min			mm	Recommended feed per tooth (fz = mm/th) for 3D milling/profiling (A) – roughing								
	ap	ae	min	m/min			D1 – Diameter								
				0,5	0,6		0,8	1,0	1,5	2,0	2,5	3,0			
	A		m/min												
P	3	0,2 x D	0,1 x D	216	-	288	fz	0,004	0,005	0,007	0,008	0,013	0,017	0,021	0,026
	4	0,2 x D	0,1 x D	162	-	270	fz	0,004	0,005	0,006	0,008	0,012	0,016	0,020	0,024
H	1	0,15 x D	0,1 x D	144	-	252	fz	0,004	0,005	0,006	0,008	0,012	0,016	0,020	0,024
	2	0,1 x D	0,075 x D	126	-	216	fz	0,003	0,004	0,005	0,006	0,009	0,012	0,015	0,018
	3	0,05 x D	0,05 x D	108	-	162	fz	0,002	0,003	0,004	0,005	0,007	0,009	0,012	0,014
	4	0,05 x D	0,05 x D	90	-	126	fz	0,002	0,002	0,002	0,003	0,005	0,006	0,008	0,009

NOTE: Please use reference table for correction of vc based on averages degree of the mold. See page B192.

Vision Plus • Series 7N21 Roughing • Application Data • WU10PE • Metric

Material Group	A		Cutting Speed – vc m/min			mm	Recommended feed per tooth (Fz=mm/th) for 3D milling/profiling (A) - roughing								
	ap	ae	Min	m/min			D1 - Diameter								
				0,5	0,6		0,8	1,0	1,5	2,0	2,5	3,0			
P	3	0,2 x D	0,1 x D	208	–	234	Fz	0,0037	0,0044	0,0059	0,0075	0,0113	0,0152	0,0192	0,0232
	4	0,2 x D	0,1 x D	182	–	208	Fz	0,0035	0,0042	0,0056	0,0070	0,0105	0,0141	0,0177	0,0213
H	1	0,15 x D	0,1 x D	140	–	196	Fz	0,0052	0,0062	0,0083	0,0104	0,0157	0,0211	0,0265	0,0319
	2	0,1 x D	0,075 x D	119	–	204	Fz	0,0059	0,0070	0,0094	0,0118	0,0178	0,0238	0,0299	0,0360
	3	0,05 x D	0,05 x D	138	–	207	Fz	0,0066	0,0080	0,0106	0,0133	0,0201	0,0269	0,0338	0,0408
	4	0,05 x D	0,05 x D	115	–	161	Fz	0,0044	0,0053	0,0071	0,0089	0,0134	0,0179	0,0226	0,0272

NOTE: Please use the reference table to optimize your cutting speed based on the average cutting angle of the application. See page B192.

Vision Plus • Series 7N21 Semi-Finishing • Application Data • WU10PE • Metric

Material Group	Profile Milling		WU10PE			Recommended feed per tooth (fz = mm/th) for 3D milling/profiling (A) – finishing									
	A		Cutting Speed – vc m/min			mm	D1 – Diameter								
	ap	ae	min	–	max		0,5	0,6	0,8	1,0	1,5	2,0	2,5	3,0	
P	3	0,04 x D	0,04 x D	432	–	576	fz	0,012	0,015	0,020	0,025	0,038	0,051	0,064	0,078
	4	0,04 x D	0,04 x D	324	–	540	fz	0,012	0,014	0,019	0,023	0,035	0,047	0,059	0,072
H	1	0,03 x D	0,03 x D	288	–	504	fz	0,012	0,014	0,019	0,023	0,035	0,047	0,059	0,072
	2	0,03 x D	0,03 x D	252	–	432	fz	0,009	0,011	0,014	0,018	0,027	0,036	0,045	0,054
	3	0,02 x D	0,02 x D	216	–	324	fz	0,007	0,008	0,011	0,014	0,021	0,028	0,035	0,043
	4	0,02 x D	0,02 x D	180	–	252	fz	0,005	0,006	0,007	0,009	0,014	0,019	0,024	0,028

Material Group	Profile Milling		WU10PE			Recommended feed per tooth (fz = mm/th) for 3D milling/profiling (A) – semi-finishing									
	A		Cutting Speed – vc m/min			mm	D1 – Diameter								
	ap	ae	min	–	max		0,5	0,6	0,8	1,0	1,5	2,0	2,5	3,0	
P	3	0,1 x D	0,05 x D	300	–	400	fz	0,008	0,010	0,013	0,017	0,025	0,034	0,043	0,052
	4	0,1 x D	0,05 x D	225	–	375	fz	0,008	0,009	0,012	0,016	0,023	0,031	0,040	0,048
H	1	0,07 x D	0,1 x D	200	–	350	fz	0,008	0,009	0,012	0,016	0,023	0,031	0,040	0,048
	2	0,05 x D	0,04 x D	175	–	300	fz	0,006	0,007	0,009	0,012	0,018	0,024	0,030	0,036
	3	0,03 x D	0,03 x D	150	–	225	fz	0,005	0,006	0,007	0,009	0,014	0,019	0,024	0,028
	4	0,03 x D	0,03 x D	125	–	175	fz	0,003	0,004	0,005	0,006	0,009	0,012	0,016	0,019

Material Group	Profile Milling		WU10PE			Recommended feed per tooth (fz = mm/th) for 3D milling/profiling (A) – roughing									
	A		Cutting Speed – vc m/min			mm	D1 – Diameter								
	ap	ae	min	–	max		0,5	0,6	0,8	1,0	1,5	2,0	2,5	3,0	
P	3	0,2 x D	0,1 x D	216	–	288	fz	0,004	0,005	0,007	0,008	0,013	0,017	0,021	0,026
	4	0,2 x D	0,1 x D	162	–	270	fz	0,004	0,005	0,006	0,008	0,012	0,016	0,020	0,024
H	1	0,15 x D	0,1 x D	144	–	252	fz	0,004	0,005	0,006	0,008	0,012	0,016	0,020	0,024
	2	0,1 x D	0,075 x D	126	–	216	fz	0,003	0,004	0,005	0,006	0,009	0,012	0,015	0,018
	3	0,05 x D	0,05 x D	108	–	162	fz	0,002	0,003	0,004	0,005	0,007	0,009	0,012	0,014
	4	0,05 x D	0,05 x D	90	–	126	fz	0,002	0,002	0,002	0,003	0,005	0,006	0,008	0,009

NOTE: Please use reference table for correction of vc based on averages degree of the mold. See page B192.

Vision Plus • Series 7N21 Finishing • Application Data • WU10PE • Metric

Material Group	A		WU10PE			Recommended feed per tooth (Fz=mm/th) for 3D milling/profiling (A) - finishing									
			Cutting Speed – vc m/min			mm	D1 - Diameter								
	ap	ae	Min	–	Max		0,5	0,6	0,8	1,0	1,5	2,0	2,5	3,0	
P	3	0,04 x D	0,04 x D	416	–	468	Fz	0,0127	0,0153	0,0204	0,0256	0,0389	0,0522	0,0659	0,0796
	4	0,04 x D	0,04 x D	364	–	416	Fz	0,0119	0,0143	0,0191	0,0239	0,0361	0,0484	0,0609	0,0734
H	1	0,03 x D	0,03 x D	290	–	406	Fz	0,0127	0,0153	0,0204	0,0255	0,0386	0,0517	0,0650	0,0784
	2	0,03 x D	0,03 x D	203	–	348	Fz	0,0096	0,0116	0,0154	0,0193	0,0292	0,0391	0,0491	0,0592
	3	0,02 x D	0,02 x D	216	–	324	Fz	0,0081	0,0097	0,0130	0,0163	0,0245	0,0328	0,0413	0,0497
	4	0,02 x D	0,02 x D	180	–	252	Fz	0,0054	0,0065	0,0087	0,0108	0,0164	0,0219	0,0275	0,0331

NOTE: Please use the reference table to optimize your cutting speed based on the average cutting angle of the application. See page B192.

Table of Factors to Maximize Ball Nose Cutting Speed for Hard Machining • Metric

Calculation Examples

Table of Factors for Speed Calculation of Ball Nose

Average Wall Angle	ap/D						
	0.003	0.006	0.010	0.016	0.020	0.025	0.030
0.0°	9.1	6.5	5.0	4.0	3.6	3.2	2.9
3.0°	6.2	4.9	4.0	3.3	3.0	2.8	2.6
5.0°	5.1	4.2	3.5	3.0	2.8	2.5	2.4
8.0°	4.1	3.4	3.0	2.6	2.4	2.3	2.1
10.0°	3.6	3.1	2.7	2.4	2.3	2.1	2.0
15.0°	2.8	2.5	2.2	2.0	1.9	1.8	1.7
20.0°	2.3	2.1	1.9	1.8	1.7	1.6	1.6
30.0°	1.7	1.6	1.5	1.4	1.4	1.3	1.3
40.0°	1.4	1.3	1.3	1.2	1.2	1.2	1.2
50.0°	1.2	1.2	1.1	1.1	1.1	1.1	1.1
55.0°	1.1	1.1	1.1	1.1	1.1	1.0	1.0

For calculating real cutting speed, use formula: Basic cutting speed * Factor

Choose the coefficient according to the ap/D and average wall angle.

Example 1:

For Tool = 10mm and ap = 0,2mm for average wall angle 0°, ap/D ratio equal 0,2/10 = 0,02. Factor equal 3.6.

Example 2:

For Tool = 8mm and ap = 0,1mm for average wall angle 10°, ap/D ratio equal 0,1/8 = 0,0125. Factor will be between 2.7 and 2.4, choose 2.6.

Keep in mind shank diameter and length effect.

If tool length out of the chuck is more than 2 x D, please decrease feed per tooth by 15% each 1 x D.

Material Group	TiAlN or AlTiN Basic Cutting Speed Vc m/min		
	min		max
P3	160	-	180
P4	140	-	160
H1	100	-	140
H2	70	-	120
H3	60	-	90
H4	50	-	70

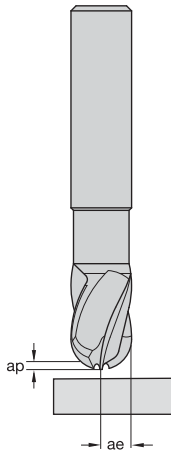

Application example #1 =

face milling a flat surface

D = 10mm

ap = 0,2mm

Average wall angle = 0°

Finishing H2

Starting vc from chart = 100

ap/D = 0.02

Factor from table =

3.6

vc to program into machine = 100 * 3.6 = 360 m/min

RPM = 360 * 1000/3.14/10 = 11460 RPM

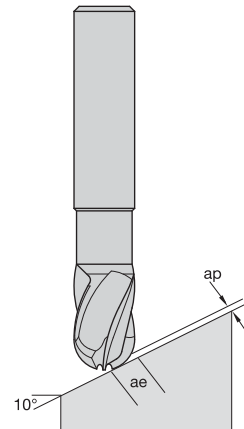

Application example #2 =

face milling a 10° average wall angle

D = 8mm

ap = 0,1mm

Average wall angle = 10°

Finishing H2

Starting vc from chart = 100

ap/D = 0,1/8 = 0,0125

Factor from table =

2.6

vc to program into machine = 100 * 2.6 = 260 m/min

RPM = 260 * 1000/3.14/10 = 7640 RPM



HSS End Mills

High-Performance Solid End Milling

The next generation of premium cobalt HSS roughers are designed specifically for titanium and stainless steels. They are engineered with an eccentric relief (ER) grind to provide a stronger cutting edge that requires less torque to operate. The unique proprietary chipbreaker geometry will break and control the chip, enabling higher metal removal rates and greater productivity. The HSS rougher offers the best-in-class performance for difficult-to-machine workpiece materials.

Features and Benefits



High cobalt and vanadium content PM HSS providing superior wear resistance and red hardness.

Different edge preparations and geometries to machine a wide range of materials.

Center cutting offering excellent performance in roughing applications, especially in titanium.

WavCut™ tools for machining titanium are best suited for applications in aerospace and energy, providing high metal removal rates (MRR) and increased tool life. The special wave design of these 4- and 6-fluted end mills requires less horsepower during roughing and semi-finishing, and provides excellent chip formation. Since chips evacuate easily, WavCut tools do not recut chips thus increasing tool life. Also, the edges change the radial cutting edge position without changing the diameter.

HIGH

SOPHISTICATED PERFORMANCE

Sophisticated roughing profiles capable of dealing with chip formation issues.

High-performance finishers with specific geometries for different workpiece materials.

EFFICIENT

Increase stock removal rates over regular roughing tools due to reduced horsepower consumption.

HIGH SPEED STEEL

PRODUCT

SOLID CARBIDE END MILL

GRADE

UNCOATED
TICN

FLUTE

4-8

DIAMETER RANGE

METRIC

6-50mm

INDUSTRY



GENERAL
ENGINEERING



AEROSPACE



ENERGY



TRANSPORTATION

APPLICATIONS

MATERIALS

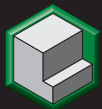

SIDE MILLING



RAMPING



HELICAL INTERPOLATION



SLOTTING



DYNAMIC MILLING



PLUNGING

HSS Roughers • Series 6N06 • Chamfer • Weldon® • Metric

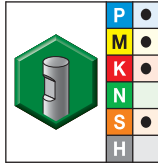
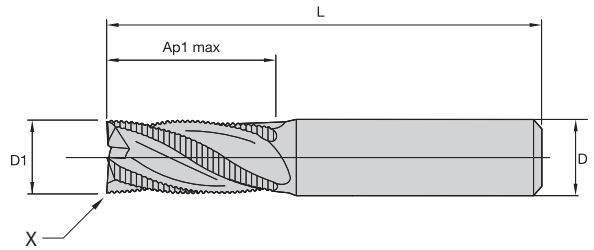
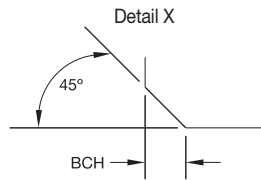

TIAIN-LW

- first choice
- alternate choice

order #	catalogue #	D1	D	length of cut Ap1 max	length L	BCH	ZU
1660373	6N0606002LW	6,0	6	13,00	57	0,25	4
1660389	6N0608004LW	8,0	10	19,00	69	0,25	4
1660397	6N0609004LW	9,0	10	19,00	69	0,25	4
1660405	6N0610004LW	10,0	10	22,00	72	0,25	4
1660421	6N0612005LW	12,0	12	26,00	83	0,35	4
1660437	6N0614005LW	14,0	12	26,00	83	0,35	4
1660453	6N0616006LW	16,0	16	32,00	92	0,35	4
1660479	6N0620007LW	20,0	20	38,00	104	0,35	4
1660487	6N0622007LW	22,0	20	38,00	104	0,50	5
1660497	6N0625008LW	25,0	25	45,00	121	0,50	5
1660507	6N0630008LW	30,0	25	45,00	121	0,50	5

NOTE: For application data, please see page B198.

HSS Roughers • Series 6NL6 • Chamfer • Neck • Weldon® • Metric

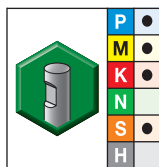
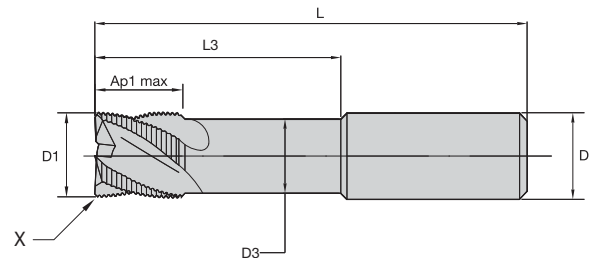
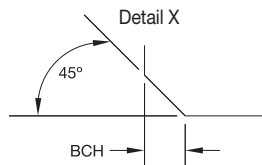

TIAIN-LW

- first choice
- alternate choice

order #	catalogue #	D1	D	D3	length of cut Ap1 max	L3	length L	BCH	ZU
1660623	6NL612005LW	12,0	12	12	26,00	78,00	125	0,35	4
1660629	6NL616006LW	16,0	16	15	32,00	87,00	138	0,35	4
1660635	6NL620007LW	20,0	20	20	38,00	108,00	160	0,35	4
1660640	6NL625008LW	25,0	25	25	45,00	155,00	216	0,50	5

NOTE: For application data, please see page B198.

WavCut™ I • Series 660W 661W 664W • Chamfer • Weldon® • Metric

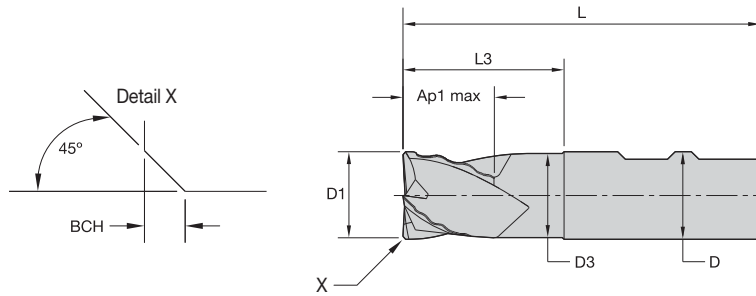
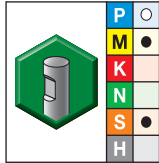

- first choice
- alternate choice

UNCOATED-WW

order #	catalogue #	D1	D	D3	length of cut Ap1 max	L3	length L	BCH	ZU
3871691	664W25008WW	25,0	25	23	26,00	46,00	102	1,00	5
3871692	660W25008WW	25,0	25	23	45,00	65,00	121	1,00	5
3871833	661W25008WW	25,0	25	23	90,00	110,00	166	1,00	6
3871835	660W32009WW	32,0	32	30	53,00	73,00	133	1,00	6
3871836	661W32009WW	32,0	32	30	100,00	110,00	170	1,00	6
3871837	664W40009WW	40,0	32	—	38,00	58,00	118	1,00	6
3871839	661W40009WW	40,0	32	—	100,00	110,00	170	1,00	6
3871840	664W50000WW	50,0	50	47	40,00	60,00	140	1,00	6
3871841	660W50000WW	50,0	50	47	75,00	95,00	175	1,00	6
3871842	661W50000WW	50,0	50	47	110,00	130,00	210	1,00	8

NOTE: For application data, please see page B199.

INDEXABLE MILLING

SOLID END MILLING

HOLEMAKING

TAPPING

TURNING

HSS Solid End Mills • HSS Roughers

HSS Roughers • Series 6N06 • Application Data • TiAlN-LW • Metric

Material Group	Side Milling (A) and Slotting (B)			TiCN		TiAlN		Recommended feed per tooth (fz = mm/th) for side milling (A). For slotting (B), reduce fz by 20%.										
	A		B	Cutting Speed – vc m/min		Cutting Speed – vc m/min		mm	D1 – Diameter									
	ap	ae	ap	min	max	min	max		6,0	8,0	10,0	12,0	16,0	18,0	20,0	25,0	30,0	
	1	1,5 x D	0,5 x D	1 x D	56	64	70	80	fz	0,046	0,062	0,072	0,079	0,097	0,104	0,109	0,119	0,143
P	2	1,5 x D	0,5 x D	1 x D	48	64	60	80	fz	0,046	0,062	0,072	0,079	0,097	0,104	0,109	0,119	0,143
	3	1,5 x D	0,5 x D	1 x D	40	56	50	70	fz	0,038	0,052	0,061	0,067	0,084	0,091	0,097	0,109	0,131
	5	1,5 x D	0,5 x D	1 x D	20	28	25	35	fz	0,031	0,042	0,048	0,054	0,067	0,073	0,078	0,087	0,105
M	1	1,5 x D	0,5 x D	1 x D	20	28	25	35	fz	0,038	0,052	0,061	0,067	0,084	0,091	0,097	0,109	0,131
	2	1,5 x D	0,5 x D	1 x D	20	24	25	30	fz	0,031	0,042	0,048	0,054	0,067	0,073	0,078	0,087	0,105
	3	1,5 x D	0,5 x D	1 x D	12	16	15	20	fz	0,026	0,035	0,040	0,045	0,055	0,059	0,062	0,068	0,082
K	1	1,5 x D	0,5 x D	1 x D	56	64	70	80	fz	0,046	0,062	0,072	0,079	0,097	0,104	0,109	0,119	0,143
	2	1,5 x D	0,5 x D	1 x D	40	56	50	70	fz	0,038	0,052	0,061	0,067	0,084	0,091	0,097	0,109	0,131
	3	1,5 x D	0,5 x D	1 x D	12	24	15	30	fz	0,038	0,052	0,061	0,067	0,084	0,091	0,097	0,109	0,131
S	1	1,5 x D	0,5 x D	1 x D	4	12	5	15	fz	0,021	0,027	0,032	0,036	0,045	0,048	0,052	0,059	0,071
	2	1,5 x D	0,5 x D	1 x D	12	22	15	28	fz	0,031	0,042	0,048	0,054	0,067	0,073	0,078	0,087	0,105
	3	1,5 x D	0,5 x D	1 x D	12	22	15	28	fz	0,031	0,042	0,048	0,054	0,067	0,073	0,078	0,087	0,105
	4	1,5 x D	0,5 x D	1 x D	12	22	15	28	fz	0,027	0,038	0,045	0,050	0,062	0,067	0,071	0,080	0,096

NOTE: Lower value of cutting speed is used for high stock removal applications or for higher hardness (machinability) within group.
Higher value of cutting speed is used for finishing applications or for lower hardness (machinability) within group.
Above parameters are based on ideal conditions. For smaller taper machining centers, please adjust parameters accordingly on diameters >12mm.

HSS Roughers • Series 6NL6 • Application Data • TiAlN-LW • Metric

Material Group	Side Milling (A) and Slotting (B)			TiAlN			Recommended feed per tooth (fz = mm/th) for side milling (A). For slotting (B), reduce fz by 20%.					
	A		B	Cutting Speed – vc m/min			mm	D1 – Diameter				
	ap	ae	ap	min	max	10,0		12,0	16,0	20,0	25,0	
	1	1,5 x D	0,5 x D	1 x D	70	80	fz	0,063	0,070	0,085	0,096	0,104
P	2	1,5 x D	0,5 x D	1 x D	60	80	fz	0,063	0,070	0,085	0,096	0,104
	3	1,5 x D	0,5 x D	1 x D	50	70	fz	0,053	0,059	0,073	0,085	0,096
	5	1,5 x D	0,5 x D	1 x D	25	35	fz	0,042	0,047	0,059	0,068	0,076
M	1	1,5 x D	0,5 x D	1 x D	25	35	fz	0,053	0,059	0,073	0,085	0,096
	2	1,5 x D	0,5 x D	1 x D	25	30	fz	0,042	0,047	0,059	0,068	0,076
	3	1,5 x D	0,5 x D	1 x D	15	20	fz	0,035	0,039	0,048	0,054	0,060
K	1	1,5 x D	0,5 x D	1 x D	70	80	fz	0,063	0,070	0,085	0,096	0,104
	2	1,5 x D	0,5 x D	1 x D	50	70	fz	0,053	0,059	0,073	0,085	0,096
	3	1,5 x D	0,5 x D	1 x D	15	30	fz	0,053	0,059	0,073	0,085	0,096
S	1	1,5 x D	0,5 x D	1 x D	5	15	fz	0,028	0,031	0,039	0,045	0,051
	2	1,5 x D	0,5 x D	1 x D	15	30	fz	0,042	0,047	0,059	0,068	0,076
	3	1,5 x D	0,5 x D	1 x D	15	30	fz	0,042	0,047	0,059	0,068	0,076
	4	1,5 x D	0,5 x D	1 x D	10	20	fz	0,039	0,043	0,054	0,062	0,070

NOTE: Lower value of cutting speed is used for high stock removal applications or for higher hardness (machinability) within group.
Higher value of cutting speed is used for finishing applications or for lower hardness (machinability) within group.
Above parameters are based on ideal conditions. For smaller taper machining centers, please adjust parameters accordingly on diameters >12mm.

INDEXABLE MILLING



SOLID END MILLING

HOLEMAKING

TAPPING

TURNING

WavCut I • Series 664W 660W 661W • Application Data • Uncoated-WW • Metric

												
		Side Milling (A) and Slotting (B)		Uncoated			Recommended feed per tooth (fz = mm/th) for side milling (A). For slotting (B), reduce fz by 20%.					
Material Group	A		B	Cutting Speed – vc m/min			mm	D1 – Diameter				
	ap	ae	ap	min		max		25,0	32,0	40,0	50,0	
P	5	1,5 x D	0,4 x D	1 x D	10	–	14	fz	0,091	0,105	0,124	0,146
M	1	1,5 x D	0,4 x D	1 x D	10	–	14	fz	0,114	0,131	0,155	0,182
	2	1,5 x D	0,4 x D	1 x D	10	–	12	fz	0,091	0,105	0,124	0,146
S	3	1,5 x D	0,4 x D	0,75 x D	6	–	11	fz	0,091	0,105	0,124	0,146
	4	1,5 x D	0,4 x D	0,75 x D	6	–	11	fz	0,084	0,096	0,114	0,134

NOTE: Lower value of cutting speed is used for high stock removal applications or for higher hardness (machinability) within group.
 Higher value of cutting speed is used for finishing applications or for lower hardness (machinability) within group.
 Above parameters are based on ideal conditions. For smaller taper machining centers, please adjust parameters accordingly on diameters >12mm.

INDEXABLE MILLING

SOLID END MILLING

HOLEMAKING

TAPPING

TURNING



Holemaking

Selection Guide and Grade Descriptions	C4–C7
Solid Carbide Drills	C8–C53
VariDrill.....	C8–C29
TOP DRILL S+ 12 x D.....	C30–C35
TOP DRILL Deep Hole Drills.....	C36–C45
TOP DRILL S Pilot Drills.....	C46–C53
Modular Drills	C54–C84
TOP DRILL Modular X.....	C54–C70
TOP DRILL M1.....	C72–C84
Indexable Drills	C86–C110
Top Cut 4.....	C86–C110
Hole Finishing	C112–C132
HSR Reamers.....	C112–C123
TRF and TRM Reamers.....	C124–C132
Modular Boring	C134–C152
eBore.....	C134–C152

Added Value for Your Performance

Optimized Purchase

- Broad selection of holemaking tools.
- Integrated into a full range of cutting tools and service offers.
- On-site service for an efficient development and implementation of machining solutions.

Control of Total Tooling Costs

- Process-safe regrinding service.
- Reduction of stocks through efficient modular concepts.
- Multiple platforms per application to achieve the most cost-efficient solution.

- Solid Carbide Drills
- Modular Drills
- Indexable Drills

Select the Correct Holemaking Product Platform for Your Application

diameter	hourly rate					
	low (rough)		normal (M/C)		high (fine)	
	IT11	IT10	IT9	IT8	IT7	IT6
mm						
3			Solid Carbide Drills 1,00–25,00mm			
6			Top Drill M1™ 7,94–27,99mm			
9			Top Drill MX 16,00–40,00mm			
12			Top Drill MX 16,00–40,00mm			
15			Top Drill MX 16,00–40,00mm			
18			Top Drill MX 16,00–40,00mm			
21			Top Drill MX 16,00–40,00mm			
27			Top Drill MX 16,00–40,00mm			
30			Top Drill MX 16,00–40,00mm			
33			Top Drill MX 16,00–40,00mm			
36			Top Drill MX 16,00–40,00mm			
39			Top Drill MX 16,00–40,00mm			
42			Top Drill MX 16,00–40,00mm			
45			Top Drill MX 16,00–40,00mm			
48			Top Drill MX 16,00–40,00mm			
51			Top Drill MX 16,00–40,00mm			
54			Top Drill MX 16,00–40,00mm			
57			Top Drill MX 16,00–40,00mm			
60			Top Drill MX 16,00–40,00mm			
63			Top Drill MX 16,00–40,00mm			
66			Top Drill MX 16,00–40,00mm			
69			Top Drill MX 16,00–40,00mm			
72			Top Drill MX 16,00–40,00mm			
75			Top Drill MX 16,00–40,00mm			
110			Top Drill MX 16,00–40,00mm			

Solid Drilling

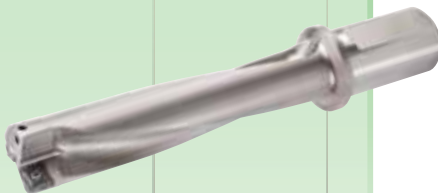

Added Value for Your Performance

- Reamers
- Modular Boring

Select the Correct Holemaking Product Platform for Your Application

Hole Finishing	diameter mm	hourly rate					
		low (rough)		normal (M/C) hole quality		high (fine)	
		IT11	IT10	IT9	IT8	IT7	IT6
	3						
	10						
	20						
	30						
	40						
	50						
	60						
	70						
	80						
	90						
	100						
	110						
	120						
	130						
	140						
	150						
	160						
	170						
	180						
	190						
	200						
	210						
	510						
	1020						

Product Platform	Application Range (mm)	Hourly Rate
eBore™ Twin Cutter Rnd Shank	19.5–29.5mm	low (rough)
eBore Twin Cutter - KMTS Back End	29.5–205mm	low (rough)
eBore Bridge Twin Cutter - Shell Mill Back End	200–1020mm	low (rough)
eBore Universal	6.0–152mm	normal (M/C)
eBore Boring Tool	20.0–200mm	normal (M/C)
eBore Bridge Finishing - Shell Mill Back End	200–1020mm	normal (M/C)
Tipped Reamers (TRF)	14–42mm	high (fine)
Modular Reamers (TRM)	14–42mm	high (fine)

*IT6 is possible above 10mm (0.394") for both HSR SC-Reaming and HSR-Tipped Reamer in custom solutions.

Grades and Grade Descriptions

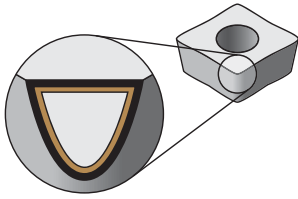

Coatings provide high-speed capability and are engineered for finishing to heavy roughing.

P	Steel
M	Stainless Steel
K	Cast Iron
N	Non-Ferrous
S	High-Temp Alloys
H	Hardened Materials

Grade	Coating	Grade Description	wear resistance ← → toughness												
			05	10	15	20	25	30	35	40	45				
WK15PD		<p>Composition: With a newly developed unique multilayered PVD AlCrN coating and a high-quality submicron carbide substrate, this grade gives the highest level of wear resistance at high cutting speeds.</p> <p>Application: This grade offers extraordinary wear resistance in drilling of cast iron materials. With its high hot hardness, it allows for high-speed machining.</p>													
WM15PD		<p>Composition: With PVD AlTiN coating for wear resistance along with unalloyed, submicron tungsten carbide containing 10% cobalt.</p> <p>Application: For use in cast iron, stainless steel, non-ferrous, and super alloys. Grade capable to operate at higher temperatures to guarantee high performance at faster cutting speeds.</p>													
WU20PD		<p>Composition: With a multilayered PVD TiN-TiAlN coating, a high-quality, submicron carbide substrate and a state-of-the-art surface condition, this grade gives the highest level of wear resistance at high cutting speeds.</p> <p>Application: First choice for alloyed and high-alloyed steels and cast irons. A state-of-the-art surface condition enables superior chip evacuation even when MQL is applied.</p>													
WU25PD		<p>Composition: With a multilayered PVD TiN-TiAlN coating and a high-quality, submicron carbide substrate, this grade gives a high level of wear resistance at medium to high cutting speeds.</p> <p>Application: First choice for high reliability in all materials. This grade should be used at medium to high speeds and feeds. It is a general-purpose grade that performs very well for alloyed and high-alloy steel and cast iron, but can also be used with excellent performance in all other material groups.</p>													
WP40PD		<p>Composition: With a multilayered TiN-TiAlN coating and a high-quality tough, substrate containing 11% cobalt.</p> <p>Application: For use in steel, cast iron, stainless steel, and super alloys. This grade is suitable for critical operations and unstable conditions.</p>													
WN10HD		<p>Composition: This uncoated fine-grain carbide with high hardness offers excellent abrasive wear resistance.</p> <p>Application: First choice for precision drilling of non-ferrous materials.</p>													

Grades and Grade Descriptions

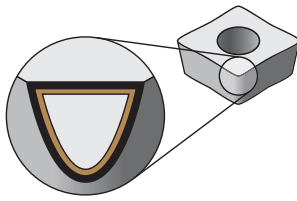

Coatings provide high-speed capability and are engineered for finishing to heavy roughing.

P	Steel
M	Stainless Steel
K	Cast Iron
N	Non-Ferrous
S	High-Temp Alloys
H	Hardened Materials

wear resistance ← → toughness

Grade	Coating	Grade Description	Performance Matrix																					
			05	10	15	20	25	30	35	40	45													
WN15HD		Composition: Submicron grain size tungsten carbide for excellent wear resistance and edge retention. Application: For use in aluminum and non-ferrous materials																						
			K																					
			N																					
WPK10CH		Composition: With an advanced CVD TiCN-Al ₂ O ₃ coating combined with a cobalt-enriched carbide substrate, this grade offers a balanced combination of deformation resistance and edge toughness. Application: Offers outstanding abrasion and crater wear resistance for high-speed machining of steels and cast irons. Use for very high cutting speeds with low to medium feed rates.																						
			P																					
			K																					
WN10PH		Composition: Submicron grain size tungsten carbide with PVD TiB ₂ coating for excellent wear resistance. Application: For use in aluminum and non-ferrous applications.																						
			N																					
WU20PH		Composition: With a wear-resistant TiAlN coating and unalloyed, submicron tungsten carbide containing 10% cobalt. Application: This is a universal grade for use in steel, cast iron, stainless steel, and super alloys at medium machining speeds.																						
			P																					
			M																					
			K																					
			N																					
			S																					
WU25CH		Composition: Advanced CVD TiCN-Al ₂ O ₃ coating together with a newly engineered, tough carbide substrate. Ensures adequate deformation resistance and excellent edge strength and offers very good wear resistance over a wide range of machining conditions. Application: high-productivity grade with high speeds and feeds. First choice for high productivity with excellent reliability in steels, stainless steels, and cast irons.																						
			P																					
			M																					
WU40PH		Composition: With a multilayered PVD TiN-TiAlN coating and a tough substrate, this grade withstands interruptions and provides high wear resistance for long tool life. Application: First choice for high reliability in most materials. This grade should be used at medium speeds and high feeds due to sharper edges and as a grade for high-toughness applications. It covers steel, stainless steel, cast iron, and high-temp alloys under certain conditions.																						
			P																					
			M																					

The VariDrill solid carbide drill is a versatile drill designed for use in multi-material drilling operations.

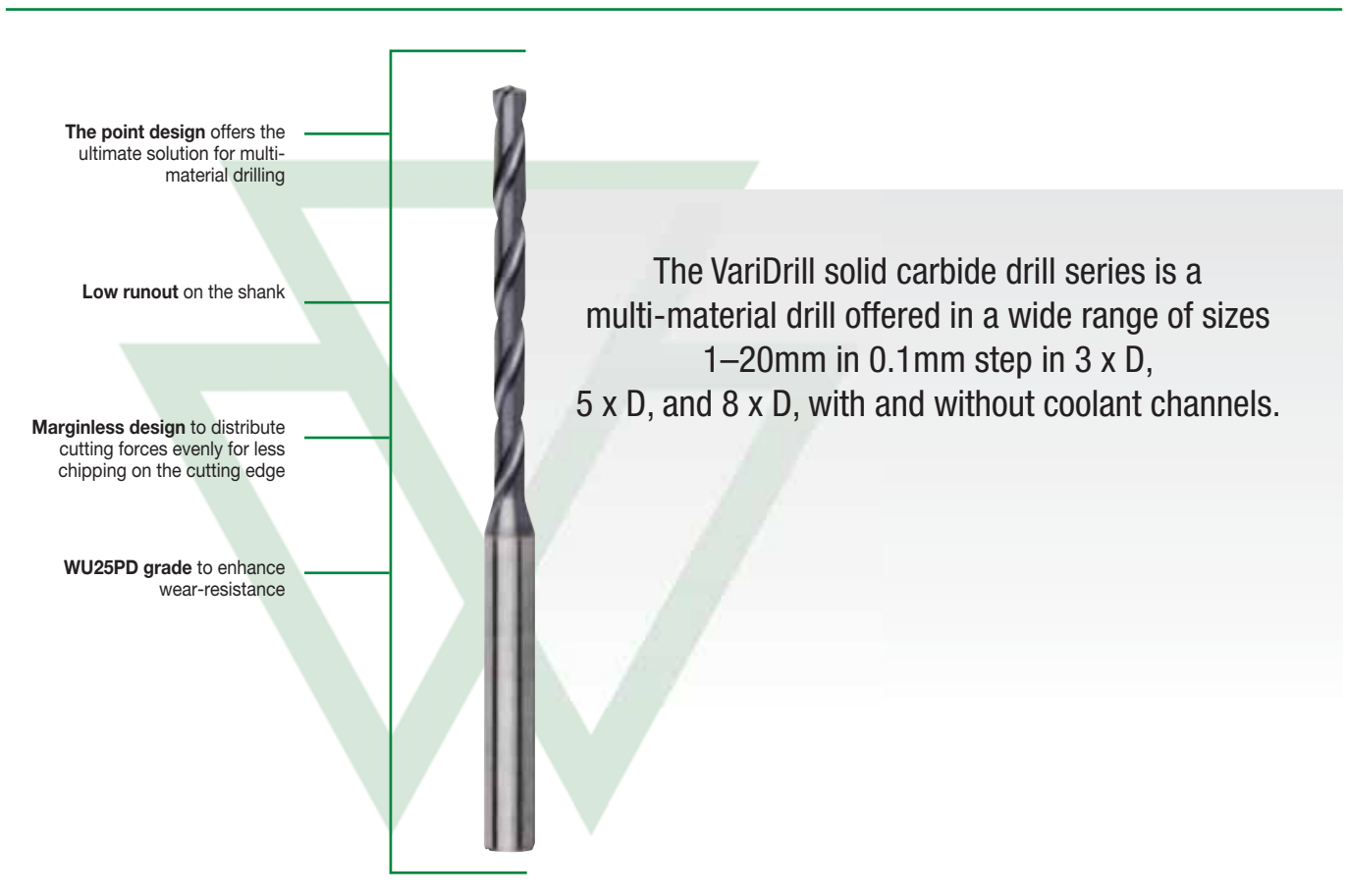

WU25PD



Delivers a smooth surface finish across multiple materials:

Steel, stainless steel, aluminum, cast iron, and high-temp alloys.

MULTI-MATERIAL DRILLING

PRODUCT

GRADE

WU25PD

DIAMETER RANGE

1–20mm
1,5–20mm

INDUSTRY



MATERIALS

FIRST CHOICE



Applications



DRILLING



STACKED PLATES



PLAIN SHANK: $\leq H6$



HELIX ANGLE: 30°



DIN 6537



DIN 6535



THROUGH COOLANT



FLOOD COOLANT



THROUGH COOLANT: MQL



SERIES

VDS201

VDS202

VDS401

VDS402

VDS403

COOLANT

Non-Coolant

Non-Coolant

Through Coolant

Through Coolant

Through Coolant

LENGTH RATIO

3 x D

5 x D

3 x D

5 x D

8 x D

DIAMETER RANGE

1–20mm

1–20mm

1,5–20mm

1,5–20mm

1,5–20mm

PRECISION SHANK

Low Runout
Increase the overall drill stability



VariDrill™ • Catalog Numbering System

Each character in our catalog number signifies a specific trait of that product.
Use the following key columns and corresponding images to easily identify which attributes apply.

VDS	4	0	1	A	08500	WU25PD
VariDrill Spiral	Flute Style - Coolant	Point	Length	Shank	Diameter in Metric	
	<p>2 = 2 Flute Spiral Non- Coolant</p> <p>4 = 2 Flute Spiral Coolant</p>	<p>0 = Conventional Cone Point</p>	<p>1 = ~ 3 x D 2 = ~ 5 x D 3 = ~ 8 x D</p>	<p>A = Cylindrical Shank, DIN 6535 - 2mm steps</p> <p>F = Whistle Notch 2, DIN 6535 - 2mm steps</p>	<p>03000 = 3,000mm 06350 = 1/4"</p>	<p>WIDIA™; Universal, Application 25 = roughing carbide, PVD coated, Drill</p>

New type "A"

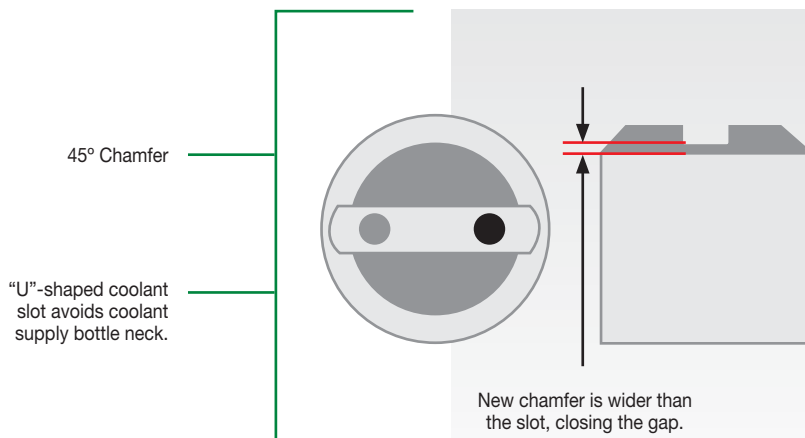

New standard back end fulfills the requirements of DIN 6535 and 69090-03 for variable use of internal coolant or MQL.

VariDrill • 3 x D • VDS201A / VDS401A • A-Shank

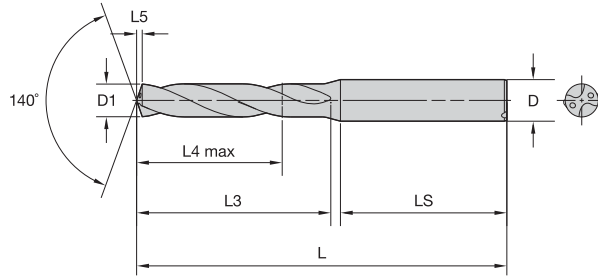

For information on L, L3, and L4 max, see page C29.

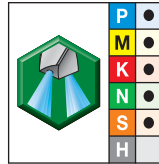
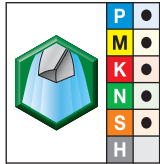

● first choice
○ alternate choice

grade WU25PD TiAlN		grade WU25PD TiAlN		D1 diameter		L4 max	L3	L5	L	LS	D
order #	catalogue #	order #	catalogue #	mm	in						
4144195	VDS201A01000	-	-	1,000	.0394	5	7	0,2	58	28	4
4144196	VDS201A01016	-	-	1,016	.0400	5	7	0,1	58	28	4
4144197	VDS201A01041	-	-	1,041	.0410	5	7	0,2	58	28	4
4144198	VDS201A01067	-	-	1,067	.0420	5	7	0,2	58	28	4
4144199	VDS201A01092	-	-	1,092	.0430	5	7	0,2	58	28	4
4144200	VDS201A01100	-	-	1,100	.0433	5	7	0,2	58	28	4
4144201	VDS201A01181	-	-	1,181	.0465	5	7	0,2	58	28	4
4144202	VDS201A01191	-	-	1,191	.0469	5	7	0,2	58	28	4
4144523	VDS201A01200	-	-	1,200	.0472	5	7	0,2	58	28	4
4144524	VDS201A01300	-	-	1,300	.0512	5	7	0,2	58	28	4
4144526	VDS201A01397	-	-	1,397	.0550	5	7	0,2	58	28	4
4144527	VDS201A01400	-	-	1,400	.0551	5	7	0,2	58	28	4
4144528	VDS201A01500	4140270	VDS401A01500	1,500	.0591	6	9	0,2	58	28	4
4144529	VDS201A01600	-	-	1,600	.0630	6	9	0,3	58	28	4
-	-	4140271	VDS401A01600	1,600	.0630	6	9	0,2	58	28	4
4144530	VDS201A01700	4140272	VDS401A01700	1,700	.0669	6	9	0,3	58	28	4
4144531	VDS201A01800	4140423	VDS401A01800	1,800	.0709	6	9	0,3	58	28	4
4144532	VDS201A01900	4140424	VDS401A01900	1,900	.0748	6	9	0,3	58	28	4
4144533	VDS201A01984	4140425	VDS401A01984	1,984	.0781	10	13	0,3	58	28	4
4144534	VDS201A02000	4140426	VDS401A02000	2,000	.0787	10	13	0,3	58	28	4
4144535	VDS201A02100	4140427	VDS401A02100	2,100	.0827	10	13	0,3	58	28	4
4144536	VDS201A02200	4140428	VDS401A02200	2,200	.0866	10	13	0,3	58	28	4
4144537	VDS201A02300	4140429	VDS401A02300	2,300	.0906	10	13	0,4	58	28	4
4144538	VDS201A02383	4140430	VDS401A02383	2,383	.0938	12	17	0,4	58	28	4
4144539	VDS201A02400	4140431	VDS401A02400	2,400	.0945	12	17	0,4	58	28	4
4144540	VDS201A02439	4140432	VDS401A02439	2,439	.0960	12	17	0,4	58	28	4
4144541	VDS201A02489	4140433	VDS401A02489	2,489	.0980	12	17	0,4	58	28	4
4144542	VDS201A02500	4140434	VDS401A02500	2,500	.0984	12	17	0,4	58	28	4
4144543	VDS201A02578	4140435	VDS401A02578	2,578	.1015	12	17	0,4	58	28	4
4144544	VDS201A02600	4140436	VDS401A02600	2,600	.1024	12	17	0,4	58	28	4
4144545	VDS201A02642	4140437	VDS401A02642	2,642	.1040	12	17	0,4	58	28	4
4144546	VDS201A02700	4140438	VDS401A02700	2,700	.1063	12	17	0,4	58	28	4
4144547	VDS201A02705	4140439	VDS401A02705	2,705	.1065	12	17	0,4	58	28	4
4144548	VDS201A02779	4140440	VDS401A02779	2,779	.1094	12	17	0,4	58	28	4
4144549	VDS201A02800	4140441	VDS401A02800	2,800	.1102	12	17	0,5	58	28	4
4144550	VDS201A02820	4140442	VDS401A02820	2,820	.1110	12	17	0,5	58	28	4
4144551	VDS201A02870	4140443	VDS401A02870	2,870	.1130	12	17	0,5	58	28	4
4144552	VDS201A02900	4140444	VDS401A02900	2,900	.1142	12	17	0,5	58	28	4
4144553	VDS201A02947	4140445	VDS401A02947	2,947	.1160	12	17	0,5	58	28	4
4143907	VDS201A03000	4140299	VDS401A03000	3,000	.1181	14	20	0,5	62	36	6
4143908	VDS201A03048	4140300	VDS401A03048	3,048	.1200	14	20	0,5	62	36	6
4143909	VDS201A03100	4140301	VDS401A03100	3,100	.1220	14	20	0,5	62	36	6
4143910	VDS201A03175	4140302	VDS401A03175	3,175	.1250	14	20	0,5	62	36	6
4143911	VDS201A03200	4140303	VDS401A03200	3,200	.1260	14	20	0,5	62	36	6
4143912	VDS201A03264	4140304	VDS401A03264	3,264	.1285	14	20	0,5	62	36	6
4143913	VDS201A03300	4140305	VDS401A03300	3,300	.1299	14	20	0,5	62	36	6
4143914	VDS201A03400	4140306	VDS401A03400	3,400	.1339	14	20	0,5	62	36	6
4143915	VDS201A03455	4140307	VDS401A03455	3,455	.1360	14	20	0,6	62	36	6
4143916	VDS201A03500	4140308	VDS401A03500	3,500	.1378	14	20	0,6	62	36	6
4143917	VDS201A03571	4140309	VDS401A03571	3,571	.1406	14	20	0,6	62	36	6
4143918	VDS201A03600	4140310	VDS401A03600	3,600	.1417	14	20	0,6	62	36	6
4143919	VDS201A03658	4140311	VDS401A03658	3,658	.1440	14	20	0,6	62	36	6

VariDrill • 3 x D • VDS201A / VDS401A • A-Shank

(continued)

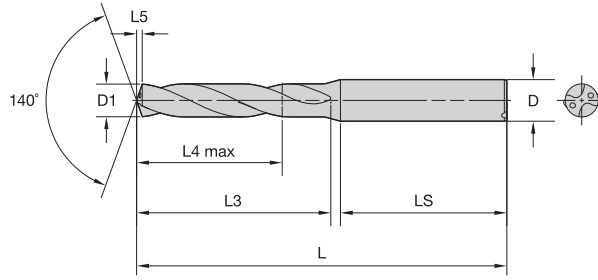

For information on L, L3, and L4 max, see page C29.

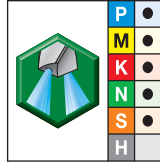
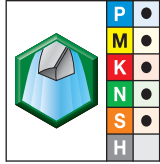

● first choice
○ alternate choice

grade WU25PD TiAlN		grade WU25PD TiAlN		D1 diameter		L4 max	L3	L5	L	LS	D
order #	catalogue #	order #	catalogue #	mm	in						
4143920	VDS201A03700	4140312	VDS401A03700	3,700	.1457	14	20	0,6	62	36	6
4143921	VDS201A03734	4140313	VDS401A03734	3,734	.1470	14	20	0,6	62	36	6
4143922	VDS201A03800	4140314	VDS401A03800	3,800	.1496	17	24	0,6	66	36	6
4143923	VDS201A03900	4140315	VDS401A03900	3,900	.1535	17	24	0,6	66	36	6
4143924	VDS201A03970	4140316	VDS401A03970	3,970	.1563	17	24	0,7	66	36	6
4143925	VDS201A04000	4140317	VDS401A04000	4,000	.1575	17	24	0,7	66	36	6
4143926	VDS201A04039	4140318	VDS401A04039	4,039	.1590	17	24	0,7	66	36	6
4143927	VDS201A04090	4140319	VDS401A04090	4,090	.1610	17	24	0,7	66	36	6
4143928	VDS201A04100	4140320	VDS401A04100	4,100	.1614	17	24	0,7	66	36	6
4143929	VDS201A04200	4140321	VDS401A04200	4,200	.1654	17	24	0,7	66	36	6
4143930	VDS201A04217	-	-	4,217	.1660	17	24	0,7	66	36	6
4143931	VDS201A04300	4140323	VDS401A04300	4,300	.1693	17	24	0,7	66	36	6
4143932	VDS201A04366	4140324	VDS401A04366	4,366	.1719	17	24	0,7	66	36	6
4143933	VDS201A04400	4140325	VDS401A04400	4,400	.1732	17	24	0,7	66	36	6
4143934	VDS201A04500	4140326	VDS401A04500	4,500	.1772	17	24	0,7	66	36	6
4143935	VDS201A04600	4140328	VDS401A04600	4,600	.1811	17	24	0,8	66	36	6
4143936	VDS201A04623	4140329	VDS401A04623	4,623	.1820	17	24	0,8	66	36	6
4143937	VDS201A04700	4140330	VDS401A04700	4,700	.1850	17	24	0,8	66	36	6
4143938	VDS201A04763	4140331	VDS401A04763	4,763	.1875	20	28	0,8	66	36	6
4143939	VDS201A04800	4140332	VDS401A04800	4,800	.1890	20	28	0,8	66	36	6
4143940	VDS201A04852	4140333	VDS401A04852	4,852	.1910	20	28	0,8	66	36	6
4143941	VDS201A04900	4140334	VDS401A04900	4,900	.1929	20	28	0,8	66	36	6
4143942	VDS201A05000	4140335	VDS401A05000	5,000	.1969	20	28	0,8	66	36	6
4143943	VDS201A05100	4140336	VDS401A05100	5,100	.2008	20	28	0,9	66	36	6
4143944	VDS201A05106	4140337	VDS401A05106	5,106	.2010	20	28	0,9	66	36	6
4143945	VDS201A05159	4140338	VDS401A05159	5,159	.2031	20	28	0,9	66	36	6
4143946	VDS201A05200	4140339	VDS401A05200	5,200	.2047	20	28	0,9	66	36	6
4143947	VDS201A05300	4140340	VDS401A05300	5,300	.2087	20	28	0,9	66	36	6
4143948	VDS201A05400	4140341	VDS401A05400	5,400	.2126	20	28	0,9	66	36	6
4143949	VDS201A05410	4140342	VDS401A05410	5,410	.2130	20	28	0,9	66	36	6
4143950	VDS201A05500	4140343	VDS401A05500	5,500	.2165	20	28	0,9	66	36	6
4143951	VDS201A05558	4140344	VDS401A05558	5,558	.2188	20	28	0,9	66	36	6
4143952	VDS201A05600	4140345	VDS401A05600	5,600	.2205	20	28	0,9	66	36	6
4143953	VDS201A05616	4140346	VDS401A05616	5,616	.2211	20	28	0,9	66	36	6
4143954	VDS201A05700	4140347	VDS401A05700	5,700	.2244	20	28	1,0	66	36	6
4143955	VDS201A05800	4140348	VDS401A05800	5,800	.2283	20	28	1,0	66	36	6
4143956	VDS201A05900	4140349	VDS401A05900	5,900	.2323	20	28	1,0	66	36	6
4143957	VDS201A05954	4140350	VDS401A05954	5,954	.2344	20	28	1,0	66	36	6
4143958	VDS201A06000	4140351	VDS401A06000	6,000	.2362	20	28	1,0	66	36	6
4143959	VDS201A06100	4140352	VDS401A06100	6,100	.2402	24	34	1,0	79	36	8
4143960	VDS201A06200	4140353	VDS401A06200	6,200	.2441	24	34	1,0	79	36	8
4143961	VDS201A06300	4140354	VDS401A06300	6,300	.2480	24	34	1,1	79	36	8
4143962	VDS201A06350	4140355	VDS401A06350	6,350	.2500	24	34	1,1	79	36	8
4143963	VDS201A06400	4140356	VDS401A06400	6,400	.2520	24	34	1,1	79	36	8
4143964	VDS201A06500	4140357	VDS401A06500	6,500	.2559	24	34	1,1	79	36	8
4143965	VDS201A06528	4140358	VDS401A06528	6,528	.2570	24	34	1,1	79	36	8
4143966	VDS201A06600	4140359	VDS401A06600	6,600	.2598	24	34	1,1	79	36	8
4143967	VDS201A06630	4140360	VDS401A06630	6,630	.2610	24	34	1,1	79	36	8
4143968	VDS201A06700	4140361	VDS401A06700	6,700	.2638	24	34	1,1	79	36	8
4143969	VDS201A06746	4140362	VDS401A06746	6,746	.2656	24	34	1,1	79	36	8
4143970	VDS201A06800	4140363	VDS401A06800	6,800	.2677	24	34	1,1	79	36	8
4143971	VDS201A06900	4140364	VDS401A06900	6,900	.2717	24	34	1,2	79	36	8

INDEXABLE MILLING

SOLID END MILLING

HOLEMAKING

TAPPING

TURNING

VariDrill • 3 x D • VDS201A / VDS401A • A-Shank

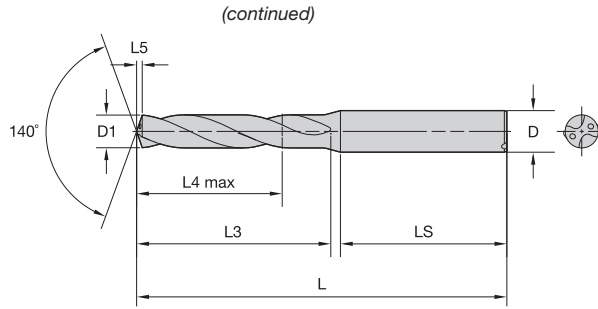

For information on L, L3, and L4 max, see page C29.

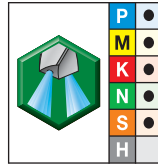
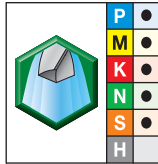

● first choice
○ alternate choice

grade WU25PD TiAlN		grade WU25PD TiAlN		D1 diameter		L4 max	L3	L5	L	LS	D
order #	catalogue #	order #	catalogue #	mm	in						
4143972	VDS201A07000	4140365	VDS401A07000	7,000	.2756	24	34	1,2	79	36	8
4143973	VDS201A07100	4140366	VDS401A07100	7,100	.2795	29	41	1,2	79	36	8
4143974	VDS201A07145	4140367	VDS401A07145	7,145	.2813	29	41	1,2	79	36	8
4143975	VDS201A07200	4140368	VDS401A07200	7,200	.2835	29	41	1,2	79	36	8
4143976	VDS201A07300	4140369	VDS401A07300	7,300	.2874	29	41	1,2	79	36	8
4143977	VDS201A07400	4140370	VDS401A07400	7,400	.2913	29	41	1,3	79	36	8
4143978	VDS201A07500	4140371	VDS401A07500	7,500	.2953	29	41	1,3	79	36	8
4143979	VDS201A07541	4140372	VDS401A07541	7,541	.2969	29	41	1,3	79	36	8
4143980	VDS201A07600	4140373	VDS401A07600	7,600	.2992	29	41	1,3	79	36	8
4143981	VDS201A07700	4140374	VDS401A07700	7,700	.3031	29	41	1,3	79	36	8
4143982	VDS201A07800	4140375	VDS401A07800	7,800	.3071	29	41	1,3	79	36	8
4143983	VDS201A07900	4140376	VDS401A07900	7,900	.3110	29	41	1,3	79	36	8
4143984	VDS201A07938	4140377	VDS401A07938	7,938	.3125	29	41	1,3	79	36	8
4143985	VDS201A08000	4140378	VDS401A08000	8,000	.3150	29	41	1,4	79	36	8
4143986	VDS201A08100	4140379	VDS401A08100	8,100	.3189	35	47	1,4	89	40	10
4143987	VDS201A08200	4140380	VDS401A08200	8,200	.3228	35	47	1,4	89	40	10
4143988	VDS201A08300	4140381	VDS401A08300	8,300	.3268	35	47	1,4	89	40	10
4143989	VDS201A08334	4140382	VDS401A08334	8,334	.3281	35	47	1,4	89	40	10
4143990	VDS201A08400	4140383	VDS401A08400	8,400	.3307	35	47	1,4	89	40	10
4143991	VDS201A08433	4140384	VDS401A08433	8,433	.3320	35	47	1,4	89	40	10
4143992	VDS201A08500	4140385	VDS401A08500	8,500	.3346	35	47	1,4	89	40	10
4143993	VDS201A08600	4140386	VDS401A08600	8,600	.3386	35	47	1,5	89	40	10
4143994	VDS201A08700	4140387	VDS401A08700	8,700	.3425	35	47	1,5	89	40	10
4143995	VDS201A08733	4140388	VDS401A08733	8,733	.3438	35	47	1,5	89	40	10
4143996	VDS201A08800	4140389	VDS401A08800	8,800	.3465	35	47	1,5	89	40	10
4143997	VDS201A08900	4140390	VDS401A08900	8,900	.3504	35	47	1,5	89	40	10
4143998	VDS201A09000	4140391	VDS401A09000	9,000	.3543	35	47	1,5	89	40	10
4143999	VDS201A09100	-	-	9,100	.3583	35	47	1,5	89	40	10
-	-	4140392	VDS401A09100	9,100	.3583	35	47	1,6	89	40	10
4144000	VDS201A09129	4140393	VDS401A09129	9,129	.3594	35	47	1,6	89	40	10
4144001	VDS201A09200	4140394	VDS401A09200	9,200	.3622	35	47	1,6	89	40	10
4144002	VDS201A09300	4140395	VDS401A09300	9,300	.3661	35	47	1,6	89	40	10
4144003	VDS201A09347	4140396	VDS401A09347	9,347	.3680	35	47	1,6	89	40	10
4144004	VDS201A09400	4140397	VDS401A09400	9,400	.3701	35	47	1,6	89	40	10
4144005	VDS201A09500	4140398	VDS401A09500	9,500	.3740	35	47	1,6	89	40	10
4144006	VDS201A09525	4140399	VDS401A09525	9,525	.3750	35	47	1,6	89	40	10
4144007	VDS201A09600	4140400	VDS401A09600	9,600	.3780	35	47	1,6	89	40	10
4144008	VDS201A09700	4140401	VDS401A09700	9,700	.3819	35	47	1,7	89	40	10
4144009	VDS201A09800	4140402	VDS401A09800	9,800	.3858	35	47	1,7	89	40	10
4144010	VDS201A09900	4140403	VDS401A09900	9,900	.3898	35	47	1,7	89	40	10
4144011	VDS201A09921	4140404	VDS401A09921	9,921	.3906	35	47	1,7	89	40	10
4144172	VDS201A10000	4140001	VDS401A10000	10,000	.3937	35	47	1,7	89	40	10
4144423	VDS201A10100	4140002	VDS401A10100	10,100	.3976	40	55	1,7	102	45	12
4144424	VDS201A10200	4140163	VDS401A10200	10,200	.4016	40	55	1,7	102	45	12
4144425	VDS201A10300	4140164	VDS401A10300	10,300	.4055	40	55	1,8	102	45	12
4144426	VDS201A10320	4140165	VDS401A10320	10,320	.4063	40	55	1,8	102	45	12
4144427	VDS201A10400	4140166	VDS401A10400	10,400	.4094	40	55	1,8	102	45	12
4144428	VDS201A10500	4140167	VDS401A10500	10,500	.4134	40	55	1,8	102	45	12
4144429	VDS201A10600	4140168	VDS401A10600	10,600	.4173	40	55	1,8	102	45	12
4144430	VDS201A10700	4140169	VDS401A10700	10,700	.4213	40	55	1,8	102	45	12
4144431	VDS201A10716	4140170	VDS401A10716	10,716	.4219	40	55	1,8	102	45	12
4144432	VDS201A10800	4140171	VDS401A10800	10,800	.4252	40	55	1,9	102	45	12

VariDrill • 3 x D • VDS201A / VDS401A • A-Shank

(continued)

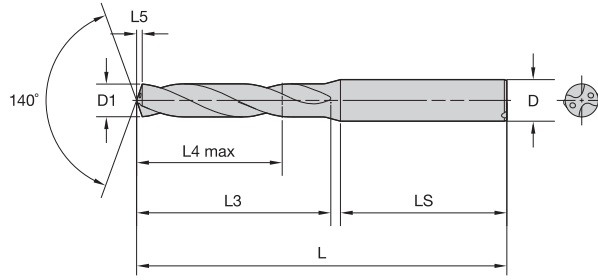

For information on L, L3, and L4 max, see page C29.

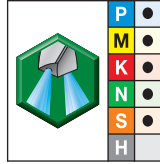
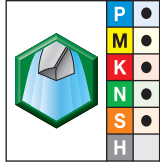

● first choice
○ alternate choice

grade WU25PD TiAlN		grade WU25PD TiAlN		D1 diameter		L4 max	L3	L5	L	LS	D
order #	catalogue #	order #	catalogue #	mm	in						
4144433	VDS201A10900	4140172	VDS401A10900	10,900	.4291	40	55	1,9	102	45	12
4144434	VDS201A11000	4140173	VDS401A11000	11,000	.4331	40	55	1,9	102	45	12
4144435	VDS201A11100	4140174	VDS401A11100	11,100	.4370	40	55	1,9	102	45	12
4144436	VDS201A11113	4140175	VDS401A11113	11,113	.4375	40	55	1,9	102	45	12
4144437	VDS201A11200	4140176	VDS401A11200	11,200	.4409	40	55	1,9	102	45	12
4144438	VDS201A11300	4140177	VDS401A11300	11,300	.4449	40	55	1,9	102	45	12
4144439	VDS201A11400	4140178	VDS401A11400	11,400	.4488	40	55	2,0	102	45	12
4144440	VDS201A11500	4140179	VDS401A11500	11,500	.4528	40	55	2,0	102	45	12
4144441	VDS201A11509	4140180	VDS401A11509	11,509	.4531	40	55	2,0	102	45	12
4144442	VDS201A11600	4140181	VDS401A11600	11,600	.4567	40	55	2,0	102	45	12
4144443	VDS201A11700	4140182	VDS401A11700	11,700	.4606	40	55	2,0	102	45	12
4144444	VDS201A11800	4140183	VDS401A11800	11,800	.4646	40	55	2,0	102	45	12
4144445	VDS201A11900	4140184	VDS401A11900	11,900	.4685	40	55	2,0	102	45	12
4144446	VDS201A11908	4140185	VDS401A11908	11,908	.4688	40	55	2,0	102	45	12
4144447	VDS201A12000	4140186	VDS401A12000	12,000	.4724	40	55	2,1	102	45	12
4144448	VDS201A12100	4140187	VDS401A12100	12,100	.4764	43	60	2,1	107	45	14
4144449	VDS201A12200	4140188	VDS401A12200	12,200	.4803	43	60	2,1	107	45	14
4144450	VDS201A12300	4140189	VDS401A12300	12,300	.4843	43	60	2,1	107	45	14
4144451	VDS201A12304	4140190	VDS401A12304	12,304	.4844	43	60	2,1	107	45	14
4144452	VDS201A12400	4140191	VDS401A12400	12,400	.4882	43	60	2,1	107	45	14
4144453	VDS201A12500	4140192	VDS401A12500	12,500	.4921	43	60	2,2	107	45	14
4144454	VDS201A12600	4140194	VDS401A12600	12,600	.4961	43	60	2,2	107	45	14
4144455	VDS201A12700	4140195	VDS401A12700	12,700	.5000	43	60	2,2	107	45	14
4144456	VDS201A12800	4140196	VDS401A12800	12,800	.5039	43	60	2,2	107	45	14
4144457	VDS201A12900	4140197	VDS401A12900	12,900	.5079	43	60	2,2	107	45	14
4144458	VDS201A13000	4140198	VDS401A13000	13,000	.5118	43	60	2,2	107	45	14
4144459	VDS201A13096	4140199	VDS401A13096	13,096	.5156	43	60	2,3	107	45	14
4144460	VDS201A13100	4140200	VDS401A13100	13,100	.5157	43	60	2,3	107	45	14
4144461	VDS201A13200	4140201	VDS401A13200	13,200	.5197	43	60	2,3	107	45	14
4144462	VDS201A13300	4140202	VDS401A13300	13,300	.5236	43	60	2,3	107	45	14
4144463	VDS201A13400	4140203	VDS401A13400	13,400	.5276	43	60	2,3	107	45	14
4144464	VDS201A13500	4140204	VDS401A13500	13,500	.5315	43	60	2,3	107	45	14
4144465	VDS201A13600	4140205	VDS401A13600	13,600	.5354	43	60	2,3	107	45	14
4144466	VDS201A13700	4140206	VDS401A13700	13,700	.5394	43	60	2,4	107	45	14
4144467	VDS201A13800	4140207	VDS401A13800	13,800	.5433	43	60	2,4	107	45	14
4144468	VDS201A13891	-	-	13,891	.5469	43	60	2,4	107	45	14
4144469	VDS201A13900	4140209	VDS401A13900	13,900	.5472	43	60	2,4	107	45	14
4144470	VDS201A14000	4140210	VDS401A14000	14,000	.5512	43	60	2,4	107	45	14
4144471	VDS201A14100	4140211	VDS401A14100	14,100	.5551	45	65	2,4	115	48	16
4144472	VDS201A14200	4140212	VDS401A14200	14,200	.5591	45	65	2,5	115	48	16
4144473	VDS201A14288	4140213	VDS401A14288	14,288	.5625	45	65	2,5	115	48	16
4144474	VDS201A14300	4140214	VDS401A14300	14,300	.5630	45	65	2,5	115	48	16
4144475	VDS201A14400	4140215	VDS401A14400	14,400	.5669	45	65	2,5	115	48	16
4144476	VDS201A14500	4140216	VDS401A14500	14,500	.5709	45	65	2,5	115	48	16
4144477	VDS201A14600	4140217	VDS401A14600	14,600	.5748	45	65	2,5	115	48	16
4144478	VDS201A14684	4140218	VDS401A14684	14,684	.5781	45	65	2,5	115	48	16
4144479	VDS201A14700	4140219	VDS401A14700	14,700	.5787	45	65	2,5	115	48	16
4144480	VDS201A14800	4140220	VDS401A14800	14,800	.5827	45	65	2,6	115	48	16
4144481	VDS201A14900	4140221	VDS401A14900	14,900	.5866	45	65	2,6	115	48	16
4144482	VDS201A15000	4140222	VDS401A15000	15,000	.5906	45	65	2,6	115	48	16
4144483	VDS201A15083	4140223	VDS401A15083	15,083	.5938	45	65	2,6	115	48	16
4144484	VDS201A15100	4140224	VDS401A15100	15,100	.5945	45	65	2,6	115	48	16

VariDrill • 3 x D • VDS201A / VDS401A • A-Shank

(continued)

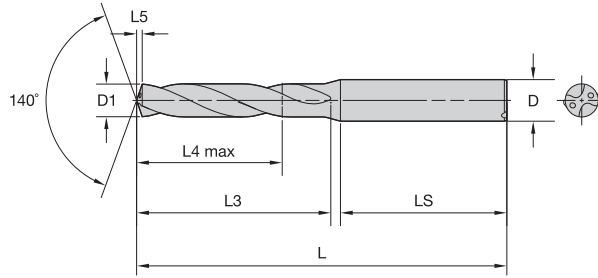

For information on L, L3, and L4 max, see page C29.

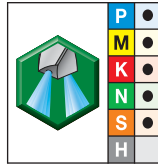

● first choice
○ alternate choice

grade WU25PD TiAlN		grade WU25PD TiAlN		D1 diameter		L4 max	L3	L5	L	LS	D
order #	catalogue #	order #	catalogue #	mm	in						
4144485	VDS201A15200	4140225	VDS401A15200	15,200	.5984	45	65	2,6	115	48	16
4144486	VDS201A15300	4140226	VDS401A15300	15,300	.6024	45	65	2,6	115	48	16
4144487	VDS201A15400	4140227	VDS401A15400	15,400	.6063	45	65	2,7	115	48	16
4144488	VDS201A15479	4140228	VDS401A15479	15,479	.6094	45	65	2,7	115	48	16
4144489	VDS201A15500	4140229	VDS401A15500	15,500	.6102	45	65	2,7	115	48	16
4144490	VDS201A15600	4140230	VDS401A15600	15,600	.6142	45	65	2,7	115	48	16
4144491	VDS201A15700	4140231	VDS401A15700	15,700	.6181	45	65	2,7	115	48	16
4144492	VDS201A15800	4140232	VDS401A15800	15,800	.6220	45	65	2,7	115	48	16
4144493	VDS201A15875	4140233	VDS401A15875	15,875	.6250	45	65	2,8	115	48	16
4144494	VDS201A15900	4140234	VDS401A15900	15,900	.6260	45	65	2,8	115	48	16
4144495	VDS201A16000	4140235	VDS401A16000	16,000	.6299	45	65	2,8	115	48	16
4144496	VDS201A16100	4140236	VDS401A16100	16,100	.6339	51	73	2,8	123	48	18
4144497	VDS201A16200	4140237	VDS401A16200	16,200	.6378	51	73	2,8	123	48	18
4144498	VDS201A16271	-	-	16,271	.6406	51	73	2,8	123	48	18
4144499	VDS201A16300	4140239	VDS401A16300	16,300	.6417	51	73	2,8	123	48	18
4144500	VDS201A16400	4140241	VDS401A16400	16,400	.6457	51	73	2,8	123	48	18
4144501	VDS201A16500	4140242	VDS401A16500	16,500	.6496	51	73	2,9	123	48	18
4144503	VDS201A16600	4140243	VDS401A16600	16,600	.6535	51	73	2,9	123	48	18
4144504	VDS201A16670	4140244	VDS401A16670	16,670	.6563	51	73	2,9	123	48	18
4144505	VDS201A16700	4140245	VDS401A16700	16,700	.6575	51	73	2,9	123	48	18
4144506	VDS201A16800	4140246	VDS401A16800	16,800	.6614	51	73	2,9	123	48	18
4144507	VDS201A16900	4140247	VDS401A16900	16,900	.6654	51	73	2,9	123	48	18
4144508	VDS201A17000	-	-	17,000	.6693	51	73	3,0	123	48	18
-	-	4140248	VDS401A17000	17,000	.6693	51	73	2,9	123	48	18
4144509	VDS201A17100	4140249	VDS401A17100	17,100	.6732	51	73	3,0	123	48	18
4144510	VDS201A17200	4140250	VDS401A17200	17,200	.6772	51	73	3,0	123	48	18
4144511	VDS201A17300	4140251	VDS401A17300	17,300	.6811	51	73	3,0	123	48	18
4144512	VDS201A17400	4140252	VDS401A17400	17,400	.6850	51	73	3,0	123	48	18
4144513	VDS201A17463	4140253	VDS401A17463	17,463	.6875	51	73	3,0	123	48	18
4144514	VDS201A17500	4140254	VDS401A17500	17,500	.6890	51	73	3,0	123	48	18
4144515	VDS201A17600	4140255	VDS401A17600	17,600	.6929	51	73	3,1	123	48	18
4144516	VDS201A17700	4140256	VDS401A17700	17,700	.6969	51	73	3,1	123	48	18
4144517	VDS201A17800	4140257	VDS401A17800	17,800	.7008	51	73	3,1	123	48	18
4144518	VDS201A17859	-	-	17,859	.7031	51	73	3,1	123	48	18
4144519	VDS201A17900	-	-	17,900	.7047	51	73	3,1	123	48	18
4144590	VDS201A18000	4140449	VDS401A18000	18,000	.7087	51	73	3,1	123	48	18
4144591	VDS201A18100	4140450	VDS401A18100	18,100	.7126	55	79	3,1	131	50	20
4144592	VDS201A18200	4140451	VDS401A18200	18,200	.7165	55	79	3,2	131	50	20
4144593	VDS201A18258	4140452	VDS401A18258	18,258	.7188	55	79	3,2	131	50	20
4144594	VDS201A18300	4140463	VDS401A18300	18,300	.7205	55	79	3,2	131	50	20
-	-	4140464	VDS401A18400	18,400	.7244	55	79	3,2	131	50	20
4144596	VDS201A18500	4140465	VDS401A18500	18,500	.7283	55	79	3,2	131	50	20
4144597	VDS201A18600	4140466	VDS401A18600	18,600	.7323	55	79	3,2	131	50	20
4144598	VDS201A18654	4140467	VDS401A18654	18,654	.7344	55	79	3,2	131	50	20
4144599	VDS201A18700	-	-	18,700	.7362	55	79	3,3	131	50	20
-	-	4140468	VDS401A18700	18,700	.7362	55	79	3,2	131	50	20
4144600	VDS201A18800	4140469	VDS401A18800	18,800	.7402	55	79	3,3	131	50	20
4144601	VDS201A18900	4140470	VDS401A18900	18,900	.7441	55	79	3,3	131	50	20
4144602	VDS201A19000	4140471	VDS401A19000	19,000	.7480	55	79	3,3	131	50	20
4144603	VDS201A19050	4140472	VDS401A19050	19,050	.7500	55	79	3,3	131	50	20
4144604	VDS201A19100	4140473	VDS401A19100	19,100	.7520	55	79	3,3	131	50	20
4144605	VDS201A19200	4140474	VDS401A19200	19,200	.7559	55	79	3,3	131	50	20

VariDrill • 3 x D • VDS201A / VDS401A • A-Shank

(continued)

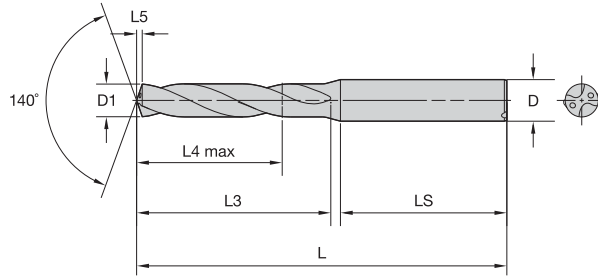

For information on L, L3, and L4 max, see page C29.

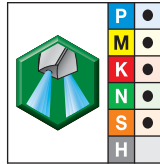
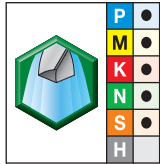

● first choice
○ alternate choice

grade WU25PD TiAlN		grade WU401A TiAlN		D1 diameter		L4 max	L3	L5	L	LS	D
order #	catalogue #	order #	catalogue #	mm	in						
4144606	VDS201A19300	4140475	VDS401A19300	19,300	.7598	55	79	3,4	131	50	20
4144607	VDS201A19400	4140476	VDS401A19400	19,400	.7638	55	79	3,4	131	50	20
4144608	VDS201A19500	4140477	VDS401A19500	19,500	.7677	55	79	3,4	131	50	20
-	-	4140478	VDS401A19600	19,600	.7717	55	79	3,4	131	50	20
4144610	VDS201A19700	4140479	VDS401A19700	19,700	.7756	55	79	3,4	131	50	20
4144611	VDS201A19800	4140480	VDS401A19800	19,800	.7795	55	79	3,4	131	50	20
4144612	VDS201A19900	4140481	VDS401A19900	19,900	.7835	55	79	3,5	131	50	20
4144613	VDS201A20000	4140482	VDS401A20000	20,000	.7874	55	79	3,5	131	50	20

INDEXABLE MILLING

SOLID END MILLING

HOLEMAKING

TAPPING

TURNING

VariDrill • 5 x D • VDS202A / VDS402A • A-Shank

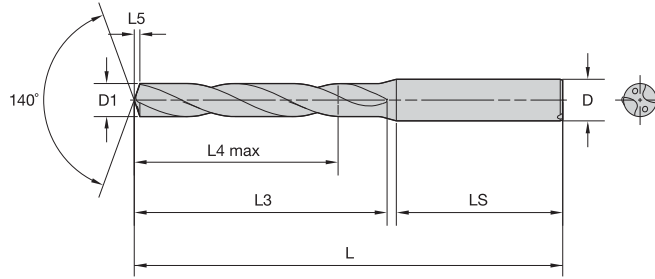

For information on L, L3, and L4 max, see page C29.

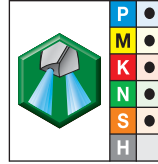
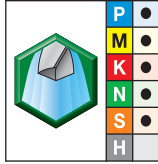

● first choice
○ alternate choice

grade WU25PD TiAlN		grade WU25PD TiAlN		D1 diameter		L4 max	L3	L5	L	LS	D
order #	catalogue #	order #	catalogue #	mm	in						
4148000	VDS202A01000	-	-	1,000	.0394	6	9	0,1	58	28	4
4148001	VDS202A01016	-	-	1,016	.0400	6	9	0,1	58	28	4
4148002	VDS202A01041	-	-	1,041	.0410	6	9	0,2	58	28	4
4148003	VDS202A01067	-	-	1,067	.0420	6	9	0,2	58	28	4
4148005	VDS202A01100	-	-	1,100	.0433	6	9	0,2	58	28	4
4148006	VDS202A01181	-	-	1,181	.0465	6	9	0,2	58	28	4
4148007	VDS202A01191	-	-	1,191	.0469	6	9	0,2	58	28	4
4148008	VDS202A01200	-	-	1,200	.0472	6	9	0,2	58	28	4
4148009	VDS202A01300	-	-	1,300	.0512	6	9	0,2	58	28	4
4148010	VDS202A01321	-	-	1,321	.0520	6	9	0,2	58	28	4
4148011	VDS202A01397	-	-	1,397	.0550	6	9	0,2	58	28	4
4148012	VDS202A01400	-	-	1,400	.0551	6	9	0,2	58	28	4
4148013	VDS202A01500	4142871	VDS402A01500	1,500	.0591	9	12	0,2	58	28	4
4148014	VDS202A01600	4142884	VDS402A01600	1,600	.0630	9	12	0,2	58	28	4
4148015	VDS202A01700	4142887	VDS402A01700	1,700	.0669	9	12	0,3	58	28	4
4148016	VDS202A01800	4142890	VDS402A01800	1,800	.0709	9	12	0,3	58	28	4
4148017	VDS202A01900	4142893	VDS402A01900	1,900	.0748	9	12	0,3	58	28	4
4148018	VDS202A01984	4142896	VDS402A01984	1,984	.0781	14	18	0,3	58	28	4
4148019	VDS202A02000	4142899	VDS402A02000	2,000	.0787	14	18	0,3	58	28	4
4148020	VDS202A02100	4142902	VDS402A02100	2,100	.0827	14	18	0,3	58	28	4
4148021	VDS202A02200	4142905	VDS402A02200	2,200	.0866	14	18	0,3	58	28	4
4148022	VDS202A02300	4142908	VDS402A02300	2,300	.0906	14	18	0,4	58	28	4
4148023	VDS202A02383	4142911	VDS402A02383	2,383	.0938	17	22	0,4	58	28	4
4148024	VDS202A02400	4142924	VDS402A02400	2,400	.0945	17	22	0,4	58	28	4
4148025	VDS202A02439	4142927	VDS402A02439	2,439	.0960	17	22	0,4	58	28	4
4148026	VDS202A02489	4142930	VDS402A02489	2,489	.0980	17	22	0,4	58	28	4
4148027	VDS202A02500	4142933	VDS402A02500	2,500	.0984	17	22	0,4	58	28	4
4148028	VDS202A02578	4142936	VDS402A02578	2,578	.1015	17	22	0,4	58	28	4
4148029	VDS202A02600	4142939	VDS402A02600	2,600	.1024	17	22	0,4	58	28	4
4148030	VDS202A02642	4142942	VDS402A02642	2,642	.1040	17	22	0,4	58	28	4
4148031	VDS202A02700	4142945	VDS402A02700	2,700	.1063	17	22	0,4	58	28	4
4148032	VDS202A02705	-	-	2,705	.1065	17	22	0,4	58	28	4
4148033	VDS202A02779	4142951	VDS402A02779	2,779	.1094	17	22	0,4	58	28	4
4148034	VDS202A02800	4142964	VDS402A02800	2,800	.1102	17	22	0,5	58	28	4
4148035	VDS202A02820	4142967	VDS402A02820	2,820	.1110	17	22	0,5	58	28	4
4148036	VDS202A02870	4142970	VDS402A02870	2,870	.1130	17	22	0,5	58	28	4
4148037	VDS202A02900	4142973	VDS402A02900	2,900	.1142	17	22	0,5	58	28	4
4148038	VDS202A02947	4142976	VDS402A02947	2,947	.1160	17	22	0,5	58	28	4
4148142	VDS202A03000	4142844	VDS402A03000	3,000	.1181	23	28	0,5	66	36	6
4148143	VDS202A03048	4142846	VDS402A03048	3,048	.1200	23	28	0,5	66	36	6
4148144	VDS202A03100	4142847	VDS402A03100	3,100	.1220	23	28	0,5	66	36	6
4148145	VDS202A03175	4142849	VDS402A03175	3,175	.1250	23	28	0,5	66	36	6
4148146	VDS202A03200	4142851	VDS402A03200	3,200	.1260	23	28	0,5	66	36	6
4148147	VDS202A03264	4142864	VDS402A03264	3,264	.1285	23	28	0,5	66	36	6
4148148	VDS202A03300	4142865	VDS402A03300	3,300	.1299	23	28	0,5	66	36	6
4148149	VDS202A03400	4142867	VDS402A03400	3,400	.1339	23	28	0,6	66	36	6
4148150	VDS202A03455	4142869	VDS402A03455	3,455	.1360	23	28	0,6	66	36	6
4148151	VDS202A03500	4142872	VDS402A03500	3,500	.1378	23	28	0,6	66	36	6
4148152	VDS202A03571	4142885	VDS402A03571	3,571	.1406	23	28	0,6	66	36	6
4148153	VDS202A03600	4142888	VDS402A03600	3,600	.1417	23	28	0,6	66	36	6
4148154	VDS202A03658	4142891	VDS402A03658	3,658	.1440	23	28	0,6	66	36	6
4148155	VDS202A03700	4142894	VDS402A03700	3,700	.1457	23	28	0,6	66	36	6

VariDrill • 5 x D • VDS202A / VDS402A • A-Shank

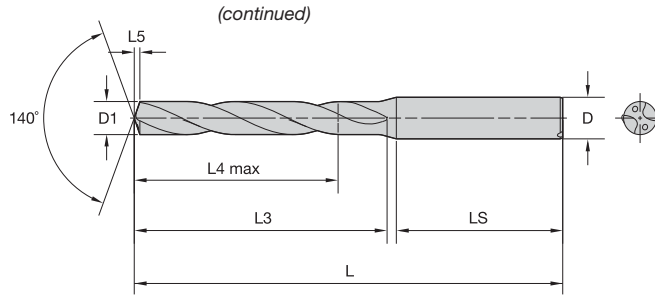

For information on L, L3, and L4 max, see page C29.

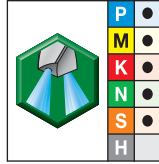
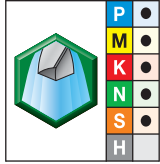

● first choice
○ alternate choice

grade WU25PD TiAlN		grade VDS402A TiAlN		D1 diameter		L4 max	L3	L5	L	LS	D
order #	catalogue #	order #	catalogue #	mm	in						
4148156	VDS202A03734	4142897	VDS402A03734	3,734	.1470	23	28	0,6	66	36	6
4148157	VDS202A03800	4142900	VDS402A03800	3,800	.1496	29	36	0,6	74	36	6
4148158	VDS202A03900	4142903	VDS402A03900	3,900	.1535	29	36	0,6	74	36	6
4148159	VDS202A03970	4142906	VDS402A03970	3,970	.1563	29	36	0,7	74	36	6
4148160	VDS202A04000	4142909	VDS402A04000	4,000	.1575	29	36	0,7	74	36	6
4148161	VDS202A04039	4142912	VDS402A04039	4,039	.1590	29	36	0,7	74	36	6
4148162	VDS202A04090	4142925	VDS402A04090	4,090	.1610	29	36	0,7	74	36	6
4148163	VDS202A04100	4142928	VDS402A04100	4,100	.1614	29	36	0,7	74	36	6
4148164	VDS202A04200	4142931	VDS402A04200	4,200	.1654	29	36	0,7	74	36	6
4148165	VDS202A04217	4142934	VDS402A04217	4,217	.1660	29	36	0,7	74	36	6
4148166	VDS202A04300	4142937	VDS402A04300	4,300	.1693	29	36	0,7	74	36	6
4148167	VDS202A04366	4142940	VDS402A04366	4,366	.1719	29	36	0,7	74	36	6
4148168	VDS202A04400	4142943	VDS402A04400	4,400	.1732	29	36	0,7	74	36	6
4148169	VDS202A04500	4142946	VDS402A04500	4,500	.1772	29	36	0,7	74	36	6
4148170	VDS202A04600	4142949	VDS402A04600	4,600	.1811	29	36	0,8	74	36	6
4148171	VDS202A04623	4142952	VDS402A04623	4,623	.1820	29	36	0,8	74	36	6
4148172	VDS202A04700	4142965	VDS402A04700	4,700	.1850	29	36	0,8	74	36	6
4148173	VDS202A04763	4142968	VDS402A04763	4,763	.1875	35	44	0,8	82	36	6
4148174	VDS202A04800	4142971	VDS402A04800	4,800	.1890	35	44	0,8	82	36	6
4148175	VDS202A04852	4142974	VDS402A04852	4,852	.1910	35	44	0,8	82	36	6
4148176	VDS202A04900	4142977	VDS402A04900	4,900	.1929	35	44	0,8	82	36	6
4148177	VDS202A05000	4142979	VDS402A05000	5,000	.1969	35	44	0,8	82	36	6
4148178	VDS202A05100	4142981	VDS402A05100	5,100	.2008	35	44	0,9	82	36	6
4148179	VDS202A05106	4142994	VDS402A05106	5,106	.2010	35	44	0,9	82	36	6
4148180	VDS202A05159	4142996	VDS402A05159	5,159	.2031	35	44	0,9	82	36	6
4148181	VDS202A05200	4142997	VDS402A05200	5,200	.2047	35	44	0,9	82	36	6
4148182	VDS202A05300	4142999	VDS402A05300	5,300	.2087	35	44	0,9	82	36	6
4148183	VDS202A05400	4143000	VDS402A05400	5,400	.2126	35	44	0,9	82	36	6
4148184	VDS202A05410	4143001	VDS402A05410	5,410	.2130	35	44	0,9	82	36	6
4148185	VDS202A05500	4143002	VDS402A05500	5,500	.2165	35	44	0,9	82	36	6
4148186	VDS202A05558	4143003	VDS402A05558	5,558	.2188	35	44	0,9	82	36	6
4148187	VDS202A05600	4143004	VDS402A05600	5,600	.2205	35	44	0,9	82	36	6
4148188	VDS202A05616	4143005	VDS402A05616	5,616	.2211	35	44	0,9	82	36	6
4148189	VDS202A05700	4143006	VDS402A05700	5,700	.2244	35	44	1,0	82	36	6
4148190	VDS202A05800	4143007	VDS402A05800	5,800	.2283	35	44	1,0	82	36	6
4148191	VDS202A05900	4143008	VDS402A05900	5,900	.2323	35	44	1,0	82	36	6
4148192	VDS202A05954	4143009	VDS402A05954	5,954	.2344	35	44	1,0	82	36	6
4148193	VDS202A06000	4143010	VDS402A06000	6,000	.2362	35	44	1,0	82	36	6
4148194	VDS202A06100	4143011	VDS402A06100	6,100	.2402	43	53	1,0	91	36	8
4148195	VDS202A06200	4143012	VDS402A06200	6,200	.2441	43	53	1,0	91	36	8
4148196	VDS202A06300	4143023	VDS402A06300	6,300	.2480	43	53	1,1	91	36	8
4148197	VDS202A06350	4143024	VDS402A06350	6,350	.2500	43	53	1,1	91	36	8
4148198	VDS202A06400	4143025	VDS402A06400	6,400	.2520	43	53	1,1	91	36	8
4148199	VDS202A06500	4143026	VDS402A06500	6,500	.2559	43	53	1,1	91	36	8
4148200	VDS202A06528	4143027	VDS402A06528	6,528	.2570	43	53	1,1	91	36	8
4148201	VDS202A06600	4143028	VDS402A06600	6,600	.2598	43	53	1,1	91	36	8
4148202	VDS202A06630	4143029	VDS402A06630	6,630	.2610	43	53	1,1	91	36	8
4148203	VDS202A06700	4143030	VDS402A06700	6,700	.2638	43	53	1,1	91	36	8
4148204	VDS202A06746	4143031	VDS402A06746	6,746	.2656	43	53	1,1	91	36	8
4148205	VDS202A06800	4143032	VDS402A06800	6,800	.2677	43	53	1,1	91	36	8
4148206	VDS202A06900	4143043	VDS402A06900	6,900	.2717	43	53	1,2	91	36	8
4148207	VDS202A07000	4143044	VDS402A07000	7,000	.2756	43	53	1,2	91	36	8

VariDrill • 5 x D • VDS202A / VDS402A • A-Shank

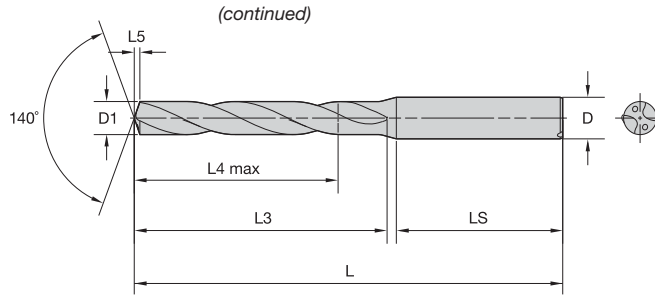

For information on L, L3, and L4 max, see page C29.

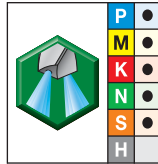
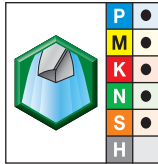

● first choice
○ alternate choice

grade WU25PD TiAlN		grade VDS402A TiAlN		D1 diameter		L4 max	L3	L5	L	LS	D
order #	catalogue #	order #	catalogue #	mm	in						
4148208	VDS202A07100	4143045	VDS402A07100	7,100	.2795	43	53	1,2	91	36	8
4148209	VDS202A07145	4143046	VDS402A07145	7,145	.2813	43	53	1,2	91	36	8
4148210	VDS202A07200	4143047	VDS402A07200	7,200	.2835	43	53	1,2	91	36	8
4148211	VDS202A07300	4143048	VDS402A07300	7,300	.2874	43	53	1,2	91	36	8
4148212	VDS202A07400	4143049	VDS402A07400	7,400	.2913	43	53	1,3	91	36	8
4148213	VDS202A07500	4143050	VDS402A07500	7,500	.2953	43	53	1,3	91	36	8
4148214	VDS202A07541	4143051	VDS402A07541	7,541	.2969	43	53	1,3	91	36	8
4148215	VDS202A07600	4143052	VDS402A07600	7,600	.2992	43	53	1,3	91	36	8
4148216	VDS202A07700	4143063	VDS402A07700	7,700	.3031	43	53	1,3	91	36	8
4148217	VDS202A07800	4143064	VDS402A07800	7,800	.3071	43	53	1,3	91	36	8
4148218	VDS202A07900	4143065	VDS402A07900	7,900	.3110	43	53	1,3	91	36	8
4148219	VDS202A07938	4143066	VDS402A07938	7,938	.3125	43	53	1,3	91	36	8
4148220	VDS202A08000	4143067	VDS402A08000	8,000	.3150	43	53	1,4	91	36	8
4148221	VDS202A08100	4143068	VDS402A08100	8,100	.3189	49	61	1,4	103	40	10
4148222	VDS202A08200	4143069	VDS402A08200	8,200	.3228	49	61	1,4	103	40	10
4148223	VDS202A08300	4143070	VDS402A08300	8,300	.3268	49	61	1,4	103	40	10
4148224	VDS202A08334	4143071	VDS402A08334	8,334	.3281	49	61	1,4	103	40	10
4148225	VDS202A08400	4143072	VDS402A08400	8,400	.3307	49	61	1,4	103	40	10
4148226	VDS202A08433	4143083	VDS402A08433	8,433	.3320	49	61	1,4	103	40	10
4148227	VDS202A08500	4143084	VDS402A08500	8,500	.3346	49	61	1,4	103	40	10
4148228	VDS202A08600	4143085	VDS402A08600	8,600	.3386	49	61	1,5	103	40	10
4148229	VDS202A08700	4143086	VDS402A08700	8,700	.3425	49	61	1,5	103	40	10
4148230	VDS202A08733	4143087	VDS402A08733	8,733	.3438	49	61	1,5	103	40	10
4148231	VDS202A08800	4143088	VDS402A08800	8,800	.3465	49	61	1,5	103	40	10
4148232	VDS202A08900	4143089	VDS402A08900	8,900	.3504	49	61	1,5	103	40	10
4148233	VDS202A09000	4143090	VDS402A09000	9,000	.3543	49	61	1,5	103	40	10
4148234	VDS202A09100	4143091	VDS402A09100	9,100	.3583	49	61	1,6	103	40	10
4148235	VDS202A09129	4143092	VDS402A09129	9,129	.3594	49	61	1,6	103	40	10
4148236	VDS202A09200	4143103	VDS402A09200	9,200	.3622	49	61	1,6	103	40	10
4148237	VDS202A09300	4143104	VDS402A09300	9,300	.3661	49	61	1,6	103	40	10
4148238	VDS202A09347	4143105	VDS402A09347	9,347	.3680	49	61	1,6	103	40	10
4148239	VDS202A09400	4143106	VDS402A09400	9,400	.3701	49	61	1,6	103	40	10
4148240	VDS202A09500	4143107	VDS402A09500	9,500	.3740	49	61	1,6	103	40	10
4148241	VDS202A09525	4143108	VDS402A09525	9,525	.3750	49	61	1,6	103	40	10
4148242	VDS202A09600	4143109	VDS402A09600	9,600	.3780	49	61	1,6	103	40	10
4148243	VDS202A09700	4143110	VDS402A09700	9,700	.3819	49	61	1,7	103	40	10
4148244	VDS202A09800	4143111	VDS402A09800	9,800	.3858	49	61	1,7	103	40	10
4148245	VDS202A09900	4143112	VDS402A09900	9,900	.3898	49	61	1,7	103	40	10
4148246	VDS202A09921	4143113	VDS402A09921	9,921	.3906	49	61	1,7	103	40	10
4148258	VDS202A10000	4142823	VDS402A10000	10,000	.3937	49	61	1,7	103	40	10
4148259	VDS202A10100	4142825	VDS402A10100	10,100	.3976	56	71	1,7	118	45	12
4148260	VDS202A10200	4142827	VDS402A10200	10,200	.4016	56	71	1,7	118	45	12
4148261	VDS202A10300	4142829	VDS402A10300	10,300	.4055	56	71	1,8	118	45	12
4148262	VDS202A10320	4142831	VDS402A10320	10,320	.4063	56	71	1,8	118	45	12
4148283	VDS202A10400	4142832	VDS402A10400	10,400	.4094	56	71	1,8	118	45	12
4148284	VDS202A10500	4142834	VDS402A10500	10,500	.4134	56	71	1,8	118	45	12
4148285	VDS202A10600	4142836	VDS402A10600	10,600	.4173	56	71	1,8	118	45	12
4148286	VDS202A10700	4142838	VDS402A10700	10,700	.4213	56	71	1,8	118	45	12
4148287	VDS202A10716	4142840	VDS402A10716	10,716	.4219	56	71	1,8	118	45	12
4148288	VDS202A10800	4142842	VDS402A10800	10,800	.4252	56	71	1,9	118	45	12
4148289	VDS202A10900	4142855	VDS402A10900	10,900	.4291	56	71	1,9	118	45	12
4148290	VDS202A11000	4142857	VDS402A11000	11,000	.4331	56	71	1,9	118	45	12

VariDrill • 5 x D • VDS202A / VDS402A • A-Shank

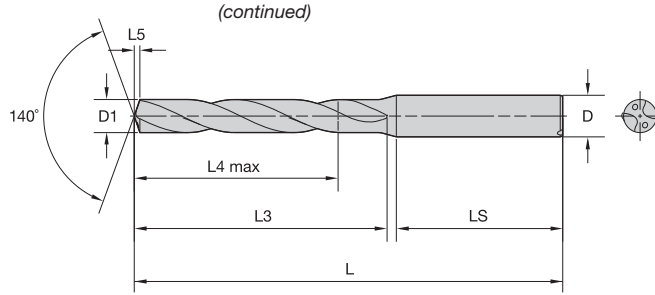

For information on L, L3, and L4 max, see page C29.

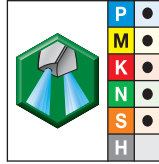
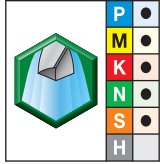

● first choice
○ alternate choice

grade WU25PD TiAlN		grade WU25PD TiAlN		D1 diameter		L4 max	L3	L5	L	LS	D
order #	catalogue #	order #	catalogue #	mm	in						
4148291	VDS202A11100	4142858	VDS402A11100	11,100	.4370	56	71	1,9	118	45	12
4148292	VDS202A11113	4142861	VDS402A11113	11,113	.4375	56	71	1,9	118	45	12
4148293	VDS202A11200	4142862	VDS402A11200	11,200	.4409	56	71	1,9	118	45	12
4148294	VDS202A11300	4142873	VDS402A11300	11,300	.4449	56	71	1,9	118	45	12
4148295	VDS202A11400	4142874	VDS402A11400	11,400	.4488	56	71	2,0	118	45	12
4148296	VDS202A11500	4142875	VDS402A11500	11,500	.4528	56	71	2,0	118	45	12
4148297	VDS202A11509	4142876	VDS402A11509	11,509	.4531	56	71	2,0	118	45	12
4148298	VDS202A11600	4142877	VDS402A11600	11,600	.4567	56	71	2,0	118	45	12
4148299	VDS202A11700	4142878	VDS402A11700	11,700	.4606	56	71	2,0	118	45	12
4148300	VDS202A11800	4142879	VDS402A11800	11,800	.4646	56	71	2,0	118	45	12
4148301	VDS202A11900	4142880	VDS402A11900	11,900	.4685	56	71	2,0	118	45	12
4148302	VDS202A11908	4142881	VDS402A11908	11,908	.4688	56	71	2,0	118	45	12
4148313	VDS202A12000	4142882	VDS402A12000	12,000	.4724	56	71	2,1	118	45	12
4148314	VDS202A12100	4142913	VDS402A12100	12,100	.4764	60	77	2,1	124	45	14
4148315	VDS202A12200	4142914	VDS402A12200	12,200	.4803	60	77	2,1	124	45	14
4148316	VDS202A12300	4142915	VDS402A12300	12,300	.4843	60	77	2,1	124	45	14
4148317	VDS202A12304	4142916	VDS402A12304	12,304	.4844	60	77	2,1	124	45	14
4148318	VDS202A12400	4142917	VDS402A12400	12,400	.4882	60	77	2,1	124	45	14
4148319	VDS202A12500	4142918	VDS402A12500	12,500	.4921	60	77	2,2	124	45	14
4148320	VDS202A12600	4142919	VDS402A12600	12,600	.4961	60	77	2,2	124	45	14
4148321	VDS202A12700	4142920	VDS402A12700	12,700	.5000	60	77	2,2	124	45	14
4148322	VDS202A12800	4142921	VDS402A12800	12,800	.5039	60	77	2,2	124	45	14
4148343	VDS202A12900	4142922	VDS402A12900	12,900	.5079	60	77	2,2	124	45	14
4148344	VDS202A13000	4142953	VDS402A13000	13,000	.5118	60	77	2,2	124	45	14
4148345	VDS202A13096	4142954	VDS402A13096	13,096	.5156	60	77	2,3	124	45	14
4148346	VDS202A13100	4142955	VDS402A13100	13,100	.5157	60	77	2,3	124	45	14
4148347	VDS202A13200	4142956	VDS402A13200	13,200	.5197	60	77	2,3	124	45	14
4148348	VDS202A13300	4142957	VDS402A13300	13,300	.5236	60	77	2,3	124	45	14
4148349	VDS202A13400	4142958	VDS402A13400	13,400	.5276	60	77	2,3	124	45	14
4148350	VDS202A13500	4142959	VDS402A13500	13,500	.5315	60	77	2,3	124	45	14
4148351	VDS202A13600	4142960	VDS402A13600	13,600	.5354	60	77	2,3	124	45	14
4148352	VDS202A13700	4142961	VDS402A13700	13,700	.5394	60	77	2,4	124	45	14
4148353	VDS202A13800	4142962	VDS402A13800	13,800	.5433	60	77	2,4	124	45	14
4148354	VDS202A13891	4142983	VDS402A13891	13,891	.5469	60	77	2,4	124	45	14
4148355	VDS202A13900	4142984	VDS402A13900	13,900	.5472	60	77	2,4	124	45	14
4148356	VDS202A14000	4142985	VDS402A14000	14,000	.5512	60	77	2,4	124	45	14
4148357	VDS202A14100	4142986	VDS402A14100	14,100	.5551	63	83	2,4	133	48	16
4148358	VDS202A14200	4142987	VDS402A14200	14,200	.5591	63	83	2,5	133	48	16
4148359	VDS202A14288	4142988	VDS402A14288	14,288	.5625	63	83	2,5	133	48	16
4148360	VDS202A14300	4142989	VDS402A14300	14,300	.5630	63	83	2,5	133	48	16
4148361	VDS202A14400	4142990	VDS402A14400	14,400	.5669	63	83	2,5	133	48	16
4148362	VDS202A14500	4142991	VDS402A14500	14,500	.5709	63	83	2,5	133	48	16
4148363	VDS202A14600	4142992	VDS402A14600	14,600	.5748	63	83	2,5	133	48	16
4148364	VDS202A14684	4143013	VDS402A14684	14,684	.5781	63	83	2,5	133	48	16
4148365	VDS202A14700	4143014	VDS402A14700	14,700	.5787	63	83	2,5	133	48	16
4148366	VDS202A14800	4143015	VDS402A14800	14,800	.5827	63	83	2,6	133	48	16
4148367	VDS202A14900	4143016	VDS402A14900	14,900	.5866	63	83	2,6	133	48	16
4148368	VDS202A15000	4143017	VDS402A15000	15,000	.5906	63	83	2,6	133	48	16
4148369	VDS202A15083	4143018	VDS402A15083	15,083	.5938	63	83	2,6	133	48	16
4148370	VDS202A15100	4143019	VDS402A15100	15,100	.5945	63	83	2,6	133	48	16
4148371	VDS202A15200	4143020	VDS402A15200	15,200	.5984	63	83	2,6	133	48	16
4148372	VDS202A15300	4143021	VDS402A15300	15,300	.6024	63	83	2,6	133	48	16

VariDrill • 5 x D • VDS202A / VDS402A • A-Shank

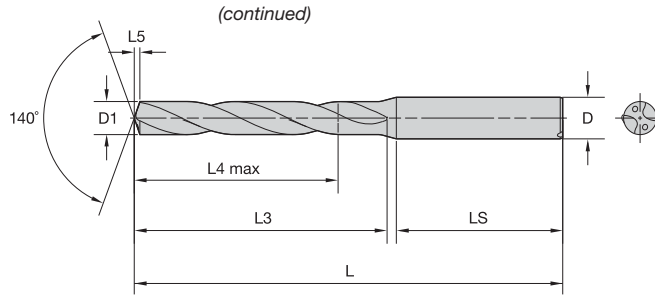

For information on L, L3, and L4 max, see page C29.

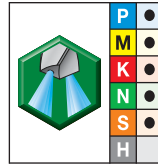
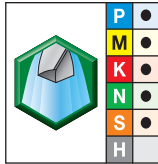

● first choice
○ alternate choice

grade WU25PD TiAlN		grade WU25PD TiAlN		D1 diameter		L4 max	L3	L5	L	LS	D
order #	catalogue #	order #	catalogue #	mm	in						
-	-	4143022	VDS402A15400	15,400	.6063	63	83	2,7	133	48	16
-	-	4143033	VDS402A15479	15,479	.6094	63	83	2,7	133	48	16
4148375	VDS202A15500	4143034	VDS402A15500	15,500	.6102	63	83	2,7	133	48	16
4148376	VDS202A15600	4143035	VDS402A15600	15,600	.6142	63	83	2,7	133	48	16
4148377	VDS202A15700	4143036	VDS402A15700	15,700	.6181	63	83	2,7	133	48	16
4148378	VDS202A15800	4143037	VDS402A15800	15,800	.6220	63	83	2,7	133	48	16
4148379	VDS202A15875	4143038	VDS402A15875	15,875	.6250	63	83	2,8	133	48	16
4148380	VDS202A15900	4143039	VDS402A15900	15,900	.6260	63	83	2,8	133	48	16
4148381	VDS202A16000	4143040	VDS402A16000	16,000	.6299	63	83	2,8	133	48	16
4148382	VDS202A16100	4143041	VDS402A16100	16,100	.6339	71	93	2,8	143	48	18
4148383	VDS202A16200	4143042	VDS402A16200	16,200	.6378	71	93	2,8	143	48	18
4148384	VDS202A16271	4143053	VDS402A16271	16,271	.6406	71	93	2,8	143	48	18
4148385	VDS202A16300	4143054	VDS402A16300	16,300	.6417	71	93	2,8	143	48	18
-	-	4143055	VDS402A16400	16,400	.6457	71	93	2,8	143	48	18
4148387	VDS202A16500	4143056	VDS402A16500	16,500	.6496	71	93	2,9	143	48	18
4148388	VDS202A16600	4143057	VDS402A16600	16,600	.6535	71	93	2,9	143	48	18
4148389	VDS202A16670	4143058	VDS402A16670	16,670	.6563	71	93	2,9	143	48	18
-	-	4143059	VDS402A16700	16,700	.6575	71	93	2,9	143	48	18
4148391	VDS202A16800	4143060	VDS402A16800	16,800	.6614	71	93	2,9	143	48	18
-	-	4143061	VDS402A16900	16,900	.6654	71	93	2,9	143	48	18
4148393	VDS202A17000	4143062	VDS402A17000	17,000	.6693	71	93	3,0	143	48	18
4148394	VDS202A17100	4143073	VDS402A17100	17,100	.6732	71	93	3,0	143	48	18
-	-	4143074	VDS402A17200	17,200	.6772	71	93	3,0	143	48	18
4148396	VDS202A17300	4143075	VDS402A17300	17,300	.6811	71	93	3,0	143	48	18
-	-	4143076	VDS402A17400	17,400	.6850	71	93	3,0	143	48	18
4148398	VDS202A17463	4143077	VDS402A17463	17,463	.6875	71	93	3,0	143	48	18
4148399	VDS202A17500	4143078	VDS402A17500	17,500	.6890	71	93	3,0	143	48	18
4148400	VDS202A17600	4143079	VDS402A17600	17,600	.6929	71	93	3,1	143	48	18
4148401	VDS202A17700	4143080	VDS402A17700	17,700	.6969	71	93	3,1	143	48	18
4148402	VDS202A17800	4143081	VDS402A17800	17,800	.7008	71	93	3,1	143	48	18
-	-	4143082	VDS402A17859	17,859	.7031	71	93	3,1	143	48	18
-	-	4143093	VDS402A17900	17,900	.7047	71	93	3,1	143	48	18
4147921	VDS202A18000	4142803	VDS402A18000	18,000	.7087	71	93	3,1	143	48	18
4147922	VDS202A18100	4142804	VDS402A18100	18,100	.7126	77	101	3,1	153	50	20
4148303	VDS202A18200	4142805	VDS402A18200	18,200	.7165	77	101	3,2	153	50	20
4148304	VDS202A18258	4142806	VDS402A18258	18,258	.7188	77	101	3,2	153	50	20
-	-	4142807	VDS402A18300	18,300	.7205	77	101	3,2	153	50	20
-	-	4142808	VDS402A18400	18,400	.7244	77	101	3,2	153	50	20
4148307	VDS202A18500	4142809	VDS402A18500	18,500	.7283	77	101	3,2	153	50	20
-	-	4142810	VDS402A18600	18,600	.7323	77	101	3,2	153	50	20
-	-	4142811	VDS402A18654	18,654	.7344	77	101	3,2	153	50	20
-	-	4142812	VDS402A18700	18,700	.7362	77	101	3,3	153	50	20
4148311	VDS202A18800	4142824	VDS402A18800	18,800	.7402	77	101	3,3	153	50	20
-	-	4142826	VDS402A18900	18,900	.7441	77	101	3,3	153	50	20
4148323	VDS202A19000	4142828	VDS402A19000	19,000	.7480	77	101	3,3	153	50	20
4148324	VDS202A19050	4142830	VDS402A19050	19,050	.7500	77	101	3,3	153	50	20
4148325	VDS202A19100	4142833	VDS402A19100	19,100	.7520	77	101	3,3	153	50	20
-	-	4142835	VDS402A19200	19,200	.7559	77	101	3,3	153	50	20
4148327	VDS202A19300	4142837	VDS402A19300	19,300	.7598	77	101	3,4	153	50	20
4148328	VDS202A19400	4142839	VDS402A19400	19,400	.7638	77	101	3,4	153	50	20
4148329	VDS202A19500	4142841	VDS402A19500	19,500	.7677	77	101	3,4	153	50	20
-	-	4142853	VDS402A19600	19,600	.7717	77	101	3,4	153	50	20

VariDrill • 5 x D • VDS202A / VDS402A • A-Shank

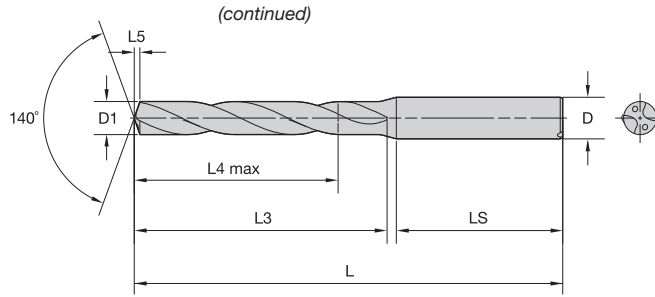

For information on L, L3, and L4 max, see page C29.

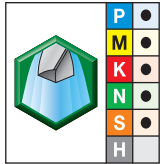

● first choice
○ alternate choice

grade WU25PD TiAlN		grade WU402A TiAlN		D1 diameter		L4 max	L3	L5	L	LS	D
order #	catalogue #	order #	catalogue #	mm	in						
4148332	-	4142854	VDS402A19700	19,700	.7756	77	101	3,4	153	50	20
4148333	VDS202A19800	4142856	VDS402A19800	19,800	.7795	77	101	3,4	153	50	20
4148334	VDS202A19900	4142859	VDS402A19900	19,900	.7835	77	101	3,5	153	50	20
4148334	VDS202A20000	4142860	VDS402A20000	20,000	.7874	77	101	3,5	153	50	20

VariDrill • 8 x D • VDS403A • A-Shank

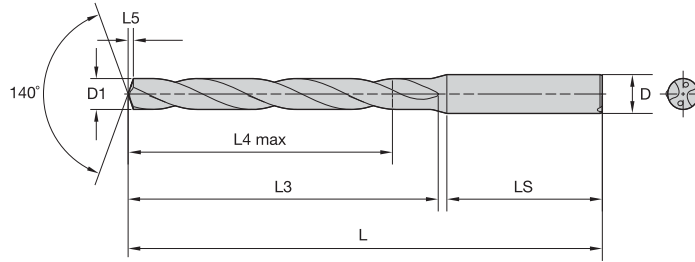

For information on L, L3, and L4 max, see page C29.

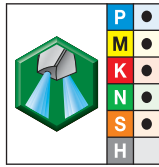

● first choice
○ alternate choice

grade WU25PD TiAlN		D1 diameter		L4 max	L3	L5	L	LS	D
order #	catalogue #	mm	in						
6023126	VDS403A01000	1,000	.0394	10	12	0,2	58	28	4
6023129	VDS403A01100	1,100	.0433	10	12	0,2	58	28	4
6023132	VDS403A01200	1,200	.0472	10	12	0,2	58	28	4
6023133	VDS403A01300	1,300	.0512	10	12	0,2	58	28	4
6023134	VDS403A01321	1,321	.0520	10	12	0,2	58	28	4
6023136	VDS403A01400	1,400	.0551	10	12	0,2	58	28	4
4143700	VDS403A01500	1,500	.0591	15	18	0,2	58	28	4
4143701	VDS403A01600	1,600	.0630	15	18	0,2	58	28	4
4143702	VDS403A01700	1,700	.0669	15	18	0,3	58	28	4
4143723	VDS403A01800	1,800	.0709	15	18	0,3	58	28	4
4143724	VDS403A01900	1,900	.0748	15	18	0,3	58	28	4
4143725	VDS403A01984	1,984	.0781	22	26	0,3	66	28	4
4143726	VDS403A02000	2,000	.0787	22	26	0,3	66	28	4
4143727	VDS403A02100	2,100	.0827	22	26	0,3	66	28	4
4143728	VDS403A02200	2,200	.0866	22	26	0,3	66	28	4
4143729	VDS403A02300	2,300	.0906	22	26	0,4	66	28	4
4143730	VDS403A02383	2,383	.0938	25	30	0,4	66	28	4
4143731	VDS403A02400	2,400	.0945	25	30	0,4	66	28	4
4143732	VDS403A02439	2,439	.0960	25	30	0,4	66	28	4
4143733	VDS403A02489	2,489	.0980	25	30	0,4	66	28	4
4143734	VDS403A02500	2,500	.0984	25	30	0,4	66	28	4
4143735	VDS403A02578	2,578	.1015	25	30	0,4	66	28	4
4143736	VDS403A02600	2,600	.1024	25	30	0,4	66	28	4
4143737	VDS403A02642	2,642	.1040	25	30	0,4	66	28	4
4143738	VDS403A02700	2,700	.1063	25	30	0,4	66	28	4
4143739	VDS403A02705	2,705	.1065	25	30	0,4	66	28	4
4143740	VDS403A02779	2,779	.1094	25	30	0,5	66	28	4
4143741	VDS403A02800	2,800	.1102	25	30	0,5	66	28	4
4143742	VDS403A02820	2,820	.1110	25	30	0,5	66	28	4
4143743	VDS403A02870	2,870	.1130	25	30	0,5	66	28	4
4143744	VDS403A02900	2,900	.1142	25	30	0,5	66	28	4
4143745	VDS403A02947	2,947	.1160	25	30	0,5	66	28	4
4143746	VDS403A03000	3,000	.1181	33	40	0,5	78	36	6
4143747	VDS403A03048	3,048	.1200	33	40	0,5	78	36	6
4143748	VDS403A03100	3,100	.1220	33	40	0,5	78	36	6
4143749	VDS403A03175	3,175	.1250	33	40	0,5	78	36	6
4143750	VDS403A03200	3,200	.1260	33	40	0,5	78	36	6
4143751	VDS403A03264	3,264	.1285	33	40	0,5	78	36	6
4143752	VDS403A03300	3,300	.1299	33	40	0,5	78	36	6
4143753	VDS403A03400	3,400	.1339	33	40	0,6	78	36	6
4143754	VDS403A03455	3,455	.1360	33	40	0,6	78	36	6
4143755	VDS403A03500	3,500	.1378	33	40	0,6	78	36	6
4143756	VDS403A03571	3,571	.1406	33	40	0,6	78	36	6
4143757	VDS403A03600	3,600	.1417	33	40	0,6	78	36	6
4143758	VDS403A03658	3,658	.1440	33	40	0,6	78	36	6
4143759	VDS403A03700	3,700	.1457	33	40	0,6	78	36	6
4143760	VDS403A03734	3,734	.1470	33	40	0,6	78	36	6
4143761	VDS403A03800	3,800	.1496	41	49	0,6	87	36	6
4143762	VDS403A03900	3,900	.1535	41	49	0,6	87	36	6
4143763	VDS403A03970	3,970	.1563	41	49	0,7	87	36	6
4143764	VDS403A04000	4,000	.1575	41	49	0,7	87	36	6
4143765	VDS403A04039	4,039	.1590	41	49	0,7	87	36	6

VariDrill • 8 x D • VDS403A • A-Shank

(continued)

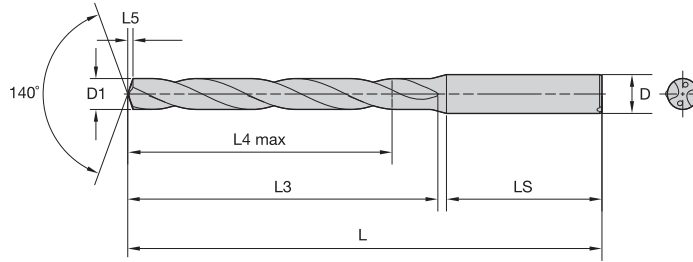

For information on L, L3, and L4 max, see page C29.



- first choice
- alternate choice

grade WU25PD TiAIN		D1 diameter		L4 max	L3	L5	L	LS	D
order #	catalogue #	mm	in						
4143766	VDS403A04090	4,090	.1610	41	49	0,7	87	36	6
4143767	VDS403A04100	4,100	.1614	41	49	0,7	87	36	6
4143768	VDS403A04200	4,200	.1654	41	49	0,7	87	36	6
4143769	VDS403A04217	4,217	.1660	41	49	0,7	87	36	6
4143770	VDS403A04300	4,300	.1693	41	49	0,7	87	36	6
4143771	VDS403A04366	4,366	.1719	41	49	0,7	87	36	6
4143772	VDS403A04400	4,400	.1732	41	49	0,7	87	36	6
4143773	VDS403A04500	4,500	.1772	41	49	0,7	87	36	6
4143774	VDS403A04600	4,600	.1811	41	49	0,8	87	36	6
4143775	VDS403A04623	4,623	.1820	41	49	0,8	87	36	6
4143776	VDS403A04700	4,700	.1850	41	49	0,8	87	36	6
4143777	VDS403A04763	4,763	.1875	48	56	0,8	94	36	6
4143778	VDS403A04800	4,800	.1890	48	56	0,8	94	36	6
4143779	VDS403A04852	4,852	.1910	48	56	0,8	94	36	6
4143780	VDS403A04900	4,900	.1929	48	56	0,8	94	36	6
4143781	VDS403A05000	5,000	.1969	48	56	0,8	94	36	6
4143782	VDS403A05100	5,100	.2008	48	56	0,9	94	36	6
4143783	VDS403A05106	5,106	.2010	48	56	0,9	94	36	6
4143784	VDS403A05159	5,159	.2031	48	56	0,9	94	36	6
4143785	VDS403A05200	5,200	.2047	48	56	0,9	94	36	6
4143786	VDS403A05300	5,300	.2087	48	56	0,9	94	36	6
4143787	VDS403A05400	5,400	.2126	48	56	0,9	94	36	6
4143788	VDS403A05410	5,410	.2130	48	56	0,9	94	36	6
4143789	VDS403A05500	5,500	.2165	48	56	0,9	94	36	6
4143790	VDS403A05558	5,558	.2188	48	56	0,9	94	36	6
4143791	VDS403A05600	5,600	.2205	48	56	0,9	94	36	6
4143792	VDS403A05616	5,616	.2211	48	56	0,9	94	36	6
4143793	VDS403A05700	5,700	.2244	48	56	1,0	94	36	6
4143794	VDS403A05800	5,800	.2283	48	56	1,0	94	36	6
4143795	VDS403A05900	5,900	.2323	48	56	1,0	94	36	6
4143796	VDS403A05954	5,954	.2344	48	56	1,0	94	36	6
4143797	VDS403A06000	6,000	.2362	48	56	1,0	94	36	6
4143798	VDS403A06100	6,100	.2402	57	67	1,0	105	36	8
4143799	VDS403A06200	6,200	.2441	57	67	1,0	105	36	8
4143800	VDS403A06300	6,300	.2480	57	67	1,1	105	36	8
4143801	VDS403A06350	6,350	.2500	57	67	1,1	105	36	8
4143802	VDS403A06400	6,400	.2520	57	67	1,1	105	36	8
4143803	VDS403A06500	6,500	.2559	57	67	1,1	105	36	8
4143804	VDS403A06528	6,528	.2570	57	67	1,1	105	36	8
4143805	VDS403A06600	6,600	.2598	57	67	1,1	105	36	8
4143806	VDS403A06630	6,630	.2610	57	67	1,1	105	36	8
4143807	VDS403A06700	6,700	.2638	57	67	1,1	105	36	8
4143808	VDS403A06746	6,746	.2656	57	67	1,1	105	36	8
4143809	VDS403A06800	6,800	.2677	57	67	1,1	105	36	8
4143810	VDS403A06900	6,900	.2717	57	67	1,2	105	36	8
4143811	VDS403A07000	7,000	.2756	57	67	1,2	105	36	8
4143812	VDS403A07100	7,100	.2795	64	74	1,2	113	36	8
4143813	VDS403A07145	7,145	.2813	64	74	1,2	113	36	8
4143814	VDS403A07200	7,200	.2835	64	74	1,2	113	36	8
4143815	VDS403A07300	7,300	.2874	64	74	1,2	113	36	8
4143816	VDS403A07400	7,400	.2913	64	74	1,3	113	36	8
4143817	VDS403A07500	7,500	.2953	64	74	1,3	113	36	8

INDEXABLE MILLING

SOLID END MILLING

HOLEMAKING

TAPPING

TURNING

VariDrill • 8 x D • VDS403A • A-Shank

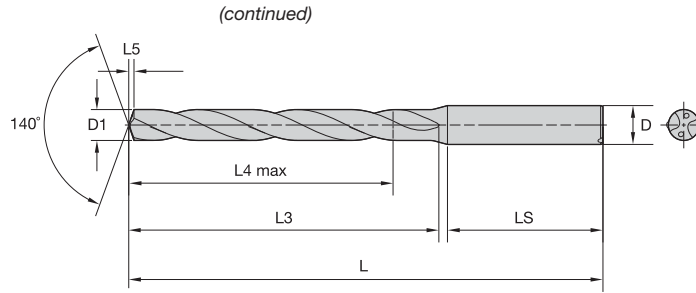

For information on L, L3, and L4 max, see page C29.



- first choice
- alternate choice

grade WU25PD TiAlN		D1 diameter		L4 max	L3	L5	L	LS	D
order #	catalogue #	mm	in						
4143818	VDS403A07541	7,541	.2969	64	74	1,3	113	36	8
4143819	VDS403A07600	7,600	.2992	64	74	1,3	113	36	8
4143820	VDS403A07700	7,700	.3031	64	74	1,3	113	36	8
4143821	VDS403A07800	7,800	.3071	64	74	1,3	113	36	8
4143822	VDS403A07900	7,900	.3110	64	74	1,3	113	36	8
4143823	VDS403A07938	7,938	.3125	64	74	1,3	113	36	8
4143824	VDS403A08000	8,000	.3150	64	74	1,4	113	36	8
4143825	VDS403A08100	8,100	.3189	80	92	1,4	135	40	10
4143826	VDS403A08200	8,200	.3228	80	92	1,4	135	40	10
4143827	VDS403A08300	8,300	.3268	80	92	1,4	135	40	10
4143828	VDS403A08334	8,334	.3281	80	92	1,4	135	40	10
4143829	VDS403A08400	8,400	.3307	80	92	1,4	135	40	10
4143830	VDS403A08433	8,433	.3320	80	92	1,4	135	40	10
4143831	VDS403A08500	8,500	.3346	80	92	1,4	135	40	10
4143832	VDS403A08600	8,600	.3386	80	92	1,5	135	40	10
4143833	VDS403A08700	8,700	.3425	80	92	1,5	135	40	10
4143834	VDS403A08733	8,733	.3438	80	92	1,5	135	40	10
4143835	VDS403A08800	8,800	.3465	80	92	1,5	135	40	10
4143836	VDS403A08900	8,900	.3504	80	92	1,5	135	40	10
4143837	VDS403A09000	9,000	.3543	80	92	1,5	135	40	10
4143838	VDS403A09100	9,100	.3583	80	92	1,6	135	40	10
4143839	VDS403A09129	9,129	.3594	80	92	1,6	135	40	10
4143840	VDS403A09200	9,200	.3622	80	92	1,6	135	40	10
4143841	VDS403A09300	9,300	.3661	80	92	1,6	135	40	10
4143842	VDS403A09347	9,347	.3680	80	92	1,6	135	40	10
4143843	VDS403A09400	9,400	.3701	80	92	1,6	135	40	10
4143844	VDS403A09500	9,500	.3740	80	92	1,6	135	40	10
4143845	VDS403A09525	9,525	.3750	80	92	1,6	135	40	10
4143846	VDS403A09600	9,600	.3780	80	92	1,6	135	40	10
4143847	VDS403A09700	9,700	.3819	80	92	1,7	135	40	10
4143848	VDS403A09800	9,800	.3858	80	92	1,7	135	40	10
4143849	VDS403A09900	9,900	.3898	80	92	1,7	135	40	10
4143850	VDS403A09921	9,921	.3906	68	80	1,7	122	40	10
4143421	VDS403A10000	10,000	.3937	80	92	1,7	135	40	10
4143422	VDS403A10100	10,100	.3976	96	110	1,7	158	45	12
4143473	VDS403A10200	10,200	.4016	96	110	1,7	158	45	12
4143474	VDS403A10300	10,300	.4055	96	110	1,8	158	45	12
4143475	VDS403A10320	10,320	.4063	96	110	1,8	158	45	12
4143476	VDS403A10400	10,400	.4094	96	110	1,8	158	45	12
4143477	VDS403A10500	10,500	.4134	96	110	1,8	158	45	12
4143478	VDS403A10600	10,600	.4173	96	110	1,8	158	45	12
4143479	VDS403A10700	10,700	.4213	96	110	1,8	158	45	12
4143480	VDS403A10716	10,716	.4219	96	110	1,8	158	45	12
4143481	VDS403A10800	10,800	.4252	96	110	1,9	158	45	12
4143482	VDS403A10900	10,900	.4291	96	110	1,9	158	45	12
4143483	VDS403A11000	11,000	.4331	96	110	1,9	158	45	12
4143484	VDS403A11100	11,100	.4370	96	110	1,9	158	45	12
4143485	VDS403A11113	11,113	.4375	96	110	1,9	158	45	12
4143486	VDS403A11200	11,200	.4409	96	110	1,9	158	45	12
4143487	VDS403A11300	11,300	.4449	96	110	1,9	158	45	12
4143488	VDS403A11400	11,400	.4488	96	110	2,0	158	45	12
4143489	VDS403A11500	11,500	.4528	96	110	2,0	158	45	12

VariDrill • 8 x D • VDS403A • A-Shank

(continued)

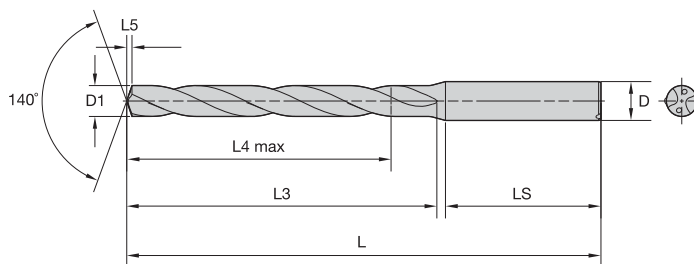

For information on L, L3, and L4 max, see page C29.



- first choice
- alternate choice

grade WU25PD TiAlN		D1 diameter		L4 max	L3	L5	L	LS	D
order #	catalogue #	mm	in						
4143490	VDS403A11509	11,509	.4531	96	110	2,0	158	45	12
4143491	VDS403A11600	11,600	.4567	96	110	2,0	158	45	12
4143492	VDS403A11700	11,700	.4606	96	110	2,0	158	45	12
4143493	VDS403A11800	11,800	.4646	96	110	2,0	158	45	12
4143494	VDS403A11900	11,900	.4685	96	110	2,0	158	45	12
4143495	VDS403A11908	11,908	.4688	96	110	2,0	158	45	12
4143496	VDS403A12000	12,000	.4724	96	110	2,1	158	45	12
4143497	VDS403A12100	12,100	.4764	112	128	2,1	176	45	14
4143498	VDS403A12200	12,200	.4803	112	128	2,1	176	45	14
4143499	VDS403A12300	12,300	.4843	112	128	2,1	176	45	14
4143500	VDS403A12304	12,304	.4844	112	128	2,1	176	45	14
4143501	VDS403A12400	12,400	.4882	112	128	2,1	176	45	14
4143502	VDS403A12500	12,500	.4921	112	128	2,2	176	45	14
4143503	VDS403A12600	12,600	.4961	112	128	2,2	176	45	14
4143504	VDS403A12700	12,700	.5000	112	128	2,2	176	45	14
4143505	VDS403A12800	12,800	.5039	112	128	2,2	176	45	14
4143506	VDS403A12900	12,900	.5079	112	128	2,2	176	45	14
4143507	VDS403A13000	13,000	.5118	112	128	2,2	176	45	14
4143508	VDS403A13096	13,096	.5156	112	128	2,3	176	45	14
4143509	VDS403A13100	13,100	.5157	112	128	2,3	176	45	14
4143510	VDS403A13200	13,200	.5197	112	128	2,3	176	45	14
4143511	VDS403A13300	13,300	.5236	112	128	2,3	176	45	14
4143512	VDS403A13400	13,400	.5276	112	128	2,3	176	45	14
4143513	VDS403A13500	13,500	.5315	112	128	2,3	176	45	14
4143514	VDS403A13600	13,600	.5354	112	128	2,3	176	45	14
4143515	VDS403A13700	13,700	.5394	112	128	2,4	176	45	14
4143516	VDS403A13800	13,800	.5433	112	128	2,4	176	45	14
4143517	VDS403A13891	13,891	.5469	112	128	2,4	176	45	14
4143518	VDS403A13900	13,900	.5472	112	128	2,4	176	45	14
4143519	VDS403A14000	14,000	.5512	112	128	2,4	176	45	14
4143520	VDS403A14100	14,100	.5551	128	146	2,4	197	48	16
4143521	VDS403A14200	14,200	.5591	128	146	2,5	197	48	16
4143522	VDS403A14288	14,288	.5625	128	146	2,5	197	48	16
4143523	VDS403A14300	14,300	.5630	128	146	2,5	197	48	16
4143524	VDS403A14400	14,400	.5669	128	146	2,5	197	48	16
4143525	VDS403A14500	14,500	.5709	128	146	2,5	197	48	16
4143526	VDS403A14600	14,600	.5748	128	146	2,5	197	48	16
4143527	VDS403A14684	14,684	.5781	128	146	2,5	197	48	16
4143528	VDS403A14700	14,700	.5787	128	146	2,5	197	48	16
4143529	VDS403A14800	14,800	.5827	128	146	2,6	197	48	16
4143530	VDS403A14900	14,900	.5866	128	146	2,6	197	48	16
4143531	VDS403A15000	15,000	.5906	128	146	2,6	197	48	16
4143532	VDS403A15083	15,083	.5938	128	146	2,6	197	48	16
4143533	VDS403A15100	15,100	.5945	128	146	2,6	197	48	16
4143534	VDS403A15200	15,200	.5984	128	146	2,6	197	48	16
4143535	VDS403A15300	15,300	.6024	128	146	2,6	197	48	16
4143536	VDS403A15400	15,400	.6063	128	146	2,7	197	48	16
4143537	VDS403A15479	15,479	.6094	128	146	2,7	197	48	16
4143538	VDS403A15500	15,500	.6102	128	146	2,7	197	48	16
4143539	VDS403A15600	15,600	.6142	128	146	2,7	197	48	16
4143540	VDS403A15700	15,700	.6181	128	146	2,7	197	48	16
4143541	VDS403A15800	15,800	.6220	128	146	2,7	197	48	16

INDEXABLE MILLING

SOLID END MILLING

HOLEMAKING

TAPPING

TURNING

VariDrill • 8 x D • VDS403A • A-Shank

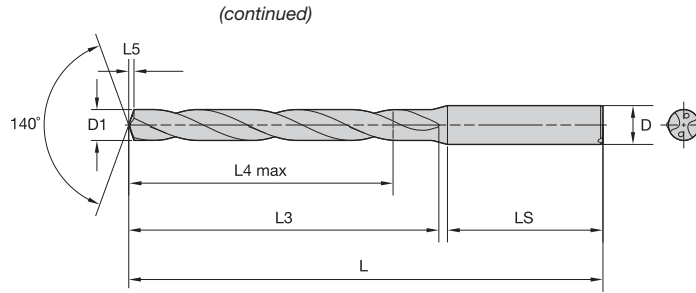

For information on L, L3, and L4 max, see page C29.



- first choice
- alternate choice

grade WU25PD TiAlN		D1 diameter		L4 max	L3	L5	L	LS	D
order #	catalogue #	mm	in						
4143542	VDS403A15875	15,875	.6250	128	146	2,8	197	48	16
4143543	VDS403A15900	15,900	.6260	128	146	2,8	197	48	16
4143544	VDS403A16000	16,000	.6299	128	146	2,8	197	48	16
4143546	VDS403A16200	16,200	.6378	144	163	2,8	214	48	18
4143547	VDS403A16271	16,271	.6406	144	163	2,8	214	48	18
4143548	VDS403A16300	16,300	.6417	144	163	2,8	214	48	18
4143549	VDS403A16400	16,400	.6457	144	163	2,8	214	48	18
4143550	VDS403A16500	16,500	.6496	144	163	2,9	214	48	18
4143551	VDS403A16600	16,600	.6535	144	163	2,9	214	48	18
4143552	VDS403A16670	16,670	.6563	144	163	2,9	214	48	18
4143553	VDS403A16700	16,700	.6575	144	163	2,9	214	48	18
4143554	VDS403A16800	16,800	.6614	144	163	2,9	214	48	18
4143555	VDS403A16900	16,900	.6654	144	163	2,9	214	48	18
4143556	VDS403A17000	17,000	.6693	144	163	3,0	214	48	18
4143557	VDS403A17100	17,100	.6732	144	163	3,0	214	48	18
4143558	VDS403A17200	17,200	.6772	144	163	3,0	214	48	18
4143559	VDS403A17300	17,300	.6811	144	163	3,0	214	48	18
4143560	VDS403A17400	17,400	.6850	144	163	3,0	214	48	18
4143561	VDS403A17463	17,463	.6875	144	163	3,0	214	48	18
4143562	VDS403A17500	17,500	.6890	144	163	3,0	214	48	18
4143563	VDS403A17600	17,600	.6929	144	163	3,1	214	48	18
4143564	VDS403A17700	17,700	.6969	144	163	3,1	214	48	18
4143565	VDS403A17800	17,800	.7008	144	163	3,1	214	48	18
4144209	VDS403A18000	18,000	.7087	144	163	3,1	214	48	18
4144211	VDS403A18100	18,100	.7126	160	181	3,1	234	50	20
4144212	VDS403A18200	18,200	.7165	160	181	3,2	234	50	20
4144246	VDS403A18300	18,300	.7205	160	181	3,2	234	50	20
4144248	VDS403A18400	18,400	.7244	160	181	3,2	234	50	20
4144250	VDS403A18500	18,500	.7283	160	181	3,2	234	50	20
4144252	VDS403A18600	18,600	.7323	160	181	3,2	234	50	20
4144256	VDS403A18700	18,700	.7362	160	181	3,3	234	50	20
4144258	VDS403A18800	18,800	.7402	160	181	3,3	234	50	20
4144260	VDS403A18900	18,900	.7441	160	181	3,3	234	50	20
4144262	VDS403A19000	19,000	.7480	160	181	3,3	234	50	20
4144275	VDS403A19050	19,050	.7500	160	181	3,3	234	50	20
4144277	VDS403A19100	19,100	.7520	160	181	3,3	234	50	20
4144281	VDS403A19300	19,300	.7598	160	181	3,4	234	50	20
4144283	VDS403A19400	19,400	.7638	160	181	3,4	234	50	20
4144285	VDS403A19500	19,500	.7677	160	181	3,4	234	50	20
4144289	VDS403A19700	19,700	.7756	160	181	3,4	234	50	20
4144291	VDS403A19800	19,800	.7795	160	181	3,4	234	50	20
4144303	VDS403A19900	19,900	.7835	160	181	3,5	234	50	20
4144305	VDS403A20000	20,000	.7874	160	181	3,5	234	50	20

INDEXABLE MILLING

SOLID END MILLING

HOLEMAKING

TAPPING

TURNING

Application Data • VDS2 Series • WU25PD™ • Flood Coolant • Metric

Material Group	Cutting Speed – vc Range – m/min			Tool Diameter (mm)	Recommended Feed Rate (f) by Diameter										
	min	–	max		1,0	2,0	3,0	4,0	6,0	8,0	10,0	12,0	16,0	20,0	
	P	0	70		–	115	mm/r	0,03–0,08	0,04–0,09	0,05–0,11	0,08–0,14	0,09–0,19	0,11–0,22	0,13–0,26	0,15–0,30
	1	60	–	100	mm/r	0,04–0,09	0,05–0,11	0,06–0,13	0,09–0,16	0,11–0,22	0,13–0,26	0,15–0,31	0,18–0,35	0,22–0,42	0,28–0,54
	2	80	–	100	mm/r	0,04–0,09	0,05–0,11	0,06–0,13	0,08–0,16	0,12–0,22	0,14–0,26	0,17–0,31	0,20–0,35	0,24–0,42	0,31–0,53
	3	50	–	90	mm/r	0,05–0,11	0,06–0,13	0,07–0,15	0,09–0,17	0,13–0,23	0,15–0,28	0,19–0,33	0,22–0,38	0,26–0,47	0,34–0,59
	4	50	–	100	mm/r	0,04–0,12	0,05–0,13	0,06–0,15	0,08–0,17	0,12–0,23	0,14–0,28	0,17–0,33	0,19–0,38	0,23–0,47	0,29–0,59
	5	30	–	60	mm/r	0,03–0,05	0,04–0,06	0,05–0,07	0,06–0,10	0,08–0,14	0,10–0,18	0,12–0,22	0,14–0,24	0,18–0,32	0,23–0,41
	6	30	–	60	mm/r	0,03–0,05	0,04–0,06	0,05–0,07	0,06–0,10	0,08–0,14	0,10–0,18	0,12–0,22	0,14–0,24	0,18–0,32	0,23–0,41
M	1	20	–	40	mm/r	0,02–0,05	0,03–0,06	0,04–0,07	0,05–0,09	0,08–0,11	0,09–0,12	0,10–0,14	0,12–0,16	0,14–0,18	0,16–0,20
	2	30	–	50	mm/r	0,02–0,06	0,03–0,07	0,04–0,08	0,06–0,10	0,08–0,12	0,09–0,14	0,10–0,16	0,12–0,18	0,14–0,20	0,16–0,22
	3	20	–	40	mm/r	0,02–0,05	0,03–0,06	0,04–0,07	0,06–0,09	0,08–0,11	0,09–0,12	0,10–0,14	0,12–0,16	0,14–0,18	0,16–0,20
K	1	80	–	170	mm/r	0,09–0,18	0,10–0,20	0,11–0,22	0,12–0,24	0,16–0,31	0,20–0,38	0,23–0,44	0,25–0,49	0,31–0,60	0,38–0,74
	2	90	–	120	mm/r	0,06–0,13	0,08–0,15	0,10–0,17	0,12–0,19	0,16–0,25	0,20–0,31	0,23–0,36	0,25–0,40	0,31–0,48	0,38–0,60
	3	80	–	130	mm/r	0,05–0,11	0,06–0,13	0,07–0,15	0,09–0,19	0,12–0,25	0,14–0,30	0,17–0,35	0,19–0,40	0,25–0,48	0,30–0,60
N	1	90	–	270	mm/r	0,05–0,12	0,06–0,13	0,08–0,14	0,10–0,16	0,12–0,20	0,16–0,24	0,20–0,28	0,24–0,32	0,28–0,40	0,32–0,48
	2	90	–	270	mm/r	0,04–0,08	0,06–0,12	0,08–0,16	0,10–0,20	0,12–0,24	0,16–0,28	0,20–0,32	0,24–0,36	0,28–0,44	0,32–0,52
	3	90	–	225	mm/r	0,10–0,13	0,11–0,14	0,12–0,14	0,13–0,16	0,14–0,20	0,16–0,24	0,20–0,28	0,24–0,32	0,28–0,40	0,32–0,44
	4	90	–	270	mm/r	0,04–0,08	0,06–0,12	0,08–0,16	0,10–0,20	0,12–0,24	0,16–0,28	0,20–0,32	0,24–0,36	0,28–0,40	0,32–0,48
S	1	20	–	30	mm/r	0,01–0,04	0,02–0,05	0,03–0,06	0,04–0,08	0,06–0,10	0,08–0,12	0,09–0,13	0,10–0,14	0,12–0,16	0,14–0,18
	2	10	–	30	mm/r	0,01–0,03	0,02–0,03	0,02–0,04	0,03–0,06	0,05–0,08	0,07–0,10	0,08–0,11	0,09–0,12	0,10–0,14	0,11–0,16
	3	20	–	40	mm/r	0,01–0,03	0,02–0,03	0,02–0,04	0,02–0,05	0,04–0,07	0,06–0,09	0,07–0,10	0,08–0,11	0,09–0,13	0,10–0,15
	4	20	–	50	mm/r	0,01–0,03	0,02–0,03	0,02–0,04	0,03–0,06	0,05–0,08	0,07–0,10	0,08–0,11	0,09–0,12	0,10–0,14	0,11–0,16
H	1	10	–	30	mm/r	0,01–0,03	0,02–0,03	0,02–0,04	0,03–0,06	0,05–0,08	0,07–0,10	0,08–0,11	0,09–0,12	0,10–0,14	0,11–0,16
	2	10	–	30	mm/r	0,01–0,03	0,02–0,03	0,02–0,04	0,02–0,05	0,04–0,07	0,06–0,09	0,07–0,10	0,08–0,11	0,09–0,13	0,10–0,15

Application Data • VDS4 Series • WU25PD • Through Coolant • Metric

Material Group	Cutting Speed – vc Range – m/min			Tool Diameter (mm)	Recommended Feed Rate (f) by Diameter										
	min	–	max		1,0	2,0	3,0	4,0	6,0	8,0	10,0	12,0	16,0	20,0	
	P	0	70		–	115	mm/r	0,03–0,08	0,04–0,09	0,05–0,11	0,08–0,14	0,09–0,19	0,11–0,22	0,13–0,26	0,15–0,30
	1	70	–	140	mm/r	0,04–0,09	0,05–0,12	0,07–0,14	0,08–0,16	0,11–0,22	0,13–0,26	0,15–0,31	0,18–0,35	0,22–0,42	0,28–0,54
	2	90	–	140	mm/r	0,04–0,09	0,05–0,12	0,07–0,14	0,08–0,16	0,12–0,22	0,14–0,26	0,17–0,31	0,20–0,35	0,24–0,42	0,31–0,53
	3	60	–	100	mm/r	0,05–0,10	0,06–0,13	0,08–0,15	0,09–0,17	0,13–0,23	0,15–0,28	0,19–0,33	0,22–0,38	0,26–0,47	0,34–0,59
	4	50	–	100	mm/r	0,05–0,10	0,06–0,13	0,07–0,15	0,08–0,17	0,12–0,23	0,14–0,28	0,17–0,33	0,19–0,38	0,23–0,47	0,29–0,59
	5	30	–	60	mm/r	0,03–0,05	0,04–0,06	0,05–0,07	0,06–0,10	0,08–0,14	0,10–0,18	0,12–0,22	0,14–0,24	0,18–0,32	0,23–0,41
	6	40	–	70	mm/r	0,03–0,05	0,04–0,06	0,05–0,08	0,06–0,10	0,08–0,14	0,10–0,18	0,13–0,22	0,14–0,24	0,18–0,32	0,23–0,41
M	1	20	–	40	mm/r	0,02–0,05	0,03–0,06	0,04–0,07	0,05–0,09	0,08–0,11	0,09–0,12	0,10–0,14	0,12–0,16	0,14–0,18	0,16–0,20
	2	30	–	50	mm/r	0,02–0,06	0,03–0,07	0,04–0,08	0,06–0,10	0,08–0,12	0,09–0,14	0,10–0,16	0,12–0,18	0,14–0,20	0,16–0,22
	3	20	–	40	mm/r	0,02–0,05	0,03–0,06	0,04–0,07	0,05–0,09	0,08–0,11	0,09–0,12	0,10–0,14	0,12–0,16	0,14–0,18	0,16–0,20
K	1	80	–	170	mm/r	0,08–0,16	0,09–0,17	0,11–0,22	0,12–0,24	0,16–0,31	0,20–0,38	0,23–0,44	0,25–0,49	0,31–0,60	0,38–0,74
	2	80	–	140	mm/r	0,10–0,14	0,11–0,15	0,12–0,16	0,13–0,19	0,16–0,25	0,20–0,31	0,23–0,36	0,25–0,40	0,31–0,48	0,38–0,60
	3	80	–	130	mm/r	0,05–0,13	0,07–0,15	0,08–0,17	0,09–0,19	0,12–0,25	0,14–0,30	0,17–0,35	0,19–0,40	0,24–0,48	0,30–0,60
N	1	90	–	315	mm/r	0,05–0,12	0,06–0,13	0,08–0,14	0,10–0,16	0,12–0,20	0,16–0,24	0,20–0,28	0,24–0,32	0,28–0,40	0,32–0,48
	2	90	–	270	mm/r	0,04–0,08	0,06–0,12	0,08–0,16	0,10–0,20	0,12–0,24	0,16–0,28	0,20–0,32	0,24–0,36	0,28–0,44	0,32–0,52
	3	90	–	270	mm/r	0,10–0,13	0,11–0,14	0,12–0,14	0,13–0,16	0,14–0,20	0,16–0,24	0,20–0,28	0,24–0,32	0,28–0,40	0,32–0,44
	4	90	–	180	mm/r	0,04–0,08	0,06–0,12	0,08–0,16	0,10–0,20	0,12–0,24	0,16–0,28	0,20–0,32	0,24–0,36	0,28–0,40	0,32–0,48
S	1	10	–	30	mm/r	0,01–0,04	0,02–0,05	0,03–0,06	0,04–0,08	0,06–0,10	0,08–0,12	0,09–0,13	0,10–0,14	0,12–0,16	0,14–0,18
	2	10	–	25	mm/r	0,01–0,03	0,02–0,03	0,02–0,04	0,03–0,06	0,05–0,08	0,07–0,10	0,08–0,11	0,09–0,12	0,10–0,14	0,11–0,16
	3	10	–	30	mm/r	0,01–0,03	0,02–0,03	0,02–0,04	0,02–0,05	0,04–0,07	0,06–0,09	0,07–0,10	0,08–0,11	0,09–0,13	0,10–0,15
	4	10	–	40	mm/r	0,01–0,03	0,02–0,03	0,02–0,04	0,03–0,06	0,05–0,08	0,07–0,10	0,08–0,11	0,09–0,12	0,10–0,14	0,11–0,16
H	1	10	–	30	mm/r	0,01–0,03	0,02–0,03	0,02–0,04	0,03–0,06	0,05–0,08	0,07–0,10	0,08–0,11	0,09–0,12	0,10–0,14	0,11–0,16
	2	10	–	30	mm/r	0,01–0,03	0,02–0,03	0,02–0,04	0,02–0,05	0,04–0,07	0,06–0,09	0,07–0,10	0,08–0,11	0,09–0,13	0,10–0,15

Metric tolerance

nominal size range	D1 tolerance	D tolerance h6
1–3	0,000/-0,014 (h8)	0,000/-0,006
>3–6	0,000/-0,012 (h7)	0,000/-0,008
>6–10	0,000/-0,015 (h7)	0,000/-0,009
>10–18	0,000/-0,018 (h7)	0,000/-0,011
>18–20	0,000/-0,021 (h7)	0,000/-0,013

General Application Instructions

Shank Designs to DIN 6535



Form HE,
2° angle
Design F



Form HA,
straight
design A

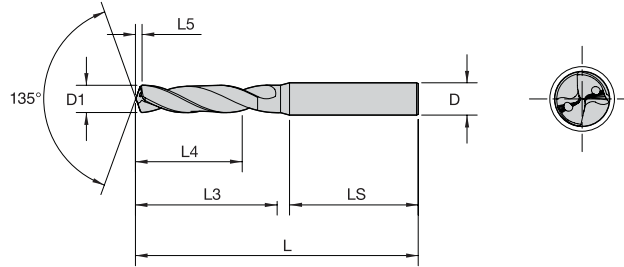

Dimensions for WIDIA™ High-Performance Solid Carbide Drills

mm Ø		DIN 6535		SHORT* ~3 x D			LONG* ~5 x D			EXTRA LONG** ~8 x D		
D1 min	D1 max	D	LS	L	L3	L4 max	L	L3	L4 max	L	L3	L4 max
1,000	1,400	4	28	58	7	5	58	9	6	58	12	10
1,401	1,900	4	28	58	9	6	58	12	9	58	18	15
1,901	2,300	4	28	58	13	9	58	18	14	66	26	22
2,301	2,999	4	28	58	17	12	58	22	17	66	30	25
3,000	3,750	6	36	62	20	14	66	28	23	78	40	33
3,751	4,750	6	36	66	24	17	74	36	29	87	49	41
4,751	6,000	6	36	66	28	20	82	44	35	94	56	48
6,001	7,000	8	36	79	34	24	91	53	43	105	67	57
7,001	8,000	8	36	79	41	29	91	53	43	110	72	61
8,001	10,000	10	40	89	47	35	103	61	49	122	80	68
10,001	12,000	12	45	102	55	40	118	71	56	141	94	79
12,001	14,000	14	45	107	60	43	124	77	60	155	108	91
14,001	16,000	16	48	115	65	45	133	83	63	171	121	101
16,001	18,000	18	48	123	73	51	143	93	71	185	135	113
18,001	20,000	20	50	131	79	55	153	101	77	200	148	124
20,001	22,000	20	50	141	86	60	167	112	85	217	162	136
22,001	25,000	25	56	153	95	65	184	126	98	238	180	150

* D1 < 20mm to DIN 6537K
D1 > 20mm to factory standard
** To factory standard

NOTE: Solid Carbide Drills from WIDIA in short and regular lengths conform to DIN 6537.
Drills with long lengths conform to WIDIA factory standard.
Solid Carbide Drills with diameter D1 > 20mm (not DIN 6537) are also standardised to factory standard.

Tolerances of Drills and Holes

High-performance solid carbide drills with tolerances of m7 create holes with tolerances of H9. H8 can be achieved in very good conditions. The drill should be used for holes in H8, and in favourable conditions, H7 can be achieved. Solid carbide drills with H7 create holes in K9-K11. Other drilling tolerances require special solid carbide drill versions.

Tolerances of diameter D1 on:
Spiral Flute
TDG Drill

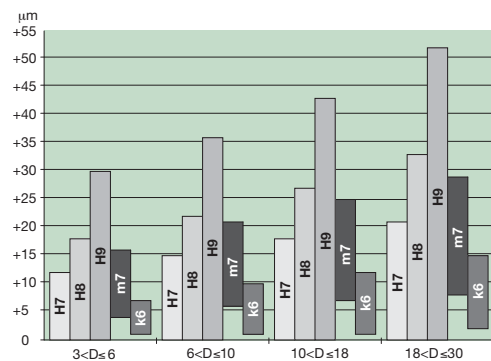

TOP DRILL S+™

Solid Carbide Drills 12 x D • TDS+

TDS+ solid carbide drills are for shop floors seeking a drill with optimal performance and hole quality in steel, stainless steel, and cast iron materials using one universal geometry and grade.



135° point geometry
Low thrust with excellent centering capabilities

4-margin design to full length
Provides stability in interrupted cut with optimal hole quality

30° helix with optimized flute profile
Reduces risk of chip jamming and catastrophic failure

Sub-micron grain substrate
Superior resistance against drill breakage

TDS+ 12 x D drills are capable of drilling holes in steel and cast iron without a pilot drill due to its 135° P point geometry and four full-length margins

WU20PD



Sub-micron grain carbide

TiAlN multilayer for steel, stainless steel, and cast iron

OPTIMAL PERFORMANCE

PRODUCT

TDS P Point with 135° P point angle for excellent centering and low thrust

DIAMETER RANGE

3–20mm

INDUSTRY



MATERIALS

FIRST CHOICE



SECOND CHOICE



APPLICATIONS



DRILLING



INCLINED EXIT



STACKED PLATES



DRILLING DEPTH: 12X



2 FLUTE/4 MARGIN/ COOLANT



THROUGH COOLANT



MQL (MINIMUM QUANTITY LUBRICANT)



HELIX ANGLE: 30°



PLAIN SHANK: ≤H6



DIN 6535

SERIES

TDS504

COOLANT

Through Coolant

LENGTH RATIO

12 x D

DIAMETER RANGE

3–20mm

Shank Style

A - Shank DIN 6535 HA
(round cylindrical, 2mm steps)



TDS+ • Catalog Numbering System

Each character in our catalog number signifies a specific trait of that product.
Use the following key columns and corresponding images to easily identify which attributes apply.

TDS	5	0	4	A	06350	WU20PD
Top Drill Spiral	Flute Style - Coolant	Point	Length	Shank	Diameter in Metric	
	5 = 2 Flute Through Coolant	0 = Conventional Cone Point 1 = Conventional Cone Point with Chamfer	1 = ~ 3 x D 2 = ~ 5 x D 3 = ~ 8 x D 4 = ~ 12 x D	A = Cylindrical Shank, DIN 6535 - 2mm steps F = Whistle Notch 2, DIN 6535 - 2mm steps	03000 = 3,000mm 06350 = 1/4" = E	WIDIA™; Universal, Application 20 = medium carbide, PVD coated, Drill

TOP DRILL S+ • 12 x D • TDS504A • A-Shank

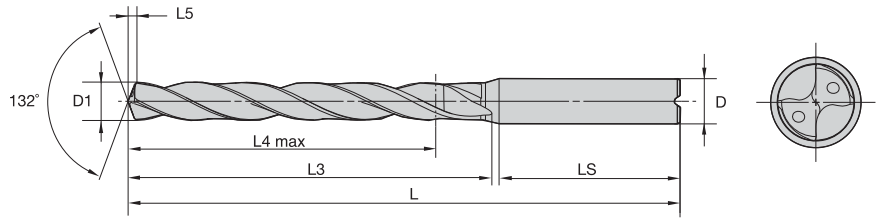

For information on L, L3, and L4 max, see page C29.

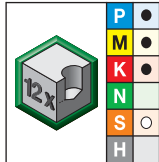

- first choice
- alternate choice

grade WU20PD TiAlN		D1 diameter		L	L4 max	L3	L5	LS	D
order #	catalogue #	mm	in						
4173459	TDS504A03000	3,000	.1181	93	44	52,0	0,6	36	6
4173460	TDS504A03175	3,175	.1250	93	44	52,0	0,7	36	6
4173461	TDS504A03264	3,264	.1285	93	44	53,0	0,7	36	6
4173545	TDS504A03455	3,455	.1360	93	44	53,0	0,7	36	6
4173462	TDS504A03500	3,500	.1378	93	44	53,0	0,7	36	6
4173546	TDS504A03734	3,734	.1470	93	45	54,0	0,8	36	6
4173463	TDS504A03970	3,970	.1563	107	56	66,0	0,8	36	6
4173464	TDS504A04000	4,000	.1575	107	56	66,0	0,8	36	6
4173465	TDS504A04500	4,500	.1772	107	56	67,0	0,9	36	6
4173466	TDS504A04600	4,600	.1811	107	57	68,0	1,0	36	6
4173467	TDS504A04763	4,763	.1875	125	69	82,0	1,0	36	6
4173468	TDS504A04800	4,800	.1890	125	69	82,0	1,0	36	6
4173469	TDS504A05000	5,000	.1969	125	70	83,0	1,1	36	6
4173470	TDS504A05100	5,100	.2008	125	70	83,0	1,1	36	6
4173471	TDS504A05200	5,200	.2047	125	70	83,0	1,1	36	6
4173472	TDS504A05300	5,300	.2087	125	71	84,0	1,1	36	6
4173473	TDS504A05410	5,410	.2130	125	71	84,0	1,1	36	6
4173474	TDS504A05500	5,500	.2165	125	71	84,0	1,2	36	6
4173475	TDS504A05558	5,558	.2188	125	71	84,0	1,2	36	6
4173476	TDS504A05600	5,600	.2205	125	72	85,0	1,2	36	6
4173477	TDS504A05700	5,700	.2244	125	72	85,0	1,2	36	6
4173478	TDS504A05800	5,800	.2283	125	71	85,0	1,2	36	6
4173479	TDS504A06000	6,000	.2362	125	72	86,0	1,3	36	6
4173480	TDS504A06200	6,200	.2441	139	82	97,0	1,3	36	8
4173481	TDS504A06350	6,350	.2500	139	83	98,0	1,3	36	8
4173482	TDS504A06500	6,500	.2559	139	83	98,0	1,4	36	8
4173484	TDS504A06600	6,600	.2598	139	84	99,0	1,4	36	8
4173485	TDS504A06746	6,746	.2656	139	83	99,0	1,4	36	8
4173486	TDS504A06800	6,800	.2677	139	83	99,0	1,4	36	8
4173487	TDS504A06909	6,909	.2720	139	84	100,0	1,5	36	8
4173488	TDS504A07000	7,000	.2756	139	84	100,0	1,5	36	8
4173489	TDS504A07145	7,145	.2813	153	94	111,0	1,5	36	8
4173490	TDS504A07500	7,500	.2953	153	95	112,0	1,6	36	8
4173491	TDS504A07541	7,541	.2969	153	95	112,0	1,6	36	8
4173492	TDS504A07700	7,700	.3031	153	96	113,0	1,6	36	8
4173493	TDS504A07800	7,800	.3071	153	95	113,0	1,7	36	8
4173494	TDS504A07938	7,938	.3125	153	96	114,0	1,7	36	8
4173495	TDS504A08000	8,000	.3150	153	96	114,0	1,7	36	8
4173496	TDS504A08100	8,100	.3189	185	116	136,0	1,7	40	10
4173497	TDS504A08334	8,334	.3281	185	117	137,0	1,8	40	10
4173498	TDS504A08433	8,433	.3320	185	117	137,0	1,8	40	10
4173499	TDS504A08500	8,500	.3346	185	117	137,0	1,8	40	10
4173500	TDS504A08700	8,700	.3425	185	118	138,0	1,9	40	10
4173501	TDS504A08733	8,733	.3438	185	117	138,0	1,9	40	10
4173502	TDS504A09000	9,000	.3543	185	118	139,0	1,9	40	10
4173503	TDS504A09100	9,100	.3583	185	118	139,0	1,9	40	10
4173504	TDS504A09129	9,129	.3594	185	118	139,0	1,9	40	10
4173547	TDS504A09347	9,347	.3680	185	119	140,0	2,0	40	10
4173505	TDS504A09500	9,500	.3740	185	119	140,0	2,0	40	10
4173506	TDS504A09525	9,525	.3750	185	119	140,0	2,0	40	10
4173507	TDS504A09921	9,921	.3906	185	120	142,0	2,1	40	10
4173508	TDS504A10000	10,000	.3937	185	120	142,0	2,1	40	10
4173509	TDS504A10200	10,200	.4016	218	140	164,0	2,2	45	12
4173510	TDS504A10300	10,300	.4055	218	141	165,0	2,2	45	12
4173511	TDS504A10320	10,320	.4063	218	141	165,0	2,2	45	12
4173512	TDS504A10500	10,500	.4134	218	141	165,0	2,2	45	12

INDEXABLE MILLING

SOLID END MILLING

HOLEMAKING

TAPPING

TURNING

TOP DRILL S+ • 12 x D • TDS504A • A-Shank

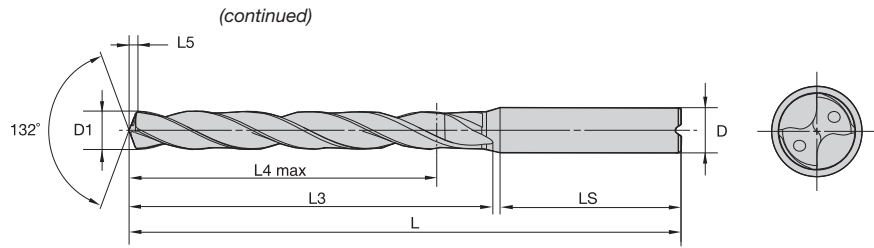
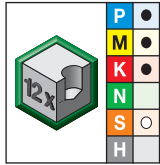

For information on L, L3, and L4 max, see page C29.

- first choice
- alternate choice

grade WU20PD TiAlN		D1 diameter		L	L4 max	L3	L5	LS	D
order #	catalogue #	mm	in						
4173513	TDS504A10716	10,716	.4219	218	142	166,0	2,3	45	12
4173514	TDS504A10800	10,800	.4252	218	141	166,0	2,3	45	12
4173515	TDS504A11000	11,000	.4331	218	142	167,0	2,4	45	12
4173516	TDS504A11113	11,113	.4375	218	142	167,0	2,4	45	12
4173517	TDS504A11500	11,500	.4528	218	143	168,0	2,5	45	12
4173518	TDS504A11800	11,800	.4646	218	143	169,0	2,5	45	12
4173519	TDS504A12000	12,000	.4724	218	144	170,0	2,6	45	12
4173520	TDS504A12100	12,100	.4764	246	164	192,0	2,6	45	14
4148906	TDS504A12500	12,500	.4921	246	165	193,0	2,7	45	14
4173522	TDS504A12700	12,700	.5000	246	166	194,0	2,7	45	14
4173523	TDS504A13000	13,000	.5118	246	166	195,0	2,8	45	14
4173524	TDS504A13100	13,100	.5157	246	166	195,0	2,8	45	14
4173525	TDS504A13500	13,500	.5315	246	167	196,0	2,9	45	14
4173526	TDS504A14000	14,000	.5512	246	168	198,0	3,0	45	14
4173527	TDS504A14100	14,100	.5551	277	188	220,0	3,0	48	16
4173528	TDS504A14288	14,288	.5625	277	188	220,0	3,1	48	16
4173529	TDS504A14500	14,500	.5709	277	189	221,0	3,1	48	16
4173530	TDS504A14684	14,684	.5781	277	190	222,0	3,2	48	16
4173531	TDS504A15000	15,000	.5906	277	190	223,0	3,2	48	16
4173533	TDS504A15875	15,875	.6250	277	192	225,0	3,4	48	16
4173534	TDS504A16000	16,000	.6299	277	192	226,0	3,4	48	16
4173535	TDS504A16500	16,500	.6496	305	213	249,0	3,6	48	18
4173536	TDS504A17000	17,000	.6693	305	214	250,0	3,7	48	18
4173537	TDS504A17463	17,463	.6875	305	215	252,0	3,8	48	18
4173538	TDS504A17500	17,500	.6890	305	215	252,0	3,8	48	18
4173539	TDS504A18000	18,000	.7087	305	216	253,0	3,9	48	18
4173541	TDS504A19000	19,000	.7480	334	238	278,0	4,1	50	20
4173543	TDS504A19500	19,500	.7677	334	239	280,0	4,2	50	20
4173544	TDS504A20000	20,000	.7874	334	240	281,0	4,3	50	20

Application Data • TDS+ Series • WU20PD™ • Through Coolant • Metric

Material Group	Cutting Speed – vc Range – m/min			Recommended Feed Rate (f) by Diameter								
	min	-	max	Tool Diameter (mm)	3,0	4,0	6,0	8,0	10,0	12,0	16,0	20,0
	P	0	1	2	3	4	5	6	1	2	3	4
M	1	2	3	1	2	3	1	2	3	1	2	3
K	1	2	3	1	2	3	1	2	3	1	2	3
N	1	2	3	4	1	2	3	4	1	2	3	4
S	1	2	3	4	1	2	3	4	1	2	3	4

Metric tolerance

nominal size range	D1 tolerance m7	D tolerance h6
>3-6	0,004/0,016	0,000/-0,008
>6-10	0,006/0,021	0,000/-0,009
>10-18	0,007/0,025	0,000/-0,011
>18-25,4	0,008/0,029	0,000/-0,013

INDEXABLE MILLING

SOLID END MILLING

HOLEMAKING

TAPPING

TURNING

TOP DRILL™ Deep Hole

Solid Carbide Deep Hole Drills • TDD

TDD solid carbide deep hole drills consistently deliver high MRRs in steel and cast iron materials using one universal grade.



132° cone point geometry
Improves hole quality, and productivity.

4-margin design
Improves process stability, increases tool life, enables interrupted cuts.

30° helix with optimized flute profile
Reduces risk of chip jamming and catastrophic failure.

Ultra-fine grain substrate
Superior resistance against drill breakage.

The Solid Carbide Deep Hole Drills are enhanced with a cone point geometry which enables the drill to outperform gun drills and HSS deep hole drills in deep hole applications up to 30 x D.

WU20PD



Ultra-fine grain carbide
TiAlN multilayer for steel and cast iron

CONSISTENT PERFORMANCE

PRODUCT

POINT GEOMETRY/GRADE

UP 132° cone point geometry, low thrust, excellent centering

DIAMETER RANGE

3,0–13,0mm

INDUSTRY



MATERIALS

FIRST CHOICE



SECOND CHOICE



APPLICATIONS



DRILLING



INCLINED EXIT



STACKED PLATES



2 FLUTE/4 MARGIN/ COOLANT



THROUGH COOLANT



MQL (MINIMUM QUANTITY LUBRICANT)



HELIX ANGLE: 30°



PLAIN SHANK: ≤H5

SERIES

TDD105Z (H101Z)

LENGTH RATIO

15 x D

DIAMETER RANGE

3,0–13,0mm

TDD106Z (H102Z)

20 x D

3,0–13,0mm

TDD107Z (H103Z)

25 x D

3,0–13,0mm

TDD108Z (H104Z)

30 x D

3,0–13,0mm

Z-SHANK

Round cylindrical, 1mm steps



TDD • Catalog Numbering System

Each character in our catalog number signifies a specific trait of that product.
Use the following key columns and corresponding images to easily identify which attributes apply.

TD	D	105	Z	03000	WU20PD
Top Drill	Deep Hole Drills	Length	Shank	Diameter in Metric	
TD = Top Drill		5 = 15 x D (H101) 6 = 20 x D (H102) 7 = 25 x D (H103) 8 = 30 x D (H104)	Z = Cylindrical Shank, 1mm steps	03000 = 3,000mm 06350 = 1/4"	WIDIA™ , Universal, PVD, Drilling

TOP DRILL Deep Hole • 15 x D • TDD105 • 2 Flute

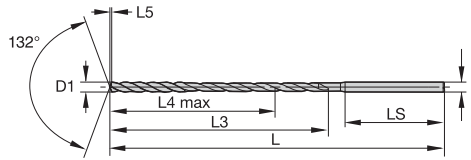

For information on L, L3, and L4 max, see page C29.

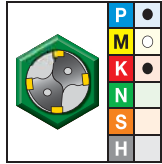

- first choice
- alternate choice

grade WU20PD TiAlN		D1 diameter		D	L3	L4 max	L5	LS	L
order #	catalogue #	mm	in						
3899626	TDD105Z03000	3,000	.1181	3	52	45	0,6	30	86
3899627	TDD105Z03175	3,175	.1250	4	67	58	0,6	32	105
3899628	TDD105Z03500	3,500	.1378	4	68	59	0,7	32	105
3899629	TDD105Z03571	3,571	.1406	4	68	59	0,7	32	105
3899630	TDD105Z03800	3,800	.1496	4	69	60	0,8	32	105
3899631	TDD105Z03970	3,970	.1563	4	70	60	0,8	32	105
3899632	TDD105Z04000	4,000	.1575	4	70	60	0,8	32	105
3899683	TDD105Z04039	4,039	.1590	5	84	73	0,8	34	124
3899684	TDD105Z04300	4,300	.1693	5	85	74	0,9	34	124
3899685	TDD105Z04500	4,500	.1772	5	85	74	0,9	34	124
3899686	TDD105Z04623	4,623	.1820	5	86	75	1,0	34	124
3899687	TDD105Z04763	4,763	.1875	5	86	75	1,0	34	124
3899688	TDD105Z05000	5,000	.1969	5	87	75	1,0	34	124
3899689	TDD105Z05159	5,159	.2031	6	101	88	1,1	36	143
3899690	TDD105Z05410	5,410	.2130	6	102	89	1,1	36	143
3899691	TDD105Z05500	5,500	.2165	6	102	89	1,1	36	143
3899692	TDD105Z05558	5,558	.2188	6	102	89	1,2	36	143
3899693	TDD105Z05800	5,800	.2283	6	103	89	1,2	36	143
3899694	TDD105Z06000	6,000	.2362	6	104	90	1,2	36	143
3899695	TDD105Z06200	6,200	.2441	7	118	103	1,3	38	162
3899696	TDD105Z06350	6,350	.2500	7	119	104	1,3	38	162
3899697	TDD105Z06500	6,500	.2559	7	119	104	1,4	38	162
3899698	TDD105Z06528	6,528	.2570	7	119	104	1,4	38	162
3899699	TDD105Z06746	6,746	.2656	7	120	104	1,4	38	162
3899700	TDD105Z06800	6,800	.2677	7	120	104	1,4	38	162
3899701	TDD105Z06909	6,909	.2720	7	121	105	1,4	38	162
3899702	TDD105Z07000	7,000	.2756	7	121	105	1,5	38	162
3900612	TDD105Z07145	7,145	.2813	8	135	118	1,5	40	181
3900633	TDD105Z07500	7,500	.2953	8	136	119	1,6	40	181
3899764	TDD106Z07500	7,500	.2953	8	174	157	1,6	40	221
3900635	TDD105Z07938	7,938	.3125	8	138	120	1,7	40	181
3900636	TDD105Z08000	8,000	.3150	8	138	120	1,7	40	181
3900637	TDD105Z08334	8,334	.3281	9	153	134	1,8	42	200
3900638	TDD105Z08433	8,433	.3320	9	153	134	1,8	42	200
3900639	TDD105Z08500	8,500	.3346	9	153	134	1,8	42	200
3900640	TDD105Z08733	8,733	.3438	9	154	134	1,8	42	200
3900641	TDD105Z09000	9,000	.3543	9	155	135	1,9	42	200
3900643	TDD105Z09500	9,500	.3740	10	170	149	2,0	44	219
3900644	TDD105Z09525	9,525	.3750	10	170	149	2,0	44	219
3900645	TDD105Z09750	9,750	.3839	10	171	149	2,1	44	219
3900647	TDD105Z10000	10,000	.3937	10	172	150	2,1	44	219
3900648	TDD105Z10200	10,200	.4016	11	186	163	2,2	46	238
3900649	TDD105Z10320	10,317	.4062	11	187	164	2,2	46	238
3900650	TDD105Z10500	10,500	.4134	11	187	164	2,2	46	238
3900652	TDD105Z11000	11,000	.4331	11	189	165	2,3	46	238
3900653	TDD105Z11113	11,113	.4375	12	203	178	2,4	48	257
3900654	TDD105Z11500	11,500	.4528	12	204	179	2,4	48	257
3900656	TDD105Z12000	12,000	.4724	12	206	180	2,5	48	257
3900657	TDD105Z12304	12,304	.4844	13	221	194	2,6	50	276
3900658	TDD105Z12500	12,500	.4921	13	221	194	2,7	50	276
3900659	TDD105Z12700	12,700	.5000	13	222	195	2,7	50	276
3900660	TDD105Z13000	13,000	.5118	13	223	195	2,8	50	276

NOTE: Use TDS 40xx series as pilot drills, see page C44.

TOP DRILL Deep Hole • 20 x D • TDD106 • 2 Flute

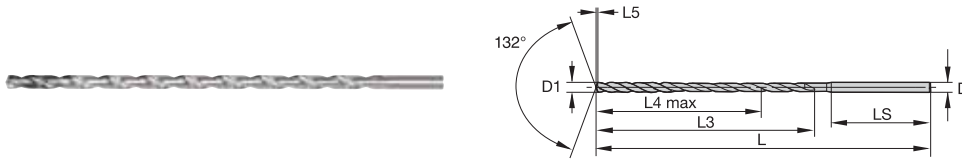

For information on L, L3, and L4 max, see page C29.

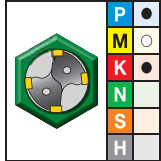

- first choice
- alternate choice

grade WU20PD TiAlN		D1 diameter		D	L3	L4 max	L5	LS	L
order #	catalogue #	mm	in						
3899782	TDD106Z03000	3,000	.1181	3	67	60	0,6	30	101
3899803	TDD106Z03175	3,175	.1250	4	83	74	0,6	32	125
3899804	TDD106Z03500	3,500	.1378	4	86	77	0,7	32	125
3899805	TDD106Z03571	3,571	.1406	4	86	77	0,7	32	125
3899806	TDD106Z03800	3,800	.1496	4	88	79	0,8	32	125
3899807	TDD106Z03970	3,970	.1563	4	89	79	0,8	32	125
3899808	TDD106Z04000	4,000	.1575	4	90	80	0,8	32	125
3899809	TDD106Z04039	4,039	.1590	5	104	93	0,8	34	149
3899810	TDD106Z04300	4,300	.1693	5	106	95	0,9	34	149
3899811	TDD106Z04500	4,500	.1772	5	108	97	0,9	34	149
3899812	TDD106Z04623	4,623	.1820	5	109	98	1,0	34	149
3899813	TDD106Z04763	4,763	.1875	5	110	99	1,0	34	149
3899814	TDD106Z05000	5,000	.1969	5	112	100	1,0	34	149
3899815	TDD106Z05159	5,159	.2031	6	127	114	1,1	36	173
3899816	TDD106Z05410	5,410	.2130	6	129	116	1,1	36	173
3899818	TDD106Z05500	5,500	.2165	6	130	117	1,1	36	173
3899819	TDD106Z05558	5,558	.2188	6	130	117	1,2	36	173
3899820	TDD106Z05800	5,800	.2283	6	132	118	1,2	36	173
3899821	TDD106Z06000	6,000	.2362	6	134	120	1,2	36	173
3899822	TDD106Z06200	6,200	.2441	7	149	134	1,3	38	197
3899823	TDD106Z06350	6,350	.2500	7	151	136	1,3	38	197
3899824	TDD106Z06500	6,500	.2559	7	152	137	1,4	38	197
3899825	TDD106Z06528	6,528	.2570	7	152	137	1,4	38	197
3899826	TDD106Z06746	6,746	.2656	7	154	138	1,4	38	197
3899827	TDD106Z06800	6,800	.2677	7	154	138	1,4	38	197
3899829	TDD106Z07000	7,000	.2756	7	156	140	1,5	38	197
3899763	TDD106Z07145	7,145	.2813	8	171	154	1,5	40	221
3899765	TDD106Z07541	7,541	.2969	8	174	157	1,6	40	221
3899766	TDD106Z07938	7,938	.3125	8	177	159	1,7	40	221
3899767	TDD106Z08000	8,000	.3150	8	178	160	1,7	40	221
3899769	TDD106Z08433	8,433	.3320	9	195	176	1,8	42	245
3899770	TDD106Z08500	8,500	.3346	9	196	177	1,8	42	245
3899771	TDD106Z08733	8,733	.3438	9	198	178	1,8	42	245
3899772	TDD106Z09000	9,000	.3543	9	200	180	1,9	42	245
3899784	TDD106Z09500	9,500	.3740	10	218	197	2,0	44	269
3899785	TDD106Z09525	9,525	.3750	10	218	197	2,0	44	269
3899787	TDD106Z09921	9,921	.3906	10	221	199	2,1	44	269
3899788	TDD106Z10000	10,000	.3937	10	222	200	2,1	44	269
3899789	TDD106Z10200	10,200	.4016	11	237	214	2,2	46	293
3899790	TDD106Z10320	10,317	.4062	11	238	215	2,2	46	293
3899791	TDD106Z10500	10,500	.4134	11	240	217	2,2	46	293
3899792	TDD106Z10716	10,716	.4219	11	242	219	2,3	46	293
3899793	TDD106Z11000	11,000	.4331	11	244	220	2,3	46	293
3899794	TDD106Z11113	11,113	.4375	12	259	234	2,4	48	317
3899795	TDD106Z11500	11,500	.4528	12	262	237	2,4	48	317
3899797	TDD106Z12000	12,000	.4724	12	266	240	2,5	48	317
3899799	TDD106Z12500	12,500	.4921	13	284	257	2,7	50	341
3899800	TDD106Z12700	12,700	.5000	13	285	258	2,7	50	341
3899801	TDD106Z13000	13,000	.5118	13	288	260	2,8	50	341

NOTE: Use TDS 40xx series as pilot drills, see page C44.

INDEXABLE MILLING

SOLID END MILLING

HOLEMAKING

TAPPING

TURNING

TOP DRILL Deep Hole • 25 x D • TDD107 • 2 Flute

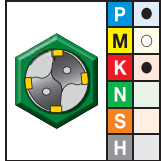
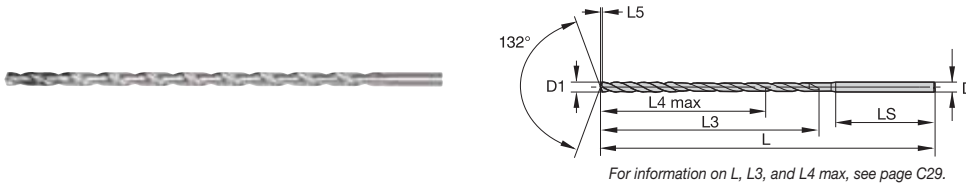

- first choice
- alternate choice

grade WU20PD TiAlN		D1 diameter		D	L3	L4 max	L5	LS	L
order #	catalogue #	mm	in						
3899708	TDD107Z03000	3,000	.1181	3	82	75	0,6	30	116
3899709	TDD107Z03175	3,175	.1250	4	99	90	0,6	32	145
3899710	TDD107Z03500	3,500	.1378	4	103	94	0,7	32	145
3899712	TDD107Z03800	3,800	.1496	4	107	98	0,8	32	145
3899733	TDD107Z03970	3,970	.1563	4	109	99	0,8	32	145
3899734	TDD107Z04000	4,000	.1575	4	110	100	0,8	32	145
3899737	TDD107Z04500	4,500	.1772	5	130	119	0,9	34	174
3899739	TDD107Z04763	4,763	.1875	5	134	123	1,0	34	174
3899740	TDD107Z05000	5,000	.1969	5	137	125	1,0	34	174
3899743	TDD107Z05500	5,500	.2165	6	157	144	1,1	36	203
3899744	TDD107Z05558	5,558	.2188	6	158	145	1,2	36	203
3899745	TDD107Z05800	5,800	.2283	6	161	147	1,2	36	203
3899746	TDD107Z06000	6,000	.2362	6	164	150	1,2	36	203
3899748	TDD107Z06350	6,350	.2500	7	182	167	1,3	38	232
3899749	TDD107Z06500	6,500	.2559	7	184	169	1,4	38	232
3899750	TDD107Z06528	6,528	.2570	7	185	170	1,4	38	232
3899753	TDD107Z06909	6,909	.2720	7	190	174	1,4	38	232
3899754	TDD107Z07000	7,000	.2756	7	191	175	1,5	38	232
3899567	TDD107Z07541	7,541	.2969	8	212	195	1,6	40	261
3899569	TDD107Z08000	8,000	.3150	8	218	200	1,7	40	261
3899571	TDD107Z08433	8,433	.3320	9	237	218	1,8	42	290
3899572	TDD107Z08500	8,500	.3346	9	238	219	1,8	42	290
3899604	TDD107Z09000	9,000	.3543	9	245	225	1,9	42	290
3899606	TDD107Z09500	9,500	.3740	10	265	244	2,0	44	319
3899607	TDD107Z09525	9,525	.3750	10	266	245	2,0	44	319
3899610	TDD107Z10000	10,000	.3937	10	272	250	2,1	44	319
3899611	TDD107Z10300	10,300	.4055	11	290	267	2,2	46	348
3899612	TDD107Z10320	10,320	.4063	11	290	267	2,2	46	348
3899613	TDD107Z10500	10,500	.4134	11	292	269	2,2	46	348
3899614	TDD107Z10716	10,716	.4219	11	295	272	2,3	46	348
3899615	TDD107Z11000	11,000	.4331	11	299	275	2,3	46	348
3899616	TDD107Z11113	11,113	.4375	12	314	289	2,4	48	377
3899617	TDD107Z11500	11,500	.4528	12	319	294	2,4	48	377
3899619	TDD107Z12000	12,000	.4724	12	326	300	2,5	48	377
3899621	TDD107Z12500	12,500	.4921	13	346	319	2,7	50	406
3899622	TDD107Z12700	12,700	.5000	13	349	322	2,7	50	406
3899623	TDD107Z13000	13,000	.5118	13	353	325	2,8	50	406

NOTE: Use TDS 40xx series as pilot drills, see page C44.

INDEXABLE MILLING

SOLID END MILLING

HOLEMAKING

TAPPING

TURNING

TOP DRILL Deep Hole • 30 x D • TDD108 • 2 Flute

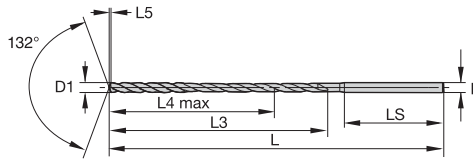

For information on L, L3, and L4 max, see page C29.

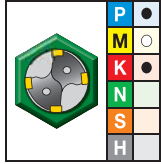

● first choice
○ alternate choice

grade WU20PD TiAlN		D1 diameter		D	L3	L4 max	L5	LS	L
order #	catalogue #	mm	in						
3899539	TDD108Z03000	3,000	.1181	3	97	90	0,6	30	131
3899540	TDD108Z03175	3,175	.1250	4	115	106	0,6	32	165
3899541	TDD108Z03500	3,500	.1378	4	121	112	0,7	32	165
3899573	TDD108Z03800	3,800	.1496	4	126	117	0,8	32	165
3899574	TDD108Z03970	3,970	.1563	4	129	119	0,8	32	165
3899575	TDD108Z04000	4,000	.1575	4	130	120	0,8	32	165
3899576	TDD108Z04039	4,039	.1590	5	144	133	0,8	34	199
3899577	TDD108Z04300	4,300	.1693	5	149	138	0,9	34	199
3899578	TDD108Z04500	4,500	.1772	5	153	142	0,9	34	199
3899579	TDD108Z04623	4,623	.1820	5	155	144	1,0	34	199
3899580	TDD108Z04763	4,763	.1875	5	157	146	1,0	34	199
3899581	TDD108Z05000	5,000	.1969	5	162	150	1,0	34	199
3899582	TDD108Z05159	5,159	.2031	6	179	166	1,1	36	233
3899583	TDD108Z05410	5,410	.2130	6	183	170	1,1	36	233
3899584	TDD108Z05500	5,500	.2165	6	185	172	1,1	36	233
3899586	TDD108Z05800	5,800	.2283	6	190	176	1,2	36	233
3899587	TDD108Z06000	6,000	.2362	6	194	180	1,2	36	233
3899588	TDD108Z06200	6,200	.2441	7	211	196	1,3	38	267
3899589	TDD108Z06350	6,350	.2500	7	214	199	1,3	38	267
3899590	TDD108Z06500	6,500	.2559	7	217	202	1,4	38	267
3899592	TDD108Z06746	6,746	.2656	7	221	205	1,4	38	267
3899593	TDD108Z06800	6,800	.2677	7	222	206	1,4	38	267
3899594	TDD108Z06909	6,909	.2720	7	224	208	1,4	38	267
3899595	TDD108Z07000	7,000	.2756	7	226	210	1,5	38	267
3899600	TDD108Z07145	7,145	.2813	8	242	225	1,5	40	301
3899601	TDD108Z07500	7,500	.2953	8	249	232	1,6	40	301
3899653	TDD108Z07938	7,938	.3125	8	257	239	1,7	40	301
3899654	TDD108Z08000	8,000	.3150	8	258	240	1,7	40	301
3899657	TDD108Z08500	8,500	.3346	9	281	262	1,8	42	335
3899659	TDD108Z09000	9,000	.3543	9	290	270	1,9	42	335
3899661	TDD108Z09500	9,500	.3740	10	313	292	2,0	44	369
3899662	TDD108Z09525	9,525	.3750	10	313	292	2,0	44	369
3899663	TDD108Z09750	9,750	.3839	10	317	295	2,1	44	369
3899665	TDD108Z10000	10,000	.3937	10	322	300	2,1	44	369
3899666	TDD108Z10200	10,200	.4016	11	339	316	2,2	46	403
3899667	TDD108Z10320	10,317	.4062	11	341	318	2,2	46	403
3899668	TDD108Z10500	10,500	.4134	11	345	322	2,2	46	403
3899670	TDD108Z11000	11,000	.4331	11	354	330	2,3	46	403
3899671	TDD108Z11113	11,113	.4375	12	370	345	2,4	48	437
3899672	TDD108Z11500	11,500	.4528	12	377	352	2,4	48	437
3899674	TDD108Z12000	12,000	.4724	12	386	360	2,5	48	437
3899675	TDD108Z12304	12,304	.4844	13	405	378	2,6	50	471
3899676	TDD108Z12500	12,500	.4921	13	409	382	2,7	50	471
3899677	TDD108Z12700	12,700	.5000	13	412	385	2,7	50	471
3899678	TDD108Z13000	13,000	.5118	13	418	390	2,8	50	471

NOTE: Use TDS 40xx series as pilot drills, see page C44.

INDEXABLE MILLING



SOLID END MILLING

HOLEMAKING

TAPPING

TURNING

Application Data • TDD Series • WU20PD™ • Through Coolant • Metric

													
		Cutting Speed – vc		Recommended Feed Rate (fz) by Diameter									
Material Group	Range – m/min												
	min		max										
P	1	90	–	130	mm/r	0,08–0,12	0,12–0,18	0,18–0,20	0,20–0,22	0,22–0,25	0,25–0,28	0,28–0,30	0,30–0,34
	2	80	–	115	mm/r	0,08–0,12	0,12–0,18	0,18–0,20	0,20–0,22	0,22–0,25	0,25–0,28	0,28–0,30	0,30–0,34
	3	70	–	110	mm/r	0,05–0,10	0,10–0,16	0,16–0,18	0,18–0,20	0,20–0,22	0,22–0,24	0,24–0,26	0,26–0,28
	4	65	–	95	mm/r	0,05–0,10	0,10–0,16	0,16–0,18	0,18–0,20	0,20–0,22	0,22–0,24	0,24–0,26	0,26–0,28
K	1	105	–	145	mm/r	0,10–0,15	0,15–0,20	0,20–0,25	0,25–0,28	0,28–0,30	0,30–0,33	0,33–0,36	0,36–0,38
	2	85	–	120	mm/r	0,10–0,15	0,15–0,20	0,20–0,25	0,25–0,28	0,28–0,30	0,30–0,33	0,33–0,36	0,36–0,38
	3	100	–	140	mm/r	0,10–0,15	0,15–0,20	0,20–0,25	0,25–0,28	0,28–0,30	0,30–0,33	0,33–0,36	0,36–0,38

nominal size range	Metric tolerance		
	D1 tolerance	D1 tolerance	D tolerance h6
>3–6	0,000/-0,012	>3–6	0,000/-0,008
>6–10	0,000/-0,015	>6–10	0,000/-0,009
>10–13	0,000/-0,018	>10–13	0,000/-0,011

INDEXABLE MILLING

SOLID END MILLING

HOLEMAKING

TAPPING

TURNING

Deep-Hole Drills Application Rules

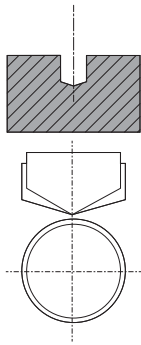

1) Pilot Drill Hole — IMPORTANT!

- The point angle of the pilot drill must be greater than one of the following deep-hole drills to protect its cutting corners.
- The diameter size of the pilot drill must be greater than one of the deep-hole drills to enable easy fit and protect margin lands. The required difference in diameter is covered by design with the different position of tolerance.
- Drill \varnothing = nominal \varnothing up to nominal +0,010mm.
- Depth of pilot hole: minimum 2 x D.
- Deeper pilot holes are preferable.

Recommendations:

- Use a conical (TDS*) or split-point drill to pilot (do not use a TDG, VariDrill™, or TDS 12 x D or any competitive drill).
- Check the pilot drill for wear, which can lead to premature wear on the TDD10* cutting edge and possibly catastrophic failure.
- TOP DRILL S™ for steel or cast iron (TDS4* series) and TOP DRILL S +™ for multiple applications (TDS501* series 3 x D and TD502* series 5 x D) with a 140° point angle are recommended.
- TDS503* series 8 x D and TDS504* series 12 x D is not recommended as the point angle is 132°!

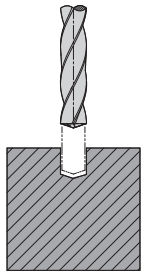

2) Feed TDD10* into Pilot Hole

- Max 500 RPM and recommended feed rate; no rapid traverse.
- Run counter-clockwise, especially in horizontal applications to protect the cutting edge, when entering the pilot hole.
- Depth: 1mm above the bottom of pilot hole.
- Feed TDD10* into pilot hole

Recommendations:

- Reduce cutting speed to minimize imbalances in machine spindle/adaptor!

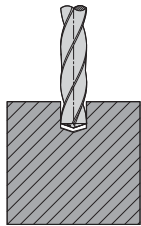

3) Drill Hole

Cutting Parameters: Start recommended speed and feed rate at 1mm from the bottom of the pilot hole, clockwise.

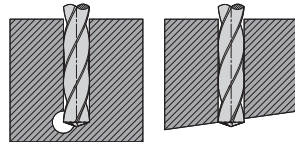

Recommendations:

- DO NOT PECK OR DWELL up to 30 x D!
- With long-chipping steel materials, it may be necessary to increase feed rate by 10–20% to provide optimal chip control.
- For long-chipping aluminum materials, it may be necessary to decrease feed rate and increase speed.
- Reduce feed rate on angled exits and crossholes by 50–60%.

HP feed recommendations are usually higher than with competitive SC drills!

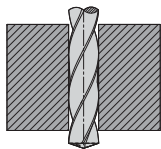

4) Drill Retraction

Cutting Parameters: 50–500 RPM and feed rate 2–6 m/min.

Recommendations:

To achieve the best tool performance, we recommend using the deep-hole drill with a hydraulic chuck.

Reduce cutting speed to minimize imbalances in machine spindle/adaptor!



5) Vertical Applications

- If the pilot holes are close to each other, chips can fall into the neighboring hole.
- Do not enter a pilot hole that might contain chips with a deep hole drill to avoid chip jamming, wear, or breakage.
- If required holes are close to each other, use smart drilling strategies, make sure the pilot holes are getting properly cleaned, or switch to horizontal drilling.



Horizontal drilling process preferred for optimum chip evacuation.

Deep-Hole Drills Application Rules



6) Coolant

- For increased stability, the coolant channels of the TDD10* are smaller than on typical WIDIA® drills.
- Steady supply of coolant delivered to the cutting edges necessary. If coolant supply is not steady or is unequal through both channels, check:
 - Coolant filtering system.
 - Sealing of adapter/spindle.
 - Chips blocking the coolant hole on the drill shank.
- Make sure that the coolant supply reaches the cutting edge before drilling begins.
- Pressure by diameter: <5mm 40–50 bar maximum; >5mm 25 bar minimum.

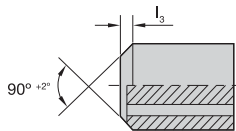

MQL back end according to DIN 69090-3

7) Minimal Quantity Lubrication

- On MQL applications, make sure that the coolant is directly supplied from the chuck into the back end of the drill shank (without gap) to avoid leakage.
- Pressure should be between 1–10 bar depending on coolant hole size.
- Spray contains an amount of oil less than 50 ml/h.
- If required, the shank can be evenly optimized for MQL applications with enlarged 90° chamfer instead of 40°.



8) Shanks

- Other than normal SC Drills, TDD10* series have a “Z” shank, increasing with 1mm steps.
- For drills with uneven shank size, use reduction sleeves to adapt the shank to the customer’s toolholder.
- The clamping force is better with increasing diameter.
- If required, DIN shanks (even, 2mm steps) are available as custom solutions.

Achieve the best tool performance with hydraulic chucks.

D1	12mm hydraulic reducer sleeve		20mm hydraulic reducer sleeve		25mm hydraulic reducer sleeve		32mm hydraulic reducer sleeve		.500" hydraulic reducer sleeve		.750" hydraulic reducer sleeve	
	order number	catalogue number	order number	catalogue number	order number	catalogue number	order number	catalogue number	order number	catalogue number	order number	catalogue number
3	3026450	12MHC030M	3026648	20MHC030M	3026662	25MHC030M	–	–	2248993	50HC030M	2248995	75HC030M
4	3026451	12MHC040M	3026649	20MHC040M	3026663	25MHC040M	–	–	1606050	50HC040M	2248996	75HC040M
5	3026452	12MHC050M	3026650	20MHC050M	3026664	25MHC050M	–	–	2248994	50HC050M	2248997	75HC050M
6	3026643	12MHC060M	3026651	20MHC060M	3026665	25MHC060M	3026675	32MHC060M	1606061	50HC060M	1093271	75HC060M
7	3026644	12MHC070M	3026652	20MHC070M	3026666	25MHC070M	3026676	32MHC070M	–	–	–	–
8	3026645	12MHC080M	3026653	20MHC080M	3026667	25MHC080M	3026677	32MHC080M	1606062	50HC080M	1093272	75HC080M
9	3026646	12MHC090M	3026654	20MHC090M	3026668	25MHC090M	3026678	32MHC090M	–	–	–	–
10	3026647	12MHC100M	3026655	20MHC100M	3026669	25MHC100M	3026679	32MHC100M	1606064	50HC100M	1093273	75HC100M
11	–	–	3026656	20MHC110M	–	–	3026680	32MHC110M	–	–	–	–
12	–	–	3026657	20MHC120M	3026669	25MHC120M	3026681	32MHC120M	–	–	1093524	75HC120M
13	–	–	3026658	20MHC130M	–	–	3026682	32MHC130M	–	–	–	–
14	–	–	3026659	20MHC140M	3026671	25MHC140M	3026683	32MHC140M	–	–	1093525	75HC140M
15	–	–	3026660	20MHC150M	–	–	3026684	32MHC150M	–	–	–	–
16	–	–	3026661	20MHC160M	3026672	25MHC160M	3026685	32MHC160M	–	–	1093526	75HC160M

TOP DRILL™ Series

Solid Carbide Drills • TDS Pilot Drills

The TDS solid carbide drills are primarily designed to be used as a pilot drill for the TDD Deep Hole drill in steel and cast iron applications.



140° point geometry
Low thrust with excellent centering capabilities

2-margin design provides stability and hole quality with less friction

30° helix with optimized flute profile and finish reduces risk of chip jamming

Sub-micron grain substrate
Superior resistance against drill breakage

The Solid Carbide TDS4 series is designed with a 140° point angle suited for pilot drill for the TDD series. Excellent centering and hole quality is attained by the TDS point and 2-margin design.

TDS40.. Steel
TDS45.. Stainless Steel
TDS41.. Cast Iron

WP20PD



P

WM15PD



M

WK15PD



K

PILOT DRILL

PRODUCT

TDS P Point with 140° P point angle for excellent centering and low thrust

DIAMETER RANGE

3–13mm

INDUSTRY



ENERGY



GENERAL ENGINEERING



TRANSPORTATION

APPLICATIONS



DRILLING



FLOOD COOLANT: DRILLING



COOLANT: DRY: DRILLING



THROUGH COOLANT



MQL (MINIMUM QUANTITY LUBRICANT)



2 FLUTE/2 MARGIN/ COOLANT



HELIX ANGLE: 30°



PLAIN SHANK: ≤H6



DIN 6535



DIN 6537

SERIES

MATERIAL

FIRST CHOICE SECOND CHOICE

COOLANT

LENGTH RATIO

DIAMETER RANGE

TDS401

P

M

Through Coolant

3 x D

3,0–13,0mm

TDS451

M

P S

Through Coolant

3 x D

3,0–13,0mm

TDS411

K

Through Coolant

3 x D

3,0–13,0mm

5 x D and 8 x D available on WIDIA.com

Shank Style

A - Shank DIN 6535 HA
(Round cylindrical)



TDS • Catalog Numbering System

Each character in our catalog number signifies a specific trait of that product.
Use the following key columns and corresponding images to easily identify which attributes apply.

TDS	4	0	1	A	06350	WP20PD
Top Drill Spiral	Flute Style - Coolant	Point	Length	Shank	Diameter in Metric	
	<p>4 = 2 Flute Spiral Through Coolant, 2 margin lands</p>	<p>0 = Cone Point Steel Specific</p>	<p>1 = ~ 3 x D 2 = ~ 5 x D 3 = ~ 8 x D</p>	<p>A = Cylindrical Shank, DIN 6535 - 2mm steps</p>	<p>03000 = 3,000mm 06350 = 1/4" = E</p>	<p>WIDIA™; P = Steel Application 20 & 25 = medium carbide, PVD coated, SC Drill</p>

TDS401A • A-Shank • WP20PD™ • 3 x D

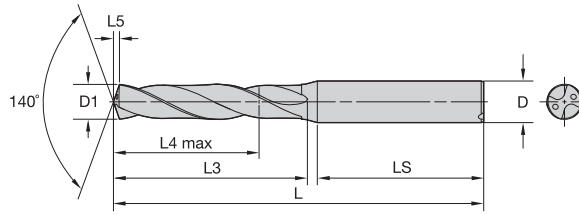

For information on L, L3, and L4 max, see page C29.

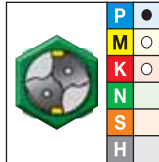

● first choice
○ alternate choice

grade WP20PD TiAlN		D1 diameter		L	L3	L4 max	L5	LS	D
order #	catalogue #	mm	in						
4163315	TDS401A03000	3,000	.1181	62	20	14	0,5	36	6
4163339	TDS401A03175	3,175	.1250	62	20	14	0,5	36	6
4163465	TDS401A03500	3,500	.1378	62	20	14	0,6	36	6
4163473	TDS401A03970	3,970	.1563	66	24	17	0,7	36	6
4163474	TDS401A04000	4,000	.1575	66	24	17	0,7	36	6
4163475	TDS401A04039	4,039	.1590	66	24	17	0,7	36	6
4163483	TDS401A04500	4,500	.1772	66	24	17	0,7	36	6
4163487	TDS401A04763	4,763	.1875	66	28	20	0,8	36	6
4163491	TDS401A05000	5,000	.1969	66	28	20	0,8	36	6
4163492	TDS401A05100	5,100	.2008	66	28	20	0,8	36	6
4163498	TDS401A05410	5,410	.2130	66	28	20	0,9	36	6
4163499	TDS401A05500	5,500	.2165	66	28	20	0,9	36	6
4163500	TDS401A05558	5,558	.2188	66	28	20	0,9	36	6
4163504	TDS401A05800	5,800	.2283	66	28	20	1,0	36	6
4163507	TDS401A06000	6,000	.2362	66	28	20	1,0	36	6
4163511	TDS401A06350	6,350	.2500	79	34	24	1,1	36	8
4163513	TDS401A06500	6,500	.2559	79	34	24	1,1	36	8
4163514	TDS401A06528	6,528	.2570	79	34	24	1,1	36	8
4163518	TDS401A06746	6,746	.2656	79	34	24	1,1	36	8
4163519	TDS401A06800	6,800	.2677	79	34	24	1,1	36	8
4163520	TDS401A06900	6,900	.2717	79	34	24	1,2	36	8
4163521	TDS401A07000	7,000	.2756	79	34	24	1,2	36	8
4163523	TDS401A07145	7,145	.2813	79	41	29	1,2	36	8
4163525	TDS401A07300	7,300	.2874	79	41	29	1,2	36	8
4163526	TDS401A07400	7,400	.2913	79	41	29	1,3	36	8
4163531	TDS401A07800	7,800	.3071	79	41	29	1,3	36	8
4163533	TDS401A07938	7,938	.3125	79	41	29	1,3	36	8
4163534	TDS401A08000	8,000	.3150	79	41	29	1,4	36	8
4163536	TDS401A08200	8,200	.3228	89	47	35	1,4	40	10
4163538	TDS401A08334	8,334	.3281	89	47	35	1,4	40	10
4163540	TDS401A08433	8,433	.3320	89	47	35	1,4	40	10
4163541	TDS401A08500	8,500	.3346	89	47	35	1,4	40	10
4163544	TDS401A08733	8,733	.3438	89	47	35	1,5	40	10
4163545	TDS401A08800	8,800	.3465	89	47	35	1,5	40	10
4163547	TDS401A09000	9,000	.3543	89	47	35	1,5	40	10
4163551	TDS401A09300	9,300	.3661	89	47	35	1,6	40	10
4163552	TDS401A09347	9,347	.3680	89	47	35	1,6	40	10
4163554	TDS401A09500	9,500	.3740	89	47	35	1,6	40	10
4163555	TDS401A09525	9,525	.3750	89	47	35	1,6	40	10
4163556	TDS401A09600	9,600	.3780	89	47	35	1,6	40	10
4162950	TDS401A10000	10,000	.3937	89	47	35	1,7	40	10
4162952	TDS401A10200	10,200	.4016	102	55	40	1,7	45	12
4163344	TDS401A10320	10,320	.4063	102	55	40	1,8	45	12
4163346	TDS401A10500	10,500	.4134	102	55	40	1,8	45	12
4163348	TDS401A10700	10,700	.4213	102	55	40	1,8	45	12
4163349	TDS401A10716	10,716	.4219	102	55	40	1,8	45	12
4163350	TDS401A10800	10,800	.4252	102	55	40	1,8	45	12
4163352	TDS401A11000	11,000	.4331	102	55	40	1,9	45	12
4163354	TDS401A11113	11,113	.4375	102	55	40	1,9	45	12
4163358	TDS401A11500	11,500	.4528	102	55	40	2,0	45	12
4163365	TDS401A12000	12,000	.4724	102	55	40	2,1	45	12
4163367	TDS401A12200	12,200	.4803	107	60	43	2,1	45	14
4163369	TDS401A12304	12,304	.4844	107	60	43	2,1	45	14
4163371	TDS401A12500	12,500	.4921	107	60	43	2,1	45	14
4163373	TDS401A12700	12,700	.5000	107	60	43	2,2	45	14
4163376	TDS401A13000	13,000	.5118	107	60	43	2,2	45	14

TDS401A • A-Shank • WP20PD™ • 3 x D

(continued)

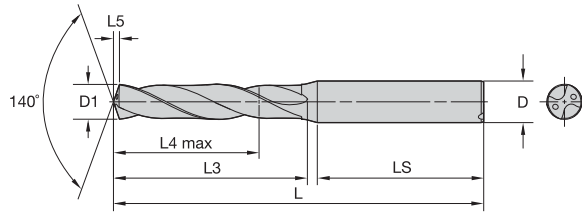

For information on L, L3, and L4 max, see page C29.

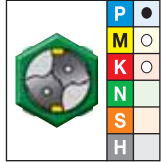

● first choice
○ alternate choice

grade WP20PD TiAlN		D1 diameter		L	L3	L4 max	L5	LS	D
order #	catalogue #	mm	in						
4163382	TDS401A13500	13,500	.5315	107	60	43	2,3	45	14
4163388	TDS401A14000	14,000	.5512	107	60	43	2,4	45	14
4163397	TDS401A14700	14,700	.5787	115	65	45	2,5	48	16
4163407	TDS401A15500	15,500	.6102	115	65	45	2,7	48	16

TDS451A • A-Shank • WM15PD™ • 3 x D

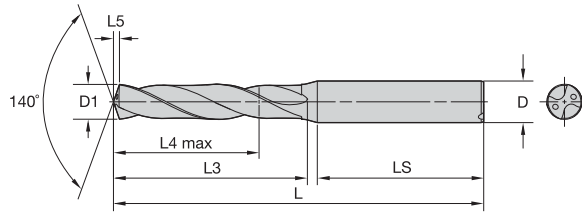

For information on L, L3, and L4 max, see page C29.

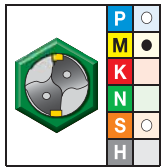

- first choice
- alternate choice

grade WM15PD uncoated		D1 diameter		L	L3	L4 max	L5	LS	D
order #	catalogue #	mm	in						
6327750	TDS451A04852	4,852	.1910	66	28	20	0,8	36	6
6327752	TDS451A05000	5,000	.1969	66	28	20	0,8	36	6
6327772	TDS451A06350	6,350	.2500	79	34	24	1,1	36	8
6327779	TDS451A06746	6,746	.2656	79	34	24	1,1	36	8
6327780	TDS451A06800	6,800	.2677	79	34	24	1,1	36	8
6327795	TDS451A08000	8,000	.3150	79	41	29	1,4	36	8
6327806	TDS451A08800	8,800	.3465	89	47	35	1,5	40	10
6327808	TDS451A09000	9,000	.3543	89	47	35	1,5	40	10
6327817	TDS451A09600	9,600	.3780	89	47	35	1,6	40	10
6327822	TDS451A10000	10,000	.3937	89	47	35	1,7	40	10
6327844	TDS451A11000	11,000	.4331	102	55	40	1,9	45	12
6327845	TDS451A11100	11,100	.4370	102	55	40	1,9	45	12
6327857	TDS451A12000	12,000	.4724	102	55	40	2,1	45	12
6327869	TDS451A13096	13,096	.5156	107	60	43	2,3	45	14
6327884	TDS451A13500	13,500	.5315	107	60	43	2,3	45	14
6327887	TDS451A13800	13,800	.5433	107	60	43	2,4	45	14
6327890	TDS451A14000	14,000	.5512	107	60	43	2,4	45	14
6327917	TDS451A16200	16,200	.6378	123	73	51	2,8	48	18
6327928	TDS451A17100	17,100	.6732	123	73	51	3,0	48	18
6327930	TDS451A17300	17,300	.6811	123	73	51	3,0	48	18

INDEXABLE MILLING

SOLID END MILLING

HOLEMAKING

TAPPING

TURNING

INDEXABLE MILLING

SOLID END MILLING

HOLEMAKING

TAPPING

TURNING

TDS411A • A-Shank • WK15PD™ • 3 x D

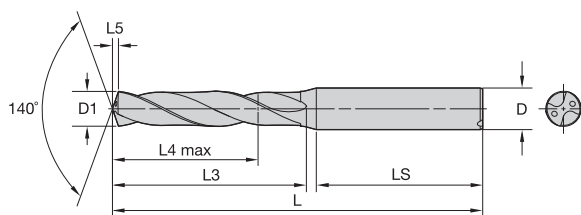

For information on L, L3, and L4 max, see page C29.



- first choice
- alternate choice

grade WK15PD AlCrN		D1 diameter		L	L3	L4 max	L5	LS	D
order #	catalogue #	mm	in						
4156605	TDS411A10300	10,300	.4055	102	55	40	1,8	45	12
4156614	TDS411A11000	11,000	.4331	102	55	40	1,9	45	12
4156633	TDS411A12500	12,500	.4921	107	60	43	2,1	45	14
4156638	TDS411A13000	13,000	.5118	107	60	43	2,2	45	14
4156644	TDS411A13500	13,500	.5315	107	60	43	2,3	45	14
4156675	TDS411A16000	16,000	.6299	115	65	45	2,8	48	16

Application Data • TDS Series • WP20PD™ • Through Coolant • Metric

Material Group	Cutting Speed – vc Range – m/min			Recommended Feed Rate (f) by Diameter									
	min	-	max	Tool Diameter (mm)	3,0	4,0	6,0	8,0	10,0	12,0	16,0	20,0	
	P	0	80	-	180	mm/r	0,08–0,16	0,11–0,19	0,13–0,26	0,16–0,32	0,16–0,36	0,21–0,40	0,24–0,47
	1	80	-	180	mm/r	0,08–0,16	0,11–0,19	0,13–0,26	0,16–0,32	0,16–0,36	0,21–0,40	0,24–0,47	0,29–0,58
	2	80	-	160	mm/r	0,09–0,17	0,11–0,20	0,13–0,26	0,16–0,32	0,20–0,36	0,23–0,40	0,29–0,50	0,36–0,63
	3	80	-	160	mm/r	0,09–0,17	0,11–0,20	0,13–0,26	0,16–0,32	0,20–0,36	0,23–0,40	0,29–0,50	0,36–0,63
	4	80	-	140	mm/r	0,08–0,17	0,11–0,20	0,12–0,26	0,15–0,32	0,18–0,35	0,21–0,40	0,25–0,50	0,30–0,63
	5	50	-	80	mm/r	0,06–0,11	0,08–0,13	0,11–0,21	0,10–0,23	0,13–0,25	0,14–0,28	0,19–0,33	0,25–0,44
	6	50	-	80	mm/r	0,06–0,11	0,08–0,13	0,11–0,21	0,10–0,23	0,13–0,25	0,14–0,28	0,19–0,33	0,25–0,44
M	1	40	-	60	mm/r	0,05–0,09	0,06–0,12	0,08–0,14	0,09–0,16	0,11–0,18	0,13–0,21	0,15–0,23	0,17–0,26
	2	40	-	70	mm/r	0,05–0,11	0,07–0,13	0,09–0,14	0,11–0,19	0,11–0,21	0,13–0,23	0,15–0,26	0,17–0,29
	3	35	-	50	mm/r	0,05–0,09	0,07–0,12	0,08–0,13	0,09–0,16	0,11–0,18	0,13–0,20	0,15–0,22	0,17–0,26

Application Data • TDS Series • WM15PD™ • Through Coolant • Metric

Material Group	Cutting Speed – vc Range – m/min			Recommended Feed Rate (f) by Diameter									
	min	-	max	Tool Diameter (mm)	3,0	4,0	6,0	8,0	10,0	12,0	16,0	20,0	
	P	0	80	-	160	mm/r	0,05–0,11	0,08–0,14	0,09–0,19	0,11–0,22	0,13–0,26	0,15–0,30	0,19–0,36
	1	70	-	140	mm/r	0,05–0,13	0,08–0,19	0,11–0,24	0,14–0,30	0,16–0,35	0,18–0,39	0,20–0,46	0,23–0,51
	2	90	-	140	mm/r	0,05–0,13	0,08–0,17	0,11–0,20	0,14–0,24	0,16–0,28	0,18–0,32	0,20–0,37	0,23–0,41
	3	60	-	100	mm/r	0,08–0,13	0,12–0,19	0,14–0,24	0,17–0,30	0,20–0,35	0,22–0,39	0,26–0,46	0,29–0,51
	4	50	-	100	mm/r	0,08–0,12	0,11–0,18	0,12–0,23	0,15–0,28	0,17–0,33	0,19–0,37	0,22–0,43	0,25–0,48
	5	50	-	80	mm/r	0,03–0,11	0,04–0,11	0,05–0,11	0,05–0,14	0,08–0,18	0,11–0,21	0,14–0,24	0,16–0,26
	6	40	-	70	mm/r	0,05–0,11	0,08–0,14	0,11–0,17	0,13–0,21	0,15–0,24	0,17–0,27	0,19–0,33	0,22–0,36
M	1	50	-	90	mm/r	0,05–0,13	0,06–0,14	0,08–0,16	0,10–0,18	0,12–0,20	0,13–0,21	0,16–0,24	0,18–0,26
	2	50	-	80	mm/r	0,05–0,13	0,06–0,14	0,08–0,16	0,10–0,18	0,12–0,20	0,13–0,21	0,16–0,24	0,18–0,26
	3	50	-	70	mm/r	0,05–0,13	0,06–0,14	0,08–0,16	0,10–0,18	0,12–0,20	0,13–0,21	0,16–0,24	0,18–0,26
S	1	20	-	30	mm/r	0,03–0,06	0,04–0,08	0,06–0,10	0,08–0,12	0,09–0,13	0,10–0,14	0,12–0,16	0,14–0,18
	2	10	-	30	mm/r	0,02–0,04	0,03–0,06	0,05–0,08	0,07–0,10	0,08–0,11	0,09–0,12	0,10–0,14	0,11–0,16
	3	10	-	40	mm/r	0,02–0,04	0,02–0,05	0,04–0,07	0,06–0,09	0,07–0,10	0,08–0,11	0,09–0,13	0,10–0,15
	4	10	-	40	mm/r	0,02–0,04	0,03–0,06	0,05–0,08	0,07–0,10	0,08–0,11	0,09–0,12	0,10–0,14	0,11–0,16

Application Data • TDS Series • WK15PD™ • Through Coolant • Metric

Material Group	Cutting Speed – vc Range – m/min			Recommended Feed Rate (f) by Diameter									
	min	-	max	Tool Diameter (mm)	3,0	4,0	6,0	8,0	10,0	12,0	16,0	20,0	
	K	1	80	-	190	mm/r	0,11–0,22	0,12–0,24	0,16–0,31	0,20–0,38	0,23–0,44	0,25–0,49	0,31–0,60
	2	90	-	170	mm/r	0,12–0,16	0,13–0,19	0,16–0,25	0,20–0,31	0,23–0,36	0,25–0,40	0,31–0,48	0,38–0,60
	3	80	-	150	mm/r	0,08–0,17	0,09–0,19	0,12–0,25	0,14–0,30	0,17–0,35	0,19–0,40	0,24–0,48	0,30–0,60

Metric tolerance

nominal size range	D1 tolerance m7	D tolerance h6
>3–6	0,004/0,016	0,000/-0,008
>6–10	0,006/0,021	0,000/-0,009
>10–18	0,007/0,025	0,000/-0,011
>18–25,4	0,008/0,029	0,000/-0,013

TOP DRILL™ Modular X

TDMX™

The TDMX modular drill will deliver maximum clamping stability between the carbide insert and the pocket seat, enabling safe operations under unstable conditions using material-specific point geometries and grades.



Extra stable pocket seat design to increase stability to securely face high demanding applications.

Coolant channels exit behind the cutting edge to ensure the best coolant delivery.

Two standard screws clamp and unclamp the insert, without disassembling the tool from the holder.

Margin lands on the entire body length to ensure straightness and increased hole quality.

Polished flutes
Improved chip evacuation.

The TDMX modular drilling line features material-specific inserts seated in an advanced pocket seat design which maximizes the insert clamping rigidity and enables higher productivity even under unstable machining conditions.

TDMX heads can be re-conditioned to increase the total life cycle of the tool.

PK



First choice for steel and cast iron drilling.

FPE



Flat bottom drilling, stacked plates, piloting for deep hole drilling.

MS



First choice for stainless steel and super alloys.

MODULAR STABILITY

PRODUCT

POINT GEOMETRY/GRADE

FPE / WP40PD
PK / WP40PD
MS / WM15PD

DIAMETER RANGE

16-40mm

INDUSTRY



MATERIALS

FIRST CHOICE



APPLICATIONS



DRILLING



INCLINED
ENTRY



INCLINED
EXIT



CROSS
HOLES



STACKED
PLATES



FLAT
BOTTOM

STEEL BODIES

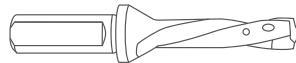
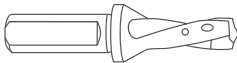

FLANGED SHANK

Increase overall drill stability in deep-drilling applications. Suitable for machining and turning centers.

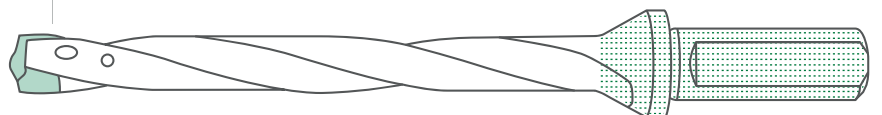

TDMX™ Inserts • Catalog Numbering System

Each character in our catalog number signifies a specific trait of that product. Use the following key columns and corresponding images to easily identify which attributes apply.

TDMX	20000	PK	M	WP40PD
TOP DRILL™ Modular X	Insert Diameter	Insert Geometry	Metric Insert	Grade
	Metric = 20mm	PK = steel and cast iron		WIDIA™ ; P = Primarily steel Application 30 & 40 = tough carbide, PVD coated, Modular Drilling Insert

TDMX Bodies • Catalog Numbering System

Each character in our catalog number signifies a specific trait of that product. Use the following key columns and corresponding images to easily identify which attributes apply.

TDMX	200	R5	SL	25	M
Top Drill Modular X	Drill Body Diameter	L/D Ratio	Shank Style	Shank Diameter	Metric Insert
	Metric = 20mm	5 x D	Side Lock	25mm	

TOP DRILL Modular X • 1.5 x D • Side Lock Shank • Metric

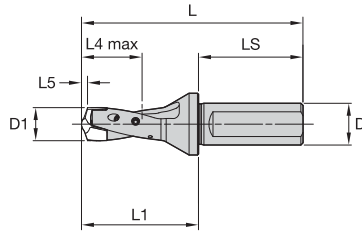

order number	catalogue number	SSC	D1	D1 max	LS	D	L	L1	L4 max
6680951	TDMX160R1SL20M	A	16,000	16,999	50	20	106	56	26
6680952	TDMX170R1SL20M	B	17,000	17,999	50	20	109	59	27
6680953	TDMX180R1SL25M	C	18,000	18,999	56	25	118	62	29
6680954	TDMX190R1SL25M	D	19,000	19,999	56	25	121	65	30
6680955	TDMX200R1SL25M	E	20,000	20,999	56	25	124	68	32
6680956	TDMX210R1SL25M	F	21,000	21,999	56	25	127	71	33
6680957	TDMX220R1SL25M	G	22,000	22,999	56	25	130	74	35
6680958	TDMX230R1SL25M	H	23,000	23,999	56	25	133	77	36
6680959	TDMX240R1SL32M	I	24,000	24,999	60	32	140	80	38
6680960	TDMX250R1SL32M	J	25,000	25,999	60	32	143	83	39
6680971	TDMX260R1SL32M	K	26,000	26,999	60	32	146	86	41
6680972	TDMX270R1SL32M	L	27,000	27,999	60	32	149	89	42
6680973	TDMX280R1SL32M	M	28,000	28,999	60	32	152	92	44
6680974	TDMX290R1SL32M	N	29,000	29,999	60	32	155	95	45
6680975	TDMX300R1SL32M	O	30,000	30,999	60	32	158	98	47
6680976	TDMX310R1SL32M	P	31,000	31,999	60	32	161	101	48

NOTE: SSC = Pocket Seat Reference. To correspond with the SSC on the inserts.
L5 is dependent on the insert.

TOP DRILL Modular X • 3 x D • Side Lock Shank • Metric

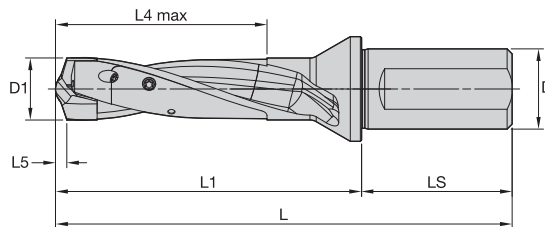

order number	catalogue number	SSC	D1	D1 max	LS	D	L	L1	L4 max
6572091	TDMX160R3SL20M	A	16,000	16,999	50	20	131	81	51
6572092	TDMX170R3SL20M	B	17,000	17,999	50	20	136	86	54
6572093	TDMX180R3SL25M	C	18,000	18,999	56	25	146	90	57
6572094	TDMX190R3SL25M	D	19,000	19,999	56	25	151	95	60
6572096	TDMX200R3SL25M	E	20,000	20,999	56	25	155	99	63
6572097	TDMX210R3SL25M	F	21,000	21,999	56	25	160	104	66
6572098	TDMX220R3SL25M	G	22,000	22,999	56	25	164	108	69
6572099	TDMX230R3SL25M	H	23,000	23,999	56	25	169	113	72
6572100	TDMX240R3SL32M	I	24,000	24,999	60	32	177	117	75
6572101	TDMX250R3SL32M	J	25,000	25,999	60	32	182	122	78
6572102	TDMX260R3SL32M	K	26,000	26,999	60	32	186	126	81
6572104	TDMX270R3SL32M	L	27,000	27,999	60	32	191	131	84
6572105	TDMX280R3SL32M	M	28,000	28,999	60	32	195	135	87
6572106	TDMX290R3SL32M	N	29,000	29,999	60	32	200	140	90
6572107	TDMX300R3SL32M	O	30,000	30,999	60	32	204	144	93
6572108	TDMX310R3SL32M	P	31,000	31,999	60	32	209	149	96
6572109	TDMX320R3SL40M	Q	32,000	33,999	70	40	228	158	102
6572110	TDMX340R3SL40M	R	34,000	35,999	70	40	237	167	108
6572121	TDMX360R3SL40M	S	36,000	37,999	70	40	246	176	114
6572122	TDMX380R3SL40M	T	38,000	40,000	70	40	255	185	120

NOTE: SSC = Pocket Seat Reference. To correspond with the SSC on the inserts.
L5 is dependent on the insert.

INDEXABLE MILLING

SOLID END MILLING

HOLEMAKING

TAPPING

TURNING

TOP DRILL Modular X • 5 x D • Side Lock Shank • Metric

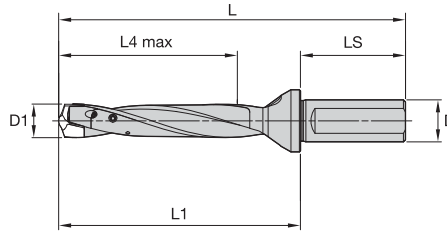

order number	catalogue number	SSC	D1	D1 max	LS	D	L	L1	L4 max
6572125	TDMX160R5SL20M	A	16,000	16,999	50	20	165	115	85
6572126	TDMX170R5SL20M	B	17,000	17,999	50	20	172	122	90
6572127	TDMX180R5SL25M	C	18,000	18,999	56	25	184	128	95
6572128	TDMX190R5SL25M	D	19,000	19,999	56	25	191	135	100
6572129	TDMX200R5SL25M	E	20,000	20,999	56	25	197	141	105
6572130	TDMX210R5SL25M	F	21,000	21,999	56	25	204	148	110
6572141	TDMX220R5SL25M	G	22,000	22,999	56	25	210	154	115
6572142	TDMX230R5SL25M	H	23,000	23,999	56	25	217	161	120
6572143	TDMX240R5SL32M	I	24,000	24,999	60	32	227	167	125
6572144	TDMX250R5SL32M	J	25,000	25,999	60	32	234	174	130
6572145	TDMX260R5SL32M	K	26,000	26,999	60	32	240	180	135
6572146	TDMX270R5SL32M	L	27,000	27,999	60	32	247	187	140
6572147	TDMX280R5SL32M	M	28,000	28,999	60	32	253	193	145
6572148	TDMX290R5SL32M	N	29,000	29,999	60	32	260	200	150
6572149	TDMX300R5SL32M	O	30,000	30,999	60	32	266	206	155
6572150	TDMX310R5SL32M	P	31,000	31,999	60	32	273	213	160
6572151	TDMX320R5SL40M	Q	32,000	33,999	70	40	296	226	170
6572152	TDMX340R5SL40M	R	34,000	35,999	70	40	309	239	180
6572153	TDMX360R5SL40M	S	36,000	37,999	70	40	322	252	190
6572154	TDMX380R5SL40M	T	38,000	40,000	70	40	335	265	200

NOTE: SSC = Pocket Seat Reference. To correspond with the SSC on the inserts.
L5 is dependent on the insert.

TOP DRILL Modular X • 8 x D • Side Lock Shank • Metric

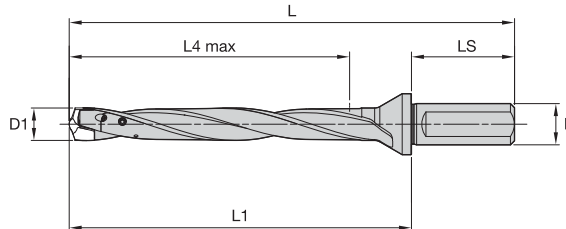

order number	catalogue number	SSC	D1	D1 max	LS	D	L	L1	L4 max
6572155	TDMX160R8SL20M	A	16,000	16,999	50	20	216	166	136
6572156	TDMX170R8SL20M	B	17,000	17,999	50	20	226	176	144
6572157	TDMX180R8SL25M	C	18,000	18,999	56	25	241	185	152
6572158	TDMX190R8SL25M	D	19,000	19,999	56	25	251	195	160
6572159	TDMX200R8SL25M	E	20,000	20,999	56	25	260	204	168
6572160	TDMX210R8SL25M	F	21,000	21,999	56	25	270	214	176
6572171	TDMX220R8SL25M	G	22,000	22,999	56	25	279	223	184
6572172	TDMX230R8SL25M	H	23,000	23,999	56	25	289	233	192
6572173	TDMX240R8SL32M	I	24,000	24,999	60	32	302	242	200
6572174	TDMX250R8SL32M	J	25,000	25,999	60	32	312	252	208
6572175	TDMX260R8SL32M	K	26,000	26,999	60	32	321	261	216
6572176	TDMX270R8SL32M	L	27,000	27,999	60	32	331	271	224
6572177	TDMX280R8SL32M	M	28,000	28,999	60	32	340	280	232
6572178	TDMX290R8SL32M	N	29,000	29,999	60	32	350	290	240
6572179	TDMX300R8SL32M	O	30,000	30,999	60	32	359	299	248
6572180	TDMX310R8SL32M	P	31,000	31,999	60	32	369	309	256
6572181	TDMX320R8SL40M	Q	32,000	33,999	70	40	398	328	272
6572182	TDMX340R8SL40M	R	34,000	35,999	70	40	417	374	288
6572183	TDMX360R8SL40M	S	36,000	37,999	70	40	436	366	304
6572184	TDMX380R8SL40M	T	38,000	40,000	70	40	455	385	320

NOTE: SSC = Pocket Seat Reference. To correspond with the SSC on the inserts.
L5 is dependent on the insert.

INDEXABLE MILLING

SOLID END MILLING

HOLEMAKING

TAPPING

TURNING

TOP DRILL Modular X • 12 x D • Flanged Round Shank • Metric

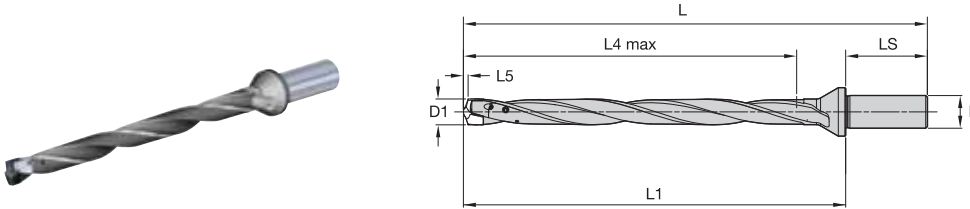

order number	catalogue number	SSC	D1	D1 max	LS	D	L	L1	L4 max
6681017	TDMX160R12SF20M	A	16,000	16,999	50	20	284	234	204
6681018	TDMX170R12SF20M	B	17,000	17,999	50	20	298	248	216
6681019	TDMX180R12SF25M	C	18,000	18,999	56	25	317	261	228
6681020	TDMX190R12SF25M	D	19,000	19,999	56	25	331	275	240
6681041	TDMX200R12SF25M	E	20,000	20,999	56	25	344	288	252
6681042	TDMX210R12SF25M	F	21,000	21,999	56	25	358	302	264
6681043	TDMX220R12SF25M	G	22,000	22,999	56	25	371	315	276
6681044	TDMX230R12SF25M	H	23,000	23,999	56	25	385	329	288
6681045	TDMX240R12SF32M	I	24,000	24,999	60	32	402	342	300
6681046	TDMX250R12SF32M	J	25,000	25,999	60	32	416	356	312
6681047	TDMX260R12SF32M	K	26,000	26,999	60	32	429	369	324
6681049	TDMX270R12SF32M	L	27,000	27,999	60	32	443	383	336
6681050	TDMX280R12SF32M	M	28,000	28,999	60	32	456	396	348
6681051	TDMX290R12SF32M	N	29,000	29,999	60	32	470	410	360
6681052	TDMX300R12SF32M	O	30,000	30,999	60	32	483	423	372
6681053	TDMX310R12SF32M	P	31,000	31,999	60	32	497	437	384

NOTE: SSC = Pocket Seat Reference. To correspond with the SSC on the inserts.
L5 is dependent on the insert.

INDEXABLE MILLING

SOLID END MILLING

HOLEMAKING

TAPPING

TURNING

TOP DRILL Modular X • Inserts • PK

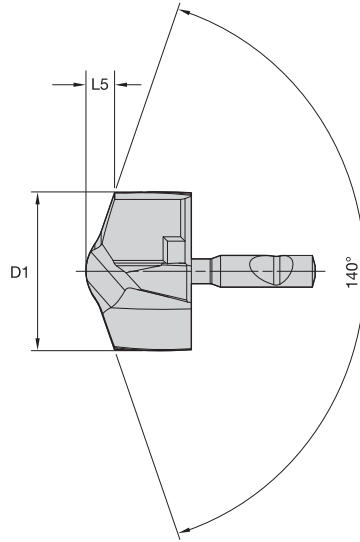

- first choice
- alternate choice

P		●
M		○
K		●
N		○
S		○
H		○

catalogue number	D1	L5	SSC	WP40PD
TDMX16000PKM	16,00	3,21	A	6568446
TDMX16200PKM	16,20	3,25	A	6568447
TDMX16281PKM	16,28	3,26	A	6568448
TDMX16500PKM	16,50	3,30	A	6568449
TDMX16667PKM	16,67	3,33	A	6568450
TDMX17000PKM	17,00	3,39	B	6568461
TDMX17064PKM	17,06	3,41	B	6568462
TDMX17463PKM	17,46	3,48	B	6568464
TDMX17500PKM	17,50	3,49	B	6568465
TDMX17600PKM	17,60	3,50	B	6568467
TDMX17800PKM	17,80	3,54	B	6568471
TDMX17859PKM	17,86	3,55	B	6568472
TDMX18000PKM	18,00	3,58	C	6568473
TDMX18255PKM	18,26	3,64	C	6568474
TDMX18500PKM	18,50	3,68	C	6568475
TDMX18651PKM	18,65	3,71	C	6568476
TDMX18800PKM	18,80	3,74	C	6568477
TDMX19000PKM	19,00	3,78	D	6568478
TDMX19050PKM	19,05	3,78	D	6568479
TDMX19200PKM	19,20	3,81	D	6568480
TDMX19270PKM	19,27	3,82	D	6568481
TDMX19450PKM	19,45	3,86	D	6568482
TDMX19500PKM	19,50	3,87	D	6568483
TDMX19700PKM	19,70	3,90	D	6568484
TDMX19840PKM	19,84	3,93	D	6568485
TDMX20000PKM	20,00	3,97	E	6568813
TDMX20100PKM	20,10	3,99	E	6568814
TDMX20200PKM	20,20	4,01	E	6568815
TDMX20239PKM	20,24	4,02	E	6568816
TDMX20300PKM	20,30	4,03	E	6568817
TDMX20400PKM	20,40	4,05	E	6568818
TDMX20500PKM	20,50	4,06	E	6568819
TDMX20600PKM	20,60	4,08	E	6568820
TDMX20650PKM	20,65	4,09	E	6568841
TDMX20700PKM	20,70	4,10	E	6568842
TDMX20800PKM	20,80	4,12	E	6568843
TDMX20900PKM	20,90	4,14	E	6568844
TDMX21000PKM	21,00	4,16	F	6568845
TDMX21430PKM	21,43	4,23	F	6568846
TDMX21500PKM	21,50	4,25	F	6568847
TDMX22000PKM	22,00	4,35	G	6568848
TDMX22225PKM	22,23	4,39	G	6568849
TDMX22450PKM	22,45	4,44	G	6568850
TDMX22500PKM	22,50	4,44	G	6568851
TDMX23000PKM	23,00	4,54	H	6568852
TDMX23500PKM	23,50	4,63	H	6568853
TDMX23813PKM	23,81	4,68	H	6568854
TDMX24000PKM	24,00	4,73	I	6568856
TDMX24500PKM	24,50	4,82	I	6568857
TDMX24605PKM	24,61	4,84	I	6568858
TDMX25000PKM	25,00	4,91	J	6568859
TDMX25400PKM	25,40	4,99	J	6568860

TOP DRILL Modular X • Inserts • PK

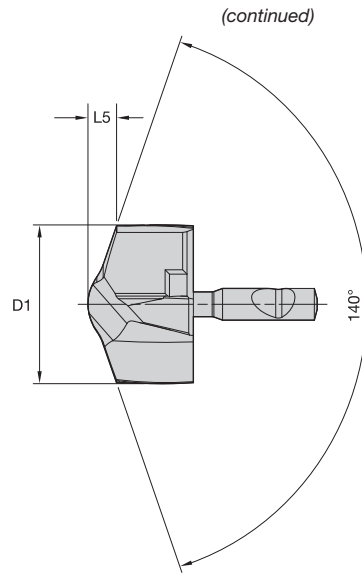

- first choice
- alternate choice

P		●
M		○
K		●
N		
S		
H		

catalogue number	D1	L5	SSC	WP40PD
TDMX25500PKM	25,50	5,01	J	6568861
TDMX25670PKM	25,67	5,04	J	6568862
TDMX25700PKM	25,70	5,04	J	6568863
TDMX25760PKM	25,76	5,05	J	6568864
TDMX25796PKM	25,80	5,06	J	6568865
TDMX26000PKM	26,00	5,11	K	6568866
TDMX26192PKM	26,19	5,15	K	6568867
TDMX26400PKM	26,40	5,18	K	6568868
TDMX26500PKM	26,50	5,20	K	6568869
TDMX26589PKM	26,59	5,22	K	6568870
TDMX27000PKM	27,00	5,29	L	6568871
TDMX27500PKM	27,50	5,38	L	6568872
TDMX27780PKM	27,78	5,43	L	6568873
TDMX28000PKM	28,00	5,49	M	6568874
TDMX28176PKM	28,18	5,52	M	6568875
TDMX28500PKM	28,50	5,58	M	6568876
TDMX28575PKM	28,58	5,59	M	6568877
TDMX29000PKM	29,00	5,67	N	6568878
TDMX29367PKM	29,37	5,74	N	6568879
TDMX29500PKM	29,50	5,76	N	6568880
TDMX29764PKM	29,76	5,81	N	6568891
TDMX30000PKM	30,00	5,87	O	6568892
TDMX30163PKM	30,16	5,90	O	6568893
TDMX30500PKM	30,50	5,96	O	6568896
TDMX30955PKM	30,96	6,04	O	6568897
TDMX31000PKM	31,00	6,05	P	6568898
TDMX31500PKM	31,50	6,14	P	6568899
TDMX31750PKM	31,75	6,18	P	6568900
TDMX32000PKM	32,00	6,25	Q	6568901
TDMX32500PKM	32,50	6,34	Q	6568902
TDMX33000PKM	33,00	6,43	Q	6568903
TDMX33338PKM	33,34	6,49	Q	6568904
TDMX34000PKM	34,00	6,61	R	6568905
TDMX34130PKM	34,13	6,64	R	6568906
TDMX34925PKM	34,93	6,78	R	6568907
TDMX35000PKM	35,00	6,79	R	6568908
TDMX35500PKM	35,50	6,89	R	6568909
TDMX36000PKM	36,00	7,00	S	6568910
TDMX36500PKM	36,50	7,09	S	6568911
TDMX37000PKM	37,00	7,18	S	6568912
TDMX37500PKM	37,50	7,27	S	6568913
TDMX38000PKM	38,00	7,36	T	6568914
TDMX38100PKM	38,10	7,38	T	6568915
TDMX38500PKM	38,50	7,46	T	6568916
TDMX39000PKM	39,00	7,55	T	6568917
TDMX39289PKM	39,29	7,60	T	6568918
TDMX39500PKM	39,50	7,64	T	6568919
TDMX40000PKM	40,00	7,73	T	6568920

TOP DRILL Modular X • Inserts • FPE

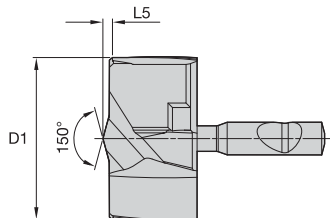

- first choice
- alternate choice

P	Blue	●
M	Yellow	○
K	Red	●
N	Green	○
S	Orange	○
H	Grey	○

catalogue number	D1	L5	SSC	WP40PD
TDMX16000FPEM	16,00	1,16	A	6693048
TDMX16281FPEM	16,28	1,17	A	6693049
TDMX16500FPEM	16,50	1,17	A	6693050
TDMX16667FPEM	16,67	1,17	A	6693111
TDMX17000FPEM	17,00	1,18	B	6693112
TDMX17064FPEM	17,06	1,18	B	6693113
TDMX17500FPEM	17,50	1,19	B	6693114
TDMX18000FPEM	18,00	1,28	C	6693115
TDMX18500FPEM	18,50	1,28	C	6693116
TDMX19000FPEM	19,00	1,29	D	6693117
TDMX19050FPEM	19,05	1,29	D	6693118
TDMX19500FPEM	19,50	1,30	D	6693119
TDMX19840FPEM	19,84	1,31	D	6693120
TDMX20000FPEM	20,00	1,39	E	6693131
TDMX20500FPEM	20,50	1,40	E	6693132
TDMX21000FPEM	21,00	1,40	F	6693133
TDMX21500FPEM	21,50	1,41	F	6693134
TDMX22000FPEM	22,00	1,50	G	6693135
TDMX22500FPEM	22,50	1,51	G	6693136
TDMX23000FPEM	23,00	1,51	H	6693137
TDMX23500FPEM	23,50	1,52	H	6693138
TDMX24000FPEM	24,00	1,61	I	6693139
TDMX24500FPEM	24,50	1,62	I	6693140
TDMX25000FPEM	25,00	1,62	J	6693151
TDMX25400FPEM	25,40	1,63	J	6693152
TDMX25500FPEM	25,50	1,63	J	6693153
TDMX26000FPEM	26,00	1,72	K	6693154
TDMX26400FPEM	26,40	1,72	K	6693194
TDMX26500FPEM	26,50	1,72	K	6693155
TDMX27000FPEM	27,00	1,73	L	6693156
TDMX27500FPEM	27,50	1,74	L	6693157
TDMX28000FPEM	28,00	1,83	M	6693158
TDMX28500FPEM	28,50	1,83	M	6693160
TDMX29000FPEM	29,00	1,84	N	6693161
TDMX29500FPEM	29,50	1,85	N	6693162
TDMX30000FPEM	30,00	1,93	O	6693163
TDMX30500FPEM	30,50	1,94	O	6693164
TDMX31000FPEM	31,00	1,94	P	6693165
TDMX31500FPEM	31,50	1,95	P	6693166
TDMX31750FPEM	31,75	1,95	P	6693167
TDMX32000FPEM	32,00	2,08	Q	6693168
TDMX32500FPEM	32,50	2,08	Q	6693169
TDMX33000FPEM	33,00	2,09	Q	6693170
TDMX34000FPEM	34,00	2,10	R	6693181
TDMX35000FPEM	35,00	2,11	R	6693182
TDMX35500FPEM	35,50	2,12	R	6693183
TDMX36000FPEM	36,00	2,29	S	6693184
TDMX36500FPEM	36,50	2,29	S	6693185
TDMX37000FPEM	37,00	2,30	S	6693186
TDMX37500FPEM	37,50	2,30	S	6693187
TDMX38000FPEM	38,00	2,31	T	6693188
TDMX38100FPEM	38,10	2,31	T	6693189
TDMX38500FPEM	38,50	2,32	T	6693190
TDMX39000FPEM	39,00	2,32	T	6693191
TDMX39500FPEM	39,50	2,33	T	6693192
TDMX40000FPEM	40,00	2,33	T	6693193

NOTE: SSC = Pocket Seat Reference. To correspond with the SSC on the toolholder.

INDEXABLE MILLING

SOLID END MILLING

HOLEMAKING

TAPPING

TURNING

TOP DRILL Modular X • Inserts • MS

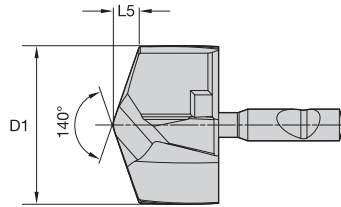

- first choice
- alternate choice

P	Blue	●
M	Yellow	●
K	Red	○
N	Green	○
S	Orange	●
H	Grey	○

catalogue number	D1	L5	SSC	WM15PD
TDMX1600MSM	16,00	2,84	A	6568922
TDMX1620MSM	16,20	2,88	A	6568923
TDMX16281MSM	16,28	2,89	A	6568924
TDMX16500MSM	16,50	2,93	A	6568925
TDMX16667MSM	16,67	2,96	A	6568926
TDMX17000MSM	17,00	3,01	B	6568927
TDMX17064MSM	17,06	3,02	B	6568929
TDMX17463MSM	17,46	3,09	B	6568930
TDMX17500MSM	17,50	3,10	B	6568931
TDMX17600MSM	17,60	3,12	B	6568932
TDMX17800MSM	17,80	3,15	B	6568933
TDMX17859MSM	17,86	3,16	B	6568934
TDMX18000MSM	18,00	3,19	C	6568935
TDMX18255MSM	18,26	3,24	C	6568938
TDMX18500MSM	18,50	3,28	C	6568939
TDMX18651MSM	18,65	3,30	C	6568940
TDMX18800MSM	18,80	3,33	C	6568941
TDMX19000MSM	19,00	3,36	D	6568942
TDMX19050MSM	19,05	3,37	D	6568943
TDMX19200MSM	19,20	3,40	D	6568944
TDMX19270MSM	19,27	3,41	D	6568945
TDMX19450MSM	19,45	3,44	D	6568946
TDMX19500MSM	19,50	3,45	D	6568947
TDMX19700MSM	19,70	3,48	D	6568948
TDMX19840MSM	19,84	3,51	D	6568949
TDMX20000MSM	20,00	3,54	E	6568961
TDMX20100MSM	20,10	3,56	E	6568962
TDMX20200MSM	20,20	3,57	E	6568963
TDMX20239MSM	20,24	3,58	E	6568964
TDMX20300MSM	20,30	3,59	E	6568965
TDMX20400MSM	20,40	3,61	E	6568966
TDMX20500MSM	20,50	3,63	E	6568967
TDMX20600MSM	20,60	3,64	E	6568968
TDMX20650MSM	20,65	3,65	E	6568969
TDMX20700MSM	20,70	3,66	E	6568973
TDMX20800MSM	20,80	3,68	E	6568980
TDMX20900MSM	20,90	3,69	E	6568981
TDMX21000MSM	21,00	3,71	F	6568982
TDMX21430MSM	21,43	3,79	F	6568983
TDMX21500MSM	21,50	3,80	F	6568984
TDMX22000MSM	22,00	3,89	G	6568985
TDMX22225MSM	22,23	3,93	G	6568986
TDMX22450MSM	22,45	3,97	G	6568987
TDMX22500MSM	22,50	3,97	G	6568988
TDMX23000MSM	23,00	4,06	H	6568989
TDMX23500MSM	23,50	4,15	H	6568990
TDMX23813MSM	23,81	4,20	H	6568991
TDMX24000MSM	24,00	4,24	I	6568993
TDMX24500MSM	24,50	4,32	I	6568994
TDMX24605MSM	24,61	4,34	I	6568995
TDMX25000MSM	25,00	4,41	J	6568996
TDMX25400MSM	25,40	4,48	J	6568998
TDMX25500MSM	25,50	4,49	J	6568999
TDMX25670MSM	25,67	4,52	J	6569000
TDMX25700MSM	25,70	4,53	J	6569001
TDMX25760MSM	25,76	4,54	J	6569002
TDMX25796MSM	25,80	4,55	J	6569003
TDMX26000MSM	26,00	4,59	K	6569006
TDMX26192MSM	26,19	4,62	K	6569007
TDMX26400MSM	26,40	4,65	K	6569008
TDMX26500MSM	26,50	4,67	K	6569009
TDMX26589MSM	26,59	4,69	K	6569010
TDMX27000MSM	27,00	4,76	L	6569502
TDMX27500MSM	27,50	4,84	L	6569503
TDMX27780MSM	27,78	4,89	L	6569504
TDMX28000MSM	28,00	4,93	M	6569505
TDMX28176MSM	28,18	4,96	M	6569506
TDMX28500MSM	28,50	5,02	M	6569507

INDEXABLE MILLING

SOLID END MILLING

HOLEMAKING

TAPPING

TURNING

TOP DRILL Modular X • Inserts • MS

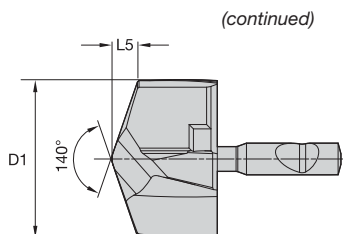

- first choice
- alternate choice

P	Blue	●
M	Yellow	●
K	Red	○
N	Green	○
S	Orange	●
H	Grey	○

catalogue number	D1	L5	SSC	WM15PD
TDMX28575MSM	28,58	5,03	M	6569508
TDMX29000MSM	29,00	5,11	N	6569509
TDMX29367MSM	29,37	5,17	N	6569510
TDMX29500MSM	29,50	5,19	N	6569521
TDMX29764MSM	29,76	5,24	N	6569522
TDMX30000MSM	30,00	5,28	O	6569523
TDMX30163MSM	30,16	5,31	O	6569524
TDMX30500MSM	30,50	5,37	O	6569525
TDMX30955MSM	30,96	5,45	O	6569526
TDMX31000MSM	31,00	5,45	P	6569527
TDMX31500MSM	31,50	5,54	P	6569528
TDMX31750MSM	31,75	5,58	P	6569529
TDMX32000MSM	32,00	5,63	Q	6569530
TDMX32500MSM	32,50	5,72	Q	6569531
TDMX33000MSM	33,00	5,80	Q	6569532
TDMX33338MSM	33,34	5,86	Q	6569533
TDMX34000MSM	34,00	5,98	R	6569534
TDMX34130MSM	34,13	6,00	R	6569535
TDMX34925MSM	34,93	6,13	R	6569536
TDMX35000MSM	35,00	6,15	R	6569537
TDMX35500MSM	35,50	6,23	R	6569538
TDMX36000MSM	36,00	6,33	S	6569539
TDMX36500MSM	36,50	6,41	S	6569540
TDMX37000MSM	37,00	6,50	S	6569551
TDMX37500MSM	37,50	6,59	S	6569552
TDMX38000MSM	38,00	6,67	T	6569553
TDMX38100MSM	38,10	6,69	T	6569554
TDMX38289MSM	38,29	6,72	T	6569557
TDMX38500MSM	38,50	6,76	T	6569555
TDMX39000MSM	39,00	6,84	T	6569556
TDMX39500MSM	39,50	6,93	T	6569558
TDMX40000MSM	40,00	7,01	T	6569559

NOTE: SSC = Pocket Seat Reference. To correspond with the SSC on the toolholder.

Metric tolerance	
D1	tolerance k8
8-10	0,000/+0,022
>10-17	0,000/+0,027
>17-18	0,000/+0,027
>18-21	0,000/+0,033

Application Data • PK • WP40PD™ • Metric

Material Group		Cutting Speed – Vc Range – m/min			Recommended Feed Rate (f) by Diameter					
		min	Starting Value	max	Tool Diameter (mm)	16,0	20,0	25,0	32,0	40,0
P	1	90	125	170	mm/r	0,19–0,45	0,25–0,48	0,25–0,52	0,28–0,57	0,29–0,60
	2	105	140	180	mm/r	0,23–0,46	0,28–0,50	0,30–0,52	0,33–0,57	0,35–0,60
	3	50	75	100	mm/r	0,23–0,46	0,28–0,50	0,30–0,52	0,33–0,57	0,35–0,60
	4	50	75	100	mm/r	0,19–0,45	0,22–0,48	0,25–0,50	0,28–0,55	0,29–0,58
	5	50	65	80	mm/r	0,16–0,32	0,18–0,36	0,22–0,42	0,24–0,46	0,25–0,48
	6	50	65	80	mm/r	0,16–0,32	0,18–0,36	0,22–0,42	0,24–0,46	0,25–0,48
M	1	40	80	110	mm/r	0,11–0,26	0,13–0,28	0,13–0,32	0,14–0,35	0,15–0,37
	2	35	55	75	mm/r	0,11–0,26	0,13–0,28	0,13–0,32	0,14–0,35	0,15–0,37
	3	20	35	50	mm/r	0,11–0,26	0,13–0,28	0,13–0,32	0,14–0,35	0,15–0,37
K	1	60	95	170	mm/r	0,25–0,48	0,28–0,52	0,32–0,56	0,35–0,62	0,37–0,65
	2	60	75	90	mm/r	0,25–0,48	0,28–0,52	0,32–0,56	0,35–0,62	0,37–0,65
	3	40	65	90	mm/r	0,21–0,44	0,23–0,48	0,25–0,50	0,28–0,55	0,29–0,58

NOTE: Through coolant recommended for greater than 3 x D applications.
Material group M is recommended for secondary applications.

Application Data • FPE • WP40PD • Metric

Material Group		Cutting Speed – Vc Range – m/min			Recommended Feed Rate (f) by Diameter					
		min	Starting Value	max	Tool Diameter (mm)	16,0	20,0	25,0	32,0	40,0
P	1	110	140	170	mm/r	0,17–0,25	0,19–0,29	0,23–0,38	0,26–0,43	0,33–0,76
	2	100	120	140	mm/r	0,19–0,25	0,22–0,29	0,29–0,38	0,32–0,43	0,33–0,76
	3	80	100	120	mm/r	0,15–0,23	0,17–0,25	0,23–0,34	0,26–0,38	0,33–0,66
	4	70	90	110	mm/r	0,13–0,23	0,14–0,25	0,18–0,34	0,21–0,38	0,26–0,66
M	1	40	60	80	mm/r	0,11–0,17	0,13–0,20	0,16–0,25	0,18–0,28	0,21–0,31
	2	35	55	70	mm/r	0,11–0,17	0,13–0,20	0,16–0,25	0,18–0,28	0,21–0,31
	3	20	40	60	mm/r	0,11–0,17	0,13–0,20	0,16–0,25	0,18–0,28	0,21–0,31
K	1	90	135	175	mm/r	0,19–0,25	0,22–0,29	0,29–0,38	0,32–0,43	0,33–0,76
	2	80	120	140	mm/r	0,19–0,25	0,22–0,29	0,29–0,38	0,32–0,43	0,33–0,76
	3	70	110	125	mm/r	0,18–0,26	0,21–0,29	0,23–0,37	0,25–0,42	0,27–0,57
S	1	20	40	60	mm/r	0,11–0,17	0,13–0,20	0,16–0,25	0,18–0,28	0,21–0,31
	3	15	30	45	mm/r	0,11–0,17	0,13–0,20	0,16–0,25	0,18–0,28	0,21–0,31

NOTE: Through coolant recommended for greater than 3 x D applications.
Material group M is recommended for secondary applications.

Application Data • MS • WM15PD™ • Metric



Cutting Speed – Vc
Range – m/min

Recommended Feed Rate (f) by Diameter

Material Group		Cutting Speed – Vc			Tool Diameter (mm)	Recommended Feed Rate (f) by Diameter				
		min	Starting Value	max		16,0	20,0	25,4	32,0	40,0
M	1	40	80	110	mm/r	0,11 – 0,26	0,13 – 0,28	0,13 – 0,32	0,14 – 0,35	0,15 – 0,37
	2	35	55	75	mm/r	0,11 – 0,26	0,13 – 0,28	0,13 – 0,32	0,14 – 0,35	0,15 – 0,37
	3	20	35	50	mm/r	0,11 – 0,26	0,13 – 0,28	0,13 – 0,32	0,14 – 0,35	0,15 – 0,37
K	1	90	135	175	mm/r	0,19 – 0,25	0,22 – 0,29	0,29 – 0,38	0,32 – 0,43	0,33 – 0,50
	2	80	120	140	mm/r	0,19 – 0,25	0,22 – 0,29	0,29 – 0,38	0,32 – 0,43	0,33 – 0,50
	3	70	110	125	mm/r	0,18 – 0,26	0,21 – 0,29	0,23 – 0,37	0,25 – 0,42	0,27 – 0,46
N	1	90	155	220	mm/r	0,25 – 0,50	0,28 – 0,56	0,32 – 0,63	0,32 – 0,70	0,32 – 0,70
	2	90	155	220	mm/r	0,25 – 0,50	0,28 – 0,56	0,32 – 0,63	0,32 – 0,70	0,32 – 0,70
	3	80	120	160	mm/r	0,25 – 0,50	0,28 – 0,56	0,32 – 0,63	0,32 – 0,70	0,32 – 0,70
	4	90	155	220	mm/r	0,25 – 0,50	0,28 – 0,56	0,32 – 0,63	0,32 – 0,70	0,32 – 0,70
	5	160	200	240	mm/r	0,25 – 0,50	0,28 – 0,56	0,32 – 0,63	0,32 – 0,70	0,32 – 0,70
	6	160	200	240	mm/r	0,25 – 0,50	0,28 – 0,56	0,32 – 0,63	0,32 – 0,70	0,32 – 0,70
S	1	20	40	60	mm/r	0,07 – 0,12	0,09 – 0,14	0,11 – 0,17	0,13 – 0,20	0,16 – 0,25
	2	15	30	45	mm/r	0,07 – 0,12	0,09 – 0,14	0,11 – 0,17	0,13 – 0,20	0,16 – 0,25
	3	15	30	45	mm/r	0,07 – 0,12	0,09 – 0,14	0,11 – 0,17	0,13 – 0,20	0,16 – 0,25
	4	10	25	40	mm/r	0,07 – 0,12	0,13 – 0,20	0,16 – 0,25	0,18 – 0,28	0,21 – 0,31

INDEXABLE MILLING

SOLID END MILLING

HOLEMAKING

TAPPING

TURNING

Assembling and Disassembling Instructions

Assembly

1 Insert positioning

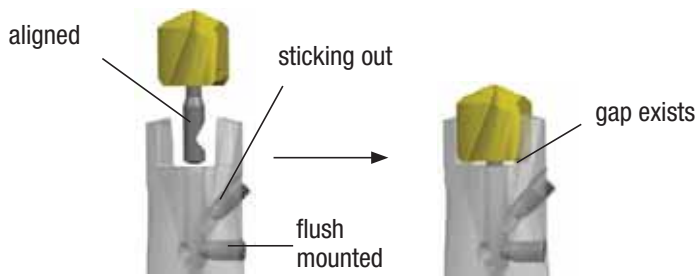

2 Insert clamping

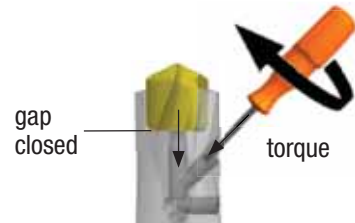

Drill diameter	Torque
ø 16–19,999mm	1,5 Nm
ø 20–23,999mm	2,1 Nm
ø 24–27,999mm	3,0 Nm
ø 28–40,000mm	4,5 Nm

Disassembly

1 Clamping screw loosening

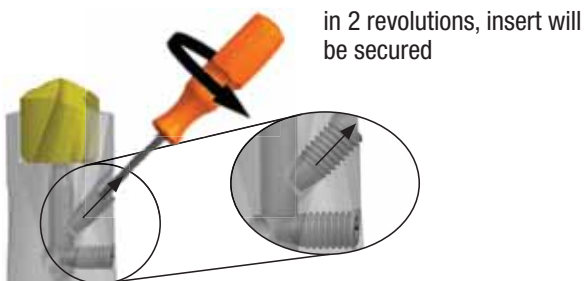

2 Insert pushing out

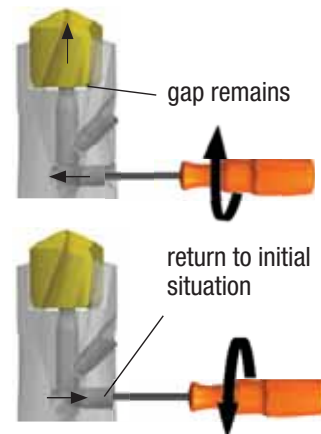

3 Further clamping screw loosening

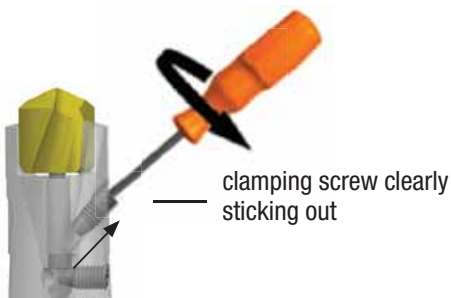

4 Insert removal



Application Guidelines

Deep-Hole Drilling from 12 x D

- Use the FPE(M) geometry in combination with the 1.5 x D body for pilot hole.
- The point angle of spot drill should be greater than point angle of the insert (>140°).
- The 150° point on the FPE(M) insert is perfect as spot for the regular 140° insert.
- The 12 x D body has a cylindrical straight shank with flange.
- Shank tolerance h6.
- Best used in combination with a hydraulic chuck to minimize the runout.

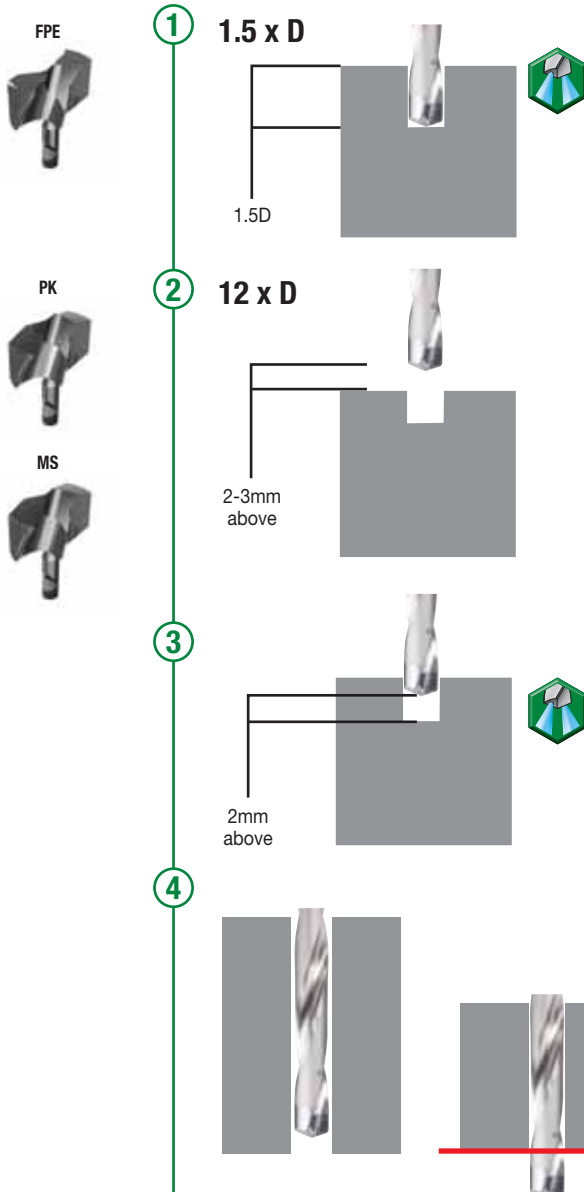
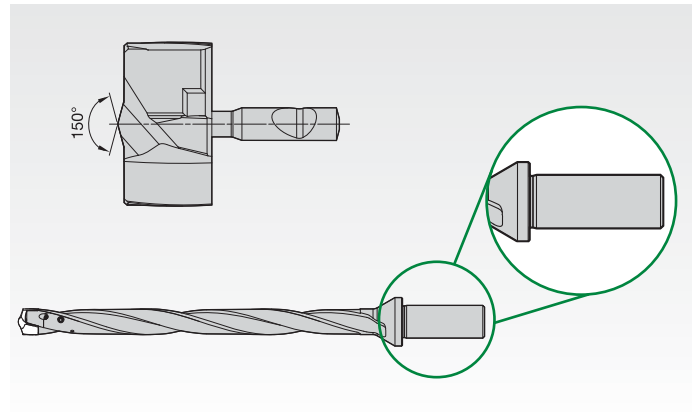

Step 1

Use 1.5 x D FPE geometry drill to create a guide hole with thru coolant and ensure no chips are stuck in the hole.

Step 2

Use 12 x D PK, MS geometry drill for deep hole.

- Spindle RPM 500 max (if horizontal machine spindle direction CCW) and 2~3 above the work piece rapid traverse.
- Feed in recommended feed rate and position 2,0mm above the pilot hole depth.

Step 3

- Switch on the through coolant and ensure coolant flow and spindle rotation CW, recommended spindle RPM.

Step 4

- Feed in for the entire depth with recommended cutting parameters (feed reduction 25% near exit).
- Ensure the carbide head does not come out of the hole if through.
- For best surface finish Vf, 2,0 to 3,0mm per min is recommended during retraction.

TDMX™ Application Notes • Power and Coolant Requirements

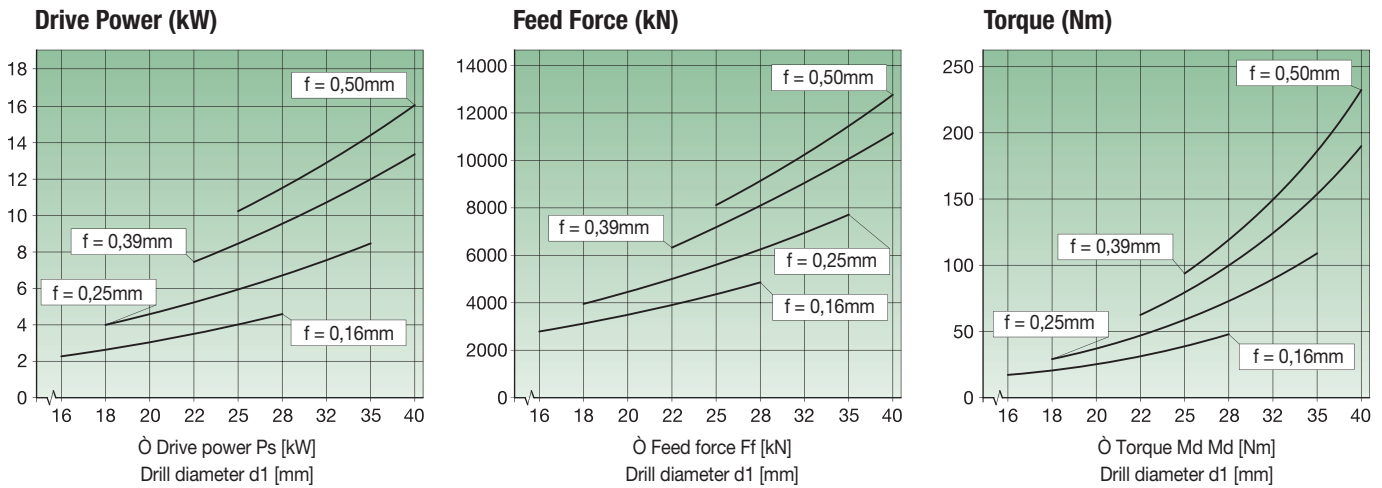

NOTE: The diagrams above are used to determine the drive power, feed force, and torque. They are based on cutting force measurement in tempered steels in Cgr. 6. Tensile strength: $R_m = 600 \text{ N/mm}^2$. The base cutting speed used is: $v_c = 80 \text{ m/min}$.

TDMX • Regrinding Length • FPE • Metric

SSC	diameter range D	L min.	L new
A	16-16,999	9,8	10,8
B	17-17,999	9,8	10,8
C	18-18,999	10,6	11,7
D	19-19,999	10,6	11,7
E	20-20,999	11,4	12,6
F	21-21,999	11,4	12,6
G	22-22,999	12,1	13,4
H	23-23,999	12,1	13,4
I	24-24,999	13,0	14,4
J	25-25,999	13,0	14,4
K	26-26,999	13,8	15,3
L	27-27,999	13,8	15,3
M	28-28,999	14,8	16,4
N	29-29,999	14,8	16,4
O	30-30,999	15,6	17,3
P	31-31,999	15,6	17,3
Q	32-33,999	17,8	19,7
R	34-35,999	17,8	19,7
S	36-37,999	19,4	21,5
T	38-40,000	19,4	21,5

NOTE: SSC = Pocket Seat Reference. To correspond with the SSC on the inserts.

TDMX • Regrinding Length • PK, MS • Metric

SSC	diameter range D	L min.	L new
A	16-16,999	11,2	12,5
B	17-17,999	11,2	12,5
C	18-18,999	12,2	13,6
D	19-19,999	12,2	13,6
E	20-20,999	13,2	14,7
F	21-21,999	13,2	14,7
G	22-22,999	14,2	15,8
H	23-23,999	14,2	15,8
I	24-24,999	15,2	16,9
J	25-25,999	15,2	16,9
K	26-26,999	16,2	18
L	27-27,999	16,2	18
M	28-28,999	17,2	19,1
N	29-29,999	17,2	19,1
O	30-30,999	18,2	20,2
P	31-31,999	18,2	20,2
Q	32-33,999	20,1	22,3
R	34-35,999	20,1	22,3
S	36-37,999	22,1	24,5
T	38-40,000	22,1	24,5

The following coolant pressure is recommended:

relative drilling depth	coolant pressure
1-3 x D	8 bars
5 x D	12 bars
7 x D	20 bars
10 x D	30 bars
12 x D	30 bars

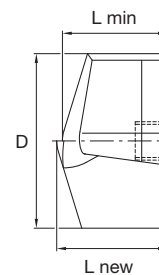

TDMX™ Application Guidelines



Up to 1D



Recommended



Recommended



Dry not recommended

Application Recommendation	Work Piece Shape	Remarks																								
Flat Face Recommended		1,5 x D, 3 x D and 5 x D: No Feed Reduction 8 x D: No Feed Reduction; Optional 25% Reduction 12 x D: 25% entry and exit Reduction																								
Stacked Plates Recommended		Minimize as much as possible the space between the two plates. The FPE geometry is a problem-solver in this situation.																								
Inclined Entry Recommended		<table border="1"> <thead> <tr> <th colspan="2">1,5 x D, 3 x D, and 5 x D</th> <th colspan="2">8 x D and 12 x D</th> </tr> <tr> <th>INCLINATION</th> <th>FEED RATE</th> <th colspan="2">Pilot drilling or pre-machining on all surfaces recommended</th> </tr> </thead> <tbody> <tr> <td>1°</td> <td>90%</td> <td colspan="2"></td> </tr> <tr> <td>2°</td> <td>75%</td> <td colspan="2"></td> </tr> <tr> <td>3°</td> <td>50%</td> <td colspan="2"></td> </tr> <tr> <td>>3°</td> <td colspan="2">Pilot Drilling or Pre-Machining</td> <td></td> </tr> </tbody> </table>	1,5 x D, 3 x D, and 5 x D		8 x D and 12 x D		INCLINATION	FEED RATE	Pilot drilling or pre-machining on all surfaces recommended		1°	90%			2°	75%			3°	50%			>3°	Pilot Drilling or Pre-Machining		
1,5 x D, 3 x D, and 5 x D		8 x D and 12 x D																								
INCLINATION	FEED RATE	Pilot drilling or pre-machining on all surfaces recommended																								
1°	90%																									
2°	75%																									
3°	50%																									
>3°	Pilot Drilling or Pre-Machining																									
Inclined Exit Recommended		<table border="1"> <thead> <tr> <th colspan="2">1,5 x D, 3 x D, and 5 x D</th> <th colspan="2">8 x D and 12 x D</th> </tr> <tr> <th>INCLINATION</th> <th>FEED RATE</th> <th colspan="2">FEED RATE</th> </tr> </thead> <tbody> <tr> <td>5°</td> <td>100%</td> <td colspan="2">75%</td> </tr> <tr> <td>>5°</td> <td>75%–50%</td> <td colspan="2">75%–50%</td> </tr> <tr> <td>>20°Cast Iron</td> <td>50%</td> <td colspan="2">50%</td> </tr> <tr> <td>>20°Steel</td> <td>Not Recommended</td> <td colspan="2">Not Recommended</td> </tr> </tbody> </table>	1,5 x D, 3 x D, and 5 x D		8 x D and 12 x D		INCLINATION	FEED RATE	FEED RATE		5°	100%	75%		>5°	75%–50%	75%–50%		>20°Cast Iron	50%	50%		>20°Steel	Not Recommended	Not Recommended	
1,5 x D, 3 x D, and 5 x D		8 x D and 12 x D																								
INCLINATION	FEED RATE	FEED RATE																								
5°	100%	75%																								
>5°	75%–50%	75%–50%																								
>20°Cast Iron	50%	50%																								
>20°Steel	Not Recommended	Not Recommended																								
Cross Holes Recommended		Cross hole out of center and center edge in contact — Recommended Cross hole on center and < drill diameter — Recommended Cross hole on center and > drill diameter — Exercise Caution Cross hole on center and = drill diameter — Exercise Caution Cross hole out of center and center edge not in contact — Not Recommended																								
Convex / Concave Surface		Always pre-machine the surface																								
Half Cylindrical Not Recommended		Usage Precautions Core Deviation 1) For Turning Machines																								
Hole Expansion Not Recommended		Set deviation amount under 0,02mm between workpiece and drill.																								
Pipe Material Not Recommended		2) For Machining Centers																								
Cored hole Not Recommended		Do not use any arbor with a damaged attachment surface. Center of arbor deviation must be within 0,02mm.																								

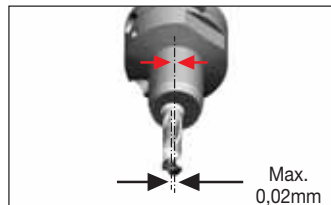
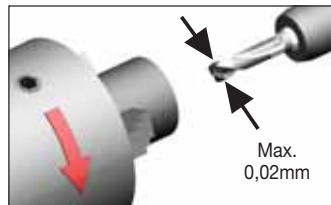



widia.com

WIDIA ™

TOP DRILL M1™

Universal Modular Drilling • TDM1

The TDM1 modular drill is for customers seeking an easy-to-use system capable of operating on a variety of materials with one single point geometry, and a tool body featuring a quick-change, front-clamping mechanism.

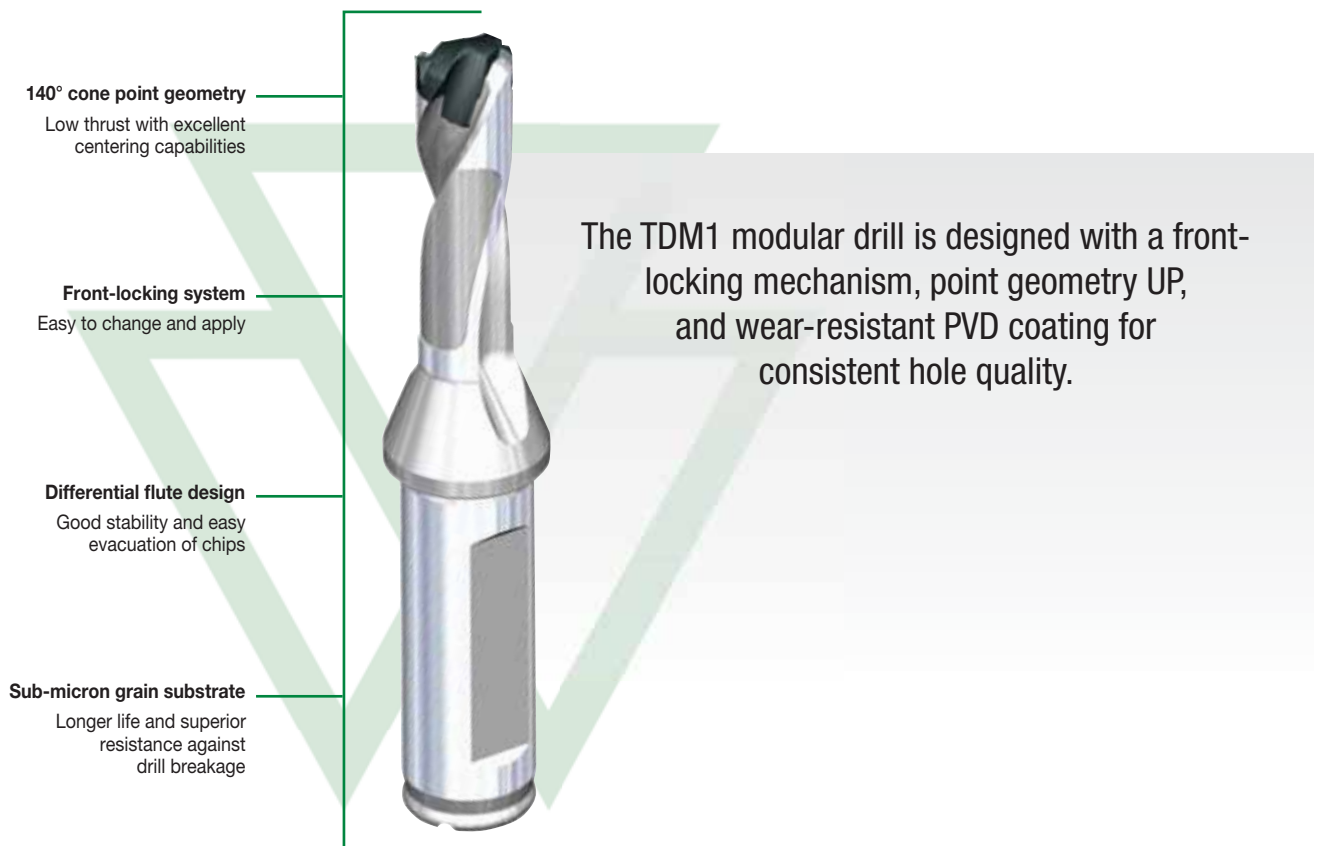

WU25PD

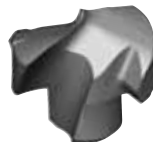

Sub-micron grain carbide
TiAlN multilayer for steel, stainless steel,
and cast iron

MODULAR VERSATILITY

PRODUCT

TDM1 is a front clamping drill with universal point geometry and grade suited for PMK materials.

DIAMETER RANGE

8–25,99mm

INDUSTRY



MATERIALS

FIRST CHOICE



SECOND CHOICE



APPLICATIONS



DRILLING



THROUGH COOLANT



2 FLUTE/2 MARGIN/ COOLANT

STEEL BODIES

SERIES	COOLANT	LENGTH RATIO	DIAMETER RANGE
TDM1	Through Coolant	3 x D	7,94–25,99mm
TDM1	Through Coolant	5 x D	7,94–25,99mm
TDM1	Through Coolant	8 x D	7,94–25,99mm

Shank Style

SCF shank for metric tools



TDM1 Inserts • Catalog Numbering System

Each character in our catalog number signifies a specific trait of that product. Use the following key columns and corresponding images to easily identify which attributes apply.

TDM	2599	UPM	WU25PD
Top Drill Modular	Insert Diameter	Insert Geometry	Grade
	25,99mm	PK = steel and cast iron	WIDIA™; Universal, Application 25 = wear resistant carbide, PVD coated, Modular Drill Insert

TDM1 Bodies • Catalog Numbering System

Each character in our catalog number signifies a specific trait of that product. Use the following key columns and corresponding images to easily identify which attributes apply.

TDM	250	R8	SCF	25M
Top Drill Modular	Drill Body Diameter	L/D Ratio	Shank Style	Shank Diameter
	25mm	8 x D	Flanged shanks with flat SCF	25mm

TOP DRILL M1™ • 3 x D • Flanged Shank • Metric

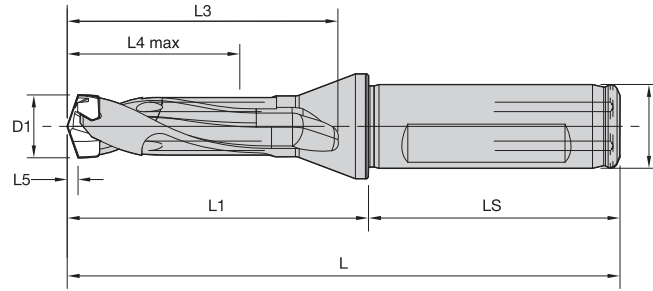

order number	catalogue number	D1	D1 max	D	L	L1	L3	L4 max	L5	LS	SSC
3850904	TDM080R3SCF12M	7,94	8,49	12	86	41	35	26	1,5	45	W10
3850906	TDM085R3SCF12M	8,50	8,99	12	88	43	37	27	1,6	45	W11
3850908	TDM090R3SCF12M	9,00	9,49	12	90	45	39	29	1,7	45	W12
3850910	TDM095R3SCF12M	9,50	9,99	12	92	47	41	30	1,8	45	W13
3850912	TDM100R3SCF16M	10,00	10,49	16	97	49	43	32	1,9	48	W14
3850924	TDM105R3SCF16M	10,50	10,99	16	99	51	45	33	2,0	48	W15
3850926	TDM110R3SCF16M	11,00	11,49	16	101	53	47	35	2,1	48	W16
3850928	TDM115R3SCF16M	11,50	11,99	16	103	55	49	36	2,2	48	W17
3850930	TDM120R3SCF16M	12,00	12,49	16	106	58	52	38	2,3	48	W18
3850932	TDM125R3SCF16M	12,50	12,99	16	108	60	54	39	2,4	48	W19
3850934	TDM130R3SCF16M	13,00	13,49	16	110	62	56	41	2,5	48	W20
3850936	TDM135R3SCF16M	13,50	13,99	16	112	64	58	42	2,6	48	W21
3850938	TDM140R3SCF16M	14,00	14,49	16	114	66	60	44	2,7	48	W22
3850940	TDM145R3SCF16M	14,50	14,99	16	116	68	62	45	2,8	48	W23
3850942	TDM150R3SCF20M	15,00	15,99	20	122	72	66	48	2,8	50	W24
3850944	TDM160R3SCF20M	16,00	16,99	20	126	76	70	51	3,0	50	W25
3850946	TDM170R3SCF20M	17,00	17,99	20	131	81	75	54	3,2	50	W26
3850948	TDM180R3SCF25M	18,00	18,99	25	141	85	79	57	3,4	56	W27
3850950	TDM190R3SCF25M	19,00	19,99	25	144	89	83	60	3,6	56	W28
3850952	TDM200R3SCF25M	20,00	20,99	25	149	93	87	63	3,8	56	W29
3992070	TDM210R3SCF25M	21,00	21,99	25	153	97	91	66	3,7	56	W30
3992071	TDM220R3SCF25M	22,00	22,99	25	158	102	96	69	3,9	56	W31
3992072	TDM230R3SCF25M	23,00	23,99	25	162	106	100	72	4,1	56	W32
3992483	TDM240R3SCF25M	24,00	24,99	25	166	110	104	75	4,2	56	W33
3992484	TDM250R3SCF25M	25,00	25,99	25	170	114	108	78	4,4	56	W34

NOTE: SSC = Pocket Seat Reference. To correspond with the SSC on the inserts.

INDEXABLE MILLING

SOLID END MILLING

HOLEMAKING

TAPPING

TURNING

TOP DRILL M1™ • 5 x D • Flanged Shank • Metric

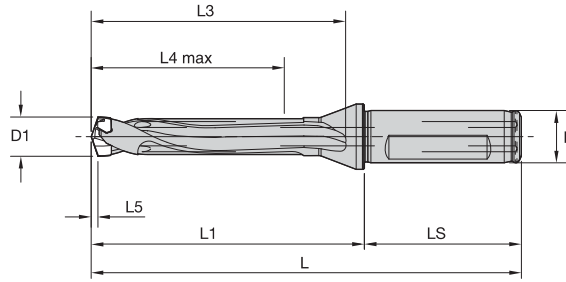

order number	catalogue number	D1	D1 max	D	L	L1	L3	L4 max	L5	LS	SSC
3850905	TDM080R5SCF12M	7,94	8,49	12	104	59	53	43	1,5	45	W10
3850907	TDM085R5SCF12M	8,50	8,99	12	107	62	56	45	1,6	45	W11
3850909	TDM090R5SCF12M	9,00	9,49	12	110	65	59	48	1,7	45	W12
3850911	TDM095R5SCF12M	9,50	9,99	12	114	69	63	50	1,8	45	W13
3850923	TDM100R5SCF16M	10,00	10,49	16	120	72	66	53	1,9	48	W14
3850925	TDM105R5SCF16M	10,50	10,99	16	123	75	69	55	2,0	48	W15
3850927	TDM110R5SCF16M	11,00	11,49	16	126	78	72	58	2,1	48	W16
3850929	TDM115R5SCF16M	11,50	11,99	16	129	81	75	60	2,2	48	W17
3850931	TDM120R5SCF16M	12,00	12,49	16	132	84	78	63	2,3	48	W18
3850933	TDM125R5SCF16M	12,50	12,99	16	135	87	81	65	2,4	48	W19
3850935	TDM130R5SCF16M	13,00	13,49	16	138	90	84	68	2,5	48	W20
3850937	TDM135R5SCF16M	13,50	13,99	16	142	94	88	70	2,6	48	W21
3850939	TDM140R5SCF16M	14,00	14,49	16	145	97	91	73	2,7	48	W22
3850941	TDM145R5SCF16M	14,50	14,99	16	148	100	94	75	2,8	48	W23
3850943	TDM150R5SCF20M	15,00	15,99	20	156	106	100	80	2,8	50	W24
3850945	TDM160R5SCF20M	16,00	16,99	20	162	112	106	85	3,0	50	W25
3850947	TDM170R5SCF20M	17,00	17,99	20	169	119	113	90	3,2	50	W26
3850949	TDM180R5SCF25M	18,00	18,99	25	181	125	119	95	3,4	56	W27
3850951	TDM190R5SCF25M	19,00	19,99	25	187	131	125	100	3,6	56	W28
3850953	TDM200R5SCF25M	20,00	20,99	25	193	137	131	105	3,8	56	W29
3992485	TDM210R5SCF25M	21,00	21,99	25	200	144	138	110	3,7	56	W30
3992486	TDM220R5SCF25M	22,00	22,99	25	206	150	144	115	3,9	56	W31
3992487	TDM230R5SCF25M	23,00	23,99	25	212	156	150	120	4,1	56	W32
3992488	TDM240R5SCF25M	24,00	24,99	25	218	162	156	125	4,2	56	W33
3992489	TDM250R5SCF25M	25,00	25,99	25	225	169	163	130	4,4	56	W34

NOTE: SSC = Pocket Seat Reference. To correspond with the SSC on the inserts.

INDEXABLE MILLING

SOLID END MILLING

HOLEMAKING

TAPPING

TURNING

TOP DRILL M1™ • 8 x D • Flanged Shank • Metric

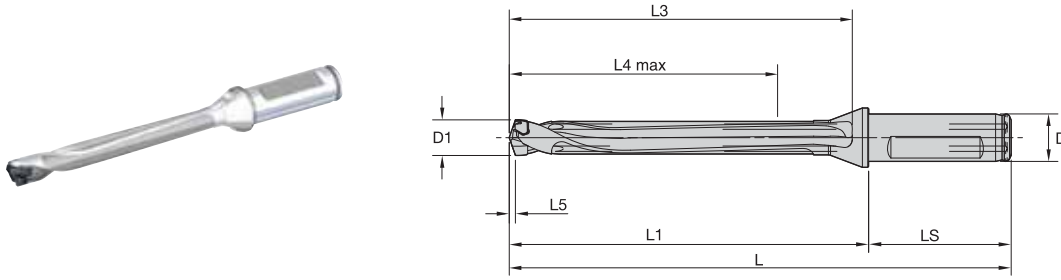

order number	catalogue number	D1	D1 max	D	L	L1	L3	L4 max	L5	LS	SSC
3992141	TDM080R8SCF12M	7,94	8,49	12	129	84	79	68	1,4	45	W10
3992142	TDM085R8SCF12M	8,50	8,99	12	134	89	83	72	1,5	45	W11
3992213	TDM090R8SCF12M	9,00	9,49	12	138	93	88	76	1,6	45	W12
3992214	TDM095R8SCF12M	9,50	9,99	12	144	99	93	80	1,7	45	W13
3992215	TDM100R8SCF16M	10,00	10,49	16	151	103	98	84	1,8	48	W14
3992216	TDM105R8SCF16M	10,50	10,99	16	156	108	102	88	1,9	48	W15
3992217	TDM110R8SCF16M	11,00	11,49	16	160	112	107	92	2,0	48	W16
3992218	TDM115R8SCF16M	11,50	11,99	16	165	117	111	96	2,1	48	W17
3992219	TDM120R8SCF16M	12,00	12,49	16	169	121	116	100	2,1	48	W18
3992220	TDM125R8SCF16M	12,50	12,99	16	174	126	120	104	2,2	48	W19
3992221	TDM130R8SCF16M	13,00	13,49	16	178	130	125	108	2,3	48	W20
3992222	TDM135R8SCF16M	13,50	13,99	16	184	136	130	112	2,4	48	W21
3992223	TDM140R8SCF16M	14,00	14,49	16	188	140	135	116	2,5	48	W22
3992224	TDM145R8SCF16M	14,50	14,99	16	193	145	139	120	2,6	48	W23
3992225	TDM150R8SCF20M	15,00	15,99	20	204	154	148	128	2,7	50	W24
3992226	TDM160R8SCF20M	16,00	16,99	20	213	163	157	136	2,8	50	W25
3992227	TDM170R8SCF20M	17,00	17,99	20	223	173	167	144	3,0	50	W26
3992228	TDM180R8SCF25M	18,00	18,99	25	238	182	176	152	2,9	56	W27
3992229	TDM190R8SCF25M	19,00	19,99	25	247	191	185	160	3,4	56	W28
3992230	TDM200R8SCF25M	20,00	20,99	25	256	200	194	168	3,6	56	W29
3992231	TDM210R8SCF25M	21,00	21,99	25	266	210	204	176	3,7	56	W30
3992232	TDM220R8SCF25M	22,00	22,99	25	275	219	213	184	3,9	56	W31
3992233	TDM230R8SCF25M	23,00	23,99	25	284	228	222	192	4,1	56	W32
3992234	TDM240R8SCF25M	24,00	24,99	25	293	237	231	200	4,2	56	W33
3992235	TDM250R8SCF25M	25,00	25,99	25	303	247	241	208	4,4	56	W34

NOTE: SSC = Pocket Seat Reference. To correspond with the SSC on the inserts.

INDEXABLE MILLING

SOLID END MILLING

HOLEMAKING

TAPPING

TURNING

TOP DRILL M1™ • Inserts • UP

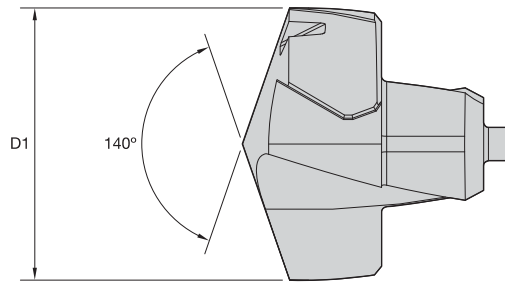

● first choice
○ alternate choice

grade WU25PD
TiAlN

order #	catalogue #	D1	SSC
3850959	TDM0794UPM	7,94	W10
3848984	TDM0800UPM	8,00	W10
3848985	TDM0810UPM	8,10	W10
3850960	TDM0816UPM	8,16	W10
3850961	TDM0820UPM	8,20	W10
3848986	TDM0830UPM	8,30	W10
3850962	TDM0833UPM	8,33	W10
3848987	TDM0840UPM	8,40	W10
3850963	TDM0843UPM	8,43	W10
3848988	TDM0850UPM	8,50	W11
3848989	TDM0860UPM	8,60	W11
3850964	TDM0861UPM	8,61	W11
3848990	TDM0870UPM	8,70	W11
3850965	TDM0873UPM	8,73	W11
3848991	TDM0880UPM	8,80	W11
3850966	TDM0884UPM	8,84	W11
3848992	TDM0890UPM	8,90	W11
3849043	TDM0900UPM	9,00	W12
3850967	TDM0909UPM	9,09	W12
3849044	TDM0910UPM	9,10	W12
3850968	TDM0913UPM	9,13	W12
3849045	TDM0920UPM	9,20	W12
3849046	TDM0930UPM	9,30	W12
3850969	TDM0935UPM	9,35	W12
3849047	TDM0940UPM	9,40	W12
3849048	TDM0950UPM	9,50	W13
3850970	TDM0953UPM	9,53	W13
3850971	TDM0956UPM	9,56	W13
3850972	TDM0958UPM	9,58	W13
3849049	TDM0960UPM	9,60	W13
3850973	TDM0970UPM	9,70	W13
3850974	TDM0980UPM	9,80	W13
3849050	TDM0990UPM	9,90	W13
3850975	TDM0992UPM	9,92	W13
3849051	TDM1000UPM	10,00	W14
3850976	TDM1002UPM	10,02	W14
3850977	TDM1008UPM	10,08	W14
3849052	TDM1010UPM	10,10	W14
3849053	TDM1020UPM	10,20	W14
3850978	TDM1026UPM	10,26	W14
3849054	TDM1030UPM	10,30	W14
3850979	TDM1032UPM	10,32	W14
3849055	TDM1040UPM	10,40	W14
3850980	TDM1049UPM	10,49	W14
3849056	TDM1050UPM	10,50	W15
3849057	TDM1060UPM	10,60	W15
3849058	TDM1070UPM	10,70	W15
3850981	TDM1072UPM	10,72	W15
3849059	TDM1080UPM	10,80	W15
3849060	TDM1090UPM	10,90	W15
3849061	TDM1100UPM	11,00	W16
3849062	TDM1110UPM	11,10	W16

TOP DRILL M1™ • Inserts • UP

(continued)

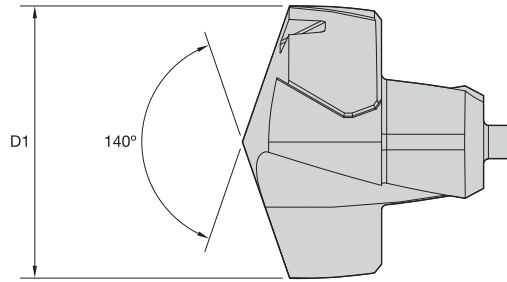

● first choice
○ alternate choice

grade WU25PD
TiAlN

order #	catalogue #	D1	SSC
3850982	TDM1111UPM	11,11	W16
3849063	TDM1120UPM	11,20	W16
3849064	TDM1130UPM	11,30	W16
3849065	TDM1140UPM	11,40	W16
3849066	TDM1150UPM	11,50	W17
3850983	TDM1151UPM	11,51	W17
3849067	TDM1160UPM	11,60	W17
3850984	TDM1161UPM	11,61	W17
3849068	TDM1170UPM	11,70	W17
3849069	TDM1180UPM	11,80	W17
3849070	TDM1190UPM	11,90	W17
3850985	TDM1191UPM	11,91	W17
3849071	TDM1200UPM	12,00	W18
3849072	TDM1210UPM	12,10	W18
3849073	TDM1220UPM	12,20	W18
3850986	TDM1230UPM	12,30	W18
3849074	TDM1240UPM	12,40	W18
3850987	TDM1247UPM	12,47	W18
3849075	TDM1250UPM	12,50	W19
3849076	TDM1260UPM	12,60	W19
3850988	TDM1270UPM	12,70	W19
3849077	TDM1280UPM	12,80	W19
3850989	TDM1290UPM	12,90	W19
3849078	TDM1300UPM	13,00	W20
3850990	TDM1310UPM	13,10	W20
3849079	TDM1320UPM	13,20	W20
3849080	TDM1330UPM	13,30	W20
3849081	TDM1340UPM	13,40	W20
3850991	TDM1349UPM	13,49	W20
3849082	TDM1350UPM	13,50	W21
3849083	TDM1360UPM	13,60	W21
3849084	TDM1370UPM	13,70	W21
3849085	TDM1380UPM	13,80	W21
3850992	TDM1389UPM	13,89	W21
3850993	TDM1390UPM	13,90	W21
3849086	TDM1400UPM	14,00	W22
3849087	TDM1410UPM	14,10	W22
3849088	TDM1420UPM	14,20	W22
3850994	TDM1429UPM	14,29	W22
3849089	TDM1430UPM	14,30	W22
3849090	TDM1440UPM	14,40	W22
3849091	TDM1450UPM	14,50	W23
3849092	TDM1460UPM	14,60	W23
3850995	TDM1467UPM	14,67	W23
3850996	TDM1468UPM	14,68	W23
3849093	TDM1470UPM	14,70	W23
3849094	TDM1480UPM	14,80	W23
3849095	TDM1490UPM	14,90	W23
3849096	TDM1500UPM	15,00	W24
3850997	TDM1508UPM	15,08	W24
3849097	TDM1510UPM	15,10	W24
3849098	TDM1520UPM	15,20	W24

TOP DRILL M1™ • Inserts • UP

(continued)

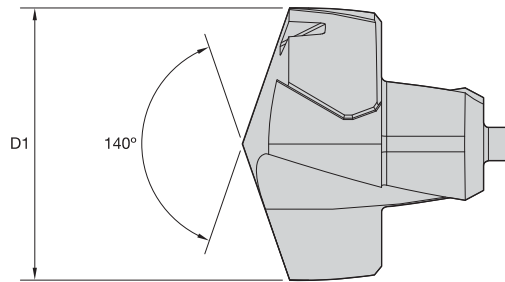

● first choice
○ alternate choice

grade WU25PD
TiAlN

order #	catalogue #	D1	SSC
3849099	TDM1530UPM	15,30	W24
3849100	TDM1540UPM	15,40	W24
3850998	TDM1548UPM	15,48	W24
3849101	TDM1550UPM	15,50	W24
3849102	TDM1560UPM	15,60	W24
3849103	TDM1570UPM	15,70	W24
3849104	TDM1580UPM	15,80	W24
3850999	TDM1588UPM	15,88	W24
3849105	TDM1600UPM	16,00	W25
3851000	TDM1603UPM	16,03	W25
3851001	TDM1608UPM	16,08	W25
3849106	TDM1610UPM	16,10	W25
4010625	TDM1618UPM	16,18	W25
3849107	TDM1620UPM	16,20	W25
3851002	TDM1627UPM	16,27	W25
3849108	TDM1630UPM	16,30	W25
3849109	TDM1640UPM	16,40	W25
3849110	TDM1650UPM	16,50	W25
3849111	TDM1660UPM	16,60	W25
3851003	TDM1667UPM	16,67	W25
3849112	TDM1670UPM	16,70	W25
3849113	TDM1680UPM	16,80	W25
3851004	TDM1687UPM	16,87	W25
3849114	TDM1690UPM	16,90	W25
3849119	TDM1700UPM	17,00	W26
3851005	TDM1707UPM	17,07	W26
3849120	TDM1710UPM	17,10	W26
3849121	TDM1720UPM	17,20	W26
3849122	TDM1730UPM	17,30	W26
3849193	TDM1740UPM	17,40	W26
3851006	TDM1746UPM	17,46	W26
3849194	TDM1750UPM	17,50	W26
3849195	TDM1760UPM	17,60	W26
3849196	TDM1770UPM	17,70	W26
3849197	TDM1780UPM	17,80	W26
3851007	TDM1786UPM	17,86	W26
3849198	TDM1790UPM	17,90	W26
3849199	TDM1800UPM	18,00	W27
3849200	TDM1810UPM	18,10	W27
3849201	TDM1820UPM	18,20	W27
3851008	TDM1826UPM	18,26	W27
3849202	TDM1830UPM	18,30	W27
3849203	TDM1840UPM	18,40	W27
3849204	TDM1850UPM	18,50	W27
3849205	TDM1860UPM	18,60	W27
3851009	TDM1865UPM	18,65	W27
3849206	TDM1870UPM	18,70	W27
3849207	TDM1880UPM	18,80	W27
3849208	TDM1890UPM	18,90	W27
3849209	TDM1900UPM	19,00	W28
3851010	TDM1905UPM	19,05	W28
3849210	TDM1910UPM	19,10	W28

TOP DRILL M1™ • Inserts • UP

(continued)

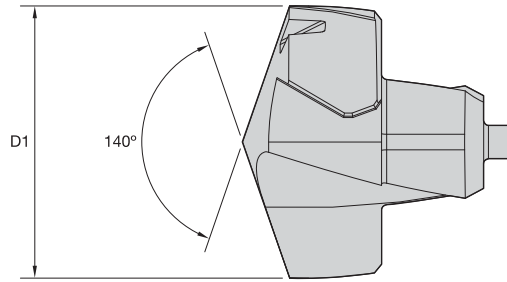

● first choice
○ alternate choice

grade WU25PD
TiAlN

order #	catalogue #	D1	SSC
3849211	TDM1920UPM	19,20	W28
3851011	TDM1923UPM	19,23	W28
3851012	TDM1925UPM	19,25	W28
3851013	TDM1928UPM	19,28	W28
3849212	TDM1930UPM	19,30	W28
3851014	TDM1935UPM	19,35	W28
3849213	TDM1940UPM	19,40	W28
3851015	TDM1945UPM	19,45	W28
3849214	TDM1950UPM	19,50	W28
3849215	TDM1960UPM	19,60	W28
3849216	TDM1970UPM	19,70	W28
3849217	TDM1980UPM	19,80	W28
3851016	TDM1984UPM	19,84	W28
3849218	TDM1990UPM	19,90	W28
3849219	TDM2000UPM	20,00	W29
3849220	TDM2010UPM	20,10	W29
3849221	TDM2020UPM	20,20	W29
3851017	TDM2024UPM	20,24	W29
3849222	TDM2030UPM	20,30	W29
3849223	TDM2040UPM	20,40	W29
3849224	TDM2050UPM	20,50	W29
3849225	TDM2060UPM	20,60	W29
3851018	TDM2064UPM	20,64	W29
3849226	TDM2070UPM	20,70	W29
3849227	TDM2080UPM	20,80	W29
3849228	TDM2090UPM	20,90	W29
3849229	TDM2099UPM	20,99	W29
4003225	TDM2100UPM	21,00	W30
4003203	TDM2144UPM	21,44	W30
3969291	TDM2150UPM	21,50	W30
4003226	TDM2200UPM	22,00	W31
4003204	TDM2223UPM	22,23	W31
4003205	TDM2245UPM	22,45	W31
4003227	TDM2250UPM	22,50	W31
4003228	TDM2300UPM	23,00	W32
4003229	TDM2350UPM	23,50	W32
4003206	TDM2381UPM	23,81	W32
4003230	TDM2400UPM	24,00	W33
4003231	TDM2450UPM	24,50	W33
4003207	TDM2461UPM	24,61	W33
4003232	TDM2500UPM	25,00	W34
4003208	TDM2540UPM	25,40	W34
4002444	TDM2550UPM	25,50	W34
4003209	TDM2568UPM	25,68	W34
4003210	TDM2581UPM	25,81	W34
3992013	TDM2599UPM	25,99	W34

Application Data • UP • WU25PD™ • Metric



Cutting Speed – vc

Range – m/min

Recommended Feed Rate

Material Group		Cutting Speed – vc			Tool Diameter (mm)	Recommended Feed Rate						
		min	Starting Value	max		8,0	10,0	12,0	14,0	16,0	20,0	25,0
P	1	90	125	170	mm/r	0,11–0,20	0,13–0,25	0,14–0,31	0,17–0,39	0,19–0,45	0,25–0,48	0,30–0,52
	2	105	140	180	mm/r	0,11–0,28	0,12–0,35	0,16–0,37	0,21–0,46	0,23–0,46	0,28–0,50	0,30–0,52
	3	50	75	100	mm/r	0,11–0,28	0,12–0,35	0,16–0,37	0,21–0,46	0,23–0,46	0,28–0,50	0,30–0,52
	4	50	75	100	mm/r	0,11–0,28	0,12–0,35	0,16–0,37	0,17–0,36	0,19–0,45	0,22–0,48	0,25–0,50
	5	50	65	80	mm/r	0,10–0,20	0,10–0,23	0,10–0,25	0,14–0,29	0,16–0,32	0,18–0,36	0,22–0,42
	6	50	65	80	mm/r	0,10–0,20	0,10–0,23	0,10–0,25	0,14–0,29	0,16–0,32	0,18–0,36	0,22–0,42
M	1	40	80	110	mm/r	0,06–0,22	0,08–0,23	0,09–0,24	0,10–0,25	0,11–0,26	0,13–0,28	0,13–0,32
	2	35	55	75	mm/r	0,06–0,22	0,08–0,23	0,09–0,24	0,10–0,25	0,11–0,26	0,13–0,28	0,13–0,32
	3	20	35	50	mm/r	0,06–0,22	0,08–0,23	0,09–0,24	0,10–0,25	0,11–0,26	0,13–0,28	0,13–0,32
K	1	60	95	170	mm/r	0,15–0,29	0,16–0,32	0,17–0,35	0,21–0,42	0,25–0,48	0,28–0,52	0,32–0,56
	2	60	75	90	mm/r	0,15–0,29	0,16–0,30	0,17–0,33	0,21–0,41	0,25–0,48	0,28–0,52	0,32–0,56
	3	40	65	90	mm/r	0,16–0,30	0,17–0,33	0,18–0,36	0,20–0,41	0,21–0,44	0,23–0,48	0,25–0,50

NOTE: Through coolant recommended for greater than 3 x D applications.

INDEXABLE MILLING

SOLID END MILLING

HOLEMAKING

TAPPING

TURNING

Application Data • Victory™ TOP DRILL M1™

How to attach inserts



1) Fix drill holder on arbor. For insert exchange, fix arbor on the machine or set on tool presetter.



2) Remove dust using air blast.



3) Put insert into drill holder. (Use gloves to protect your hands.)



4) Turn lightly in a clockwise direction. (Use gloves to protect your hands.)



5) Set the wrench properly.*



6) Make sure the wrench fits with the insert slot for the wrench. (Is the wrench unfixed from the slot?)



7) Slowly turn the wrench in a clockwise direction.



8) Complete.

How to detach inserts



1) Remove dust from insert using air blast.



2) Set the wrench properly.*



3) Fit the wrench to insert slot.



4) Turn the wrench in a counterclockwise direction.



5) Once lock is released, insert can be turned with fingers. (Use gloves to protect your hands.)



6) Remove insert. (Use gloves to protect your hands.)

*To order the TDM1 Wrench, please use order number 3861623 and catalog number 170.315.

Application Data • Victory™ TOP DRILL M1™

Cautions

Coolant



1) Internal coolant is recommended.

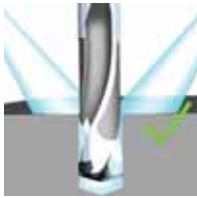

2) In case of external coolant, cutting depth must be 3 x D or less.



3) Dry cutting is not recommended. Limited applicability in cast iron materials, MQL strongly recommended.

Usage Precautions

Core deviation

1) For Turning Machines

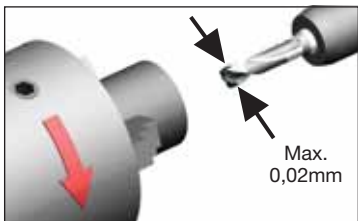

Set deviation amount under 0,02mm between workpiece and drill.

2) For Machining Centers

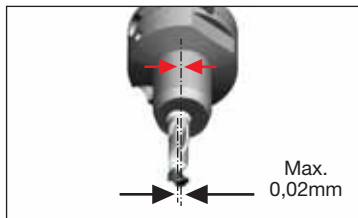

Do not use any arbor with a damaged attachment surface. Center of arbor deviation must be within 0,02mm.

Application Recommendation	Workpiece Shape
Flat Face Recommended	
Stacked Plates Recommended	
Inclined Surface >3° Not Recommended	
Half Cylindrical Not Recommended	
Hole Expansion Not Recommended	
Concave Surface Not Recommended	
Pipe Material Not Recommended	
Cored Hole Not Recommended	



Top Cut 4™

Efficient Indexable Drill • TC4

Top Cut 4 indexable drills are equipped with centering capabilities and inboard and outboard inserts delivering outstanding flexibility and versatility in multiple materials.

Large Coolant Holes
Improves coolant in the cutting zone and facilitates easy chip evacuation.

Large Optimized Chip Flutes to enable chip flow and reduce vibrations.

Rigid Cross Section – Sturdy Body
Higher tool life even in tough conditions.



Top Cut 4 indexable drill portfolio encompasses dual four-edged front inserts, instead of traditional drill point geometry, enabling it to perform in a variety of applications on multiple materials.

FOUR CHIP BREAKERS IN FOUR GRADES

-V34



P K

First choice for machining steel, cast iron and short chipping materials. Suitable for severe cutting conditions.

-V36



P M K N

This insert is suitable for situations with low power consumption.

-V38



P M S

First choice for long chipping materials in titanium and stainless steel.

-DU



P M K

First choice for low-powered applications, machining of steel, cast iron, and stainless steel.

FLEXIBLE AND VERSATILE

PRODUCT

Top Cut 4™ is an efficient drill which performs on PMKN materials with true four cutting edges.

DIAMETER RANGE

12–68mm

INDUSTRY



MATERIALS



APPLICATIONS



DRILLING



INCLINED ENTRY



INCLINED EXIT



CROSS HOLES



BLIND



HALF-CYLINDRICAL DRILLING



CORNER DRILLING 45°



X-OFFSET



CONVEX



CHAIN DRILLING

STEEL BODIES

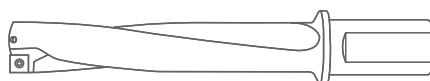
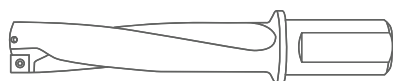
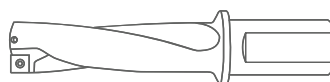

INSERTS

GRADES

WN10PH, WPK10CH,
WU25CH, WU20PH,
WU40PH

FLANGED SLR SHANK

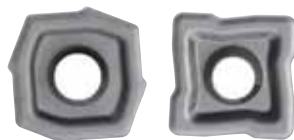

Top Cut 4™ Catalog Numbering System

The guide below provides an example of how to select the Top Cut 4 tool body and accompanying inserts for a stable steel drilling application.

Metric Body

TCF Tool Family Top Cut 4	250 Diameter Metric = 3 digits (e.g. 250 = 25mm) Inch = 4 digits (e.g. 2500 = 2.5")	R Right-Hand Cutting	3 Length Diameter Ratio L/D = 3 x D	SL Shank Style SL = Side Lock Adapter	32 Shank Size	M Metric	D Insert Size
--	---	-----------------------------------	--	--	-------------------------	--------------------	-------------------------

Periphery Insert

TCF Tool Family Top Cut 4	08 Size In-Circle D1	03 Insert Thickness	08 Insert Corner Radius	D Insert Size	P Insert Positioning C = Central P = Periphery	V34 Insert Geometry	WU25CH Grade
--	-----------------------------------	----------------------------------	---	-------------------------	---	----------------------------------	------------------------

Insert Geometry – V34 for steel or cast iron or V36 for stainless steel and long chipping steel.

Insert Guide for Grades

W	U	25	C	H
W	U	40	P	H
W	PK	10	C	H
WIDIA™	Material Range U = Universal P = Steel K = Cast Iron	Toughness Range Choose high numbers for toughness in stable conditions, low numbers for high wear resistance at continuous cuts.	Coating P = PVD C = CVD	Application H = Holemaking

Top Cut 4 • 2 x D • SLR Shanks • Metric

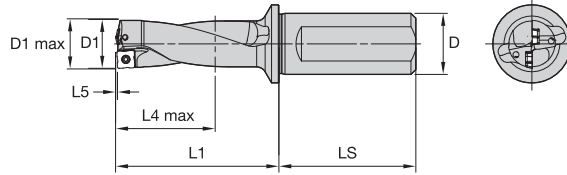

order number	catalogue number	D1	D1 max	D	L1	L4 max	L5	LS	SSC	periphery insert	center insert
5537778	TCF120R2SLR20MA	12,00	12,50	20	43,4	24,4	0,43	50,00	A	TCF040204AP	TCF040203AC
5537779	TCF125R2SLR20MA	12,50	13,00	20	44,5	25,5	0,45	50,00	A	TCF040204AP	TCF040203AC
5537860	TCF127R2SLR20MA	12,70	13,20	20	45,9	25,9	0,46	50,00	A	TCF040204AP	TCF040203AC
5537861	TCF130R2SLR20MA	13,00	13,50	20	46,5	26,5	0,47	50,00	A	TCF040204AP	TCF040203AC
5537862	TCF135R2SLR20MA	13,50	14,00	20	48,5	27,5	0,48	50,00	A	TCF040204AP	TCF040203AC
5577828	TCF140R2SLR25MB	14,00	14,50	25	48,5	28,5	0,49	56,00	B	TCF050204BP	TCF060203BC
5577829	TCF145R2SLR25MB	14,50	15,00	25	49,5	29,5	0,52	56,00	B	TCF050204BP	TCF060203BC
5577920	TCF150R2SLR25MB	15,00	15,50	25	51,5	30,5	0,55	56,00	B	TCF050204BP	TCF060203BC
5577921	TCF155R2SLR25MB	15,50	16,00	25	53,6	31,6	0,56	56,00	B	TCF050204BP	TCF060203BC
5577922	TCF160R2SLR25MB	16,00	16,50	25	54,6	32,6	0,58	56,00	B	TCF050204BP	TCF060203BC
5577923	TCF165R2SLR25MB	16,50	17,00	25	56,6	33,6	0,60	56,00	B	TCF050204BP	TCF060203BC
5577924	TCF170R2SLR25MB	17,00	17,50	25	57,6	34,6	0,61	56,00	B	TCF050204BP	TCF060203BC
5577925	TCF175R2SLR25MB	17,50	18,00	25	59,6	35,6	0,63	56,00	B	TCF050204BP	TCF060203BC
5577926	TCF180R2SLR25MB	18,00	18,50	25	60,6	36,6	0,64	56,00	B	TCF050204BP	TCF060203BC
5577927	TCF185R2SLR25MB	18,50	19,00	25	62,7	37,7	0,65	56,00	B	TCF050204BP	TCF060203BC
5578820	TCF190R2SLR25MC	19,00	19,50	25	63,7	38,7	0,68	56,00	C	TCF070306CP	TCF070304CC
5578821	TCF195R2SLR25MC	19,50	20,00	25	65,7	39,7	0,71	56,00	C	TCF070306CP	TCF070304CC
5578822	TCF200R2SLR25MC	20,00	20,50	25	66,7	40,7	0,72	56,00	C	TCF070306CP	TCF070304CC
5578823	TCF205R2SLR25MC	20,50	21,00	25	68,7	41,7	0,74	56,00	C	TCF070306CP	TCF070304CC
5578824	TCF210R2SLR25MC	21,00	21,50	25	70,8	42,8	0,75	56,00	C	TCF070306CP	TCF070304CC
5578825	TCF220R2SLR25MC	22,00	22,50	25	73,8	44,8	0,78	56,00	C	TCF070306CP	TCF070304CC
5578826	TCF225R2SLR25MC	22,50	23,00	25	74,8	45,8	0,79	56,00	C	TCF070306CP	TCF070304CC
5578827	TCF230R2SLR25MC	23,00	23,50	25	76,8	46,8	0,80	56,00	C	TCF070306CP	TCF070304CC
5537167	TCF240R2SLR25MD	24,00	25,00	25	76,9	48,9	0,87	56,00	D	TCF080308DP	TCF090305DC
5537168	TCF250R2SLR32MD	25,00	26,00	32	80,9	50,9	0,91	60,00	D	TCF080308DP	TCF090305DC
5537169	TCF260R2SLR32MD	26,00	27,00	32	83,9	52,9	0,94	60,00	D	TCF080308DP	TCF090305DC
5537820	TCF265R2SLR32MD	26,50	27,50	32	86,0	54,0	0,95	60,00	D	TCF080308DP	TCF090305DC
5537821	TCF270R2SLR32MD	27,00	28,00	32	87,0	55,0	0,97	60,00	D	TCF080308DP	TCF090305DC
5537822	TCF280R2SLR32MD	28,00	29,00	32	90,0	57,0	0,99	60,00	D	TCF080308DP	TCF090305DC
5537823	TCF290R2SLR32MD	29,00	30,00	32	93,0	59,0	1,02	60,00	D	TCF080308DP	TCF090305DC
5537937	TCF300R2SLR32ME	30,00	31,00	32	93,1	61,1	1,09	60,00	E	TCF100408EP	TCF120405EC
5537938	TCF310R2SLR32ME	31,00	32,00	32	96,1	63,1	1,12	60,00	E	TCF100408EP	TCF120405EC
5537939	TCF320R2SLR32ME	32,00	33,00	32	99,2	65,2	1,15	60,00	E	TCF100408EP	TCF120405EC
5537940	TCF330R2SLR40ME	33,00	34,00	40	103,2	67,2	1,18	70,00	E	TCF100408EP	TCF120405EC
5537941	TCF340R2SLR40ME	34,00	35,00	40	106,2	69,2	1,21	70,00	E	TCF100408EP	TCF120405EC
5537942	TCF350R2SLR40ME	35,00	36,00	40	109,2	71,2	1,24	70,00	E	TCF100408EP	TCF120405EC
5537943	TCF360R2SLR40ME	36,00	37,00	40	112,3	73,3	1,27	70,00	E	TCF100408EP	TCF120405EC
5578539	TCF370R2SLR40MF	37,00	38,00	40	115,3	75,3	1,35	70,00	F	TCF120412FP	TCF150406FC
5578600	TCF375R2SLR40MF	37,50	38,50	40	116,4	76,4	1,36	70,00	F	TCF120412FP	TCF150406FC
5578601	TCF380R2SLR40MF	38,00	39,00	40	118,4	77,4	1,38	70,00	F	TCF120412FP	TCF150406FC
5578602	TCF390R2SLR40MF	39,00	40,00	40	121,4	79,4	1,41	70,00	F	TCF120412FP	TCF150406FC
5578603	TCF400R2SLR40MF	40,00	41,00	40	123,4	81,4	1,45	70,00	F	TCF120412FP	TCF150406FC
5578604	TCF410R2SLR40MF	41,00	42,00	40	126,5	83,5	1,48	70,00	F	TCF120412FP	TCF150406FC
5578605	TCF420R2SLR40MF	42,00	43,00	40	129,5	85,5	1,51	70,00	F	TCF120412FP	TCF150406FC
5578606	TCF430R2SLR40MF	43,00	44,00	40	132,5	87,5	1,53	70,00	F	TCF120412FP	TCF150406FC
5578607	TCF440R2SLR40MF	44,00	45,00	40	135,6	89,6	1,56	70,00	F	TCF120412FP	TCF150406FC
5578608	TCF450R2SLR40MF	45,00	46,00	40	138,6	91,6	1,59	70,00	F	TCF120412FP	TCF150406FC
5578694	TCF460R2SLR40MG	46,00	47,00	40	136,7	93,7	1,67	70,00	G	TCF150512GP	TCF180508GC
5578695	TCF470R2SLR40MG	47,00	48,00	40	139,7	95,7	1,70	70,00	G	TCF150512GP	TCF180508GC
5578696	TCF480R2SLR40MG	48,00	49,00	40	142,7	97,7	1,73	70,00	G	TCF150512GP	TCF180508GC
5578697	TCF490R2SLR40MG	49,00	50,00	40	145,8	99,8	1,76	70,00	G	TCF150512GP	TCF180508GC
5578698	TCF500R2SLR40MG	50,00	51,00	40	147,8	101,8	1,79	70,00	G	TCF150512GP	TCF180508GC
5578699	TCF505R2SLR40MG	50,50	51,50	40	149,8	102,8	1,80	70,00	G	TCF150512GP	TCF180508GC
5578710	TCF510R2SLR40MG	51,00	52,00	40	150,8	103,8	1,81	70,00	G	TCF150512GP	TCF180508GC
5578711	TCF520R2SLR40MG	52,00	53,00	40	153,8	105,8	1,84	70,00	G	TCF150512GP	TCF180508GC
5578712	TCF530R2SLR40MG	53,00	54,00	40	156,9	107,9	1,87	70,00	G	TCF150512GP	TCF180508GC
5578713	TCF540R2SLR40MG	54,00	55,00	40	159,9	109,9	1,89	70,00	G	TCF150512GP	TCF180508GC
5578714	TCF550R2SLR40MG	55,00	56,00	40	161,9	111,9	1,92	70,00	G	TCF150512GP	TCF180508GC
5578715	TCF560R2SLR40MG	56,00	57,00	40	164,9	113,9	1,94	70,00	G	TCF150512GP	TCF180508GC
5538613	TCF570R2SLR40MH	57,00	58,00	40	162,1	116,1	2,06	70,00	H	TCF180614HP	TCF210608HC
5538614	TCF580R2SLR40MH	58,00	59,00	40	165,1	118,1	2,09	70,00	H	TCF180614HP	TCF210608HC
5538615	TCF590R2SLR40MH	59,00	60,00	40	168,1	120,1	2,12	70,00	H	TCF180614HP	TCF210608HC
5538616	TCF600R2SLR40MH	60,00	61,00	40	170,1	122,1	2,15	70,00	H	TCF180614HP	TCF210608HC
5538617	TCF610R2SLR40MH	61,00	62,00	40	173,2	124,2	2,18	70,00	H	TCF180614HP	TCF210608HC

Top Cut 4 • 2 x D • SLR Shanks • Metric

(continued)

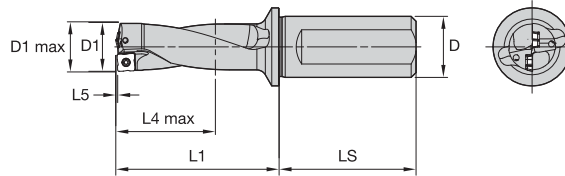

order number	catalogue number	D1	D1 max	D	L1	L4 max	L5	LS	SSC	periphery insert	center insert
5538618	TCF620R2SLR40MH	62,00	63,00	40	176,2	126,2	2,20	70,00	H	TCF180614HP	TCF210608HC
5538619	TCF630R2SLR40MH	63,00	64,00	40	179,2	128,2	2,23	70,00	H	TCF180614HP	TCF210608HC
5538630	TCF640R2SLR40MH	64,00	65,00	40	181,3	130,3	2,26	70,00	H	TCF180614HP	TCF210608HC
5538631	TCF650R2SLR40MH	65,00	66,00	40	184,3	132,3	2,28	70,00	H	TCF180614HP	TCF210608HC
5538632	TCF660R2SLR40MH	66,00	67,00	40	187,3	134,3	2,31	70,00	H	TCF180614HP	TCF210608HC
5538633	TCF670R2SLR40MH	67,00	68,00	40	189,3	136,3	2,33	70,00	H	TCF180614HP	TCF210608HC
5538634	TCF680R2SLR40MH	68,00	69,00	40	192,4	138,4	2,36	70,00	H	TCF180614HP	TCF210608HC

D	LS
20,00	50
25,00	56
32,00	60
40,00	70

NOTE: SSC = Pocket Seat Reference. To correspond with the SSC on the inserts.

NOTE: Drilling in stacked plates possible in certain applications. Ask for technical support.

Drill shipped with insert screws and Torx wrench.

See pages C97-C104 for inserts.

SSC = Pocket Seat Reference.

SLR = Side Lock.

D1 max is an achievable diameter using x-offset.

WARNING

During through-hole operations, a slug or disc is produced as the tool breaks through the workpiece.

When the drill is stationary and the workpiece is rotating, this slug may be hurled from the chuck by centrifugal force.

Provide adequate shielding to protect bystanders.

Top Cut 4 • 3 x D • SLR Shanks • Metric

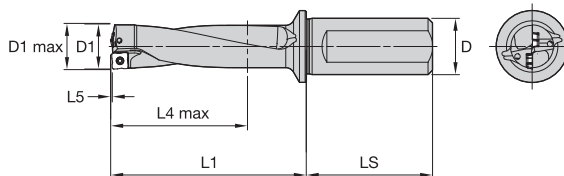

order number	catalogue number	D1	D1 max	D	L1	L4 max	L5	LS	SSC	periphery insert	center insert
5537863	TCF120R3SLR20MA	12,00	12,50	20	55,4	36,4	0,43	50,00	A	TCF040204AP	TCF040203AC
5537864	TCF125R3SLR20MA	12,50	13,00	20	57,0	38,0	0,45	50,00	A	TCF040204AP	TCF040203AC
5537866	TCF127R3SLR20MA	12,70	13,20	20	58,6	38,6	0,46	50,00	A	TCF040204AP	TCF040203AC
5537867	TCF130R3SLR20MA	13,00	13,50	20	59,5	39,5	0,47	50,00	A	TCF040204AP	TCF040203AC
5537868	TCF135R3SLR20MA	13,50	14,00	20	61,0	41,0	0,48	50,00	A	TCF040204AP	TCF040203AC
5577928	TCF140R3SLR25MB	14,00	14,50	25	62,5	42,5	0,49	56,00	B	TCF050204BP	TCF060203BC
5577929	TCF145R3SLR25MB	14,50	15,00	25	64,0	44,0	0,52	56,00	B	TCF050204BP	TCF060203BC
5577930	TCF150R3SLR25MB	15,00	15,50	25	66,5	45,5	0,55	56,00	B	TCF050204BP	TCF060203BC
5577931	TCF155R3SLR25MB	15,50	16,00	25	69,1	47,1	0,56	56,00	B	TCF050204BP	TCF060203BC
5577932	TCF160R3SLR25MB	16,00	16,50	25	70,6	48,6	0,58	56,00	B	TCF050204BP	TCF060203BC
5577933	TCF165R3SLR25MB	16,50	17,00	25	73,1	50,1	0,60	56,00	B	TCF050204BP	TCF060203BC
5577934	TCF170R3SLR25MB	17,00	17,50	25	74,6	51,6	0,61	56,00	B	TCF050204BP	TCF060203BC
5577935	TCF175R3SLR25MB	17,50	18,00	25	77,1	53,1	0,63	56,00	B	TCF050204BP	TCF060203BC
5577936	TCF180R3SLR25MB	18,00	18,50	25	78,6	54,6	0,64	56,00	B	TCF050204BP	TCF060203BC
5577937	TCF185R3SLR25MB	18,50	19,00	25	81,2	56,2	0,65	56,00	B	TCF050204BP	TCF060203BC
5578828	TCF190R3SLR25MC	19,00	19,50	25	82,7	57,7	0,68	56,00	C	TCF070306CP	TCF070304CC
5578829	TCF195R3SLR25MC	19,50	20,00	25	85,2	59,2	0,71	56,00	C	TCF070306CP	TCF070304CC
5578830	TCF200R3SLR25MC	20,00	20,50	25	86,7	60,7	0,72	56,00	C	TCF070306CP	TCF070304CC
5578831	TCF205R3SLR25MC	20,50	21,00	25	89,2	62,2	0,74	56,00	C	TCF070306CP	TCF070304CC
5578832	TCF210R3SLR25MC	21,00	21,50	25	91,8	63,8	0,75	56,00	C	TCF070306CP	TCF070304CC
5578833	TCF220R3SLR25MC	22,00	22,50	25	95,8	66,8	0,78	56,00	C	TCF070306CP	TCF070304CC
5578834	TCF225R3SLR25MC	22,50	23,00	25	97,3	68,3	0,79	56,00	C	TCF070306CP	TCF070304CC
5578835	TCF230R3SLR25MC	23,00	23,50	25	99,8	69,8	0,80	56,00	C	TCF070306CP	TCF070304CC
5537824	TCF240R3SLR25MD	24,00	25,00	25	100,9	72,9	0,87	56,00	D	TCF080308DP	TCF090305DC
5537825	TCF250R3SLR32MD	25,00	26,00	32	105,9	75,9	0,91	60,00	D	TCF080308DP	TCF090305DC
5537826	TCF260R3SLR32MD	26,00	27,00	32	109,9	78,9	0,94	60,00	D	TCF080308DP	TCF090305DC
5537827	TCF265R3SLR32MD	26,50	27,50	32	112,5	80,5	0,95	60,00	D	TCF080308DP	TCF090305DC
5537828	TCF270R3SLR32MD	27,00	28,00	32	114,0	82,0	0,97	60,00	D	TCF080308DP	TCF090305DC
5537829	TCF280R3SLR32MD	28,00	29,00	32	118,0	85,0	0,99	60,00	D	TCF080308DP	TCF090305DC
5537830	TCF290R3SLR32MD	29,00	30,00	32	122,0	88,0	1,02	60,00	D	TCF080308DP	TCF090305DC
5537944	TCF300R3SLR32ME	30,00	31,00	32	123,1	91,1	1,09	60,00	E	TCF100408EP	TCF120405EC
5537945	TCF310R3SLR32ME	31,00	32,00	32	127,1	94,1	1,12	60,00	E	TCF100408EP	TCF120405EC
5537946	TCF320R3SLR32ME	32,00	33,00	32	131,2	97,2	1,15	60,00	E	TCF100408EP	TCF120405EC
5537947	TCF330R3SLR40ME	33,00	34,00	40	136,2	100,2	1,18	70,00	E	TCF100408EP	TCF120405EC
5537948	TCF340R3SLR40ME	34,00	35,00	40	140,2	103,2	1,21	70,00	E	TCF100408EP	TCF120405EC
5537949	TCF350R3SLR40ME	35,00	36,00	40	144,2	106,2	1,24	70,00	E	TCF100408EP	TCF120405EC
5537950	TCF360R3SLR40ME	36,00	37,00	40	148,3	109,3	1,27	70,00	E	TCF100408EP	TCF120405EC
5578609	TCF370R3SLR40MF	37,00	38,00	40	152,3	112,3	1,35	70,00	F	TCF120412FP	TCF150406FC
5578610	TCF375R3SLR40MF	37,50	38,50	40	153,9	113,9	1,36	70,00	F	TCF120412FP	TCF150406FC
5578611	TCF380R3SLR40MF	38,00	39,00	40	156,4	115,4	1,38	70,00	F	TCF120412FP	TCF150406FC
5578612	TCF390R3SLR40MF	39,00	40,00	40	160,4	118,4	1,41	70,00	F	TCF120412FP	TCF150406FC
5578613	TCF400R3SLR40MF	40,00	41,00	40	163,4	121,4	1,45	70,00	F	TCF120412FP	TCF150406FC
5578614	TCF410R3SLR40MF	41,00	42,00	40	167,5	124,5	1,48	70,00	F	TCF120412FP	TCF150406FC
5578615	TCF420R3SLR40MF	42,00	43,00	40	171,5	127,5	1,51	70,00	F	TCF120412FP	TCF150406FC
5578616	TCF430R3SLR40MF	43,00	44,00	40	175,5	130,5	1,53	70,00	F	TCF120412FP	TCF150406FC
5578617	TCF440R3SLR40MF	44,00	45,00	40	179,6	133,6	1,56	70,00	F	TCF120412FP	TCF150406FC
5578618	TCF450R3SLR40MF	45,00	46,00	40	183,6	136,6	1,59	70,00	F	TCF120412FP	TCF150406FC
5578716	TCF460R3SLR40MG	46,00	47,00	40	182,7	139,7	1,67	70,00	G	TCF150512GP	TCF180508GC
5578717	TCF470R3SLR40MG	47,00	48,00	40	186,7	142,7	1,70	70,00	G	TCF150512GP	TCF180508GC
5578718	TCF480R3SLR40MG	48,00	49,00	40	190,7	145,7	1,73	70,00	G	TCF150512GP	TCF180508GC
5578719	TCF490R3SLR40MG	49,00	50,00	40	194,8	148,8	1,76	70,00	G	TCF150512GP	TCF180508GC
5578720	TCF500R3SLR40MG	50,00	51,00	40	197,8	151,8	1,79	70,00	G	TCF150512GP	TCF180508GC
5578721	TCF505R3SLR40MG	50,50	51,50	40	200,3	153,3	1,80	70,00	G	TCF150512GP	TCF180508GC
5578722	TCF510R3SLR40MG	51,00	52,00	40	201,8	154,8	1,81	70,00	G	TCF150512GP	TCF180508GC
5578723	TCF520R3SLR40MG	52,00	53,00	40	205,8	157,8	1,84	70,00	G	TCF150512GP	TCF180508GC
5578724	TCF530R3SLR40MG	53,00	54,00	40	209,9	160,9	1,87	70,00	G	TCF150512GP	TCF180508GC
5578726	TCF540R3SLR40MG	54,00	55,00	40	213,9	163,9	1,89	70,00	G	TCF150512GP	TCF180508GC
5578727	TCF550R3SLR40MG	55,00	56,00	40	216,9	166,9	1,92	70,00	G	TCF150512GP	TCF180508GC
5578728	TCF560R3SLR40MG	56,00	57,00	40	220,9	169,9	1,94	70,00	G	TCF150512GP	TCF180508GC
5538635	TCF570R3SLR40MH	57,00	58,00	40	219,1	173,1	2,06	70,00	H	TCF180614HP	TCF210608HC
5538636	TCF580R3SLR40MH	58,00	59,00	40	223,1	176,1	2,09	70,00	H	TCF180614HP	TCF210608HC
5538637	TCF590R3SLR40MH	59,00	60,00	40	227,1	179,1	2,12	70,00	H	TCF180614HP	TCF210608HC
5538638	TCF600R3SLR40MH	60,00	61,00	40	230,1	182,1	2,15	70,00	H	TCF180614HP	TCF210608HC
5538639	TCF610R3SLR40MH	61,00	62,00	40	234,2	185,2	2,18	70,00	H	TCF180614HP	TCF210608HC

Top Cut 4 • 3 x D • SLR Shanks • Metric

(continued)

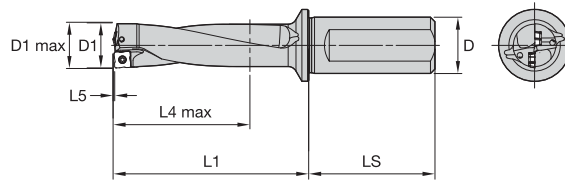

order number	catalogue number	D1	D1 max	D	L1	L4 max	L5	LS	SSC	periphery insert	center insert
5538640	TCF620R3SLR40MH	62,00	63,00	40	238,2	188,2	2,20	70,00	H	TCF180614HP	TCF210608HC
5538641	TCF630R3SLR40MH	63,00	64,00	40	242,2	191,2	2,23	70,00	H	TCF180614HP	TCF210608HC
5538642	TCF640R3SLR40MH	64,00	65,00	40	245,3	194,3	2,26	70,00	H	TCF180614HP	TCF210608HC
5538643	TCF650R3SLR40MH	65,00	66,00	40	249,3	197,3	2,28	70,00	H	TCF180614HP	TCF210608HC
5538644	TCF660R3SLR40MH	66,00	67,00	40	253,3	200,3	2,31	70,00	H	TCF180614HP	TCF210608HC
5538645	TCF670R3SLR40MH	67,00	68,00	40	256,3	203,3	2,33	70,00	H	TCF180614HP	TCF210608HC
5538646	TCF680R3SLR40MH	68,00	69,00	40	260,4	206,4	2,36	70,00	H	TCF180614HP	TCF210608HC

D	LS
20,00	50
25,00	56
32,00	60
40,00	70

NOTE: SSC = Pocket Seat Reference. To correspond with the SSC on the inserts.

NOTE: Drilling in stacked plates possible in certain applications. Ask for technical support.

Drill shipped with insert screws and Torx wrench.

See pages C97-C104 for inserts.

SSC = Pocket Seat Reference.

SLR = Side Lock.

D1 max is an achievable diameter using x-offset.

WARNING

During through-hole operations, a slug or disc is produced as the tool breaks through the workpiece. When the drill is stationary and the workpiece is rotating, this slug may be hurled from the chuck by centrifugal force. Provide adequate shielding to protect bystanders.

Top Cut 4 • 4 x D • SLR Shanks • Metric

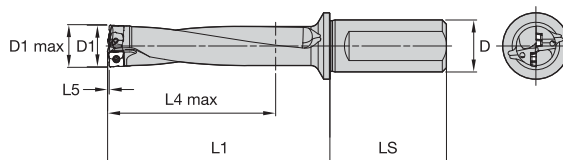

order number	catalogue number	D1	D1 max	D	L1	L4 max	L5	LS	SSC	periphery insert	center insert
5537869	TCF120R4SLR20MA	12,00	12,50	20	67,4	48,4	0,43	50,00	A	TCF040204AP	TCF040203AC
5537870	TCF125R4SLR20MA	12,50	13,00	20	69,5	50,5	0,45	50,00	A	TCF040204AP	TCF040203AC
5537871	TCF127R4SLR20MA	12,70	13,20	20	71,3	51,3	0,46	50,00	A	TCF040204AP	TCF040203AC
5537872	TCF130R4SLR20MA	13,00	13,50	20	72,5	52,5	0,47	50,00	A	TCF040204AP	TCF040203AC
5537873	TCF135R4SLR20MA	13,50	14,00	20	75,5	54,5	0,48	50,00	A	TCF040204AP	TCF040203AC
5577938	TCF140R4SLR25MB	14,00	14,50	25	76,5	56,5	0,49	56,00	B	TCF050204BP	TCF060203BC
5577939	TCF145R4SLR25MB	14,50	15,00	25	78,5	58,5	0,52	56,00	B	TCF050204BP	TCF060203BC
5577940	TCF150R4SLR25MB	15,00	15,50	25	81,5	60,5	0,55	56,00	B	TCF050204BP	TCF060203BC
5577941	TCF155R4SLR25MB	15,50	16,00	25	84,6	62,6	0,56	56,00	B	TCF050204BP	TCF060203BC
5577942	TCF160R4SLR25MB	16,00	16,50	25	86,6	64,6	0,58	56,00	B	TCF050204BP	TCF060203BC
5577943	TCF165R4SLR25MB	16,50	17,00	25	89,6	66,6	0,60	56,00	B	TCF050204BP	TCF060203BC
5577944	TCF170R4SLR25MB	17,00	17,50	25	91,6	68,6	0,61	56,00	B	TCF050204BP	TCF060203BC
5577945	TCF175R4SLR25MB	17,50	18,00	25	94,6	70,6	0,63	56,00	B	TCF050204BP	TCF060203BC
5577946	TCF180R4SLR25MB	18,00	18,50	25	96,6	72,6	0,64	56,00	B	TCF050204BP	TCF060203BC
5577947	TCF185R4SLR25MB	18,50	19,00	25	99,7	74,7	0,65	56,00	B	TCF050204BP	TCF060203BC
5578836	TCF190R4SLR25MC	19,00	19,50	25	101,7	76,7	0,68	56,00	C	TCF070306CP	TCF070304CC
5578837	TCF195R4SLR25MC	19,50	20,00	25	104,7	78,7	0,71	56,00	C	TCF070306CP	TCF070304CC
5578838	TCF200R4SLR25MC	20,00	20,50	25	106,7	80,7	0,72	56,00	C	TCF070306CP	TCF070304CC
5578839	TCF205R4SLR25MC	20,50	21,00	25	109,7	82,7	0,74	56,00	C	TCF070306CP	TCF070304CC
5578840	TCF210R4SLR25MC	21,00	21,50	25	112,8	84,8	0,75	56,00	C	TCF070306CP	TCF070304CC
5578841	TCF220R4SLR25MC	22,00	22,50	25	117,8	88,8	0,78	56,00	C	TCF070306CP	TCF070304CC
5578842	TCF225R4SLR25MC	22,50	23,00	25	119,8	90,8	0,79	56,00	C	TCF070306CP	TCF070304CC
5578843	TCF230R4SLR25MC	23,00	23,50	25	122,8	92,8	0,80	56,00	C	TCF070306CP	TCF070304CC
5537831	TCF240R4SLR25MD	24,00	25,00	25	124,9	96,9	0,87	56,00	D	TCF080308DP	TCF090305DC
5537832	TCF250R4SLR32MD	25,00	26,00	32	130,9	100,9	0,91	60,00	D	TCF080308DP	TCF090305DC
5537833	TCF260R4SLR32MD	26,00	27,00	32	135,9	104,9	0,94	60,00	D	TCF080308DP	TCF090305DC
5537834	TCF265R4SLR32MD	26,50	27,50	32	139,0	107,0	0,95	60,00	D	TCF080308DP	TCF090305DC
5537835	TCF270R4SLR32MD	27,00	28,00	32	141,0	109,0	0,97	60,00	D	TCF080308DP	TCF090305DC
5537836	TCF280R4SLR32MD	28,00	29,00	32	146,0	113,0	0,99	60,00	D	TCF080308DP	TCF090305DC
5537837	TCF290R4SLR32MD	29,00	30,00	32	151,0	117,0	1,02	60,00	D	TCF080308DP	TCF090305DC
5537951	TCF300R4SLR32ME	30,00	31,00	32	153,1	121,1	1,09	60,00	E	TCF100408EP	TCF120405EC
5537952	TCF310R4SLR32ME	31,00	32,00	32	158,1	125,1	1,12	60,00	E	TCF100408EP	TCF120405EC
5537953	TCF320R4SLR32ME	32,00	33,00	32	163,2	129,2	1,15	60,00	E	TCF100408EP	TCF120405EC
5537954	TCF330R4SLR40ME	33,00	34,00	40	165,2	133,2	1,18	70,00	E	TCF100408EP	TCF120405EC
5537955	TCF340R4SLR40ME	34,00	35,00	40	174,2	137,2	1,21	70,00	E	TCF100408EP	TCF120405EC
5537956	TCF350R4SLR40ME	35,00	36,00	40	179,2	141,2	1,24	70,00	E	TCF100408EP	TCF120405EC
5537957	TCF360R4SLR40ME	36,00	37,00	40	184,3	145,3	1,27	70,00	E	TCF100408EP	TCF120405EC
5578619	TCF370R4SLR40MF	37,00	38,00	40	189,3	149,3	1,35	70,00	F	TCF120412FP	TCF150406FC
5578620	TCF375R4SLR40MF	37,50	38,50	40	191,4	151,4	1,36	70,00	F	TCF120412FP	TCF150406FC
5578621	TCF380R4SLR40MF	38,00	39,00	40	194,4	153,4	1,38	70,00	F	TCF120412FP	TCF150406FC
5578622	TCF390R4SLR40MF	39,00	40,00	40	199,4	157,4	1,41	70,00	F	TCF120412FP	TCF150406FC
5578623	TCF400R4SLR40MF	40,00	41,00	40	203,4	161,4	1,45	70,00	F	TCF120412FP	TCF150406FC
5578624	TCF410R4SLR40MF	41,00	42,00	40	208,5	165,5	1,48	70,00	F	TCF120412FP	TCF150406FC
5578625	TCF420R4SLR40MF	42,00	43,00	40	213,5	169,5	1,51	70,00	F	TCF120412FP	TCF150406FC
5578626	TCF430R4SLR40MF	43,00	44,00	40	218,5	173,5	1,53	70,00	F	TCF120412FP	TCF150406FC
5578627	TCF440R4SLR40MF	44,00	45,00	40	223,6	177,6	1,56	70,00	F	TCF120412FP	TCF150406FC
5578628	TCF450R4SLR40MF	45,00	46,00	40	228,6	181,6	1,59	70,00	F	TCF120412FP	TCF150406FC
5578729	TCF460R4SLR40MG	46,00	47,00	40	228,7	185,7	1,67	70,00	G	TCF150512GP	TCF180508GC
5578730	TCF470R4SLR40MG	47,00	48,00	40	233,7	189,7	1,70	70,00	G	TCF150512GP	TCF180508GC
5578731	TCF480R4SLR40MG	48,00	49,00	40	238,7	193,7	1,73	70,00	G	TCF150512GP	TCF180508GC
5578732	TCF490R4SLR40MG	49,00	50,00	40	243,8	197,8	1,76	70,00	G	TCF150512GP	TCF180508GC
5578733	TCF500R4SLR40MG	50,00	51,00	40	247,8	201,8	1,79	70,00	G	TCF150512GP	TCF180508GC
5578734	TCF505R4SLR40MG	50,50	51,50	40	250,8	203,8	1,80	70,00	G	TCF150512GP	TCF180508GC
5578735	TCF510R4SLR40MG	51,00	52,00	40	252,8	205,8	1,81	70,00	G	TCF150512GP	TCF180508GC
5578736	TCF520R4SLR40MG	52,00	53,00	40	257,8	209,8	1,84	70,00	G	TCF150512GP	TCF180508GC
5578737	TCF530R4SLR40MG	53,00	54,00	40	262,9	213,9	1,87	70,00	G	TCF150512GP	TCF180508GC
5578738	TCF540R4SLR40MG	54,00	55,00	40	267,9	217,9	1,89	70,00	G	TCF150512GP	TCF180508GC
5578739	TCF550R4SLR40MG	55,00	56,00	40	271,9	221,9	1,92	70,00	G	TCF150512GP	TCF180508GC
5578750	TCF560R4SLR40MG	56,00	57,00	40	276,9	225,9	1,94	70,00	G	TCF150512GP	TCF180508GC
5538647	TCF570R4SLR40MH	57,00	58,00	40	276,1	230,1	2,06	70,00	H	TCF180614HP	TCF210608HC
5538648	TCF580R4SLR40MH	58,00	59,00	40	281,1	234,1	2,09	70,00	H	TCF180614HP	TCF210608HC
5538649	TCF590R4SLR40MH	59,00	60,00	40	286,1	238,1	2,12	70,00	H	TCF180614HP	TCF210608HC
5538650	TCF600R4SLR40MH	60,00	61,00	40	290,1	242,1	2,15	70,00	H	TCF180614HP	TCF210608HC
5538651	TCF610R4SLR40MH	61,00	62,00	40	295,2	246,2	2,18	70,00	H	TCF180614HP	TCF210608HC

Top Cut 4 • 4 x D • SLR Shanks • Metric

(continued)

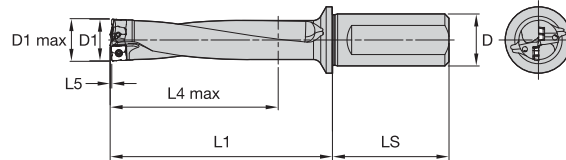

order number	catalogue number	D1	D1 max	D	L1	L4 max	L5	LS	SSC	periphery insert	center insert
5538652	TCF620R4SLR40MH	62,00	63,00	40	300,2	250,2	2,20	70,00	H	TCF180614HP	TCF210608HC
5538653	TCF630R4SLR40MH	63,00	64,00	40	305,2	254,2	2,23	70,00	H	TCF180614HP	TCF210608HC
5538654	TCF640R4SLR40MH	64,00	65,00	40	309,3	258,3	2,26	70,00	H	TCF180614HP	TCF210608HC
5538655	TCF650R4SLR40MH	65,00	66,00	40	314,3	262,3	2,28	70,00	H	TCF180614HP	TCF210608HC
5538656	TCF660R4SLR40MH	66,00	67,00	40	319,3	266,3	2,31	70,00	H	TCF180614HP	TCF210608HC
5538657	TCF670R4SLR40MH	67,00	68,00	40	323,3	270,3	2,33	70,00	H	TCF180614HP	TCF210608HC
5538658	TCF680R4SLR40MH	68,00	69,00	40	328,4	274,4	2,36	70,00	H	TCF180614HP	TCF210608HC

D	LS
20,00	50
25,00	56
32,00	60
40,00	70

NOTE: SSC = Pocket Seat Reference. To correspond with the SSC on the inserts.
 NOTE: Drilling in stacked plates possible in certain applications. Ask for technical support.
 Drill shipped with insert screws and Torx wrench.
 See pages C97–C104 for inserts.
 SSC = Pocket Seat Reference.
 SLR = Side Lock.
 D1 max is an achievable diameter using x-offset.

WARNING

During through-hole operations, a slug or disc is produced as the tool breaks through the workpiece.
 When the drill is stationary and the workpiece is rotating, this slug may be hurled from the chuck by centrifugal force.
 Provide adequate shielding to protect bystanders.

Top Cut 4 • 5 x D • SLR Shank • Metric

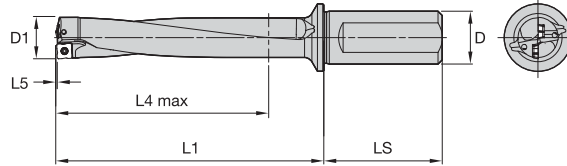

order number	catalogue number	D1	D	L1	L4 max	L5	LS	SSC	periphery insert	center insert
5537874	TCF120R5SLR20MA	12,00	20	79,4	60,4	0,43	50,00	A	TCF040204AP	TCF040203AC
5537875	TCF125R5SLR20MA	12,50	20	82,0	63,0	0,45	50,00	A	TCF040204AP	TCF040203AC
5537876	TCF127R5SLR20MA	12,70	20	84,0	64,0	0,46	50,00	A	TCF040204AP	TCF040203AC
5537877	TCF130R5SLR20MA	13,00	20	85,5	65,5	0,47	50,00	A	TCF040204AP	TCF040203AC
5537878	TCF135R5SLR20MA	13,50	20	89,0	68,0	0,48	50,00	A	TCF040204AP	TCF040203AC
5577948	TCF140R5SLR25MB	14,00	25	90,5	70,5	0,49	56,00	B	TCF050204BP	TCF060203BC
5577949	TCF145R5SLR25MB	14,50	25	93,0	73,0	0,52	56,00	B	TCF050204BP	TCF060203BC
5577950	TCF150R5SLR25MB	15,00	25	96,5	75,5	0,55	56,00	B	TCF050204BP	TCF060203BC
5577951	TCF155R5SLR25MB	15,50	25	100,1	78,1	0,56	56,00	B	TCF050204BP	TCF060203BC
5577952	TCF160R5SLR25MB	16,00	25	102,6	80,6	0,58	56,00	B	TCF050204BP	TCF060203BC
5577953	TCF165R5SLR25MB	16,50	25	106,1	83,1	0,60	56,00	B	TCF050204BP	TCF060203BC
5577954	TCF170R5SLR25MB	17,00	25	108,6	85,6	0,61	56,00	B	TCF050204BP	TCF060203BC
5577955	TCF175R5SLR25MB	17,50	25	112,1	88,1	0,63	56,00	B	TCF050204BP	TCF060203BC
5577956	TCF180R5SLR25MB	18,00	25	114,6	90,6	0,64	56,00	B	TCF050204BP	TCF060203BC
5577957	TCF185R5SLR25MB	18,50	25	118,2	93,2	0,65	56,00	B	TCF050204BP	TCF060203BC
5578844	TCF190R5SLR25MC	19,00	25	120,7	95,7	0,68	56,00	C	TCF070306CP	TCF070304CC
5578845	TCF195R5SLR25MC	19,50	25	124,2	98,2	0,71	56,00	C	TCF070306CP	TCF070304CC
5578846	TCF200R5SLR25MC	20,00	25	126,7	100,7	0,72	56,00	C	TCF070306CP	TCF070304CC
5578847	TCF205R5SLR25MC	20,50	25	130,2	103,2	0,74	56,00	C	TCF070306CP	TCF070304CC
5578848	TCF210R5SLR25MC	21,00	25	133,8	105,8	0,75	56,00	C	TCF070306CP	TCF070304CC
5578849	TCF220R5SLR25MC	22,00	25	139,8	110,8	0,78	56,00	C	TCF070306CP	TCF070304CC
5578850	TCF225R5SLR25MC	22,50	25	142,3	113,3	0,79	56,00	C	TCF070306CP	TCF070304CC
5578851	TCF230R5SLR25MC	23,00	25	145,8	115,8	0,80	56,00	C	TCF070306CP	TCF070304CC
5537838	TCF240R5SLR25MD	24,00	25	148,9	120,9	0,87	56,00	D	TCF080308DP	TCF090305DC
5537839	TCF250R5SLR32MD	25,00	32	155,9	125,9	0,91	60,00	D	TCF080308DP	TCF090305DC
5537840	TCF260R5SLR32MD	26,00	32	161,9	130,9	0,94	60,00	D	TCF080308DP	TCF090305DC
5537841	TCF265R5SLR32MD	26,50	32	165,5	133,5	0,95	60,00	D	TCF080308DP	TCF090305DC
5537842	TCF270R5SLR32MD	27,00	32	168,0	136,0	0,97	60,00	D	TCF080308DP	TCF090305DC
5537843	TCF280R5SLR32MD	28,00	32	174,0	141,0	0,99	60,00	D	TCF080308DP	TCF090305DC
5537844	TCF290R5SLR32MD	29,00	32	180,0	146,0	1,02	60,00	D	TCF080308DP	TCF090305DC
5537958	TCF300R5SLR32ME	30,00	32	183,1	151,1	1,09	60,00	E	TCF100408EP	TCF120405EC
5537959	TCF310R5SLR32ME	31,00	32	189,1	156,1	1,12	60,00	E	TCF100408EP	TCF120405EC
5537960	TCF320R5SLR32ME	32,00	32	195,2	161,2	1,15	60,00	E	TCF100408EP	TCF120405EC
5537961	TCF330R5SLR40ME	33,00	40	202,2	166,2	1,18	70,00	E	TCF100408EP	TCF120405EC
5537962	TCF340R5SLR40ME	34,00	40	208,2	171,2	1,21	70,00	E	TCF100408EP	TCF120405EC
5537963	TCF350R5SLR40ME	35,00	40	214,2	176,2	1,24	70,00	E	TCF100408EP	TCF120405EC
5537964	TCF360R5SLR40ME	36,00	40	220,3	181,3	1,27	70,00	E	TCF100408EP	TCF120405EC
5578629	TCF370R5SLR40MF	37,00	40	226,3	186,3	1,35	70,00	F	TCF120412FP	TCF150406FC
5578640	TCF375R5SLR40MF	37,50	40	228,9	188,9	1,36	70,00	F	TCF120412FP	TCF150406FC
5578641	TCF380R5SLR40MF	38,00	40	232,4	191,4	1,38	70,00	F	TCF120412FP	TCF150406FC
5578642	TCF390R5SLR40MF	39,00	40	238,4	196,4	1,41	70,00	F	TCF120412FP	TCF150406FC
5578643	TCF400R5SLR40MF	40,00	40	243,4	201,4	1,45	70,00	F	TCF120412FP	TCF150406FC
5578644	TCF410R5SLR40MF	41,00	40	249,5	206,5	1,48	70,00	F	TCF120412FP	TCF150406FC
5578645	TCF420R5SLR40MF	42,00	40	255,5	211,5	1,51	70,00	F	TCF120412FP	TCF150406FC
5578646	TCF430R5SLR40MF	43,00	40	261,5	216,5	1,53	70,00	F	TCF120412FP	TCF150406FC
5578647	TCF440R5SLR40MF	44,00	40	267,6	221,6	1,56	70,00	F	TCF120412FP	TCF150406FC
5578648	TCF450R5SLR40MF	45,00	40	273,6	226,6	1,59	70,00	F	TCF120412FP	TCF150406FC
5578751	TCF460R5SLR40MG	46,00	40	274,7	231,7	1,67	70,00	G	TCF150512GP	TCF180508GC
5578752	TCF470R5SLR40MG	47,00	40	280,7	236,7	1,70	70,00	G	TCF150512GP	TCF180508GC
5578753	TCF480R5SLR40MG	48,00	40	286,7	241,7	1,73	70,00	G	TCF150512GP	TCF180508GC
5578754	TCF490R5SLR40MG	49,00	40	292,8	246,8	1,76	70,00	G	TCF150512GP	TCF180508GC
5578755	TCF500R5SLR40MG	50,00	40	297,8	251,8	1,79	70,00	G	TCF150512GP	TCF180508GC
5578756	TCF505R5SLR40MG	50,50	40	301,3	254,3	1,80	70,00	G	TCF150512GP	TCF180508GC
5578757	TCF510R5SLR40MG	51,00	40	303,8	256,8	1,81	70,00	G	TCF150512GP	TCF180508GC
5578758	TCF520R5SLR40MG	52,00	40	309,8	261,8	1,84	70,00	G	TCF150512GP	TCF180508GC
5578759	TCF530R5SLR40MG	53,00	40	315,9	266,9	1,87	70,00	G	TCF150512GP	TCF180508GC
5578760	TCF540R5SLR40MG	54,00	40	321,9	271,9	1,89	70,00	G	TCF150512GP	TCF180508GC
5578761	TCF550R5SLR40MG	55,00	40	326,9	276,9	1,92	70,00	G	TCF150512GP	TCF180508GC
5578762	TCF560R5SLR40MG	56,00	40	332,9	281,9	1,94	70,00	G	TCF150512GP	TCF180508GC
5538659	TCF570R5SLR40MH	57,00	40	333,1	287,1	2,06	70,00	H	TCF180614HP	TCF210608HC
5538680	TCF580R5SLR40MH	58,00	40	339,1	292,1	2,09	70,00	H	TCF180614HP	TCF210608HC
5538681	TCF590R5SLR40MH	59,00	40	345,1	297,1	2,12	70,00	H	TCF180614HP	TCF210608HC
5538682	TCF600R5SLR40MH	60,00	40	350,1	302,1	2,15	70,00	H	TCF180614HP	TCF210608HC
5538683	TCF610R5SLR40MH	61,00	40	356,2	307,2	2,18	70,00	H	TCF180614HP	TCF210608HC

Top Cut 4 • 5 x D • SLR Shank • Metric

(continued)

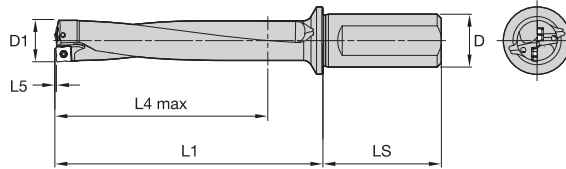

order number	catalogue number	D1	D	L1	L4 max	L5	LS	SSC	periphery insert	center insert
5538684	TCF620R5SLR40MH	62,00	40	362,2	312,2	2,20	70,00	H	TCF180614HP	TCF210608HC
5538685	TCF630R5SLR40MH	63,00	40	368,2	317,2	2,23	70,00	H	TCF180614HP	TCF210608HC
5538686	TCF640R5SLR40MH	64,00	40	373,3	322,3	2,26	70,00	H	TCF180614HP	TCF210608HC
5538687	TCF650R5SLR40MH	65,00	40	379,3	327,3	2,28	70,00	H	TCF180614HP	TCF210608HC
5538688	TCF660R5SLR40MH	66,00	40	385,3	332,3	2,31	70,00	H	TCF180614HP	TCF210608HC
5538689	TCF670R5SLR40MH	67,00	40	390,3	337,3	2,33	70,00	H	TCF180614HP	TCF210608HC
5538700	TCF680R5SLR40MH	68,00	40	396,4	342,4	2,36	70,00	H	TCF180614HP	TCF210608HC

D	LS
20,00	50
25,00	56
32,00	60
40,00	70

NOTE: SSC = Pocket Seat Reference. To correspond with the SSC on the inserts.
 NOTE: Drilling in stacked plates possible in certain applications. Ask for technical support.
 Drill shipped with insert screws and Torx wrench.
 See pages C97-C104 for inserts.
 SSC = Pocket Seat Reference.
 SLR = Side Lock.

WARNING

During through-hole operations, a slug or disc is produced as the tool breaks through the workpiece. When the drill is stationary and the workpiece is rotating, this slug may be hurled from the chuck by centrifugal force. Provide adequate shielding to protect bystanders.

Top Cut 4 • Center Inserts • Roughing V34

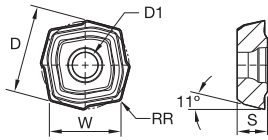

- first choice
- alternate choice

P	●	○
M	●	○
K	●	○
N	○	○
S	○	○
H	○	○

catalogue number	D	D1	W	S	RR	SSC	WU25CH	WU40PH
TCF040203ACV34	4,47	2,10	3,65	2,00	0,300	A	5541817	5541818
TCF060203BCV34	6,00	2,40	4,90	2,40	0,300	B	5542602	5542604
TCF070304CCV34	7,59	2,60	6,20	2,80	0,400	C	5542642	5542643
TCF090305DCV34	9,55	2,80	7,80	3,00	0,500	D	5538554	5538555
TCF120405ECV34	12,00	3,40	9,80	3,60	0,500	E	5538603	5538604
TCF150406FCV34	14,94	4,80	12,20	4,20	0,600	F	5542623	5542624
TCF180508GCV34	17,88	6,00	14,60	5,40	0,800	G	5542475	5542476
TCF210608HCV34	21,68	7,50	17,70	6,50	0,800	H	5542002	5542003

NOTE :For application-specific insert selection, please refer to the application data on page C107.
SSC = Pocket Seat Reference. To correspond with the SSC on the toolholder.

INDEXABLE MILLING

SOLID END MILLING

HOLEMAKING

TAPPING

TURNING

Top Cut 4 • Periphery Inserts • Roughing V34

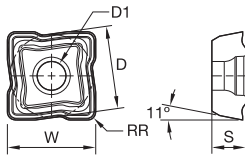

- first choice
- alternate choice

P	<input type="radio"/>	<input type="radio"/>	<input type="radio"/>	<input type="radio"/>
M	<input type="radio"/>	<input type="radio"/>	<input type="radio"/>	<input type="radio"/>
K	<input type="radio"/>	<input type="radio"/>	<input type="radio"/>	<input type="radio"/>
N	<input type="radio"/>	<input type="radio"/>	<input type="radio"/>	<input type="radio"/>
S	<input type="radio"/>	<input type="radio"/>	<input type="radio"/>	<input type="radio"/>
H	<input type="radio"/>	<input type="radio"/>	<input type="radio"/>	<input type="radio"/>

catalogue number	D	D1	W	S	RR	SSC	WPK10CH	WU25CH	WU40PH
TCF040204APV34	4,14	2,10	4,40	2,00	0,400	A	5541843	5541841	5541842
TCF050204BPV34	5,07	2,40	5,40	2,40	0,400	B	5542620	5542608	5542609
TCF070306CPV34	6,67	2,60	7,10	2,80	0,600	C	5542648	5542646	5542647
TCF080308DPV34	8,08	2,80	8,60	3,00	0,800	D	5538600	5538558	5538559
TCF100408EPV34	9,96	3,40	10,60	3,60	0,800	E	5538610	5538608	5538609
TCF120412FPV34	12,59	4,80	13,40	4,20	1,200	F	5542629	5542627	5542628
TCF150512GPV34	15,13	6,00	16,10	5,40	1,200	G	5542601	5542479	5542600
TCF180614HPV34	18,04	7,50	19,20	6,50	1,400	H	5542008	5542006	5542007

NOTE :For application-specific insert selection, please refer to the application data on page C107.
SSC = Pocket Seat Reference. To correspond with the SSC on the toolholder.

INDEXABLE MILLING

SOLID END MILLING

HOLEMAKING

TAPPING

TURNING

Top Cut 4 • Center Inserts • Aluminum V36

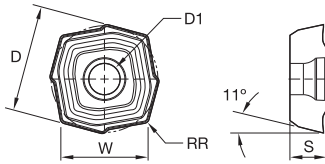

- first choice
- alternate choice

P	Blue	Yellow	White
M	Blue	Yellow	White
K	Red	Green	White
N	Red	Green	White
S	Orange	White	White
H	Grey	White	White

catalogue number	D	D1	W	S	RR	SSC	WN10PH
TCF040203ACV36	4,47	2,10	3,65	2,00	0,300	A	6407887
TCF060203BCV36	6,00	2,40	4,90	2,40	0,300	B	6372041
TCF070304CCV36	7,59	2,60	6,20	2,80	0,400	C	6372042
TCF090305DCV36	9,55	2,80	7,80	3,00	0,500	D	6372045
TCF120405ECV36	12,00	3,40	9,80	3,60	0,500	E	6372047
TCF150406FCV36	14,94	4,80	12,20	4,20	0,600	F	6346757
TCF180508GCV36	17,88	6,00	14,60	5,40	0,800	G	6407890
TCF210608HCV36	21,68	7,50	17,70	6,50	0,800	H	6372049

NOTE: SSC = Pocket Seat Reference. To correspond with the SSC on the toolholder.

INDEXABLE MILLING

SOLID END MILLING

HOLEMAKING

TAPPING

TURNING

Top Cut 4 • Periphery Inserts • Aluminum V36

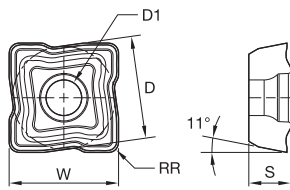

- first choice
- alternate choice

P	■	■
M	■	■
K	■	■
N	■	●
S	■	■
H	■	■

catalogue number	D	D1	W	S	RR	SSC	WN10PH
TCF040204APV36	4,14	2,10	4,40	2,00	0,400	A	6407888
TCF050204BPV36	5,07	2,40	5,40	2,40	0,400	B	6371850
TCF070306CPV36	6,67	2,60	7,10	2,80	0,600	C	6372043
TCF080308DPV36	8,08	2,80	8,60	3,00	0,800	D	6372044
TCF100408EPV36	9,96	3,40	10,60	3,60	0,800	E	6372046
TCF120412FPV36	12,59	4,80	13,40	4,20	1,200	F	6348893
TCF150512GPV36	15,13	6,00	16,10	5,40	1,200	G	6407889
TCF180614HPV36	18,04	7,50	19,20	6,50	1,400	H	6372048

NOTE: SSC = Pocket Seat Reference. To correspond with the SSC on the toolholder.

INDEXABLE MILLING

SOLID END MILLING

HOLEMAKING

TAPPING

TURNING

Top Cut 4 • Center Inserts • Roughing V36

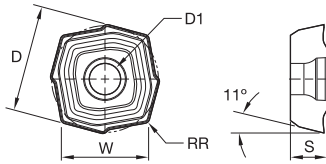

- first choice
- alternate choice

P	Blue	○	●
M	Yellow	○	●
K	Red	○	●
N	Green	○	●
S	Orange	○	●
H	Grey	○	●

catalogue number	D	D1	W	S	RR	SSC	WU25CH	WU40PH
TCF040203ACV36	4,47	2,10	3,65	2,00	0,300	A	5541819	5541840
TCF060203BCV36	6,00	2,40	4,90	2,40	0,300	B	5542606	5542607
TCF070304CCV36	7,59	2,60	6,20	2,80	0,400	C	5542644	5542645
TCF090305DCV36	9,55	2,80	7,80	3,00	0,500	D	5538556	5538557
TCF120405ECV36	12,00	3,40	9,80	3,60	0,500	E	5538606	5538607
TCF150406FCV36	14,94	4,80	12,20	4,20	0,600	F	5542625	5542626
TCF180508GCV36	17,88	6,00	14,60	5,40	0,800	G	5542477	5542478
TCF210608HCV36	21,68	7,50	17,70	6,50	0,800	H	5542004	5542005

NOTE :For application-specific insert selection, please refer to the application data on page C107.
SSC = Pocket Seat Reference. To correspond with the SSC on the toolholder.

INDEXABLE MILLING

SOLID END MILLING

HOLEMAKING

TAPPING

TURNING

Top Cut 4 • Periphery Inserts • Roughing V36

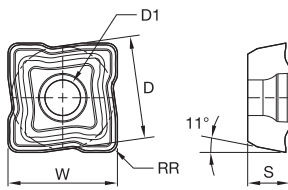

- first choice
- alternate choice

P	●	○
M	●	○
K	●	○
N	○	○
S	○	○
H	○	○

catalogue number	D	D1	W	S	RR	SSC	WU25CH	WU40PH
TCF040204APV36	4,14	2,10	4,40	2,00	0,400	A	5541844	5541845
TCF050204BPV36	5,07	2,40	5,40	2,40	0,400	B	5542621	5542622
TCF070306CPV36	6,67	2,60	7,10	2,80	0,600	C	5542649	5542650
TCF080308DPV36	8,08	2,80	8,60	3,00	0,800	D	5538601	5538602
TCF100408EPV36	9,96	3,40	10,60	3,60	0,800	E	5538611	5538612
TCF120412FPV36	12,59	4,80	13,40	4,20	1,200	F	5542640	5542641
TCF150512GPV36	15,13	6,00	16,10	5,40	1,200	G	5542603	5542605
TCF180614HPV36	18,04	7,50	19,20	6,50	1,400	H	5542009	5542020

NOTE :For application-specific insert selection, please refer to the application data on page C107.
SSC = Pocket Seat Reference. To correspond with the SSC on the toolholder.

INDEXABLE MILLING

SOLID END MILLING

HOLEMAKING

TAPPING

TURNING

Top Cut 4 • Center Inserts • Long Chip Materials V38

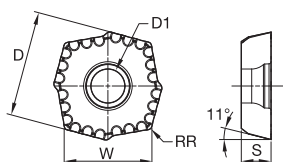

- first choice
- alternate choice

P	●
M	○
K	○
N	○
S	○
H	○

catalogue number	D	D1	W	S	RR	SSC	WU40PH
TCF040203ACV38	4,47	2,10	3,65	2,00	0,300	A	6429458
TCF060203BCV38	6,00	2,40	4,90	2,40	0,300	B	6429459
TCF070304CCV38	7,59	2,60	6,20	2,80	0,400	C	6429460
TCF090305DCV38	9,55	2,80	7,80	3,00	0,500	D	6429461
TCF120405ECV38	12,00	3,40	9,80	3,60	0,500	E	6429462
TCF150406FCV38	14,94	4,80	12,20	4,20	0,600	F	6429463
TCF180508GCV38	17,88	6,00	14,60	5,40	0,800	G	6324383
TCF210608HCV38	21,68	7,50	17,70	6,50	0,800	H	6429464

NOTE: SSC = Pocket Seat Reference. To correspond with the SSC on the toolholder.

Top Cut 4 • Periphery Inserts • Long Chip Materials V38

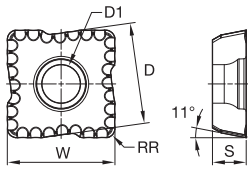

- first choice
- alternate choice

P	●	●
M	●	●
K	○	○
N	○	○
S	○	○
H	○	○

catalogue number	D	D1	W	S	RR	SSC	WUJ25CH	WU40PH
TCF040204APV38	4,14	2,10	4,40	2,00	0,400	A	6429424	6429425
TCF050204BPV38	5,07	2,40	5,40	2,40	0,400	B	6429426	6429427
TCF070306CPV38	6,67	2,60	7,10	2,80	0,600	C	6429466	6429428
TCF080308DPV38	8,08	2,80	8,60	3,00	0,800	D	6429429	6429430
TCF100408EPV38	9,96	3,40	10,60	3,60	0,800	E	6429451	6429452
TCF120412FPV38	12,59	4,80	13,40	4,20	1,200	F	6429453	6429454
TCF150512GPV38	15,13	6,00	16,10	5,40	1,200	G	6429455	6324381
TCF180614HPV38	18,04	7,50	19,20	6,50	1,400	H	6429456	6429457

NOTE: SSC = Pocket Seat Reference. To correspond with the SSC on the toolholder.

INDEXABLE MILLING

SOLID END MILLING

HOLEMAKING

TAPPING

TURNING

Top Cut 4 • Center Inserts • Universal DU

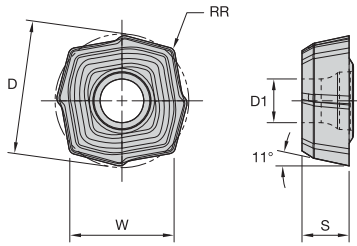

- first choice
- alternate choice

P	●
M	●
K	●
N	●
S	●
H	●

catalogue number	D	D1	W	S	RR	SSC	WU20PH
TCF070304CCDU	7,59	2,60	6,20	2,80	0,400	C	6858590
TCF090305DCDU	9,55	2,80	7,80	3,00	0,500	D	6858611
TCF120405ECDU	12,00	3,40	9,80	3,60	0,500	E	6858612
TCF150406FCDU	14,94	4,80	12,20	4,20	0,600	F	6858613

NOTE :For application-specific insert selection, please refer to the application data on page C107.
 SSC = Pocket Seat Reference. To correspond with the SSC on the toolholder.

INDEXABLE MILLING

SOLID END MILLING

HOLEMAKING

TAPPING

TURNING

INDEXABLE MILLING

SOLID END MILLING

HOLEMAKING

TAPPING

TURNING

Top Cut 4 • Periphery Inserts • Universal DU

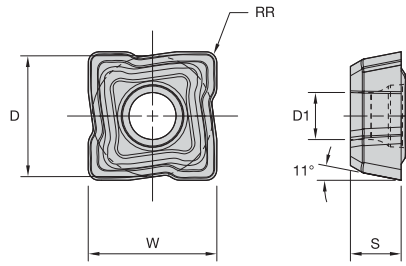

- first choice
- alternate choice

P	●
M	●
K	●
N	●
S	●
H	●

catalogue number	D	D1	W	S	RR	SSC	WU20PH
TCF070306CPDU	6,67	2,60	7,10	2,80	0,600	C	6856586
TCF080308DPDU	8,08	2,80	8,60	3,00	0,800	D	6856587
TCF100408EPDU	9,96	3,40	10,60	3,60	0,800	E	6856588
TCF120412FPDU	12,59	4,80	13,40	4,20	1,200	F	6856589

NOTE :For application-specific insert selection, please refer to the application data on page C107.
 SSC = Pocket Seat Reference. To correspond with the SSC on the toolholder.

Top Cut 4 • Insert Selection Guide

Material Group	Geometry	Light Machining		General Purpose		Heavy Machining	
		periphery insert	center insert	periphery insert	center insert	periphery insert	center insert
P1	V38/DU	WU25CH	WU40PH/WU20PH	WU40PH/WU20PH	WU40PH/WU20PH	WU40PH/WU20PH	WU40PH/WU20PH
P2-P4	V34/DU	WPK10CH	WU40PH/WU20PH	WU25CH/WU20PH	WU40PH/WU20PH	WU40PH/WU20PH	WU40PH/WU20PH
P5-P6	V36/DU	WU25CH	WU40PH/WU20PH	WU40PH/WU20PH	WU40PH/WU20PH	WU40PH/WU20PH	WU40PH/WU20PH
M1-M3	V36/DU	WU25CH	WU40PH/WU20PH	WU40PH/WU20PH	WU40PH/WU20PH	WU40PH/WU20PH	WU40PH/WU20PH
K1-K3	V34/DU	WPK10CH	WU40PH/WU20PH	WU40PH/WU20PH	WU40PH/WU20PH	WU40PH/WU20PH	WU40PH/WU20PH
N1-N4	V36	WN10PH	WN10PH	WN10PH	WN10PH	WN10PH	WN10PH
S1-S4	V38/DU	WU40PH/WU20PH	WU40PH/WU20PH	WU40PH/WU20PH	WU40PH/WU20PH	WU40PH/WU20PH	WU40PH/WU20PH

NOTE: All speed conditions are for stable conditions. For unstable conditions, it is suggested to reduce starting speeds by 10%. For interrupted cuts, reduce speed by 20%.
 For 4 x D, it is highly recommended to start with feed and speed values reduced by 10% less than above data.
 For 5 x D, diameter range 12–23,99mm (insert sizes A to C), it is highly recommended to start with feed and speed values reduced by 20% less than above data.
 For 5 x D, diameter range 25–68mm (inserts sizes D to H), it is highly recommended to start with feed and speed values reduced by 15% less than above data.
 For 4 x D and 5 x D, it is recommended to reduce feed rate during entry and exit by 30–50%.

INDEXABLE MILLING

SOLID END MILLING

HOLEMAKING

TAPPING

TURNING

Top Cut 4 • Cutting Data • Metric

Material Group	Geometry	Grade		Cutting Speed – vc m/min			Recommended Feed Rate per Revolution				
		centre	periphery	min	Start	max	Tool Diameter	12,00–13,99	14,00–18,99	19,00–23,99	24,00–29,99
								Insert Size A	Insert Size B	Insert Size C	Insert Size D
P0	-V38	WU40PH	WU25CH	120	180	260	mm/rev	0,06–0,08	0,08–0,11	0,10–0,13	0,11–0,14
	-DU	WU20PH	WU20PH	90	150	200	mm/rev	–	–	0,07–0,10	0,08–0,10
P1	-V38	WU40PH	WU25CH	120	180	260	mm/rev	0,06–0,10	0,08–0,13	0,10–0,15	0,11–0,16
	-DU	WU20PH	WU20PH	90	150	200	mm/rev	–	–	0,07–0,11	0,08–0,11
P2	-V34	WU40PH	WU25CH	120	190	280	mm/rev	0,06–0,10	0,08–0,15	0,10–0,16	0,11–0,17
	-DU	WU20PH	WU20PH	90	150	220	mm/rev	–	–	0,07–0,12	0,08–0,13
P3	-V34	WU40PH	WPK10CH	120	200	310	mm/rev	0,08–0,15	0,10–0,16	0,11–0,18	0,12–0,20
	-DU	WU20PH	WU20PH	90	160	220	mm/rev	–	–	0,08–0,13	0,09–0,15
P4	-V34	WU40PH	WPK10CH	120	190	310	mm/rev	0,08–0,15	0,10–0,16	0,11–0,18	0,12–0,20
	-DU	WU20PH	WU20PH	90	150	220	mm/rev	–	–	0,08–0,13	0,09–0,15
P5	-V36	WU40PH	WU25CH	120	180	250	mm/rev	0,06–0,10	0,08–0,14	0,10–0,15	0,11–0,16
	-DU	WU20PH	WU20PH	90	150	220	mm/rev	–	–	0,07–0,11	0,08–0,12
P6	-V36	WU40PH	WU25CH	120	160	210	mm/rev	0,06–0,10	0,08–0,14	0,10–0,15	0,11–0,16
	-DU	WU20PH	WU20PH	90	130	165	mm/rev	–	–	0,07–0,11	0,08–0,12
M1	-V38	WU40PH	WU40PH	120	160	240	mm/rev	0,06–0,11	0,07–0,11	0,08–0,12	0,10–0,14
	-DU	WU20PH	WU20PH	90	130	190	mm/rev	–	–	0,06–0,09	0,07–0,10
M2	-V38	WU40PH	WU40PH	110	140	210	mm/rev	0,06–0,10	0,07–0,11	0,08–0,12	0,10–0,14
	-DU	WU20PH	WU20PH	110	140	190	mm/rev	–	–	0,06–0,09	0,07–0,10
M3	-V36	WU40PH	WU40PH	100	120	200	mm/rev	0,06–0,10	0,07–0,11	0,08–0,12	0,10–0,14
	-DU	WU20PH	WU20PH	80	100	160	mm/rev	–	–	0,06–0,09	0,07–0,10
K1	-V34	WU25CH	WPK10CH	120	200	280	mm/rev	0,08–0,14	0,08–0,16	0,10–0,18	0,12–0,24
	-DU	WU20PH	WU20PH	90	160	220	mm/rev	–	–	0,07–0,13	0,09–0,18
K2	-V34	WU40PH	WPK10CH	100	180	260	mm/rev	0,08–0,14	0,08–0,16	0,10–0,18	0,12–0,24
	-DU	WU20PH	WU20PH	80	140	200	mm/rev	–	–	0,07–0,13	0,09–0,18
K3	-V34	WU40PH	WPK10CH	100	170	240	mm/rev	0,08–0,14	0,08–0,16	0,10–0,18	0,12–0,24
	-DU	WU20PH	WU20PH	80	140	190	mm/rev	–	–	0,07–0,13	0,09–0,18
N1	-V36	WN10PH	WN10PH	250	350	500	mm/rev	0,06–0,10	0,08–0,14	0,10–0,15	0,11–0,16
	-V36	WN10PH	WN10PH	150	300	450	mm/rev	0,06–0,10	0,08–0,14	0,10–0,15	0,11–0,16
N3	-V36	WN10PH	WN10PH	80	120	150	mm/rev	0,06–0,10	0,07–0,11	0,08–0,12	0,10–0,14
	-V38	WU40PH	WU40PH	20	30	45	mm/rev	0,08–0,12	0,08–0,13	0,10–0,15	0,12–0,19
S3	-DU	WU20PH	WU20PH	20	30	40	mm/rev	–	–	0,07–0,11	0,09–0,14
	-V38	WU40PH	WU40PH	35	40	65	mm/rev	0,08–0,12	0,08–0,13	0,10–0,15	0,12–0,19
S4	-DU	WU20PH	WU20PH	30	40	60	mm/rev	–	–	0,07–0,11	0,09–0,14

Material Group	Geometry	Grade		Cutting Speed – vc m/min			Tool Diameter	30,00–36,99	37,00–45,99	46,00–56,99	57,00–68,00
		centre	periphery	min	Start	max		Insert Size E	Insert Size F	Insert Size G	Insert Size H
								Insert Size E	Insert Size F	Insert Size G	Insert Size H
P0	-V38	WU40PH	WU25CH	120	180	260	mm/rev	0,13–0,16	0,15–0,18	0,16–0,23	0,17–0,24
	-DU	WU20PH	WU20PH	90	140	200	mm/rev	0,09–0,12	0,11–0,13	–	–
P1	-V38	WU40PH	WU25CH	120	180	260	mm/rev	0,13–0,17	0,15–0,19	0,16–0,24	0,17–0,25
	-DU	WU20PH	WU20PH	90	140	200	mm/rev	0,09–0,13	0,11–0,14	–	–
P2	-V34	WU40PH	WU25CH	120	190	280	mm/rev	0,13–0,20	0,15–0,21	0,16–0,28	0,17–0,30
	-DU	WU20PH	WU20PH	90	150	220	mm/rev	0,09–0,15	0,11–0,15	–	–
P3	-V34	WU40PH	WPK10CH	120	200	310	mm/rev	0,16–0,24	0,16–0,24	0,18–0,30	0,19–0,32
	-DU	WU20PH	WU20PH	90	160	250	mm/rev	0,12–0,16	0,12–0,18	–	–
P4	-V34	WU40PH	WPK10CH	120	190	310	mm/rev	0,14–0,22	0,16–0,24	0,18–0,30	0,19–0,32
	-DU	WU20PH	WU20PH	90	150	250	mm/rev	0,12–0,16	0,12–0,18	–	–
P5	-V36	WU40PH	WU25CH	120	180	250	mm/rev	0,13–0,18	0,15–0,20	0,16–0,28	0,17–0,30
	-DU	WU20PH	WU20PH	90	140	200	mm/rev	0,09–0,13	0,11–0,15	–	–
P6	-V36	WU40PH	WU25CH	120	160	210	mm/rev	0,13–0,18	0,15–0,20	0,16–0,28	0,17–0,29
	-DU	WU20PH	WU20PH	90	120	160	mm/rev	0,09–0,13	0,11–0,15	–	–
M1	-V38	WU40PH	WU40PH	120	160	240	mm/rev	0,12–0,17	0,14–0,21	0,16–0,23	0,16–0,24
	-DU	WU20PH	WU20PH	90	120	190	mm/rev	0,09–0,13	0,10–0,15	–	–
M2	-V38	WU40PH	WU40PH	110	140	210	mm/rev	0,12–0,17	0,14–0,21	0,16–0,23	0,16–0,24
	-DU	WU20PH	WU20PH	90	110	160	mm/rev	0,09–0,13	0,10–0,15	–	–
M3	-V36	WU40PH	WU40PH	100	120	200	mm/rev	0,12–0,17	0,14–0,21	0,16–0,23	0,16–0,24
	-DU	WU20PH	WU20PH	80	90	160	mm/rev	0,09–0,13	0,10–0,15	–	–
K1	-V34	WU25CH	WPK10CH	120	200	280	mm/rev	0,14–0,26	0,16–0,30	0,18–0,32	0,20–0,36
	-DU	WU20PH	WU20PH	90	160	220	mm/rev	0,10–0,19	0,12–0,22	–	–
K2	-V34	WU40PH	WPK10CH	100	180	260	mm/rev	0,14–0,26	0,16–0,30	0,18–0,32	0,20–0,36
	-DU	WU20PH	WU20PH	80	140	200	mm/rev	0,10–0,19	0,12–0,22	–	–
K3	-V34	WU40PH	WPK10CH	100	170	240	mm/rev	0,14–0,26	0,16–0,30	0,18–0,32	0,20–0,36
	-DU	WU20PH	WU20PH	80	130	190	mm/rev	0,10–0,19	0,12–0,22	–	–
N1	-V36	WN10PH	WN10PH	250	350	500	mm/rev	0,13–0,18	0,15–0,20	0,16–0,28	0,17–0,30
	-V36	WN10PH	WN10PH	150	300	450	mm/rev	0,13–0,18	0,15–0,20	0,16–0,28	0,17–0,30
N3	-V36	WN10PH	WN10PH	80	120	150	mm/rev	0,12–0,17	0,14–0,21	0,16–0,23	0,16–0,24
	-V38	WU40PH	WU40PH	20	30	45	mm/rev	0,14–0,21	0,16–0,24	0,18–0,26	0,20–0,30
S3	-DU	WU20PH	WU20PH	20	25	40	mm/rev	0,10–0,15	0,12–0,18	–	–
	-V38	WU40PH	WU40PH	35	40	65	mm/rev	0,14–0,21	0,16–0,24	0,18–0,26	0,20–0,30
S4	-DU	WU20PH	WU20PH	30	35	50	mm/rev	0,10–0,15	0,12–0,18	–	–

NOTE: All speed conditions are for stable conditions. For unstable conditions, it is suggested to reduce starting speeds by 10%. For interrupted cuts, reduce speed by 20%.
 For 4 x D, it is highly recommended to start with feed and speed values reduced by 10% less than above data.
 For 5 x D, diameter range 12–23,99mm (insert sizes A to C), it is highly recommended to start with feed and speed values reduced by 20% less than above data.
 For 5 x D, diameter range 25–68mm (inserts sizes D to H), it is highly recommended to start with feed and speed values reduced by 15% less than above data.
 For 4 x D and 5 x D, it is recommended to reduce feed rate during entry and exit by 30–50%.

Top Cut 4 • Drill Depth • X-Offset Capabilities • Hole Tolerance

Insert size	Diameter Range (mm)	2 x D and 3 x D		4 x D		5 x D	
		X-offset value max. in mm	D1 max value	X-offset value max. in mm	D1 max value	X-offset value max.	D1 max value
A	12,00–13,99	0,5	D1 + 1mm	0,5	D1 + 1mm	—	—
B	14,00–18,99	0,5	D1 + 1mm	0,5	D1 + 1mm	—	—
C	19,00–23,99	0,5	D1 + 1mm	0,5	D1 + 1mm	—	—
D	24,00–29,99	0,8	D1 + 1,6mm	0,8	D1 + 1mm	—	—
E	30,00–36,99	0,8	D1 + 1,6mm	0,8	D1 + 1mm	—	—
F	37,00–45,99	0,8	D1 + 1,6mm	0,8	D1 + 1mm	—	—
G	46,00–56,99	1	D1 + 2mm	0,8	D1 + 1mm	—	—
H	57,00–68,00	1	D1 + 2mm	0,8	D1 + 1mm	—	—

NOTE: All speed conditions are for stable conditions. For unstable conditions, it is suggested to reduce starting speeds by 10%. For interrupted cuts, reduce speed by 20%.

For 4 x D, it is highly recommended to start with feed and speed values reduced by 10% less than above data.

For 5 x D, diameter range .473–.938" (insert sizes A to C), it is highly recommended to start with feed and speed values reduced by 20% less than above data.

For 5 x D, diameter range .969–2.5" (inserts sizes D to H), it is highly recommended to start with feed and speed values reduced by 15% less than above data.

For 4 x D and 5 x D, it is recommended to reduce feed rate during entry and exit by 30–50%.

Top Cut 4 • Screw Torque

Insert size	periphery insert	center insert	Torx size	tightening torque Nm
A	TCF040204AP	TCF040203AC	T5	0,40
B	TCF050204BP	TCF060203BC	T6	0,53
C	TCF070306CP	TCF070304CC	T7	0,90
D	TCF080308DP	TCF090305DC	T8	1,10
E	TCF100408EP	TCF120405EC	T9	2,00
F	TCF120412FP	TCF150406FC	T15	4,00
G	TCF150512GP	TCF180508GC	T20	6,30
H	TCF180614HP	TCF210608HC	T25	8,80

Application Data • Top Cut 4

Top Cut 4 • Drill Depth • 2 x D/3 x D • Hole Tolerance Table

Insert size	Diameter Range (mm)	Hole Tolerance (mm)
A	12,00–13,99	+/- 0,20
B	14,00–18,99	+/- 0,20
C	19,00–23,99	+/- 0,20
D	24,00–29,99	+/- 0,20
E	30,00–36,99	+/- 0,20
F	37,00–45,99	+/- 0,25
G	46,00–56,99	+/- 0,25
H	57,00–68,00	+/- 0,28

Top Cut 4 • Drill Depth • 4 x D/5 x D • Hole Tolerance Table

Insert size	Diameter Range (mm)	Hole Tolerance (mm)
A	12,00–13,99	+/- 0,35
B	14,00–18,99	+/- 0,35
C	19,00–23,99	+/- 0,35
D	24,00–29,99	+/- 0,35
E	30,00–36,99	+/- 0,35
F	37,00–45,99	+/- 0,38
G	46,00–56,99	+/- 0,38
H	57,00–68,00	+/- 0,42

Coolant Requirement/Recommendation

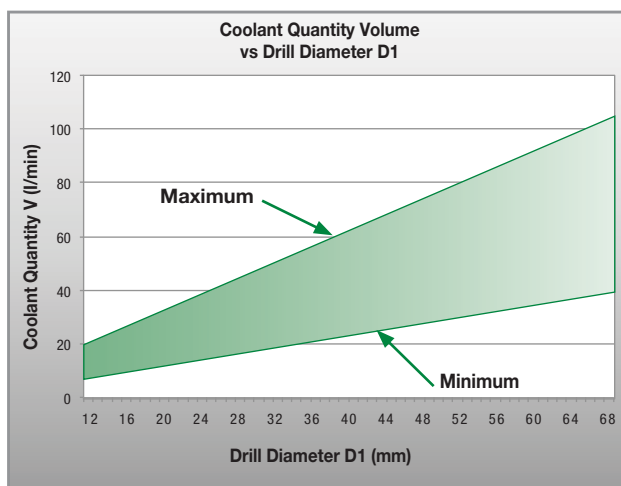



Reamers

Solid Carbide Reamers – HSR™

HSR™ Reaming Tools combine micrograin substrates, specific coatings, and unequal flutes for highly consistent machining results.

Lapped ground leads for high-speed cutting
Long tool life with increased hole and surface quality

Unequal flute design
Decreased runout and improved straightness

Radial coolant supply for through hole applications and axial coolant supply for blind holes to achieve higher feed rates

Micro-fine grain substrate
Superior wear resistance leading to longer tool life and hole consistency

Improve machining reliability with HSR leads and lapped grinding surface of rake, clearance, and relief angle.



GRADES

K10F



Micro-fine grain carbide, uncoated grade

K10F-DCFD



PVD TiAlN coated fine grain carbide

RELIABLE PERFORMANCE

PRODUCT

Lapped ground leads for high-speed cutting and long tool life with increased hole and surface quality

DIAMETER RANGE

1,4–32mm

INDUSTRY



MATERIALS



APPLICATIONS



REAMING:
THROUGH
HOLE



REAMING:
BLIND
HOLE



REAMING:
THROUGH &
CROSS
HOLES



REAMING:
BLIND &
CROSS
HOLES



THROUGH
COOLANT:
RADIAL:
REAMING



FLOOD
COOLANT:
REAMING



THROUGH
COOLANT:
AXIAL:
REAMING

DIAMETER RANGE

HSR™ Reamers with Helical Flutes for Through Holes

1,4–10mm

HSR Reamers with Helical Flutes for Through Holes

2–14mm

HSR Tipped Reamers with Helical Flutes for Through Holes

14–32mm

HSR Reamers with Straight Flutes for Blind Holes

2–4mm

HSR Reamers with Straight Flutes for Blind Holes

5–14mm

HSR Tipped Reamers with Straight Flutes for Blind Holes

14–32mm

SHANKS

Round cylindrical



Grades and Grade Descriptions

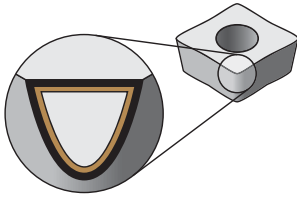

Coatings provide high-speed capability and are engineered for finishing to heavy roughing.

P	Steel
M	Stainless Steel
K	Cast Iron
N	Non-Ferrous
S	High-Temp Alloys
H	Hardened Materials

wear resistance ← → toughness

Coating	Grade Description		05	10	15	20	25	30	35	40	45
WU05PR	<p>Composition: Submicron grain-size tungsten carbide with PVD AlCrN coating for excellent edge retention and wear resistance.</p> <p>Application: For use in steel, cast iron, stainless steel, and super alloys.</p>	P									
		M									
		K									
		S									
K10F	<p>Composition: This uncoated fine-grain carbide with high hardness offers excellent abrasive wear resistance paired with excellent toughness for fine-finishing applications.</p> <p>Application: First choice for precision reaming of non-ferrous materials.</p>	P									
		M									
		N									
		S									
K10F-DCFD	<p>Composition: With a PVD TiAlN coating and a fine-grain carbide substrate, this grade offers excellent wear resistance paired with excellent toughness for medium-speed fine-finishing applications.</p> <p>Application: First choice for precision reaming of steels, stainless steel, and cast irons.</p>	P									
		M									
		K									
		S									

HSR™ Reamers with Straight Flutes for Blind Holes • K10F™/K10F-DCFD™ • 2–4mm

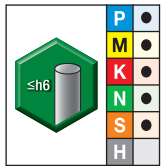
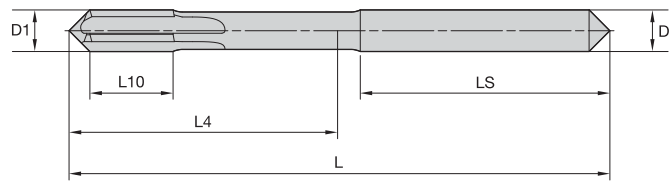

grade K10F
uncoated

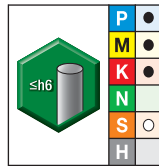

grade K10F-DCFD
TiAlN

● first choice
○ alternate choice

order #	catalogue #	order #	catalogue #	D1	D	L	L4	L10	LS	Z
2446025	050222-000200	2446371	450222-000200	2,00	3,00	48	15	6	28	4
2446029	050222-000300	2446372	450222-000300	3,00	3,00	48	15	8	28	4
2446031	050222-000400	2446415	450222-000400	4,00	4,00	54	21	8	28	4

HSR Reamers with Helical Flutes for Through Holes • K10F™/K10F-DCFD™ • 5–14mm

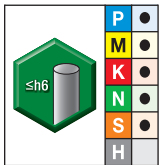
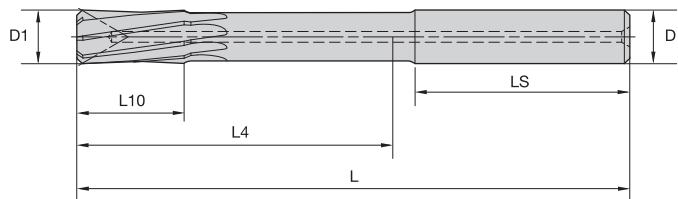

grade K10F
uncoated

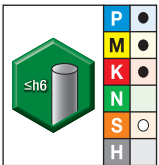

grade K10F-DCFD
TiAlN

● first choice
○ alternate choice

order #	catalogue #	order #	catalogue #	D1	D	L	L4	L10	LS	Z
-	-	2441380	450271-000500	5,00	6,00	74	32	12	36	4
-	-	2441381	450271-000600	6,00	6,00	74	33	12	36	4
-	-	2441453	450271-000800	8,00	8,00	91	50	16	36	6
-	-	2441455	450271-001000	10,00	10,00	103	58	20	40	6
2437432	050271-001200	2441457	450271-001200	12,00	12,00	118	68	24	45	6
-	-	2441494	450271-001400	14,00	14,00	132	81	28	45	6

HSR™ Reamers with Straight Flutes for Blind Holes • K10F™/K10F-DCFD™ • 5–14mm

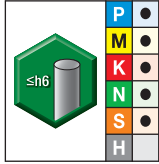
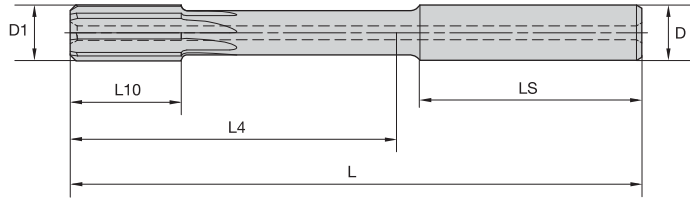

grade K10F
uncoated

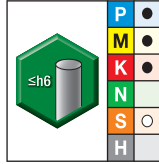

grade K10F-DCFD
TiAlN

● first choice
○ alternate choice

order #	catalogue #	order #	catalogue #	D1	D	L	L4	L10	LS	Z
2437472	050270-000500	2441337	450270-000500	5,00	6,00	74	32	12	36	4
2437523	050270-000600	2441339	450270-000600	6,00	6,00	74	33	12	36	4
2437525	050270-000800	2441341	450270-000800	8,00	8,00	91	50	16	36	6
2437526	050270-001000	2441342	450270-001000	10,00	10,00	103	58	20	40	6
2437527	050270-001200	2441353	450270-001200	12,00	12,00	118	68	24	45	6
2437529	050270-001400	2441354	450270-001400	14,00	14,00	132	81	28	45	6

HSR Reamers with Helical Flutes for Through Holes • K10F™/K10F-DCFD™ • 2–12mm

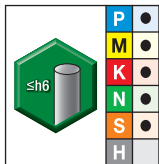
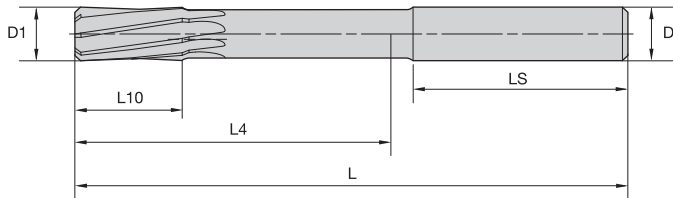

grade K10F
uncoated

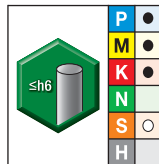

grade K10F-DCFD
TiAlN

● first choice
○ alternate choice

order #	catalogue #	order #	catalogue #	D1	D	L	L4	L10	LS	Z
2436494	050227-000200	2441162	450227-000200	2,00	3,00	48	15	6	28	4
2436871	050227-000300	2441253	450227-000300	3,00	3,00	48	15	6	28	4
-	-	2441254	450227-000400	4,00	4,00	54	21	8	28	4
-	-	2441256	450227-000500	5,00	6,00	74	32	12	36	4
2436914	050227-000600	2441257	450227-000600	6,00	6,00	74	33	12	36	4
2436916	050227-000800	2441260	450227-000800	8,00	8,00	91	50	16	36	6
2436919	050227-001000	2441261	450227-001000	10,00	10,00	103	58	20	40	6
2436922	050227-001200	-	-	12,00	12,00	118	68	24	45	6

GP Reamers for Through Holes • 1,4–10,0mm • Helical Flute • K10 • Uncoated • Cylindrical Shank

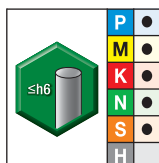
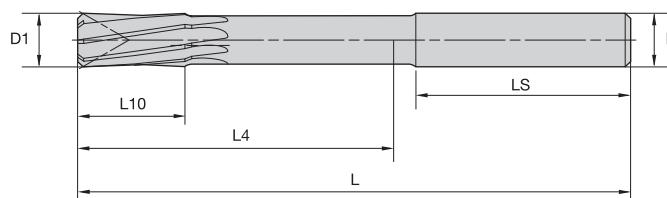

grade K10
uncoated



● first choice

○ alternate choice



order #	catalogue #	D1	D	L	L4	L10	LS	Z
2293637	050221-000015	1,50	1,50	40	18	8	1	3
2293638	050221-000016	1,60	1,60	43	20	9	1	3
2283423	050221-000020	2,00	2,00	49	24	11	1	4
2283424	050221-000022	2,20	2,20	53	26	12	1	4
2283426	050221-000025	2,50	2,50	57	28	14	1	4
2283427	050221-000028	2,80	2,80	61	32	15	1	4
2283428	050221-000030	3,00	3,00	61	32	15	1	6
2283429	050221-000032	3,20	3,20	65	35	16	1	6
2283430	050221-000035	3,50	3,50	70	40	18	1	6
2283431	050221-000040	4,00	4,00	75	41	19	1	6
2293640	050221-000045	4,50	4,50	80	44	21	1	6
2283445	050221-000050	5,00	5,00	86	51	23	1	6
2293642	050221-000060	6,00	5,60	93	53	26	1	6
2293644	050221-000070	7,00	7,10	109	69	31	2	6
2283451	050221-000080	8,00	8,00	117	75	33	2	6
2283464	050221-000090	9,00	9,00	125	81	36	2	6
2283465	050221-000095	9,50	9,00	125	81	36	2	6
2283466	050221-000100	10,00	10,00	133	87	38	2	6

mm	Reaming Allowances in Diameter		
	min	mid	max
1,40–4,80	0,08	0,12	0,20
4,81–9,59	0,10	0,15	0,25
9,60–15,00	0,15	0,20	0,30
15,00–20,00	0,15	0,25	0,35
20,00–50,00	0,20	0,30	0,40



Application Data • Series 050222 • HP Reamers for Blind Holes

							
Material Group		Cutting Speed – vc Range – m/min			Recommended Feed Rate per Rev		
		min		max	Tool Diameter	1,40–3,15	3,16–4,80
P	1	30	–	40	mm/r	0,20–0,30	0,20–0,40
	2	30	–	40	mm/r	0,20–0,30	0,20–0,40
	3	30	–	30	mm/r	0,20–0,30	0,20–0,40
	4	20	–	30	mm/r	0,20–0,30	0,20–0,40
	5	10	–	20	mm/r	0,20–0,30	0,20–0,40
	6	10	–	20	mm/r	0,15–0,30	0,20–0,30
M	1	10	–	20	mm/r	0,15–0,30	0,20–0,30
	2	10	–	20	mm/r	0,15–0,30	0,20–0,30
	3	10	–	10	mm/r	0,15–0,30	0,20–0,30
K	1	20	–	30	mm/r	0,25–0,45	0,35–0,65
	2	20	–	30	mm/r	0,25–0,45	0,35–0,65
	3	20	–	30	mm/r	0,25–0,45	0,35–0,65
N	1	70	–	90	mm/r	0,25–0,45	0,35–0,65
	2	80	–	100	mm/r	0,25–0,45	0,35–0,65
	3	80	–	100	mm/r	0,25–0,45	0,35–0,65
	4	70	–	90	mm/r	0,25–0,45	0,35–0,65
	5	60	–	80	mm/r	0,25–0,45	0,35–0,65
	6	90	–	110	mm/r	0,25–0,45	0,35–0,65
S	1	10	–	20	mm/r	0,10–0,20	0,15–0,30
	2	10	–	10	mm/r	0,10–0,20	0,15–0,30
	3	20	–	30	mm/r	0,15–0,30	0,20–0,30
	4	20	–	30	mm/r	0,15–0,30	0,20–0,30



Application Data • Series 450222 • HP Reamers for Blind Holes

							
Material Group		Cutting Speed – vc Range – m/min			Recommended Feed Rate per Rev		
		min		max	Tool Diameter	1,40–3,15	3,16–4,80
P	1	60	–	80	mm/r	0,20–0,30	0,20–0,40
	2	60	–	80	mm/r	0,20–0,30	0,20–0,40
	3	50	–	70	mm/r	0,20–0,30	0,20–0,40
	4	40	–	60	mm/r	0,20–0,30	0,20–0,40
	5	20	–	30	mm/r	0,20–0,30	0,20–0,40
	6	20	–	30	mm/r	0,15–0,30	0,20–0,30
M	1	10	–	20	mm/r	0,15–0,30	0,20–0,30
	2	10	–	20	mm/r	0,15–0,30	0,20–0,30
	3	10	–	20	mm/r	0,15–0,30	0,20–0,30
K	1	50	–	70	mm/r	0,25–0,45	0,35–0,65
	2	50	–	70	mm/r	0,25–0,45	0,35–0,65
	3	50	–	70	mm/r	0,25–0,45	0,35–0,65
S	1	10	–	20	mm/r	0,10–0,20	0,15–0,30
	2	10	–	20	mm/r	0,10–0,20	0,15–0,30

Application Data • Series 050271 • HP Reamers for Through Holes

										
		Cutting Speed – vc Range – m/min			Recommended Feed Rate per Rev					
Material Group		min		max	Tool Diameter	3,16–4,80	4,81–7,15	7,16–9,59	9,60–12,70	12,70–15,00
P	1	50	–	70	mm/r	0,20–0,40	0,30–0,50	0,35–0,65	0,40–0,80	0,50–0,90
	2	40	–	60	mm/r	0,20–0,40	0,30–0,50	0,35–0,65	0,40–0,80	0,50–0,90
	3	40	–	60	mm/r	0,20–0,40	0,30–0,50	0,35–0,65	0,40–0,80	0,50–0,90
	4	30	–	40	mm/r	0,20–0,40	0,30–0,50	0,35–0,65	0,40–0,80	0,50–0,90
	5	20	–	30	mm/r	0,20–0,40	0,30–0,50	0,35–0,65	0,40–0,80	0,50–0,90
	6	10	–	20	mm/r	0,20–0,30	0,20–0,40	0,30–0,50	0,30–0,60	0,35–0,65
M	1	10	–	20	mm/r	0,20–0,30	0,20–0,40	0,30–0,50	0,30–0,60	0,35–0,65
	2	10	–	20	mm/r	0,20–0,30	0,20–0,40	0,30–0,50	0,30–0,60	0,35–0,65
	3	10	–	20	mm/r	0,20–0,30	0,20–0,40	0,30–0,50	0,30–0,60	0,35–0,65
K	1	30	–	50	mm/r	0,35–0,65	0,40–0,80	0,50–0,90	0,60–1,05	0,60–1,20
	2	30	–	50	mm/r	0,35–0,65	0,40–0,80	0,50–0,90	0,60–1,05	0,60–1,20
	3	30	–	50	mm/r	0,35–0,65	0,40–0,80	0,50–0,90	0,60–1,05	0,60–1,20
N	1	130	–	150	mm/r	0,35–0,65	0,40–0,80	0,50–0,90	0,60–1,05	0,60–1,20
	2	140	–	160	mm/r	0,35–0,65	0,40–0,80	0,50–0,90	0,60–1,05	0,60–1,20
	3	140	–	160	mm/r	0,35–0,65	0,40–0,80	0,50–0,90	0,60–1,05	0,60–1,20
	4	130	–	150	mm/r	0,35–0,65	0,40–0,80	0,50–0,90	0,60–1,05	0,60–1,20
	5	120	–	140	mm/r	0,35–0,65	0,40–0,80	0,50–0,90	0,60–1,05	0,60–1,20
	6	150	–	170	mm/r	0,35–0,65	0,40–0,80	0,50–0,90	0,60–1,05	0,60–1,20
S	1	10	–	20	mm/r	0,15–0,30	0,20–0,30	0,20–0,40	0,25–0,45	0,30–0,50
	2	10	–	20	mm/r	0,15–0,30	0,20–0,30	0,20–0,40	0,25–0,45	0,30–0,50
	3	30	–	40	mm/r	0,20–0,30	0,20–0,40	0,30–0,50	0,30–0,60	0,35–0,65
	4	30	–	40	mm/r	0,20–0,30	0,20–0,40	0,30–0,50	0,30–0,60	0,35–0,65

Application Data • Series 450271 • HP Reamers for Through Holes

										
		Cutting Speed – vc Range – m/min			Recommended Feed Rate per Rev					
Material Group		min		max	Tool Diameter	3,16–4,80	4,81–7,15	7,16–9,59	9,60–12,70	12,70–15,00
P	1	110	–	130	mm/r	0,20–0,40	0,30–0,50	0,35–0,65	0,40–0,80	0,50–0,90
	2	110	–	130	mm/r	0,20–0,40	0,30–0,50	0,35–0,65	0,40–0,80	0,50–0,90
	3	100	–	120	mm/r	0,20–0,40	0,30–0,50	0,35–0,65	0,40–0,80	0,50–0,90
	4	60	–	80	mm/r	0,20–0,40	0,30–0,50	0,35–0,65	0,40–0,80	0,50–0,90
	5	30	–	50	mm/r	0,20–0,40	0,30–0,50	0,35–0,65	0,40–0,80	0,50–0,90
	6	30	–	40	mm/r	0,20–0,30	0,20–0,40	0,30–0,50	0,30–0,60	0,35–0,65
M	1	30	–	40	mm/r	0,20–0,30	0,20–0,40	0,30–0,50	0,30–0,60	0,35–0,65
	2	30	–	40	mm/r	0,20–0,30	0,20–0,40	0,30–0,50	0,30–0,60	0,35–0,65
	3	20	–	30	mm/r	0,20–0,30	0,20–0,40	0,30–0,50	0,30–0,60	0,35–0,65
K	1	80	–	100	mm/r	0,35–0,65	0,40–0,80	0,50–0,90	0,60–1,05	0,60–1,20
	2	80	–	100	mm/r	0,35–0,65	0,40–0,80	0,50–0,90	0,60–1,05	0,60–1,20
	3	70	–	90	mm/r	0,35–0,65	0,40–0,80	0,50–0,90	0,60–1,05	0,60–1,20
S	1	30	–	40	mm/r	0,15–0,30	0,20–0,30	0,20–0,40	0,25–0,45	0,30–0,50
	2	20	–	30	mm/r	0,15–0,30	0,20–0,30	0,20–0,40	0,25–0,45	0,30–0,50



Application Data • Series 050270 • HP Reamers for Blind Holes

Material Group	Cutting Speed – vc Range – m/min			Recommended Feed Rate per Rev						
	min		max	Tool Diameter	3,16–4,80	4,81–7,15	7,16–9,59	9,60–12,70	12,70–15,00	
				mm/r						
P	1	50	–	70	mm/r	0,20–0,40	0,30–0,50	0,35–0,65	0,40–0,80	0,50–0,90
	2	40	–	60	mm/r	0,20–0,40	0,30–0,50	0,35–0,65	0,40–0,80	0,50–0,90
	3	40	–	60	mm/r	0,20–0,40	0,30–0,50	0,35–0,65	0,40–0,80	0,50–0,90
	4	30	–	40	mm/r	0,20–0,40	0,30–0,50	0,35–0,65	0,40–0,80	0,50–0,90
	5	20	–	30	mm/r	0,20–0,40	0,30–0,50	0,35–0,65	0,40–0,80	0,50–0,90
	6	10	–	20	mm/r	0,20–0,30	0,20–0,40	0,30–0,50	0,30–0,60	0,35–0,65
M	1	10	–	20	mm/r	0,20–0,30	0,20–0,40	0,30–0,50	0,30–0,60	0,35–0,65
	2	10	–	20	mm/r	0,20–0,30	0,20–0,40	0,30–0,50	0,30–0,60	0,35–0,65
	3	10	–	20	mm/r	0,20–0,30	0,20–0,40	0,30–0,50	0,30–0,60	0,35–0,65
K	1	30	–	50	mm/r	0,35–0,65	0,40–0,80	0,50–0,90	0,60–1,05	0,60–1,20
	2	30	–	50	mm/r	0,35–0,65	0,40–0,80	0,50–0,90	0,60–1,05	0,60–1,20
	3	30	–	50	mm/r	0,35–0,65	0,40–0,80	0,50–0,90	0,60–1,05	0,60–1,20
N	1	130	–	150	mm/r	0,35–0,65	0,40–0,80	0,50–0,90	0,60–1,05	0,60–1,20
	2	140	–	160	mm/r	0,35–0,65	0,40–0,80	0,50–0,90	0,60–1,05	0,60–1,20
	3	140	–	160	mm/r	0,35–0,65	0,40–0,80	0,50–0,90	0,60–1,05	0,60–1,20
	4	130	–	150	mm/r	0,35–0,65	0,40–0,80	0,50–0,90	0,60–1,05	0,60–1,20
	5	120	–	140	mm/r	0,35–0,65	0,40–0,80	0,50–0,90	0,60–1,05	0,60–1,20
	6	150	–	170	mm/r	0,35–0,65	0,40–0,80	0,50–0,90	0,60–1,05	0,60–1,20
S	1	10	–	20	mm/r	0,15–0,30	0,20–0,30	0,20–0,40	0,25–0,45	0,30–0,50
	2	10	–	20	mm/r	0,15–0,30	0,20–0,30	0,20–0,40	0,25–0,45	0,30–0,50
	3	30	–	40	mm/r	0,20–0,30	0,20–0,40	0,30–0,50	0,30–0,60	0,35–0,65
	4	30	–	40	mm/r	0,20–0,30	0,20–0,40	0,30–0,50	0,30–0,60	0,35–0,65



Application Data • Series 450270 • HP Reamers for Blind Holes

Material Group	Cutting Speed – vc Range – m/min			Recommended Feed Rate per Rev						
	min		max	Tool Diameter	3,16–4,80	4,81–7,15	7,16–9,59	9,60–12,70	12,70–15,00	
				mm/r						
P	1	110	–	130	mm/r	0,20–0,40	0,30–0,50	0,35–0,65	0,40–0,80	0,50–0,90
	2	110	–	130	mm/r	0,20–0,40	0,30–0,50	0,35–0,65	0,40–0,80	0,50–0,90
	3	100	–	120	mm/r	0,20–0,40	0,30–0,50	0,35–0,65	0,40–0,80	0,50–0,90
	4	60	–	80	mm/r	0,20–0,40	0,30–0,50	0,35–0,65	0,40–0,80	0,50–0,90
	5	30	–	50	mm/r	0,20–0,40	0,30–0,50	0,35–0,65	0,40–0,80	0,50–0,90
	6	30	–	40	mm/r	0,20–0,30	0,20–0,40	0,30–0,50	0,30–0,60	0,35–0,65
M	1	30	–	40	mm/r	0,20–0,30	0,20–0,40	0,30–0,50	0,30–0,60	0,35–0,65
	2	30	–	40	mm/r	0,20–0,30	0,20–0,40	0,30–0,50	0,30–0,60	0,35–0,65
	3	20	–	30	mm/r	0,20–0,30	0,20–0,40	0,30–0,50	0,30–0,60	0,35–0,65
K	1	80	–	100	mm/r	0,35–0,65	0,40–0,80	0,50–0,90	0,60–1,05	0,60–1,20
	2	80	–	100	mm/r	0,35–0,65	0,40–0,80	0,50–0,90	0,60–1,05	0,60–1,20
	3	70	–	90	mm/r	0,35–0,65	0,40–0,80	0,50–0,90	0,60–1,05	0,60–1,20
S	1	30	–	40	mm/r	0,15–0,30	0,20–0,30	0,20–0,40	0,25–0,45	0,30–0,50
	2	20	–	30	mm/r	0,15–0,30	0,20–0,30	0,20–0,40	0,25–0,45	0,30–0,50



Application Data • Series 050227 • Reamers for Through Holes

											
Material Group		Cutting Speed – vc Range – m/min			Recommended Feed Rate per Rev						
		min		max	Tool Diameter	1,40–3,15	3,16–4,80	4,81–7,15	7,16–9,59	9,60–12,70	12,70–15,00
P	1	30	–	40	mm/r	0,20–0,30	0,20–0,40	0,30–0,50	0,40–0,70	0,40–0,80	0,50–0,90
	2	30	–	40	mm/r	0,20–0,30	0,20–0,40	0,30–0,50	0,40–0,70	0,40–0,80	0,50–0,90
	3	30	–	30	mm/r	0,20–0,30	0,20–0,40	0,30–0,50	0,40–0,70	0,40–0,80	0,50–0,90
	4	20	–	30	mm/r	0,20–0,30	0,20–0,40	0,30–0,50	0,40–0,70	0,40–0,80	0,50–0,90
	5	10	–	20	mm/r	0,20–0,30	0,20–0,40	0,30–0,50	0,40–0,70	0,40–0,80	0,50–0,90
	6	10	–	20	mm/r	0,15–0,30	0,20–0,30	0,20–0,40	0,30–0,50	0,30–0,60	0,35–0,65
M	1	10	–	20	mm/r	0,15–0,30	0,20–0,30	0,20–0,40	0,30–0,50	0,30–0,60	0,35–0,65
	2	10	–	20	mm/r	0,15–0,30	0,20–0,30	0,20–0,40	0,30–0,50	0,30–0,60	0,35–0,65
	3	10	–	10	mm/r	0,15–0,30	0,20–0,30	0,20–0,40	0,30–0,50	0,30–0,60	0,35–0,65
K	1	20	–	30	mm/r	0,25–0,45	0,35–0,65	0,40–0,80	0,50–0,90	0,60–1,05	0,60–1,20
	2	20	–	30	mm/r	0,25–0,45	0,35–0,65	0,40–0,80	0,50–0,90	0,60–1,05	0,60–1,20
	3	20	–	30	mm/r	0,25–0,45	0,35–0,65	0,40–0,80	0,50–0,90	0,60–1,05	0,60–1,20
N	1	70	–	90	mm/r	0,25–0,45	0,35–0,65	0,40–0,80	0,50–0,90	0,60–1,05	0,60–1,20
	2	80	–	100	mm/r	0,25–0,45	0,35–0,65	0,40–0,80	0,50–0,90	0,60–1,05	0,60–1,20
	3	80	–	100	mm/r	0,25–0,45	0,35–0,65	0,40–0,80	0,50–0,90	0,60–1,05	0,60–1,20
	4	70	–	90	mm/r	0,25–0,45	0,35–0,65	0,40–0,80	0,50–0,90	0,60–1,05	0,60–1,20
	5	60	–	80	mm/r	0,25–0,45	0,35–0,65	0,40–0,80	0,50–0,90	0,60–1,05	0,60–1,20
	6	90	–	110	mm/r	0,25–0,45	0,35–0,65	0,40–0,80	0,50–0,90	0,60–1,05	0,60–1,20
S	1	10	–	20	mm/r	0,10–0,20	0,15–0,30	0,20–0,30	0,20–0,40	0,25–0,45	0,30–0,50
	2	10	–	10	mm/r	0,10–0,20	0,15–0,30	0,20–0,30	0,20–0,40	0,25–0,45	0,30–0,50
	3	20	–	30	mm/r	0,15–0,30	0,20–0,30	0,20–0,40	0,30–0,50	0,30–0,60	0,35–0,65
	4	20	–	30	mm/r	0,15–0,30	0,20–0,30	0,20–0,40	0,30–0,50	0,30–0,60	0,35–0,65

Application Data • Series 450227 • Reamers for Through Holes

											
Material Group		Cutting Speed – vc Range – m/min			Recommended Feed Rate per Rev						
		min		max	Tool Diameter	1,40–3,15	3,16–4,80	4,81–7,15	7,16–9,59	9,60–12,70	12,70–15,00
P	1	60	–	80	mm/r	0,20–0,30	0,20–0,40	0,30–0,50	0,40–0,70	0,40–0,80	0,50–0,90
	2	60	–	80	mm/r	0,20–0,30	0,20–0,40	0,30–0,50	0,40–0,70	0,40–0,80	0,50–0,90
	3	60	–	70	mm/r	0,20–0,30	0,20–0,40	0,30–0,50	0,40–0,70	0,40–0,80	0,50–0,90
	4	40	–	60	mm/r	0,20–0,30	0,20–0,40	0,30–0,50	0,40–0,70	0,40–0,80	0,50–0,90
	5	20	–	30	mm/r	0,20–0,30	0,20–0,40	0,30–0,50	0,40–0,70	0,40–0,80	0,50–0,90
	6	20	–	30	mm/r	0,15–0,30	0,20–0,30	0,20–0,40	0,30–0,50	0,30–0,60	0,35–0,65
M	1	10	–	20	mm/r	0,15–0,30	0,20–0,30	0,20–0,40	0,30–0,50	0,30–0,60	0,35–0,65
	2	10	–	20	mm/r	0,15–0,30	0,20–0,30	0,20–0,40	0,30–0,50	0,30–0,60	0,35–0,65
	3	10	–	20	mm/r	0,15–0,30	0,20–0,30	0,20–0,40	0,30–0,50	0,30–0,60	0,35–0,65
K	1	50	–	70	mm/r	0,25–0,45	0,35–0,65	0,40–0,80	0,50–0,90	0,60–1,05	0,60–1,20
	2	50	–	70	mm/r	0,25–0,45	0,35–0,65	0,40–0,80	0,50–0,90	0,60–1,05	0,60–1,20
	3	50	–	70	mm/r	0,25–0,45	0,35–0,65	0,40–0,80	0,50–0,90	0,60–1,05	0,60–1,20
S	1	10	–	20	mm/r	0,10–0,20	0,15–0,30	0,20–0,30	0,20–0,40	0,25–0,45	0,30–0,50
	2	10	–	20	mm/r	0,10–0,20	0,15–0,30	0,20–0,30	0,20–0,40	0,25–0,45	0,30–0,50

Application Data • Series 050221 • GP Reamers for Through Holes

										
		Cutting Speed – vc Range – m/min			Recommended Feed Rate per Rev					
Material Group		min		max	Tool Diameter	1,40–3,15	3,16–4,80	4,81–7,15	7,16–9,59	9,60–12,70
P	1	20	–	30	mm/r	0,07–0,13	0,08–0,16	0,10–0,20	0,13–0,23	0,15–0,25
	2	20	–	20	mm/r	0,07–0,13	0,08–0,16	0,10–0,20	0,13–0,23	0,15–0,25
	3	10	–	20	mm/r	0,07–0,13	0,08–0,16	0,10–0,20	0,13–0,23	0,15–0,25
	4	10	–	10	mm/r	0,07–0,13	0,08–0,16	0,10–0,20	0,13–0,23	0,15–0,25
	5	10	–	10	mm/r	0,07–0,13	0,08–0,16	0,10–0,20	0,13–0,23	0,15–0,25
	6	10	–	10	mm/r	0,06–0,10	0,07–0,13	0,08–0,16	0,10–0,20	0,13–0,23
M	1	10	–	10	mm/r	0,07–0,13	0,08–0,16	0,10–0,20	0,13–0,23	0,15–0,25
	2	10	–	10	mm/r	0,07–0,13	0,08–0,16	0,10–0,20	0,13–0,23	0,15–0,25
	3	10	–	10	mm/r	0,07–0,13	0,08–0,16	0,10–0,20	0,13–0,23	0,15–0,25
K	1	10	–	20	mm/r	0,10–0,20	0,15–0,30	0,20–0,30	0,20–0,40	0,25–0,45
	2	10	–	20	mm/r	0,10–0,20	0,15–0,30	0,20–0,30	0,20–0,40	0,25–0,45
	3	10	–	20	mm/r	0,10–0,20	0,15–0,30	0,20–0,30	0,20–0,40	0,25–0,45
N	1	30	–	30	mm/r	0,10–0,20	0,15–0,30	0,20–0,30	0,20–0,40	0,25–0,45
	2	30	–	40	mm/r	0,10–0,20	0,15–0,30	0,20–0,30	0,20–0,40	0,25–0,45
	3	30	–	40	mm/r	0,10–0,20	0,15–0,30	0,20–0,30	0,20–0,40	0,25–0,45
	4	30	–	30	mm/r	0,10–0,20	0,15–0,30	0,20–0,30	0,20–0,40	0,25–0,45
	5	20	–	30	mm/r	0,10–0,20	0,15–0,30	0,20–0,30	0,20–0,40	0,25–0,45
	6	30	–	40	mm/r	0,10–0,20	0,15–0,30	0,20–0,30	0,20–0,40	0,25–0,45
S	1	10	–	10	mm/r	0,07–0,13	0,08–0,16	0,10–0,20	0,13–0,23	0,15–0,25
	2	10	–	10	mm/r	0,07–0,13	0,08–0,16	0,10–0,20	0,13–0,23	0,15–0,25
	3	10	–	20	mm/r	0,07–0,13	0,08–0,16	0,10–0,20	0,13–0,23	0,15–0,25
	4	10	–	20	mm/r	0,07–0,13	0,08–0,16	0,10–0,20	0,13–0,23	0,15–0,25

INDEXABLE MILLING

SOLID END MILLING

HOLEMAKING

TAPPING

TURNING

Pre-Drill Recommendations for Reamers • HSR™, TRF™, and TRM™

Pre-Drill

Leave stock for reamer.

0,2mm (.0079") to 0,4mm (.0156") in diameter.

Run-Out

Runout and angularity are critical.

If possible, use an adjustable holder.

Recommended runout and angularity is 3–5 microns (.00001–.00002").

Material	Ø, mm					
	1–3	3–5	5.1–10	10.1–20	20.1–30	>30
P1	0,1–0,2	0,1–0,2	0,2	0,2–0,3	0,3–0,4	0,4–0,45
P2	0,1–0,2	0,1–0,2	0,2	0,2	0,3	0,3–0,4
P3	0,1–0,2	0,1–0,2	0,2	0,2	0,3	0,3–0,4
P4	0,1–0,2	0,1–0,2	0,2	0,2–0,3	0,3–0,4	0,4–0,5
P5	0,1–0,2	0,1–0,2	0,2	0,2	0,3	0,3–0,4
M1	0,1–0,2	0,1–0,2	0,2	0,2	0,3	0,3–0,4
M2	0,1–0,2	0,1–0,2	0,2	0,2	0,3	0,3–0,4
M3	0,1–0,2	0,1–0,2	0,2	0,2	0,3	0,3–0,4
K1	0,1–0,2	0,1–0,2	0,2	0,3	0,3	0,5
K2	0,1–0,2	0,1–0,2	0,2	0,2–0,3	0,3–0,4	0,4–0,5
K3	0,1–0,2	0,1–0,2	0,2	0,3	0,4	0,5
K4	0,1–0,2	0,1–0,2	0,2	0,3	0,4	0,5
K5	0,1–0,2	0,1–0,2	0,2	0,3	0,4	0,5
N1	0,1–0,2	0,1–0,2	0,2–0,3	0,3–0,4	0,4–0,5	0,5
N2	0,1–0,2	0,1–0,2	0,2–0,3	0,3–0,4	0,4–0,5	0,5
N3	0,1–0,2	0,1–0,2	0,2–0,3	0,2–0,3	0,3	0,5
N4	0,1–0,2	0,1–0,2	0,2–0,3	0,2–0,3	0,3	0,3–0,4
S1	0,1–0,2	0,1–0,2	0,2	0,2–0,3	0,3–0,4	0,4–0,5
S2	0,1–0,2	0,1–0,2	0,2	0,2	0,3	0,3–0,4
S3	0,1–0,2	0,1–0,2	0,2	0,2	0,3	0,3–0,4
S4	0,1–0,2	0,1–0,2	0,2	0,2–0,3	0,3–0,4	0,3–0,4
S5	0,1–0,2	0,1–0,2	0,2	0,2–0,3	0,3–0,4	0,3–0,4
S6	0,1–0,2	0,1–0,2	0,2	0,2–0,3	0,3–0,4	0,3–0,4
H1	0,1–0,2	0,1–0,2	0,2	0,2	0,3	0,25–0,35
H2	0,1–0,2	0,1–0,2	0,2	0,2	0,3	0,25–0,35
H3	0,1–0,2	0,1–0,2	0,2	0,2	0,3	0,25–0,35
H4	0,1–0,2	0,1–0,2	0,2	0,2	0,3	0,25–0,35

Reamers • TRM™ and TRF™

Disc-Style Reamers

TRM and TRF Reaming Tools combine sub-micron grain substrates and the latest AlCrN PVD coatings, which provide high wear resistance even at elevated speeds and consistency.

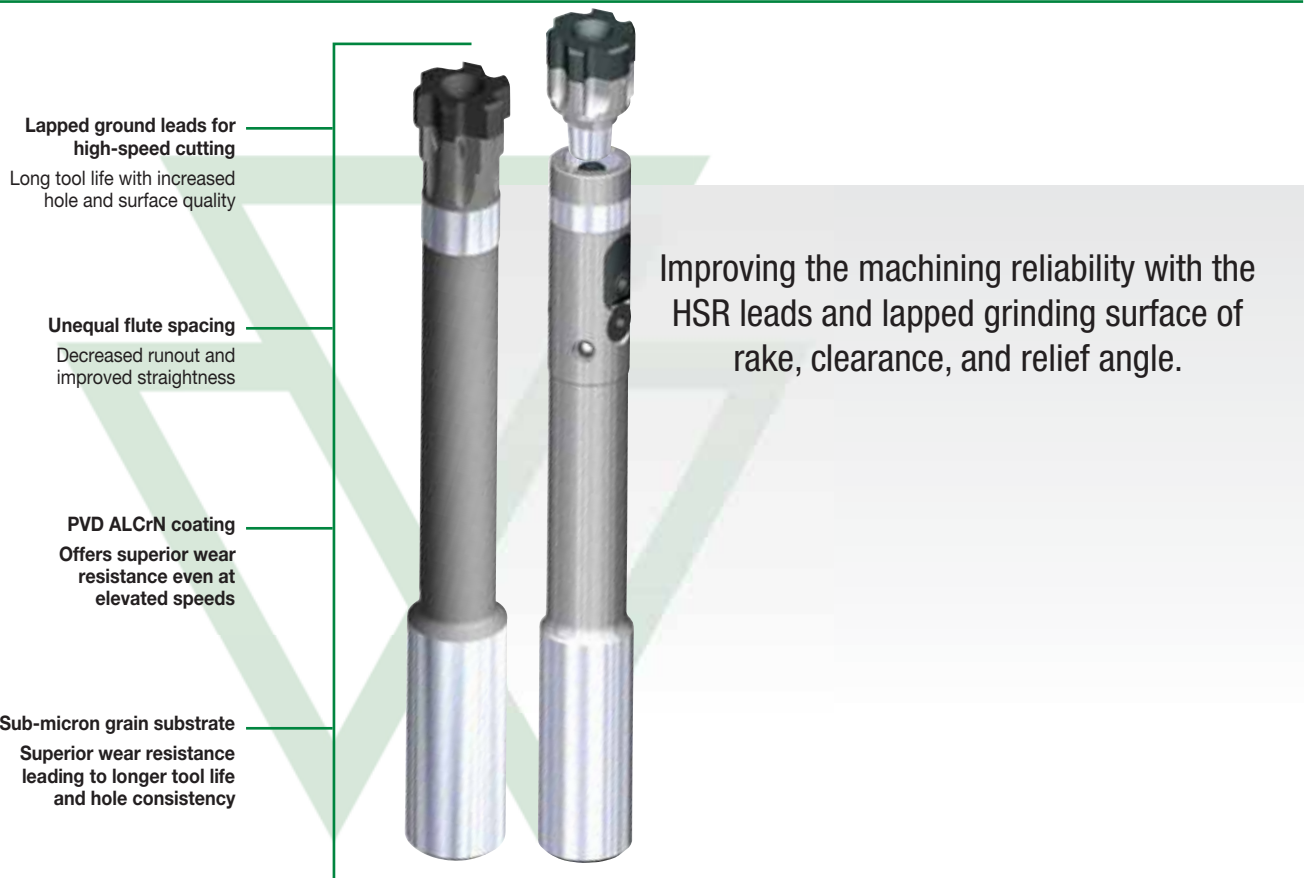

GRADE

WU05PR



Sub-micron fine-grain carbide, coated with PVD AlCrN.
Provides superior edge retention and wear resistance.

RELIABLE, CONSISTENT QUALITY AND PERFORMANCE

PRODUCT

Lapped ground leads for high-speed cutting and long tool life with increased hole and surface quality

DIAMETER RANGE

14–42mm

INDUSTRY



MATERIALS

FIRST CHOICE



SECOND CHOICE



APPLICATIONS



REAMING:
THROUGH &
CROSS HOLE



REAMING:
BLIND &
CROSS HOLE

SERIES	STYLE	DIAMETER RANGE
TRF™	Straight	16–40mm
TRF™	Helical	14–40mm
TRM™	Straight	14–42mm
TRM™	Helical	15–41mm

Shank Style

Round cylindrical

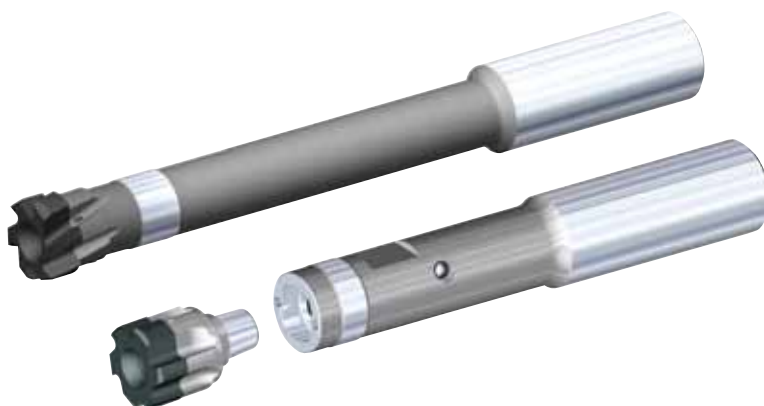

TRF™ • Disc Style Reamers • Straight Fluted with Internal Coolant

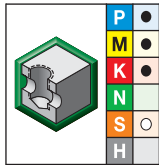
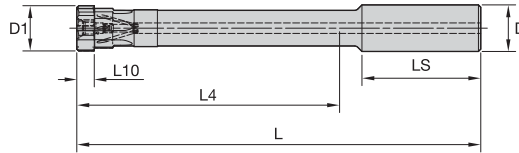

grade WU05PR
AlCrN

● first choice
○ alternate choice

order #	catalogue #	D1	D	L	L4	L10	LS	Z
6055333	TRF16000H7SF	16,00	20,00	159,4	102,4	7,5	51,0	6
6055334	TRF17000H7SF	17,00	20,00	159,4	102,4	7,5	51,0	6
6055335	TRF18000H7SF	18,00	20,00	173,4	116,4	7,5	51,0	6
6055336	TRF19000H7SF	19,00	20,00	173,4	116,4	7,5	51,0	6
6055337	TRF20000H7SF	20,00	20,00	173,4	116,4	7,5	51,0	6
6135130	TRF21000H7SF	21,00	20,00	202,4	145,4	7,5	51,0	6
6135191	TRF22000H7SF	22,00	20,00	202,4	145,4	7,5	51,0	6
6135193	TRF24000H7SF	24,00	20,00	212,4	155,4	7,5	51,0	6
6135194	TRF25000H7SF	25,00	25,00	232,4	169,4	7,5	57,0	8
6135195	TRF26000H7SF	26,00	25,00	232,4	169,4	7,5	57,0	8
6135196	TRF27000H7SF	27,00	25,00	232,4	169,4	7,5	57,0	8
6135199	TRF30000H7SF	30,00	25,00	272,4	209,4	7,5	57,0	8
6135200	TRF31000H7SF	31,00	25,00	272,4	209,4	7,5	57,0	8
6135201	TRF32000H7SF	32,00	25,00	272,4	209,4	7,5	57,0	8
6135209	TRF40000H7SF	40,00	32,00	272,4	205,4	7,5	61,0	8

TRF • Disc Style Reamers • Helical Fluted with Internal Coolant

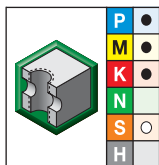
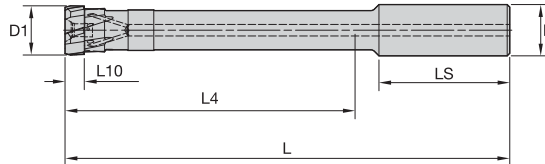

grade WU05PR
AlCrN

● first choice
○ alternate choice

order #	catalogue #	D1	D	L	L4	L10	LS	Z
6055338	TRF14000H7HF	14,00	16,00	147,4	92,4	7,5	49,0	6
6055339	TRF15000H7HF	15,00	16,00	147,4	92,4	7,5	49,0	6
6055340	TRF16000H7HF	16,00	20,00	159,4	102,4	7,5	51,0	6
6055341	TRF17000H7HF	17,00	20,00	159,4	102,4	7,5	51,0	6
6055342	TRF18000H7HF	18,00	20,00	173,4	116,4	7,5	51,0	6
6055344	TRF20000H7HF	20,00	20,00	173,4	116,4	7,5	51,0	6
6135212	TRF21000H7HF	21,00	20,00	202,4	145,4	7,5	51,0	6
6135213	TRF22000H7HF	22,00	20,00	202,4	145,4	7,5	51,0	6
6135214	TRF23000H7HF	23,00	20,00	212,4	155,4	7,5	51,0	6
6135215	TRF24000H7HF	24,00	20,00	212,4	155,4	7,5	51,0	6
6135216	TRF25000H7HF	25,00	25,00	232,4	169,4	7,5	57,0	8
6135218	TRF27000H7HF	27,00	25,00	232,4	169,4	7,5	57,0	8
6135219	TRF28000H7HF	28,00	25,00	242,4	179,4	7,5	57,0	8
6135221	TRF30000H7HF	30,00	25,00	272,4	209,4	7,5	57,0	8
6135223	TRF32000H7HF	32,00	25,00	272,4	209,4	7,5	57,0	8
6135226	TRF35000H7HF	35,00	32,00	272,4	205,4	7,5	61,0	8
6135229	TRF38000H7HF	38,00	32,00	272,4	205,4	7,5	61,0	8
6135231	TRF40000H7HF	40,00	32,00	272,4	205,4	7,5	61,0	8

TRM™ Disc Style Modular Reamer Heads • Blind Holes

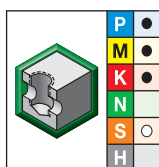
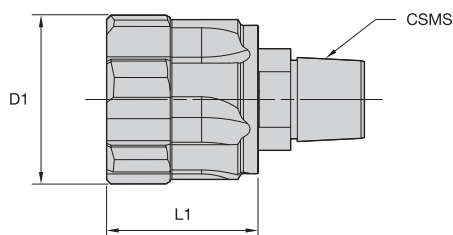

● first choice
○ alternate choice

grade WU05PR
AICrN

order #	catalogue #	CSMS system size	D1	L1	Z
6447321	TRM14000WST115H7SF	KST115	14,00	17,90	6
6447323	TRM15000WST115H7SF	KST115	15,00	17,90	6
6447327	TRM17000WST135H7SF	KST135	17,00	17,90	6
6447329	TRM18000WST155H7SF	KST155	18,00	17,90	6
6447342	TRM20000WST175H7SF	KST175	20,00	17,90	6
6447344	TRM21000WST175H7SF	KST175	21,00	17,90	6
6447346	TRM22000WST175H7SF	KST175	22,00	17,90	6
6447348	TRM23000WST200H7SF	KST200	23,00	18,90	6
6447361	TRM25000WST200H7SF	KST200	25,00	18,90	8
6447365	TRM27000WST200H7SF	KST200	27,00	18,90	8
6447367	TRM28000WST250H7SF	KST250	28,00	18,90	8
6447369	TRM29000WST250H7SF	KST250	29,00	18,90	8
6447371	TRM30000WST250H7SF	KST250	30,00	18,90	8
6447373	TRM31000WST250H7SF	KST250	31,00	18,90	8
6447377	TRM33000WST300H7SF	KST300	33,00	20,40	8
6447379	TRM34000WST300H7SF	KST300	34,00	20,40	8
6447381	TRM35000WST300H7SF	KST300	35,00	20,40	8
6175690	TRM36000WST300H7SF	KST300	36,00	20,40	8
6447384	TRM37000WST300H7SF	KST300	37,00	20,40	8
6447386	TRM38000WST350H7SF	KST350	38,00	20,40	8
6447388	TRM39000WST350H7SF	KST350	39,00	20,40	8
6447390	TRM40000WST350H7SF	KST350	40,00	20,40	8
6447392	TRM41000WST350H7SF	KST350	41,00	20,40	8
6447393	TRM42000WST350H7SF	KST350	42,00	20,40	8

TRM™ Disc Style Modular Reamer Heads • Through Holes

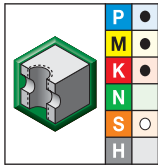
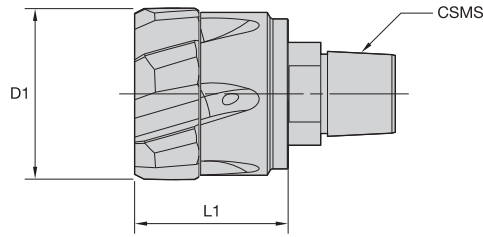

● first choice
○ alternate choice

grade WU5PR
AlCrN

order #	catalogue #	CSMS system size	D1	L1	Z
6447322	TRM15000WST115H7HF	KST115	15,00	17,90	6
6447326	TRM17000WST135H7HF	KST135	17,00	17,90	6
6447328	TRM18000WST155H7HF	KST155	18,00	17,90	6
6447330	TRM19000WST155H7HF	KST155	19,00	17,90	6
6393172	TRM20000WST175H7HF	KST175	20,00	17,90	6
6447343	TRM21000WST175H7HF	KST175	21,00	17,90	6
6447345	TRM22000WST175H7HF	KST175	22,00	17,90	6
6447347	TRM23000WST200H7HF	KST200	23,00	18,90	6
6447349	TRM24000WST200H7HF	KST200	24,00	18,90	6
6205150	TRM25000WST200H7HF	KST200	25,00	18,90	8
6447362	TRM26000WST200H7HF	KST200	26,00	18,90	8
6447364	TRM27000WST200H7HF	KST200	27,00	18,90	8
6447368	TRM29000WST250H7HF	KST250	29,00	18,90	8
6447372	TRM31000WST250H7HF	KST250	31,00	18,90	8
6447374	TRM32000WST250H7HF	KST250	32,00	18,90	8
6447376	TRM33000WST300H7HF	KST300	33,00	20,40	8
6447380	TRM35000WST300H7HF	KST300	35,00	20,40	8
6447382	TRM36000WST300H7HF	KST300	36,00	20,40	8
6447385	TRM38000WST350H7HF	KST350	38,00	20,40	8
6447389	TRM40000WST350H7HF	KST350	40,00	20,40	8
6447391	TRM41000WST350H7HF	KST350	41,00	20,40	8

INDEXABLE MILLING

SOLID END MILLING

HOLEMAKING

TAPPING

TURNING

Straight Shank Bodies • Axial Clamping • 3 x D

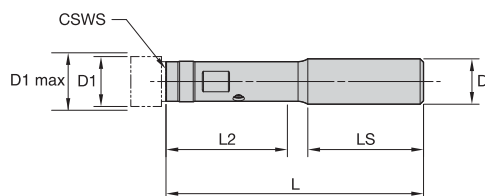

order number	catalogue number	CSWS system size	D1	D1 max	D	L	L2	LS	kg	lbs
6338199	SS16WST115AR3M	KST115	14,00	15,999	16,00	91,00	35,00	48,00	0,1	.3
6311901	SS20WST155AR3M	KST155	18,00	19,999	20,00	106,00	45,00	51,00	0,2	.5

Straight Shank • Radial Clamping • 3 x D

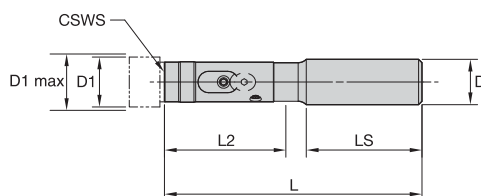

order number	catalogue number	CSWS system size	D1	D1 max	D	L	L2	LS
6055345	SS20WST175RR3M	KST175	20,00	22,499	20,00	113,50	51,50	51,00
6055347	SS20WST200RR3M	KST200	22,50	27,499	20,00	130,50	65,50	51,00
6055349	SS25WST250RR3M	KST250	27,50	32,499	25,00	152,50	80,50	56,00
6055351	SS32WST300RR3M	KST300	32,50	37,499	32,00	174,00	94,00	61,00
6055353	SS32WST350RR3M	KST350	37,50	42,000	32,00	190,00	108,00	61,00

Straight Shank Bodies • Axial Clamping • 5 x D

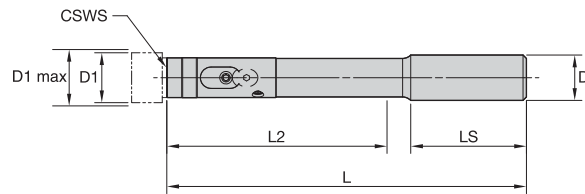

order number	catalogue number	CSWS system size	D1	D1 max	D	L	L2	LS	kg	lbs
6433752	SS16WST115AR5M	KST115	14,00	15,999	16,00	123,00	67,00	48,00	0,1	.3
6433754	SS20WST155AR5M	KST155	18,00	19,999	20,00	146,00	85,00	51,00	0,2	.5

Straight Shank • Radial Clamping • 5 x D

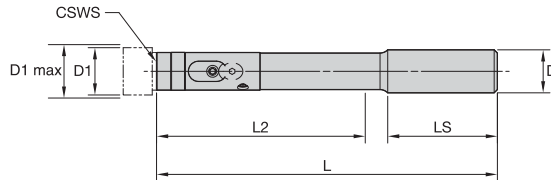

order number	catalogue number	CSWS system size	D1	D1 max	D	L	L2	LS
6055346	SS20WST175RR5M	KST175	20,00	22,499	20,00	158,50	96,50	51,00
6055348	SS20WST200RR5M	KST200	22,50	27,499	20,00	185,50	120,50	51,00
6055350	SS25WST250RR5M	KST250	27,50	32,499	25,00	217,50	145,50	56,00
6055352	SS32WST300RR5M	KST300	32,50	37,499	32,00	249,00	169,00	61,00
6055354	SS32WST350RR5M	KST350	37,50	42,000	32,00	274,00	192,00	61,00

Application Data • TRM™ • WU05PR • Metric

Material Group		WU05-PR			Metric						
		Cutting Speed – vc			Recommended Feed Rate per Tooth						
		Range – m/min			Tool Diameter (mm)	14,00–19,99mm		20,00–32,00mm		32,50–42,00mm	
		min	Starting Value	max		Feed/Tooth	min	max	min	max	min
P	1	90	120	155	mm/z	0,10	0,20	0,10	0,22	0,10	0,25
	2	90	120	155	mm/z	0,10	0,20	0,10	0,22	0,10	0,25
	3	75	100	130	mm/z	0,10	0,20	0,10	0,22	0,10	0,25
	4	50	80	105	mm/z	0,10	0,20	0,10	0,22	0,10	0,25
	5	30	40	60	mm/z	0,08	0,18	0,08	0,20	0,08	0,22
	6	30	40	60	mm/z	0,08	0,18	0,08	0,20	0,08	0,22
M	1	15	20	40	mm/z	0,08	0,15	0,08	0,18	0,08	0,20
	2	15	20	30	mm/z	0,08	0,15	0,08	0,18	0,08	0,20
	3	15	20	30	mm/z	0,08	0,15	0,08	0,18	0,08	0,20
K	1	80	110	130	mm/z	0,10	0,20	0,10	0,22	0,10	0,25
	2	65	90	110	mm/z	0,10	0,20	0,10	0,22	0,10	0,25
	3	50	70	90	mm/z	0,10	0,18	0,10	0,20	0,10	0,22
S	1	15	20	30	mm/z	0,06	0,15	0,10	0,18	0,10	0,20
	2	15	20	30	mm/z	0,06	0,15	0,10	0,18	0,10	0,20
	3	20	30	40	mm/z	0,08	0,18	0,10	0,20	0,10	0,20
	4	20	30	40	mm/z	0,08	0,18	0,10	0,20	0,10	0,20

Application Data • TRF™ • WU05PR • Metric

Material Group		WU05-PR			Metric						
		Cutting Speed – vc			Recommended Feed Rate per Tooth						
		Range – m/min			Tool Diameter (mm)	14,00–19,99mm		20,00–32,00mm			
		min	Starting Value	max		Feed/Tooth	min	max	min	max	min
P	1	90	120	155	mm/z	0,10	0,22	0,10	0,25		
	2	90	120	155	mm/z	0,10	0,22	0,10	0,25		
	3	75	100	130	mm/z	0,10	0,22	0,10	0,25		
	4	50	80	105	mm/z	0,10	0,22	0,10	0,25		
	5	30	40	60	mm/z	0,10	0,22	0,10	0,25		
	6	30	40	60	mm/z	0,08	0,20	0,08	0,22		
M	1	15	20	40	mm/z	0,08	0,18	0,08	0,20		
	2	15	20	30	mm/z	0,08	0,18	0,08	0,20		
	3	15	20	30	mm/z	0,08	0,18	0,08	0,20		
K	1	80	110	130	mm/z	0,10	0,22	0,10	0,25		
	2	65	90	110	mm/z	0,10	0,22	0,10	0,25		
	3	50	70	90	mm/z	0,10	0,20	0,10	0,25		
S	1	15	20	30	mm/z	0,10	0,18	0,10	0,20		
	2	15	20	30	mm/z	0,10	0,18	0,10	0,20		
	3	20	30	40	mm/z	0,10	0,20	0,10	0,20		
	4	20	30	40	mm/z	0,10	0,20	0,10	0,20		

TRM™ Assembly

Assembling

1 Assembling reamer head



2 Place reamer head in reamer body



3 Clamp reamer head in reamer body



WST	Ø Range [mm]		Mt [Nm]	Torx size
175	20.000	22.499	5	TT-15
200	22.500	27.499	5	TT-15
250	27.500	32.499	9	TT-25
300	32.500	37.499	13	TT-30
350	37.500	42.000	13	TT-30

Disassembling

Reverse order [3, 2, 1]



The eBore boring system covers a diameter range from 6–1020mm by providing state-of-the-art fine boring tooling solutions that have one thing in common: all of them are digital ready.

The digital eBore display enables the tool to be readjusted on the spindle, reducing setup time and idle time. **One for all — One eBore digital display serving all eBore fine boring tools.**

Micron by micron, the precision adjustment of each tool is as easy as 1, 2, 3.

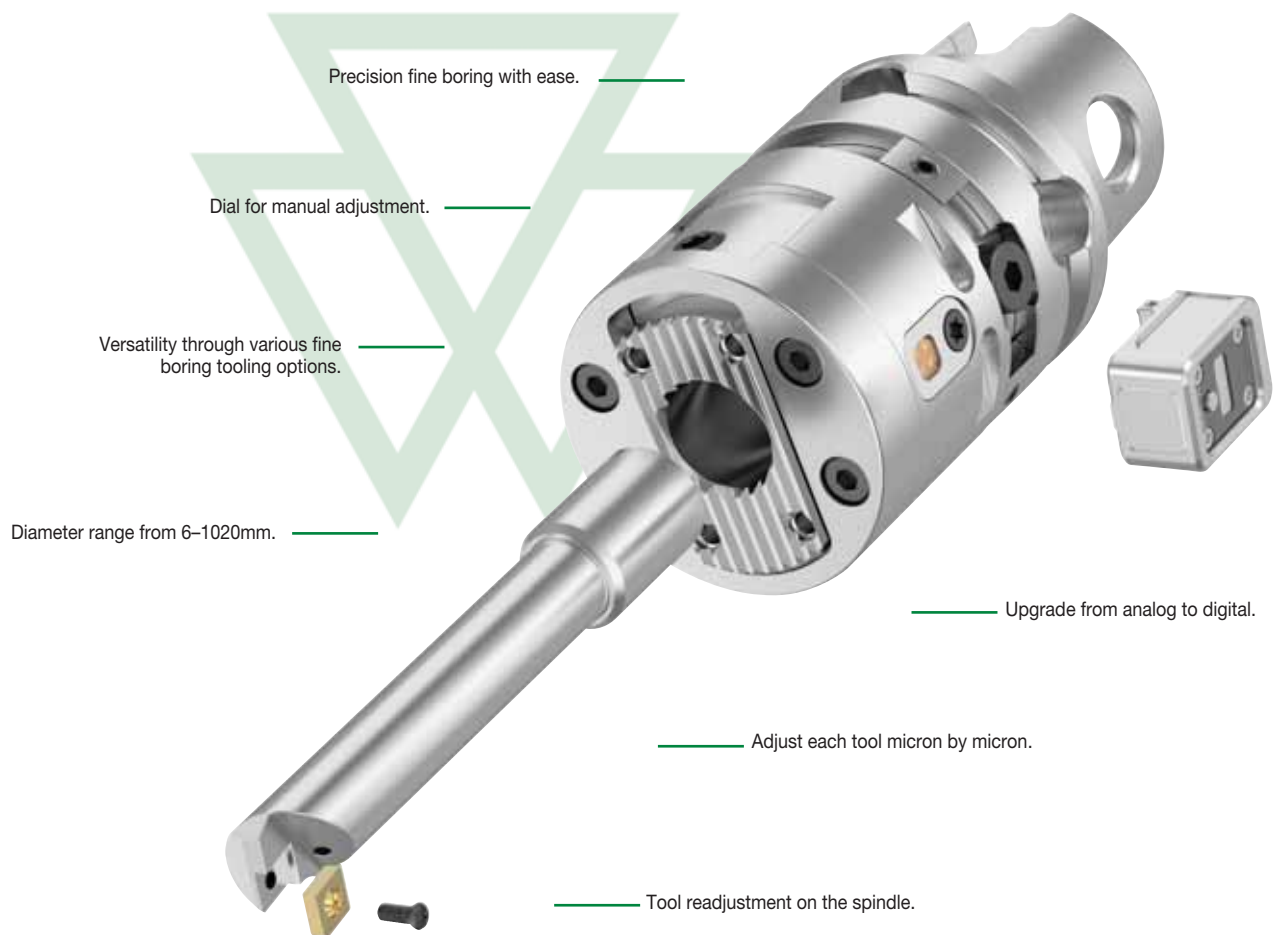

CONSISTENT PERFORMANCE

PRODUCT

ONE FOR ALL
One eBore™ digital display serving all eBore fine boring tools.

DIAMETER RANGE

6–1020mm

INDUSTRY



MATERIALS



APPLICATIONS



REAMING:
THROUGH
HOLE



REAMING:
BLIND HOLE



REAMING:
THROUGH &
CROSS HOLES



REAMING:
BLIND &
CROSS HOLES

ADAPTERS

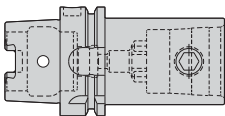

HSK to KM™

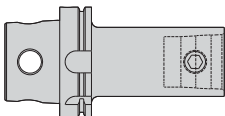

KM4X™ to KM

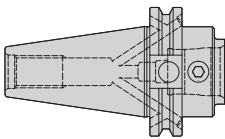

BT, CV, DV to KM

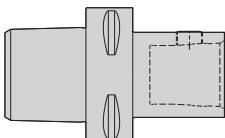

PSC to KM

EXTENSION

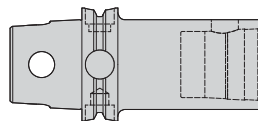

eBore

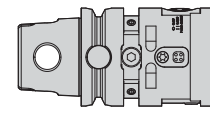

eBore Universal

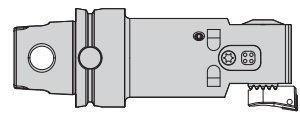



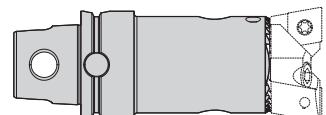























eBore Fine Boring



eBore Twin Cutter

Tool Selection Guide • Fine Boring

				
Series	eBore™ Universal	eBore Fine Boring Tool	eBore Bridge Finishing Tools	eBore Twin Cutters
Page	C140	C146	C148	C151
Workpiece material				
<i>Primary</i>	P M K N S	P M K N S	P M K N S	P M K N S
<i>Secondary</i>	H	H	H	
Boring range [BR1]	6–152mm	20–205mm	200–1020mm	19,5–1020mm
Accuracy		IT6		IT9
Cylindricity 		5 µm		10 µm
Position 		5–10 µm		>20 µm
Surface roughness (Ra) P		0,8–2,0 µm		1,0–5,0 µm
Surface roughness (Ra) M		0,8–2,0 µm		1,0–5,0 µm
Surface roughness (Ra) K		0,8–2,0 µm		1,0–5,0 µm
Surface roughness (Ra) N		0,8–2,0 µm		1,0–2,0 µm
Surface roughness (Ra) S		0,8–2,0 µm		1,0–5,0 µm
Surface roughness (Ra) H		< 1,2 µm		
Coolant				
Main Operations	 	 	 	 
	 	 	 	 

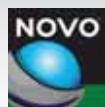

**TO SEE ALL PRODUCT LINES,
VISIT OUR DIGITAL RESOURCES**
widia.com or widianovo.com

eBore™ • Catalog Numbering System

Each character in our catalog number signifies a specific trait of that product. Use the following key columns and corresponding images to easily identify which attributes apply.

▼ Head

KM50	UFT	152
Back End	Boring System	Boring Range
KM™	UTF = Universal Fine Boring Tool BT = Fine Boring Tool BDG = Bridge Tool TC = Twin Cutter	Diameter (min. or max.)

▼ Boring Bar and Insert Holder

BB	14	50	CC06
Tool Type	Diameter	Length	Insert Style and Size
BB = Boring bar IH = Insert holder	Ø14mm	50mm	CC = Rhomboid 60°, 7° clearance angle 06 = IC 6mm 09 = IC 9mm 12 = IC 12mm

eBore™ Digital Display Overview

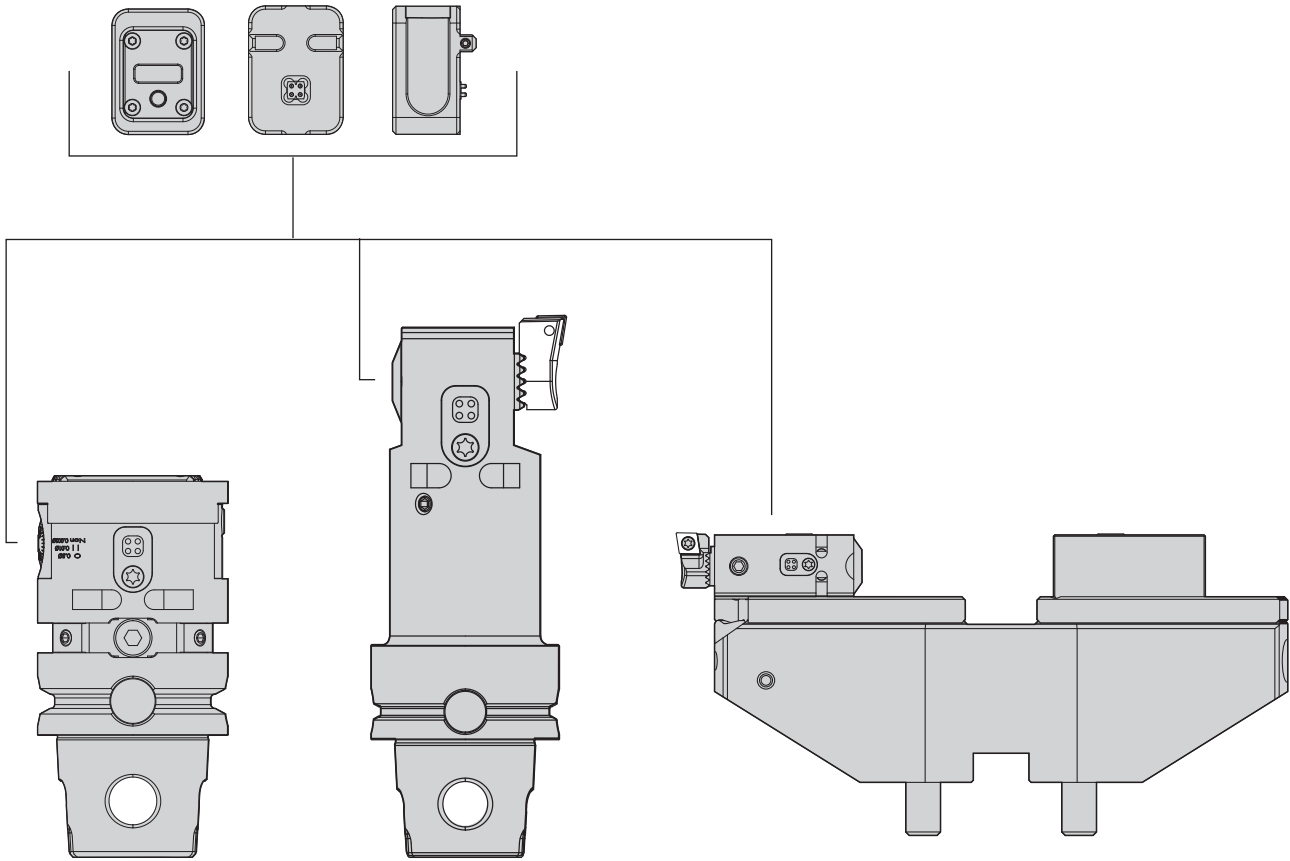

eBore Digital Display



order number
6655307
6655306

catalogue number
FBDD0001IN
FBDD0001M

eBore™ Universal Overview

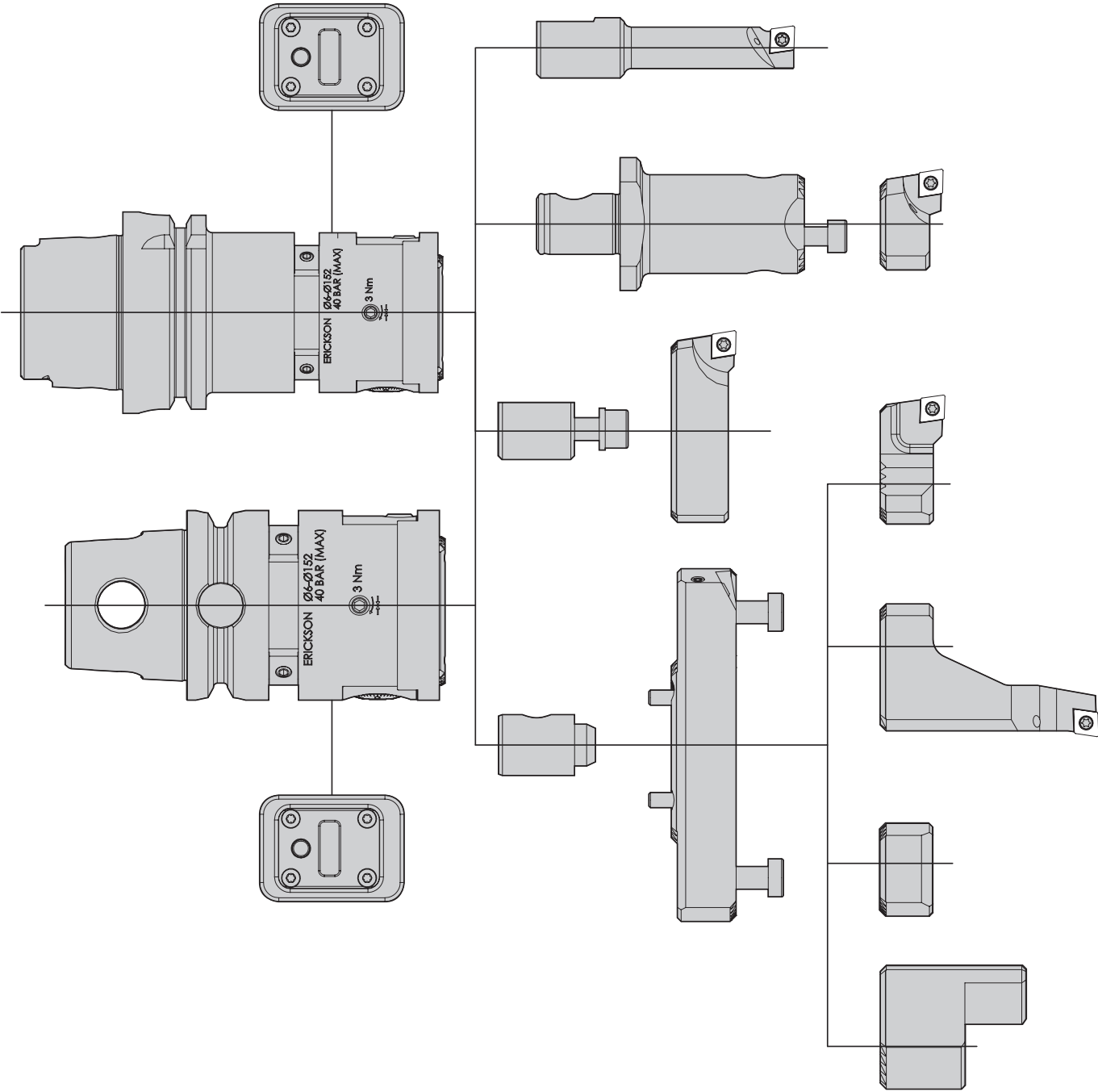

INDEXABLE MILLING

SOLID END MILLING

HOLEMAKING

TAPPING

TURNING

eBore™ • Universal • Head • KM™

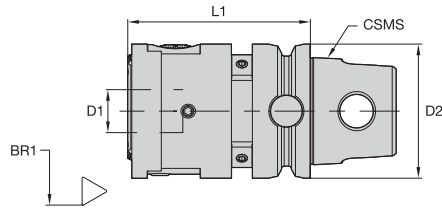

order number	catalogue number	BR1	CSMS	D1	D2	L1
6655201	KM50UFT152	6,0000-152,0000	KM50TS	16,0	50,0	68,0

eBore • Universal • Head • HSK63A

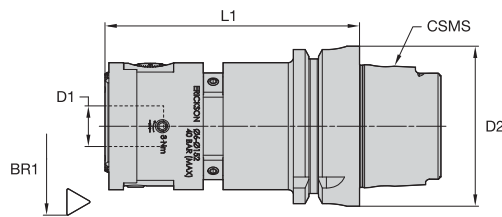

order number	catalogue number	BR1	CSMS	D1	D2	L1
6922550	HSK63AUFT152	6,0000-152,0000	HSK63A	16,0	50,0	100,0

eBore™ Universal • Boring Bar • Heavy Metal

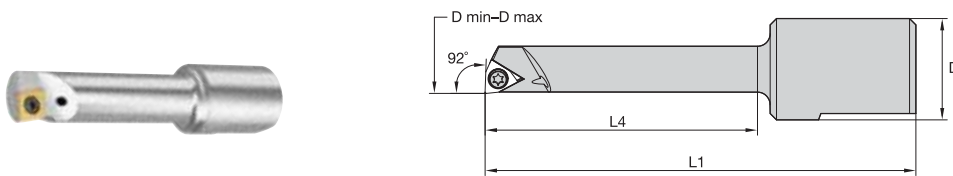

order number	catalogue number	D min	D max	D	L1	L4
6655221	BB0632WBGX02	6,0	8,0	16,0	55,0	30,0
6655222	BB0845WBGX02	8,0	10,0	16,0	68,0	43,0

eBore Universal • Boring Bar • Heavy Metal • Insert

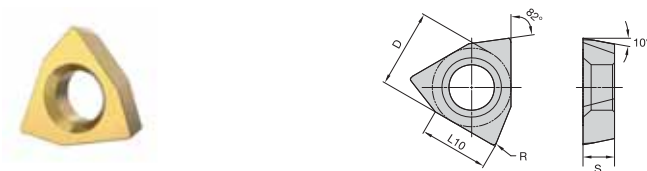

- first choice
- alternate choice

P	●
M	●
K	●
N	●
S	●
H	●

ISO catalogue number	D	L10	Rε	KCU10
WBGX020101	3,97	3,45	0,1	6826761

eBore Universal • Boring Bar • Steel

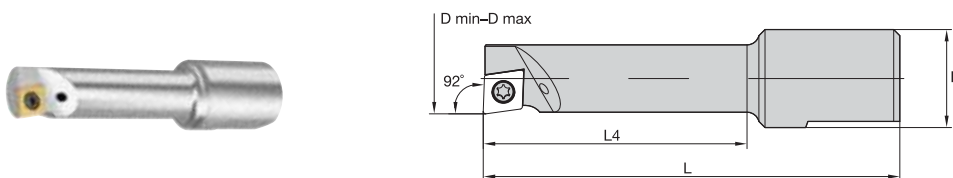

order number	catalogue number	D min	D max	D	L	L4
6655202	BB0622WBGX02	6,0	8,0	16,0	45,0	20,0
6655203	BB0830WBGX02	8,0	10,0	16,0	53,0	28,0
6655204	BB1025CC06	10,0	12,0	16,0	48,0	23,0
6655205	BB1035CC06	10,0	12,0	16,0	58,0	33,0
6655206	BB1230CC06	12,0	14,0	16,0	53,0	28,0
6655207	BB1245CC06	12,0	14,0	16,0	68,0	43,0
6655208	BB1435CC06	14,0	16,0	16,0	58,0	34,0
6655209	BB1450CC06	14,0	16,0	16,0	73,0	48,4
6655210	BB1560CC06	15,0	20,0	16,0	83,0	57,8
6655211	BB1640CC06	16,0	20,0	16,0	63,0	40,0
6655212	BB2070CC06	20,0	25,0	16,0	93,0	70,0
6655213	BB2570CC06	25,0	30,0	16,0	93,0	70,0

eBore™ Universal • Boring Bar • Carbide

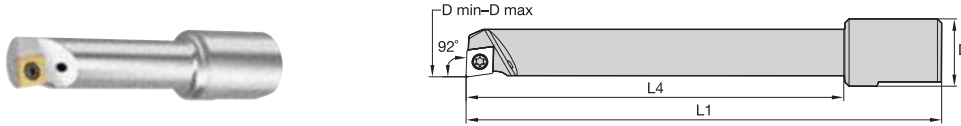

order number	catalogue number	D min	D max	D	L1	L4
6655214	BB1055CC06	10,0	12,0	16,0	78,0	55,0
6655215	BB1075CC06	10,0	12,0	16,0	98,0	75,0
6655216	BB1290CC06	12,0	14,0	16,0	113,0	90,0
6655217	BB1475CC06	14,0	16,0	16,0	98,0	75,0
6655218	BB14100CC06	14,0	16,0	16,0	123,0	100,0
6655219	BB1690CC06	16,0	20,0	16,0	113,0	90,0
6655220	BB16120CC06	16,0	20,0	16,0	143,0	120,0

eBore Universal • Extension

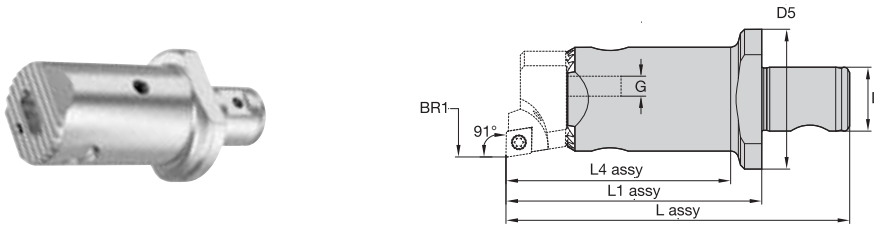

order number	catalogue number	BR1	D	D5	L1 assy	L2 assy	G
6655223	UFTE64	29,0000-53,0000	16,0	35,0	64,0	56,2	M5X20
6655224	UFTE100	29,0000-53,0000	16,0	35,0	100,0	92,2	M5X20

eBore Universal • Insert Holder for Extension • CC06

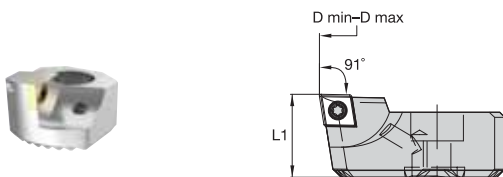

order number	catalogue number	D min	D max	L1
6655226	IH02916CC06	29,0	41,0	16,0
6655227	IH04016CC06	40,0	53,0	16,0

eBore Universal • Mounting Bolt for Insert Holder Straight Mount

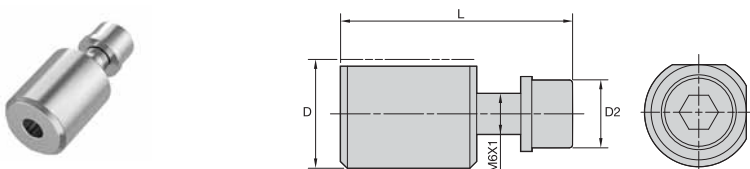

order number	catalogue number	D	D2	L
6655231	WIH052076	16,0	11,00	34,10

eBore™ Universal • Insert Holder for Straight Mount • CC06

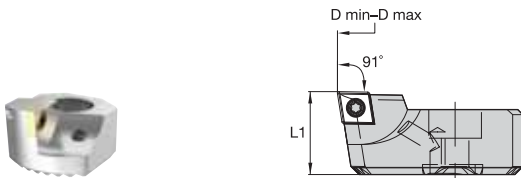

order number	catalogue number	D min	D max	L1
6655228	IH05216CC06	52,0	77,0	16,5
6655229	IH07616CC06	76,0	102,0	16,5

eBore Universal • Coolant Connector



order number	catalogue number	D	L
6655238	CBUFTB	16,0	25,5

eBore Universal • Bridge for Insert Holder I.D./O.D.

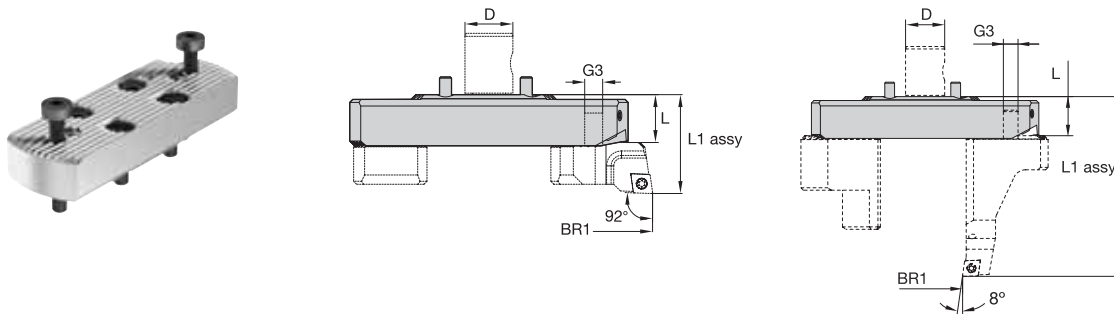

order number	catalogue number	BR1 - I.D.	BR1 - O.D.	D	L	L1 assy - I.D.	L1 assy - O.D.	G3
6655233	UFTB06816	68,0000-96,0000	—	16,0	17,1	32,5	—	M4X0.7
6655234	UFTB09616	96,0000-124,0000	2,0000 - 30,0000	16,0	17,1	32,5	75,1	M4X0.7
6655235	UFTB12416	124,0000-152,0000	29,0000 - 58,0000	16,0	17,1	32,5	75,1	M4X0.7

eBore™ Universal • Insert Holder I.D. • CC06

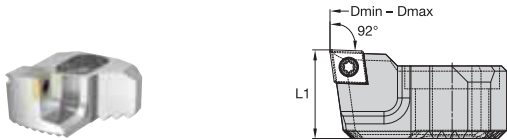

order number	catalogue number	D min	D max	L1
6655236	IHUFTBCC06	68,0	152,0	16,5

eBore Universal • Counterweight I.D.

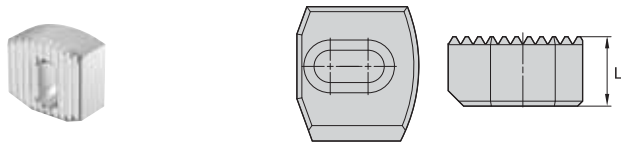

order number	catalogue number	L
6655237	CWUFTB	14,0

eBore Universal • Insert Holder O.D. • CC06



order number	catalogue number	D min	D max	L1
6655308	IHUFTODCC06	2,0	58,0	57,0

eBore™ Universal • Counterweight O.D.

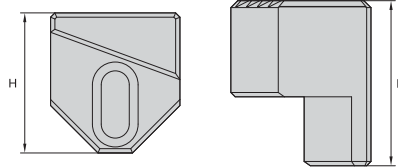

order number	catalogue number	L	H
6655309	CWUFTBOD	38,3	32,5

eBore™ Universal • Balancing Weight



order number	catalogue number
6655232	BW536005

INDEXABLE MILLING

SOLID END MILLING

HOLEMAKING

TAPPING

TURNING

eBore™ Fine Boring Overview

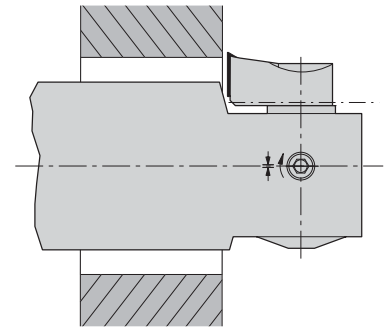
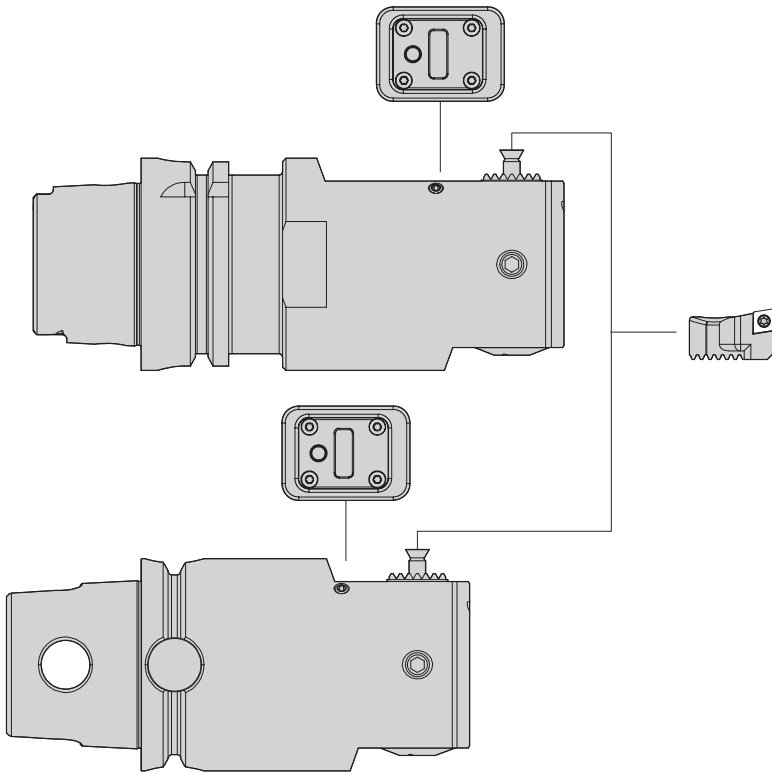

Back boring feasible with identical cartridge

For back boring, the insert holder is turned through 180° and mounted on the slider.

Attention: Back boring then takes place with the machine spindle rotating counterclockwise.

eBore Fine Boring • Cutting Unit • KM™

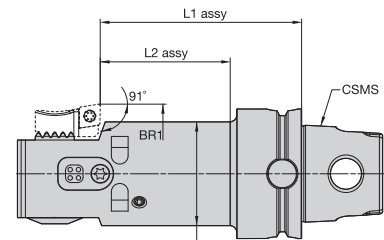
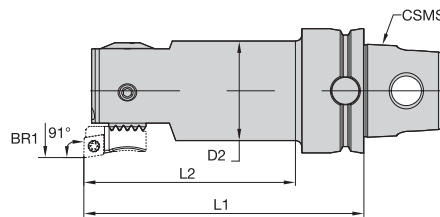

Back boring (BB)

order number	catalogue number	BR1	CSMS	D2	L1 assy	L2 assy	L1 assy BB	L2 assy BB	IHS
6655290	KM32BT024532	24,5000-29,0000	KM32TS	23,0	90,0	78,0	—	—	A
6655292	KM32BT02942	29,0000-44,0000	KM32TS	27,0	100,0	88,0	72,0	60,0	A / B
6655294	KM40BT04352	43,0000-54,0000	KM40TS	32,0	90,0	68,0	62,0	40,0	B
6655295	KM50BT05357	53,0000-66,0000	KM50TS	42,0	86,0	68,0	58,0	36,0	B
6655297	KM50BT06557	65,0000-83,0000	KM50TS	50,0	90,0	90,0	54,0	32,0	C
6655298	KM63BT08272	82,0000-103,0000	KM63TS	63,0	100,0	100,0	64,0	42,0	C
6655299	KM80BT10072	100,0000-130,0000	KM80TS	80,0	120,0	120,0	84,0	62,0	C
6655300	KM80BT12572	125,0000-167,5000	KM80TS	100,0	120,0	120,0	84,0	62,0	C
6655301	KM80BT162572	162,5000-205,0000	KM80TS	135,0	150,0	150,0	114,0	92,0	C

eBore™ Fine Boring • Cutting Unit • HSK63A

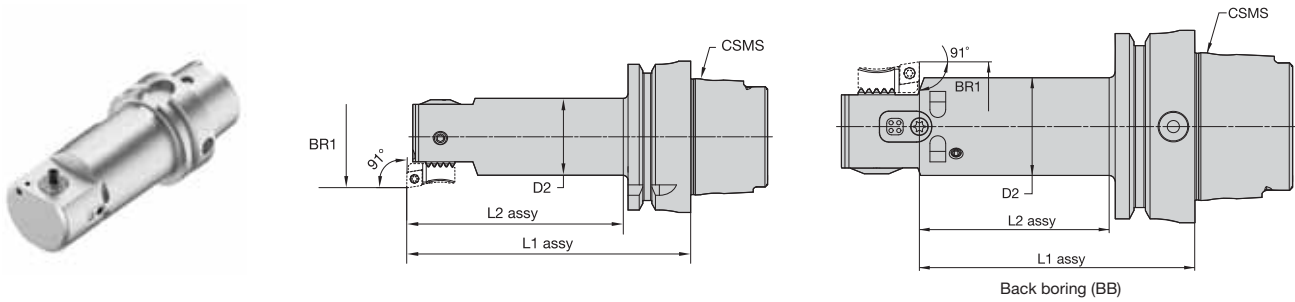

order number	catalogue number	BR1	CSMS	D2	L1 assay	L2 assay	L1 assay BB	L2 assay BB	IHS
6922551	HSK63ABT024580	24,5000-29,0000	HSK63A	23,0	108,0	82,0	—	—	A
6922552	HSK63ABT02990	29,0000-44,0000	HSK63A	27,0	118,0	92,0	90,0	62,0	A / B
6922553	HSK63ABT04390	43,0000-54,0000	HSK63A	32,0	118,0	92,0	90,0	62,0	B
6922554	HSK63ABT053100	53,0000-66,0000	HSK63A	42,0	128,0	102,0	100,0	72,0	B
6922555	HSK63ABT065100	65,0000-83,0000	HSK63A	50,0	128,0	102,0	92,0	64,0	C
6922556	HSK63ABT082100	82,0000-103,0000	HSK63A	63,0	128,0	102,0	92,0	64,0	C
6922557	HSK63ABT100120	100,0000-130,0000	HSK63A	80,0	148,0	122,0	112,0	84,0	C
6922558	HSK63ABT125120	125,0000-167,5000	HSK63A	100,0	148,0	122,0	112,0	84,0	C
6922559	HSK63ABT1625150	162,5000-205,0000	HSK63A	135,0	178,0	152,0	142,0	114,0	C

eBore Fine Boring • Insert Holder

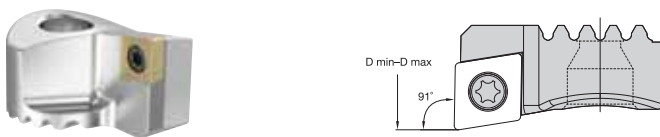

order number	catalogue number	D min	D max	IHS
6655291	IHBT024CC06	24,5	37,0	A
6655293	IHBT036CC06	36,0	66,0	B
6655296	IHBT065CC06	65,0	205,0	C

eBore™ Bridge Tools Overview

eBore — Bridge S (Small)

eBore — Bridge L (Large)

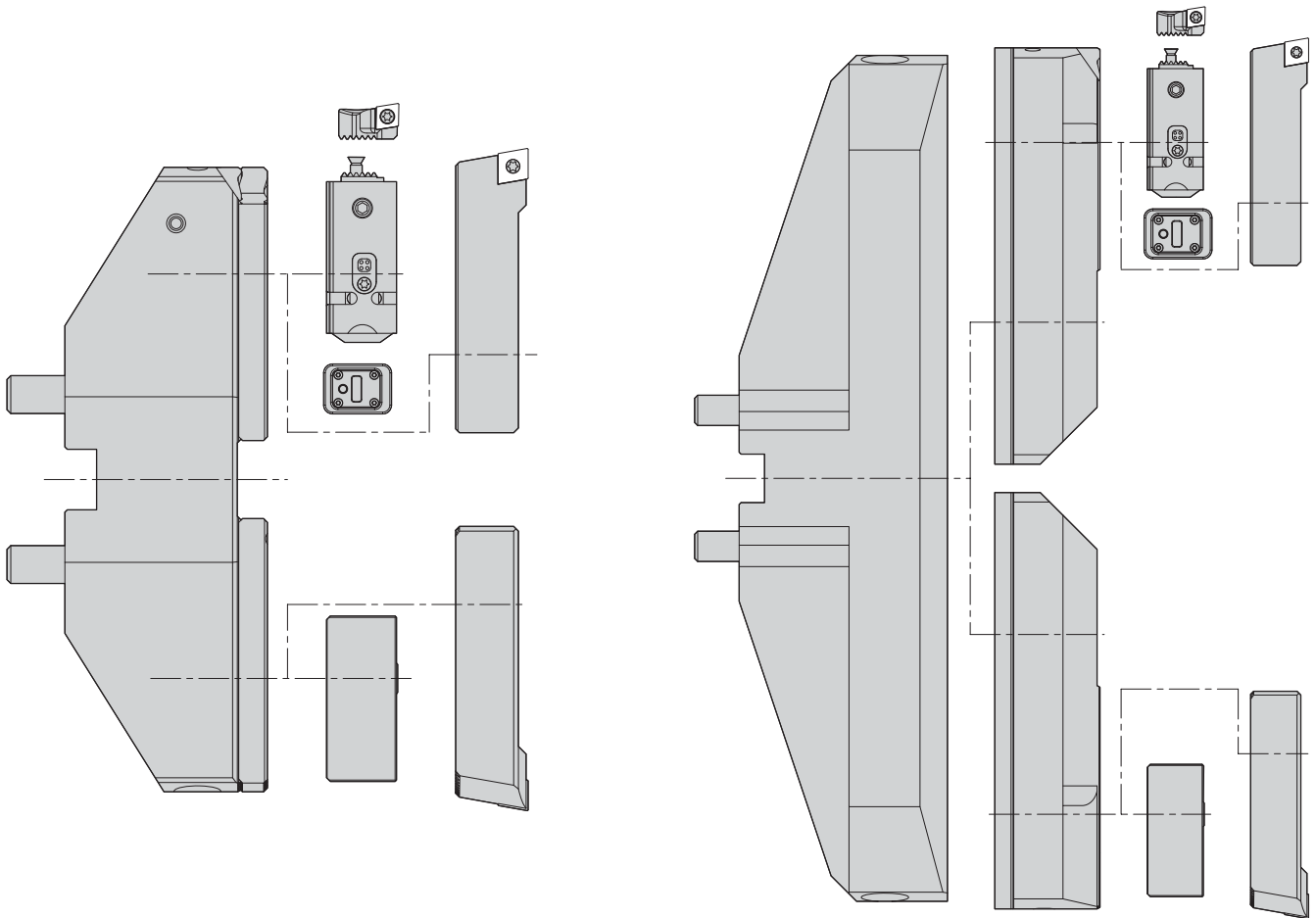

eBore™ • Bridge S

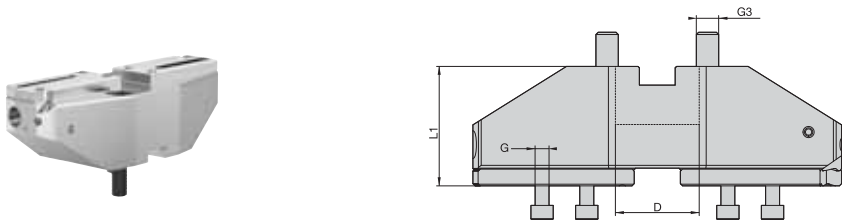

order number	catalogue number	BR1	D	L1	L1 assy	G	G3
6655282	BDG20060	200,000-280,000	60,0	85,0	115,1	M10X50	M16X2
6655284	BDG27560	275,000-355,000	60,0	85,0	115,1	M10X50	M16X2
6655285	BDG35060	350,000-430,000	60,0	85,0	115,1	M10X50	M16X2
6655286	BDG42560	425,000-505,000	60,0	85,0	115,1	M10X50	M16X2

eBore™ • Bridge • Large

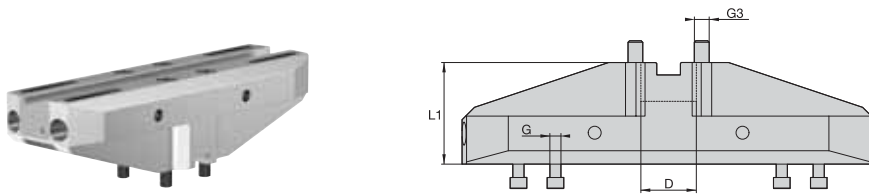

order number	catalogue number	BR1	D	L1	L1 assy	G	G3
6655287	BDG46560	465,0000-745,0000	60,0	110,0	185,1	M12X55	M16X2
6655289	BDG74060	740,0000-1020,0000	60,0	110,0	185,1	M12X55	M16X2

eBore • Bridge • Large • Extender



order number	catalogue number	L1	G
6655288	SBDG46545	45,0	M10X1,5

eBore • Bridge S/L • Insert Holder • CC12

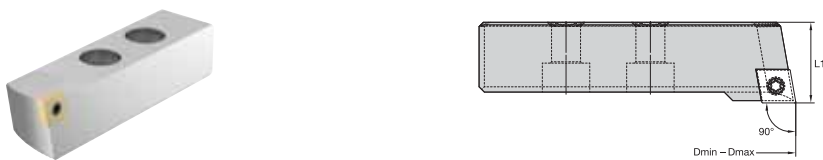

order number	catalogue number	D min	D max	L1
6655283	IHBDGCC12	200,0	1020,0	30,1

INDEXABLE MILLING

SOLID END MILLING

HOLEMAKING

TAPPING

TURNING

eBore™ • Bridge S/L • Slide

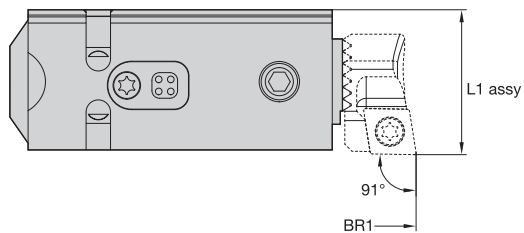

order number
6655302

catalogue number
BFBS10012

BR1
100,0000

L1 assy
30,0

eBore • Bridge S/L • Slide Insert Holder • CC09

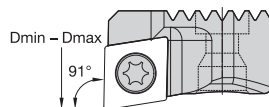

order number
6655303

catalogue number
IHBFBSCC09

D min
200,0

D max
1020,0

eBore • Bridge S/L • Slide • Counterweight

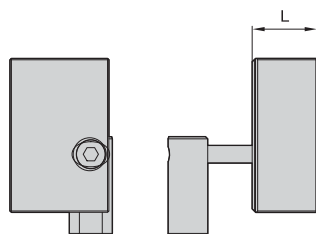

order number
6655305

catalogue number
CWFBS

L
68,2

eBore™ Twin Cutter Overview

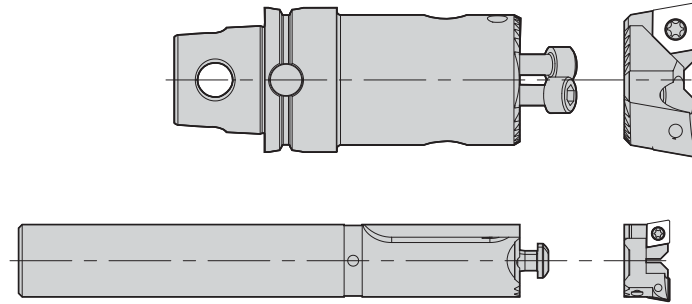

eBore • Twin Cutter • Straight Shank

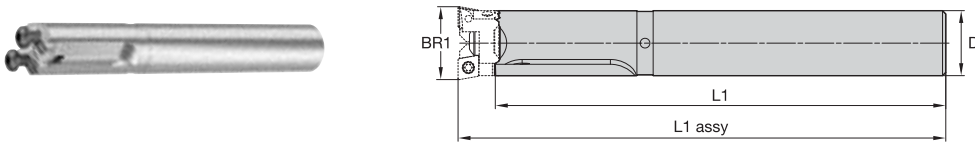

order number	catalogue number	BR1	D	L1	L1 assy
6655239	SS18TC0195	19,5000-23,0000	18,0	138,0	150,0
6655241	SS20TC0225	22,2000-26,0000	20,0	138,0	150,0
6922560	SS25TC0255	25,5000-30,0000	25,0	148,0	160,0

eBore • Twin Cutter • Straight Shank • Insert Holder

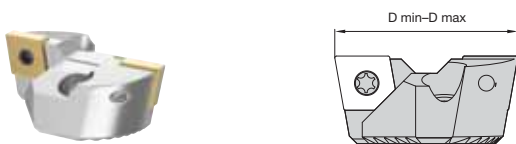

order number	catalogue number	D min	D max
6655240	IHTC0195CC06	19,5	23,0
6655242	IHTC0225CC06	22,5	26,0
6655244	IHTC0255CC06	25,5	30,0

NOTE: Order two insert holders for complete assembly as shown on the image.

INDEXABLE MILLING

SOLID END MILLING

HOLEMAKING

TAPPING

TURNING

eBore™ • Twin Cutter • KM™

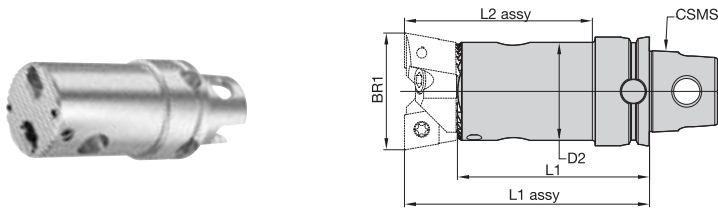

order number	catalogue number	BR1	CSMS	D2	L1	L1 assy	L2 assy
6655245	KM32TC029	29,0000-37,0000	KM32TS	25,0	86,0	100,0	88,0
6655247	KM32TC036	36,0000-44,0000	KM32TS	30,0	86,0	100,0	79,5
6655249	KM40TC043	43,0000-54,0000	KM40TS	36,0	70,0	90,0	69,0
6655271	KM50TC053	53,0000-66,0000	KM50TS	40,0	70,0	90,1	70,1
6655273	KM50TC065	65,0000-83,0000	KM50TS	50,0	70,0	90,1	90,1
6655275	KM63TC082	82,0000-103,0000	KM63TS	63,0	70,0	100,1	100,1
6655277	KM80TC100	100,0000-155,0000	KM80TS	80,0	90,0	120,1	120,1
6655280	KM80TC150	150,0000-205,0000	KM80TS	125,0	120,0	150,1	150,1

eBore • Twin Cutter • KM • Insert Holder



order number	catalogue number	D min	D max
6655246	IHTC029CC09	29,0	37,0
6655248	IHTC036CC09	36,0	44,0
6655250	IHTC043CC12	43,0	54,0
6655272	IHTC053CC12	53,0	66,0
6655274	IHTC065CC12	65,0	83,0
6655276	IHTC082CC12	82,0	103,0
6655278	IHTC100CC12	100,0	130,0
6655279	IHTC125CC12	125,0	205,0





Tapping

VariTap	D4–D23
Victory.....	D24–D25
Tap Drill Size Charts.....	D26–D30
Technical Information	D31–D33

VariTap has optimized geometries capable of working in a wide variety of ductile materials – including carbon and alloy steels, stainless steels, ductile iron, and cast aluminum.



Advanced spiral flute design
Smooth ejection of chip to reduce or eliminate bird-nesting

Multiple tap dimension options
ANSI, DIN, JIS, and DIN/ANSI

High-vanadium HSS-E
Improved wear characteristics, longer tool life

The VariTap platform is designed with a positive rake face and a flute optimized for tapping multiple materials.

GRADES

WP42EG	TiCN		WU41EG	TiN		WP49EG	Oxide	
	P	●		P	●		P	○
	M	●		M	○		M	○
	K	●		K	○		K	○
	N	●		N	○		N	○
	S	○		S	○		S	○
	H	○		H	○		H	○

VERSATILE MULTI-MATERIAL TAPS



PRODUCT

VariTap™ taps deliver performance for value in multi-material tapping applications.

INDUSTRY



MATERIALS



APPLICATIONS



BLIND HOLE



THROUGH HOLE



HSS-E



FORM E



FORM C



FORM B



ANSI UNC



ANSI UNF



ANSI M



ANSI MF



FLOOD COOLANT: TAPPING



CLASS OF FIT: 2B



CLASS OF FIT: 3B



CLASS OF FIT: 6H

SPIRAL POINT WITH ANSI DIMENSIONS

SIZE RANGE	CHAMFER STYLE	GRADE
2-56 to 1-12"	Plug (Form B)	WP49EG] All H Limits
		WP42EG]
		WU41EG] 3B Only
1-1/8-8" to 2-4-1/2"	Plug (Form B)	WP49EG
M3 x 0.50 to M12 x 1.75	Plug (Form B)	WP49EG] 6H D Limits
		WP42EG]
		WU41EG]
		WP49EG] D11
		WP42EG]
M14 x 1.5 to M20 x 2.5	Plug (Form B)	WP49EG WP42EG
M22 x 1.5 to M30 x 3.5	Plug (Form B)	WP49EG

SPIRAL FLUTE WITH ANSI DIMENSIONS

SIZE RANGE	CHAMFER STYLE	GRADE
2-56 to 1-12"	Semi-Bottom (Form C)	WP49EG] All H Limits
		WP42EG]
1-1/8-8" to 2-4-1/2"	Semi-Bottom (Form C)	WP49EG
4-40 to 3/4-16	Bottom (Form E)	WP49EG
M3 x 0.50 to M12 x 1.75	Semi-Bottom (Form C)	WP49EG] 6H D Limits
		WP42EG]
		WU41EG]
		WP49EG] D11
M14 x 1.5 to M20 x 2.5	Semi-Bottom (Form C)	WP49EG
		WP42EG
M22 x 1.5 to M30 x 3.5	Semi-Bottom (Form C)	WP49EG
M3 x 0.50 to M18 x 1.5	Bottom (Form E)	WP49EG

Shank Style

ANSI, DIN, JIS, and DIN/ANSI precision ground to h9 tolerance

Grades and Grade Descriptions

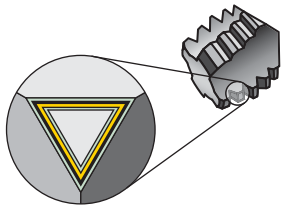

Coatings are designed for optimized tapping performance in specific materials.

P	Steel
M	Stainless Steel
K	Cast Iron
N	Non-Ferrous
S	High-Temp Alloys
H	Hardened Materials

wear resistance ← → toughness

Coating		Grade Description		05	10	15	20	25	30	35	40	45		
WP42EG		Coated HSS-E substrate with TiCN PVD layer. Use in multiple applications, including steel, stainless steel, ductile cast iron, and cast aluminum. WP42EG is more abrasion-resistant than WU41EG.	P							Blue	Blue	Blue		
			M								Yellow	Yellow	Yellow	
			K									Red	Red	Red
			N									Green	Green	Green
			S											
WU41EG		Coated HSS-E substrate with TiN PVD layer. Use in multiple applications, including steel, stainless steel, ductile cast iron, and cast aluminum.	P								Blue	Blue		
			M								Yellow	Yellow	Yellow	
			K										Red	Red
			N										Green	Green
			S											
WP49EG		HSS-E substrate with black oxide surface treatment. Use in a variety of materials, including steel, stainless steel, and ductile iron. Not recommended for non-ferrous materials.	P								Blue	Blue		
			M									Yellow	Yellow	
			K											Red
			N											
			S											

VT-SPO • Form B Plug Chamfer • Metric • DIN 371, 374, and 376

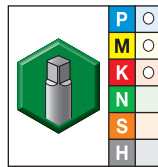
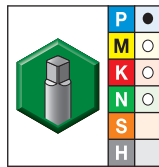
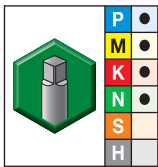
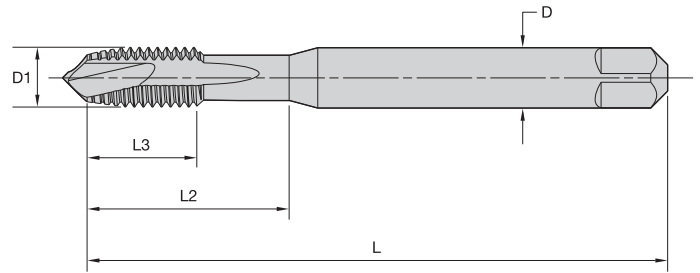

● first choice
○ alternate choice

grade WP42EG TiCN		grade WU41EG TiN		grade WP49EG Oxide		D1 size	L	L3	L2	D	number of flutes	dimension standard	class of fit
5366647	VTSP06505	5366646	VTSP06505	5366648	VTSP06505	M2 X 0,4	45	7	13	2,8	2	DIN 371	6H
-	-	-	-	5366660	VTSP06506	M2 X 0,4	45	7	13	2,8	2	DIN 371	6G
-	-	-	-	5366661	VTSP06507	M2,2 X 0,45	45	7	13	2,8	2	DIN 371	6H
-	-	5366662	VTSP06508	5366663	VTSP06508	M2,5 X 0,45	50	7	15	2,8	2	DIN 371	6H
-	-	-	-	5366665	VTSP06509	M2,5 X 0,45	50	7	15	2,8	2	DIN 371	6G
-	-	-	-	5368515	VTSP06525	M3 X 0,5	56	8	-	2,2	2	DIN 376	6H
5366667	VTSP06510	5366666	VTSP06510	5366668	VTSP06510	M3 X 0,5	56	8	18	3,5	2	DIN 371	6H
-	-	5366671	VTSP06512	5366673	VTSP06512	M3,5 X 0,6	56	9	20	4,0	2	DIN 371	6H
-	-	-	-	5368604	VTSP06546	M4 X 0,5	63	10	21	2,8	2	DIN 374	6H
-	-	-	-	5368518	VTSP06526	M4 X 0,7	63	10	21	2,8	2	DIN 376	6H
5366676	VTSP06513	5366675	VTSP06513	5366677	VTSP06513	M4 X 0,7	63	11	21	4,5	2	DIN 371	6H
-	-	-	-	5368606	VTSP06547	M5 X 0,5	70	12	25	3,5	2	DIN 374	6H
-	-	5368540	VTSP06527	5368541	VTSP06527	M5 X 0,8	70	12	25	3,5	2	DIN 376	6H
5366681	VTSP06515	5366680	VTSP06515	5366682	VTSP06515	M5 X 0,8	70	12	25	6,0	2	DIN 371	6H
-	-	-	-	5368610	VTSP06549	M6 X 0,75	80	12	30	4,5	3	DIN 374	6H
-	-	5368543	VTSP06528	5368544	VTSP06528	M6 X 1	80	12	30	4,5	3	DIN 376	6H
5366687	VTSP06517	5366686	VTSP06517	5366688	VTSP06517	M6 X 1	80	12	30	6,0	3	DIN 371	6H
-	-	-	-	5366690	VTSP06518	M6 X 1	80	12	30	6,0	3	DIN 371	6G
-	-	-	-	5368612	VTSP06550	M7 X 0,75	80	12	30	5,5	3	DIN 374	6H
5366693	VTSP06519	-	-	5366695	VTSP06519	M7 X 1	80	12	30	7,0	3	DIN 371	6H
-	-	-	-	5368614	VTSP06551	M8 X 0,75	80	12	30	6,0	3	DIN 374	6H
-	-	-	-	5368616	VTSP06552	M8 X 1	90	15	35	6,0	3	DIN 374	6H
-	-	5368546	VTSP06529	5368547	VTSP06529	M8 X 1,25	90	15	35	6,0	3	DIN 376	6H
5366700	VTSP06521	5366698	VTSP06521	5366701	VTSP06521	M8 X 1,25	90	15	35	8,0	3	DIN 371	6H
-	-	-	-	5366704	VTSP06522	M8 X 1,25	90	15	35	8,0	3	DIN 371	6G
-	-	-	-	5368618	VTSP06553	M10 X 0,75	90	15	35	7,0	3	DIN 374	6H
-	-	-	-	5368620	VTSP06554	M10 X 1	90	15	35	7,0	3	DIN 374	6H
-	-	-	-	5368622	VTSP06555	M10 X 1,25	100	18	39	7,0	3	DIN 374	6H
-	-	-	-	5366709	VTSP06524	M10 X 1,5	100	18	39	10,0	3	DIN 371	6G
5366706	VTSP06523	5366705	VTSP06523	5366707	VTSP06523	M10 X 1,5	100	18	39	10,0	3	DIN 371	6H
-	-	-	-	5368550	VTSP06530	M10 X 1,5	100	18	39	7,0	3	DIN 376	6H
-	-	-	-	5368624	VTSP06556	M11 X 1	90	15	36	8,0	3	DIN 374	6H
-	-	-	-	5368626	VTSP06557	M12 X 1	100	21	39	9,0	3	DIN 374	6H
-	-	-	-	5368628	VTSP06558	M12 X 1,25	100	21	39	9,0	3	DIN 374	6H
-	-	-	-	5368630	VTSP06559	M12 X 1,5	100	21	39	9,0	3	DIN 374	6H
-	-	-	-	5368556	VTSP06532	M12 X 1,75	110	21	44	9,0	3	DIN 376	6G
5368553	VTSP06531	5368552	VTSP06531	5368554	VTSP06531	M12 X 1,75	110	21	44	9,0	3	DIN 376	6H
-	-	-	-	5368632	VTSP06560	M14 X 1	100	21	47	11,0	3	DIN 374	6H
-	-	-	-	5368636	VTSP06562	M14 X 1,5	100	21	47	11,0	3	DIN 374	6H
5368558	VTSP06533	5368557	VTSP06533	5368559	VTSP06533	M14 X 2	110	24	52	11,0	3	DIN 376	6H
-	-	-	-	5368561	VTSP06534	M14 X 2	110	24	52	11,0	3	DIN 376	6G
-	-	-	-	5368638	VTSP06563	M16 X 1	100	21	46	12,0	3	DIN 374	6H
-	-	-	-	5368640	VTSP06564	M16 X 1,5	100	21	46	12,0	3	DIN 374	6H
5368563	VTSP06535	5368562	VTSP06535	5368565	VTSP06535	M16 X 2	110	24	51	12,0	3	DIN 376	6H
-	-	-	-	5368567	VTSP06536	M16 X 2	110	24	51	12,0	3	DIN 376	6G
-	-	-	-	5368642	VTSP06565	M18 X 1	110	21	50	14,0	3	DIN 374	6H
-	-	-	-	5368683	VTSP06566	M18 X 1,5	110	21	50	14,0	3	DIN 374	6H
-	-	-	-	5368685	VTSP06567	M18 X 2	125	30	58	14,0	3	DIN 374	6H

VT-SPO • Form B Plug Chamfer • Metric • DIN 371, 374, and 376

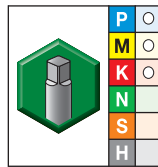
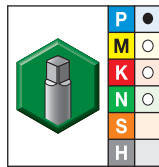
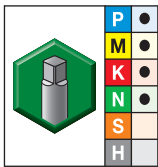
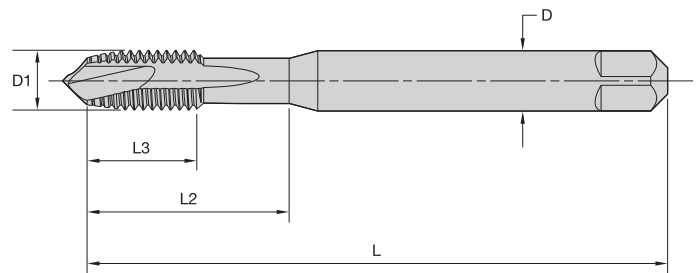

● first choice
○ alternate choice

grade WP42EG TiCN		grade WU41EG TiN		grade WP49EG Oxide		D1 size	L	L3	L2	D	number of flutes	dimension standard	class of fit
order #	catalogue #	order #	catalogue #	order #	catalogue #								
5368569	VTSP06537	5368568	VTSP06537	5368570	VTSP06537	M18 X 2,5	125	30	58	14,0	3	DIN 376	6H
-	-	-	-	5368687	VTSP06568	M20 X 1	125	24	56	16,0	3	DIN 374	6H
-	-	-	-	5368689	VTSP06569	M20 X 1,5	125	24	56	16,0	3	DIN 374	6H
-	-	-	-	5368691	VTSP06570	M20 X 2	140	30	64	16,0	3	DIN 374	6H
5368573	VTSP06538	5368572	VTSP06538	5368574	VTSP06538	M20 X 2,5	140	30	64	16,0	3	DIN 376	6H
-	-	-	-	5368693	VTSP06571	M22 X 1,5	125	24	62	18,0	3	DIN 374	6H
5368577	VTSP06539	5368576	VTSP06539	5368578	VTSP06539	M22 X 2,5	140	30	70	18,0	3	DIN 376	6H
-	-	-	-	5368696	VTSP06573	M24 X 1,5	140	28	67	18,0	3	DIN 374	6H
5368581	VTSP06540	5368580	VTSP06540	5368582	VTSP06540	M24 X 3	160	36	77	18,0	3	DIN 376	6H
-	-	5368584	VTSP06541	5368585	VTSP06541	M27 X 3	160	36	82	20,0	4	DIN 376	6H
-	-	-	-	5368588	VTSP06542	M30 X 3,5	180	42	91	22,0	4	DIN 376	6H
-	-	-	-	5368600	VTSP06543	M33 X 3,5	180	42	100	25,0	4	DIN 376	6H
-	-	-	-	5368601	VTSP06544	M36 X 4	200	48	110	28,0	4	DIN 376	6H

INDEXABLE MILLING

SOLID END MILLING

HOLEMAKING

TAPPING

TURNING

VT-SPO • Form B Plug Chamfer • Through Coolant • Metric • DIN Length ANSI Shank

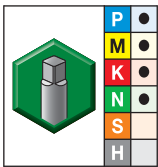
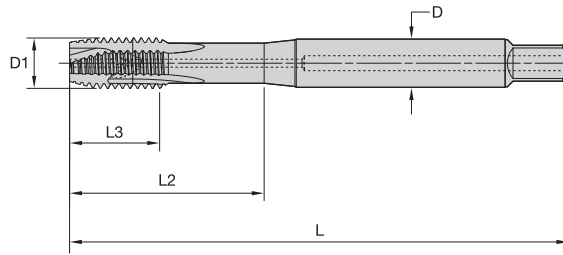

● first choice
○ alternate choice

grade WP42EG
TiCN

order #	catalogue #	D1 size	L	L3	L2	D	number of flutes	dimension standard	class of fit
5368483	VTSP09911	M12 X 1,75	4.33	.83	1.73	.367	3	DIN-ANSI	6H
5368485	VTSP09913	M14 X 2	4.33	.94	2.05	.429	3	DIN-ANSI	6H

VT-SPO • Form B Plug Chamfer • Metric • DIN Length ANSI Shank

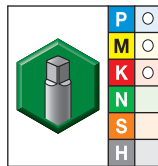
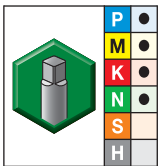
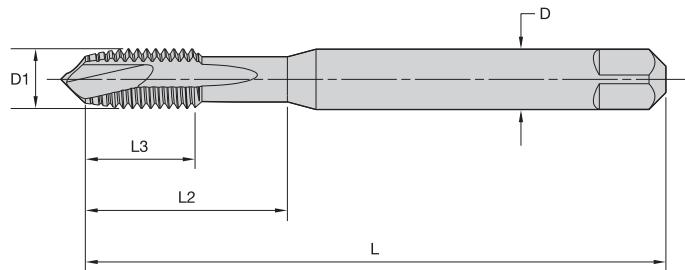

● first choice
○ alternate choice

grade WP42EG
TiCN

grade WP49EG
Oxide

order #	catalogue #	order #	catalogue #	D1 size	L	L3	L2	D	number of flutes	dimension standard	class of fit
5368174	VTSP09507	5368173	VTSP09507	M4 X 0,7	2.48	.43	.83	.168	2	DIN-ANSI	6H
5368176	VTSP09508	5368175	VTSP09508	M5 X 0,8	2.75	.47	.97	.194	2	DIN-ANSI	6H
5368178	VTSP09509	5368177	VTSP09509	M6 X 1	3.15	.47	1.18	.255	3	DIN-ANSI	6H
5368180	VTSP09510	5368179	VTSP09510	M8 X 1,25	3.54	.59	1.37	.318	3	DIN-ANSI	6H
5368184	VTSP09512	5368183	VTSP09512	M10 X 1,5	3.94	.71	1.53	.381	3	DIN-ANSI	6H
-	-	5368187	VTSP09514	M12 X 1,5	4.33	.83	1.73	.367	3	DIN-ANSI	6H
5368190	VTSP09515	5368189	VTSP09515	M12 X 1,75	4.33	.83	1.73	.367	3	DIN-ANSI	6H
5368197	VTSP09518	5368196	VTSP09518	M16 X 1,5	4.33	.94	2.01	.480	3	DIN-ANSI	6H
5368199	VTSP09519	5368198	VTSP09519	M16 X 2	4.33	.94	2.01	.480	3	DIN-ANSI	6H
-	-	5368200	VTSP09520	M18 X 1,5	4.92	1.18	2.28	.542	3	DIN-ANSI	6H
-	-	5368202	VTSP09521	M18 X 2,5	4.92	1.18	2.28	.542	3	DIN-ANSI	6H
5368207	VTSP09523	-	-	M20 X 2,5	5.51	1.18	2.52	.652	3	DIN-ANSI	6H

VT-SPO • Form B Plug Chamfer • Metric • ANSI

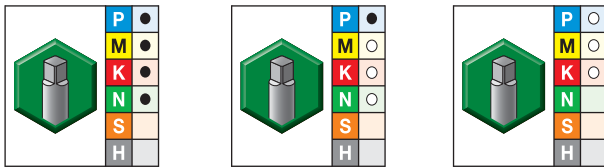
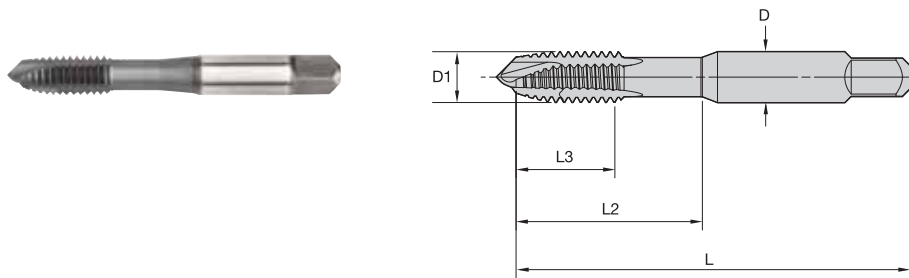

● first choice
○ alternate choice

grade WP42EG TiCN		grade WU41EG TiN		grade WP49EG Oxide		D1 size	L	L3	L2	D	number of flutes	pitch diameter limit
order #	catalogue #	order #	catalogue #	order #	catalogue #							
5362670	VTSP05505	5362671	VTSP05505	5362589	VTSP05505	M3 X 0,5	49,30	14,80	19,10	3,581	2	D3
-	-	-	-	5362673	VTSP05506	M3 X 0,5	49,30	14,80	19,10	3,581	2	D11
5631641	VTSP05613	-	-	5631640	VTSP05613	M3 X 0,5	49,30	14,80	19,10	3,581	3	D3
5631645	VTSP05614	-	-	5631644	VTSP05614	M3 X 0,5	49,30	14,80	19,10	3,581	3	D11
5362677	VTSP05507	-	-	5362676	VTSP05507	M3,5 X 0,6	50,50	9,70	18,00	3,581	2	D4
-	-	-	-	5631646	VTSP05615	M3,5 X 0,6	50,50	9,70	18,00	3,581	3	D4
-	-	-	-	5362695	VTSP05510	M4 X 0,7	53,80	9,70	19,40	4,267	2	D11
5362692	VTSP05509	5362693	VTSP05509	5362691	VTSP05509	M4 X 0,7	53,80	9,70	19,40	4,267	2	D4
5631652	VTSP05617	5631653	VTSP05617	5631651	VTSP05617	M4 X 0,7	53,80	9,70	19,40	4,267	3	D4
-	-	-	-	5631655	VTSP05618	M4 X 0,7	53,80	9,70	19,40	4,267	3	D11
5362702	VTSP05512	-	-	5362701	VTSP05512	M5 X 0,8	60,30	12,70	23,20	4,928	2	D11
5362698	VTSP05511	5362699	VTSP05511	5362697	VTSP05511	M5 X 0,8	60,30	12,70	23,20	4,928	2	D4
5631659	VTSP05619	5631670	VTSP05619	5631658	VTSP05619	M5 X 0,8	60,30	12,70	23,20	4,928	3	D4
5362704	VTSP05513	5362705	VTSP05513	5362703	VTSP05513	M6 X 1	63,50	16,00	25,40	6,477	3	D5
5362708	VTSP05514	-	-	5362707	VTSP05514	M6 X 1	63,50	16,00	25,40	6,477	3	D11
5362710	VTSP05515	-	-	5362709	VTSP05515	M7 X 1	69,20	17,50	29,30	8,077	3	D5
5362715	VTSP05517	-	-	5362714	VTSP05517	M8 X 1	68,70	17,50	28,50	8,077	3	D5
5362722	VTSP05519	5362723	VTSP05519	5362720	VTSP05519	M8 X 1,25	68,90	17,50	28,60	8,077	3	D5
5362728	VTSP05520	-	-	5362727	VTSP05520	M8 X 1,25	68,90	17,50	28,60	8,077	3	D11
5362730	VTSP05521	-	-	5362729	VTSP05521	M10 X 1	74,00	19,10	31,60	9,677	3	D5
5362733	VTSP05522	-	-	5362732	VTSP05522	M10 X 1	74,00	19,10	31,60	9,677	3	D11
-	-	-	-	5367307	VTSP05524	M10 X 1,25	74,10	18,90	31,80	9,677	3	D11
5367305	VTSP05523	-	-	5367304	VTSP05523	M10 X 1,25	74,10	18,90	31,80	9,677	3	D5
5367340	VTSP05525	5367341	VTSP05525	5367309	VTSP05525	M10 X 1,5	74,30	19,10	31,90	9,677	3	D6
5367344	VTSP05526	-	-	5367343	VTSP05526	M10 X 1,5	74,30	19,10	31,90	9,677	3	D11
5367346	VTSP05527	-	-	5367345	VTSP05527	M12 X 1,25	85,80	23,90	44,20	9,322	3	D6
-	-	-	-	5367353	VTSP05530	M12 X 1,5	85,90	23,90	44,20	9,322	3	D11
5367351	VTSP05529	-	-	5367350	VTSP05529	M12 X 1,5	85,90	23,90	44,20	9,322	3	D6
5367360	VTSP05532	-	-	-	-	M12 X 1,75	85,90	23,90	44,20	9,322	3	D11
5367356	VTSP05531	5367357	VTSP05531	5367355	VTSP05531	M12 X 1,75	85,90	23,90	44,20	9,322	3	D6
5367362	VTSP05533	-	-	5367361	VTSP05533	M14 X 1,5	91,20	25,40	44,20	10,897	3	D6
5367365	VTSP05534	-	-	5367364	VTSP05534	M14 X 2	91,20	25,40	44,20	10,897	3	D7
5366476	VTSP05535	-	-	5366475	VTSP05535	M16 X 1,5	96,80	27,70	48,00	12,192	3	D6
5366480	VTSP05536	5366481	VTSP05536	5366479	VTSP05536	M16 X 2	96,80	27,70	48,00	12,192	3	D7
5366485	VTSP05537	-	-	5366483	VTSP05537	M18 X 1,5	102,40	27,70	48,00	13,767	3	D6
5366488	VTSP05538	-	-	5366487	VTSP05538	M18 X 2,5	102,40	31,00	48,00	13,767	3	D7
5366491	VTSP05539	-	-	5366490	VTSP05539	M20 X 1,5	113,50	31,00	52,80	16,561	3	D6
5366493	VTSP05540	-	-	5366492	VTSP05540	M20 X 2,5	113,50	31,00	52,80	16,561	3	D7
-	-	-	-	5366494	VTSP05541	M22 X 1,5	119,10	31,00	58,40	17,704	3	D6
-	-	-	-	5366495	VTSP05542	M22 X 2,5	119,10	31,00	58,40	17,704	3	D7
-	-	-	-	5366496	VTSP05543	M24 X 2	124,70	31,00	58,40	19,314	3	D7
-	-	-	-	5366497	VTSP05544	M24 X 3	124,70	31,00	58,40	19,314	3	D8
-	-	-	-	5366498	VTSP05545	M27 X 1,5	130,30	31,00	63,50	22,758	4	D7
-	-	-	-	5366499	VTSP05546	M27 X 3	130,30	31,00	63,50	22,758	4	D8
-	-	-	-	5366510	VTSP05547	M30 X 1,5	138,20	31,00	65,00	25,933	4	D6
-	-	-	-	5366511	VTSP05548	M30 X 3,5	138,20	31,00	65,00	25,933	4	D9

INDEXABLE MILLING

SOLID END MILLING

HOLEMAKING

TAPPING

TURNING

VT-SPO • Form B Plug Chamfer • Metric • JIS

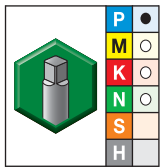
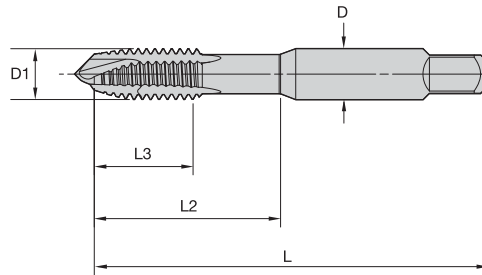

● first choice
○ alternate choice

grade WU41EG
TiN

order #	catalogue #	D1 size	L	L3	L2	D	number of flutes	dimension standard	tap class
5387865	VTSP07506	M4 X 0,7	52	13	21	5,0	2	JIS	ISO 2
5387869	VTSP07507	M5 X 0,8	60	16	24	5,5	2	JIS	ISO 2
5387873	VTSP07508	M6 X 1	62	19	29	6,0	3	JIS	ISO 2
5387877	VTSP07509	M8 X 1,25	70	22	37	6,2	3	JIS	ISO 2
5387881	VTSP07510	M10 X 1,5	75	24	41	7,0	3	JIS	ISO 2

INDEXABLE MILLING

SOLID END MILLING

HOLEMAKING

TAPPING

TURNING

VT-SFT • Form C Semi-Bottoming Chamfer • Metric • DIN Length ANSI Shank

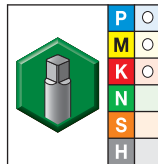
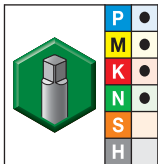
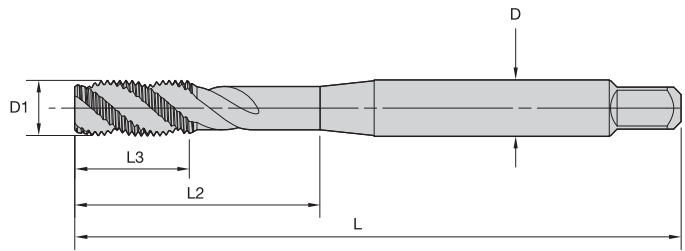

● first choice
○ alternate choice

grade WP42EG TiCN		grade WP49EG Oxide		D1 size	L	L3	L2	D	number of flutes	dimension standard	class of fit
order #	catalogue #	order #	catalogue #								
5436528	VTSFT9507	5436527	VTSFT9507	M6 X 1	3.15	.47	1.18	.255	3	DIN-ANSI	6H
5436540	VTSFT9508	-	-	M8 X 1,25	3.54	.58	1.37	.318	3	DIN-ANSI	6H
5436544	VTSFT9510	-	-	M10 X 1,5	3.94	.71	1.53	.381	3	DIN-ANSI	6H
5436546	VTSFT9511	-	-	M12 X 1,25	4.33	.83	1.73	.367	3	DIN-ANSI	6H
5436550	VTSFT9513	-	-	M12 X 1,75	4.33	.83	1.73	.367	3	DIN-ANSI	6H

NOTE: Suggested for use in rigid and synchronous holders.

VT-SFT • Form C Semi-Bottoming Chamfer • Metric • JIS

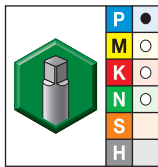
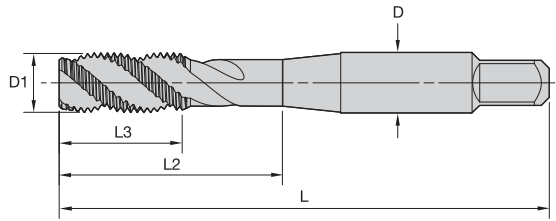

grade WU41EG
TiN

- first choice
- alternate choice

order #	catalogue #	D1 size	L	L3	L2	D	number of flutes	dimension standard	tap class
5398791	VTSFT7506	M4 X 0,7	52	13	21	5,0	3	JIS	ISO 2
5398793	VTSFT7507	M5 X 0,8	60	16	24	5,5	3	JIS	ISO 2
5398795	VTSFT7508	M6 X 1	62	19	29	6,0	3	JIS	ISO 2
5398797	VTSFT7509	M8 X 1,25	70	22	37	6,2	3	JIS	ISO 2

NOTE: Suggested for use in rigid and synchronous holders.

VT-SFT • Form C Semi-Bottoming Chamfer • Through Coolant • Metric • DIN Length ANSI Shank

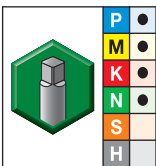
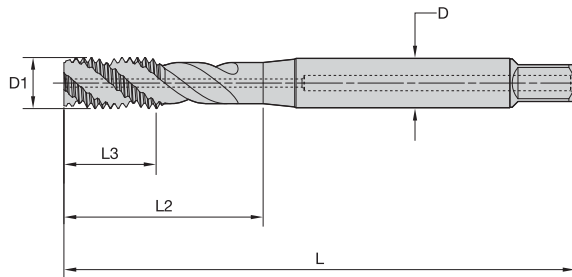

grade WP42EG
TiCN

- first choice
- alternate choice

order #	catalogue #	D1 size	L	L3	L2	D	number of flutes	dimension standard	class of fit
5436475	VTSFT9925	M6 X 1	3.15	.47	1.18	.255	3	DIN-ANSI	6H
5436476	VTSFT9926	M8 X 1,25	3.54	.59	1.38	.318	3	DIN-ANSI	6H
5436478	VTSFT9928	M10 X 1,5	3.94	.71	1.53	.381	3	DIN-ANSI	6H
5436481	VTSFT9931	M12 X 1,75	4.33	.83	1.73	.367	3	DIN-ANSI	6H

NOTE: Suggested for use in rigid and synchronous holders.

VT-SFT • Form C Semi-Bottoming Chamfer • Metric • DIN 371, 374, and 376

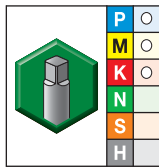
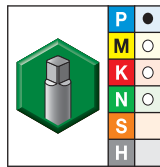
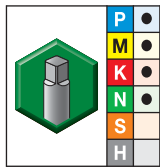
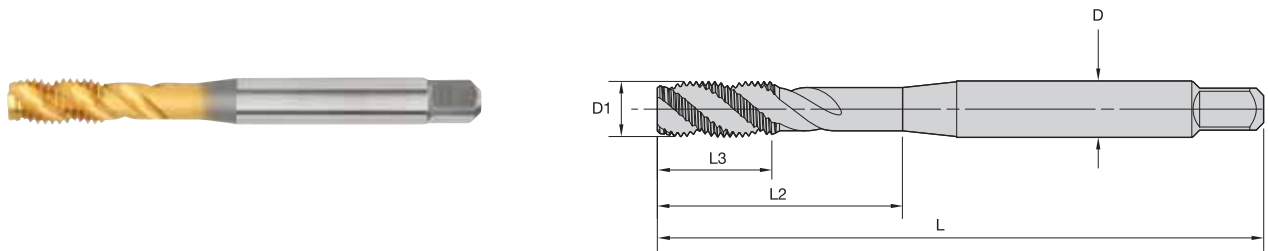

● first choice
○ alternate choice

grade WP42EG TiCN		grade WU41EG TiN		grade WP49EG Oxide		D1 size	L	L3	L2	D	number of flutes	dimension standard	class of fit
5368703	VTSFT6506	-	-	5368704	VTSFT6506	M2 X 0,4	45	7	13	2,8	2	DIN 371	6H
-	-	-	-	5368707	VTSFT6508	M2,2 X 0,45	45	7	13	2,8	2	DIN 371	6H
-	-	5368708	VTSFT6509	5368709	VTSFT6509	M2,5 X 0,45	50	7	15	2,8	2	DIN 371	6H
-	-	-	-	5368726	VTSFT6512	M3 X 0,5	56	8	18	3,5	2	DIN 371	6G
5368723	VTSFT6511	-	-	5368724	VTSFT6511	M3 X 0,5	56	8	18	3,5	2	DIN 371	6H
-	-	-	-	5402139	VTSFT6546	M4 X 0,5	63	10	21	2,8	3	DIN 374	6H
-	-	-	-	5402229	VTSFT6526	M4 X 0,7	63	10	21	2,8	3	DIN 376	6H
5368731	VTSFT6514	-	-	5368732	VTSFT6514	M4 X 0,7	63	11	21	4,5	3	DIN 371	6H
-	-	-	-	5368734	VTSFT6515	M4 X 0,7	63	11	21	4,5	3	DIN 371	6G
-	-	-	-	5402181	VTSFT6547	M5 X 0,5	70	12	25	3,5	3	DIN 374	6H
5368736	VTSFT6516	-	-	5368737	VTSFT6516	M5 X 0,8	70	12	25	6,0	3	DIN 371	6H
-	-	-	-	5402251	VTSFT6527	M5 X 0,8	70	12	25	3,5	3	DIN 376	6H
-	-	-	-	5368739	VTSFT6517	M5 X 0,8	70	12	25	6,0	3	DIN 371	6G
-	-	-	-	5402185	VTSFT6549	M6 X 0,75	80	12	30	4,5	3	DIN 374	6H
-	-	-	-	5402253	VTSFT6528	M6 X 1	80	12	30	4,5	3	DIN 376	6H
5368741	VTSFT6518	-	-	5368742	VTSFT6518	M6 X 1	80	12	30	6,0	3	DIN 371	6H
-	-	-	-	5368745	VTSFT6520	M7 X 1	80	12	30	7,0	3	DIN 371	6H
-	-	-	-	5402186	VTSFT6550	M8 X 0,75	80	12	30	6,0	3	DIN 374	6H
5402188	VTSFT6551	-	-	5402189	VTSFT6551	M8 X 1	90	15	35	6,0	3	DIN 374	6H
-	-	-	-	5368752	VTSFT6522	M8 X 1,25	90	15	35	8,0	3	DIN 371	6G
5368749	VTSFT6521	5368748	VTSFT6521	5368750	VTSFT6521	M8 X 1,25	90	15	35	8,0	3	DIN 371	6H
-	-	-	-	5402192	VTSFT6553	M10 X 1	90	15	35	7,0	3	DIN 374	6H
5402194	VTSFT6554	-	-	5402195	VTSFT6554	M10 X 1,25	100	18	39	7,0	3	DIN 374	6H
5368754	VTSFT6523	5368753	VTSFT6523	5402207	VTSFT6560	M10 X 1,5	100	18	39	10,0	3	DIN 371	6H
-	-	-	-	5402197	VTSFT6555	M12 X 1	100	21	39	9,0	3	DIN 374	6H
-	-	-	-	5402199	VTSFT6556	M12 X 1,25	100	21	39	9,0	3	DIN 374	6H
5402201	VTSFT6557	-	-	5402202	VTSFT6557	M12 X 1,5	100	21	39	9,0	3	DIN 374	6H
-	-	-	-	5402263	VTSFT6532	M12 X 1,75	110	21	44	9,0	3	DIN 376	6G
5402260	VTSFT6531	5402259	VTSFT6531	5402261	VTSFT6531	M12 X 1,75	110	21	44	9,0	3	DIN 376	6H
5402206	VTSFT6560	-	-	5402207	VTSFT6560	M14 X 1,5	100	21	47	11,0	3	DIN 374	6H
5402265	VTSFT6533	5402264	VTSFT6533	5402266	VTSFT6533	M14 X 2	110	24	52	11,0	3	DIN 376	6H
-	-	-	-	5402210	VTSFT6562	M16 X 1,5	100	21	46	12,0	3	DIN 374	6H
-	-	5402269	VTSFT6535	5402270	VTSFT6535	M16 X 2	110	24	51	12,0	3	DIN 376	6H
-	-	-	-	5402214	VTSFT6564	M18 X 1,5	110	21	50	14,0	4	DIN 374	6H
-	-	-	-	5402217	VTSFT6567	M20 X 1,5	125	24	56	16,0	4	DIN 374	6H
-	-	-	-	5402277	VTSFT6538	M20 X 2,5	140	30	64	16,0	4	DIN 376	6H
-	-	-	-	5402223	VTSFT6571	M24 X 1,5	140	28	67	18,0	4	DIN 374	6H
-	-	-	-	5402283	VTSFT6540	M24 X 3	160	36	77	18,0	4	DIN 376	6H
-	-	-	-	5402286	VTSFT6541	M27 X 3	160	36	82	20,0	4	DIN 376	6H
-	-	-	-	5402289	VTSFT6542	M30 X 3,5	180	42	91	22,0	4	DIN 376	6H
-	-	-	-	5402291	VTSFT6543	M33 X 3,5	180	42	100	25,0	4	DIN 376	6H
-	-	-	-	5402293	VTSFT6544	M36 X 4	200	48	110	28,0	5	DIN 376	6H

NOTE: Suggested for use in rigid and synchronous holders.

VT-SFT • Form E Bottoming Chamfer • Metric • ANSI

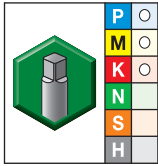
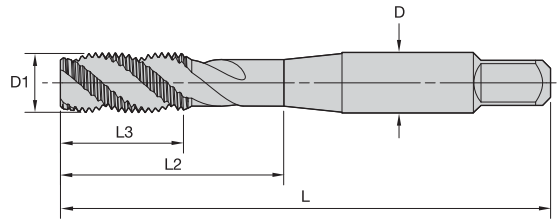

- first choice
- alternate choice

grade WP49EG
Oxide

order #	catalogue #	D1 size	L	L3	L2	D	number of flutes	pitch diameter limit
5400155	VTSFT5550	M3 X 0,5	1.94	.58	.75	.141	2	D3
5400157	VTSFT5552	M4 X 0,7	2.13	.38	.76	.168	3	D4
5400158	VTSFT5553	M5 X 0,8	2.38	.50	.91	.194	3	D4
5400159	VTSFT5554	M6 X 1	2.50	.63	1.00	.255	3	D5
5400231	VTSFT5556	M8 X 1,25	2.72	.69	1.12	.318	3	D5
5400233	VTSFT5558	M10 X 1,5	2.94	.75	1.26	.381	3	D6
5400235	VTSFT5560	M12 X 1,75	3.38	.94	1.74	.367	3	D6
5400239	VTSFT5564	M14 X 1,5	3.59	1.00	1.74	.429	3	D6
5400241	VTSFT5566	M16 X 1,5	3.81	1.09	1.89	.480	3	D6
5400240	VTSFT5565	M16 X 2	3.81	1.09	1.89	.480	3	D7

NOTE: Refer to tables on pages D32 for the recommended pitch diameter limit for 6H class of fit.
VariTap for 6H class of fit is suitable for MJ aerospace internal threading applications.

INDEXABLE MILLING

SOLID END MILLING

HOLEMAKING

TAPPING

TURNING

VT-SFT TC • Form C Semi-Bottoming Chamfer • Metric • ANSI • Tension/Compression Holders

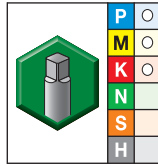
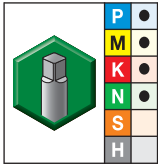
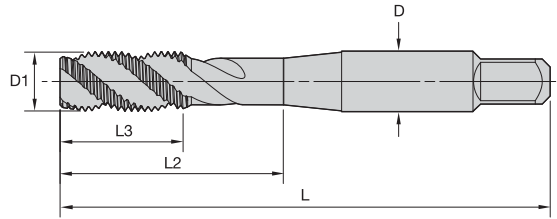

● first choice
○ alternate choice

grade WP42EG TiCN		grade WP49EG Oxide		D1	L	L3	L2	D	number of flutes	pitch diameter limit
order #	catalogue #	order #	catalogue #							
5887085	VTSFT-TC5505	5887084	VTSFT-TC5505	M3 X 0,5	49,40	14,80	19,30	3,581	3	D3
6141630	VTSFT-TC5507	6141781	VTSFT-TC5507	M3,5 X 0,6	50,50	9,70	18,00	3,582	2	D4
5887087	VTSFT-TC5509	5887086	VTSFT-TC5509	M4 X 0,7	53,80	9,70	19,40	4,267	3	D4
5887089	VTSFT-TC5511	5887088	VTSFT-TC5511	M5 X 0,8	60,30	12,70	23,20	4,928	3	D4
5887091	VTSFT-TC5513	5887090	VTSFT-TC5513	M6 X 1	63,50	16,00	25,50	6,477	3	D5
-	-	6141790	VTSFT-TC5514	M6 X 1	63,50	16,00	25,50	6,477	3	D11
-	-	6141792	VTSFT-TC5515	M7 X 1	69,20	17,50	29,30	8,077	3	D5
6141796	VTSFT-TC5517	6141797	VTSFT-TC5517	M8 X 1	68,70	17,50	28,50	8,077	3	D5
-	-	6141799	VTSFT-TC5518	M8 X 1	68,70	17,50	28,50	8,077	3	D11
5887093	VTSFT-TC5519	5887092	VTSFT-TC5519	M8 X 1,25	68,70	17,50	28,50	8,077	3	D5
-	-	6141801	VTSFT-TC5520	M8 X 1,25	68,70	17,50	28,50	8,077	3	D11
-	-	6141803	VTSFT-TC5522	M10 X 1	73,90	18,70	31,60	9,678	3	D11
-	-	6141805	VTSFT-TC5523	M10 X 1,25	74,10	18,90	31,80	9,678	3	D5
6141808	VTSFT-TC5525	6141809	VTSFT-TC5525	M10 X 1,5	74,30	19,00	31,90	9,678	3	D6
-	-	6141811	VTSFT-TC5526	M10 X 1,5	74,20	19,00	31,60	9,678	3	D11
-	-	6140508	VTSFT-TC5527	M12 X 1,25	85,90	23,90	44,20	9,322	3	D5
-	-	6140512	VTSFT-TC5529	M12 X 1,5	85,90	23,90	44,20	9,322	3	D6
5887097	VTSFT-TC5531	5887096	VTSFT-TC5531	M12 X 1,75	85,90	23,90	44,20	9,322	3	D6
6140515	VTSFT-TC5532	6140516	VTSFT-TC5532	M12 X 1,75	85,90	23,90	44,20	9,322	3	D11
-	-	6140518	VTSFT-TC5533	M14 X 1,5	91,20	25,40	44,20	10,897	3	D6
-	-	6140520	VTSFT-TC5535	M14 X 2	91,20	25,40	44,20	10,897	3	D7
6140521	VTSFT-TC5536	6140522	VTSFT-TC5536	M16 X 1,5	96,80	27,70	48,00	12,192	3	D6
5887099	VTSFT-TC5537	5887098	VTSFT-TC5537	M16 X 2	96,80	27,70	48,00	12,192	3	D7
6140523	VTSFT-TC5538	6140524	VTSFT-TC5538	M18 X 1,5	102,40	27,70	48,00	13,767	4	D6
6140525	VTSFT-TC5539	6140526	VTSFT-TC5539	M18 X 2,5	102,40	31,00	48,00	13,767	4	D7
6140527	VTSFT-TC5540	6140528	VTSFT-TC5540	M20 X 1,5	113,50	31,00	52,80	16,561	4	D6
6140529	VTSFT-TC5541	6140530	VTSFT-TC5541	M20 X 2,5	113,50	34,00	58,40	16,561	4	D7
-	-	6140531	VTSFT-TC5542	M22 X 1,5	119,10	34,00	58,40	17,704	4	D6
-	-	6140532	VTSFT-TC5543	M22 X 2,5	119,10	34,00	58,40	17,704	4	D7
-	-	6140533	VTSFT-TC5544	M24 X 1,5	124,70	34,00	58,40	19,304	4	D6
-	-	6140534	VTSFT-TC5545	M24 X 3	124,70	34,00	58,40	19,304	4	D8
-	-	6140535	VTSFT-TC5546	M27 X 1,5	130,30	38,10	63,50	22,758	4	D7
-	-	6140536	VTSFT-TC5547	M27 X 3	130,30	38,10	63,50	22,758	4	D8
-	-	6140537	VTSFT-TC5548	M30 X 1,5	138,20	43,50	65,00	25,933	4	D6
-	-	6140538	VTSFT-TC5549	M30 X 3,5	138,20	43,50	65,00	25,933	4	D9

INDEXABLE MILLING

SOLID END MILLING

HOLEMAKING

TAPPING

TURNING

VT-SFT TC • Form C Semi-Bottoming Chamfer • Metric • DIN 371, 374, and 376 • Tension/Compression Holders

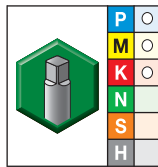
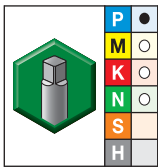
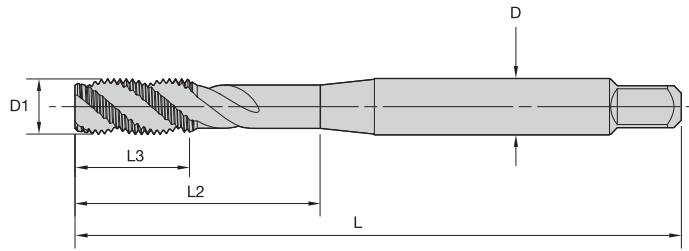

● first choice
○ alternate choice

grade WU41EG TiN		grade WP49EG Oxide		D1 size	L	L3	L2	D	number of flutes	dimension standard	class of fit
order #	catalogue #	order #	catalogue #								
6172434	VTSFT-TC6506	6172432	VTSFT-TC6506	M2 X 0,4	45	7	13	2,8	3	DIN 371	6H
6172438	VTSFT-TC6508	6172436	VTSFT-TC6508	M3 X 0,5	56	5	19	3,5	3	DIN 371	6H
6172442	VTSFT-TC6510	6172440	VTSFT-TC6510	M4 X 0,7	63	7	21	4,5	3	DIN 371	6H
6172446	VTSFT-TC6511	6172444	VTSFT-TC6511	M5 X 0,8	70	8	26	6,0	3	DIN 371	6H
6172450	VTSFT-TC6512	6172448	VTSFT-TC6512	M5 X 0,8	70	8	27	3,5	3	DIN 376	6H
6172464	VTSFT-TC6513	-	-	M6 X 0,75	80	10	34	4,5	3	DIN 374	6H
6172468	VTSFT-TC6514	6172466	VTSFT-TC6514	M6 X 1	80	10	30	6,0	3	DIN 371	6H
6172470	VTSFT-TC6515	6172469	VTSFT-TC6515	M6 X 1	80	10	34	4,5	3	DIN 376	6H
6172482	VTSFT-TC6516	6172481	VTSFT-TC6516	M8 X 0,75	90	13	37	6,0	3	DIN 374	6H
6172484	VTSFT-TC6517	6172483	VTSFT-TC6517	M8 X 1	90	13	37	6,0	3	DIN 374	6H
6172486	VTSFT-TC6518	6172485	VTSFT-TC6518	M8 X 1,25	90	13	37	8,0	3	DIN 371	6H
6172488	VTSFT-TC6519	6172487	VTSFT-TC6519	M8 X 1,25	90	13	37	6,0	3	DIN 376	6H
6172490	VTSFT-TC6520	6172489	VTSFT-TC6520	M10 X 0,75	90	15	40	7,0	3	DIN 374	6H
6172492	VTSFT-TC6540	6172491	VTSFT-TC6540	M10 X 1	90	15	40	7,0	3	DIN 374	6H
6172494	VTSFT-TC6522	6172493	VTSFT-TC6522	M10 X 1,25	100	15	44	7,0	3	DIN 374	6H
6172496	VTSFT-TC6550	6172495	VTSFT-TC6550	M10 X 1,5	100	15	41	10,0	3	DIN 371	6H
6172498	VTSFT-TC6524	6172497	VTSFT-TC6524	M10 X 1,5	100	15	44	7,0	3	DIN 376	6H
6172500	VTSFT-TC6525	6172499	VTSFT-TC6525	M12 X 1	100	13	50	9,0	3	DIN 374	6H
6172502	VTSFT-TC6526	6172501	VTSFT-TC6526	M12 X 1,25	100	13	50	9,0	3	DIN 374	6H
6172504	VTSFT-TC6527	6172503	VTSFT-TC6527	M12 X 1,5	100	13	50	9,0	3	DIN 374	6H
6172506	VTSFT-TC6528	6172505	VTSFT-TC6528	M12 X 1,75	110	18	55	9,0	3	DIN 376	6H
6172508	VTSFT-TC6529	6172507	VTSFT-TC6529	M14 X 1	100	15	41	11,0	4	DIN 374	6H
6172510	VTSFT-TC6530	6172509	VTSFT-TC6530	M14 X 1,25	100	15	41	11,0	4	DIN 374	6H
6172512	VTSFT-TC6536	6172511	VTSFT-TC6536	M14 X 1,5	100	15	41	11,0	4	DIN 374	6H
6172672	VTSFT-TC6532	6172671	VTSFT-TC6532	M14 X 2	110	20	50	11,0	3	DIN 376	6H
6172674	VTSFT-TC6534	6172673	VTSFT-TC6534	M16 X 1,5	100	15	45	12,0	4	DIN 374	6H
6172676	VTSFT-TC6564	6172675	VTSFT-TC6564	M16 X 2	110	20	55	12,0	4	DIN 376	6H
6172678	VTSFT-TC6537	6172677	VTSFT-TC6537	M18 X 1,5	110	17	55	14,0	4	DIN 374	6H
6172680	VTSFT-TC6538	6172679	VTSFT-TC6538	M18 X 2	125	25	61	14,0	4	DIN 374	6H
6172692	VTSFT-TC6539	6172691	VTSFT-TC6539	M18 X 2,5	125	25	61	14,0	4	DIN 376	6H
6172694	VTSFT-TC6541	6172693	VTSFT-TC6541	M20 X 1,5	125	17	56	16,0	4	DIN 374	6H
6172698	VTSFT-TC6543	6172697	VTSFT-TC6543	M20 X 2,5	140	25	65	16,0	4	DIN 376	6H
6172700	VTSFT-TC6544	6172699	VTSFT-TC6544	M22 X 1,5	125	18	61	18,0	4	DIN 374	6H
6172712	VTSFT-TC6545	6172711	VTSFT-TC6545	M22 X 2	140	25	66	18,0	4	DIN 374	6H
6172714	VTSFT-TC6546	6172713	VTSFT-TC6546	M22 X 2,5	140	25	66	18,0	4	DIN 376	6H
6172716	VTSFT-TC6547	6172715	VTSFT-TC6547	M24 X 1,5	140	20	67	18,0	4	DIN 374	6H
6172718	VTSFT-TC6548	6172717	VTSFT-TC6548	M24 X 2	140	20	67	18,0	4	DIN 374	6H
6172720	VTSFT-TC6549	6172719	VTSFT-TC6549	M24 X 3	160	30	77	18,0	4	DIN 376	6H
6172722	VTSFT-TC6551	6172721	VTSFT-TC6551	M27 X 1,5	140	20	65	20,0	4	DIN 374	6H
6172724	VTSFT-TC6552	6172723	VTSFT-TC6552	M27 X 3	160	33	85	20,0	4	DIN 376	6H
6172726	VTSFT-TC6554	6172725	VTSFT-TC6554	M30 X 1,5	150	22	68	20,0	4	DIN 374	6H
6172728	VTSFT-TC6555	6172727	VTSFT-TC6555	M30 X 2	150	22	68	22,0	4	DIN 374	6H
6172730	VTSFT-TC6556	6172729	VTSFT-TC6556	M30 X 3,5	180	35	87	22,0	4	DIN 376	6H
6172732	VTSFT-TC6558	-	-	M33 X 3,5	180	35	92	25,0	4	DIN 376	6H
6172734	VTSFT-TC6560	6172733	VTSFT-TC6560	M36 X 4	200	40	110	28,0	4	DIN 376	6H
6172736	VTSFT-TC6563	6172735	VTSFT-TC6563	M39 X 4	200	40	105	32,0	4	DIN 376	6H
6172738	VTSFT-TC6565	6172737	VTSFT-TC6565	M42 X 4,5	200	40	105	32,0	5	DIN 376	6H
6172740	VTSFT-TC6567	6172739	VTSFT-TC6567	M45 X 5	220	50	110	36,0	5	DIN 376	6H
6172742	VTSFT-TC6569	6172741	VTSFT-TC6569	M48 X 5	250	50	145	36,0	5	DIN 376	6H
6172744	VTSFT-TC6571	6172743	VTSFT-TC6571	M52 X 5	250	50	135	40,0	5	DIN 376	6H

VT-SFT TC • Form E Bottoming Chamfer • Metric • ANSI • Tension/Compression Holders

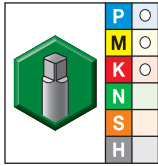
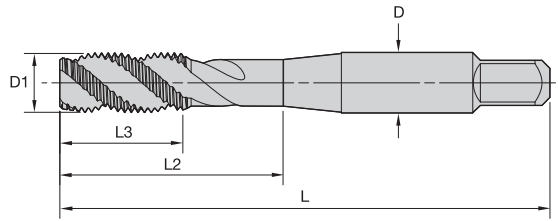

● first choice
○ alternate choice

grade WP49EG
Oxide

order #	catalogue #	D1 TPI	L	L3	L2	D	number of flutes	pitch diameter limit
6140343	VTSFT-TC5550	M3 X 0,5	49,30	14,80	19,10	3,582	2	D3
6140344	VTSFT-TC5551	M3,5 X 0,6	50,80	9,70	—	3,582	2	D4
6140345	VTSFT-TC5552	M4 X 0,7	54,10	9,70	19,40	4,267	3	D4
6140346	VTSFT-TC5553	M5 X 0,8	60,50	12,70	23,20	4,928	3	D4
6140347	VTSFT-TC5554	M6 X 1	63,50	16,00	25,50	6,477	3	D5
6140348	VTSFT-TC5555	M7 X 1	69,10	17,50	—	8,077	3	D5
6140349	VTSFT-TC5556	M8 X 1,25	69,10	17,50	28,50	8,077	3	D5
6140350	VTSFT-TC5557	M8 X 1	69,10	17,50	28,50	8,077	3	D5
6140391	VTSFT-TC5558	M10 X 1,5	74,70	19,10	31,90	9,678	3	D6
6140392	VTSFT-TC5559	M10 X 1,25	74,70	19,10	31,90	9,677	3	D5
6140393	VTSFT-TC5560	M12 X 1,75	85,90	23,90	—	9,322	3	D6
6140394	VTSFT-TC5561	M12 X 1,5	85,90	23,90	44,20	9,322	3	D5
6140395	VTSFT-TC5562	M12 X 1,25	85,90	23,90	44,20	9,322	3	D5
6140396	VTSFT-TC5563	M14 X 2	91,20	25,40	44,20	10,897	3	D7
6140397	VTSFT-TC5564	M14 X 1,5	91,20	25,40	44,20	10,897	3	D6
6140398	VTSFT-TC5565	M16 X 2	96,80	27,70	48,00	12,192	3	D7
6140399	VTSFT-TC5566	M16 X 1,5	96,80	27,70	48,00	12,192	3	D6

INDEXABLE MILLING

SOLID END MILLING

HOLEMAKING

TAPPING

TURNING

VT-SFT • Form E Bottoming Chamfer • Metric • DIN 371, 374, and 376

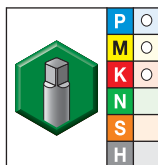
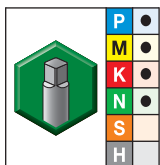
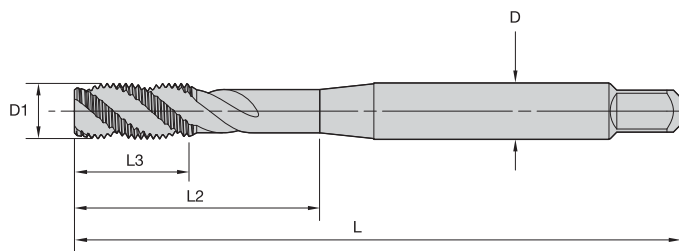

● first choice
○ alternate choice

grade WP42EG TiCN		grade WP49EG Oxide		D1 size	L	L3	L2	D	number of flutes	dimension standard	class of fit
5387434	VTSFT6574	5387435	VTSFT6574	M3 X 0,5	56	8	18	3,5	2	DIN 371	6H
5387436	VTSFT6575	-	-	M4 X 0,7	63	11	21	4,5	3	DIN 371	6H
5387438	VTSFT6576	5387439	VTSFT6576	M5 X 0,8	70	12	25	6,0	3	DIN 371	6H
5387460	VTSFT6577	-	-	M6 X 1	80	12	30	6,0	3	DIN 371	6H
5387462	VTSFT6578	5387463	VTSFT6578	M8 X 1,25	90	15	35	8,0	3	DIN 371	6H
5387464	VTSFT6579	5387465	VTSFT6579	M10 X 1,5	100	18	39	10,0	3	DIN 371	6H
5387479	VTSFT6587	-	-	M12 X 1,5	100	21	39	9,0	3	DIN 374	6H
5387466	VTSFT6580	5387467	VTSFT6580	M12 X 1,75	110	21	44	9,0	3	DIN 376	6H
-	-	5387483	VTSFT6588	M14 X 1,5	100	21	47	11,0	3	DIN 374	6H
-	-	5387469	VTSFT6581	M14 X 2	110	24	52	11,0	3	DIN 376	6H
-	-	5387470	VTSFT6582	M16 X 2	110	24	51	12,0	3	DIN 376	6H
5387473	VTSFT6584	5387474	VTSFT6584	M20 X 2,5	140	30	64	16,0	4	DIN 376	6H

NOTE: Suggested for use in rigid and synchronous holders.

INDEXABLE MILLING

SOLID END MILLING

HOLEMAKING

TAPPING

TURNING

VT-SFT • Form C Semi-Bottoming Chamfer • Metric • ANSI

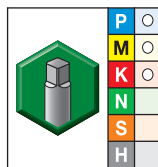
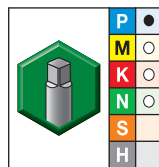
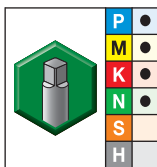
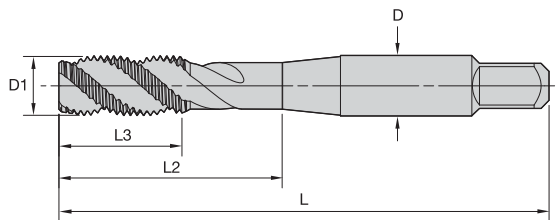

● first choice
○ alternate choice

grade WP42EG TiCN		grade WU41EG TiN		grade WP49EG Oxide		D1 size	L	L3	L2	D	number of flutes	pitch diameter limit
order #	catalogue #	order #	catalogue #	order #	catalogue #							
5357039	VTSFT5507	-	-	5357031	VTSFT5505	M3 X 0,5	49,20	14,80	19,10	3,581	2	D3
-	-	5357056	VTSFT5509	5357054	VTSFT5509	M3,5 X 0,6	50,50	9,70	18,00	3,581	2	D4
-	-	-	-	5357060	VTSFT5511	M4 X 0,7	53,80	9,70	19,40	4,267	3	D4
5357066	VTSFT5512	-	-	-	-	M5 X 0,8	60,30	12,70	23,20	4,928	3	D4
-	-	5357069	VTSFT5513	5357067	VTSFT5513	M5 X 0,8	60,30	12,70	23,20	4,928	3	D11
5357083	VTSFT5514	-	-	-	-	M6 X 1	63,50	16,00	25,50	6,477	3	D5
-	-	-	-	5357084	VTSFT5515	M6 X 1	63,50	16,00	25,50	6,477	3	D11
5357101	VTSFT5517	5357102	VTSFT5517	5357100	VTSFT5517	M7 X 1	69,20	17,50	29,30	8,077	3	D5
-	-	-	-	5357106	VTSFT5519	M8 X 1	68,70	17,50	28,50	8,077	3	D5
5357123	VTSFT5520	-	-	5357121	VTSFT5520	M8 X 1,25	68,70	17,50	28,50	8,077	3	D5
5365567	VTSFT5521	-	-	5365566	VTSFT5521	M8 X 1,25	68,70	17,50	28,50	8,077	3	D5
5365590	VTSFT5522	-	-	-	-	M10 X 1	73,90	18,70	31,60	9,677	3	D11
5365592	VTSFT5523	-	-	5365591	VTSFT5523	M10 X 1,25	74,10	18,90	31,80	9,677	3	D5
5365598	VTSFT5525	-	-	5365597	VTSFT5525	M10 X 1,25	74,10	18,90	31,80	9,677	3	D5
5365612	VTSFT5526	-	-	-	-	M10 X 1,5	74,20	19,00	31,90	9,677	3	D6
5365614	VTSFT5527	-	-	5365613	VTSFT5527	M10 X 1,5	74,20	19,00	31,90	9,677	3	D11
5365621	VTSFT5529	-	-	-	-	M12 X 1,25	85,90	23,90	44,20	9,322	3	D6
5365624	VTSFT5530	-	-	5365625	VTSFT5531	M12 X 1,5	85,90	23,90	44,20	9,322	3	D6
-	-	-	-	5365629	VTSFT5532	M12 X 1,75	85,90	23,90	44,20	9,322	3	D11
-	-	-	-	5365635	VTSFT5535	M12 X 1,75	85,90	23,90	44,20	9,322	3	D7
-	-	-	-	5365637	VTSFT5536	M14 X 2	91,20	25,40	44,20	10,897	3	D6
-	-	-	-	5365640	VTSFT5537	M16 X 1,5	96,80	27,70	48,00	12,192	3	D7
5365650	VTSFT5540	-	-	5365651	VTSFT5541	M16 X 2	96,80	27,70	48,00	12,192	3	D7
-	-	-	-	5365656	VTSFT5545	M20 X 1,5	113,50	31,00	52,80	16,561	4	D6
-	-	-	-	5365660	VTSFT5549	M20 X 2,5	113,50	31,00	52,80	16,561	4	D7
-	-	-	-	-	-	M24 X 3	124,70	34,00	58,40	19,304	4	D8
-	-	-	-	-	-	M30 X 3,5	138,20	43,50	65,00	25,933	4	D9

NOTE: Refer to tables on pages D32 for the recommended pitch diameter limit for 6H class of fit. VariTap for 6H class of fit is suitable for MJ aerospace internal threading applications.

INDEXABLE MILLING

SOLID END MILLING

HOLEMAKING

TAPPING

TURNING

VT-STR • NPT • Standard Chamfer • Pipe Taps

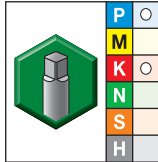
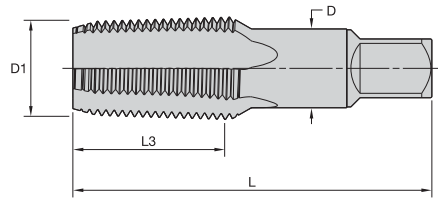

grade WU40EG
Bright

- first choice
- alternate choice

order #	catalogue #	D1 TPI	number of flutes	thread type
5629646	VTSTR8001	1/8 - 27	4	NPT
5629647	VTSTR8002	1/4 - 18	4	NPT
5629648	VTSTR8003	3/8 - 18	4	NPT
5629649	VTSTR8004	1/2 - 14	4	NPT
5629904	VTSTR8005	3/4 - 14	5	NPT

INDEXABLE MILLING



SOLID END MILLING

HOLEMAKING

TAPPING

TURNING

Application Data • VariTap • HSS-E • Metric

Material Group		 Through Holes					 Blind Holes				
				Range – m/min					Range – m/min		
		Tap Style	Grade	min	Starting Value	max	Tap Style	Grade	min	Starting Value	max
P	P1	VT-SPO	WP42EG, WU41EG	21	27	34	VT-SFT	WP42EG, WU41EG	13	18	26
		VT-SPO	WP49EG	10	14	17	VT-SFT	WP49EG	6	9	13
	P2	VT-SPO	WP42EG, WU41EG	16	21	27	VT-SFT	WP42EG, WU41EG	11	15	22
		VT-SPO	WP49EG	8	11	13	VT-SFT	WP49EG	4	6	9
	P3	VT-SPO	WP42EG, WU41EG	9	12	15	VT-SFT	WP42EG, WU41EG	6	9	13
		VT-SPO	WP49EG	5	6	8	VT-SFT	WP49EG	2	3	4
		VT-STR NPT	WU41EG	5	6	8	VT-STR NPT	WU41EG	5	6	8
M	M1	VT-SPO	WP42EG, WU41EG	9	12	15	VT-SFT	WP42EG, WU41EG	6	9	13
		VT-SPO	WP49EG	5	6	8	VT-SFT	WP49EG	2	3	4
		VT-SFT NPT	WU41EG	5	6	8	VT-SFT NPT	WU41EG	5	6	8
		VT-SFT NPT	WP49EG	2	3	4	VT-SFT NPT	WP49EG	2	3	4
	M3	VT-SPO	WP42EG, WU41EG	7	9	11	VT-SFT	WP42EG, WU41EG	4	6	9
		VT-SPO	WP49EG	3	5	6	VT-SFT	WP49EG	2	3	4
K	K1	VT-STR NPT	WU41EG	10	14	17	VT-STR NPT	WU41EG	10	14	17
	K2	VT-SPO	WP42EG, WU41EG	21	27	34	VT-SFT	WP42EG, WU41EG	13	18	26
N	N1	VT-SPO	WP49EG	10	14	17	VT-SFT	WP49EG	6	9	13
		VT-SPO	WP42EG, WU41EG	34	46	57	VT-SFT	WP42EG, WU41EG	23	34	48
	N2	VT-SPO	WP42EG, WU41EG	30	40	50	VT-SFT	WP42EG, WU41EG	19	27	39
	N4	VT-SPO	WP42EG, WU41EG	7	9	11	VT-SFT	WP42EG, WU41EG	4	6	9

* Grades: WP42EG = TiCN
 WU41EG = TiN
 WP49EG = oxide

WIDIA™ TAP/DRILL COMBINATIONS:

VariDrill™ /VariTap™

MATERIALS



VERSATILE:

VariDrill™ drilling tools, in combination with VariTap™ tapping tools, are designed for productivity in an array of different materials. These tools feature strong geometries that are ideal for small-batch and varied production.

For more than 95 years, WIDIA has defined excellence in innovation, technology, and customer service. As an industry-leading manufacturer of cutting tools, WIDIA offers a complete portfolio of precision-engineered products. With drilling, tapping, and tooling systems products, you will find everything you need from one single source.

- Extensive Portfolio
- Expertise
- Customized Solutions

Victory™ Tap

HSS-E-PM • Victory Taps

Victory HSS-E-PM Taps feature material-specific geometries and grades capable of working in a wider application range than solid carbide taps.

Please visit our website widia.com to view the full line of Victory Tap products.



Optimized flute designs
Better chip evacuation

Application-specific coatings
Extremely high wear resistance, longer tool life

HSS-E-PM powder metallurgy substrate
Improved wear characteristics, longer tool life

Optimum choice for customers seeking consistency and optimal performance in a wide variety of applications and materials.

GRADES

	WP31MG	WS32MG	WN35MG	WU32MG	WS34MG	WH36MG	WS39MG	WN48MG	WN44EG
	●			●		●			○
P				○	●				●
M				●					
K				●					
N				●	○			●	●
S	○	●	●	●	●	○	●		
H		●							

RELIABLE AND CONSISTENT



PRODUCT

Victory™ HSS-E-PM Taps deliver reliability and consistent performance on a wide range of applications

INDUSTRY



MATERIALS



APPLICATIONS



BLIND HOLE



THROUGH HOLE



HSS-E-PM



DIN 371



DIN 374



DIN 376



ANSI



FLOOD COOLANT: TAPPING



THROUGH COOLANT: RADIAL: TAPPING



THROUGH COOLANT: AXIAL: TAPPING

SERIES	SIZE RANGE	DIMENSIONS
GT00, GT14, GT16	M and MF: M3 to M12	DIN
GT02, GT04, GT10, GT12, GT80	M and MF: M3 to M20	DIN
GT06	M and MF: M6 to M16	DIN
GT2x	M and MF: M3 to M42	ANSI & DIN
	UNC and UNF: #2 to 3/4"	ANSI
GT3x	UNC and UNF: #6 to 1/2"	DIN/ANSI
	M and MF: M3 to M42	ANSI & DIN
GT4x	UNC and UNF: #2 to 1"	ANSI
	UNC and UNF: #6 to 1/2"	DIN/ANSI
GT5x	M and MF: M4 to M22	DIN
	UNC and UNF: #10 to 3/4"	ANSI
GT6x	UNC and UNF: #6 to 1/2"	DIN/ANSI
	M: M24 to M42	DIN
GT9x	M and MF: M2.5 to M12	ANSI
	UNC and UNF: #2 to 1"	ANSI
GT70	M and MF: M2.5 to M12	ANSI
	UNC and UNF: #2 to 3/4"	ANSI
GT7x & GT8x	M and MF: M3 to M16	DIN/ANSI
	M and MF: M3 to M12	DIN/ANSI
	UNC and UNF: #2 to 1/2"	DIN/ANSI



Shank Style

ANSI, DIN, JIS, and DIN/ANSI precision ground

Tap Drill Size Chart

Tap Drill Size Charts • Thread Forming • UNC and UNF

tap size	pitch		65° thread						70° thread						75° thread					
	UNC	UNF	Metric			Inch			Metric			Inch			Metric			Inch		
			smallest drill	theoretical	largest drill	smallest drill	theoretical	largest drill	smallest drill	theoretical	largest drill	smallest drill	theoretical	largest drill	smallest drill	theoretical	largest drill	smallest drill	theoretical	largest drill
#0	-	80	1.32	1.38	1.40	0.0520	0.0545	0.0550	1.32	1.38	1.40	0.0520	0.0540	0.0550	1.32	1.36	1.40	0.0520	0.0536	0.0550
#1	64	-	1.60	1.68	1.70	0.0630	0.0661	0.0669	1.60	1.67	1.70	0.0630	0.0655	0.0669	1.60	1.65	1.70	0.0630	0.0650	0.0669
	-	72	1.70	1.70	1.70	0.0669	0.0669	0.0669	1.60	1.69	1.70	0.0630	0.0663	0.0669	1.60	1.67	1.70	0.0630	0.0659	0.0669
#2	56	-	1.98	1.98	1.98	0.0781	0.0781	0.0781	1.90	1.97	1.98	0.0748	0.0774	0.0781	1.90	1.95	1.98	0.0748	0.0769	0.0781
	-	64	2.00	2.01	2.10	0.0787	0.0791	0.0827	2.00	2.00	2.00	0.0781	0.0785	0.0787	1.98	1.98	1.98	0.0748	0.0780	0.0781
#3	48	-	2.20	2.28	2.30	0.0866	0.0898	0.0906	2.20	2.27	2.30	0.0866	0.0890	0.0906	2.20	2.25	2.30	0.0866	0.0884	0.0906
	-	56	2.30	2.31	2.38	0.0906	0.0911	0.0938	2.30	2.31	2.38	0.0866	0.0904	0.0906	2.20	2.28	2.30	0.0866	0.0899	0.0906
#4	40	-	2.50	2.57	2.58	0.0984	0.1010	0.1015	2.50	2.55	2.58	0.0984	0.1000	0.1015	2.50	2.52	2.58	0.0984	0.0993	0.1015
	-	48	2.60	2.61	2.64	0.1024	0.1028	0.1040	2.60	2.60	2.60	0.1015	0.1020	0.1024	2.58	2.58	2.58	0.0984	0.1014	0.1015
#5	40	-	2.90	2.90	2.90	0.1130	0.1140	0.1142	2.87	2.88	2.90	0.1130	0.1130	0.1130	2.82	2.85	2.87	0.1110	0.1123	0.1130
	-	44	2.90	2.92	2.95	0.1142	0.1150	0.1160	2.90	2.91	2.95	0.1130	0.1141	0.1142	2.87	2.88	2.90	0.1130	0.1134	0.1142
#6	32	-	3.10	3.16	3.18	0.1220	0.1243	0.1250	3.10	3.14	3.18	0.1220	0.1230	0.1250	3.10	3.10	3.10	0.1220	0.1221	0.1250
	-	40	3.20	3.23	3.26	0.1260	0.1270	0.1285	3.20	3.21	3.26	0.1260	0.1260	0.1260	3.18	3.18	3.18	0.1250	0.1253	0.1260
#8	32	-	3.80	3.82	3.90	0.1496	0.1503	0.1535	3.80	3.80	3.80	0.1470	0.1490	0.1496	3.73	3.76	3.80	0.1470	0.1481	0.1496
	-	36	3.80	3.86	3.90	0.1496	0.1518	0.1535	3.80	3.84	3.90	0.1496	0.1507	0.1535	3.80	3.80	3.80	0.1470	0.1498	0.1535
#10	24	-	4.30	4.36	4.37	0.1693	0.1716	0.1719	4.30	4.34	4.37	0.1693	0.1700	0.1719	4.22	4.29	4.30	0.1660	0.1688	0.1693
	-	32	4.40	4.48	4.50	0.1732	0.1762	0.1772	4.40	4.46	4.50	0.1732	0.1750	0.1772	4.40	4.42	4.50	0.1732	0.1741	0.1772
#12	24	-	5.00	5.02	5.10	0.1969	0.1976	0.2008	5.00	5.00	5.00	0.1929	0.1960	0.1969	4.90	4.95	5.00	0.1929	0.1948	0.1969
	-	28	5.00	5.09	5.10	0.1969	0.2002	0.2008	5.00	5.07	5.10	0.1969	0.1990	0.2008	5.00	5.02	5.10	0.1969	0.1978	0.2008
1/4	20	-	5.70	5.79	5.80	0.2244	0.2279	0.2283	5.70	5.76	5.80	0.2244	0.2260	0.2283	5.70	5.70	5.70	0.2244	0.2245	0.2283
	-	28	5.95	5.95	5.95	0.2323	0.2342	0.2344	5.90	5.94	5.95	0.2323	0.2329	0.2344	5.80	5.89	5.90	0.2283	0.2318	0.2323
5/16	18	-	7.30	7.31	7.40	0.2874	0.2879	0.2913	7.30	7.30	7.30	0.2835	0.2861	0.2874	7.20	7.22	7.30	0.2835	0.2842	0.2874
	-	24	7.40	7.47	7.50	0.2913	0.2941	0.2953	7.40	7.46	7.50	0.2913	0.2927	0.2953	7.40	7.40	7.40	0.2874	0.2912	0.2913
3/8	16	-	8.80	8.82	8.90	0.3465	0.3474	0.3504	8.80	8.80	8.80	0.3438	0.3452	0.3465	8.70	8.71	8.73	0.3425	0.3431	0.3438
	-	24	9.00	9.06	9.10	0.3543	0.3566	0.3583	9.00	9.06	9.10	0.3543	0.3552	0.3583	8.90	8.98	9.00	0.3504	0.3537	0.3543
7/16	14	-	10.30	10.31	10.32	0.4055	0.4059	0.4063	10.20	10.29	10.30	0.4016	0.4035	0.4055	10.10	10.19	10.20	0.3976	0.4011	0.4016
	-	20	10.50	10.55	10.60	0.4134	0.4154	0.4173	10.50	10.55	10.60	0.4134	0.4137	0.4173	10.40	10.46	10.50	0.4094	0.4120	0.4134
1/2	13	-	11.80	11.84	11.90	0.4646	0.4660	0.4685	11.80	11.82	11.90	0.4606	0.4634	0.4646	11.70	11.70	11.70	0.4606	0.4608	0.4646
	-	20	12.10	12.14	12.20	0.4764	0.4779	0.4803	12.10	12.14	12.20	0.4724	0.4762	0.4764	12.00	12.05	12.10	0.4724	0.4745	0.4764
9/16	12	-	13.10	13.35	13.50	0.5157	0.5257	0.5315	13.10	13.33	13.50	0.5157	0.5229	0.5315	13.10	13.21	13.50	0.5157	0.5200	0.5315
	-	18	13.50	13.66	13.80	0.5315	0.5379	0.5433	13.50	13.67	13.80	0.5315	0.5361	0.5433	13.50	13.57	13.80	0.5315	0.5342	0.5433
5/8	11	-	14.50	14.85	15.00	0.5709	0.5848	0.5906	14.50	14.83	15.00	0.5709	0.5817	0.5906	14.50	14.70	15.00	0.5709	0.5787	0.5906
	-	18	15.10	15.25	15.50	0.5945	0.6004	0.6102	15.10	15.26	15.50	0.5945	0.5986	0.6102	15.10	15.16	15.50	0.5945	0.5967	0.6102
3/4	10	-	17.50	17.93	18.00	0.6890	0.7058	0.7087	17.50	17.91	18.00	0.6890	0.7024	0.7087	17.50	17.75	18.00	0.6890	0.6990	0.7087
	-	16	18.00	18.35	18.50	0.7087	0.7224	0.7283	18.00	18.37	18.50	0.7087	0.7202	0.7283	18.00	18.24	18.50	0.7087	0.7181	0.7283
7/8	9	-	20.50	20.98	21.00	0.8071	0.8259	0.8268	20.50	20.96	21.00	0.8071	0.8221	0.8268	20.50	20.78	21.00	0.8071	0.8183	0.8268
	-	14	21.33	21.42	21.43	0.8398	0.8434	0.8440	21.43	21.45	21.50	0.8398	0.8410	0.8440	21.15	21.30	21.33	0.8327	0.8386	0.8398
1	8	-	24.00	24.00	24.00	0.9380	0.9448	0.9449	23.81	23.98	24.00	0.9380	0.9405	0.9449	23.50	23.78	23.81	0.9252	0.9363	0.9375
	-	12	24.30	24.47	24.50	0.9567	0.9632	0.9646	24.30	24.49	24.50	0.9567	0.9603	0.9646	24.30	24.32	24.50	0.9567	0.9575	0.9646

INDEXABLE MILLING

SOLID END MILLING

HOLEMAKING

TAPPING

TURNING

Tap Drill Size Charts • Thread Forming • M and MF

tap size	pitch		65° thread						70° thread						75° thread					
	M	MF	Metric			Inch			Metric			Inch			Metric			Inch		
			smallest drill	theoretical	largest drill	smallest drill	theoretical	largest drill	smallest drill	theoretical	largest drill	smallest drill	theoretical	largest drill	smallest drill	theoretical	largest drill	smallest drill	theoretical	largest drill
M1.6	0.35	-	1.40	1.45	1.50	0.0551	0.0571	0.0591	1.40	1.43	1.50	0.0551	0.0563	0.0591	1.40	1.42	1.50	0.0551	0.0559	0.0591
M1.7	0.35	-	1.50	1.58	1.60	0.0591	0.0623	0.0630	1.50	1.57	1.60	0.0591	0.0620	0.0630	1.50	1.56	1.60	0.0591	0.0617	0.0630
M1.8	0.35	-	1.60	1.65	1.70	0.0630	0.0650	0.0669	1.60	1.63	1.70	0.0630	0.0642	0.0669	1.60	1.62	1.70	0.0630	0.0638	0.0669
M2	0.4	-	1.80	1.82	1.90	0.0709	0.0717	0.0748	1.80	1.81	1.90	0.0709	0.0713	0.0748	1.80	1.80	1.80	0.0709	0.0709	0.0709
M2.2	0.45	-	2.00	2.00	2.00	0.0787	0.0787	0.0787	1.98	1.99	2.00	0.0781	0.0783	0.0787	1.90	1.97	1.98	0.0748	0.0776	0.0781
M2.5	0.45	-	2.30	2.30	2.30	0.0906	0.0906	0.0906	2.20	2.29	2.30	0.0866	0.0902	0.0906	2.20	2.27	2.30	0.0866	0.0894	0.0906
M2.6	0.45	-	2.40	2.43	2.44	0.0945	0.0957	0.0960	2.40	2.42	2.44	0.0945	0.0953	0.0960	2.40	2.41	2.44	0.0945	0.0949	0.0960
M3	0.5	-	2.78	2.78	2.80	0.1094	0.1094	0.1094	2.71	2.76	2.78	0.1065	0.1087	0.1094	2.71	2.75	2.78	0.1065	0.1083	0.1094
M3.5	0.6	-	3.20	3.23	3.26	0.1260	0.1272	0.1285	3.20	3.21	3.26	0.1260	0.1264	0.1285	3.18	3.19	3.20	0.1250	0.1256	0.1260
M4	0.7	-	3.66	3.69	3.70	0.1440	0.1453	0.1457	3.66	3.67	3.70	0.1440	0.1445	0.1457	3.60	3.64	3.66	0.1417	0.1433	0.1440
M4.5	0.75	-	4.10	4.17	4.20	0.1614	0.1642	0.1654	4.10	4.14	4.20	0.1614	0.1630	0.1654	4.10	4.12	4.20	0.1614	0.1622	0.1654
M5	0.8	-	4.62	4.65	4.70	0.1820	0.1831	0.1850	4.60	4.62	4.62	0.1811	0.1819	0.1820	4.50	4.59	4.60	0.1772	0.1807	0.1811
M6	1	-	5.56	5.56	5.60	0.2188	0.2189	0.2205	5.50	5.52	5.56	0.2165	0.2173	0.2188	5.41	5.49	5.50	0.2130	0.2161	0.2165
M7	1	-	6.53	6.56	6.60	0.2570	0.2583	0.2598	6.50	6.52	6.53	0.2559	0.2567	0.2570	6.40	6.49	6.50	0.2520	0.2555	0.2559
M8	1.25	-	7.40	7.45	7.50	0.2913	0.2933	0.2953	7.40	7.41	7.50	0.2913	0.2917	0.2953	7.30	7.36	7.40	0.2874	0.2898	0.2913
M8	-	1	7.54	7.56	7.60	0.2969	0.2976	0.2992	7.50	7.52	7.54	0.2953	0.2961	0.2969	7.40	7.49	7.50	0.2913	0.2949	0.2953
M8	-	0.75	7.60	7.67	7.70	0.2992	0.3020	0.3031	7.60	7.64	7.70	0.2992	0.3008	0.3031	7.60	7.62	7.70	0.2992	0.3000	0.3031
M10	1.5	-	9.30	9.34	9.35	0.3661	0.3677	0.3680	9.20	9.29	9.30	0.3622	0.3657	0.3661	9.20	9.24	9.30	0.3622	0.3638	0.3661
M10	-	1.25	9.40	9.45	9.50	0.3701	0.3720	0.3740	9.40	9.41	9.50	0.3701	0.3705	0.3740	9.35	9.36	9.40	0.3680	0.3685	0.3701
M10	-	1	9.53	9.56	9.60	0.3750	0.3764	0.3780	9.50	9.52	9.53	0.3740	0.3748	0.3750	9.40	9.49	9.50	0.3701	0.3736	0.3740
M10	-	0.75	9.60	9.67	9.70	0.3780	0.3807	0.3819	9.60	9.64	9.70	0.3780	0.3795	0.3819	9.60	9.62	9.70	0.3780	0.3787	0.3819
M12	1.75	-	11.20	11.23	11.30	0.4409	0.4421	0.4449	11.15	11.17	11.20	0.4375	0.4398	0.4409	11.10	11.11	11.15	0.4370	0.4374	0.4375
M12	-	1.5	11.30	11.34	11.40	0.4449	0.4465	0.4488	11.20	11.29	11.30	0.4449	0.4484	0.4488	11.20	11.24	11.30	0.4409	0.4425	0.4449
M12	-	1.25	11.40	11.45	11.50	0.4488	0.4508	0.4528	11.40	11.41	11.50	0.4488	0.4492	0.4528	11.30	11.36	11.40	0.4449	0.4472	0.4488
M12	-	1	11.51	11.56	11.60	0.4531	0.4551	0.4567	11.51	11.52	11.60	0.4531	0.4535	0.4567	11.40	11.49	11.50	0.4488	0.4524	0.4528
M14	2	-	13.10	13.12	13.50	0.5157	0.5165	0.5315	13.00	13.05	13.10	0.5118	0.5138	0.5157	12.80	12.98	13.00	0.5039	0.5110	0.5118
M14	-	1.5	13.10	13.34	13.50	0.5157	0.5252	0.5315	13.10	13.29	13.50	0.5157	0.5232	0.5315	13.10	13.24	13.50	0.5157	0.5213	0.5315
M16	2	-	15.10	15.12	15.50	0.5945	0.5953	0.6102	15.00	15.05	15.10	0.5906	0.5925	0.5945	14.50	14.98	15.00	0.5709	0.5898	0.5906
M16	-	1.5	15.10	15.34	15.50	0.5945	0.6039	0.6102	15.10	15.29	15.50	0.5945	0.6020	0.6102	15.10	15.24	15.50	0.5945	0.6000	0.6102
M18	2.5	-	16.50	16.90	17.00	0.6496	0.6654	0.6693	16.50	16.81	17.00	0.6496	0.6618	0.6693	16.50	16.73	17.00	0.6496	0.6587	0.6693
M18	-	1.5	17.00	17.34	17.50	0.6693	0.6827	0.6890	17.00	17.29	17.50	0.6693	0.6807	0.6890	17.00	17.24	17.50	0.6693	0.6787	0.6890
M20	2.5	-	18.50	18.90	19.00	0.7283	0.7441	0.7480	18.50	18.81	19.00	0.7283	0.7406	0.7480	18.50	18.73	19.00	0.7283	0.7374	0.7480
M20	-	1.5	19.00	19.34	19.50	0.7480	0.7614	0.7677	19.00	19.29	19.50	0.7480	0.7594	0.7677	19.00	19.24	19.50	0.7480	0.7575	0.7677
M20	-	1	19.50	19.56	20.00	0.7677	0.7701	0.7874	19.50	19.52	20.00	0.7677	0.7685	0.7874	19.00	19.49	19.50	0.7480	0.7673	0.7677
M22	2.5	-	20.50	20.90	21.00	0.8071	0.8228	0.8268	20.50	20.81	21.00	0.8071	0.8193	0.8268	20.50	20.73	21.00	0.8071	0.8161	0.8268
M22	-	2	21.00	21.12	21.15	0.8268	0.8315	0.8327	21.00	21.05	21.15	0.8268	0.8287	0.8327	20.50	20.98	21.00	0.8071	0.8260	0.8268
M22	-	1.5	21.33	21.34	21.43	0.8398	0.8402	0.8440	21.15	21.29	21.33	0.8327	0.8382	0.8398	21.15	21.24	21.33	0.8327	0.8362	0.8398
M24	3	-	22.50	22.67	22.77	0.8858	0.8925	0.8965	22.50	22.57	22.77	0.8858	0.8886	0.8965	22.44	22.47	22.50	0.8840	0.8846	0.8858
M24	-	2	23.10	23.12	23.30	0.9094	0.9102	0.9173	23.00	23.05	23.10	0.9055	0.9075	0.9094	22.77	22.98	23.00	0.8965	0.9047	0.9055
M24	-	1.5	23.30	23.34	23.42	0.9173	0.9189	0.9220	23.10	23.29	23.30	0.9094	0.9169	0.9173	23.10	23.24	23.30	0.9094	0.9150	0.9173

INDEXABLE MILLING

SOLID END MILLING

HOLEMAKING

TAPPING

TURNING

Tap Drill Size Charts • Pipe Taps

pipe tap size	NPT and NPTF		NPSM	NPSC	NPSF
	without reamer	with reamer			
1/16-27	0.2420	0.2344	-	0.2500	0.2460
1/8-27	0.3320	0.3281	0.3580	0.3320	0.3390
1/4-18	0.4375	0.4219	0.4688	0.4375	0.4375
3/8-18	0.5625	0.5625	0.6030	0.5781	0.5781
1/2-14	0.7031	0.6875	0.7480	0.7087	0.7087
3/4-14	0.9063	0.8906	0.9531	0.9219	0.9219
1-11 1/2	1.1406	1.1250	1.2031	1.1563	1.1563
1 1/4-11 1/2	1.4844	1.4688	1.5460	1.5000	-
1 1/2-11 1/2	1.7188	1.7031	1.7813	1.7344	-
2-11 1/2	2.1875	2.1719	2.2500	2.2031	-

Tap Recommendations for Classes 2B and 3B

Unified Inch Screw Threads

thread size/pitch	recommended tap limits ¹		internal thread pitch diameter limits		
	class 2B	class 3B	min all classes (Basic)	max class 2B	max class 3B
0 - 80	H2	H2	0.0519	0.0542	0.0536
1 - 64	H2	H2	0.0629	0.0655	0.0648
1 - 72	H2	H2	0.0640	0.0665	0.0659
2 - 56	H2	H2	0.0744	0.0772	0.0765
2 - 64	H2	H2	0.0759	0.0786	0.0779
3 - 48	H3	H2	0.0855	0.0885	0.0877
3 - 56	H2	H2	0.0874	0.0902	0.0895
4 - 40	H3	H2	0.0958	0.0991	0.0982
4 - 48	H3	H2	0.0985	0.1016	0.1008
5 - 40	H3	H2	0.1088	0.1121	0.1113
5 - 44	H3	H2	0.1102	0.1134	0.1126
6 - 32	H3	H2	0.1177	0.1214	0.1204
6 - 40	H3	H2	0.1218	0.1252	0.1243
8 - 32	H3	H3	0.1437	0.1475	0.1465
8 - 36	H3	H3	0.1460	0.1496	0.1487
10 - 24	H3	H3	0.1629	0.1672	0.1661
10 - 32	H3	H3	0.1697	0.1736	0.1726
12 - 24	H3	H3	0.1889	0.1933	0.1922
12 - 28	H3	H3	0.1928	0.1970	0.1959
1/4 - 20	H5	H3	0.2175	0.2224	0.2211
1/4 - 28	H4	H3	0.2268	0.2311	0.2300
5/16 - 18	H5	H3	0.2764	0.2817	0.2803
5/16 - 24	H4	H3	0.2854	0.2902	0.2890
3/8 - 16	H5	H3	0.3344	0.3401	0.3387
3/8 - 24	H4	H3	0.3479	0.3528	0.3516
7/16 - 14	H5	H3	0.3911	0.3972	0.3957
7/16 - 20	H5	H3	0.4050	0.4104	0.4091
1/2 - 13	H5	H4	0.4500	0.4565	0.4548
1/2 - 20	H5	H3	0.4675	0.4731	0.4717
9/16 - 12	H5	H4	0.5084	0.5152	0.5135
9/16 - 18	H5	H3	0.5264	0.5323	0.5308
5/8 - 11	H5	H4	0.5660	0.5732	0.5714
5/8 - 18	H5	H3	0.5889	0.5949	0.5934
3/4 - 10	H5	H4	0.6850	0.6927	0.6907

¹Tap H limit selected for 3B will also produce thread to 2B.

NOTE: The above recommended taps normally produce the class of thread indicated in average materials when used with reasonable care. However, if the specified tap does not provide a satisfactory gage fit, choose an alternate tap limit.

Tap Recommendations for Classes 2B and 3B

Unified Inch Screw Threads

thread size/pitch	recommended tap limits		internal thread pitch diameter limits		
	class 2B	class 3B	min all classes (Basic)	max class 2B	max class 3B
3/4 - 16	H5	H4	0.7094	0.7159	0.7143
7/8 - 9	H6	H4	0.8028	0.8110	0.8089
7/8 - 14	H6	H4	0.8286	0.8356	0.8339
1" - 8	H6	H5	0.9188	0.9276	0.9254
1" - 12	H6	H4	0.9459	0.9535	0.9516
1-1/8 - 7	H8	H6	1.0322	1.0416	1.0393
1-1/8 - 8	H8	H6	1.0438	1.0528	1.0505
1-1/8 - 12	H6	H5	1.0709	1.0787	1.0768
1-1/4 - 7	H8	H6	1.1572	1.1668	1.1644
1-1/4 - 8	H8	H6	1.1688	1.1780	1.1757
1-1/4 - 12	H6	H5	1.1959	1.2039	1.2019
1-3/8 - 6	H8	H6	1.2667	1.2771	1.2745
1-3/8 - 8	H8	H6	1.2938	1.3031	1.3008
1-3/8 - 12	H6	H5	1.3209	1.3291	1.3270
1-1/2 - 6	H8	H6	1.3917	1.4022	1.3996
1-1/2 - 8	H8	H6	1.4188	1.4283	1.4259
1-1/2 - 12	H6	H5	1.4459	1.4542	1.4522
1-3/4 - 5	H8	H7	1.6201	1.6317	1.6288
2 - 4 1/2	H8	H7	1.8557	1.8681	1.8650

¹Tap H limit selected for 3B will also produce thread to 2B.

Tap Recommendations for Class 6H Metric Screw Threads

thread size		recommended tap limit number	internal thread product limits — class 6H			
nominal diameter (mm)	pitch (mm)		pitch diameter (mm)		pitch diameter (in)	
			min	max	min	max
1,6	0,35	D3	1,373	1,458	.05406	.05740
2	0,4	D3	1,740	1,830	.06850	.07205
2,5	0,45	D3	2,208	2,303	.08693	.09067
3	0,5	D3	2,675	2,775	.10531	.10925
3,5	0,6	D4	3,110	3,222	.12244	.12685
4	0,7	D4	3,545	3,663	.13957	.14421
4,5	0,75	D4	4,013	4,131	.15789	.16264
5	0,8	D4	4,480	4,605	.17638	.18130
6	1	D5	5,350	5,500	.21063	.21654
7	1	D5	6,350	6,500	.25000	.25591
8	1,25	D5	7,188	7,348	.28299	.28929
10	1,5	D6	9,026	9,206	.35535	.36244
12	1,75	D6	10,863	11,063	.42768	.43555
14	2	D7	12,701	12,913	.50004	.50839
16	2	D7	14,701	14,913	.57878	.58713
20	2,5	D7	18,376	18,600	.72346	.73228
24	3	D8	22,051	22,316	.86815	.87858
30	3,5	D9	27,727	28,007	1.09161	1.10264
36	4	D9	33,402	33,702	1.31504	1.32685

Decimal Equivalents

drill size	decimal (in)	drill size	decimal (in)	drill size	decimal (in)	drill size	decimal (in)	drill size	decimal (in)	drill size	decimal (in)
0,30mm	.0118	54	.0550	3,10mm	.1220	5,50mm	.2165	8,50mm	.3346	9/16	.5625
0,32mm	.0126	1,40mm	.0551	1/18	.1250	7/32	.2188	8,60mm	.3386	14,50mm	.5709
80	.0135	1,45mm	.0571	3,20mm	.1260	5,60mm	.2205	R	.3390	37/64	.5781
0,35mm	.0138	1,50mm	.0591	30	.1285	2	.2210	8,70mm	.3425	14,75mm	.5807
79	.0145	53	.0595	3,30mm	.1299	5,70mm	.2244	11/32	.3438	15,00mm	.5906
0,38mm	.0150	1,55mm	.0610	3,40mm	.1339	1	.2280	8,80mm	.3465	19/32	.5938
1/64	.0156	1/16	.0625	29	.1360	5,80mm	.2283	S	.3480	15,25mm	.6004
0,40mm	.0157	1,60mm	.0630	3,50mm	.1378	5,90mm	.2323	8,90mm	.3504	39/64	.6094
78	.0160	52	.0635	28	.1405	A	.2340	9,00mm	.3543	15,50mm	.6102
0,42mm	.0165	1,65mm	.0650	9/64	.1406	15/64	.2344	T	.3580	15,75mm	.6201
0,45mm	.0177	1,70mm	.0669	3,60mm	.1417	6,00mm	.2362	9,10mm	.3583	5/8	.6250
77	.0180	51	.0670	27	.1440	B	.2380	23/64	.3594	16,00mm	.6299
0,48mm	.0189	1,75mm	.0689	3,70mm	.1457	6,10mm	.2402	9,20mm	.3622	16,25mm	.6398
0,50mm	.0197	50	.0700	26	.1470	C	.2420	9,30mm	.3661	41/64	.6406
76	.0200	1,80mm	.0709	25	.1495	6,20mm	.2441	U	.3680	16,50mm	.6496
75	.0210	1,85mm	.0728	3,80mm	.1496	D	.2460	9,40mm	.3701	21/32	.6562
0,55mm	.0217	49	.0730	24	.1520	6,30mm	.2480	9,50mm	.3740	16,75mm	.6594
74	.0225	1,90mm	.0748	3,90mm	.1535	1/4, E	.2500	3/8	.3750	17,00mm	.6693
0,60mm	.0236	48	.0760	23	.1540	6,40mm	.2520	V	.3770	43/64	.6719
73	.0240	1,95mm	.0768	5/32	.1562	6,50mm	.2559	9,60mm	.3780	17,25mm	.6791
0,62mm	.0244	5/64	.0781	22	.1570	F	.2570	9,70mm	.3819	11/16	.6875
72	.0250	47	.0785	4,00mm	.1575	6,60mm	.2598	9,80mm	.3858	17,50mm	.6890
0,65mm	.0256	2,00mm	.0787	21	.1590	G	.2610	W	.3860	45/64	.7031
71	.0260	2,05mm	.0807	20	.1610	6,70mm	.2638	9,90mm	.3898	18,00mm	.7087
0,70mm	.0276	46	.0810	4,10mm	.1614	17/64	.2656	25/64	.3906	23/32	.7188
70	.0280	45	.0820	4,20mm	.1654	H	.2660	10,00mm	.3937	18,50mm	.7283
69	.0292	2,10mm	.0827	19	.1660	6,80mm	.2677	X	.3970	47/64	.7344
0,75mm	.0295	2,15mm	.0846	4,30mm	.1693	6,90mm	.2717	10,20mm	.4016	19,00mm	.7480
68	.0310	44	.0860	18	.1695	I	.2720	Y	.4040	3/4	.7500
1/32	.0312	2,20mm	.0866	11/64	.1719	7,00mm	.2756	13/32	.4062	49/64	.7656
0,80mm	.0315	2,25mm	.0886	17	.1730	J	.2770	Z	.4130	19,50mm	.7677
67	.0320	43	.0890	4,40mm	.1732	7,10mm	.2795	10,50mm	.4134	25/32	.7812
66	.0330	2,30mm	.0906	16	.1770	K	.2810	27/64	.4219	20,00mm	.7874
0,85mm	.0335	2,35mm	.0925	4,50mm	.1772	9/32	.2812	10,80mm	.4252	51/64	.7969
65	.0350	42	.0935	15	.1800	7,20mm	.2835	11,00mm	.4331	20,50mm	.8071
0,90mm	.0354	3/32	.0938	4,60mm	.1811	7,30mm	.2874	7/16	.4375	13/16	.8125
64	.0360	2,40mm	.0945	14	.1820	L	.2900	11,20mm	.4409	21,00mm	.8268
63	.0370	41	.0960	4,70mm, 13	.1850	7,40mm	.2913	11,50mm	.4528	53/64	.8281
0,95mm	.0374	2,45mm	.0965	3/16	.1875	M	.2950	29/64	.4531	27/32	.8438
62	.0380	40	.0980	4,80mm, 12	.1890	7,50mm	.2953	11,80mm	.4646	21,50mm	.8465
61	.0390	2,50mm	.0984	11	.1910	19/64	.2969	15/32	.4688	55/64	.8594
1,00mm	.0394	39	.0995	4,90mm	.1929	7,60mm	.2992	12,00mm	.4724	22,00mm	.8661
60	.0400	38	.1015	10	.1935	N	.3020	12,20mm	.4803	7/8	.8750
59	.0410	2,60mm	.1024	9	.1960	7,70mm	.3031	31/64	.4844	22,50mm	.8858
1,05mm	.0413	37	.1040	5,00mm	.1969	7,80mm	.3071	12,50mm	.4921	57/64	.8906
58	.0420	2,70mm	.1063	8	.1990	7,90mm	.3110	1/2	.5000	23,00mm	.9055
57	.0430	36	.1065	5,10mm	.2008	5/16	.3125	12,80mm	.5039	29/32	.9062
1,10mm	.0433	7/64	.1094	7	.2010	8,00mm	.3150	13,00mm	.5118	59/64	.9219
1,15mm	.0453	35	.1100	13/64	.2031	O	.3160	33/64	.5156	23,50mm	.9252
56	.0465	2,80mm	.1102	6	.2040	8,10mm	.3189	13,20mm	.5197	15/16	.9375
3/64	.0469	34	.1110	5,20mm	.2047	8,20mm	.3228	17/32	.5312	24,00mm	.9449
1,20mm	.0472	33	.1130	5	.2055	P	.3230	13,50mm	.5315	61/64	.9531
1,25mm	.0492	2,90mm	.1142	5,30mm	.2087	8,30mm	.3268	13,80mm	.5433	24,50mm	.9646
1,30mm	.0512	32	.1160	4	.2090	21/64	.3281	35/64	.5469	31/32	.9688
55	.0520	3,00mm	.1181	5,40mm	.2126	8,40mm	.3307	14,00mm	.5512	25,00mm	.9843
1,35mm	.0531	31	.1200	3	.2130	Q	.3320	14,25mm	.5610	63/64	.9844
-	-	-	-	-	-	-	-	-	-	1*	1.0000

■ Metric
 ■ Fractional
 ■ Wire gage
 ■ Letter size



Turning

External Turning and Internal Boring	E4–E297
High-Performance Inserts • WIDIA Victory	E4–E117
High-Performance Inserts for Machining Aluminum	E118–E125
Advanced Materials Inserts • CBN, Ceramics, and PCD	E126–E177
Toolholders for External Turning	E178–E212
Toolholders for Internal Boring	E214–E237
Cartridges for Internal Boring	E238–E245
Railway Wheel Reprofilng / Wheelset Turning / Bar Peeling	E246–E255
Small Hole Boring	E256–E297
Grooving and Cut-Off	E298–E429
WGC	E298–E338
WMT	E340–E373
TopGroove	E374–E425
LG Grooving	E426–E429
Threading	E430–E515
TopThread	E430–E461
Laydown	E462–E491
Technical Information	E492–E515

WIDIA™ Victory™ Turning Inserts

Turning

The Victory ISO turning portfolio offers a comprehensive range of ISO Turning Inserts with advanced substrates and coating technologies for high productivity, long tool life, and reliability in rough to finish-turning applications. Inserts in this portfolio can be applied across a wide range of applications with effective chip control and smooth surface finish at a strong cost performance ratio.

NEGATIVE INSERTS

- Negative-style inserts are first choice for general machining of materials in medium to large lathes
- Negative-style inserts are available in flat-top and chip-control chip breakers in both molded and ground peripheries suitable for all workpiece materials



POSITIVE INSERTS

- Screw-on inserts are the first choice for I.D. turning of all materials and O.D. turning on small to medium lathes suitable for all workpiece materials



PcBN AND PCD INSERTS

- PcBN can be used for machining steels with a hardness higher than 48 HRC
- PcBN inserts can also be used for productivity improvements in machining cast irons and high-temp alloys
- PCD inserts are used to machine non-ferrous materials



CERAMIC INSERTS

- Ceramic inserts are a great choice for productive machining of high-temp alloys
- Negative rake inserts are also recommended for the machining of hardened materials and cast irons available in flat-top chip breakers with molded and ground peripheries



WIDIA VICTORY TURNING INSERTS

VERSATILITY

Specialty engineering substrate with wear-resistant, multi-layer coating makes it suitable for wide range of applications.

STABILITY

Pre- and post-coat treatment along with post-coat grinding improves edge toughness, provides secure seating leading to consistent performance.

PRODUCTIVITY

Multi-layer CVD coating with alpha-alumina layer provides higher productivity and tool life with reliability at elevated speeds and feeds.

SIMPLICITY

Outer layer bronze colored for easy wear identification. Easy to select and apply grades and chip breakers for roughing to finishing applications in variety of workpiece materials.

STEEL, STAINLESS STEEL, CAST IRON, AND HIGH-TEMP ALLOY INSERTS

VICTORY™ TURNING

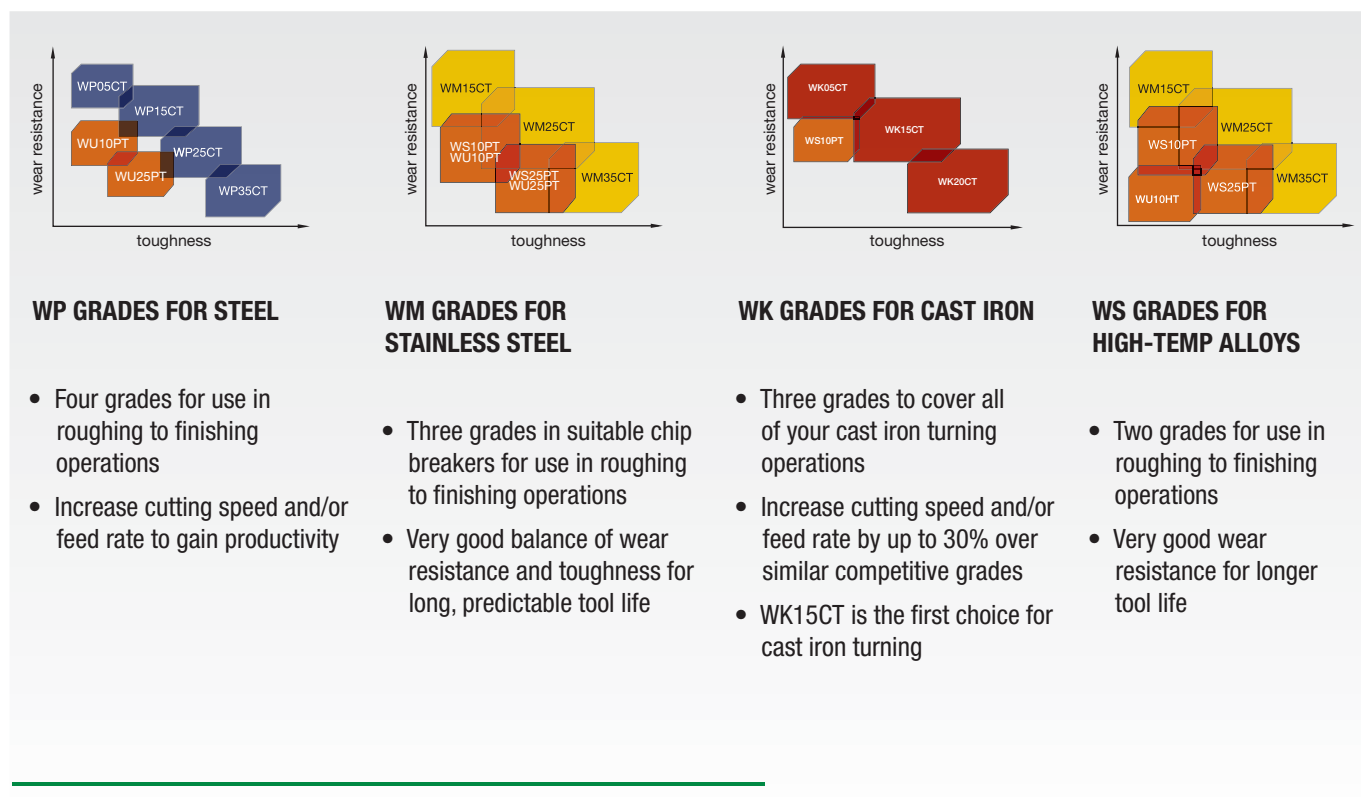

INDUSTRY



Catalog Numbering System

Each character in our catalog number signifies a specific trait of that product. Use the following key columns and corresponding images to easily identify which attributes apply.

INDEXABLE MILLING

SOLID END MILLING

HOLEMAKING

TAPPING

TURNING

C		N		M		G		12																																																																																																																																																																																																	
Insert Shape		Insert Clearance Angle		Tolerance Class		Insert Features		Size																																																																																																																																																																																																	
H	Hexagon 120°	A	3°	<p>Tolerances apply prior to edge prep and coating</p> <p>D = Theoretical diameter of the insert inscribed circle S = Thickness B = See figures below</p>	N		<p>Code for mm cutting edge length "L10"</p> <table border="1"> <thead> <tr> <th>"D"</th> <th>C</th> <th>D</th> <th>R</th> <th>S</th> <th>T</th> <th>V</th> <th>W</th> </tr> </thead> <tbody> <tr><td>3,97</td><td>S4</td><td>04</td><td>03</td><td>03</td><td>06</td><td>—</td><td>—</td></tr> <tr><td>4,76</td><td>04</td><td>05</td><td>04</td><td>04</td><td>08</td><td>08</td><td>S3</td></tr> <tr><td>5,56</td><td>05</td><td>06</td><td>05</td><td>05</td><td>09</td><td>09</td><td>03</td></tr> <tr><td>6,00</td><td>—</td><td>—</td><td>06</td><td>—</td><td>—</td><td>—</td><td>—</td></tr> <tr><td>6,35</td><td>06</td><td>07</td><td>06</td><td>06</td><td>11</td><td>11</td><td>04</td></tr> <tr><td>7,94</td><td>08</td><td>09</td><td>07</td><td>07</td><td>13</td><td>13</td><td>05</td></tr> <tr><td>8,00</td><td>—</td><td>—</td><td>08</td><td>—</td><td>—</td><td>—</td><td>—</td></tr> <tr><td>9,52</td><td>09</td><td>11</td><td>09</td><td>09</td><td>16</td><td>16</td><td>06</td></tr> <tr><td>10,00</td><td>—</td><td>—</td><td>10</td><td>—</td><td>—</td><td>—</td><td>—</td></tr> <tr><td>11,11</td><td>11</td><td>13</td><td>11</td><td>11</td><td>19</td><td>19</td><td>07</td></tr> <tr><td>12,00</td><td>—</td><td>—</td><td>12</td><td>—</td><td>—</td><td>—</td><td>—</td></tr> <tr><td>12,70</td><td>12</td><td>15</td><td>12</td><td>12</td><td>22</td><td>22</td><td>08</td></tr> <tr><td>14,29</td><td>14</td><td>17</td><td>14</td><td>14</td><td>24</td><td>24</td><td>09</td></tr> <tr><td>15,88</td><td>16</td><td>19</td><td>15</td><td>15</td><td>27</td><td>27</td><td>10</td></tr> <tr><td>16,00</td><td>—</td><td>—</td><td>16</td><td>—</td><td>—</td><td>—</td><td>—</td></tr> <tr><td>17,46</td><td>17</td><td>21</td><td>17</td><td>17</td><td>30</td><td>30</td><td>11</td></tr> <tr><td>19,05</td><td>19</td><td>23</td><td>19</td><td>19</td><td>33</td><td>33</td><td>13</td></tr> <tr><td>20,00</td><td>—</td><td>—</td><td>20</td><td>—</td><td>—</td><td>—</td><td>—</td></tr> <tr><td>22,22</td><td>22</td><td>27</td><td>22</td><td>22</td><td>38</td><td>38</td><td>15</td></tr> <tr><td>25,00</td><td>—</td><td>—</td><td>25</td><td>—</td><td>—</td><td>—</td><td>—</td></tr> <tr><td>25,40</td><td>25</td><td>31</td><td>25</td><td>25</td><td>44</td><td>44</td><td>17</td></tr> <tr><td>31,75</td><td>32</td><td>38</td><td>31</td><td>31</td><td>54</td><td>54</td><td>21</td></tr> <tr><td>32,00</td><td>—</td><td>—</td><td>32</td><td>—</td><td>—</td><td>—</td><td>—</td></tr> </tbody> </table>	"D"	C	D	R	S	T	V	W	3,97	S4	04	03	03	06	—	—	4,76	04	05	04	04	08	08	S3	5,56	05	06	05	05	09	09	03	6,00	—	—	06	—	—	—	—	6,35	06	07	06	06	11	11	04	7,94	08	09	07	07	13	13	05	8,00	—	—	08	—	—	—	—	9,52	09	11	09	09	16	16	06	10,00	—	—	10	—	—	—	—	11,11	11	13	11	11	19	19	07	12,00	—	—	12	—	—	—	—	12,70	12	15	12	12	22	22	08	14,29	14	17	14	14	24	24	09	15,88	16	19	15	15	27	27	10	16,00	—	—	16	—	—	—	—	17,46	17	21	17	17	30	30	11	19,05	19	23	19	19	33	33	13	20,00	—	—	20	—	—	—	—	22,22	22	27	22	22	38	38	15	25,00	—	—	25	—	—	—	—	25,40	25	31	25	25	44	44	17	31,75	32	38	31	31	54	54	21	32,00	—	—	32	—	—	—	—	R	
"D"	C	D	R		S	T		V	W																																																																																																																																																																																																
3,97	S4	04	03		03	06		—	—																																																																																																																																																																																																
4,76	04	05	04		04	08		08	S3																																																																																																																																																																																																
5,56	05	06	05		05	09		09	03																																																																																																																																																																																																
6,00	—	—	06		—	—		—	—																																																																																																																																																																																																
6,35	06	07	06		06	11		11	04																																																																																																																																																																																																
7,94	08	09	07		07	13		13	05																																																																																																																																																																																																
8,00	—	—	08		—	—		—	—																																																																																																																																																																																																
9,52	09	11	09		09	16		16	06																																																																																																																																																																																																
10,00	—	—	10	—	—	—	—																																																																																																																																																																																																		
11,11	11	13	11	11	19	19	07																																																																																																																																																																																																		
12,00	—	—	12	—	—	—	—																																																																																																																																																																																																		
12,70	12	15	12	12	22	22	08																																																																																																																																																																																																		
14,29	14	17	14	14	24	24	09																																																																																																																																																																																																		
15,88	16	19	15	15	27	27	10																																																																																																																																																																																																		
16,00	—	—	16	—	—	—	—																																																																																																																																																																																																		
17,46	17	21	17	17	30	30	11																																																																																																																																																																																																		
19,05	19	23	19	19	33	33	13																																																																																																																																																																																																		
20,00	—	—	20	—	—	—	—																																																																																																																																																																																																		
22,22	22	27	22	22	38	38	15																																																																																																																																																																																																		
25,00	—	—	25	—	—	—	—																																																																																																																																																																																																		
25,40	25	31	25	25	44	44	17																																																																																																																																																																																																		
31,75	32	38	31	31	54	54	21																																																																																																																																																																																																		
32,00	—	—	32	—	—	—	—																																																																																																																																																																																																		
O	Octagon 135°	B	5°	F		M		W																																																																																																																																																																																																	
P	Pentagon 108°	C	7°	G		H		T																																																																																																																																																																																																	
R	Round —	D	15°	W		Q		U																																																																																																																																																																																																	
S	Square 90°	E	20°	T		B		X	Special Design																																																																																																																																																																																																
T	Triangular 60°	F	25°	Q		V	Special Design																																																																																																																																																																																																		
C	Rhomboid 80°	G	30°	U																																																																																																																																																																																																					
D	55°	N	0°																																																																																																																																																																																																						
E	75°	P	11°																																																																																																																																																																																																						
M	86°																																																																																																																																																																																																								
V	35°																																																																																																																																																																																																								
W	Trigon 80° with enlarged corner angles																																																																																																																																																																																																								
L	Rectangular 90°																																																																																																																																																																																																								
A	Parallelogram 85°																																																																																																																																																																																																								
B	82°																																																																																																																																																																																																								
N/K	55°	O	Indicated for other clearance angles requiring descriptions.																																																																																																																																																																																																						

tolerance class	tolerance on "D"	tolerance on "B"	tolerance on "S"
C	±0,025	±0,013	±0,025
H	±0,013	±0,013	±0,025
E	±0,025	±0,025	±0,025
G	±0,025	±0,025	±0,013
M	See tables on next page		±0,013
U	See tables on next page		±0,013

Catalog Numbering System

(continued)

INDEXABLE MILLING

SOLID END MILLING

HOLEMAKING

TAPPING

TURNING

04	08	Hand of Insert (optional)	Cutting Edge (optional)	UR																																																																
Thickness S	Corner Radius "Rε"			Chipbreaker (optional)																																																																
<table border="1"> <thead> <tr> <th>symbol</th> <th>thickness</th> </tr> <tr> <th>mm</th> <th>mm</th> </tr> </thead> <tbody> <tr><td>—</td><td>0,79</td></tr> <tr><td>T0</td><td>1,00</td></tr> <tr><td>01</td><td>1,59</td></tr> <tr><td>T1</td><td>1,98</td></tr> <tr><td>02</td><td>2,38</td></tr> <tr><td>03</td><td>3,18</td></tr> <tr><td>T3</td><td>3,97</td></tr> <tr><td>04</td><td>4,76</td></tr> <tr><td>05</td><td>5,56</td></tr> <tr><td>06</td><td>6,35</td></tr> <tr><td>07</td><td>7,94</td></tr> <tr><td>9</td><td>9,52</td></tr> <tr><td>11</td><td>11,11</td></tr> <tr><td>12</td><td>12,70</td></tr> </tbody> </table>	symbol	thickness	mm	mm	—	0,79	T0	1,00	01	1,59	T1	1,98	02	2,38	03	3,18	T3	3,97	04	4,76	05	5,56	06	6,35	07	7,94	9	9,52	11	11,11	12	12,70	<table border="1"> <thead> <tr> <th>symbol</th> <th>corner radius</th> </tr> <tr> <th>mm</th> <th>mm</th> </tr> </thead> <tbody> <tr><td>X0</td><td>0,04</td></tr> <tr><td>01</td><td>0,1</td></tr> <tr><td>02</td><td>0,2</td></tr> <tr><td>04</td><td>0,4</td></tr> <tr><td>08</td><td>0,8</td></tr> <tr><td>12</td><td>1,2</td></tr> <tr><td>16</td><td>1,6</td></tr> <tr><td>20</td><td>2,0</td></tr> <tr><td>24</td><td>2,4</td></tr> <tr><td>28</td><td>2,8</td></tr> <tr><td>32</td><td>3,2</td></tr> <tr><td>00</td><td>—</td></tr> <tr><td>M0</td><td>round insert</td></tr> <tr><td>—</td><td>—</td></tr> </tbody> </table>	symbol	corner radius	mm	mm	X0	0,04	01	0,1	02	0,2	04	0,4	08	0,8	12	1,2	16	1,6	20	2,0	24	2,4	28	2,8	32	3,2	00	—	M0	round insert	—	—	<p>R = Right hand</p> <p>L = Left hand</p> <p>N = Neutral</p>	<p>F Sharp</p> <p>E Rounded</p> <p>T Chamfered</p> <p>S Chamfered and Rounded</p> <p>K Double-Chamfered</p> <p>P Double-Chamfered and Rounded</p>	<p>13 = Railroad Light</p> <p>CT = Copy Turning</p> <p>FF = Fine Finishing</p> <p>FP = Finish Positive</p> <p>FW = Finish Wiper</p> <p>ML = Medium Light</p> <p>MR = Medium Roughing</p> <p>MW = Medium Wiper</p> <p>RH = Roughing Heavy</p> <p>T = Negative Land</p> <p>UF = Universal Finishing</p> <p>UM = Universal Medium</p> <p>UR = Universal Roughing</p> <p>.NMP = Sharp Medium</p> <p>MP = Medium Positive</p> <p>FS = Finishing High-Temp(S)</p> <p>MS = Medium High-Temp(S)</p> <p>MU = Medium Universal</p> <p>SR = Super Roughing</p> <p>65 = Heavy Roughing</p> <p>8 = Heavy Roughing</p> <p>.NGP = Sharp Medium</p>
symbol	thickness																																																																			
mm	mm																																																																			
—	0,79																																																																			
T0	1,00																																																																			
01	1,59																																																																			
T1	1,98																																																																			
02	2,38																																																																			
03	3,18																																																																			
T3	3,97																																																																			
04	4,76																																																																			
05	5,56																																																																			
06	6,35																																																																			
07	7,94																																																																			
9	9,52																																																																			
11	11,11																																																																			
12	12,70																																																																			
symbol	corner radius																																																																			
mm	mm																																																																			
X0	0,04																																																																			
01	0,1																																																																			
02	0,2																																																																			
04	0,4																																																																			
08	0,8																																																																			
12	1,2																																																																			
16	1,6																																																																			
20	2,0																																																																			
24	2,4																																																																			
28	2,8																																																																			
32	3,2																																																																			
00	—																																																																			
M0	round insert																																																																			
—	—																																																																			

"D"	± Tolerance on "D"					± Tolerance on "B"				
	Class M Tolerance				Class U Tolerance	Class M Tolerance				Class U Tolerance
	Shapes S, T, C, R, & W	Shape D	Shape V	Shapes S, T, & C		Shapes S, T, C, R, & W	Shape D	Shape V	Shapes S, T, & C	
mm	mm	mm	mm	mm	mm	mm	mm	mm	mm	
3,97	0,05	—	—	—	3,97	0,08	—	—	—	
4,76	0,05	—	—	0,08	4,76	0,08	—	—	0,13	
5,56	0,05	0,05	0,05	0,08	5,56	0,08	0,11	—	0,13	
6,35	0,05	0,05	0,05	0,08	6,35	0,08	0,11	—	0,13	
7,94	0,05	0,05	0,05	0,08	7,94	0,08	0,11	—	0,13	
9,52	0,05	0,05	0,05	0,08	9,52	0,08	0,11	0,18	0,13	
11,11	0,08	0,08	0,08	0,13	11,11	0,13	0,15	—	—	
12,70	0,08	0,08	0,08	0,13	12,70	0,13	0,15	0,25	0,20	
14,29	0,08	0,08	0,08	0,13	14,29	0,13	0,15	—	—	
15,88	0,10	0,10	0,10	0,18	15,88	0,15	0,18	—	0,27	
17,46	0,10	0,10	0,10	0,18	17,46	0,15	0,18	—	0,27	
19,05	0,10	0,10	0,10	0,18	19,05	0,15	0,18	—	0,27	
22,22	0,13	—	—	0,25	22,22	0,15	—	—	0,38	
25,40	0,13	—	—	0,25	25,40	0,18	—	—	0,38	
31,75	0,15	—	—	0,25	31,75	0,20	—	—	0,38	

Victory Grade Naming System

ISO turning products featured in the All-Star program provide solutions for applications in steel, stainless steel, cast iron, and high-temp alloys. WIDIA™ Victory turning grades and geometries deliver higher productivity through reduced cycle time, long tool life, and improved chip control.

W	P	15	C	T
Brand	Workpiece Material	Application Range	Insert Material	Application
<p>W = WIDIA</p>	<p>P = Steel M = Stainless Steel K = Cast Iron N = Non Ferrous S = High-Temp Alloys H = Hardened Materials U = Universal Application</p>	<p>05 = Fine Finishing 10 = Finishing 15 = } 20 = } Medium to Roughing 25 = } 30 = } Roughing 35 = } 40 = } 45 = } Heavy Roughing 50 = }</p>	<p>H = Carbide (Uncoated) C = Carbide + CVD P = Carbide + PVD T = Cermet Y = Ceramics D = Diamond B = PCBN S = HSS E = HSS-E M = HSS-E-PM</p>	<p>T = Turning M = Milling H = Holemaking D = Solid Drills E = Solid End Mills G = Taps R = Reamers V = Thread Mills</p>

Cutting Speed Recommendation • P • Metric

Low-Carbon (<0.3% C) and Free-Machining Steel

material group	grade	speed – m/min									Starting Conditions
		135	180	225	275	320	360	410	455	495	m/min
P0/P1	WP05CT	◇									435
	WP15CT	◇									395
	WP25CT	◇									275
	WP35CT	◇									210
	WS10PT/WU10PT	◇									280

Medium- and High-Carbon Steels (>0.3% C)

material group	grade	speed – m/min									Starting Conditions
		135	180	225	275	320	360	410	455	495	m/min
P2	WP05CT	◇									240
	WP15CT	◇									265
	WP25CT	◇									195
	WP35CT	◇									150
	WS10PT/WU10PT	◇									200

Alloy Steels and Tool Steels (≤330 HB) (≤35 HRC)

material group	grade	speed – m/min									Starting Conditions
		135	180	225	275	320	360	410	455	495	m/min
P3	WP05CT	◇									205
	WP15CT	◇									190
	WP25CT	◇									155
	WP35CT	◇									120
	WS10PT/WU10PT	◇									155

Alloy Steels and Tool Steels (340–450 HB) (36–48 HRC)

material group	grade	speed – m/min									Starting Conditions
		60	90	120	150	180	210	240	270	300	m/min
P4	WP05CT	◇									160
	WP15CT	◇									145
	WP25CT	◇									105
	WP35CT	◇									95
	WS10PT/WU10PT	◇									110

Ferritic, Martensitic, and PH Stainless Steels (≤330 HB) (≤35 HRC)

material group	grade	speed – m/min									Starting Conditions
		120	150	180	210	240	270	300	330	360	m/min
P5	WP05CT	◇									240
	WP15CT	◇									215
	WP25CT	◇									195
	WP35CT	◇									135
	WS10PT/WU10PT	◇									200

Ferritic, Martensitic, and PH Stainless Steels (340–450 HB) (36–48 HRC)

material group	grade	speed – m/min									Starting Conditions
		105	135	165	195	225	255	285	315	345	m/min
P6	WP05CT	◇									200
	WP15CT	◇									180
	WP25CT	◇									150
	WP35CT	◇									105
	WS10PT/WU10PT	◇									150

INDEXABLE MILLING

SOLID END MILLING

HOLEMAKING

TAPPING

TURNING

Cutting Speed Recommendation • M • Metric

Austenitic Stainless Steel		speed – m/min										Starting Conditions
material group	grade	90	135	180	225	270	315	360	405	450	m/min	
M1	WM15CT			◊							180	
	WM25CT			◊							150	
	WM35CT		◊								120	
	WS10PT				◊						215	
	WS25PT			◊							180	

Austenitic Stainless Steel		speed – m/min										Starting Conditions
material group	grade	90	135	180	225	270	315	360	405	450	m/min	
M2	WM15CT			◊							165	
	WM25CT			◊							140	
	WM35CT		◊								105	
	WS10PT				◊						200	
	WS25PT			◊							165	

Austenitic Stainless Steel: Duplex (Ferritic and Austenitic Mixture)		speed – m/min										Starting Conditions
material group	grade	90	135	180	225	270	315	360	405	450	m/min	
M3	WM15CT			◊							150	
	WM25CT			◊							120	
	WM35CT		◊								90	
	WS10PT				◊						185	
	WS10PT/WU25PT			◊							150	

Cutting Speed Recommendation • K • Metric

Gray Cast Iron		speed – m/min										Starting Conditions
material group	grade	60	180	305	430	550	675	800	920	1040	1160	m/min
K1	WK05CT				◊							450
	WK15CT			◊								360
	WK20CT			◊								300

Ductile, Compacted Graphite, and Malleable Cast Irons (<600 MPa tensile strength)		speed – m/min										Starting Conditions
material group	grade	90	135	180	225	275	320	360	410	460	500	m/min
K2	WS10PT/WU10PT				◊							200
	WK05CT							◊				360
	WK15CT					◊						270
	WK20CT					◊						240

Ductile, Malleable, and Austempered Cast Irons (>600 MPa tensile strength)		speed – m/min										Starting Conditions
material group	grade	90	135	180	225	275	320	360	410	460	500	m/min
K3	WS10PT/WU10PT			◊								150
	WK05CT				◊							240
	WK15CT					◊						215
	WK20CT				◊							210

Cutting Speed Recommendation • N • Metric

Low-Silicon Aluminum Alloys
(hypoeutectic <12.2% Si) and Magnesium Alloys

material group	grade	Speed – m/min										Starting Conditions
		250	500	750	1000	1250	1500	1750	2000	2250	2500	m/min
N1	WU10HT	◇										488

Low-Silicon Aluminum Alloys
(hypoeutectic <12.2% Si) and Magnesium Alloys

material group	grade	Speed – m/min										Starting Conditions
		250	500	750	1000	1250	1500	1750	2000	2250	2500	m/min
N2	WU10HT	◇										488

High-Silicon Aluminum Alloys
(hypereutectic >12.2% Si) and Magnesium Alloys

material group	grade	Speed – m/min										Starting Conditions
		250	500	750	1000	1250	1500	1750	2000	2250	2500	m/min
N3	WU10HT	◇										488
	WU05PT	◇										550

Copper-, Brass-, Zinc-Based on a Machinability
Index Range of 70–100

material group	grade	Speed – m/min				Starting Conditions
		250	500	750	1000	m/min
N4	WU10HT	◇				259
	WU05PT	◇				275

Nylon, Plastics, Rubbers, Phenolics, Resins,
Fiberglass, and Glass

material group	grade	Speed – m/min				Starting Conditions
		250	500	750	1000	m/min
N5	WU10HT	◇				170
	WU05PT	◇				170

Carbon and Graphite Composites:
Brush Alloys, Kevlar, and Graphite (280–400 HB) (30–43 HRC)

material group	grade	Speed – m/min				Starting Conditions
		250	500	750	1000	m/min
N6	WU05PT	◇				200

MMCs (Aluminum-Based Metal Matrix Composites)

material group	grade	Speed – m/min				Starting Conditions
		250	500	750	1000	m/min
N7	WU10HT	◇				180

Tin Alloys, Cast: ASTM 823, Alloys 1, 2, 3, 11

material group	grade	Speed – m/min				Starting Conditions
		250	500	750	1000	m/min
N8	WU05PT	◇				215

Cutting Speed Recommendation • S • Metric

Iron-Based, Heat-Resistant Alloys (135–320 HB) (≤34 HRC)

material group	grade	speed – m/min										Starting Conditions
		15	45	75	105	140	170	200	230	290	310	m/min
S1	WU10HT	◊										30
	WS10PT/WU10PT	◊										55
	WS25PT/WU25PT	◊										40
	WM15CT	◊										55
	WM25CT/WM35CT	◊										40

Cobalt-Based, Heat-Resistant Alloys (150–425 HB) (≤45 HRC)

material group	grade	speed – m/min										Starting Conditions
		15	45	75	105	140	170	200	230	290	310	m/min
S2	WU10HT	◊										35
	WS10PT/WU10PT	◊										60
	WS25PT/WU25PT	◊										30
	WM15CT	◊										60
	WM25CT/WM35CT	◊										30

Nickel-Based, Heat-Resistant Alloys (140–475 HB) (≤48 HRC)

material group	grade	speed – m/min										Starting Conditions
		15	45	75	105	140	170	200	230	290	310	m/min
S3	WU10HT	◊										40
	WS10PT/WU10PT	◊										70
	WS25PT/WU25PT	◊										40
	WM15CT	◊										70
	WM25CT/WM35CT	◊										40

Titanium and Titanium Alloys (110–450 HB) (≤48 HRC)

material group	grade	speed – m/min										Starting Conditions
		15	45	75	105	140	170	200	230	290	310	m/min
S4	WU10HT	◊										45
	WM15CT	◊										70
	WM25CT/WM35CT	◊										55

Negative Inserts

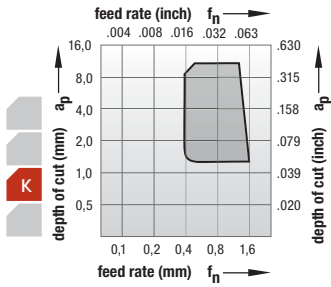

..MA

Flat-top geometry for machining cast iron. For finishing to roughing applications.

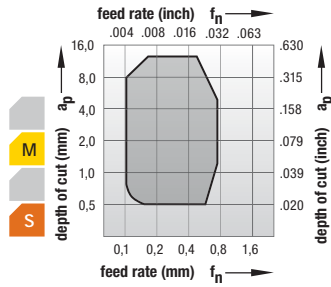

.NMP

For medium-duty machining of tough work materials, such as chrome- and nickel-based alloys. Minimizes tendency for materials to adhere to insert.

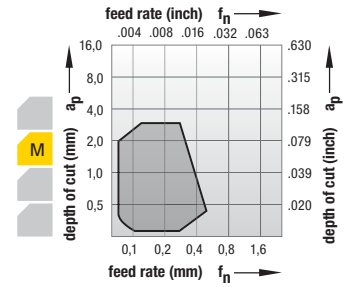

CT

Designed for outward copy turning. Where other geometries produce long chips, the unique distribution of the cut results in good chip control.

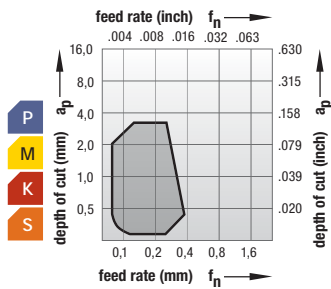

FF

For finish turning, producing smooth, accurate surfaces. Very good chip control, especially at low depths of cut.

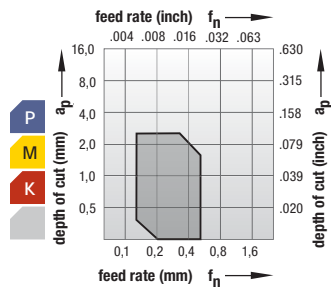

FW

Wiper geometry for finishing when good surface finish is needed using high feed rates. First choice for high-performance finishing.

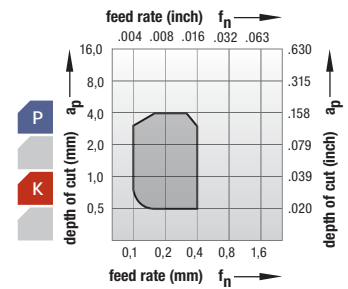

ML

For finishing to medium machining with a negative, stable cutting edge.

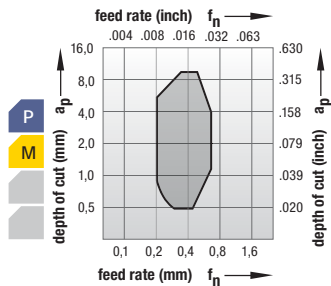

MR

For medium to light roughing of steels, difficult-to-machine high-alloy titanium, and aluminum materials. High strength to deal with heavy chip deformation.

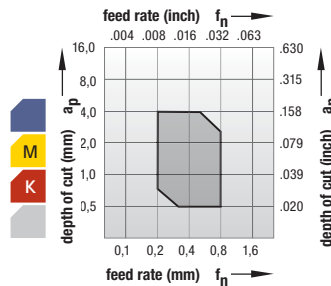

MW

Wiper geometry for light to medium turning with high feed rates. Feed twice as high as with edges with full corner radii to produce same surface finish.

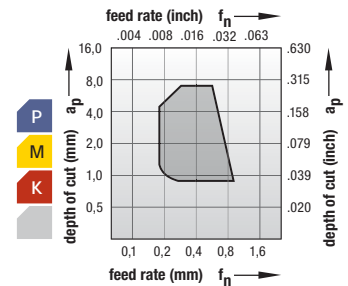

RH

For medium-duty to roughing. Outstanding chip control. High edge strength for interrupted cuts, forging skin, or scale. Preferred for all cast iron, such as gray, malleable, and nodular.

Negative Inserts

INDEXABLE MILLING

SOLID END MILLING

HOLEMAKING

TAPPING

TURNING

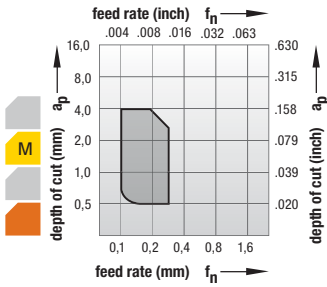

UF
For finishing with a positive cutting edge for reduced cutting forces and superior surface quality.

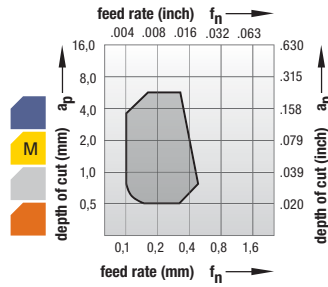

UM
For medium-duty turning operations. Soft-cutting chipbreaker. Used in applications producing varying chip sections, such as profile or copy turning. Good dimensional accuracy. For soft steel materials and stainless steels.

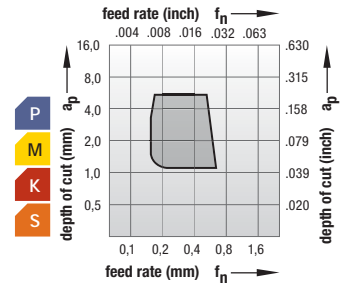

UR
Roughing geometry with smooth chip forming and improved coolant flow for increased tool life. Positive geometry reduces cutting forces and improves depth-of-cut notching resistance. Ideally suitable for stainless steel applications and for smooth machining of steel.

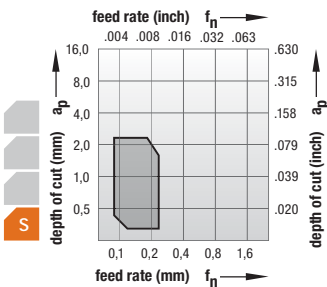

FS
For finishing applications. Ground periphery with positive cutting edge ideally suited for high-temp alloys. Micro-finished edge on the ground periphery adds just a slight hone for improved edge integrity and reliability.

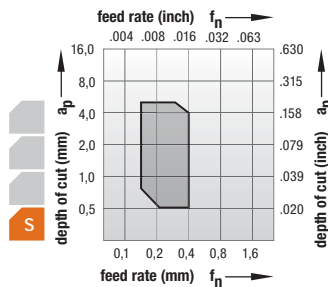

MS
For medium machining in high-temp materials. Utilizes a micro-finished edge preparation to increase edge toughness.

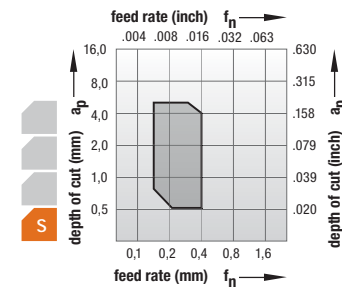

.NGP
For medium-duty machining of tough work materials, such as chrome- and nickel-based alloys. Minimizes tendency for materials to adhere to insert.

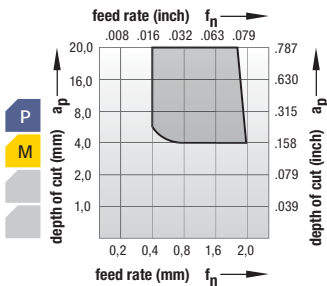

SR
A super-roughing geometry. The -SR has a strong cutting edge to support high cutting loads in roughing applications. Can produce high metal removal rates.

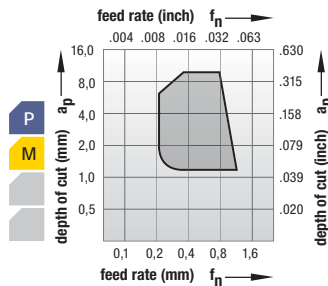

65
Rough-turning geometry with chip control extending to the medium-duty range. Positive rake angle lowers cutting forces, reducing power requirements. Used on low-tensile and stainless steels.

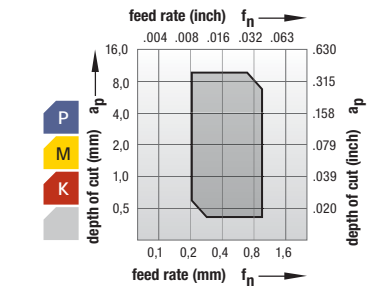

-RU
Positive geometry for smooth cutting. Positive T-land with rake angle to lower cutting forces and improve DOCN resistance. Post-coat grinding of seating surface for secure seating surface. Good edge strength for interrupted cuts, forging skin, and casting surfaces.

Positive Inserts

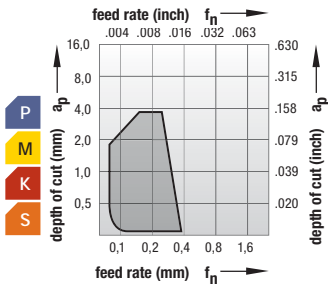

MU

A medium universal geometry with a soft cutting action due to its positive geometry. Has a versatile application range and is suited for turning unstable components and for boring applications.

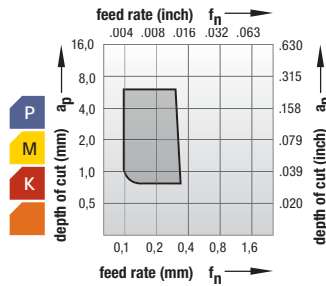

MP

For medium to rough turning with reduced cutting forces and improved chip control for high feed rates. Suitable for high metal removal rates and spindling applications.

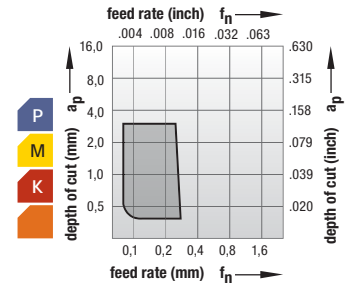

FP

For finishing to medium turning operations with optimal chip control over a wide range of cutting conditions and workpiece materials.

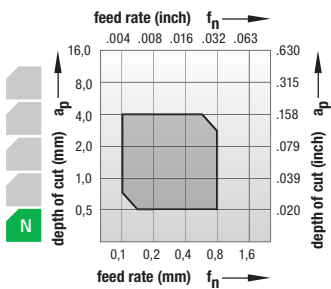

-AL

For cost-effective machining of aluminum, non-ferrous metals, and plastics. Extremely sharp cutting edges result in optimum part finishes with low cutting forces and short chips.

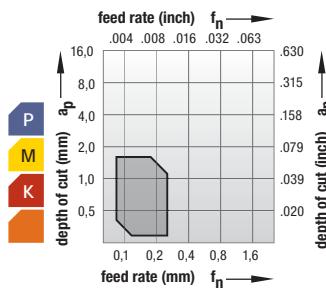

1P

Preferred for light finishing. Low cutting forces and reduced power requirements due to positive rake angle. Good chip control over a wide range.

INDEXABLE MILLING

SOLID END MILLING

HOLEMAKING

TAPPING

TURNING

P Steel Turning



Crankshaft/Camshaft
Roughing and Finishing



Connecting Rods
Boring



Gears
Roughing and Finishing



Input/Output Shafts

M Stainless Steel Turning



Turbo Charger
Roughing and Finishing



Flanges
Roughing and Finishing



Bearing Housing
Roughing and Finishing



Valve Body
Roughing and Finishing

K Cast Iron Turning



Cylinder Liner
Roughing and Finishing



Engine Block



Brake Drum and Disc



Hub
Roughing and Finishing

Grades and Grade Descriptions

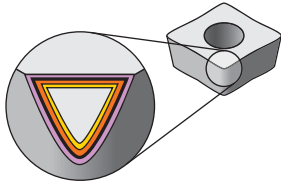

Coatings provide high-speed capability and are engineered for finishing to heavy roughing.

P	Steel
M	Stainless Steel
K	Cast Iron
N	Non-Ferrous
S	High-Temp Alloys
H	Hardened Materials

Grade	Coating	Grade Description	wear resistance ← → toughness																		
			05	10	15	20	25	30	35	40	45										
TTR		Uncoated carbide. Tough grade for medium to rough turning applications in steel. Suitable for interrupted cuts and unfavorable conditions.	P																		
	HW-P35																				
WP20TT		Uncoated cermet. Highly wear-resistant grade suitable for finish turning applications in steel in continuous cuts. Gives excellent surface finish.	P																		
	HT-P05																				
WP05CT		Composition: A deformation-resistant, cobalt-enriched substrate combined with thick MTCVD TiCN-Al ₂ O ₃ coating. Application: For high productivity turning of steels and PH stainless steels in continuous to lightly interrupted cuts. This grade provides excellent combination of toughness and high-speed wear resistance allowing the fastest steel part production. Its unique combination of substrate and coating also makes it an ideal roughing grade for cast iron where chipping resistance is required.	P																		
	HC-P10		K																		
WP15CT		Coated carbide. MT-CVD/CVD — TiN-TiCN-Al ₂ O ₃ -ZrCN. Good balance of wear resistance and toughness properties. High-productivity machining on smooth to lightly interrupted cuts. For steels.	P																		
	HC-P15		K																		
WP25CT		Coated carbide. MT-CVD/CVD — TiN-TiCN-Al ₂ O ₃ -ZrCN. Good toughness properties. Excellent first choice for steel machining, high-productivity metal removal for all but the harshest interrupted cuts.	P																		
	HC-P25		K																		
WP35CT		Coated carbide. MT-CVD/CVD — TiN-TiCN-Al ₂ O ₃ -TiOCN. Proven on all roughing and heavy roughing operations, wet or dry, on interrupted and uninterrupted cuts.	P																		
	HC-P35		M																		

INDEXABLE MILLING

SOLID END MILLING

HOLEMAKING

TAPPING

TURNING

Grades and Grade Descriptions

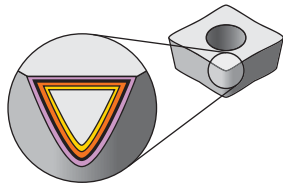

Coatings provide high-speed capability and are engineered for finishing to heavy roughing.

P	Steel
M	Stainless Steel
K	Cast Iron
N	Non-Ferrous
S	High-Temp Alloys
H	Hardened Materials

Grade	Coating	Grade Description	wear resistance ← → toughness																			
			05	10	15	20	25	30	35	40	45											
WM15CT		Coated carbide. MT-CVD/CVD — TiN-TiCN-Al ₂ O ₃ -TiOCN. High degree of wear resistance and good resistance to depth-of-cut notching for long tool life in finishing to medium turning applications.	P																			
	HC-M15		M																			
WM20CT		A multilayer CVD coated carbide grade with TiN-TiCN-Al ₂ O ₃ coating over a wear-resistant substrate. Suitable for general-purpose/medium machining applications in stainless steels at moderate speeds and feeds. The substrate offers very good toughness and the coating provides high wear resistance, ensuring performance even in interrupted cuts with long tool life.	P																			
	HC-K15		M																			
WM25CT		Coated carbide. MT-CVD/CVD — TiN-TiCN-Al ₂ O ₃ -TiOCN. Good balance of wear resistance and toughness properties. Light and medium machining. For austenitic stainless steel AISI series.	P																			
	HC-M25		M																			
WM35CT		Coated carbide. MT-CVD/CVD — TiN-TiCN-Al ₂ O ₃ -TiOCN. Good toughness and wear resistance balance. For medium to roughing operations with light and heavily interrupted cuts.	P																			
	HC-M35		M																			
THM		Uncoated carbide. Extraordinary balance of toughness, wear resistance, edge stability. Suitable for light to medium turning applications in continuous and light interrupted cuts in materials like cast iron and non-ferrous metals.	P																			
	HW-K15		K																			
WK05CT		Coated carbide. MT-CVD/CVD — TiN-TiCN-Al ₂ O ₃ . Increased wear resistance for long tool life at high cutting speeds. Enhanced edge strength against depth-of-cut notching in interrupted cuts. Maximum wear resistance for long tool life at high cutting speeds in finish to medium machining.	P																			
	HC-K05		K																			

Grades and Grade Descriptions

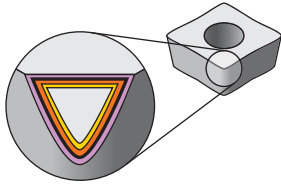

Coatings provide high-speed capability and are engineered for finishing to heavy roughing.

P	Steel
M	Stainless Steel
K	Cast Iron
N	Non-Ferrous
S	High-Temp Alloys
H	Hardened Materials

Grade	Coating	Grade Description	wear resistance ← → toughness												
			05	10	15	20	25	30	35	40	45				
WK15CT		Composition: A multilayered coating with moderately thick MTCVD TiCN-Al ₂ O ₃ layers over a highly deformation-resistant carbide substrate. Application: Designed for high-speed machining of gray and ductile irons. The substrate and coating architecture together with post-coat treatment ensure a tremendous tool life advantage, especially when cutting higher tensile strength ductile and gray irons where workpiece size consistency and reliability of tool life are critical. Excellent both in continuous cuts and varied depths of cut.	P												
	HC-M20		K												
WK20CT		Coated carbide. MT-CVD/CVD — TiN-TiCN-Al ₂ O ₃ . First choice for a wide range of machining on all gray and ductile irons, light to heavy machining, smooth or interrupted cuts, and wet or dry.	P												
	HC-K20		K												
WS10PT		An advanced multilayer PVD coating over a very deformation-resistant unalloyed carbide substrate. The new and improved coating improves edge stability with wide range speed and feed capabilities. WS10PT™ is ideal for finishing to general machining of most workpiece materials at a wide range of speed and feed capabilities. Excellent for machining most steels, stainless steels, cast irons, non-ferrous materials, and super alloys with improved edge toughness and higher cutting speed and feed capabilities.	P												
			M												
			K												
			N												
			S												
			H												
WS25PT		An advanced PVD grade with hard AlTiN coating and fine-grain unalloyed substrate. The new and improved coating improves edge stability with wide range speed and feed capabilities. WS25PT™ is ideal for general machining of most steels, stainless steels, high-temp alloys, titanium, irons, and non-ferrous materials at moderate speeds and over a wide range of feeds, with improved edge toughness for interrupted cut and high feed rates.	P												
			M												
			K												
			N												
			S												
WU10HT		Uncoated carbide. Highly wear-resistant microfine substrate. Suitable for finish turning applications in aluminum and all types of non-ferrous materials, stainless steel, and high-temp alloys with suitable edge preparation. Mainly applied in continuous cuts.	M												
			N												
			S												
			H												
WU05PT		Coated carbide. PVD AlTiN-coated grade with microfine substrate and highly wear-resistant coating. Suitable for finish turning in aluminum and other non-ferrous materials and also steels, stainless steel, and high-temp alloys with reliability in continuous cuts with suitable edge preparation.	P												
			M												
			K												
			N												
			S												

Grades and Grade Descriptions

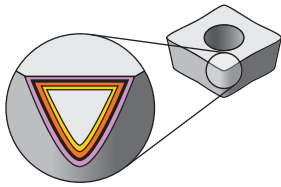

Coatings provide high-speed capability and are engineered for finishing to heavy roughing.

P	Steel
M	Stainless Steel
K	Cast Iron
N	Non-Ferrous
S	High-Temp Alloys
H	Hardened Materials

Grade	Coating	Grade Description	wear resistance ← → toughness																	
			05	10	15	20	25	30	35	40	45									
WU10PT	HC-P10	The WU10PT grade is ideal for finishing to general machining of most workpiece materials at higher speeds. Excellent for machining most steels, stainless steels, cast irons, and super alloys under stable conditions.	P																	
			M																	
			K																	
			S																	
			H																	
WU25PT	HC-P25	An advanced PVD-Al TiN-coated grade with a tough, ultra-fine-grain, unalloyed substrate. For general-purpose machining of most steels, stainless steels, high-temperature alloys, titanium alloys, and cast irons.	P																	
			M																	
			K																	
			S																	
			H																	



CCMT-FP • Finishing Positive

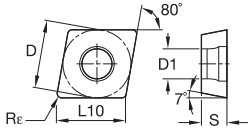

- first choice
- alternate choice

P	●	●	●	●	○	○	○	○	○	○	○	○	○	○	○	○	○	○	○	○	○	○	○	○	○
M	●	○	○	○	○	○	○	○	○	○	○	○	○	○	○	○	○	○	○	○	○	○	○	○	○
K	○	○	○	○	○	○	○	○	○	○	○	○	○	○	○	○	○	○	○	○	○	○	○	○	○
N	○	○	○	○	○	○	○	○	○	○	○	○	○	○	○	○	○	○	○	○	○	○	○	○	○
S	○	○	○	○	○	○	○	○	○	○	○	○	○	○	○	○	○	○	○	○	○	○	○	○	○
H	○	○	○	○	○	○	○	○	○	○	○	○	○	○	○	○	○	○	○	○	○	○	○	○	○

ISO catalogue number	D	L10	S	Rε	D1	WP05CT	WP15CT	WP25CT	WP35CT	WNM15CT	WNM25CT	WNM35CT	WK05CT	WK15CT	WK20CT	WS10PT	WS25PT	WU10HT	WU05PT	WP20TT	THM	TTR	WM20CT	WU10PT	WU25PT
CCMT060202FP	6,35	6,45	2,38	0,2	2,80	○	○	○	○	○	○	○	○	○	○	○	○	○	○	○	○	○	○	○	○
CCMT060204FP	6,35	6,45	2,38	0,4	2,80	○	●	○	○	○	○	○	○	○	○	○	○	○	○	○	○	○	○	○	○
CCMT060208FP	6,35	6,45	2,38	0,8	2,80	○	○	○	○	○	○	○	○	○	○	○	○	○	○	○	○	○	○	○	○
CCMT09T302FP	9,53	9,67	3,97	0,2	4,40	○	○	○	○	○	○	○	○	○	○	○	○	○	○	○	○	○	○	○	○
CCMT09T304FP	9,53	9,67	3,97	0,4	4,40	○	○	○	○	○	○	○	○	○	○	○	○	○	○	○	○	○	○	○	○
CCMT09T308FP	9,53	9,67	3,97	0,8	4,40	○	○	○	○	○	○	○	○	○	○	○	○	○	○	○	○	○	○	○	○
CCMT120404FP	12,70	12,90	4,76	0,4	5,50	○	○	○	○	○	○	○	○	○	○	○	○	○	○	○	○	○	○	○	○
CCMT120408FP	12,70	12,90	4,76	0,8	5,50	○	○	○	○	○	○	○	○	○	○	○	○	○	○	○	○	○	○	○	○

INDEXABLE MILLING

SOLID END MILLING

HOLEMAKING

TAPPING

TURNING

CCMT-MP • Medium Positive

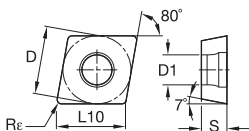

● first choice
○ alternate choice

P	M	K	N	S	H	WP05CT	WP15CT	WP25CT	WP35CT	WM15CT	WM25CT	WM35CT	WK05CT	WK15CT	WK20CT	WS10PT	WS25PT	WU10HT	WU05PT	WP20TT	THM	TTR	WM20CT	WU10PT	WU25PT
●	●	○	○	○	○	○	○	○	○	○	○	○	○	○	○	○	○	○	○	○	○	○	○	○	○
●	●	○	○	○	○	○	○	○	○	○	○	○	○	○	○	○	○	○	○	○	○	○	○	○	○
○	○	○	○	○	○	○	○	○	○	○	○	○	○	○	○	○	○	○	○	○	○	○	○	○	○
○	○	○	○	○	○	○	○	○	○	○	○	○	○	○	○	○	○	○	○	○	○	○	○	○	○
○	○	○	○	○	○	○	○	○	○	○	○	○	○	○	○	○	○	○	○	○	○	○	○	○	○
○	○	○	○	○	○	○	○	○	○	○	○	○	○	○	○	○	○	○	○	○	○	○	○	○	○
○	○	○	○	○	○	○	○	○	○	○	○	○	○	○	○	○	○	○	○	○	○	○	○	○	○
○	○	○	○	○	○	○	○	○	○	○	○	○	○	○	○	○	○	○	○	○	○	○	○	○	○
○	○	○	○	○	○	○	○	○	○	○	○	○	○	○	○	○	○	○	○	○	○	○	○	○	○
○	○	○	○	○	○	○	○	○	○	○	○	○	○	○	○	○	○	○	○	○	○	○	○	○	○
○	○	○	○	○	○	○	○	○	○	○	○	○	○	○	○	○	○	○	○	○	○	○	○	○	○
○	○	○	○	○	○	○	○	○	○	○	○	○	○	○	○	○	○	○	○	○	○	○	○	○	○

ISO catalogue number	D	L10	S	Re	D1
CCMT060204MP	6,35	6,45	2,38	0,4	2,80
CCMT09T304MP	9,53	9,67	3,97	0,4	4,40
CCMT09T308MP	9,53	9,67	3,97	0,8	4,40
CCMT09T312MP	9,53	9,67	3,97	1,2	4,40
CCMT120408MP	12,70	12,90	4,76	0,8	5,50
CCMT120412MP	12,70	12,90	4,76	1,2	5,50

CCMT-MU • Medium Universal

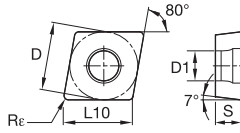

● first choice
○ alternate choice

ISO catalogue number	D	L10	S	R ϵ	D1	Material Groups																			
						P	M	K	N	S	H														
						WP05CT	WP15CT	WP25CT	WP35CT	WM15CT	WM25CT	WM35CT	WK05CT	WK15CT	WK20CT	WS10PT	WS25PT	WU10HT	WU05PT	WP20TT	THM	TTR	WM20CT	WU10PT	WU25PT
CCMT060208MU	6,35	6,45	2,38	0,8	2,80																				
CCMT090304MU	9,53	9,67	3,18	0,4	4,40			5623420			5623421				6208257								6942279	6868872	
CCMT090308MU	9,53	9,67	3,18	0,8	4,40		5623425	5623424			5623423				6208258										
CCMT09T3041P	9,53	9,67	3,97	0,4	4,40																			6869663	
CCMT09T304MU	9,53	9,67	3,97	0,4	4,40			5623431	5623430		5623427		5623429		5623432	5623428	5623426							6942280	6868873
CCMT09T3081P	9,53	9,67	3,97	0,8	4,40																			6869664	
CCMT09T308MU	9,53	9,67	3,97	0,8	4,40			5623434	5623436	5623439		5623435				5623433	5623438	5623437						6942341	6868874
CCMT120404MU	12,70	12,90	4,76	0,4	5,50			6128256				6128254					6128258								
CCMT120408MU	12,70	12,90	4,76	0,8	5,50		5623440	5623443							5623441		5623444								

INDEXABLE MILLING

SOLID END MILLING

HOLEMAKING

TAPPING

TURNING

CCMW • Medium Machining

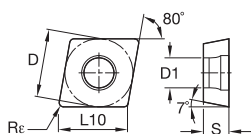
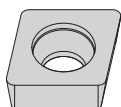

● first choice
○ alternate choice

P	M	K	N	S	H	WP05CT	WP15CT	WP25CT	WP35CT	WM15CT	WM25CT	WM35CT	WK05CT	WK15CT	WK20CT	WS10PT	WS25PT	WU10HT	WU05PT	WP20TT	THM	TTR	WM20CT	WU10PT	WU25PT	
●	●	●	●	●	●	○	○	○	○	○	○	○	○	○	○	○	○	○	○	○	○	○	○	○	○	○
●	●	○	○	○	○	○	○	○	○	○	○	○	○	○	○	○	○	○	○	○	○	○	○	○	○	○
●	●	○	○	○	○	○	○	○	○	○	○	○	○	○	○	○	○	○	○	○	○	○	○	○	○	○
●	●	○	○	○	○	○	○	○	○	○	○	○	○	○	○	○	○	○	○	○	○	○	○	○	○	○
●	●	○	○	○	○	○	○	○	○	○	○	○	○	○	○	○	○	○	○	○	○	○	○	○	○	○

ISO catalogue number	D	L10	S	Rε	D1	WP05CT	WP15CT	WP25CT	WP35CT	WM15CT	WM25CT	WM35CT	WK05CT	WK15CT	WK20CT	WS10PT	WS25PT	WU10HT	WU05PT	WP20TT	THM	TTR	WM20CT	WU10PT	WU25PT	
CCMW060202	6,35	6,45	2,38	0,2	2,80	○	○	○	○	○	○	○	○	○	○	○	○	○	○	○	○	○	○	○	○	○
CCMW060204	6,35	6,45	2,38	0,4	2,84	○	○	○	○	○	○	○	○	○	○	○	○	○	○	○	○	○	○	○	○	○
CCMW060204	6,35	6,45	2,38	0,4	2,84	○	○	○	○	○	○	○	○	○	4170368	○	○	○	○	○	○	○	○	○	○	○
CCMW090302	9,53	9,67	3,18	0,2	4,40	○	○	○	○	○	○	○	○	○	○	○	○	○	○	○	○	○	○	○	○	○
CCMW090304	9,53	9,67	3,18	0,4	4,40	○	○	○	○	○	○	○	○	○	○	○	○	○	○	○	○	○	○	○	○	○
CCMW090304	9,53	9,67	3,18	0,4	4,45	○	○	○	○	○	○	○	○	○	4170369	○	○	○	○	○	○	○	○	○	○	○
CCMW090308	9,53	9,67	3,18	0,8	4,45	○	○	○	○	○	○	○	4170466	4170370	○	○	○	○	○	○	○	○	○	○	○	○
CCMW09T304	9,53	9,67	3,97	0,4	4,45	○	○	○	○	○	○	○	4170467	4170371	○	○	○	○	○	○	○	○	○	○	○	○
CCMW09T308	9,53	9,67	3,97	0,8	4,40	○	○	○	○	○	○	○	○	○	○	○	○	○	○	○	○	○	○	○	○	○
CCMW120404	12,70	12,90	4,76	0,4	5,50	○	○	○	○	○	○	○	○	○	○	○	○	○	○	○	○	○	○	○	○	○
CCMW120408	12,70	12,90	4,76	0,8	5,50	○	○	○	○	○	○	○	○	○	○	○	○	○	○	○	○	○	○	○	○	○
CCMW120408	12,70	12,90	4,76	0,8	5,50	○	○	○	○	○	○	○	○	○	4170374	○	○	○	○	○	○	○	○	○	○	○

INDEXABLE MILLING

SOLID END MILLING

HOLEMAKING

TAPPING

TURNING

CNGG-FS • Finishing Sharp

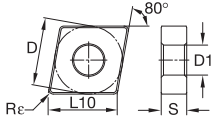
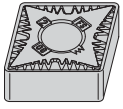

● first choice
○ alternate choice

P	M	K	N	S	H	WP05CT	WP15CT	WP25CT	WP35CT	WM15CT	WM25CT	WM35CT	WK05CT	WK15CT	WK20CT	WS10PT	WS25PT	WU10HT	WU05PT	WP20TT	THM	TTR	WM20CT	WU10PT	WU25PT	
●	●	●	●	●	●	○	○	○	○	○	○	○	○	○	○	○	○	○	○	○	○	○	○	○	○	○
○	○	○	○	○	○	○	○	○	○	○	○	○	○	○	○	○	○	○	○	○	○	○	○	○	○	○
○	○	○	○	○	○	○	○	○	○	○	○	○	○	○	○	○	○	○	○	○	○	○	○	○	○	○
○	○	○	○	○	○	○	○	○	○	○	○	○	○	○	○	○	○	○	○	○	○	○	○	○	○	○
○	○	○	○	○	○	○	○	○	○	○	○	○	○	○	○	○	○	○	○	○	○	○	○	○	○	○
○	○	○	○	○	○	○	○	○	○	○	○	○	○	○	○	○	○	○	○	○	○	○	○	○	○	○
○	○	○	○	○	○	○	○	○	○	○	○	○	○	○	○	○	○	○	○	○	○	○	○	○	○	○
○	○	○	○	○	○	○	○	○	○	○	○	○	○	○	○	○	○	○	○	○	○	○	○	○	○	○
○	○	○	○	○	○	○	○	○	○	○	○	○	○	○	○	○	○	○	○	○	○	○	○	○	○	○
○	○	○	○	○	○	○	○	○	○	○	○	○	○	○	○	○	○	○	○	○	○	○	○	○	○	○
○	○	○	○	○	○	○	○	○	○	○	○	○	○	○	○	○	○	○	○	○	○	○	○	○	○	○
○	○	○	○	○	○	○	○	○	○	○	○	○	○	○	○	○	○	○	○	○	○	○	○	○	○	○
○	○	○	○	○	○	○	○	○	○	○	○	○	○	○	○	○	○	○	○	○	○	○	○	○	○	○

ISO catalogue number	D	L10	S	Rε	D1
CNGG120401FS	12,70	12,90	4,76	0,1	5,16
CNGG120402FS	12,70	12,90	4,76	0,2	5,16
CNGG120404FS	12,70	12,90	4,76	0,4	5,16
CNGG120408FS	12,70	12,90	4,76	0,8	5,16
CNGG120412FS	12,70	12,90	4,76	1,2	5,16

CNGP • Medium Machining

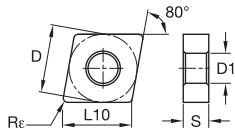
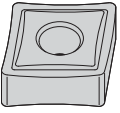

● first choice
○ alternate choice

ISO catalogue number	D	L10	S	R ϵ	D1	WP05CT	WP15CT	WP25CT	WP35CT	WM15CT	WM25CT	WM35CT	WK05CT	WK15CT	WK20CT	WS10PT	WS25PT	WU10HT	WU05PT	WP20TT	THM	TTR	WM20CT	WU10PT	WU25PT	
																			5549137 5549138 5549139	5549206 5549207						
CNGP120401	12,70	12,90	4,76	0,1	5,16	○	○	○	○	○	○	○	○	○	○	○	○	○	○	○	○	○	○	○	○	○
CNGP120402	12,70	12,90	4,76	0,2	5,16	○	○	○	○	○	○	○	○	○	○	○	○	○	○	○	○	○	○	○	○	○
CNGP120404	12,70	12,90	4,76	0,4	5,16	○	○	○	○	○	○	○	○	○	○	○	○	○	○	○	○	○	○	○	○	○
CNGP120408	12,70	12,90	4,76	0,8	5,16	○	○	○	○	○	○	○	○	○	○	○	○	○	○	○	○	○	○	○	○	○

INDEXABLE MILLING

SOLID END MILLING

HOLEMAKING

TAPPING

TURNING

CNMA • Roughing

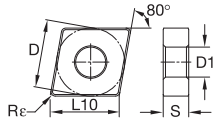
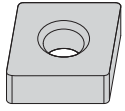

● first choice
○ alternate choice

ISO catalogue number	D	L10	S	Rε	D1	WP05CT	WP15CT	WP25CT	WP35CT	WM15CT	WM25CT	WM35CT	WK05CT	WK15CT	WK20CT	WS10PT	WS25PT	WU10HT	WU05PT	WP20TT	THM	TTR	WM20CT	WU10PT	WU25PT
CNMA120404	12,70	12,90	4,76	0,4	5,16	○	○	○	○	○	○	○	○	○	○	○	○	○	○	○	○	○	○	○	○
CNMA120404	12,70	12,90	4,76	0,4	5,16	○	○	○	○	○	○	○	○	○	○	○	○	○	○	○	○	○	○	○	○
CNMA120408	12,70	12,90	4,76	0,8	5,16	○	○	○	○	○	○	○	○	○	○	○	○	○	○	○	○	○	○	○	○
CNMA120408	12,70	12,90	4,76	0,8	5,16	○	○	○	○	○	○	○	○	○	○	○	○	○	○	○	○	○	○	○	○
CNMA120412	12,70	12,90	4,76	1,2	5,16	○	○	○	○	○	○	○	○	○	○	○	○	○	○	○	○	○	○	○	○
CNMA120416	12,70	12,90	4,76	1,6	5,16	○	○	○	○	○	○	○	○	○	○	○	○	○	○	○	○	○	○	○	○
CNMA160612	15,88	16,12	6,35	1,2	6,35	○	○	○	○	○	○	○	○	○	○	○	○	○	○	○	○	○	○	○	○
CNMA160616	15,88	16,12	6,35	1,6	6,35	○	○	○	○	○	○	○	○	○	○	○	○	○	○	○	○	○	○	○	○
CNMA190608	19,05	19,34	6,35	0,8	7,93	○	○	○	○	○	○	○	○	○	○	○	○	○	○	○	○	○	○	○	○
CNMA190612	19,05	19,34	6,35	1,2	7,93	○	○	○	○	○	○	○	○	○	○	○	○	○	○	○	○	○	○	○	○
CNMA190616	19,05	19,34	6,35	1,6	7,93	○	○	○	○	○	○	○	○	○	○	○	○	○	○	○	○	○	○	○	○

INDEXABLE MILLING

SOLID END MILLING

HOLE MAKING

TAPPING

TURNING

CNMG • Roughing

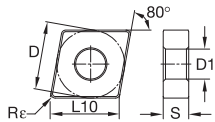
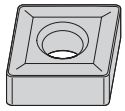

● first choice
○ alternate choice

P	M	K	N	S	H	WP05CT	WP15CT	WP25CT	WP35CT	WM15CT	WM25CT	WM35CT	WK05CT	WK15CT	WK20CT	WS10PT	WS25PT	WU10HT	WU05PT	WP20TT	THM	TTR	WM20CT	WU10PT	WU25PT	
●	●	●	●	●	●	●	●	●	●	○	○	○	○	○	○	○	○	○	○	○	○	○	○	○	○	○
●	●	○	○	○	○	○	○	○	○	○	○	○	○	○	○	○	○	○	○	○	○	○	○	○	○	
●	●	○	○	○	○	○	○	○	○	○	○	○	○	○	○	○	○	○	○	○	○	○	○	○	○	
●	○	○	○	○	○	○	○	○	○	○	○	○	○	○	○	○	○	○	○	○	○	○	○	○	○	
○	○	○	○	○	○	○	○	○	○	○	○	○	○	○	○	○	○	○	○	○	○	○	○	○	○	
○	○	○	○	○	○	○	○	○	○	○	○	○	○	○	○	○	○	○	○	○	○	○	○	○	○	

ISO catalogue number	D	L10	S	Rε	D1	WP05CT	WP15CT	WP25CT	WP35CT	WM15CT	WM25CT	WM35CT	WK05CT	WK15CT	WK20CT	WS10PT	WS25PT	WU10HT	WU05PT	WP20TT	THM	TTR	WM20CT	WU10PT	WU25PT	
CNMG120404	12,70	12,90	4,76	0,4	5,16									6613606								2559561				
CNMG120408	12,70	12,90	4,76	0,8	5,16																	2027567				
CNMG190612	19,05	19,34	6,35	1,2	7,93																	2559382				

CNMG-5 • Roughing

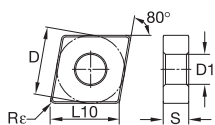
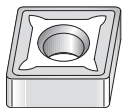

● first choice
○ alternate choice

P	M	K	N	S	H	WP05CT	WP15CT	WP25CT	WP35CT	WM15CT	WM25CT	WM35CT	WK05CT	WK15CT	WK20CT	WS10PT	WS25PT	WU10HT	WU05PT	WP20TT	THM	TTR	WM20CT	WU10PT	WU25PT
●	●	●	●	●	●	●	●	●	●	○	○	○	○	○	○	○	○	○	○	○	○	○	○	○	○
●	●	○	○	○	○	○	○	○	○	○	○	○	○	○	○	○	○	○	○	○	○	○	○	○	○
●	●	○	○	○	○	○	○	○	○	○	○	○	○	○	○	○	○	○	○	○	○	○	○	○	○
○	○	○	○	○	○	○	○	○	○	○	○	○	○	○	○	○	○	○	○	○	○	○	○	○	○
○	○	○	○	○	○	○	○	○	○	○	○	○	○	○	○	○	○	○	○	○	○	○	○	○	○

ISO catalogue number	D	L10	S	Rε	D1	WP05CT	WP15CT	WP25CT	WP35CT	WM15CT	WM25CT	WM35CT	WK05CT	WK15CT	WK20CT	WS10PT	WS25PT	WU10HT	WU05PT	WP20TT	THM	TTR	WM20CT	WU10PT	WU25PT
CNMG120408-5	12,70	12,90	4,76	0,8	5,16									6287924											
CNMG120412-5	12,70	12,90	4,76	1,2	5,16									6287925											

CNMG-FF • Fine Finishing

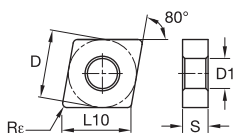
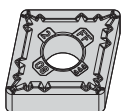

● first choice

○ alternate choice

ISO catalogue number	D	L10	S	Rε	D1	WP05CT	WP15CT	WP25CT	WP35CT	WM15CT	WM25CT	WM35CT	WK05CT	WK15CT	WK20CT	WS10PT	WS25PT	WU10HT	WU05PT	WP20TT	THM	TTR	WM20CT	WU10PT	WU25PT	
CNMG120404FF	12,70	12,90	4,76	0,4	5,16	●	●	●	●	○	○	○	○	○	○	○	○	○	○	○	○	○	○	○	○	○
CNMG120408FF	12,70	12,90	4,76	0,8	5,16	○	○	○	○	○	○	○	○	○	○	○	○	○	○	○	○	○	○	○	○	
CNMG120412FF	12,70	12,90	4,76	1,2	5,16	○	○	○	○	○	○	○	○	○	○	○	○	○	○	○	○	○	○	○	○	

CNMG-FW • Finishing Wiper

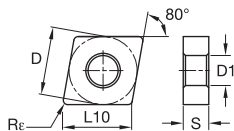
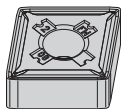

● first choice

○ alternate choice

ISO catalogue number	D	L10	S	Rε	D1	WP05CT	WP15CT	WP25CT	WP35CT	WM15CT	WM25CT	WM35CT	WK05CT	WK15CT	WK20CT	WS10PT	WS25PT	WU10HT	WU05PT	WP20TT	THM	TTR	WM20CT	WU10PT	WU25PT
CNMG120408FW	12,70	12,90	4,76	0,8	5,16	○	○	○	○	○	○	○	○	○	○	○	○	○	○	○	○	○	○	○	○

CNMG-ML • Medium Machining

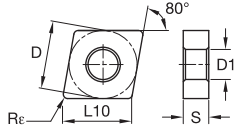
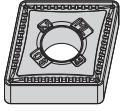

● first choice
○ alternate choice

ISO catalogue number	D	L10	S	R _ε	D1	WP05CT	WP15CT	WP25CT	WP35CT	WM15CT	WM25CT	WM35CT	WK05CT	WK15CT	WK20CT	WS10PT	WS25PT	WU10HT	WU05PT	WP20TT	THM	TTR	WM20CT	WU10PT	WU25PT	
CNMG120404ML	12,70	12,90	4,76	0,4	5,16	-	4171059	4170458	-	-	-	-	-	-	4171390	-	-	-	-	-	-	-	-	-	-	
CNMG120408ML	12,70	12,90	4,76	0,8	5,16	-	4171060	4170459	-	-	-	-	4171658	-	4171391	-	-	-	-	-	-	-	-	-	-	-
CNMG120412ML	12,70	12,90	4,76	1,2	5,16	-	4170460	-	-	-	-	-	-	4171392	-	-	-	-	-	-	-	-	-	-	-	-

P	●	●	●	●	●	●	○	○	○	○	○	○	○	○	○	○	○	○	○	○	○	○	○	○	○
M	●	○	○	○	○	○	○	○	○	○	○	○	○	○	○	○	○	○	○	○	○	○	○	○	○
K	○	○	○	○	○	○	○	○	○	○	○	○	○	○	○	○	○	○	○	○	○	○	○	○	○
N	○	○	○	○	○	○	○	○	○	○	○	○	○	○	○	○	○	○	○	○	○	○	○	○	○
S	○	○	○	○	○	○	○	○	○	○	○	○	○	○	○	○	○	○	○	○	○	○	○	○	○
H	○	○	○	○	○	○	○	○	○	○	○	○	○	○	○	○	○	○	○	○	○	○	○	○	○

INDEXABLE MILLING

SOLID END MILLING

HOLEMAKING

TAPPING

TURNING

CNMG-MR • Medium Roughing

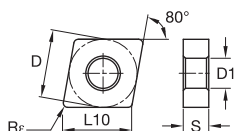
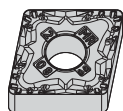

● first choice
○ alternate choice

P	M	K	N	S	H		WP05CT	WP15CT	WP25CT	WP35CT	WM15CT	WM25CT	WM35CT	WK05CT	WK15CT	WK20CT	WS10PT	WS25PT	WU10HT	WU05PT	WP20TT	THM	TTR	WM20CT	WU10PT	WU25PT	
●	●	●	●	●	●																						
●	●	●	●	●	●																						
○	○	○	○	○	○																						
○	○	○	○	○	○																						
○	○	○	○	○	○																						
○	○	○	○	○	○																						
○	○	○	○	○	○																						
○	○	○	○	○	○																						
○	○	○	○	○	○																						
○	○	○	○	○	○																						
○	○	○	○	○	○																						
○	○	○	○	○	○																						
○	○	○	○	○	○																						
○	○	○	○	○	○																						
○	○	○	○	○	○																						
○	○	○	○	○	○																						
○	○	○	○	○	○																						
○	○	○	○	○	○																						
○	○	○	○	○	○																						
○	○	○	○	○	○																						

ISO catalogue number	D	L10	S	Rε	D1
CNMG120404MR	12,70	12,90	4,76	0,4	5,16
CNMG120408MR	12,70	12,90	4,76	0,8	5,16
CNMG120412MR	12,70	12,90	4,76	1,2	5,16
CNMG120416MR	12,70	12,90	4,76	1,6	5,16
CNMG160608MR	15,88	16,12	6,35	0,8	6,35
CNMG160612MR	15,88	16,12	6,35	1,2	6,35
CNMG160616MR	15,88	16,12	6,35	1,6	6,35
CNMG190612MR	19,05	19,34	6,35	1,2	7,93
CNMG190616MR	19,05	19,34	6,35	1,6	7,93

CNMG-MW • Medium Wiper

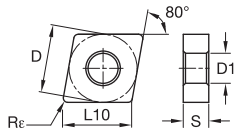
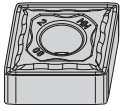

● first choice
○ alternate choice

ISO catalogue number	D	L10	S	R _ε	D1	WP05CT	WP15CT	WP25CT	WP35CT	WM15CT	WM25CT	WM35CT	WK05CT	WK15CT	WK20CT	WS10PT	WS25PT	WU10HT	WU05PT	WP20TT	TTHM	TTR	WM20CT	WU10PT	WU25PT
CNMG120408MW	12,70	12,90	4,76	0,8	5,16	●	●	●	●	○	○	○	○	○	○	○	○	○	○	○	○	○	○	○	○
CNMG120412MW	12,70	12,90	4,76	1,2	5,16	●	●	●	●	○	○	○	○	○	○	○	○	○	○	○	○	○	○	○	

CNMG-RH • Roughing

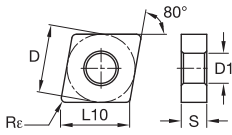
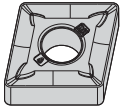

● first choice
○ alternate choice

P	M	K	N	S	H	WP05CT	WP15CT	WP25CT	WP35CT	WM15CT	WM25CT	WM35CT	WK05CT	WK15CT	WK20CT	WS10PT	WS25PT	WU10HT	WU05PT	WP20TT	THM	TTR	WM20CT	WU10PT	WU25PT	
●	●	●	●	●	●	●	●	●	○	○	○	○	○	○	○	○	○	○	○	○	○	○	○	○	○	○
●	○	○	○	○	○	○	○	○	○	○	○	○	○	○	○	○	○	○	○	○	○	○	○	○	○	○
○	○	○	○	○	○	○	○	○	○	○	○	○	○	○	○	○	○	○	○	○	○	○	○	○	○	○
○	○	○	○	○	○	○	○	○	○	○	○	○	○	○	○	○	○	○	○	○	○	○	○	○	○	○
○	○	○	○	○	○	○	○	○	○	○	○	○	○	○	○	○	○	○	○	○	○	○	○	○	○	○
ISO catalogue number	D	L10	S	Rε	D1	WP05CT	WP15CT	WP25CT	WP35CT	WM15CT	WM25CT	WM35CT	WK05CT	WK15CT	WK20CT	WS10PT	WS25PT	WU10HT	WU05PT	WP20TT	THM	TTR	WM20CT	WU10PT	WU25PT	
CNMG120408RH	12,70	12,90	4,76	0,8	5,16	-	4170979	4171504	5684356	-	-	-	-	6288264	4171903	-	-	-	-	-	-	-	-	-	-	-
CNMG120412RH	12,70	12,90	4,76	1,2	5,16	-	4170980	4171505	4171698	4173036	-	-	-	6288265	4171904	-	-	-	-	-	-	-	-	-	-	-
CNMG120416RH	12,70	12,90	4,76	1,6	5,16	-	4170981	4171506	4171699	-	-	-	-	-	4171905	-	-	-	-	-	-	-	-	-	-	-
CNMG160608RH	15,88	16,12	6,35	0,8	6,35	-	4170982	4171507	4171700	4173038	-	-	-	-	4171906	-	-	-	-	-	-	-	-	-	-	-
CNMG160612RH	15,88	16,12	6,35	1,2	6,35	-	4170983	4171508	4171701	-	-	-	-	-	4171907	-	-	-	-	-	-	-	-	-	-	-
CNMG160616RH	15,88	16,12	6,35	1,6	6,35	-	4170984	4171509	4171702	-	-	-	-	-	4171908	-	-	-	-	-	-	-	-	-	-	-
CNMG190608RH	19,05	19,34	6,35	0,8	7,93	-	4170985	4171510	4171703	4173041	-	-	-	-	4171909	-	-	-	-	-	-	-	-	-	-	-
CNMG190612RH	19,05	19,34	6,35	1,2	7,93	-	4170986	4171511	4171704	4173042	-	-	-	-	4171910	-	-	-	-	-	-	-	-	-	-	-
CNMG190616RH	19,05	19,34	6,35	1,6	7,93	-	4170987	4171512	4171705	4173043	-	-	-	-	4171911	-	-	-	-	-	-	-	-	-	-	-
CNMG190624RH	19,05	19,34	6,35	2,4	7,93	-	4171523	4171706	-	-	-	-	-	-	-	-	-	-	-	-	-	-	-	-	-	-

INDEXABLE MILLING

CNMG-RU • Roughing Universal

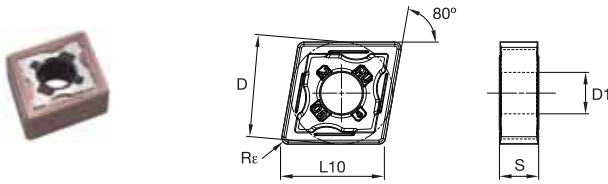

● first choice
○ alternate choice

ISO catalogue number	D	L10	S	R _ε	D1	WP05CT	WP15CT	WP25CT	WP35CT	WM15CT	WM25CT	WM35CT	WK05CT	WK15CT	WK20CT	WS10PT	WS25PT	WU10HT	WU05PT	WP20TT	TMM	TTR	WM20CT	WU10PT	WU25PT
CNMG120408RU	12,70	12,90	4,76	0,8	5,16		6690250	6690247		6817522	6817756			6678403	6690253										6795793
CNMG120412RU	12,70	12,90	4,76	1,2	5,16		6690251	6690248		6817523	6817757			6678404	6690254										6795794

SOLID END MILLING

HOLEMAKING

CNMG-UF • Fine Finishing

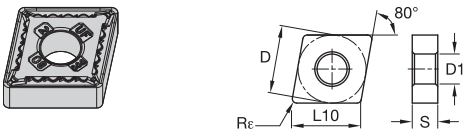

● first choice
○ alternate choice

ISO catalogue number	D	L10	S	R _ε	D1	WP05CT	WP15CT	WP25CT	WP35CT	WM15CT	WM25CT	WM35CT	WK05CT	WK15CT	WK20CT	WS10PT	WS25PT	WU10HT	WU05PT	WP20TT	TMM	TTR	WM20CT	WU10PT	WU25PT
CNMG120404UF	12,70	12,90	4,76	0,4	5,16					4169353	4169379														
CNMG120408UF	12,70	12,90	4,76	0,8	5,16					4169354	4169380					5645588									
CNMG120412UF	12,70	12,90	4,76	1,2	5,16					4169355	4169381														

TAPPING

TURNING

CNMG-UM • Medium Machining

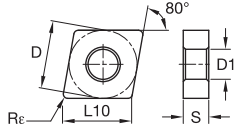
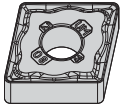

● first choice
○ alternate choice

ISO catalogue number	D	L10	S	R ϵ	D1	WP05CT	WP15CT	WP25CT	WP35CT	WM15CT	WM25CT	WM35CT	WK05CT	WK15CT	WK20CT	WS10PT	WS25PT	WU10HT	WU05PT	WP20TT	THM	TTR	WM20CT	WU10PT	WU25PT	
CNMG120404UM	12,70	12,90	4,76	0,4	5,16	●	●	●	○	○	○	○	○	○	○	○	○	○	○	○	○	○	○	○	○	○
CNMG120408UM	12,70	12,90	4,76	0,8	5,16	○	○	○	○	○	○	○	○	○	○	○	○	○	○	○	○	○	○	○	○	
CNMG120412UM	12,70	12,90	4,76	1,2	5,16	○	○	○	○	○	○	○	○	○	○	○	○	○	○	○	○	○	○	○	○	

INDEXABLE MILLING

SOLID END MILLING

HOLEMAKING

TAPPING

TURNING

INDEXABLE MILLING

SOLID END MILLING

HOLEMAKING

TAPPING

TURNING

CNMG-UR • Universal Roughing

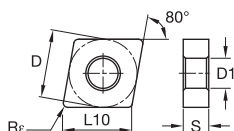
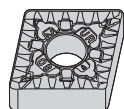

● first choice

○ alternate choice

ISO catalogue number	D	L10	S	R _ε	D1	WP05CT		WP15CT		WP25CT		WP35CT		WM15CT		WM25CT		WM35CT		WK05CT		WK15CT		WK20CT		WS10PT		WS25PT		WU10HT		WU05PT		WP20TT		TTH		TTR		WM20CT		WU10PT		WU25PT					
						○	●	○	●	○	●	○	●	○	●	○	●	○	●	○	●	○	●	○	●	○	●	○	●	○	●	○	●	○	●	○	●	○	●	○	●	○	●	○	●	○	●		
CNMG120404UR	12,70	12,90	4,76	0,4	5,16	-	-	-	-	4170500	-	-	-	-	-	-	-	-	-	-	-	-	-	-	-	-	-	-	-	-	-	-	-	-	-	-	-	-	-	-	-	-	-	-	-	-	-		
CNMG120408UR	12,70	12,90	4,76	0,8	5,16	-	-	4171093	4170501	4169960	-	-	-	-	-	-	-	-	-	-	-	-	-	-	-	-	-	-	-	-	-	-	-	-	-	-	-	-	-	-	-	-	-	-	-	-	-		
CNMG120412UR	12,70	12,90	4,76	1,2	5,16	-	-	4171094	4170502	4169961	-	-	-	-	-	-	-	-	-	-	-	-	-	-	-	-	-	-	-	-	-	-	-	-	-	-	-	-	-	-	-	-	-	-	-	-	-		
CNMG120416UR	12,70	12,90	4,76	1,6	5,16	-	-	4170503	-	-	-	-	-	4169447	4169448	4169447	4169447	4169482	4169481	-	-	-	-	-	4171420	4171419	5301413	5301413	5301416	-	-	-	-	-	-	-	-	-	-	-	-	-	-	-	-	-	-	-	-
CNMG160608UR	15,88	16,12	6,35	0,8	6,35	-	-	4171096	4170504	-	-	-	4169410	4169448	4169448	4169448	4169483	4169483	-	-	-	-	-	-	-	-	-	-	-	-	-	-	-	-	-	-	-	-	-	-	-	-	-	-	-	-	-		
CNMG160612UR	15,88	16,12	6,35	1,2	6,35	-	-	4171097	4170505	4169962	-	-	4169411	4169449	4169448	4169448	4169484	4169483	-	-	-	-	-	-	4171422	4171422	5578988	5578988	-	-	-	-	-	-	-	-	-	-	-	-	-	-	-	-	-	-	-	-	
CNMG160616UR	15,88	16,12	6,35	1,6	6,35	-	-	4171098	4170506	-	-	-	-	4169450	4169450	4169485	4169485	-	-	-	-	-	-	4171423	4171423	5578900	5578900	5578901	-	-	-	-	-	-	-	-	-	-	-	-	-	-	-	-	-	-	-		
CNMG190612UR	19,05	19,34	6,35	1,2	7,93	-	-	4171099	4170507	4169964	-	-	4169412	4169451	4169451	4169486	4169486	5680088	-	-	-	-	-	4171424	4171424	-	-	5512536	5512536	-	-	-	-	-	-	-	-	-	-	-	-	-	-	-	-	-	-		
CNMG190616UR	19,05	19,34	6,35	1,6	7,93	-	-	4170508	4169423	4169452	4169487	-	-	-	-	-	-	-	-	-	-	-	-	-	-	-	5579234	-	-	-	-	-	-	-	-	-	-	-	-	-	-	-	-	-	-	-	-		

CNMM-8 • Heavy Roughing

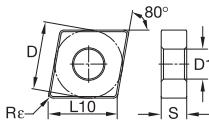
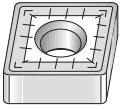

● first choice
○ alternate choice

	P	M	K	N	S	H	WP05CT	WP15CT	WP25CT	WP35CT	WM15CT	WM25CT	WM35CT	WK05CT	WK15CT	WK20CT	WS10PT	WS25PT	WU10HT	WU05PT	WP20TT	THM	TTR	WM20CT	WU10PT	WU25PT	
P	●	●	●	○	○	○	○	○	○	○	○	○	○	○	○	○	○	○	○	○	○	○	○	○	○	○	○
M	●	●	○	○	○	○	○	○	○	○	○	○	○	○	○	○	○	○	○	○	○	○	○	○	○	○	○
K	○	○	○	○	○	○	○	○	○	○	○	○	○	○	○	○	○	○	○	○	○	○	○	○	○	○	○
N	○	○	○	○	○	○	○	○	○	○	○	○	○	○	○	○	○	○	○	○	○	○	○	○	○	○	○
S	○	○	○	○	○	○	○	○	○	○	○	○	○	○	○	○	○	○	○	○	○	○	○	○	○	○	○
H	○	○	○	○	○	○	○	○	○	○	○	○	○	○	○	○	○	○	○	○	○	○	○	○	○	○	○
ISO catalogue number	D	L10	S	Rε	D1																						
CNMM1906168	19,05	19,34	6,35	1,6	7,93			5418451																			

CNMM-65 • Heavy Roughing

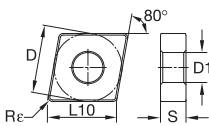
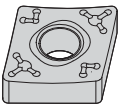

● first choice
○ alternate choice

	P	M	K	N	S	H	WP05CT	WP15CT	WP25CT	WP35CT	WM15CT	WM25CT	WM35CT	WK05CT	WK15CT	WK20CT	WS10PT	WS25PT	WU10HT	WU05PT	WP20TT	THM	TTR	WM20CT	WU10PT	WU25PT		
P	●	●	○	○	○	○	○	○	○	○	○	○	○	○	○	○	○	○	○	○	○	○	○	○	○	○	○	
M	●	●	○	○	○	○	○	○	○	○	○	○	○	○	○	○	○	○	○	○	○	○	○	○	○	○	○	
K	○	○	○	○	○	○	○	○	○	○	○	○	○	○	○	○	○	○	○	○	○	○	○	○	○	○	○	
N	○	○	○	○	○	○	○	○	○	○	○	○	○	○	○	○	○	○	○	○	○	○	○	○	○	○	○	
S	○	○	○	○	○	○	○	○	○	○	○	○	○	○	○	○	○	○	○	○	○	○	○	○	○	○	○	
H	○	○	○	○	○	○	○	○	○	○	○	○	○	○	○	○	○	○	○	○	○	○	○	○	○	○	○	
ISO catalogue number	D	L10	S	Rε	D1																							
CNMM12040865	12,70	12,90	4,76	0,8	5,16			5698348	5698349	5698360																		
CNMM12041265	12,70	12,90	4,76	1,2	5,16			5698362	5698363																			
CNMM16060865	15,88	16,12	6,35	0,8	6,35				5698366	5698367																		
CNMM16061265	15,88	16,12	6,35	1,2	6,35				5698370	5698371																		
CNMM16061665	15,88	16,12	6,35	1,6	6,35				5698372	5698373																		
CNMM19061265	19,05	19,34	6,35	1,2	7,93				5491016	5698376																		
CNMM19061665	19,05	19,34	6,35	1,6	7,93				5698378																			
CNMM19062465	19,05	19,34	6,35	2,4	7,93				5698410	5698411																		

CPMT-FP • Finishing Positive

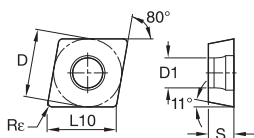

● first choice

○ alternate choice

ISO catalogue number	D	L10	S	Re	D1	WP05CT	WP15CT	WP25CT	WP35CT	WM15CT	WM25CT	WM35CT	WK05CT	WK15CT	WK20CT	WS10PT	WS25PT	WU10HT	WU05PT	WP20TT	TTHM	TTR	WM20CT	WU10PT	WU25PT
CPMT060204FP	6,35	6,45	2,38	0,4	2,80	○	○	○	○	○	○	○	○	○	○	○	○	○	○	○	○	○	○	○	○
CPMT09T308FP	9,53	9,67	3,97	0,8	4,40	○	○	○	○	○	○	○	○	○	○	○	○	○	○	○	○	○	○	○	○

INDEXABLE MILLING

SOLID END MILLING

HOLEMAKING

TAPPING

TURNING

DCMT • Medium Machining

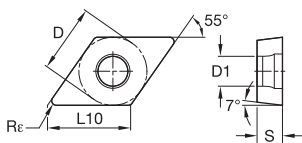
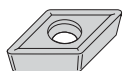

● first choice

○ alternate choice

ISO catalogue number	D	L10	S	Rε	D1	P	M	K	N	S	H	WP05CT	WP15CT	WP25CT	WP35CT	WM15CT	WM25CT	WM35CT	WK05CT	WK15CT	WK20CT	WS10PT	WS25PT	WU10HT	WU05PT	WP20TT	THM	TTR	WM20CT	WU10PT	WU25PT				
						●	●	○	○	○	○	●	○	○	○	○	○	○	○	○	○	○	○	○	○	○	○	○	○	○	○	○	○	○	○
DCMT070204	6,35	7,75	2,38	0,4	2,80	●	●	○	○	○	○	○	○	○	○	○	○	○	○	○	○	○	○	○	○	○	○	○	○	○	○	○	○	○	
DCMT11T304	9,53	11,63	3,97	0,4	4,40	●	●	○	○	○	○	○	○	○	○	○	○	○	○	○	○	○	○	○	○	○	○	○	○	○	○	○	○	○	○
DCMT11T308	9,53	11,63	3,97	0,8	4,45	●	●	○	○	○	○	○	○	○	○	○	○	○	○	○	○	○	○	○	○	○	○	○	○	○	○	○	○	○	○
DCMT11T312	9,53	11,63	3,97	1,2	4,45	●	●	○	○	○	○	○	○	○	○	○	○	○	○	○	○	○	○	○	○	○	○	○	○	○	○	○	○	○	○
DCMT150408	12,70	15,50	4,76	0,8	5,55	●	●	○	○	○	○	○	○	○	○	○	○	○	○	○	○	○	○	○	○	○	○	○	○	○	○	○	○	○	○
DCMT150412	12,70	15,50	4,76	1,2	5,55	●	●	○	○	○	○	○	○	○	○	○	○	○	○	○	○	○	○	○	○	○	○	○	○	○	○	○	○	○	○

DCMT-FP • Finishing Positive

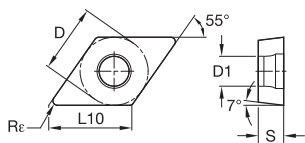
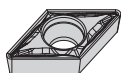

● first choice
○ alternate choice

P	M	K	N	S	H	WP05CT	WP15CT	WP25CT	WP35CT	WM15CT	WM25CT	WM35CT	WK05CT	WK15CT	WK20CT	WS10PT	WS25PT	WU10HT	WU05PT	WP20TT	TTHM	TTR	WM20CT	WU10PT	WU25PT	
●	●	●	●	●	●	○	○	○	○	○	○	○	○	○	○	○	○	○	○	○	○	○	○	○	○	○
●	○	○	○	○	○	○	○	○	○	○	○	○	○	○	○	○	○	○	○	○	○	○	○	○	○	○
○	○	○	○	○	○	○	○	○	○	○	○	○	○	○	○	○	○	○	○	○	○	○	○	○	○	○
○	○	○	○	○	○	○	○	○	○	○	○	○	○	○	○	○	○	○	○	○	○	○	○	○	○	○
○	○	○	○	○	○	○	○	○	○	○	○	○	○	○	○	○	○	○	○	○	○	○	○	○	○	○

ISO catalogue number	D	L10	S	Rε	D1	WP05CT	WP15CT	WP25CT	WP35CT	WM15CT	WM25CT	WM35CT	WK05CT	WK15CT	WK20CT	WS10PT	WS25PT	WU10HT	WU05PT	WP20TT	TTHM	TTR	WM20CT	WU10PT	WU25PT	
DCMT070202FP	6,35	7,75	2,38	0,2	2,80	○	○	○	○	○	○	○	○	○	○	○	○	○	○	○	○	○	○	○	○	○
DCMT070204FP	6,35	7,75	2,38	0,4	2,80	○	○	○	○	○	○	○	○	○	○	○	○	○	○	○	○	○	○	○	○	○
DCMT070208FP	6,35	7,75	2,38	0,8	2,80	○	○	○	○	○	○	○	○	○	○	○	○	○	○	○	○	○	○	○	○	○
DCMT11T302FP	9,53	11,63	3,97	0,2	4,40	○	○	○	○	○	○	○	○	○	○	○	○	○	○	○	○	○	○	○	○	○
DCMT11T304FP	9,53	11,63	3,97	0,4	4,40	○	○	○	○	○	○	○	○	○	○	○	○	○	○	○	○	○	○	○	○	○
DCMT11T308FP	9,53	11,63	3,97	0,8	4,40	○	○	○	○	○	○	○	○	○	○	○	○	○	○	○	○	○	○	○	○	○
DCMT150404FP	12,70	15,50	4,76	0,4	5,50	○	○	○	○	○	○	○	○	○	○	○	○	○	○	○	○	○	○	○	○	○
DCMT150408FP	12,70	15,50	4,76	0,8	5,50	○	○	○	○	○	○	○	○	○	○	○	○	○	○	○	○	○	○	○	○	○

INDEXABLE MILLING

SOLID END MILLING

HOLEMAKING

TAPPING

TURNING

DCMT-MP • Medium Positive

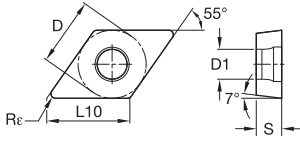
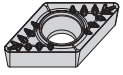

● first choice
○ alternate choice

ISO catalogue number	D	L10	S	Rε	D1	Material/Condition Matrix																	
						WP05CT	WP15CT	WP25CT	WP35CT	WM15CT	WM25CT	WM35CT	WK05CT	WK15CT	WK20CT	WS10PT	WS25PT	WU10HT	WU05PT	WP20TT	THT	TTR	WM20CT
DCMT11T304MP	9,53	11,63	3,97	0,4	4,40	●	○	○	○	○	○	○	○	○	○	○	○	○	○	○	○	○	○
DCMT11T308MP	9,53	11,63	3,97	0,8	4,40	○	○	○	○	○	○	○	○	○	○	○	○	○	○	○	○	○	○
DCMT11T312MP	9,53	11,63	3,97	1,2	4,40	○	○	○	○	○	○	○	○	○	○	○	○	○	○	○	○	○	○

INDEXABLE MILLING

SOLID END MILLING

HOLEMAKING

TAPPING

TURNING

DNGG-FS • Finishing Sharp

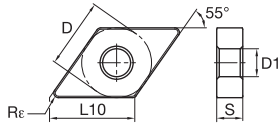

● first choice
○ alternate choice

ISO catalogue number	D	L10	S	Rε	D1	WP05CT	WP15CT	WP25CT	WP35CT	WM15CT	WM25CT	WM35CT	WK05CT	WK15CT	WK20CT	WS10PT	WS25PT	WU10HT	WU05PT	WP20TT	THM	TTR	WM20CT	WU10PT	WU25PT
DNGG110402FS	9,53	11,63	4,76	0,2	3,81	●	●	●	○	○	○	○	○	○	○	○	○	○	○	○	○	○	○	○	○
DNGG110404FS	9,53	11,63	4,76	0,4	3,81	○	○	○	○	○	○	○	○	○	○	○	○	○	○	○	○	○	○	○	○
DNGG110408FS	9,53	11,63	4,76	0,8	3,81											○	○								
DNGG150401FS	12,70	15,50	4,76	0,1	5,16											○	○								
DNGG150402FS	12,70	15,50	4,76	0,2	5,16											○	○								
DNGG150404FS	12,70	15,50	4,76	0,4	5,16											○	○								
DNGG150408FS	12,70	15,50	4,76	0,8	5,16																				
DNGG150412FS	12,70	15,50	4,76	1,2	5,16											○	○								
DNGG150604FS	12,70	15,50	6,35	0,4	5,16											○	○								
DNGG150608FS	12,70	15,50	6,35	0,8	5,16											○	○								

INDEXABLE MILLING

SOLID END MILLING

HOLEMAKING

TAPPING

TURNING

INDEXABLE MILLING

DNGP • Medium Machining

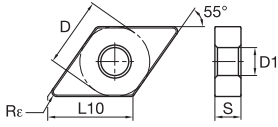
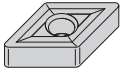

● first choice
○ alternate choice

ISO catalogue number	D	L10	S	Rε	D1	WP05CT	WP15CT	WP25CT	WP35CT	WM15CT	WM25CT	WM35CT	WK05CT	WK15CT	WK20CT	WS10PT	WS25PT	WU10HT	WU05PT	WP20TT	THM	TTR	WM20CT	WU10PT	WU25PT
DNGP150404	12,70	15,50	4,76	0,4	5,16	•	•	•	•	•	•	•	•	•	•	•	•	•	•	•	•	•	•	•	•

NOTE: Single sided

SOLID END MILLING

HOLEMAKING

DNMA • Roughing

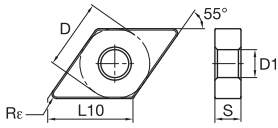
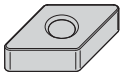

● first choice
○ alternate choice

ISO catalogue number	D	L10	S	Rε	D1	WP05CT	WP15CT	WP25CT	WP35CT	WM15CT	WM25CT	WM35CT	WK05CT	WK15CT	WK20CT	WS10PT	WS25PT	WU10HT	WU05PT	WP20TT	THM	TTR	WM20CT	WU10PT	WU25PT
DNMA110408	9,53	11,63	4,76	0,8	3,81	•	•	•	•	•	•	•	•	•	•	•	•	•	•	•	•	•	•	•	•
DNMA150408	12,70	15,50	4,76	0,8	5,16	•	•	•	•	•	•	•	•	•	•	•	•	•	•	•	•	•	•	•	•
DNMA150412	12,70	15,50	4,76	1,2	5,16	•	•	•	•	•	•	•	•	•	•	•	•	•	•	•	•	•	•	•	•
DNMA150608	12,70	15,50	6,35	0,8	5,16	•	•	•	•	•	•	•	•	•	•	•	•	•	•	•	•	•	•	•	•
DNMA150612	12,70	15,50	6,35	1,2	5,16	•	•	•	•	•	•	•	•	•	•	•	•	•	•	•	•	•	•	•	•
DNMA150616	12,70	15,50	6,35	1,6	5,16	•	•	•	•	•	•	•	•	•	•	•	•	•	•	•	•	•	•	•	•

TAPPING

TURNING

DNMG • Roughing

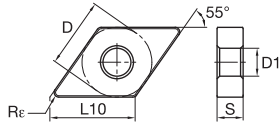
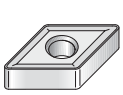

● first choice
○ alternate choice

ISO catalogue number	D	L10	S	Rε	D1	WP05CT	WP15CT	WP25CT	WP35CT	WM15CT	WM25CT	WM35CT	WK05CT	WK15CT	WK20CT	WS10PT	WS25PT	WU10HT	WU05PT	WP20TT	THM 2560240	TTR	WM20CT	WU10PT	WU25PT	Material Group												
																										P	M	K	N	S	H							
DNMG150608	12,70	15,50	6,35	0,8	5,16	●	●	●	●	○	○	○	○	○	○	○	○	○	○	○	○	○	○	○	○	○	○	○	○	○	○	○	○	○	○	○	○	
DNMG150608	12,70	15,50	6,35	0,8	5,16	○	○	○	○	○	○	○	○	○	○	○	○	○	○	○	○	○	○	○	○	○	○	○	○	○	○	○	○	○	○	○	○	○

DNMG-CT

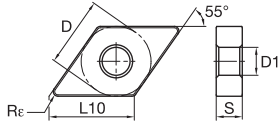
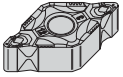

● first choice
○ alternate choice

ISO catalogue number	D	L10	S	Rε	D1	WP05CT	WP15CT	WP25CT	WP35CT	WM15CT	WM25CT	WM35CT	WK05CT	WK15CT	WK20CT	WS10PT	WS25PT	WU10HT	WU05PT	WP20TT	THM	TTR	WM20CT	WU10PT	WU25PT	Material Group												
																										P	M	K	N	S	H							
DNMG150608CT	12,70	15,50	6,35	0,8	5,16	○	○	○	○	○	○	○	○	○	○	○	○	○	○	○	○	○	○	○	○	○	○	○	○	○	○	○	○	○	○	○	○	○
											4172700																											

DNMG-FF • Fine Finishing

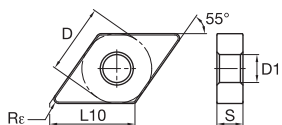
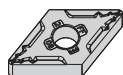

● first choice

○ alternate choice

	P	M	K	N	S	H	WP05CT	WP15CT	WP25CT	WP35CT	WM15CT	WM25CT	WM35CT	WK05CT	WK15CT	WK20CT	WS10PT	WS25PT	WU10HT	WU05PT	WP20TT	THM	TTR	WM20CT	WU10PT	WU25PT	
ISO catalogue number	D	L10	S	Rε	D1																						
DNMG110404FF	9,53	11,63	4,76	0,4	3,81		●	●	●	○	○	○	○	○	○	○	○	○	○	○	○	○	○	○	○	○	○
DNMG110408FF	9,53	11,63	4,76	0,8	3,81		○	○	○	○	○	○	○	○	○	○	○	○	○	○	○	○	○	○	○	○	○
DNMG150404FF	12,70	15,50	4,76	0,4	5,16		●	●	●	○	○	○	○	○	○	○	○	○	○	○	○	○	○	○	○	○	○
DNMG150408FF	12,70	15,50	4,76	0,8	5,16		○	○	○	○	○	○	○	○	○	○	○	○	○	○	○	○	○	○	○	○	○
DNMG150604FF	12,70	15,50	6,35	0,4	5,16		●	●	●	○	○	○	○	○	○	○	○	○	○	○	○	○	○	○	○	○	○
DNMG150608FF	12,70	15,50	6,35	0,8	5,16		○	○	○	○	○	○	○	○	○	○	○	○	○	○	○	○	○	○	○	○	○
DNMG150612FF	12,70	15,50	6,35	1,2	5,16		○	○	○	○	○	○	○	○	○	○	○	○	○	○	○	○	○	○	○	○	○

INDEXABLE MILLING

DNMG-MR • Medium Roughing

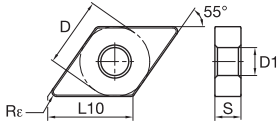
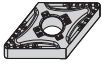

● first choice
○ alternate choice

	P	M	K	N	S	H	WP05CT	WP15CT	WP25CT	WP35CT	WM15CT	WM25CT	WM35CT	WK05CT	WK15CT	WK20CT	WS10PT	WS25PT	WU10HT	WU05PT	WP20TT	TTHM	TTR	WM20CT	WU10PT	WU25PT	
ISO catalogue number	D	L10	S	Rε	D1																						
DNMG110408MR	9,53	11,63	4,76	0,8	3,81		●	●	○	○	○	○	○	○	○	○	○	○	○	○	○	○	○	○	○	○	○
DNMG150404MR	12,70	15,50	4,76	0,4	5,16		○	○	○	○	○	○	○	○	○	○	○	○	○	○	○	○	○	○	○	○	○
DNMG150408MR	12,70	15,50	4,76	0,8	5,16		○	○	○	○	○	○	○	○	○	○	○	○	○	○	○	○	○	○	○	○	○
DNMG150412MR	12,70	15,50	4,76	1,2	5,16		○	○	○	○	○	○	○	○	○	○	○	○	○	○	○	○	○	○	○	○	○
DNMG150604MR	12,70	15,50	6,35	0,4	5,16		○	○	○	○	○	○	○	○	○	○	○	○	○	○	○	○	○	○	○	○	○
DNMG150608MR	12,70	15,50	6,35	0,8	5,16		○	○	○	○	○	○	○	○	○	○	○	○	○	○	○	○	○	○	○	○	○
DNMG150612MR	12,70	15,50	6,35	1,2	5,16		○	○	○	○	○	○	○	○	○	○	○	○	○	○	○	○	○	○	○	○	○

SOLID END MILLING

HOLEMAKING

TAPPING

TURNING

DNMG-MS • Medium Sharp

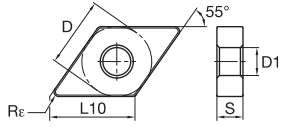
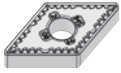

● first choice
○ alternate choice

P	M	K	N	S	H
●	●	●	○	○	○
○	○	○	○	○	○
○	○	○	○	○	○
○	○	○	○	○	○
○	○	○	○	○	○
○	○	○	○	○	○
○	○	○	○	○	○
○	○	○	○	○	○
○	○	○	○	○	○
○	○	○	○	○	○

ISO catalogue number	D	L10	S	Rε	D1	WP05CT	WP15CT	WP25CT	WP35CT	WM15CT	WM25CT	WM35CT	WK05CT	WK15CT	WK20CT	WS10PT	WS25PT	WU10HT	WU05PT	WP20TT	THM	TTR	WM20CT	WU10PT	WU25PT
DNMG110408MS	9,53	11,63	4,76	0,8	3,81	●	●	○	○	○	○	○	○	○	○	○	○	○	○	○	○	○	○	○	○
DNMG150404MS	12,70	15,50	4,76	0,4	5,16	○	○	○	○	○	○	○	○	○	○	○	○	○	○	○	○	○	○	○	○
DNMG150408MS	12,70	15,50	4,76	0,8	5,16	○	○	○	○	○	○	○	○	○	○	○	○	○	○	○	○	○	○	○	○
DNMG150412MS	12,70	15,50	4,76	1,2	5,16	○	○	○	○	○	○	○	○	○	○	○	○	○	○	○	○	○	○	○	○
DNMG150604MS	12,70	15,50	6,35	0,4	5,16	○	○	○	○	○	○	○	○	○	○	○	○	○	○	○	○	○	○	○	○
DNMG150608MS	12,70	15,50	6,35	0,8	5,16	○	○	○	○	○	○	○	○	○	○	○	○	○	○	○	○	○	○	○	○
DNMG150612MS	12,70	15,50	6,35	1,2	5,16	○	○	○	○	○	○	○	○	○	○	○	○	○	○	○	○	○	○	○	○

INDEXABLE MILLING

SOLID END MILLING

HOLEMAKING

TAPPING

TURNING

DNMG-MW • Medium Wiper

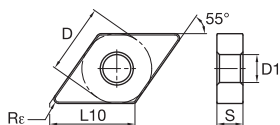
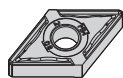

● first choice
○ alternate choice

	P	M	K	N	S	H														
	●	●	○	○	○	○	○	○	○	○	○	○	○	○	○	○	○	○	○	○
	○	○	○	○	○	○	○	○	○	○	○	○	○	○	○	○	○	○	○	○
	○	○	○	○	○	○	○	○	○	○	○	○	○	○	○	○	○	○	○	○
	○	○	○	○	○	○	○	○	○	○	○	○	○	○	○	○	○	○	○	○
	○	○	○	○	○	○	○	○	○	○	○	○	○	○	○	○	○	○	○	○
	○	○	○	○	○	○	○	○	○	○	○	○	○	○	○	○	○	○	○	○
	○	○	○	○	○	○	○	○	○	○	○	○	○	○	○	○	○	○	○	○
	○	○	○	○	○	○	○	○	○	○	○	○	○	○	○	○	○	○	○	○

ISO catalogue number	D	L10	S	Rε	D1	WP05CT	WP15CT	WP25CT	WP35CT	WM15CT	WM25CT	WM35CT	WK05CT	WK15CT	WK20CT	WS10PT	WS25PT	WU10HT	WU05PT	WP20TT	T4M	TTR	WM20CT	WU10PT	WU25PT
DNMG150408MW	12,70	15,50	4,76	0,8	5,16	●	●	○	○	○	○	○	○	○	○	○	○	○	○	○	○	○	○	○	○
DNMG150608MW	12,70	15,50	6,35	0,8	5,16	○	○	○	○	○	○	○	○	○	○	○	○	○	○	○	○	○	○	○	○

DNMG-RH • Roughing

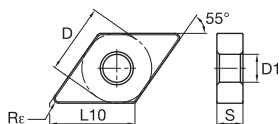

● first choice
○ alternate choice

	P	M	K	N	S	H															
	●	●	○	○	○	○	○	○	○	○	○	○	○	○	○	○	○	○	○	○	○
	○	○	○	○	○	○	○	○	○	○	○	○	○	○	○	○	○	○	○	○	○
	○	○	○	○	○	○	○	○	○	○	○	○	○	○	○	○	○	○	○	○	○
	○	○	○	○	○	○	○	○	○	○	○	○	○	○	○	○	○	○	○	○	○
	○	○	○	○	○	○	○	○	○	○	○	○	○	○	○	○	○	○	○	○	○
	○	○	○	○	○	○	○	○	○	○	○	○	○	○	○	○	○	○	○	○	○
	○	○	○	○	○	○	○	○	○	○	○	○	○	○	○	○	○	○	○	○	○
	○	○	○	○	○	○	○	○	○	○	○	○	○	○	○	○	○	○	○	○	○
	○	○	○	○	○	○	○	○	○	○	○	○	○	○	○	○	○	○	○	○	○

ISO catalogue number	D	L10	S	Rε	D1	WP05CT	WP15CT	WP25CT	WP35CT	WM15CT	WM25CT	WM35CT	WK05CT	WK15CT	WK20CT	WS10PT	WS25PT	WU10HT	WU05PT	WP20TT	T4M	TTR	WM20CT	WU10PT	WU25PT
DNMG150408RH	12,70	15,50	4,76	0,8	5,16	○	○	○	○	○	○	○	○	○	○	○	○	○	○	○	○	○	○	○	○
DNMG150608RH	12,70	15,50	6,35	0,8	5,16	○	○	○	○	○	○	○	○	○	○	○	○	○	○	○	○	○	○	○	○
DNMG150612RH	12,70	15,50	6,35	1,2	5,16	○	○	○	○	○	○	○	○	○	○	○	○	○	○	○	○	○	○	○	○
DNMG150616RH	12,70	15,50	6,35	1,6	5,16	○	○	○	○	○	○	○	○	○	○	○	○	○	○	○	○	○	○	○	○
DNMG190612RH	15,88	19,38	6,35	1,2	6,35	○	○	○	○	○	○	○	○	○	○	○	○	○	○	○	○	○	○	○	○

DNMG-UF • Fine Finishing

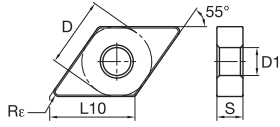
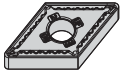

● first choice
○ alternate choice

ISO catalogue number	D	L10	S	R _ε	D1	WP05CT	WP15CT	WP25CT	WP35CT	WM15CT	WM25CT	WM35CT	WK05CT	WK15CT	WK20CT	WS10PT	WS25PT	WU10HT	WU05PT	WP20TT	THM	TTR	WM20CT	WU10PT	WU25PT
DNMG110404UF	9,53	11,63	4,76	0,4	3,81	●	●	●	○	○	○	○	○	○	○	○	○	○	○	○	○	○	○	○	○
DNMG110408UF	9,53	11,63	4,76	0,8	3,81	○	○	○	○	○	○	○	○	○	○	○	○	○	○	○	○	○	○	○	○
DNMG150404UF	12,70	15,50	4,76	0,4	5,16	●	●	●	○	○	○	○	○	○	○	○	○	○	○	○	○	○	○	○	○
DNMG150408UF	12,70	15,50	4,76	0,8	5,16	○	○	○	○	○	○	○	○	○	○	○	○	○	○	○	○	○	○	○	○
DNMG150604UF	12,70	15,50	6,35	0,4	5,16	●	●	●	○	○	○	○	○	○	○	○	○	○	○	○	○	○	○	○	○
DNMG150608UF	12,70	15,50	6,35	0,8	5,16	○	○	○	○	○	○	○	○	○	○	○	○	○	○	○	○	○	○	○	○
DNMG150612UF	12,70	15,50	6,35	1,2	5,16	○	○	○	○	○	○	○	○	○	○	○	○	○	○	○	○	○	○	○	○

INDEXABLE MILLING

SOLID END MILLING

HOLEMAKING

TAPPING

TURNING

DNMG-UM • Medium Machining

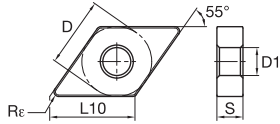
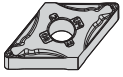

● first choice
○ alternate choice

ISO catalogue number	D	L10	S	R ϵ	D1	Material Groups																			
						P	M	K	N	S	H	Al	St	Cast	In	Co	Ti	Al	St	Cast	In	Co	Ti		
						WP05CT	WP15CT	WP25CT	WP35CT	WM15CT	WM25CT	WM35CT	WK05CT	WK15CT	WK20CT	WS10PT	WS25PT	WU10HT	WU05PT	WP20TT	THM	TTR	WM20CT	WU10PT	WU25PT
DNMG110404UM	9,53	11,63	4,76	0,4	3,81	●	●	●	●	○	○	○	○	○	○	○	○	○	○	○	○	○	○	○	
DNMG110408UM	9,53	11,63	4,76	0,8	3,81	●	●	●	●	○	○	○	○	○	○	○	○	○	○	○	○	○	○	○	
DNMG150404UM	12,70	15,50	4,76	0,4	5,16	●	●	●	●	○	○	○	○	○	○	○	○	○	○	○	○	○	○	○	
DNMG150408UM	12,70	15,50	4,76	0,8	5,16	●	●	●	●	○	○	○	○	○	○	○	○	○	○	○	○	○	○	○	
DNMG150604UM	12,70	15,50	6,35	0,4	5,16	●	●	●	●	○	○	○	○	○	○	○	○	○	○	○	○	○	○	○	
DNMG150608UM	12,70	15,50	6,35	0,8	5,16	●	●	●	●	○	○	○	○	○	○	○	○	○	○	○	○	○	○	○	
DNMG150612UM	12,70	15,50	6,35	1,2	5,16	●	●	●	●	○	○	○	○	○	○	○	○	○	○	○	○	○	○	○	
DNMG150616UM	12,70	15,50	6,35	1,6	5,16	●	●	●	●	○	○	○	○	○	○	○	○	○	○	○	○	○	○	○	

DNMG-UR • Universal Roughing

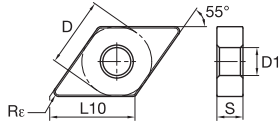

● first choice
○ alternate choice

ISO catalogue number	D	L10	S	Rε	D1	Material Groups																			
						P	M	K	N	S	H														
						WP05CT	WP15CT	WP25CT	WP35CT	WM15CT	WM25CT	WM35CT	WK05CT	WK15CT	WK20CT	WS10PT	WS25PT	WU10HT	WU05PT	WP20TT	THM	TTR	WM20CT	WU10PT	WU25PT
DNMG110408UR	9,53	11,63	4,76	0,8	3,81	-	4171101	4170509	-	4169424	4169453	4169488	-	-	-	-	-	-	-	-	-	-	6942345	6867868	
DNMG110412UR	9,53	11,63	4,76	1,2	3,81	-	4171102	4170510	-	-	-	-	-	-	-	-	-	-	-	-	-	-	-	-	
DNMG150408UR	12,70	15,50	4,76	0,8	5,16	-	4171103	4170511	-	-	4169454	-	-	4171428	-	5579271	-	-	-	-	-	-	-	-	
DNMG150412UR	12,70	15,50	4,76	1,2	5,16	-	4170512	-	-	-	-	-	-	-	-	5579292	-	-	-	-	-	-	-	-	
DNMG150608UR	12,70	15,50	6,35	0,8	5,16	-	4171105	4170513	4169969	-	4169427	4169456	4169492	-	4171431	-	5579276	-	-	-	-	-	6942346	6867869	
DNMG150612UR	12,70	15,50	6,35	1,2	5,16	-	4171106	4170514	-	-	4169457	4169493	5680172	-	4171432	4171431	-	-	-	-	-	-	6942347	6867870	
DNMG150616UR	12,70	15,50	6,35	1,6	5,16	-	4170515	-	-	-	-	4169494	-	-	-	-	-	-	-	-	-	-	-	-	

INDEXABLE MILLING

SOLID END MILLING

HOLEMAKING

TAPPING

TURNING

RCMT • Medium Machining

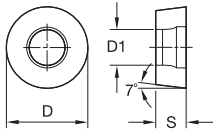
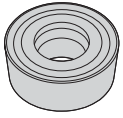

● first choice
○ alternate choice

ISO catalogue number	D	S	D1	Material Group																			
				P	M	K	N	S	H														
				WP05CT	WP15CT	WP25CT	WP35CT	WM15CT	WM25CT	WM35CT	WK05CT	WK15CT	WK20CT	WS10PT	WS25PT	WU10HT	WU05PT	WP20TT	THM	TTR	WM20CT	WU10PT	WU25PT
RCMT0602M0	6,00	2,38	2,80	-	4169975	4170536	-	-	-	-	-	-	4170478	-	-	-	-	-	2028115	-	-	-	-
RCMT0803M0	8,00	3,18	3,40	-	4169976	4170537	-	-	-	-	-	-	4170479	-	-	-	-	-	2028129	-	-	-	-
RCMT10T3M0	10,00	3,97	4,40	-	4169977	4170538	4170752	-	-	-	-	-	4170480	-	-	-	-	-	2028143	2028145	-	-	-
RCMT1204M0	12,00	4,76	4,40	-	4169978	4170539	4170803	-	-	-	-	-	4170481	-	-	-	-	-	2028157	-	-	-	-
RCMT1606M0	16,00	6,35	5,50	-	4169979	-	4170804	-	-	-	-	-	4170482	-	-	-	-	-	-	-	-	-	-

INDEXABLE MILLING

SOLID END MILLING

HOLEMAKING

TAPPING

TURNING

RCMX • Roughing

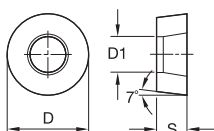
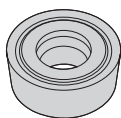

● first choice

○ alternate choice

ISO catalogue number	D	S	D1	Material Compatibility																			
				WP05CT	WP15CT	WP25CT	WP35CT	WM15CT	WM25CT	WM35CT	WK05CT	WK15CT	WK20CT	WS10PT	WS25PT	WU10HT	WU05PT	WP20TT	THM	TTR	WM20CT	WU10PT	WU25PT
RCMX2006M0	20,00	6,35	6,50	●	●	●	●	●	●	●	●	●	●	●	●	●	●	●	●	●	●	●	●
RCMX2006M0T	20,00	6,35	6,50	○	○	○	○	○	○	○	○	○	○	○	○	○	○	○	○	○	○	○	○
RCMX2507M0T	25,00	7,94	7,40	○	○	○	○	○	○	○	○	○	○	○	○	○	○	○	○	○	○	○	○
RCMX3209M0	32,00	9,53	11,85	○	○	○	○	○	○	○	○	○	○	○	○	○	○	○	○	○	○	○	○
RCMX3209M0T	32,00	9,53	9,50	○	○	○	○	○	○	○	○	○	○	○	○	○	○	○	○	○	○	○	○

RNMA • Roughing

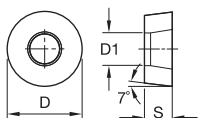
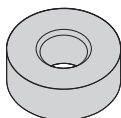

● first choice

○ alternate choice

ISO catalogue number	D	S	D1	Material Compatibility																			
				WP05CT	WP15CT	WP25CT	WP35CT	WM15CT	WM25CT	WM35CT	WK05CT	WK15CT	WK20CT	WS10PT	WS25PT	WU10HT	WU05PT	WP20TT	THM	TTR	WM20CT	WU10PT	WU25PT
RNMA120400	12,70	4,76	5,16	○	○	○	○	○	○	○	○	○	○	○	○	○	○	○	○	○	○	○	○

RNMG-RH • Roughing

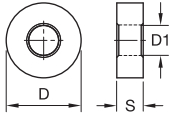
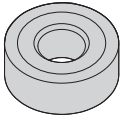

● first choice
○ alternate choice

ISO catalogue number	D	S	D1	WP05CT	WP15CT	WP25CT	WP35CT	WM15CT	WM25CT	WM35CT	WK05CT	WK15CT	WK20CT	WS10PT	WS25PT	WU10HT	WU05PT	WP20TT	THM	TTR	WM20CT	WU10PT	WU25PT
RNMG090300RH	9,53	3,18	3,81	•	•	•	•	•	•	•	•	•	•	•	•	•	•	•	•	•	•	•	•
RNMG120400RH	12,70	4,76	5,16	○	○	○	○	○	○	○	○	○	○	○	○	○	○	○	○	○	○	○	○
RNMG190600RH	19,05	6,35	7,93	○	○	○	○	○	○	○	○	○	○	○	○	○	○	○	○	○	○	○	○

INDEXABLE MILLING

SOLID END MILLING

HOLEMAKING

TAPPING

TURNING

INDEXABLE MILLING

SOLID END MILLING

HOLEMAKING

TAPPING

TURNING

SCMT • Medium Machining

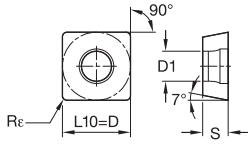

● first choice
○ alternate choice

ISO catalogue number	D	L10	S	Rε	D1	Material Compatibility																	
						WP05CT	WP15CT	WP25CT	WP35CT	WM15CT	WM25CT	WM35CT	WK05CT	WK15CT	WK20CT	WS10PT	WS25PT	WU10HT	WU05PT	WP20TT	THM	TTR	WM20CT
SCMT090304	9,53	9,53	3,18	0,4	4,45	○	○	○	○	○	○	○	○	○	○	○	○	○	○	○	○	○	○
SCMT090308	9,53	9,53	3,18	0,8	4,40	○	○	○	○	○	○	○	○	○	○	○	○	○	○	○	○	○	○
SCMT09T304	9,53	9,53	3,97	0,4	4,45	○	○	○	○	○	○	○	○	○	○	○	○	○	○	○	○	○	○
SCMT09T308	9,53	9,53	3,97	0,8	4,40	○	○	○	○	○	○	○	○	○	○	○	○	○	○	○	○	○	○
SCMT120408	12,70	12,70	4,76	0,8	5,50	○	○	○	○	○	○	○	○	○	○	○	○	○	○	○	○	○	○
SCMT150512	15,88	15,88	5,56	1,2	5,50	○	○	○	○	○	○	○	○	○	○	○	○	○	○	○	○	○	○

SCMW • Medium Machining

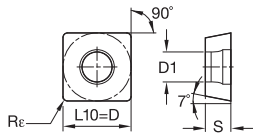
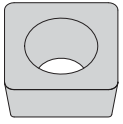

● first choice
○ alternate choice

P	M	K	N	S	H	WP05CT	WP15CT	WP25CT	WP35CT	WM15CT	WM25CT	WM35CT	WK05CT	WK15CT	WK20CT	WS10PT	WS25PT	WU10HT	WU05PT	WP20TT	THM	TTR	WM20CT	WU10PT	WU25PT
●	●	●	●	○	○	○	○	○	○	○	○	○	○	○	○	○	○	○	○	○	○	○	○	○	○
●	●	○	○	○	○	○	○	○	○	○	○	○	○	○	○	○	○	○	○	○	○	○	○	○	○
●	○	○	○	○	○	○	○	○	○	○	○	○	○	○	○	○	○	○	○	○	○	○	○	○	○
○	○	○	○	○	○	○	○	○	○	○	○	○	○	○	○	○	○	○	○	○	○	○	○	○	○
○	○	○	○	○	○	○	○	○	○	○	○	○	○	○	○	○	○	○	○	○	○	○	○	○	○
○	○	○	○	○	○	○	○	○	○	○	○	○	○	○	○	○	○	○	○	○	○	○	○	○	○
○	○	○	○	○	○	○	○	○	○	○	○	○	○	○	○	○	○	○	○	○	○	○	○	○	○
○	○	○	○	○	○	○	○	○	○	○	○	○	○	○	○	○	○	○	○	○	○	○	○	○	○
○	○	○	○	○	○	○	○	○	○	○	○	○	○	○	○	○	○	○	○	○	○	○	○	○	○
○	○	○	○	○	○	○	○	○	○	○	○	○	○	○	○	○	○	○	○	○	○	○	○	○	○
○	○	○	○	○	○	○	○	○	○	○	○	○	○	○	○	○	○	○	○	○	○	○	○	○	○
○	○	○	○	○	○	○	○	○	○	○	○	○	○	○	○	○	○	○	○	○	○	○	○	○	○
○	○	○	○	○	○	○	○	○	○	○	○	○	○	○	○	○	○	○	○	○	○	○	○	○	○

ISO catalogue number	D	L10	S	Rε	D1
SCMW090304	9,53	9,53	3,18	0,4	4,40
SCMW09T308	9,53	9,53	3,97	0,8	4,40
SCMW120408	12,70	12,70	4,76	0,8	5,50

SNGG-FS • Finishing Sharp

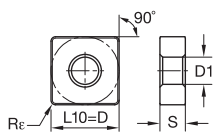

● first choice
○ alternate choice

P	M	K	N	S	H	WP06CT	WP15CT	WP25CT	WP35CT	WM15CT	WM25CT	WM35CT	WK05CT	WK15CT	WK20CT	WS10PT	WS25PT	WU10HT	WU05PT	WP20TT	THM	TTR	WM20CT	WU10PT	WU25PT
●	●	●	●	○	○	○	○	○	○	○	○	○	○	○	○	○	○	○	○	○	○	○	○	○	○
●	○	○	○	○	○	○	○	○	○	○	○	○	○	○	○	○	○	○	○	○	○	○	○	○	○
●	○	○	○	○	○	○	○	○	○	○	○	○	○	○	○	○	○	○	○	○	○	○	○	○	○
○	○	○	○	○	○	○	○	○	○	○	○	○	○	○	○	○	○	○	○	○	○	○	○	○	○
○	○	○	○	○	○	○	○	○	○	○	○	○	○	○	○	○	○	○	○	○	○	○	○	○	○
○	○	○	○	○	○	○	○	○	○	○	○	○	○	○	○	○	○	○	○	○	○	○	○	○	○
○	○	○	○	○	○	○	○	○	○	○	○	○	○	○	○	○	○	○	○	○	○	○	○	○	○
○	○	○	○	○	○	○	○	○	○	○	○	○	○	○	○	○	○	○	○	○	○	○	○	○	○
○	○	○	○	○	○	○	○	○	○	○	○	○	○	○	○	○	○	○	○	○	○	○	○	○	○
○	○	○	○	○	○	○	○	○	○	○	○	○	○	○	○	○	○	○	○	○	○	○	○	○	○
○	○	○	○	○	○	○	○	○	○	○	○	○	○	○	○	○	○	○	○	○	○	○	○	○	○
○	○	○	○	○	○	○	○	○	○	○	○	○	○	○	○	○	○	○	○	○	○	○	○	○	○
○	○	○	○	○	○	○	○	○	○	○	○	○	○	○	○	○	○	○	○	○	○	○	○	○	○
○	○	○	○	○	○	○	○	○	○	○	○	○	○	○	○	○	○	○	○	○	○	○	○	○	○

ISO catalogue number	D	L10	S	Rε	D1
SNGG120408FS	12,70	12,70	4,76	0,8	5,16

INDEXABLE MILLING

SOLID END MILLING

HOLEMAKING

TAPPING

TURNING

SNMG • Roughing

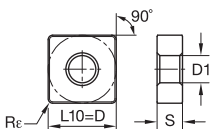
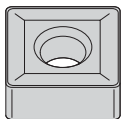

● first choice

○ alternate choice

P	M	K	N	S	H	WP05CT	WP15CT	WP25CT	WP35CT	WM15CT	WM25CT	WM35CT	WK05CT	WK15CT	WK20CT	WS10PT	WS25PT	WU10HT	WU05PT	WP20TT	THM	TTR	WM20CT	WU10PT	WU25PT
●	●	●	●	●	●	○	○	○	○	○	○	○	○	○	○	○	○	○	○	○	○	○	○	○	○
○	○	○	○	○	○	○	○	○	○	○	○	○	○	○	○	○	○	○	○	○	○	○	○	○	○
○	○	○	○	○	○	○	○	○	○	○	○	○	○	○	○	○	○	○	○	○	○	○	○	○	○
○	○	○	○	○	○	○	○	○	○	○	○	○	○	○	○	○	○	○	○	○	○	○	○	○	○
○	○	○	○	○	○	○	○	○	○	○	○	○	○	○	○	○	○	○	○	○	○	○	○	○	○
○	○	○	○	○	○	○	○	○	○	○	○	○	○	○	○	○	○	○	○	○	○	○	○	○	○

ISO catalogue number	D	L10	S	R _ε	D1	WP05CT	WP15CT	WP25CT	WP35CT	WM15CT	WM25CT	WM35CT	WK05CT	WK15CT	WK20CT	WS10PT	WS25PT	WU10HT	WU05PT	WP20TT	THM	TTR	WM20CT	WU10PT	WU25PT	
SNMG120408	12,70	12,70	4,76	0,8	5,16	●	●	●	●	●	●	●	●	●	●	●	●	●	●	●	○	○	○	○	○	
SNMG120408	12,70	12,70	4,76	0,8	5,16	○	○	○	○	○	○	○	○	○	○	○	○	○	○	○	○	○	○	○	○	○
SNMG190612	19,05	19,05	6,35	1,2	7,93	○	○	○	○	○	○	○	○	○	○	○	○	○	○	○	○	○	○	○	○	○
SNMG250724	25,40	25,40	7,94	2,4	9,12	○	○	○	○	○	○	○	○	○	○	○	○	○	○	○	○	○	○	○	○	○
SNMG250924	25,40	25,40	9,53	2,4	9,12	○	○	○	○	○	○	○	○	○	○	○	○	○	○	○	○	○	○	○	○	○

INDEXABLE MILLING

SOLID END MILLING

HOLEMAKING

TAPPING

TURNING

SNMG-FF • Fine Finishing

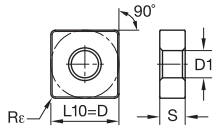
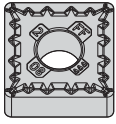

● first choice
○ alternate choice

ISO catalogue number	D	L10	S	R _ε	D1	WP05CT	WP15CT	WP25CT	WP35CT	WM15CT	WM25CT	WM35CT	WK05CT	WK15CT	WK20CT	WS10PT	WS25PT	WU10HT	WU05PT	WP20TT	THM	TTR	WM20CT	WU10PT	WU25PT
						4171046	4171047	4171048	4171049																
SNMG090308FF	9,53	9,53	3,18	0,8	3,81	●	●	●	○	○	○	○	○	○	○	○	○	○	○	○	○	○	○	○	○
SNMG120404FF	12,70	12,70	4,76	0,4	5,16	○	○	○	○	○	○	○	○	○	○	○	○	○	○	○	○	○	○	○	○
SNMG120408FF	12,70	12,70	4,76	0,8	5,16	○	○	○	○	○	○	○	○	○	○	○	○	○	○	○	○	○	○	○	○
SNMG120412FF	12,70	12,70	4,76	1,2	5,16	○	○	○	○	○	○	○	○	○	○	○	○	○	○	○	○	○	○	○	○

SNMG-ML • Medium Machining

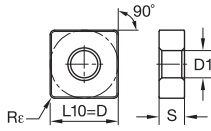
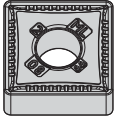

● first choice

○ alternate choice

	P	M	K	N	S	H	WP05CT	WP15CT	WP25CT	WP35CT	WM15CT	WM25CT	WM35CT	WK05CT	WK15CT	WK20CT	WS10PT	WS25PT	WU10HT	WU05PT	WP20TT	THM	TTR	WM20CT	WU10PT	WU25PT	
P	●	●	●	●	●	●	○	○	○	○	○	○	○	○	○	○	○	○	○	○	○	○	○	○	○	○	○
M	○	○	○	○	○	○	○	○	○	○	○	○	○	○	○	○	○	○	○	○	○	○	○	○	○	○	○
K	○	○	○	○	○	○	○	○	○	○	○	○	○	○	○	○	○	○	○	○	○	○	○	○	○	○	○
N	○	○	○	○	○	○	○	○	○	○	○	○	○	○	○	○	○	○	○	○	○	○	○	○	○	○	○
S	○	○	○	○	○	○	○	○	○	○	○	○	○	○	○	○	○	○	○	○	○	○	○	○	○	○	○
H	○	○	○	○	○	○	○	○	○	○	○	○	○	○	○	○	○	○	○	○	○	○	○	○	○	○	○

ISO catalogue number	D	L10	S	Rε	D1	WP05CT	WP15CT	WP25CT	WP35CT	WM15CT	WM25CT	WM35CT	WK05CT	WK15CT	WK20CT	WS10PT	WS25PT	WU10HT	WU05PT	WP20TT	THM	TTR	WM20CT	WU10PT	WU25PT
SNMG090304ML	9,53	9,53	3,18	0,4	3,81		4171071																		
SNMG090308ML	9,53	9,53	3,18	0,8	3,81		4171072 4170488																		
SNMG120404ML	12,70	12,70	4,76	0,4	5,16										4171403										
SNMG120408ML	12,70	12,70	4,76	0,8	5,16		4171073 4170489								4171404										
SNMG120412ML	12,70	12,70	4,76	1,2	5,16		4171074 4170490																		

INDEXABLE MILLING

SOLID END MILLING

HOLEMAKING

TAPPING

TURNING

SNMG-MR • Medium Roughing

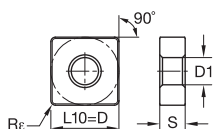
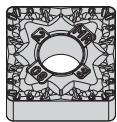

● first choice

○ alternate choice

P	M	K	N	S	H	WP05CT	WP15CT	WP25CT	WP35CT	WM15CT	WM25CT	WM35CT	WK05CT	WK15CT	WK20CT	WS10PT	WS25PT	WU10HT	WU05PT	WP20TT	THM	TTR	WM20CT	WU10PT	WU25PT
●	●	●	●	●	●	○	○	○	○	○	○	○	○	○	○	○	○	○	○	○	○	○	○	○	○
●	○	○	○	○	○	○	○	○	○	○	○	○	○	○	○	○	○	○	○	○	○	○	○	○	○
○	○	○	○	○	○	○	○	○	○	○	○	○	○	○	○	○	○	○	○	○	○	○	○	○	○
○	○	○	○	○	○	○	○	○	○	○	○	○	○	○	○	○	○	○	○	○	○	○	○	○	○
○	○	○	○	○	○	○	○	○	○	○	○	○	○	○	○	○	○	○	○	○	○	○	○	○	○
○	○	○	○	○	○	○	○	○	○	○	○	○	○	○	○	○	○	○	○	○	○	○	○	○	○
○	○	○	○	○	○	○	○	○	○	○	○	○	○	○	○	○	○	○	○	○	○	○	○	○	○
○	○	○	○	○	○	○	○	○	○	○	○	○	○	○	○	○	○	○	○	○	○	○	○	○	○
○	○	○	○	○	○	○	○	○	○	○	○	○	○	○	○	○	○	○	○	○	○	○	○	○	○
○	○	○	○	○	○	○	○	○	○	○	○	○	○	○	○	○	○	○	○	○	○	○	○	○	○
○	○	○	○	○	○	○	○	○	○	○	○	○	○	○	○	○	○	○	○	○	○	○	○	○	○

ISO catalogue number	D	L10	S	Rε	D1
SNMG120408MR	12,70	12,70	4,76	0,8	5,16
SNMG120412MR	12,70	12,70	4,76	1,2	5,16
SNMG120416MR	12,70	12,70	4,76	1,6	5,16
SNMG150612MR	15,88	15,88	6,35	1,2	6,35
SNMG190612MR	19,05	19,05	6,35	1,2	7,93

SNMG-MS • Medium Sharp

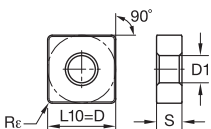
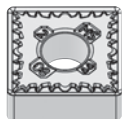

● first choice
○ alternate choice

	P	M	K	N	S	H
WP05CT	●	●	●	○	○	○
WP15CT	●	●	○	○	○	○
WP25CT	○	○	○	○	○	○
WP35CT	○	○	○	○	○	○
WM15CT	○	○	○	○	○	○
WM25CT	○	○	○	○	○	○
WM35CT	○	○	○	○	○	○
WK05CT	○	○	○	○	○	○
WK15CT	○	○	○	○	○	○
WK20CT	○	○	○	○	○	○
WS10PT	○	○	○	○	○	○
WS25PT	○	○	○	○	○	○
WU10HT	○	○	○	○	○	○
WU05PT	○	○	○	○	○	○
WP20TT	○	○	○	○	○	○
THM	○	○	○	○	○	○
TTR	○	○	○	○	○	○
WM20CT	○	○	○	○	○	○
WU10PT	○	○	○	○	○	○
WU25PT	○	○	○	○	○	○

ISO catalogue number	D	L10	S	R ϵ	D1	WP05CT	WP15CT	WP25CT	WP35CT	WM15CT	WM25CT	WM35CT	WK05CT	WK15CT	WK20CT	WS10PT	WS25PT	WU10HT	WU05PT	WP20TT	THM	TTR	WM20CT	WU10PT	WU25PT
SNMG120408MS	12,70	12,70	4,76	0,8	5,16	■	■	■	■	○	○	○	○	○	○	5908847	5908848	5908849							
SNMG120412MS	12,70	12,70	4,76	1,2	5,16	■	■	■	■	○	○	○	○	○	○	5908850	5908921								
SNMG120416MS	12,70	12,70	4,76	1,6	5,16	■	■	■	■	○	○	○	○	○	○	6219754									
SNMG150612MS	15,88	15,88	6,35	1,2	6,35	■	■	■	■	○	○	○	○	○	○		5908923	5908924							
SNMG190612MS	19,05	19,05	6,35	1,2	7,93	■	■	■	■	○	○	○	○	○	○	5908925	5908926								
SNMG190616MS	19,05	19,05	6,35	1,6	7,94	■	■	■	■	○	○	○	○	○	○	6219756									

INDEXABLE MILLING

SOLID END MILLING

HOLEMAKING

TAPPING

TURNING

SNMG-UF • Fine Finishing

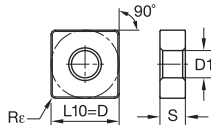
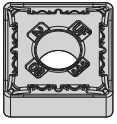

● first choice
○ alternate choice

ISO catalogue number	D	L10	S	R _ε	D1	WP05CT	WP15CT	WP25CT	WP35CT	WM15CT	WM25CT	WM35CT	WK05CT	WK15CT	WK20CT	WS10PT	WS25PT	WU10HT	WU05PT	WP20TT	THM	TTR	WM20CT	WU10PT	WU25PT
SNMG120404UF	12,70	12,70	4,76	0,4	5,16	•	•	•	•	○	○	○	○	○	○	○	○	○	○	○	○	○	○	○	○
SNMG120408UF	12,70	12,70	4,76	0,8	5,16	•	•	•	•	○	○	○	○	○	○	○	○	○	○	○	○	○	○	○	○

SNMG-UM • Medium Machining

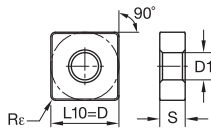
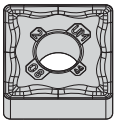

● first choice
○ alternate choice

ISO catalogue number	D	L10	S	R _ε	D1	WP05CT	WP15CT	WP25CT	WP35CT	WM15CT	WM25CT	WM35CT	WK05CT	WK15CT	WK20CT	WS10PT	WS25PT	WU10HT	WU05PT	WP20TT	THM	TTR	WM20CT	WU10PT	WU25PT
SNMG120404UM	12,70	12,70	4,76	0,4	5,16	•	•	•	•	○	○	○	○	○	○	○	○	○	○	○	○	○	○	○	○
SNMG120408UM	12,70	12,70	4,76	0,8	5,16	•	•	•	•	○	○	○	○	○	○	○	○	○	○	○	○	○	○	○	○
SNMG120412UM	12,70	12,70	4,76	1,2	5,16	•	•	•	•	○	○	○	○	○	○	○	○	○	○	○	○	○	○	○	○

INDEXABLE MILLING

SOLID END MILLING

HOLEMAKING

TAPPING

TURNING

SNMG-UR • Universal Roughing

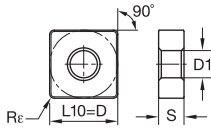
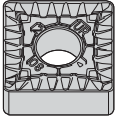

● first choice
○ alternate choice

ISO catalogue number	D	L10	S	R _ε	D1	Material Groups																			
						P	M	K	N	S	H	Al	St	Ti	In	Co	W	Mo	Cu	Al	St	Ti	In	Co	W
						WP05CT	WP15CT	WP25CT	WP35CT	WM15CT	WM25CT	WM35CT	WK05CT	WK15CT	WK20CT	WS10PT	WS25PT	WU10HT	WU05PT	WP20TT	THM	TTR	WM20CT	WU10PT	WU25PT
SNMG120408UR	12,70	12,70	4,76	0,8	5,16	-	4171108	4170516	-	4169429	4169458	4169495	-	-	4171434	-	-	-	-	-	-	-	6942348	6867891	
SNMG120412UR	12,70	12,70	4,76	1,2	5,16	-	4171109	4170517	4169990	4169430	4169459	4169496	-	-	-	5579350	-	-	-	-	-	-	5384941	6867892	
SNMG120416UR	12,70	12,70	4,76	1,6	5,16	-	4171110	-	-	4169460	4169497	-	-	4171436	5680174	5680173	-	-	-	-	-	-	-	-	
SNMG150612UR	15,88	15,88	6,35	1,2	6,35	-	4171111	4170518	4169991	-	4169461	4169498	-	-	4171437	-	5579352	-	-	-	-	-	-	-	
SNMG150616UR	15,88	15,88	6,35	1,6	6,35	-	-	4170519	-	-	4169462	4169499	-	-	4171438	-	-	-	-	-	-	-	-	-	
SNMG190612UR	19,05	19,05	6,35	1,2	7,93	-	4171113	4170520	-	4169433	4169463	4169500	-	-	-	5512538	-	-	-	-	-	-	-	-	
SNMG190616UR	19,05	19,05	6,35	1,6	7,93	-	4171114	4170521	-	-	4169464	4169501	-	-	-	-	-	-	-	-	-	-	-	-	

SNMM-8 • Heavy Roughing

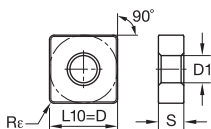

● first choice
○ alternate choice

ISO catalogue number	D	L10	S	Rε	D1	WP05CT	WP15CT	WP25CT	WP35CT	WM15CT	WM25CT	WM35CT	WK05CT	WK15CT	WK20CT	WS10PT	WS25PT	WU10HT	WU05PT	WP20TT	T1M	T1R	WM20CT	WU10PT	WU25PT	
SNMM2507248	25,40	25,40	7,94	2,4	9,12	●	●	●	●	○	○	○	○	○	○	○	○	○	○	○	○	○	○	○	○	○

SNMM-65 • Heavy Roughing

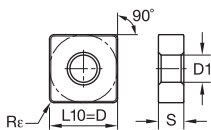
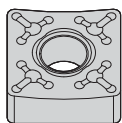

● first choice
○ alternate choice

ISO catalogue number	D	L10	S	Rε	D1	WP05CT	WP15CT	WP25CT	WP35CT	WM15CT	WM25CT	WM35CT	WK05CT	WK15CT	WK20CT	WS10PT	WS25PT	WU10HT	WU05PT	WP20TT	T1M	T1R	WM20CT	WU10PT	WU25PT
SNMM12040865	12,70	12,70	4,76	0,8	5,16	●	●	●	○	○	○	○	○	○	○	○	○	○	○	○	○	○	○	○	○
SNMM12041265	12,70	12,70	4,76	1,2	5,16	●	●	●	○	○	○	○	○	○	○	○	○	○	○	○	○	○	○	○	○
SNMM15061665	15,88	15,88	6,35	1,6	6,35	●	●	●	○	○	○	○	○	○	○	○	○	○	○	○	○	○	○	○	○
SNMM19061265	19,05	19,05	6,35	1,2	7,93	●	●	●	○	○	○	○	○	○	○	○	○	○	○	○	○	○	○	○	○
SNMM19061665	19,05	19,05	6,35	1,6	7,93	●	●	●	○	○	○	○	○	○	○	○	○	○	○	○	○	○	○	○	○
SNMM19062465	19,05	19,05	6,35	2,4	7,93	●	●	●	○	○	○	○	○	○	○	○	○	○	○	○	○	○	○	○	○

INDEXABLE MILLING

SNMM-SR • Heavy Roughing

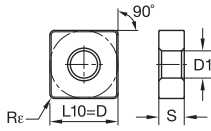
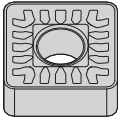

● first choice
○ alternate choice

ISO catalogue number	D	L10	S	R _ε	D1	WP05CT	WP15CT	WP25CT	WP35CT	WM15CT	WM25CT	WM35CT	WK05CT	WK15CT	WK20CT	WS10PT	WS25PT	WU10HT	WU05PT	WP20TT	THM	TTR	WM20CT	WU10PT	WU25PT	
SNMM190616SR	19,05	19,05	6,35	1,6	7,93	●	●	●	○	○	○	○	○	○	○	○	○	○	○	○	○	○	○	○	○	○
SNMM190624SR	19,05	19,05	6,35	2,4	7,93	●	●	●	○	○	○	○	○	○	○	○	○	○	○	○	○	○	○	○	○	
SNMM250724SR	25,40	25,40	7,94	2,4	9,12	○	○	○	○	○	○	○	○	○	○	○	○	○	○	○	○	○	○	○	○	
SNMM250924SR	25,40	25,40	9,53	2,4	9,12	○	○	○	○	○	○	○	○	○	○	○	○	○	○	○	○	○	○	○	○	

SOLID END MILLING

HOLEMAKING

TAPPING

TURNING

SNMP • Medium Machining

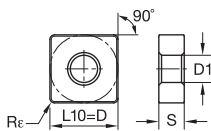
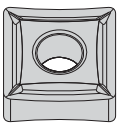

● first choice
○ alternate choice

ISO catalogue number	D	L10	S	R _ε	D1	WP05CT	WP15CT	WP25CT	WP35CT	WM15CT	WM25CT	WM35CT	WK05CT	WK15CT	WK20CT	WS10PT	WS25PT	WU10HT	WU05PT	WP20TT	THM	TTR	WM20CT	WU10PT	WU25PT
SNMP120408	12,70	12,70	4,76	0,8	5,16	●	●	●	○	○	○	○	○	○	○	○	○	○	○	○	○	○	○	○	○
SNMP120412	12,70	12,70	4,76	1,2	5,16	○	○	○	○	○	○	○	○	○	○	○	○	○	○	○	○	○	○	○	○
SNMP150612	15,88	15,88	6,35	1,2	6,35	○	○	○	○	○	○	○	○	○	○	○	○	○	○	○	○	○	○	○	○

SPGN/SPG • Medium Machining

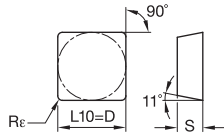
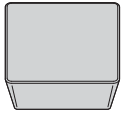

● first choice

○ alternate choice

	P	M	K	N	S	H		WP05CT	WP15CT	WP25CT	WP35CT	WM15CT	WM25CT	WM35CT	WK05CT	WK15CT	WK20CT	WS10PT	WS25PT	WU10HT	WU05PT	WP20TT	THM	TTR	WM20CT	WU10PT	WU25PT			
ISO catalogue number							D	L10	S	Rε	WP05CT	WP15CT	WP25CT	WP35CT	WM15CT	WM25CT	WM35CT	WK05CT	WK15CT	WK20CT	WS10PT	WS25PT	WU10HT	WU05PT	WP20TT	THM	TTR	WM20CT	WU10PT	WU25PT
SPGN090308	●	●	○	○	○	○	9,53	9,53	3,18	0,8									4170943											

SPMR • Medium Machining

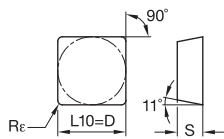
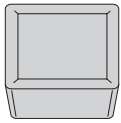

● first choice

○ alternate choice

	P	M	K	N	S	H		WP05CT	WP15CT	WP25CT	WP35CT	WM15CT	WM25CT	WM35CT	WK05CT	WK15CT	WK20CT	WS10PT	WS25PT	WU10HT	WU05PT	WP20TT	THM	TTR	WM20CT	WU10PT	WU25PT			
ISO catalogue number							D	L10	S	Rε	WP05CT	WP15CT	WP25CT	WP35CT	WM15CT	WM25CT	WM35CT	WK05CT	WK15CT	WK20CT	WS10PT	WS25PT	WU10HT	WU05PT	WP20TT	THM	TTR	WM20CT	WU10PT	WU25PT
SPMR120308	●	●	○	○	○	○	12,70	12,70	3,18	0,8		4170854		4170652																

INDEXABLE MILLING

SOLID END MILLING

HOLEMAKING

TAPPING

TURNING

SPMT-FP • Finishing Positive

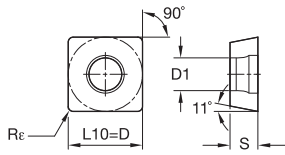
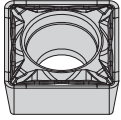

● first choice
○ alternate choice

ISO catalogue number	D	L10	S	Rε	D1	WP05CT	WP15CT	WP25CT	WP35CT	WM15CT	WM25CT	WM35CT	WK05CT	WK15CT	WK20CT	WS10PT	WS25PT	WU10HT	WU05PT	WP20TT	THM	TTR	WM20CT	WU10PT	WU25PT
SPMT09T308FP	9,53	9,53	3,97	0,8	4,40	●	●	●	○	○	○	○	○	○	○	○	○	○	○	○	○	○	○	○	○

SPMT-MP • Medium Positive

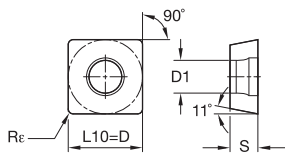
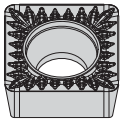

● first choice
○ alternate choice

ISO catalogue number	D	L10	S	Rε	D1	WP05CT	WP15CT	WP25CT	WP35CT	WM15CT	WM25CT	WM35CT	WK05CT	WK15CT	WK20CT	WS10PT	WS25PT	WU10HT	WU05PT	WP20TT	THM	TTR	WM20CT	WU10PT	WU25PT
SPMT09T308MP	9,53	9,53	3,97	0,8	4,40	●	●	●	○	○	○	○	○	○	○	○	○	○	○	○	○	○	○	○	○
SPMT120408MP	12,70	12,70	4,76	0,8	5,50	○	○	○	○	○	○	○	○	○	○	○	○	○	○	○	○	○	○	○	○

INDEXABLE MILLING

SPUN-T/SPU-T • Medium Machining

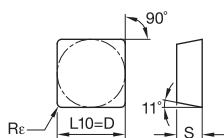
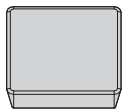

● first choice

○ alternate choice

P	●	●	●	●	○	○	○	○	○	○	○	○	○	○	○	○	○	○	○	○	○	○
M	●	●	●	●	○	○	○	○	○	○	○	○	○	○	○	○	○	○	○	○	○	○
K	○	○	○	○	○	○	○	○	○	○	○	○	○	○	○	○	○	○	○	○	○	○
N	○	○	○	○	○	○	○	○	○	○	○	○	○	○	○	○	○	○	○	○	○	○
S	○	○	○	○	○	○	○	○	○	○	○	○	○	○	○	○	○	○	○	○	○	○
H	○	○	○	○	○	○	○	○	○	○	○	○	○	○	○	○	○	○	○	○	○	○

ISO catalogue number	D	L10	S	Rε	WP05CT	WP15CT	WP25CT	WP35CT	WM15CT	WM25CT	WM35CT	WK05CT	WK15CT	WK20CT	WS10PT	WS25PT	WU10HT	WU05PT	WP20TT	THM	TTR	WM20CT	WU10PT	WU25PT	
SPUN250620T	25,40	25,40	6,35	2,0	4170858	✓	✓	✓	✓	✓	✓	✓	✓	✓	✓	✓	✓	✓	✓	✓	✓	✓	✓	✓	✓

SOLID END MILLING

HOLEMAKING

TAPPING

TURNING

TCMT • Medium Machining

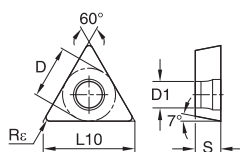
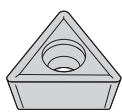

● first choice

○ alternate choice

P	●	●	●	●	○	○	○	○	○	○	○	○	○	○	○	○	○	○	○	○	○	○	○	○	○
M	●	●	●	●	○	○	○	○	○	○	○	○	○	○	○	○	○	○	○	○	○	○	○	○	○
K	○	○	○	○	○	○	○	○	○	○	○	○	○	○	○	○	○	○	○	○	○	○	○	○	○
N	○	○	○	○	○	○	○	○	○	○	○	○	○	○	○	○	○	○	○	○	○	○	○	○	○
S	○	○	○	○	○	○	○	○	○	○	○	○	○	○	○	○	○	○	○	○	○	○	○	○	○
H	○	○	○	○	○	○	○	○	○	○	○	○	○	○	○	○	○	○	○	○	○	○	○	○	○

ISO catalogue number	D	L10	S	Rε	D1	WP05CT	WP15CT	WP25CT	WP35CT	WM15CT	WM25CT	WM35CT	WK05CT	WK15CT	WK20CT	WS10PT	WS25PT	WU10HT	WU05PT	WP20TT	THM	TTR	WM20CT	WU10PT	WU25PT
TCMT110202	6,35	11,00	2,38	0,2	2,80	✓	✓	✓	✓	✓	✓	✓	✓	✓	✓	✓	✓	✓	✓	✓	2028579	✓	✓	✓	✓
TCMT110204	6,35	11,00	2,38	0,4	2,80	✓	✓	✓	✓	✓	✓	✓	✓	✓	✓	✓	✓	✓	✓	✓	2028587	2028589	✓	✓	✓
TCMT16T304	9,53	16,50	3,97	0,4	4,40	✓	✓	✓	✓	✓	✓	✓	✓	✓	✓	✓	✓	✓	✓	✓	2028607	✓	✓	✓	✓
TCMT16T308	9,53	16,50	3,97	0,8	4,40	✓	✓	✓	✓	✓	✓	✓	✓	✓	✓	✓	✓	✓	✓	✓	2028624	2028627	✓	✓	✓
TCMT220408	12,70	22,00	4,76	0,8	5,50	✓	✓	✓	✓	✓	✓	✓	✓	✓	✓	✓	✓	✓	✓	✓	2028660	✓	✓	✓	✓

TCMT-FP • Finishing Positive

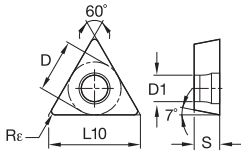
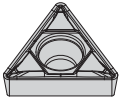

● first choice
○ alternate choice

P	M	K	N	S	H	WP05CT	WP15CT	WP25CT	WP35CT	WM15CT	WM25CT	WM35CT	WK05CT	WK15CT	WK20CT	WS10PT	WS25PT	WU10HT	WU05PT	WP20TT	THM	TTR	WM20CT	WU10PT	WU25PT
●	●	●	●	●	●	●	●	●	●	●	●	●	●	●	●	●	●	●	●	●	●	●	●	●	●
○	○	○	○	○	○	○	○	○	○	○	○	○	○	○	○	○	○	○	○	○	○	○	○	○	○
○	○	○	○	○	○	○	○	○	○	○	○	○	○	○	○	○	○	○	○	○	○	○	○	○	○
○	○	○	○	○	○	○	○	○	○	○	○	○	○	○	○	○	○	○	○	○	○	○	○	○	○
○	○	○	○	○	○	○	○	○	○	○	○	○	○	○	○	○	○	○	○	○	○	○	○	○	○

ISO catalogue number	D	L10	S	Rε	D1	WP05CT	WP15CT	WP25CT	WP35CT	WM15CT	WM25CT	WM35CT	WK05CT	WK15CT	WK20CT	WS10PT	WS25PT	WU10HT	WU05PT	WP20TT	THM	TTR	WM20CT	WU10PT	WU25PT
TCMT110202FP	6,35	11,00	2,38	0,2	2,90	○	○	○	○	○	○	○	○	○	○	○	○	○	○	○	○	○	○	○	○
TCMT110204FP	6,35	11,00	2,38	0,4	2,80	○	○	○	○	○	○	○	○	○	○	○	○	○	○	○	○	○	○	○	○
TCMT110208FP	6,35	11,00	2,38	0,8	2,80	○	○	○	○	○	○	○	○	○	○	○	○	○	○	○	○	○	○	○	○
TCMT16T304FP	9,53	16,50	3,97	0,4	4,40	○	○	○	○	○	○	○	○	○	○	○	○	○	○	○	○	○	○	○	○
TCMT16T308FP	9,53	16,50	3,97	0,8	4,40	○	○	○	○	○	○	○	○	○	○	○	○	○	○	○	○	○	○	○	○
TCMT220408FP	12,70	22,00	4,76	0,8	5,50	○	○	○	○	○	○	○	○	○	○	○	○	○	○	○	○	○	○	○	○

INDEXABLE MILLING

SOLID END MILLING

HOLEMAKING

TAPPING

TURNING

TCMT-MP • Medium Positive

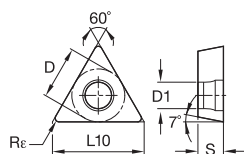

● first choice

○ alternate choice

P	M	K	N	S	H	WP05CT	WP15CT	WP25CT	WP35CT	WM15CT	WM25CT	WM35CT	WK05CT	WK15CT	WK20CT	WS10PT	WS25PT	WU10HT	WU05PT	WP20TT	THM	TTR	WM20CT	WU10PT	WU25PT	
●	●	●	●	●	●	○	○	○	○	○	○	○	○	○	○	○	○	○	○	○	○	○	○	○	○	○
●	○	○	○	○	○	○	○	○	○	○	○	○	○	○	○	○	○	○	○	○	○	○	○	○	○	○
○	○	○	○	○	○	○	○	○	○	○	○	○	○	○	○	○	○	○	○	○	○	○	○	○	○	○
○	○	○	○	○	○	○	○	○	○	○	○	○	○	○	○	○	○	○	○	○	○	○	○	○	○	○
○	○	○	○	○	○	○	○	○	○	○	○	○	○	○	○	○	○	○	○	○	○	○	○	○	○	○

ISO catalogue number	D	L10	S	R _ε	D1
TCMT110208MP	6,35	11,00	2,38	0,8	2,80
TCMT16T304MP	9,53	16,50	3,97	0,4	4,40
TCMT16T308MP	9,53	16,50	3,97	0,8	4,40
TCMT16T312MP	9,53	16,50	3,97	1,2	4,40

TCMT-MU • Medium Universal

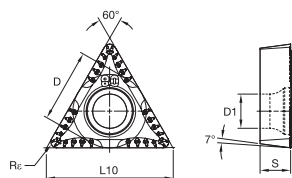
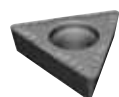

● first choice

○ alternate choice

P	M	K	N	S	H	WP05CT	WP15CT	WP25CT	WP35CT	WM15CT	WM25CT	WM35CT	WK05CT	WK15CT	WK20CT	WS10PT	WS25PT	WU10HT	WU05PT	WP20TT	THM	TTR	WM20CT	WU10PT	WU25PT	
●	●	○	○	○	○	○	○	○	○	○	○	○	○	○	○	○	○	○	○	○	○	○	○	○	○	○
○	○	○	○	○	○	○	○	○	○	○	○	○	○	○	○	○	○	○	○	○	○	○	○	○	○	○
○	○	○	○	○	○	○	○	○	○	○	○	○	○	○	○	○	○	○	○	○	○	○	○	○	○	○
○	○	○	○	○	○	○	○	○	○	○	○	○	○	○	○	○	○	○	○	○	○	○	○	○	○	○
○	○	○	○	○	○	○	○	○	○	○	○	○	○	○	○	○	○	○	○	○	○	○	○	○	○	○

ISO catalogue number	D	L10	S	R _ε	D1
TCMT16T304MU	9,53	13,89	3,97	0,4	4,40
TCMT16T308MU	9,53	16,50	3,97	0,8	4,40
TCMT220412MU	12,70	22,00	4,76	1,2	5,50

TCMT-1P • Finishing

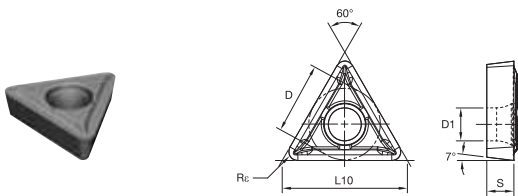

● first choice
○ alternate choice

P	M	K	N	S	H	WP05CT	WP15CT	WP25CT	WP35CT	WM15CT	WM25CT	WM35CT	WK05CT	WK15CT	WK20CT	WS10PT	WS25PT	WU10HT	WU05PT	WP20TT	THM	TTR	WM20CT	WU10PT	WU25PT
●	●	●	●	○	○	○	○	○	○	○	○	○	○	○	○	○	○	○	○	○	○	○	○	○	○
●	●	○	○	○	○	○	○	○	○	○	○	○	○	○	○	○	○	○	○	○	○	○	○	○	○
○	○	○	○	○	○	○	○	○	○	○	○	○	○	○	○	○	○	○	○	○	○	○	○	○	○
○	○	○	○	○	○	○	○	○	○	○	○	○	○	○	○	○	○	○	○	○	○	○	○	○	○
○	○	○	○	○	○	○	○	○	○	○	○	○	○	○	○	○	○	○	○	○	○	○	○	○	○

ISO catalogue number	D	L10	S	R _c	D1	WP05CT	WP15CT	WP25CT	WP35CT	WM15CT	WM25CT	WM35CT	WK05CT	WK15CT	WK20CT	WS10PT	WS25PT	WU10HT	WU05PT	WP20TT	THM	TTR	WM20CT	WU10PT	WU25PT
TCMT1102041P	6,35	11,00	2,38	0,4	2,80	○	○	○	○	○	○	○	○	○	○	○	○	○	○	○	○	○	○	○	○
TCMT1102081P	6,35	11,00	2,38	0,8	2,80	○	○	○	○	○	○	○	○	○	○	○	○	○	○	○	○	○	○	○	○
TCMT16T3041P	9,53	16,50	3,97	0,4	4,40	○	○	○	○	○	○	○	○	○	○	○	○	○	○	○	○	○	○	○	○

TCMW • Medium Machining

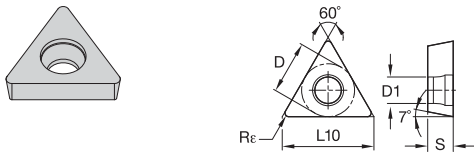

● first choice
○ alternate choice

P	M	K	N	S	H	WP05CT	WP15CT	WP25CT	WP35CT	WM15CT	WM25CT	WM35CT	WK05CT	WK15CT	WK20CT	WS10PT	WS25PT	WU10HT	WU05PT	WP20TT	THM	TTR	WM20CT	WU10PT	WU25PT
●	●	○	○	○	○	○	○	○	○	○	○	○	○	○	○	○	○	○	○	○	○	○	○	○	○
○	○	○	○	○	○	○	○	○	○	○	○	○	○	○	○	○	○	○	○	○	○	○	○	○	○
○	○	○	○	○	○	○	○	○	○	○	○	○	○	○	○	○	○	○	○	○	○	○	○	○	○
○	○	○	○	○	○	○	○	○	○	○	○	○	○	○	○	○	○	○	○	○	○	○	○	○	○
○	○	○	○	○	○	○	○	○	○	○	○	○	○	○	○	○	○	○	○	○	○	○	○	○	○

ISO catalogue number	D	L10	S	R _c	D1	WP05CT	WP15CT	WP25CT	WP35CT	WM15CT	WM25CT	WM35CT	WK05CT	WK15CT	WK20CT	WS10PT	WS25PT	WU10HT	WU05PT	WP20TT	THM	TTR	WM20CT	WU10PT	WU25PT
TCMW110204	6,35	11,00	2,38	0,4	2,85	○	○	○	○	○	○	○	4170476	4170381	○	○	○	○	○	○	○	2028670	○	○	○
TCMW16T304	9,53	16,50	3,97	0,4	4,45	○	○	○	○	○	○	○	○	○	○	○	○	○	○	○	○	○	○	○	○

TNGG-FS • Finishing Sharp

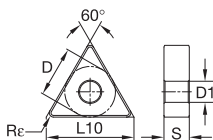
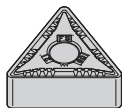

● first choice

○ alternate choice

ISO catalogue number	D	L10	S	Rε	D1	P	M	K	N	S	H	WP05CT	WP15CT	WP25CT	WP35CT	WM15CT	WM25CT	WM35CT	WK05CT	WK15CT	WK20CT	WS10PT	WS25PT	WU10HT	WU05PT	WP20TT	THM	TTR	WM20CT	WU10PT	WU25PT			
						●	●	●	●	●	○	○	○	○	○	○	○	○	○	○	○	○	○	○	○	○	○	○	○	○	○	○	○	○
TNGG160404FS	9,53	16,50	4,76	0,4	3,81	●	●	○	○	○	○	○	○	○	○	○	○	○	○	○	○	○	○	○	○	○	○	○	○	○	○	○	○	
TNGG220408FS	12,70	22,00	4,76	0,8	5,16	○	○	○	○	○	○	○	○	○	○	○	○	○	○	○	○	○	○	○	○	○	○	○	○	○	○	○	○	○

TNMA • Roughing

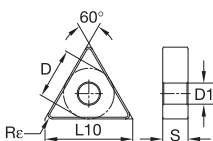
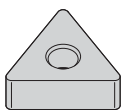

● first choice

○ alternate choice

ISO catalogue number	D	L10	S	Rε	D1	P	M	K	N	S	H	WP05CT	WP15CT	WP25CT	WP35CT	WM15CT	WM25CT	WM35CT	WK05CT	WK15CT	WK20CT	WS10PT	WS25PT	WU10HT	WU05PT	WP20TT	THM	TTR	WM20CT	WU10PT	WU25PT				
						●	●	○	○	○	○	○	○	○	○	○	○	○	○	○	○	○	○	○	○	○	○	○	○	○	○	○	○	○	○
TNMA160408	—	—	—	—	—	○	○	○	○	○	○	○	○	○	○	○	○	○	○	○	○	○	○	○	○	○	○	○	○	○	○	○	○		
TNMA160408	9,53	16,50	4,76	0,8	3,81	○	○	○	○	○	○	○	○	○	○	○	○	○	○	○	○	○	○	○	○	○	○	○	○	○	○	○	○	○	
TNMA160412	9,53	16,50	4,76	1,2	3,81	○	○	○	○	○	○	○	○	○	○	○	○	○	○	○	○	○	○	○	○	○	○	○	○	○	○	○	○	○	
TNMA220408	12,70	22,00	4,76	0,8	5,16	○	○	○	○	○	○	○	○	○	○	○	○	○	○	○	○	○	○	○	○	○	○	○	○	○	○	○	○	○	
TNMA220412	12,70	22,00	4,76	1,2	5,16	○	○	○	○	○	○	○	○	○	○	○	○	○	○	○	○	○	○	○	○	○	○	○	○	○	○	○	○	○	○
TNMA220416	12,70	22,00	4,76	1,6	5,16	○	○	○	○	○	○	○	○	○	○	○	○	○	○	○	○	○	○	○	○	○	○	○	○	○	○	○	○	○	○
TNMA270616	15,88	27,50	6,35	1,6	6,35	○	○	○	○	○	○	○	○	○	○	○	○	○	○	○	○	○	○	○	○	○	○	○	○	○	○	○	○	○	○

TNMG-ML • Medium Machining

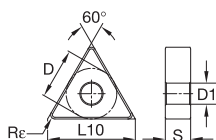

● first choice

○ alternate choice

P	M	K	N	S	H	WP05CT	WP15CT	WP25CT	WP35CT	WM15CT	WM25CT	WM35CT	WK05CT	WK15CT	WK20CT	WS10PT	WS25PT	WU10HT	WU05PT	WP20TT	THM	TTR	WM20CT	WU10PT	WU25PT	
●	●	●	●	●	●	○	○	○	○	○	○	○	○	○	○	○	○	○	○	○	○	○	○	○	○	○
●	○	○	○	○	○	○	○	○	○	○	○	○	○	○	○	○	○	○	○	○	○	○	○	○	○	○
○	○	○	○	○	○	○	○	○	○	○	○	○	○	○	○	○	○	○	○	○	○	○	○	○	○	○
○	○	○	○	○	○	○	○	○	○	○	○	○	○	○	○	○	○	○	○	○	○	○	○	○	○	○
○	○	○	○	○	○	○	○	○	○	○	○	○	○	○	○	○	○	○	○	○	○	○	○	○	○	○
○	○	○	○	○	○	○	○	○	○	○	○	○	○	○	○	○	○	○	○	○	○	○	○	○	○	○
○	○	○	○	○	○	○	○	○	○	○	○	○	○	○	○	○	○	○	○	○	○	○	○	○	○	○
○	○	○	○	○	○	○	○	○	○	○	○	○	○	○	○	○	○	○	○	○	○	○	○	○	○	○
○	○	○	○	○	○	○	○	○	○	○	○	○	○	○	○	○	○	○	○	○	○	○	○	○	○	○
○	○	○	○	○	○	○	○	○	○	○	○	○	○	○	○	○	○	○	○	○	○	○	○	○	○	○
○	○	○	○	○	○	○	○	○	○	○	○	○	○	○	○	○	○	○	○	○	○	○	○	○	○	○

ISO catalogue number	D	L10	S	Rε	D1
TNMG160404ML	9,53	16,50	4,76	0,4	3,81
TNMG160408ML	9,53	16,50	4,76	0,8	3,81
TNMG160412ML	9,53	16,50	4,76	1,2	3,81
TNMG220404ML	12,70	22,00	4,76	0,4	5,16
TNMG220408ML	12,70	22,00	4,76	0,8	5,16

TNMG-MR • Medium Roughing

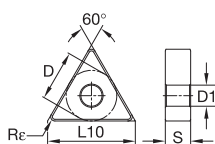

● first choice

○ alternate choice

P	M	K	N	S	H																	
●	●	●	●	●	●	●	○	○	○	○	○	○	○	○	○	○	○	○	○	○	○	○
○	○	○	○	○	○	○	○	○	○	○	○	○	○	○	○	○	○	○	○	○	○	○
○	○	○	○	○	○	○	○	○	○	○	○	○	○	○	○	○	○	○	○	○	○	○
○	○	○	○	○	○	○	○	○	○	○	○	○	○	○	○	○	○	○	○	○	○	○
○	○	○	○	○	○	○	○	○	○	○	○	○	○	○	○	○	○	○	○	○	○	○
○	○	○	○	○	○	○	○	○	○	○	○	○	○	○	○	○	○	○	○	○	○	○
○	○	○	○	○	○	○	○	○	○	○	○	○	○	○	○	○	○	○	○	○	○	○
○	○	○	○	○	○	○	○	○	○	○	○	○	○	○	○	○	○	○	○	○	○	○
○	○	○	○	○	○	○	○	○	○	○	○	○	○	○	○	○	○	○	○	○	○	○
○	○	○	○	○	○	○	○	○	○	○	○	○	○	○	○	○	○	○	○	○	○	○
○	○	○	○	○	○	○	○	○	○	○	○	○	○	○	○	○	○	○	○	○	○	○
○	○	○	○	○	○	○	○	○	○	○	○	○	○	○	○	○	○	○	○	○	○	○

ISO catalogue number	D	L10	S	Rε	D1	WP05CT	WP15CT	WP25CT	WP35CT	WM15CT	WM25CT	WM35CT	WK05CT	WK15CT	WK20CT	WS10PT	WS25PT	WU10HT	WU05PT	WP20TT	THM	TTR	WM20CT	WU10PT	WU25PT
TNMG160404MR	9,53	16,50	4,76	0,4	3,81	○	○	○	○	○	○	○	○	○	○	○	○	○	○	○	○	○	○	○	○
TNMG160408MR	9,53	16,50	4,76	0,8	3,81	○	○	○	○	○	○	○	○	○	○	○	○	○	○	○	○	○	○	○	○
TNMG160412MR	9,53	16,50	4,76	1,2	3,81	○	○	○	○	○	○	○	○	○	○	○	○	○	○	○	○	○	○	○	○
TNMG220404MR	12,70	22,00	4,76	0,4	5,16	○	○	○	○	○	○	○	○	○	○	○	○	○	○	○	○	○	○	○	○
TNMG220408MR	12,70	22,00	4,76	0,8	5,16	○	○	○	○	○	○	○	○	○	○	○	○	○	○	○	○	○	○	○	○
TNMG220412MR	12,70	22,00	4,76	1,2	5,16	○	○	○	○	○	○	○	○	○	○	○	○	○	○	○	○	○	○	○	○
TNMG220416MR	12,70	22,00	4,76	1,6	5,16	○	○	○	○	○	○	○	○	○	○	○	○	○	○	○	○	○	○	○	○

INDEXABLE MILLING

SOLID END MILLING

HOLEMAKING

TAPPING

TURNING

TNMG-MS • Medium Sharp

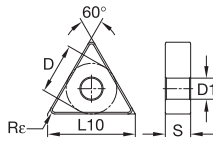
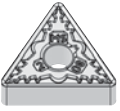

● first choice
○ alternate choice

P	●	●	●	●	○	○	○	○	○	○	○	○	○	○	○	○	○	○	○	○
M	○	○	○	○	○	○	○	○	○	○	○	○	○	○	○	○	○	○	○	○
K	○	○	○	○	○	○	○	○	○	○	○	○	○	○	○	○	○	○	○	○
N	○	○	○	○	○	○	○	○	○	○	○	○	○	○	○	○	○	○	○	○
S	○	○	○	○	○	○	○	○	○	○	○	○	○	○	○	○	○	○	○	○
H	○	○	○	○	○	○	○	○	○	○	○	○	○	○	○	○	○	○	○	○

ISO catalogue number	D	L10	S	Rε	D1	WP05CT	WP15CT	WP25CT	WP35CT	WM15CT	WM25CT	WM35CT	WK05CT	WK15CT	WK20CT	WS10PT	WS25PT	WU10HT	WU05PT	WP20TT	THM	TTR	WM20CT	WU10PT	WU25PT
TNMG160404MS	9,53	16,50	4,76	0,4	3,81	○	○	○	○	○	○	○	○	○	○	○	○	○	○	○	○	○	○	○	○
TNMG160408MS	9,53	16,50	4,76	0,8	3,81	○	○	○	○	○	○	○	○	○	○	○	○	○	○	○	○	○	○	○	○
TNMG220404MS	12,70	22,00	4,76	0,4	5,16	○	○	○	○	○	○	○	○	○	○	○	○	○	○	○	○	○	○	○	○
TNMG220408MS	12,70	22,00	4,76	0,8	5,16	○	○	○	○	○	○	○	○	○	○	○	○	○	○	○	○	○	○	○	○
TNMG220412MS	12,70	22,00	4,76	1,2	5,16	○	○	○	○	○	○	○	○	○	○	○	○	○	○	○	○	○	○	○	○
TNMG270608MS	15,88	27,50	6,35	0,8	6,35	○	○	○	○	○	○	○	○	○	○	○	○	○	○	○	○	○	○	○	○

TNMG-RH • Roughing

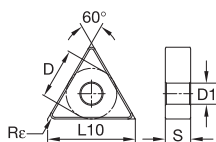

● first choice
○ alternate choice

ISO catalogue number	D	L10	S	R _ε	D1	Material/Condition Compatibility																		
						WP05CT	WP15CT	WP25CT	WP35CT	WM15CT	WM25CT	WM35CT	WK05CT	WK15CT	WK20CT	WS10PT	WS25PT	WU10HT	WU05PT	WP20TT	THM	TTR	WM20CT	WU10PT
TNMG160408RH	9,53	16,50	4,76	0,8	3,81	•	•	•	•	•	•	•	•	•	•	•	•	•	•	•	•	•	•	•
TNMG160412RH	9,53	16,50	4,76	1,2	3,81	•	•	•	•	•	•	•	•	•	•	•	•	•	•	•	•	•	•	•
TNMG220408RH	12,70	22,00	4,76	0,8	5,16	•	•	•	•	•	•	•	•	•	•	•	•	•	•	•	•	•	•	•
TNMG220412RH	12,70	22,00	4,76	1,2	5,16	•	•	•	•	•	•	•	•	•	•	•	•	•	•	•	•	•	•	•
TNMG220416RH	12,70	22,00	4,76	1,6	5,16	•	•	•	•	•	•	•	•	•	•	•	•	•	•	•	•	•	•	•
TNMG270612RH	15,88	27,50	6,35	1,2	6,35	•	•	•	•	•	•	•	•	•	•	•	•	•	•	•	•	•	•	•
TNMG270616RH	15,88	27,50	6,35	1,6	6,35	•	•	•	•	•	•	•	•	•	•	•	•	•	•	•	•	•	•	•
TNMG330924RH	19,05	33,00	9,53	2,4	7,93	•	•	•	•	•	•	•	•	•	•	•	•	•	•	•	•	•	•	•

INDEXABLE MILLING

SOLID END MILLING

HOLEMAKING

TAPPING

TURNING

TNMG-UM • Medium Machining

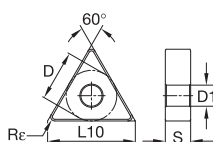
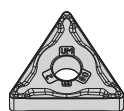

● first choice

○ alternate choice

	P	M	K	N	S	H																				
	●	●	○	○								○	○	○		○	○		○	○		○	○	○		○
ISO catalogue number	D	L10	S	Re	D1	WP05CT	WP15CT	WP25CT	WP35CT	WM15CT	WM25CT	WM35CT	WK05CT	WK15CT	WK20CT	WS10PT	WS25PT	WU10HT	WU05PT	WP20TT	THM	TTR	WM20CT	WU10PT	WU25PT	
TNMG160404UM	9,53	16,50	4,76	0,4	3,81					4172369	4172396					5550226										
TNMG160408UM	9,53	16,50	4,76	0,8	3,81					4172370	4172397	4172427				5550228										
TNMG160412UM	9,53	16,50	4,76	1,2	3,81						4172398	4172398														
TNMG160416UM	9,53	16,50	4,76	1,6	3,81						4172399	4172399														
TNMG220404UM	12,70	22,00	4,76	0,4	5,16						4172400	4172400														
TNMG220408UM	12,70	22,00	4,76	0,8	5,16						4172401	4172401														
TNMG220412UM	12,70	22,00	4,76	1,2	5,16						4172402	4172402														

INDEXABLE MILLING

SOLID END MILLING

HOLEMAKING

TAPPING

TURNING

INDEXABLE MILLING

SOLID END MILLING

HOLEMAKING

TAPPING

TURNING

TNMG-UR • Universal Roughing

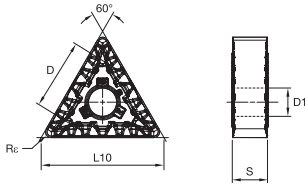
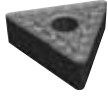

● first choice
○ alternate choice

ISO catalogue number	D	L10	S	Rε	D1	Material Groups																			
						P	M	K	N	S	H	Al	St	Ti	In	Co	W	Br	Cu	Other					
TNMG160408UR	9,53	16,50	4,76	0,8	3,81	WP06CT	WP15CT	WP25CT	WP35CT	WM15CT	WM25CT	WM35CT	WK06CT	WK15CT	WK20CT	WS10PT	WS25PT	WU10HT	WU06PT	WP20TT	THM	TTR	WM20CT	WU10PT	WU25PT
TNMG160412UR	9,53	16,50	4,76	1,2	3,81	4171115	4171116	4170522	4170035	4169434	4169465	4169466	4169468	4169503	4171441	4171443	5680175	5680175	4171444	4171444	4171444	4171444	4171444	6791842	6791845
TNMG160416UR	9,53	16,50	4,76	1,6	3,81	4171117	4171117	4171117	4171117	4171117	4171117	4171117	4171117	4171117	4171443	4171443	4171443	4171443	4171443	4171443	4171443	4171443	4171443	4171443	4171443
TNMG220408UR	12,70	22,00	4,76	0,8	5,16	4171118	4170524	4170036	4169435	4169468	4169503	4171444	4171444	4171444	4171444	4171444	4171444	4171444	4171444	4171444	4171444	4171444	4171444	4171444	
TNMG220412UR	12,70	22,00	4,76	1,2	5,16	4170525	4170525	4170525	4170525	4169469	4169470	4169504	4169504	4169504	4171444	4171444	4171444	4171444	4171444	4171444	4171444	4171444	4171444	4171444	4171444
TNMG220416UR	12,70	22,00	4,76	1,6	5,16	4171120	4171120	4171120	4171120	4169470	4169470	4169504	4169504	4169504	4171444	4171444	4171444	4171444	4171444	4171444	4171444	4171444	4171444	4171444	4171444
TNMG270612UR	15,88	27,50	6,35	1,2	6,35	4171122	4170528	4170527	4170527	4169471	4169471	4169506	4169506	4169506	4171444	4171444	4171444	4171444	4171444	4171444	4171444	4171444	4171444	4171444	4171444
TNMG270616UR	15,88	27,50	6,35	1,6	6,35	4171122	4170528	4170527	4170527	4169471	4169471	4169506	4169506	4169506	4171444	4171444	4171444	4171444	4171444	4171444	4171444	4171444	4171444	4171444	4171444

INDEXABLE MILLING

TPGN/TPG • Medium Machining

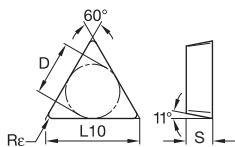
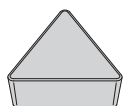

● first choice

○ alternate choice

	P	M	K	N	S	H	WP05CT	WP15CT	WP25CT	WP35CT	WM15CT	WM25CT	WM35CT	WK05CT	WK15CT	WK20CT	WS10PT	WS25PT	WU10HT	WU05PT	WP20TT	THM	TTR	WM20CT	WU10PT	WU25PT
P	●	●	●	●	●	●	○	○	○	○	○	○	○	○	○	○	○	○	○	○	○	○	○	○	○	○
M	●	●	○	○	○	○	○	○	○	○	○	○	○	○	○	○	○	○	○	○	○	○	○	○	○	○
K	○	○	○	○	○	○	○	○	○	○	○	○	○	○	○	○	○	○	○	○	○	○	○	○	○	○
N	○	○	○	○	○	○	○	○	○	○	○	○	○	○	○	○	○	○	○	○	○	○	○	○	○	○
S	○	○	○	○	○	○	○	○	○	○	○	○	○	○	○	○	○	○	○	○	○	○	○	○	○	○
H	○	○	○	○	○	○	○	○	○	○	○	○	○	○	○	○	○	○	○	○	○	○	○	○	○	○

ISO catalogue number	D	L10	S	Rε	WP05CT	WP15CT	WP25CT	WP35CT	WM15CT	WM25CT	WM35CT	WK05CT	WK15CT	WK20CT	WS10PT	WS25PT	WU10HT	WU05PT	WP20TT	THM	TTR	WM20CT	WU10PT	WU25PT	
TPGN110304	6,35	11,00	3,18	0,4																	2015100				
TPGN110308	6,35	11,00	3,18	0,8										4170952											
TPGN160308	9,53	16,50	3,18	0,8									4170953												

SOLID END MILLING

HOLE MAKING

TAPPING

TPGA • Medium Machining

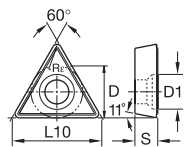
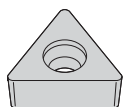

● first choice

○ alternate choice

	P	M	K	N	S	H	WP05CT	WP15CT	WP25CT	WP35CT	WM15CT	WM25CT	WM35CT	WK05CT	WK15CT	WK20CT	WS10PT	WS25PT	WU10HT	WU05PT	WP20TT	THM	TTR	WM20CT	WU10PT	WU25PT
P	●	●	●	●	●	●	○	○	○	○	○	○	○	○	○	○	○	○	○	○	○	○	○	○	○	○
M	●	●	○	○	○	○	○	○	○	○	○	○	○	○	○	○	○	○	○	○	○	○	○	○	○	○
K	○	○	○	○	○	○	○	○	○	○	○	○	○	○	○	○	○	○	○	○	○	○	○	○	○	○
N	○	○	○	○	○	○	○	○	○	○	○	○	○	○	○	○	○	○	○	○	○	○	○	○	○	○
S	○	○	○	○	○	○	○	○	○	○	○	○	○	○	○	○	○	○	○	○	○	○	○	○	○	○
H	○	○	○	○	○	○	○	○	○	○	○	○	○	○	○	○	○	○	○	○	○	○	○	○	○	○

ISO catalogue number	D	L10	S	Rε	D1	WP05CT	WP15CT	WP25CT	WP35CT	WM15CT	WM25CT	WM35CT	WK05CT	WK15CT	WK20CT	WS10PT	WS25PT	WU10HT	WU05PT	WP20TT	THM	TTR	WM20CT	WU10PT	WU25PT	
TPGA110204	6,35	11,00	2,38	0,4	3,40																	2015081				
TPGA110208	6,35	11,00	2,38	0,8	3,40																	2031786				

TURNING

TPMR • Medium Machining

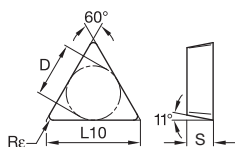
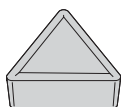

● first choice
○ alternate choice

ISO catalogue number	D	L10	S	R ϵ	Material Group																														
					P	M	K	N	S	H	WP05CT	WP15CT	WP25CT	WP35CT	WM15CT	WM25CT	WM35CT	WK05CT	WK15CT	WK20CT	WS10PT	WS25PT	WU10HT	WU05PT	WP20TT	THM	TTR	WM20CT	WU10PT	WU25PT					
TPMR110304	6,35	11,00	3,18	0,4	●	●	●	○	○	○	○	○	○	○	○	○	○	○	○	○	○	○	○	○	○	○	○	○	○	○	○	○	○	○	○
TPMR110308	6,35	11,00	3,18	0,8	○	○	○	○	○	○	○	○	○	○	○	○	○	○	○	○	○	○	○	○	○	○	○	○	○	○	○	○	○	○	○
TPMR160304	9,53	16,50	3,18	0,4	○	○	○	○	○	○	○	○	○	○	○	○	○	○	○	○	○	○	○	○	○	○	○	○	○	○	○	○	○	○	○
TPMR160308	9,53	16,50	3,18	0,8	○	○	○	○	○	○	○	○	○	○	○	○	○	○	○	○	○	○	○	○	○	○	○	○	○	○	○	○	○	○	○
TPMR160312	9,53	16,50	3,18	1,2	○	○	○	○	○	○	○	○	○	○	○	○	○	○	○	○	○	○	○	○	○	○	○	○	○	○	○	○	○	○	○

TPMT-FP • Finishing Positive

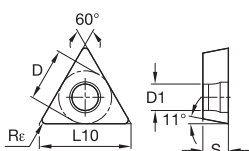
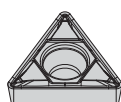

● first choice
○ alternate choice

ISO catalogue number	D	L10	S	R ϵ	D1	Material Group																														
						P	M	K	N	S	H	WP05CT	WP15CT	WP25CT	WP35CT	WM15CT	WM25CT	WM35CT	WK05CT	WK15CT	WK20CT	WS10PT	WS25PT	WU10HT	WU05PT	WP20TT	THM	TTR	WM20CT	WU10PT	WU25PT					
TPMT110204FP	6,35	11,00	2,38	0,4	2,80	○	○	○	○	○	○	○	○	○	○	○	○	○	○	○	○	○	○	○	○	○	○	○	○	○	○	○	○	○	○	
TPMT16T308FP	9,53	16,50	3,97	0,8	4,40	○	○	○	○	○	○	○	○	○	○	○	○	○	○	○	○	○	○	○	○	○	○	○	○	○	○	○	○	○	○	
TPMT220408FP	12,70	22,00	4,76	0,8	5,50	○	○	○	○	○	○	○	○	○	○	○	○	○	○	○	○	○	○	○	○	○	○	○	○	○	○	○	○	○	○	○

VNMG • Medium Machining

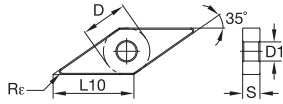

● first choice
○ alternate choice

ISO catalogue number	D	L10	S	Rε	D1	WP05CT	WP15CT	WP25CT	WP35CT	WM15CT	WM25CT	WM35CT	WK05CT	WK15CT	WK20CT	WS10PT	WS25PT	WU10HT	WU05PT	WP20TT	THM	TTR	WM20CT	WU10PT	WU25PT
VNMG12T304	7,14	12,45	3,97	0,4	3,60	●	●	●	●	●	●	●	●	●	●	●	●	○	○	○	○	○	○	○	○
VNMG12T308	7,14	12,45	3,97	0,8	3,60	○	○	○	○	○	○	○	○	○	○	○	○	○	○	○	○	○	○	○	○

VNMG-FF • Fine Finishing

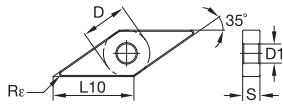
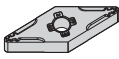

● first choice
○ alternate choice

ISO catalogue number	D	L10	S	Rε	D1	WP05CT	WP15CT	WP25CT	WP35CT	WM15CT	WM25CT	WM35CT	WK05CT	WK15CT	WK20CT	WS10PT	WS25PT	WU10HT	WU05PT	WP20TT	THM	TTR	WM20CT	WU10PT	WU25PT
VNMG160404FF	9,53	16,61	4,76	0,4	3,81	○	●	●	●	●	●	●	●	●	●	●	●	○	○	○	○	○	○	○	○
VNMG160408FF	9,53	16,61	4,76	0,8	3,81	○	○	○	○	○	○	○	○	○	○	○	○	○	○	○	○	○	○	○	○

VNMG-UF • Fine Finishing

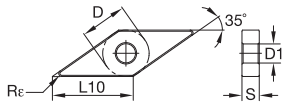

● first choice
○ alternate choice

ISO catalogue number	D	L10	S	R _ε	D1	WP05CT	WP15CT	WP25CT	WP35CT	WM15CT	WM25CT	WM35CT	WK05CT	WK15CT	WK20CT	WS10PT	WS25PT	WU10HT	WU05PT	WP20TT	THM	TTR	WM20CT	WU10PT	WU25PT
VNMG160404UF	9,53	16,61	4,76	0,4	3,81	●	●	●	○	○	○	○	○	○	○	○	○	○	○	○	○	○	○	○	○
VNMG160408UF	9,53	16,61	4,76	0,8	3,81	○	○	○	○	○	○	○	○	○	○	○	○	○	○	○	○	○	○	○	○

VNMG-UR • Universal Roughing

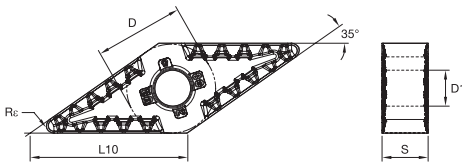

● first choice
○ alternate choice

ISO catalogue number	D	L10	S	R _ε	D1	WP05CT	WP15CT	WP25CT	WP35CT	WM15CT	WM25CT	WM35CT	WK05CT	WK15CT	WK20CT	WS10PT	WS25PT	WU10HT	WU05PT	WP20TT	THM	TTR	WM20CT	WU10PT	WU25PT
VNMG160408UR	9,53	16,61	4,76	0,8	3,81	○	○	○	○	○	○	○	○	○	○	○	○	○	○	○	○	○	○	○	○
VNMG160412UR	9,53	16,61	4,76	1,2	3,81	○	○	○	○	○	○	○	○	○	○	○	○	○	○	○	○	○	○	○	○

INDEXABLE MILLING

VNMP • Medium Machining

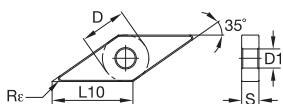
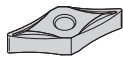

● first choice

○ alternate choice

	P	M	K	N	S	H	WP05CT	WP15CT	WP25CT	WP35CT	WM15CT	WM25CT	WM35CT	WK05CT	WK15CT	WK20CT	WS10PT	WS25PT	WU10HT	WU05PT	WP20TT	THM	TTR	WM20CT	WU10PT	WU25PT
P	●	●	●	●	●	●	○	○	○	○	○	○	○	○	○	○	○	○	○	○	○	○	○	○	○	○
M	●	●	○	○	○	○	○	○	○	○	○	○	○	○	○	○	○	○	○	○	○	○	○	○	○	○
K	○	○	○	○	○	○	○	○	○	○	○	○	○	○	○	○	○	○	○	○	○	○	○	○	○	○
N	○	○	○	○	○	○	○	○	○	○	○	○	○	○	○	○	○	○	○	○	○	○	○	○	○	○
S	○	○	○	○	○	○	○	○	○	○	○	○	○	○	○	○	○	○	○	○	○	○	○	○	○	○
H	○	○	○	○	○	○	○	○	○	○	○	○	○	○	○	○	○	○	○	○	○	○	○	○	○	○

ISO catalogue number	D	L10	S	Rε	D1	WP05CT	WP15CT	WP25CT	WP35CT	WM15CT	WM25CT	WM35CT	WK05CT	WK15CT	WK20CT	WS10PT	WS25PT	WU10HT	WU05PT	WP20TT	THM	TTR	WM20CT	WU10PT	WU25PT
VNMP160404	9,53	16,61	4,76	0,4	3,81	○	○	○	○	○	○	○	○	○	○	○	○	○	○	○	○	○	○	○	○
VNMP160408	9,53	16,61	4,76	0,8	3,81	○	○	○	○	○	○	○	○	○	○	○	○	○	○	○	○	○	○	○	○

SOLID END MILLING

HOLEMAKING

WNGG-FS • Finishing Sharp

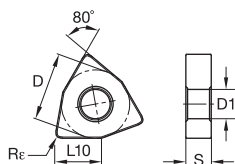
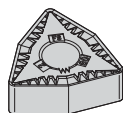

● first choice

○ alternate choice

	P	M	K	N	S	H	WP05CT	WP15CT	WP25CT	WP35CT	WM15CT	WM25CT	WM35CT	WK05CT	WK15CT	WK20CT	WS10PT	WS25PT	WU10HT	WU05PT	WP20TT	THM	TTR	WM20CT	WU10PT	WU25PT
P	●	●	●	●	●	●	○	○	○	○	○	○	○	○	○	○	○	○	○	○	○	○	○	○	○	○
M	●	●	○	○	○	○	○	○	○	○	○	○	○	○	○	○	○	○	○	○	○	○	○	○	○	○
K	○	○	○	○	○	○	○	○	○	○	○	○	○	○	○	○	○	○	○	○	○	○	○	○	○	○
N	○	○	○	○	○	○	○	○	○	○	○	○	○	○	○	○	○	○	○	○	○	○	○	○	○	○
S	○	○	○	○	○	○	○	○	○	○	○	○	○	○	○	○	○	○	○	○	○	○	○	○	○	○
H	○	○	○	○	○	○	○	○	○	○	○	○	○	○	○	○	○	○	○	○	○	○	○	○	○	○

ISO catalogue number	D	L10	S	Rε	D1	WP05CT	WP15CT	WP25CT	WP35CT	WM15CT	WM25CT	WM35CT	WK05CT	WK15CT	WK20CT	WS10PT	WS25PT	WU10HT	WU05PT	WP20TT	THM	TTR	WM20CT	WU10PT	WU25PT
WNGG080404FS	12,70	8,69	4,76	0,4	5,16	○	○	○	○	○	○	○	○	○	○	○	○	○	○	○	○	○	○	○	○
WNGG080408FS	12,70	8,69	4,76	0,8	5,16	○	○	○	○	○	○	○	○	○	○	○	○	○	○	○	○	○	○	○	○

TAPPING

TURNING

WNMA • Roughing

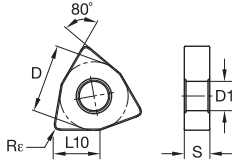
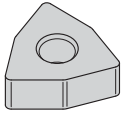

● first choice
○ alternate choice

ISO catalogue number	D	L10	S	R ϵ	D1	P	M	K	N	S	H																					
						WP05CT	WP15CT	WP25CT	WP35CT	WM15CT	WM25CT	WM35CT	WK05CT	WK15CT	WK20CT	WS10PT	WS25PT	WU10HT	WU05PT	WP20TT	THM	TTR	WM20CT	WU10PT	WU25PT							
WNMA060408	9,53	6,52	4,76	0,8	3,81	●	●	●	●	○	○	○	○	○	○	○	○	○	○	○	○	○	○	○	○	○	○	○	○	○	○	○
WNMA060412	9,53	6,52	4,76	1,2	3,81	○	○	○	○	○	○	○	○	○	○	○	○	○	○	○	○	○	○	○	○	○	○	○	○	○	○	○
WNMA080408	12,70	8,69	4,76	0,8	5,16	○	○	○	○	○	○	○	○	○	○	○	○	○	○	○	○	○	○	○	○	○	○	○	○	○	○	○
WNMA080412	12,70	8,69	4,76	1,2	5,16	○	○	○	○	○	○	○	○	○	○	○	○	○	○	○	○	○	○	○	○	○	○	○	○	○	○	○
WNMA080416	12,70	8,69	4,76	0,6	5,16	○	○	○	○	○	○	○	○	○	○	○	○	○	○	○	○	○	○	○	○	○	○	○	○	○	○	○

WNMG-5 • Roughing

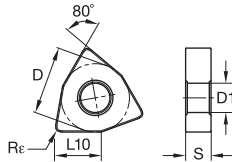
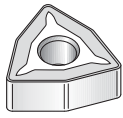

● first choice
○ alternate choice

ISO catalogue number	D	L10	S	R ϵ	D1	P	M	K	N	S	H																				
						WP05CT	WP15CT	WP25CT	WP35CT	WM15CT	WM25CT	WM35CT	WK05CT	WK15CT	WK20CT	WS10PT	WS25PT	WU10HT	WU05PT	WP20TT	THM	TTR	WM20CT	WU10PT	WU25PT						
WNMG080408-5	12,70	8,69	4,76	0,8	5,16	○	○	○	○	○	○	○	○	○	○	○	○	○	○	○	○	○	○	○	○	○	○	○	○	○	○

INDEXABLE MILLING

SOLID END MILLING

HOLEMAKING

TAPPING

TURNING

WNMG-FF • Fine Finishing

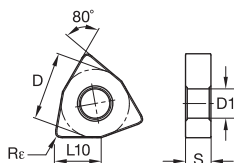

● first choice

○ alternate choice

ISO catalogue number	D	L10	S	Rε	D1	Material Groups																			
						P	M	K	N	S	H	Al	St	Ti	In	Co	W	Br	Cu	Al	St	Ti	In	Co	W
						WP05CT	WP15CT	WP25CT	WP35CT	WM15CT	WM25CT	WM35CT	WK05CT	WK15CT	WK20CT	WS10PT	WS25PT	WU10HT	WU05PT	WP20TT	THM	TTR	WM20CT	WU10PT	WU25PT
WNMG060404FF	9,53	6,52	4,76	0,4	3,81	○	●	●	●	○	○	○	○	○	○	○	○	○	○	○	○	○	○	○	
WNMG060408FF	9,53	6,52	4,76	0,8	3,81	○	○	○	○	○	○	○	○	○	○	○	○	○	○	○	○	○	○	○	
WNMG080404FF	12,70	8,69	4,76	0,4	5,16	○	○	○	○	○	○	○	○	○	○	○	○	○	○	○	○	○	○	○	
WNMG080408FF	12,70	8,69	4,76	0,8	5,16	○	○	○	○	○	○	○	○	○	○	○	○	○	○	○	○	○	○	○	

WNMG-FW • Finishing Wiper

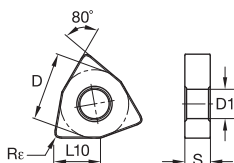
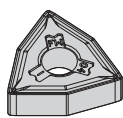

● first choice

○ alternate choice

ISO catalogue number	D	L10	S	Rε	D1	Material Groups																			
						P	M	K	N	S	H	Al	St	Ti	In	Co	W	Br	Cu	Al	St	Ti	In	Co	W
						WP05CT	WP15CT	WP25CT	WP35CT	WM15CT	WM25CT	WM35CT	WK05CT	WK15CT	WK20CT	WS10PT	WS25PT	WU10HT	WU05PT	WP20TT	THM	TTR	WM20CT	WU10PT	WU25PT
WNMG060408FW	9,53	6,52	4,76	0,8	3,81	○	○	○	○	○	○	○	○	○	○	○	○	○	○	○	○	○	○	○	
WNMG080408FW	12,70	8,69	4,76	0,8	5,16	○	○	○	○	○	○	○	○	○	○	○	○	○	○	○	○	○	○	○	

WNMG-MS • Medium Sharp

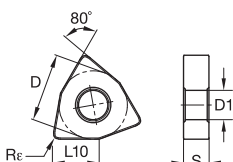

● first choice

○ alternate choice

ISO catalogue number	D	L10	S	R _ε	D1	WP05CT	WP15CT	WP25CT	WP35CT	WM15CT	WM25CT	WM35CT	WK05CT	WK15CT	WK20CT	WS10PT	WS25PT	WU10HT	WU05PT	WP20TT	THM	TTR	WM20CT	WU10PT	WU25PT	
WNMG060408MS	9,53	6,52	4,76	0,8	3,81	●	●	●	○	○	○	○	○	○	○	○	○	○	○	○	○	○	○	○	○	○
WNMG080404MS	12,70	8,69	4,76	0,4	5,16	○	○	○	○	○	○	○	○	○	○	○	○	○	○	○	○	○	○	○	○	○
WNMG080408MS	12,70	8,69	4,76	0,8	5,16	○	○	○	○	○	○	○	○	○	○	○	○	○	○	○	○	○	○	○	○	○

WNMG-MW • Medium Wiper

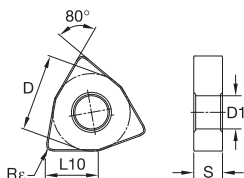
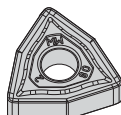

● first choice

○ alternate choice

ISO catalogue number	D	L10	S	R _ε	D1	WP05CT	WP15CT	WP25CT	WP35CT	WM15CT	WM25CT	WM35CT	WK05CT	WK15CT	WK20CT	WS10PT	WS25PT	WU10HT	WU05PT	WP20TT	THM	TTR	WM20CT	WU10PT	WU25PT	
WNMG080408MW	12,70	8,69	4,76	0,8	5,16	○	○	○	○	○	○	○	○	○	○	○	○	○	○	○	○	○	○	○	○	○
WNMG080412MW	12,70	8,69	4,76	1,2	5,16	○	○	○	○	○	○	○	○	○	○	○	○	○	○	○	○	○	○	○	○	○

WNMG-RH • Roughing

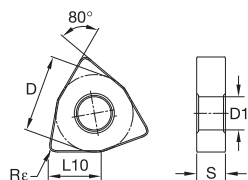
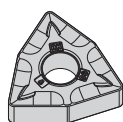

● first choice
○ alternate choice

ISO catalogue number	D	L10	S	R _e	D1	Material Groups																				
						P	M	K	N	S	H	Al	Ti	Inconel	Stainless	Aluminum	Cast Iron	Steel	Other							
WNMG060408RH	9,53	6,52	4,76	0,8	3,81	●	●	○	○	○	○	○	○	○	○	○	○	○	○	○	○	○	○	○	○	○
WNMG080408RH	12,70	8,69	4,76	0,8	5,16	●	●	○	○	○	○	○	○	○	○	○	○	○	○	○	○	○	○	○	○	○
WNMG080412RH	12,70	8,69	4,76	1,2	5,16	●	●	○	○	○	○	○	○	○	○	○	○	○	○	○	○	○	○	○	○	○
WNMG080416RH	12,70	8,69	4,76	1,6	5,16	●	●	○	○	○	○	○	○	○	○	○	○	○	○	○	○	○	○	○	○	○

WNMG-RU • Roughing Universal

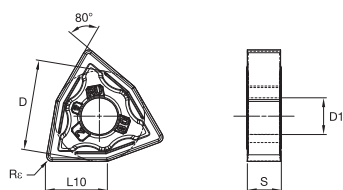

● first choice
○ alternate choice

ISO catalogue number	D	L10	S	R _e	D1	Material Groups																				
						P	M	K	N	S	H	Al	Ti	Inconel	Stainless	Aluminum	Cast Iron	Steel	Other							
WNMG080408RU	12,70	8,69	4,76	0,8	5,16	●	●	○	○	○	○	○	○	○	○	○	○	○	○	○	○	○	○	○	○	○
WNMG080412RU	12,70	8,69	4,76	1,2	5,16	●	●	○	○	○	○	○	○	○	○	○	○	○	○	○	○	○	○	○	○	○

INDEXABLE MILLING

SOLID END MILLING

HOLE MAKING

TAPPING

TURNING

WNMG-UF • Fine Finishing

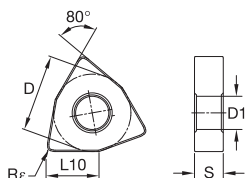

● first choice

○ alternate choice

ISO catalogue number	D	L10	S	R _ε	D1	P	M	K	N	S	H	WP05CT	WP15CT	WP25CT	WP35CT	WM15CT	WM25CT	WM35CT	WK06CT	WK15CT	WK20CT	WS10PT	WS25PT	WU10HT	WU05PT	WP20TT	THM	TTR	WM20CT	WU10PT	WU25PT	
						●	●	●	●	●	●	●	●	●	●	●	●	●	●	●	●	●	●	●	●	●	●	●	●	●	●	●
WNMG060404UF	9,53	6,52	4,76	0,4	3,81	●	●	○	○	○	○	○	○	○	○	○	○	○	○	○	○	○	○	○	○	○	○	○	○	○	○	○
WNMG060408UF	9,53	6,52	4,76	0,8	3,81	○	○	○	○	○	○	○	○	○	○	○	○	○	○	○	○	○	○	○	○	○	○	○	○	○	○	○
WNMG080404UF	12,70	8,69	4,76	0,4	5,16	○	○	○	○	○	○	○	○	○	○	○	○	○	○	○	○	○	○	○	○	○	○	○	○	○	○	○
WNMG080408UF	12,70	8,69	4,76	0,8	5,16	○	○	○	○	○	○	○	○	○	○	○	○	○	○	○	○	○	○	○	○	○	○	○	○	○	○	○
WNMG080412UF	12,70	8,69	4,76	1,2	5,16	○	○	○	○	○	○	○	○	○	○	○	○	○	○	○	○	○	○	○	○	○	○	○	○	○	○	○

INDEXABLE MILLING

SOLID END MILLING

HOLE/MAKING

TAPPING

TURNING

WNMG-UR • Universal Roughing

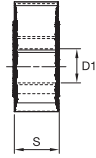
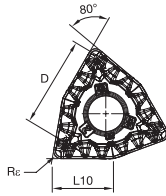
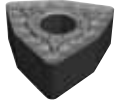

● first choice
○ alternate choice

ISO catalogue number	D	L10	S	R _c	D1	WP05CT	WP15CT	WP25CT	WP35CT	WM15CT	WM25CT	WM35CT	WK05CT	WK15CT	WK20CT	WS10PT	WS25PT	WU10HT	WU05PT	WP20TT	THM	TTR	WM20CT	WU10PT	WU25PT	
WNMG060408UR	9,53	6,52	4,76	0,8	3,81	●	●	●	○	○	○	○	○	○	○	○	○	○	○	○	○	○	○	○	○	○
WNMG060412UR	9,53	6,52	4,76	1,2	3,81	●	●	●	○	○	○	○	○	○	○	○	○	○	○	○	○	○	○	○	○	
WNMG080408UR	12,70	8,69	4,76	0,8	5,16	○	○	○	○	○	○	○	○	○	○	○	○	○	○	○	○	○	○	○	○	
WNMG080412UR	12,70	8,69	4,76	1,2	5,16	○	○	○	○	○	○	○	○	○	○	○	○	○	○	○	○	○	○	○	○	
WNMG080416UR	12,70	8,69	4,76	1,6	5,16	○	○	○	○	○	○	○	○	○	○	○	○	○	○	○	○	○	○	○	○	

WNMP • Medium Machining

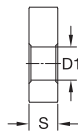
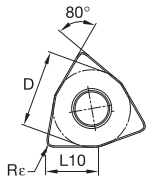
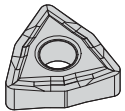

● first choice
○ alternate choice

ISO catalogue number	D	L10	S	R _c	D1	WP05CT	WP15CT	WP25CT	WP35CT	WM15CT	WM25CT	WM35CT	WK05CT	WK15CT	WK20CT	WS10PT	WS25PT	WU10HT	WU05PT	WP20TT	THM	TTR	WM20CT	WU10PT	WU25PT
WNMP080408	12,70	8,69	4,76	0,8	5,16	○	○	○	○	○	○	○	○	○	○	○	○	○	○	○	○	○	○	○	○

WPMT-FP • Finishing Positive

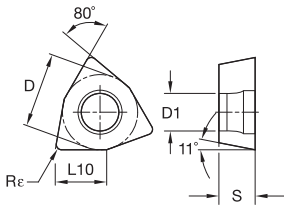
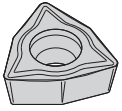

● first choice
○ alternate choice

ISO catalogue number	D	L10	S	R _ε	D1	WP05CT	WP15CT	WP25CT	WP35CT	WM15CT	WM25CT	WM35CT	WK05CT	WK15CT	WK20CT	WS10PT	WS25PT	WU10HT	WU05PT	WP20TT	THM	TTR	WM20CT	WU10PT	WU25PT	
WPMT06T308FP	9,53	6,52	3,97	0,8	4,40	●	●	●	○	○	○	○	○	○	○	○	○	○	○	○	○	○	○	○	○	○

INDEXABLE MILLING

SOLID END MILLING

HOLEMAKING

TAPPING

TURNING

Inserts for Aluminum

-AL Geometry

The AL geometry ISO turning series offers various grades and popular styles, giving customers more versatility and optionality when machining aluminum and non-ferrous metal materials in medium to finish turning applications.

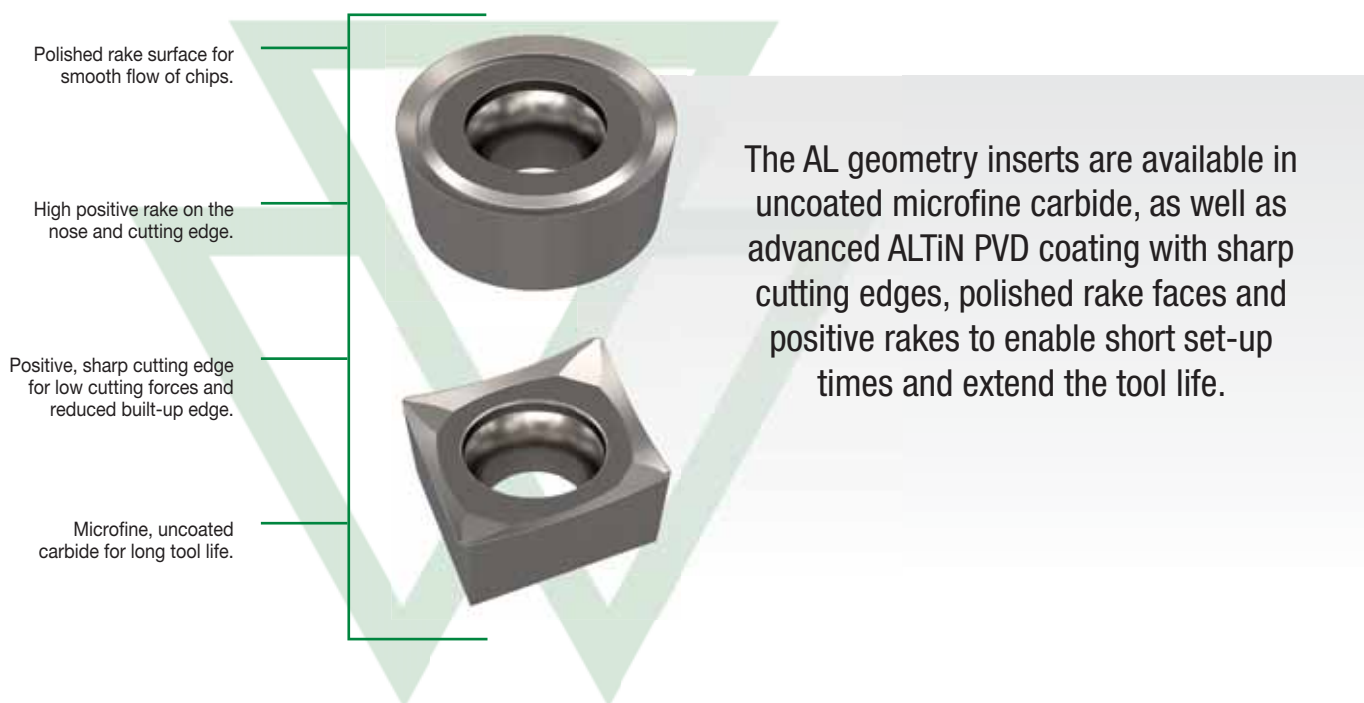

INSERTS FOR ALUMINUM

VERSATILE

RELIABLE

AFFORDABLE

MEDIUM TO FINISHING ALUMINUM TURNING

WU10HT/WU05PT • GRADE INFORMATION

A hard, unalloyed, low-binder content with fine-grained carbide. It is a wear-resistant, uncoated carbide for machining of aluminum and other non-ferrous materials.

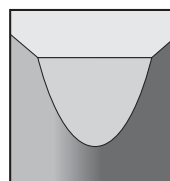

WU10HT/WU05PT

		Geometry
		AL
Lightly Interrupted Cut		WU10HT/WU05PT
Varying Depth of Cut		WU10HT/WU05PT
Smooth Cut		WU10HT/WU05PT

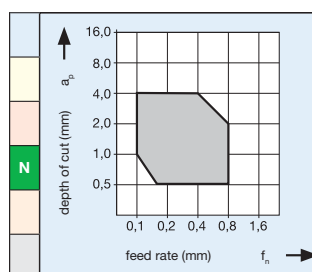

For cost-effective machining of aluminum, non-ferrous metals, and plastics. Extremely sharp cutting edges result in optimum part finishes with low cutting forces and short chips.

APPLICATIONS



TURNING



FACING



PROFILING



CHAMFERING



BORING

INDUSTRY

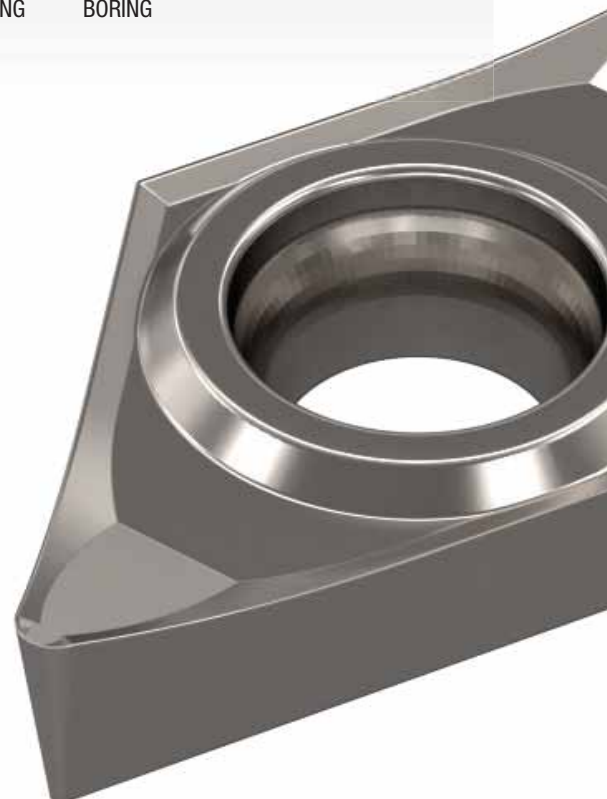

Grades and Grade Descriptions

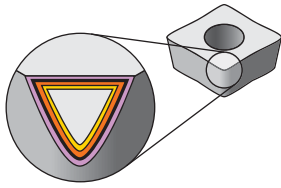

Coatings provide high-speed capability and are engineered for finishing to heavy roughing.

P	Steel
M	Stainless Steel
K	Cast Iron
N	Non-Ferrous
S	High-Temp Alloys
H	Hardened Materials

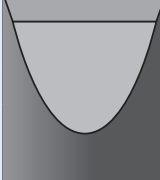
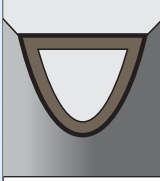
Coating	Grade Description	wear resistance ← → toughness									
		05	10	15	20	25	30	35	40	45	
WU10HT  HW-N10	Uncoated carbide. Highly wear-resistant microfine substrate. Suitable for finish turning applications in aluminum and all types of non-ferrous materials, stainless steel, and high-temp alloys with suitable edge preparation. Mainly applied in continuous cuts.										
		M									
		N									
		S									
WU05PT  HC-N05	Coated carbide. PVD AlTiN-coated grade with microfine substrate and highly wear-resistant coating. Suitable for finish turning in aluminum and other non-ferrous materials and also steels, stainless steel, and high-temp alloys with reliability in continuous cuts with suitable edge preparation.	P									
		M									
		K									
		N									
		S									

Cutting Speed Recommendation • N • Metric

Low-Silicon Aluminum Alloys
(hypoeutectic <12.2% Si) and Magnesium Alloys

material group	grade	Speed – m/min										Starting Conditions
		250	500	750	1000	1250	1500	1750	2000	2250	2500	m/min
N1	WU10HT	◇										488

Low-Silicon Aluminum Alloys
(hypoeutectic <12.2% Si) and Magnesium Alloys

material group	grade	Speed – m/min										Starting Conditions
		250	500	750	1000	1250	1500	1750	2000	2250	2500	m/min
N2	WU10HT	◇										488

High-Silicon Aluminum Alloys
(hypereutectic >12.2% Si) and Magnesium Alloys

material group	grade	Speed – m/min										Starting Conditions
		250	500	750	1000	1250	1500	1750	2000	2250	2500	m/min
N3	WU10HT	◇										488
	WU05PT	◇										550

Copper-, Brass-, Zinc-Based on a Machinability
Index Range of 70–100

material group	grade	Speed – m/min				Starting Conditions
		250	500	750	1000	m/min
N4	WU10HT	◇				259
	WU05PT	◇				275

Nylon, Plastics, Rubbers, Phenolics, Resins,
Fiberglass, and Glass

material group	grade	Speed – m/min				Starting Conditions
		250	500	750	1000	m/min
N5	WU10HT	◇				170
	WU05PT	◇				170

Carbon and Graphite Composites:
Brush Alloys, Kevlar, and Graphite (280–400 HB) (30–43 HRC)

material group	grade	Speed – m/min				Starting Conditions
		250	500	750	1000	m/min
N6	WU05PT	◇				200

MMCs (Aluminum-Based Metal Matrix Composites)

material group	grade	Speed – m/min				Starting Conditions
		250	500	750	1000	m/min
N7	WU10HT	◇				180

Tin Alloys, Cast: ASTM 823, Alloys 1, 2, 3, 11

material group	grade	Speed – m/min				Starting Conditions
		250	500	750	1000	m/min
N8	WU05PT	◇				215

CCGT-AL • Inserts for Aluminum

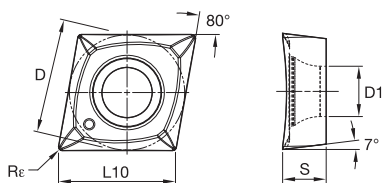

- first choice
- alternate choice

P	<input type="checkbox"/>	<input type="checkbox"/>	<input type="checkbox"/>
M	<input type="checkbox"/>	<input type="checkbox"/>	<input type="checkbox"/>
K	<input type="checkbox"/>	<input type="checkbox"/>	<input type="checkbox"/>
N	<input checked="" type="checkbox"/>	<input checked="" type="checkbox"/>	<input type="checkbox"/>
S	<input type="checkbox"/>	<input type="checkbox"/>	<input type="checkbox"/>
H	<input type="checkbox"/>	<input type="checkbox"/>	<input type="checkbox"/>

ISO catalogue number	D	L10	S	Rε	D1	WU10HT	WU05PT
CCGT060202AL	6,35	6,45	2,38	0,2	2,80	6846528	-
CCGT060204AL	6,35	6,47	2,38	0,4	2,79	6846529	6968709
CCGT060208AL	6,35	6,45	2,38	0,8	2,80	6846530	6968710
CCGT09T302AL	9,53	9,67	3,97	0,2	4,40	6846581	-
CCGT09T304AL	9,53	9,67	3,97	0,4	4,40	6846582	6968751
CCGT09T308AL	9,53	9,67	3,97	0,8	4,40	6846583	6968752
CCGT120402AL	12,70	12,90	4,76	0,2	5,50	6846584	-
CCGT120404AL	12,70	12,90	4,76	0,4	5,50	6846585	6968753
CCGT120408AL	12,70	12,90	4,76	0,8	5,50	6846586	6968754

DCGT-AL • Inserts for Aluminum

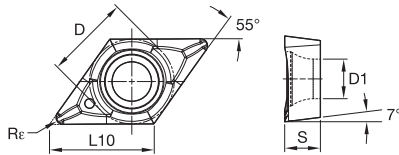

- first choice
- alternate choice

P	■	■	○
M	■	■	○
K	■	■	○
N	■	●	○
S	■	○	○
H	■	■	○

ISO catalogue number	D	L10	S	Rε	D1	WU10HT	WU05PT
DCGT070202AL	6,35	7,75	2,38	0,2	2,90	6846587	6846587
DCGT070204AL	6,35	7,75	2,38	0,4	2,90	6846588	6846588
DCGT11T302AL	9,53	11,63	3,97	0,2	4,40	6846589	6846589
DCGT11T304AL	9,53	11,59	3,97	0,4	4,40	6846590	6846590
DCGT11T308AL	9,53	11,63	3,97	0,8	4,40	6846591	6846591

RCGT-AL • Inserts for Aluminum

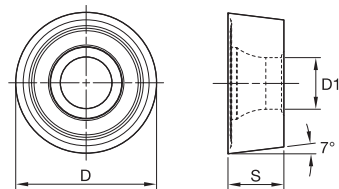

- first choice
- alternate choice

P	■	■	○
M	■	■	○
K	■	■	○
N	■	●	○
S	■	○	○
H	■	■	○

ISO catalogue number	D	S	D1	WU10HT	WU05PT
RCGT0803M0AL	8,00	3,18	3,40	6846592	6846592
RCGT1204M0AL	12,00	4,76	4,40	6846592	6846592

INDEXABLE MILLING

SOLID END MILLING

HOLEMAKING

TAPPING

TURNING

TCGT-AL • Inserts for Aluminum

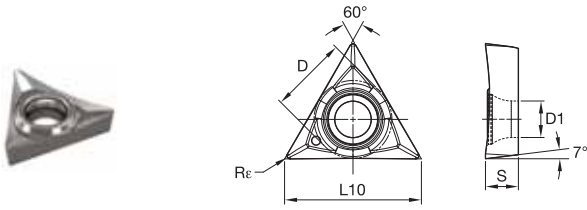

- first choice
- alternate choice

P	<input checked="" type="checkbox"/>	<input type="checkbox"/>	<input type="checkbox"/>
M	<input checked="" type="checkbox"/>	<input type="checkbox"/>	<input type="checkbox"/>
K	<input checked="" type="checkbox"/>	<input type="checkbox"/>	<input type="checkbox"/>
N	<input checked="" type="checkbox"/>	<input checked="" type="checkbox"/>	<input checked="" type="checkbox"/>
S	<input checked="" type="checkbox"/>	<input type="checkbox"/>	<input type="checkbox"/>
H	<input type="checkbox"/>	<input type="checkbox"/>	<input type="checkbox"/>

ISO catalogue number	D	L10	S	Rε	D1	WU10HT	WU05PT
TCGT110204AL	6,35	11,00	2,38	0,4	2,80	6846593	6968759
TCGT16T304AL	9,53	16,51	3,97	0,4	4,40	6846594	6968760
TCGT16T308AL	9,53	16,50	3,97	0,8	4,40	6846595	6968761

VCGT-AL • Inserts for Aluminum

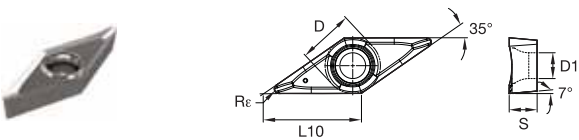

- first choice
- alternate choice

P	<input checked="" type="checkbox"/>	<input type="checkbox"/>	<input type="checkbox"/>
M	<input checked="" type="checkbox"/>	<input type="checkbox"/>	<input type="checkbox"/>
K	<input checked="" type="checkbox"/>	<input type="checkbox"/>	<input type="checkbox"/>
N	<input checked="" type="checkbox"/>	<input checked="" type="checkbox"/>	<input checked="" type="checkbox"/>
S	<input checked="" type="checkbox"/>	<input type="checkbox"/>	<input type="checkbox"/>
H	<input type="checkbox"/>	<input type="checkbox"/>	<input type="checkbox"/>

ISO catalogue number	D	L10	S	Rε	D1	WU10HT	WU05PT
VCGT160404AL	9,53	16,61	4,76	0,4	4,40	6968762	
VCGT160408AL	9,53	16,61	4,76	0,8	4,40	6968763	

VBGT-AL • Inserts for Aluminum

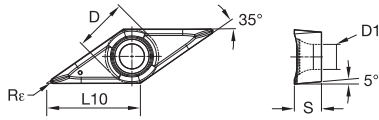

- first choice
- alternate choice

P	<input type="checkbox"/>	<input type="checkbox"/>	<input type="checkbox"/>
M	<input type="checkbox"/>	<input type="checkbox"/>	<input type="checkbox"/>
K	<input type="checkbox"/>	<input type="checkbox"/>	<input type="checkbox"/>
N	<input checked="" type="checkbox"/>	<input checked="" type="checkbox"/>	<input type="checkbox"/>
S	<input type="checkbox"/>	<input type="checkbox"/>	<input type="checkbox"/>
H	<input type="checkbox"/>	<input type="checkbox"/>	<input type="checkbox"/>

ISO catalogue number	D	L10	S	Rε	D1		
						WU10HT	WU05PT
VBGT160404AL	9,53	16,61	4,76	0,4	4,40	6846596	I
VBGT160408AL	9,53	16,46	4,76	0,8	4,40	6846597	I

INDEXABLE MILLING

SOLID END MILLING

HOLEMAKING

TAPPING

TURNING

Advanced Material Inserts

Ceramic, PcBN, PCD Inserts

Hard part turning, along with the machining of cast irons, high-temp alloys, and non-ferrous materials, can be accomplished through the use of inserts made from advanced materials. These advanced materials include ceramics, PcBN (polycrystalline cubic boron nitride), and PCD (polycrystalline diamond).

ADVANCED MATERIAL INSERT COMPOSITION

CERAMIC INSERTS

- Silicon-nitride based ceramic for cast iron machining.
- Mixed ceramic for hard machining and finishing of cast iron.
- Whisker ceramic for high-temp alloy and hard part turning.

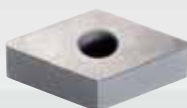

PcBN SOLID INSERTS

- Inserts are made only from PcBN.
- No material joint.
- Best heat-absorption capacity.
- Can work at highest temperatures.
- Inserts suitable for hard part turning with interruptions.



PcBN TIPPED INSERTS

- Require a carrier and a PcBN tip.
- The tips are brazed to a carrier.
- The substrate has to have a pocket that will accommodate and support the tip.
- Inserts are available in Multi Tip.
- Inserts suitable for hard part turning in continuous and interrupted applications.



PCD INSERTS

- Targeted machining of non-ferrous materials.
- Significant advantage in hardness over carbide tools.
- Increased productivity through higher speeds and longer tool life.
- Best used in processing materials that are unmachinable with conventional tooling.



ADVANCED MATERIAL INSERTS

MATERIALS



CERAMIC

- Ceramics offer greater wear resistance and toughness.
- Ceramics can be used in high-speed, continuous, and lightly interrupted turning applications in cast iron materials.
- Ceramics can be used for high-speed applications in high-temp alloys.
- Ceramics can also be used for hard part turning.

MATERIALS



PCBN

- PVD-coated grades available.
- Complete range of CBN grades for continuous to heavily interrupted turning.
- Industry-leading grades for gray cast iron machining.
- Full line of grades for hard part turning.
- For best performance: solid, full-top, and tipped inserts are available.

MATERIALS



PCD

- Two PCD grades — WDN25U and WDN00U — cover a wide range of applications.
- New grades provide outstanding performance to increase productivity and cut manufacturing costs.
- High abrasion and chipping resistance.
- Used in machining aluminum alloys with low- and high-silicon content, copper alloys, ceramics, and plastics.
- Suitable for machining highly abrasive materials such as titanium and Metal Matrix Composites (MMC).

INDUSTRY

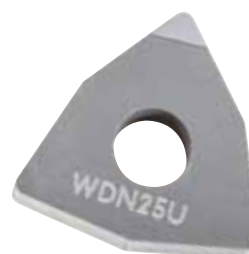

Catalog Numbering System

Each character in our catalog number signifies a specific trait of that product. Use the following key columns and corresponding images to easily identify which attributes apply.

C		C		G		W		2																																																																																																																																																																																																		
Insert Shape		Insert Clearance Angle		Tolerance Class		Insert Features		Size																																																																																																																																																																																																		
H	Hexagon 120°		A	3°	<p>Tolerances apply prior to edge prep and coating</p> <p>D = Theoretical diameter of the insert inscribed circle S = Thickness B = See figures below</p>	N		<p>Code for metric cutting edge length "L10"</p> <table border="1"> <thead> <tr> <th>"D"</th> <th>C</th> <th>D</th> <th>R</th> <th>S</th> <th>T</th> <th>V</th> <th>W</th> </tr> </thead> <tbody> <tr><td>3,97</td><td>S4</td><td>04</td><td>03</td><td>03</td><td>06</td><td>—</td><td>—</td></tr> <tr><td>4,76</td><td>04</td><td>05</td><td>04</td><td>04</td><td>08</td><td>08</td><td>S3</td></tr> <tr><td>5,56</td><td>05</td><td>06</td><td>05</td><td>05</td><td>09</td><td>09</td><td>03</td></tr> <tr><td>6,00</td><td>—</td><td>—</td><td>06</td><td>—</td><td>—</td><td>—</td><td>—</td></tr> <tr><td>6,35</td><td>06</td><td>07</td><td>06</td><td>06</td><td>11</td><td>11</td><td>04</td></tr> <tr><td>7,94</td><td>08</td><td>09</td><td>07</td><td>07</td><td>13</td><td>13</td><td>05</td></tr> <tr><td>8,00</td><td>—</td><td>—</td><td>08</td><td>—</td><td>—</td><td>—</td><td>—</td></tr> <tr><td>9,52</td><td>09</td><td>11</td><td>09</td><td>09</td><td>16</td><td>16</td><td>06</td></tr> <tr><td>10,00</td><td>—</td><td>—</td><td>10</td><td>—</td><td>—</td><td>—</td><td>—</td></tr> <tr><td>11,11</td><td>11</td><td>13</td><td>11</td><td>11</td><td>19</td><td>19</td><td>07</td></tr> <tr><td>12,00</td><td>—</td><td>—</td><td>12</td><td>—</td><td>—</td><td>—</td><td>—</td></tr> <tr><td>12,70</td><td>12</td><td>15</td><td>12</td><td>12</td><td>22</td><td>22</td><td>08</td></tr> <tr><td>14,29</td><td>14</td><td>17</td><td>14</td><td>14</td><td>24</td><td>24</td><td>09</td></tr> <tr><td>15,88</td><td>16</td><td>19</td><td>15</td><td>15</td><td>27</td><td>27</td><td>10</td></tr> <tr><td>16,00</td><td>—</td><td>—</td><td>16</td><td>—</td><td>—</td><td>—</td><td>—</td></tr> <tr><td>17,46</td><td>17</td><td>21</td><td>17</td><td>17</td><td>30</td><td>30</td><td>11</td></tr> <tr><td>19,05</td><td>19</td><td>23</td><td>19</td><td>19</td><td>33</td><td>33</td><td>13</td></tr> <tr><td>20,00</td><td>—</td><td>—</td><td>20</td><td>—</td><td>—</td><td>—</td><td>—</td></tr> <tr><td>22,22</td><td>22</td><td>27</td><td>22</td><td>22</td><td>38</td><td>38</td><td>15</td></tr> <tr><td>25,00</td><td>—</td><td>—</td><td>25</td><td>—</td><td>—</td><td>—</td><td>—</td></tr> <tr><td>25,40</td><td>25</td><td>31</td><td>25</td><td>25</td><td>44</td><td>44</td><td>17</td></tr> <tr><td>31,75</td><td>32</td><td>38</td><td>31</td><td>31</td><td>54</td><td>54</td><td>21</td></tr> <tr><td>32,00</td><td>—</td><td>—</td><td>32</td><td>—</td><td>—</td><td>—</td><td>—</td></tr> </tbody> </table>	"D"	C	D	R	S	T	V	W	3,97	S4	04	03	03	06	—	—	4,76	04	05	04	04	08	08	S3	5,56	05	06	05	05	09	09	03	6,00	—	—	06	—	—	—	—	6,35	06	07	06	06	11	11	04	7,94	08	09	07	07	13	13	05	8,00	—	—	08	—	—	—	—	9,52	09	11	09	09	16	16	06	10,00	—	—	10	—	—	—	—	11,11	11	13	11	11	19	19	07	12,00	—	—	12	—	—	—	—	12,70	12	15	12	12	22	22	08	14,29	14	17	14	14	24	24	09	15,88	16	19	15	15	27	27	10	16,00	—	—	16	—	—	—	—	17,46	17	21	17	17	30	30	11	19,05	19	23	19	19	33	33	13	20,00	—	—	20	—	—	—	—	22,22	22	27	22	22	38	38	15	25,00	—	—	25	—	—	—	—	25,40	25	31	25	25	44	44	17	31,75	32	38	31	31	54	54	21	32,00	—	—	32	—	—	—	—	R	
"D"	C	D	R	S		T	V		W																																																																																																																																																																																																	
3,97	S4	04	03	03		06	—		—																																																																																																																																																																																																	
4,76	04	05	04	04		08	08		S3																																																																																																																																																																																																	
5,56	05	06	05	05		09	09		03																																																																																																																																																																																																	
6,00	—	—	06	—		—	—		—																																																																																																																																																																																																	
6,35	06	07	06	06		11	11		04																																																																																																																																																																																																	
7,94	08	09	07	07		13	13		05																																																																																																																																																																																																	
8,00	—	—	08	—		—	—		—																																																																																																																																																																																																	
9,52	09	11	09	09		16	16		06																																																																																																																																																																																																	
10,00	—	—	10	—	—	—	—																																																																																																																																																																																																			
11,11	11	13	11	11	19	19	07																																																																																																																																																																																																			
12,00	—	—	12	—	—	—	—																																																																																																																																																																																																			
12,70	12	15	12	12	22	22	08																																																																																																																																																																																																			
14,29	14	17	14	14	24	24	09																																																																																																																																																																																																			
15,88	16	19	15	15	27	27	10																																																																																																																																																																																																			
16,00	—	—	16	—	—	—	—																																																																																																																																																																																																			
17,46	17	21	17	17	30	30	11																																																																																																																																																																																																			
19,05	19	23	19	19	33	33	13																																																																																																																																																																																																			
20,00	—	—	20	—	—	—	—																																																																																																																																																																																																			
22,22	22	27	22	22	38	38	15																																																																																																																																																																																																			
25,00	—	—	25	—	—	—	—																																																																																																																																																																																																			
25,40	25	31	25	25	44	44	17																																																																																																																																																																																																			
31,75	32	38	31	31	54	54	21																																																																																																																																																																																																			
32,00	—	—	32	—	—	—	—																																																																																																																																																																																																			
O	Octagon 135°		B	5°	F		A																																																																																																																																																																																																			
P	Pentagon 108°		C	7°	M		M																																																																																																																																																																																																			
R	Round —		D	15°	G		G																																																																																																																																																																																																			
S	Square 90°		E	20°	W		W																																																																																																																																																																																																			
T	Triangular 60°		F	25°	T		T																																																																																																																																																																																																			
C	Rhomboid 80°		G	30°	Q		Q																																																																																																																																																																																																			
D	80°		N	0°	U		U																																																																																																																																																																																																			
E	55°		H		B		B																																																																																																																																																																																																			
M	75°		W		H		H																																																																																																																																																																																																			
V	86° 35°		C		C		C																																																																																																																																																																																																			
W	Trigon 80° with enlarged corner angles		N	0°	J		J																																																																																																																																																																																																			
L	Rectangular 90°		P	11°	X	Special Design	V	Special Design																																																																																																																																																																																																		
A	Parallelogram 85°		O	For other clearance angles requiring descriptions.																																																																																																																																																																																																						
B	82°																																																																																																																																																																																																									
N/K	55°																																																																																																																																																																																																									

*Tolerances apply prior to edge prep and coating.

Catalog Numbering System

(continued)

INDEXABLE MILLING

SOLID END MILLING

HOLEMAKING

TAPPING

TURNING

15	05		E			C																																																																																										
Thickness "S"	Corner Radius "R _e "	Hand of Insert (optional)	Cutting Edge (optional)	T-Land Width (optional)	T-Land Angle (optional)	Tip Style (optional)	Chipbreaker (optional)																																																																																									
<table border="1"> <thead> <tr> <th>symbol</th> <th>thick- ness</th> </tr> <tr> <th>mm</th> <th>mm</th> </tr> </thead> <tbody> <tr><td>—</td><td>0,79</td></tr> <tr><td>T0</td><td>1,00</td></tr> <tr><td>01</td><td>11,59</td></tr> <tr><td>T1</td><td>1,98</td></tr> <tr><td>02</td><td>2,38</td></tr> <tr><td>03</td><td>3,18</td></tr> <tr><td>T3</td><td>3,97</td></tr> <tr><td>04</td><td>4,76</td></tr> <tr><td>05</td><td>5,56</td></tr> <tr><td>06</td><td>6,35</td></tr> <tr><td>07</td><td>7,94</td></tr> <tr><td>09</td><td>9,52</td></tr> <tr><td>11</td><td>11,11</td></tr> <tr><td>12</td><td>12,70</td></tr> </tbody> </table>	symbol	thick- ness	mm	mm	—	0,79	T0	1,00	01	11,59	T1	1,98	02	2,38	03	3,18	T3	3,97	04	4,76	05	5,56	06	6,35	07	7,94	09	9,52	11	11,11	12	12,70	<table border="1"> <thead> <tr> <th>symbol</th> <th>corner radius</th> </tr> <tr> <th>mm</th> <th>mm</th> </tr> </thead> <tbody> <tr><td>X0</td><td>.04</td></tr> <tr><td>01</td><td>0,1</td></tr> <tr><td>02</td><td>0,2</td></tr> <tr><td>04</td><td>0,4</td></tr> <tr><td>08</td><td>0,8</td></tr> <tr><td>12</td><td>1,2</td></tr> <tr><td>16</td><td>1,6</td></tr> <tr><td>20</td><td>2,0</td></tr> <tr><td>24</td><td>2,4</td></tr> <tr><td>28</td><td>2,8</td></tr> <tr><td>32</td><td>3,2</td></tr> <tr><td>00</td><td>round insert</td></tr> <tr><td>M0</td><td></td></tr> </tbody> </table>	symbol	corner radius	mm	mm	X0	.04	01	0,1	02	0,2	04	0,4	08	0,8	12	1,2	16	1,6	20	2,0	24	2,4	28	2,8	32	3,2	00	round insert	M0		<p>R = Right hand</p> <p>L = Left hand</p> <p>N = Neutral</p>	<p>F* Sharp</p> <p>E Rounded</p> <p>T* Chamfered</p> <p>S* Chamfered and Rounded</p> <p>K Double-Chamfered</p> <p>P Double-Chamfered and Rounded</p> <p><i>*Also available in wiper style.</i></p>	<table border="1"> <thead> <tr> <th>symbol</th> <th>mm size</th> </tr> </thead> <tbody> <tr><td>010</td><td>0,01</td></tr> <tr><td>020</td><td>0,02</td></tr> </tbody> </table>	symbol	mm size	010	0,01	020	0,02	<table border="1"> <thead> <tr> <th>symbol</th> <th>size</th> </tr> </thead> <tbody> <tr><td>10</td><td>10°</td></tr> <tr><td>15</td><td>15°</td></tr> <tr><td>20</td><td>20°</td></tr> <tr><td>25</td><td>25°</td></tr> <tr><td>30</td><td>30°</td></tr> </tbody> </table>	symbol	size	10	10°	15	15°	20	20°	25	25°	30	30°	<p>FW = Finishing Wiper</p> <p>MW = Medium Wiper</p> <table border="1"> <thead> <tr> <th>symbol</th> <th>usage</th> </tr> </thead> <tbody> <tr><td>C</td><td>full top</td></tr> <tr><td>M</td><td>mini tip</td></tr> <tr><td>MT</td><td>multi-tip</td></tr> <tr><td>ST</td><td>single tip</td></tr> </tbody> </table>	symbol	usage	C	full top	M	mini tip	MT	multi-tip	ST	single tip
symbol	thick- ness																																																																																															
mm	mm																																																																																															
—	0,79																																																																																															
T0	1,00																																																																																															
01	11,59																																																																																															
T1	1,98																																																																																															
02	2,38																																																																																															
03	3,18																																																																																															
T3	3,97																																																																																															
04	4,76																																																																																															
05	5,56																																																																																															
06	6,35																																																																																															
07	7,94																																																																																															
09	9,52																																																																																															
11	11,11																																																																																															
12	12,70																																																																																															
symbol	corner radius																																																																																															
mm	mm																																																																																															
X0	.04																																																																																															
01	0,1																																																																																															
02	0,2																																																																																															
04	0,4																																																																																															
08	0,8																																																																																															
12	1,2																																																																																															
16	1,6																																																																																															
20	2,0																																																																																															
24	2,4																																																																																															
28	2,8																																																																																															
32	3,2																																																																																															
00	round insert																																																																																															
M0																																																																																																
symbol	mm size																																																																																															
010	0,01																																																																																															
020	0,02																																																																																															
symbol	size																																																																																															
10	10°																																																																																															
15	15°																																																																																															
20	20°																																																																																															
25	25°																																																																																															
30	30°																																																																																															
symbol	usage																																																																																															
C	full top																																																																																															
M	mini tip																																																																																															
MT	multi-tip																																																																																															
ST	single tip																																																																																															

"D"	± Tolerance on "D"				"D"	± Tolerance on "B"			
	Class M Tolerance			Class U Tolerance		Class M Tolerance			Class U Tolerance
	Shapes S, T, C, R, & W	Shape D	Shape V	Shapes S, T, & C		Shapes S, T, C, R, & W	Shape D	Shape V	Shapes S, T, & C
mm	mm	mm	mm	mm	mm	mm	mm	mm	
3,97	0,05	—	—	—	3,97	0,08	—	—	—
4,76	0,05	—	—	0,08	4,76	0,08	—	—	0,13
5,56	0,05	0,05	0,05	0,08	5,56	0,08	0,11	—	0,13
6,35	0,05	0,05	0,05	0,08	6,35	0,08	0,11	—	0,13
7,94	0,05	0,05	0,05	0,08	7,94	0,08	0,11	—	0,13
9,52	0,05	0,05	0,05	0,08	9,52	0,08	0,11	0,18	0,13
11,11	0,08	0,08	0,08	0,13	11,11	0,13	0,15	—	—
12,70	0,08	0,08	0,08	0,13	12,70	0,13	0,15	0,25	0,20
14,29	0,08	0,08	0,08	0,13	14,29	0,13	0,15	—	—
15,88	0,10	0,10	0,10	0,18	15,88	0,15	0,18	—	0,27
17,46	0,10	0,10	0,10	0,18	17,46	0,15	0,18	—	0,27
19,05	0,10	0,10	0,10	0,18	19,05	0,15	0,18	—	0,27
22,22	0,13	—	—	0,25	22,22	0,15	—	—	0,38
25,40	0,13	—	—	0,25	25,40	0,18	—	—	0,38
31,75	0,15	—	—	0,25	31,75	0,20	—	—	0,38

WBH20P™ for Enhanced Performance — Five Unique Features

INDEXABLE MILLING

SOLID END MILLING

HOLEMAKING

TAPPING

TURNING

1 Newly developed substrate enables application in a wide variety of demanding situations.

The substrate contains super-hard grains with a uniquely formulated size distribution and nano-structured binder phase. This unique combination provides an unparalleled balance of wear resistance and toughness. The net result is a robust hard turning tooling solution for a wide range of applications, including continuous to interrupted cutting.



2 Nano-composite coating that enhances speed capabilities and tool life.

- Specially developed, advanced PVD coating with nano-composite architecture for improved performance.
- Improved wear resistance by PVD coating chemistry technology for machining hardened steels.
- Enhanced PVD coating adhesion on PcBN substrates.

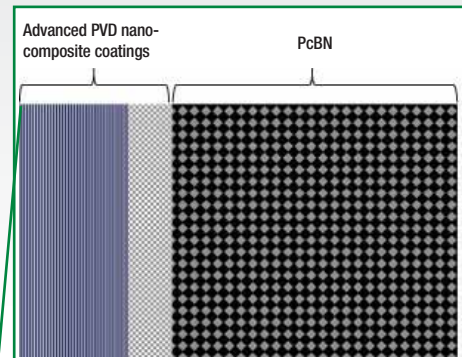

3 Improved edge preparation technology for longer tool life, reliable performance, better surface finish, and tighter workpiece tolerances.

A critical performance factor is the edge preparation itself. The grind direction, surface roughness, hone sizes, and tolerances have great impact on performance and process reliability. WIDIA™ has performed significant research work and optimized edge preparation to improve your overall machining effectiveness.

WBH20P™ for Enhanced Performance — Five Unique Features

(continued)

4 Large standard portfolio.

Standard edge preparation — the optimum combination of T-land angle, T-land width, and hone size — is paramount in achieving maximum performance. WIDIA™ has developed three standard edge configurations, including wiper inserts.

- Light machining edge prep E.
- Medium machining edge prep S01015.
- Heavy machining edge prep S01025.

- E: Honed cutting edge
- S01015: $W \times \beta = 0,10\text{mm} \times 15^\circ$
- S01025: $W \times \beta = 0,10\text{mm} \times 25^\circ$

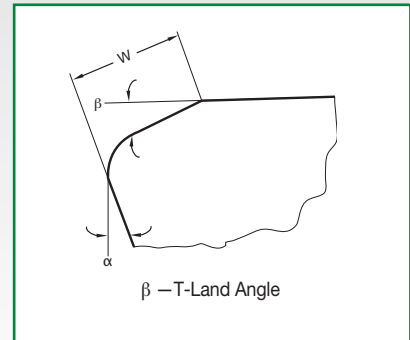

These edge preps are available in common styles, sizes, and nose radii in both positive and negative geometries.

5 CB1 chipbreaker in positive and negative geometries, solving chipbreaking and chip control issues.

Chipbreaker — when machining case-hardened steel with a hard outer skin and a tough and softer core, a chipbreaker provides a great advantage. The CB1 chipbreaker is a proven solution to effectively breaking chips. Long chips can form bird nests, causing machine malfunctions, increasing scrap-rates, and reducing the overall equipment effectiveness.

Available as a custom solution product.

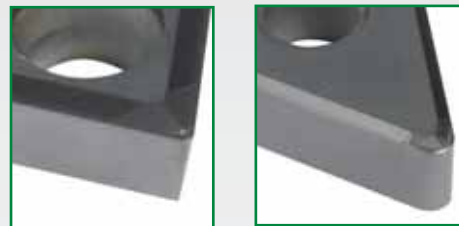

Insert without Chipbreaker



- Long chips.
- Bird-nest formation.

Insert with Chipbreaker



- Chips are broken.

Grade Numbering System — Ceramics

CW	2	0	15
Brand	Cutting Material Group		Application Range
<p>CW = WIDIA™</p>	<p>2 = CM Mixed (black) ceramic</p> <p>3 = CR Whisker reinforced ceramic</p> <p>5 = CN Silicon-nitride ceramic</p>	<p>0 = Stationary cutting edges (turning, parting, threading)</p> <p>1 = First successor</p> <p>2 = Semi-standard rotating cutting edges</p> <p>3 = Semi-standard general applications</p> <p>5 = Rotating cutting edges (milling, drilling, reaming)</p>	<p>05 = fine finishing</p> <p>10 = finishing</p> <p>15 = } medium to roughing</p> <p>20 = }</p> <p>25 = }</p> <p>30 = } roughing</p> <p>35 = }</p> <p>40 = }</p> <p>45 = } heaviest roughing</p> <p>50 = }</p>



Grade Numbering System — PcBN and PCD

W	B	H	30	P
Brand	Cutting Material Group	Material Range	Application Range	Coating
WIDIA™	<p>B = CBN</p> <p>D = PCD</p>	<p>H = hardened materials</p> <p>N = non-ferrous materials</p>	<p>05 = fine finishing</p> <p>10 = finishing</p> <p>15 = } medium to roughing</p> <p>20 = }</p> <p>25 = }</p> <p>30 = } roughing</p> <p>35 = }</p> <p>40 = }</p> <p>45 = } heaviest roughing</p> <p>50 = }</p>	<p>U = Uncoated</p> <p>C = CVD Coated</p> <p>P = PVD Coated</p>

P	Steel
M	Stainless Steel
K	Cast Iron
N	Non-Ferrous
S	High-Temp Alloys
H	Hardened Materials
U	Universal Machining

INDEXABLE MILLING

SOLID END MILLING

HOLEMAKING

TAPPING

TURNING



Cutting Material Groups

The cutting tool materials are classified by the combination of their hardness and wear-resistance characteristics.

The extended standard DIN ISO 513 also includes ceramic cutting materials and the super-hard polycrystalline materials, boron nitride and diamond, resulting in additional identification symbols for these cutting material groups.

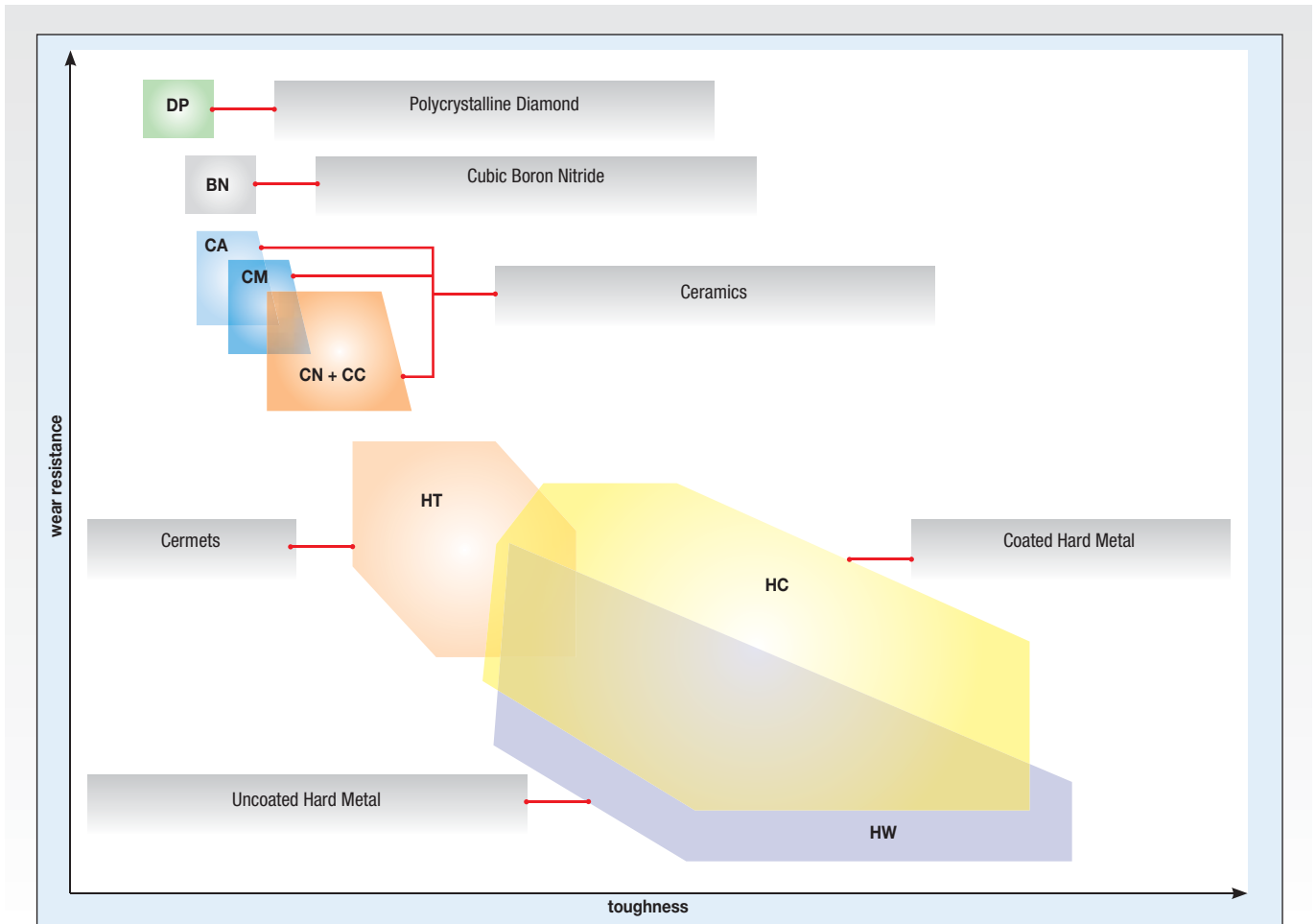

main group	sub-group (symbol)	feature
hard metal	HW	Uncoated WC-base hard metal
	HT	Uncoated TiC/TiN-base hard metal (cermets)
	HC	Coated hard metal
ceramics	CA	Al ₂ O ₃ -base oxide ceramics
	CM	Composite ceramics Al ₂ O ₃ + metal carbide
	CN	Si ₃ N ₄ -base nitride ceramics
	CC	Coated ceramics
cubic boron nitride	BL	Cubic boron nitride (CBN) with low CBN content
	BH	Cubic boron nitride (CBN) with high CBN content
diamond	DP	Polycrystalline diamond (PCD)

Ceramic Inserts for Hard Turning, Turning in Cast Iron Materials, and Turning in High-Temp Alloys



- Ceramics offer greater wear resistance and toughness.
- Ceramics can be used in high-speed, continuous, and lightly interrupted turning applications in cast iron materials.
- Ceramics can be used for high-speed applications in high-temp alloys.

Ceramic Turning Grades

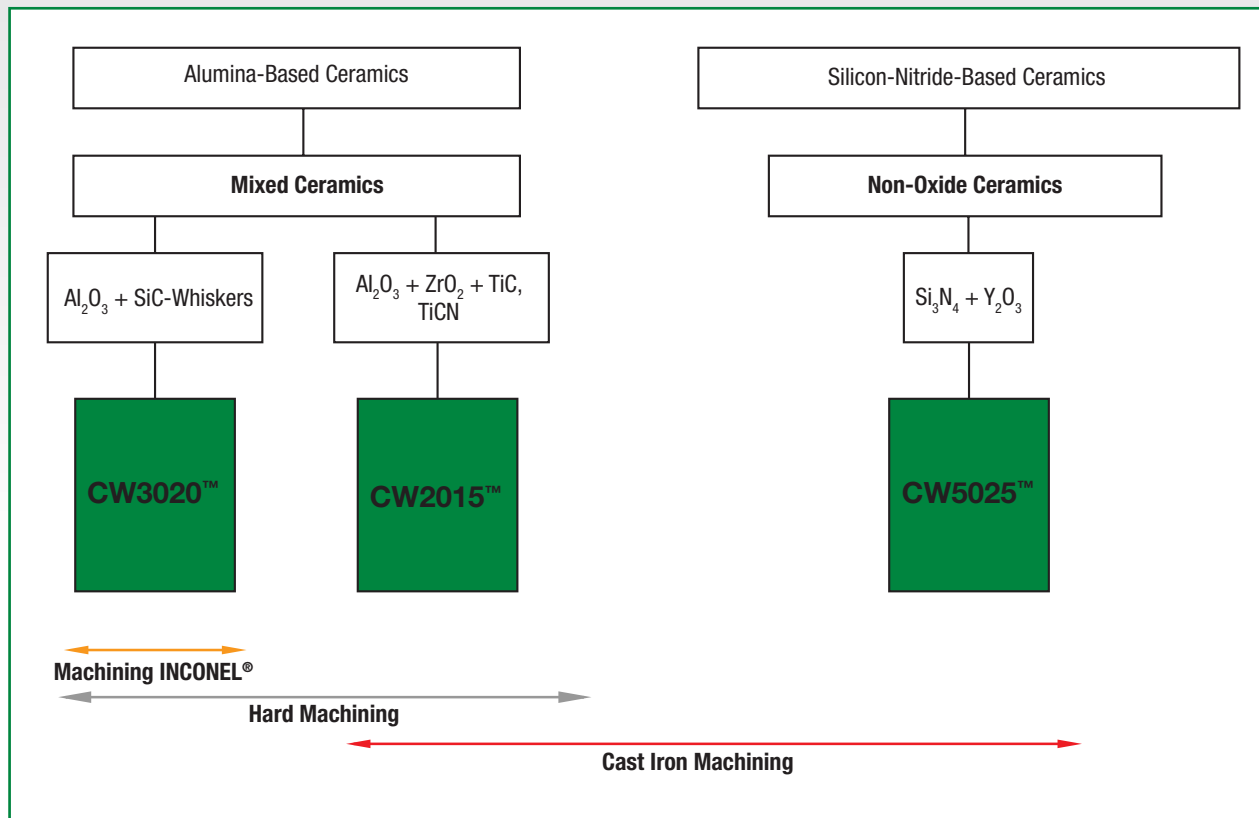

CW2015™

- Alumina and titanium carbo-nitride.
- High hardness and wear resistance.
- TiCN increases strength and hardness.
- Black in color.

CW3020™

- Alumina + SiC whisker.
- High hardness and wear resistance.
- Whisker ceramic with elongated crystals and very high strength.
- Gray-green color.

CW5025™

- Pure silicon-nitride composition.
- Used in high-speed turning applications.
- Designed for use in gray cast iron and lower-tensile ductile irons.

PcBN Grades for Hard Turning, Powder Metal, and Gray Cast Iron Machining

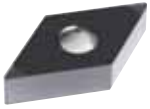

- PVD-coated grades available.
- Complete range of CBN grades for continuous to heavily interrupted turning.
- Industry-leading grades for gray cast iron machining.
- Full line of grades for hard turning.
- For best performance: solid, full-top, and tipped inserts are available.

Hard Turning Grades

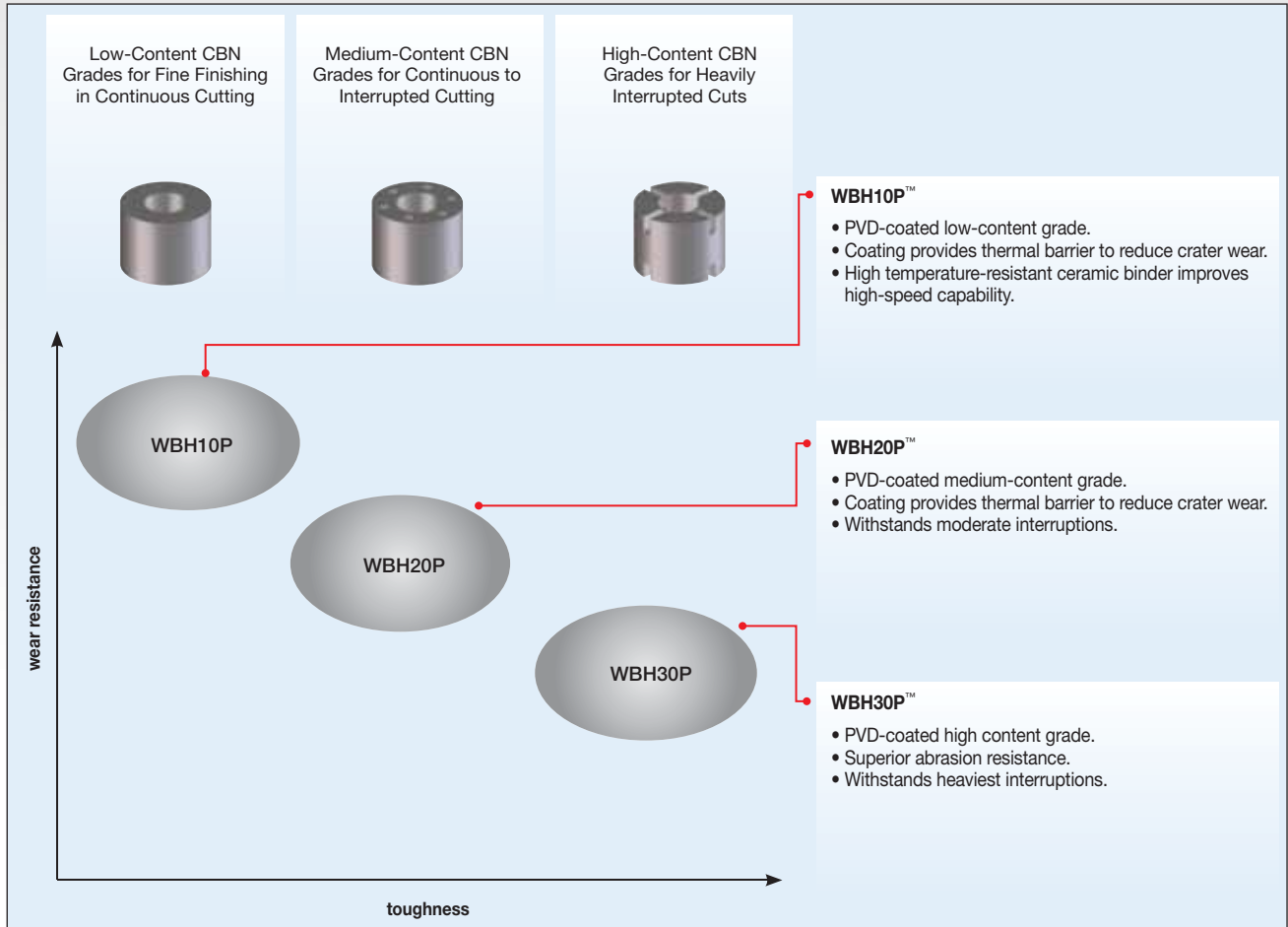

Gray Cast Iron Grade

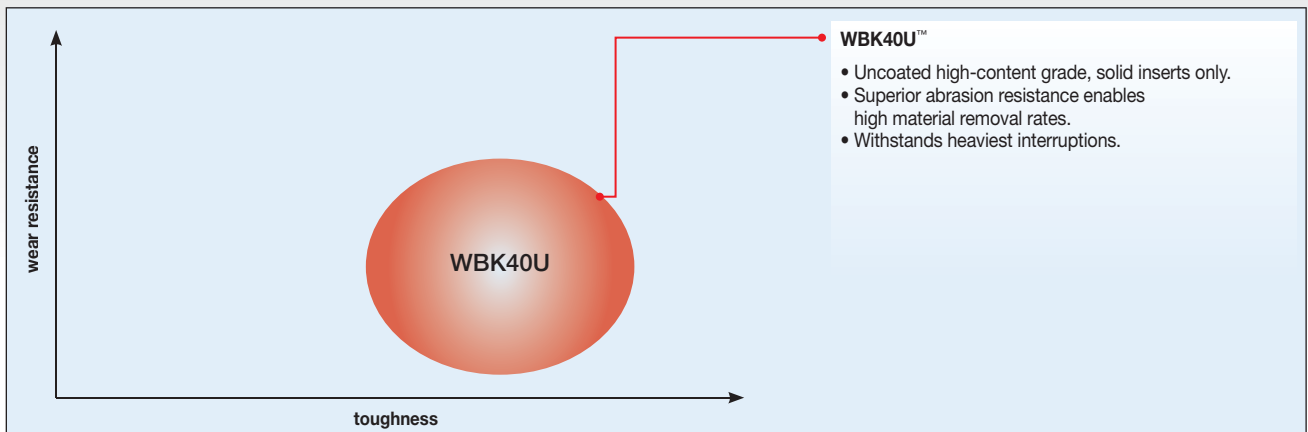

PCD Grades for Turning Non-Ferrous Materials

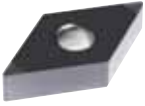

- Two PCD grades — WDN25U and WDN00U — cover a wide range of applications.
- Grades provide outstanding performance to increase productivity and cut manufacturing costs.
- High abrasion and chipping resistance.
- Used in machining aluminum alloys with low- and high-silicon content, copper alloys, ceramics, and plastics.
- Suitable for machining highly abrasive materials such as titanium and Metal Matrix Composites (MMC).

Non-Ferrous Grades

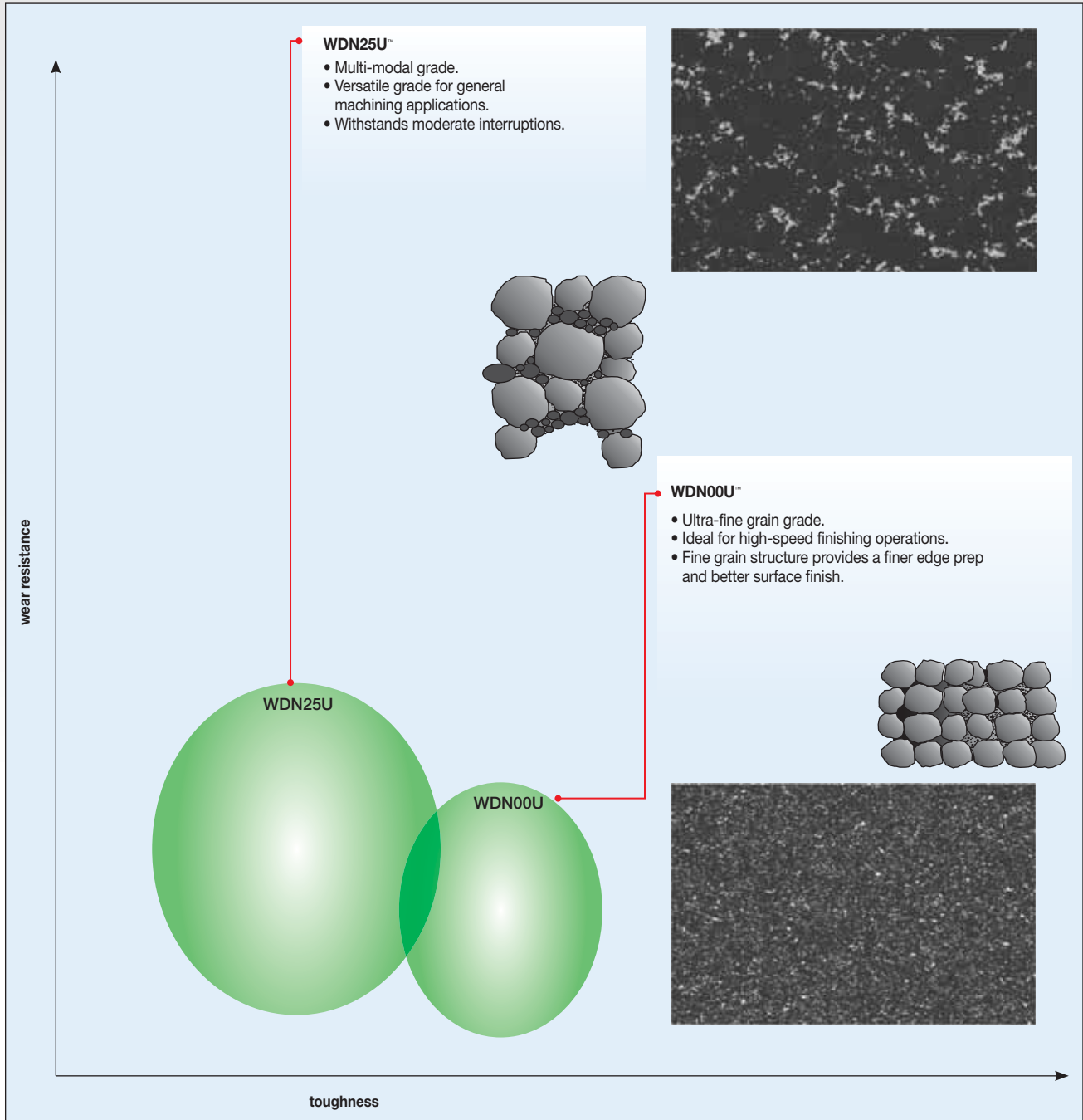

INDEXABLE MILLING

SOLID END MILLING

HOLEMAKING

TAPPING

TURNING

Advanced Materials for Hard Turning

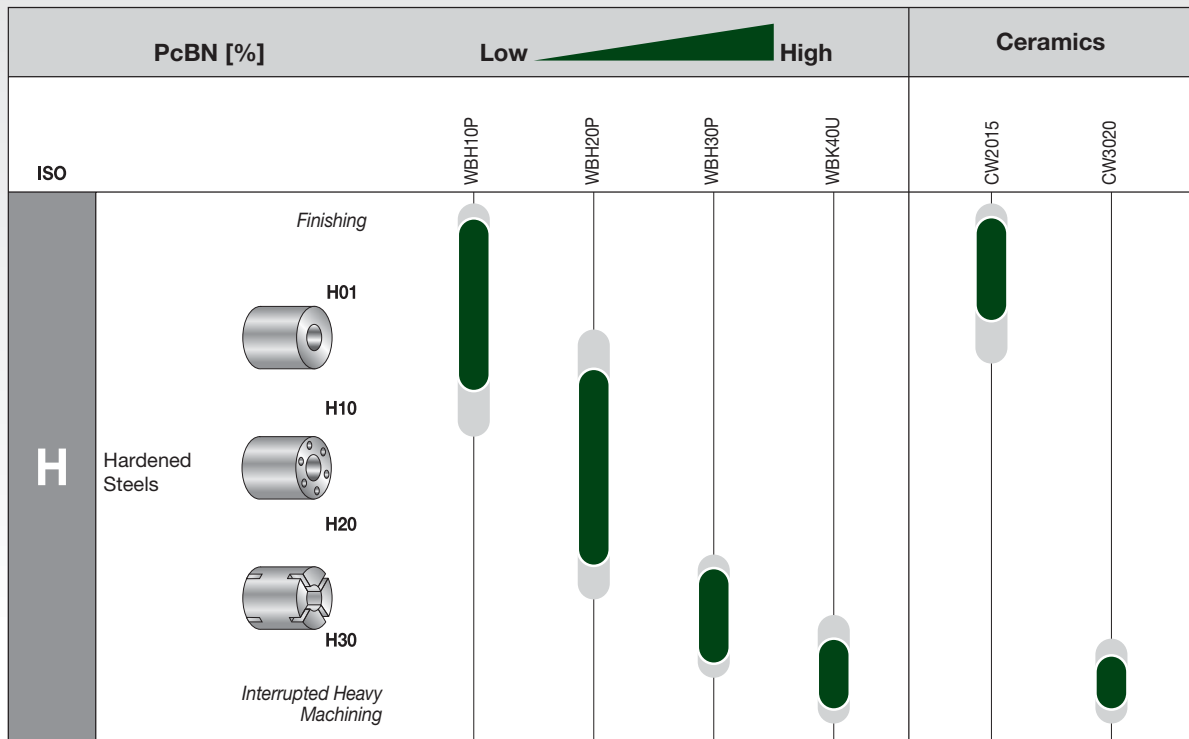

Hard Turning Grade Selection

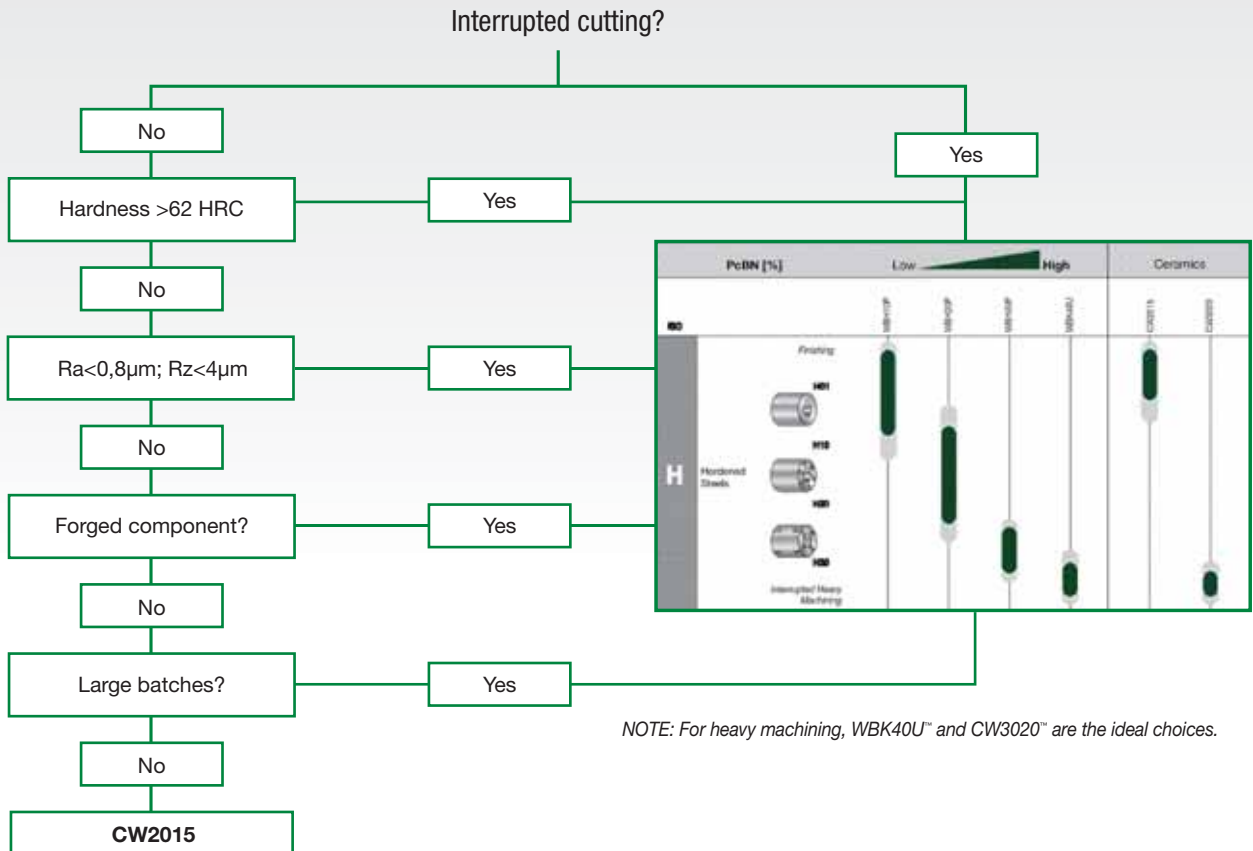

Advanced Materials for Cast Iron Machining

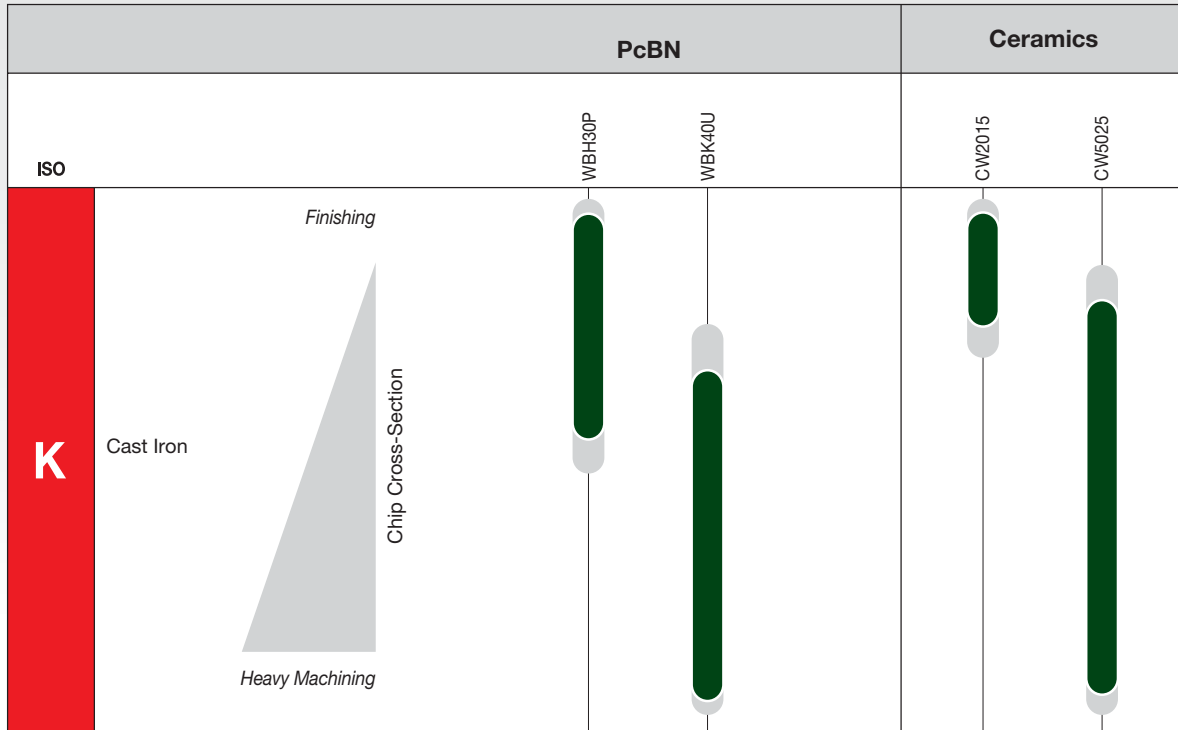

Cast Iron Machining Grade Selection

Constant and high-quality casting?

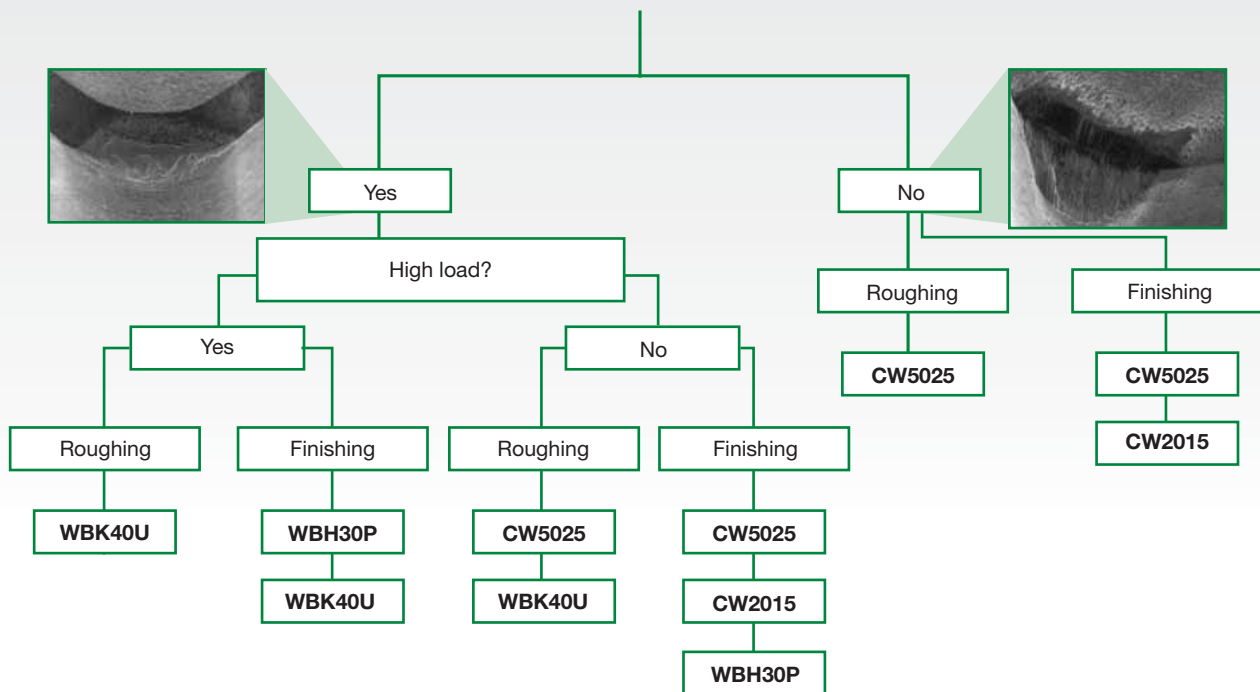

Advanced Materials for High-Temperature Machining

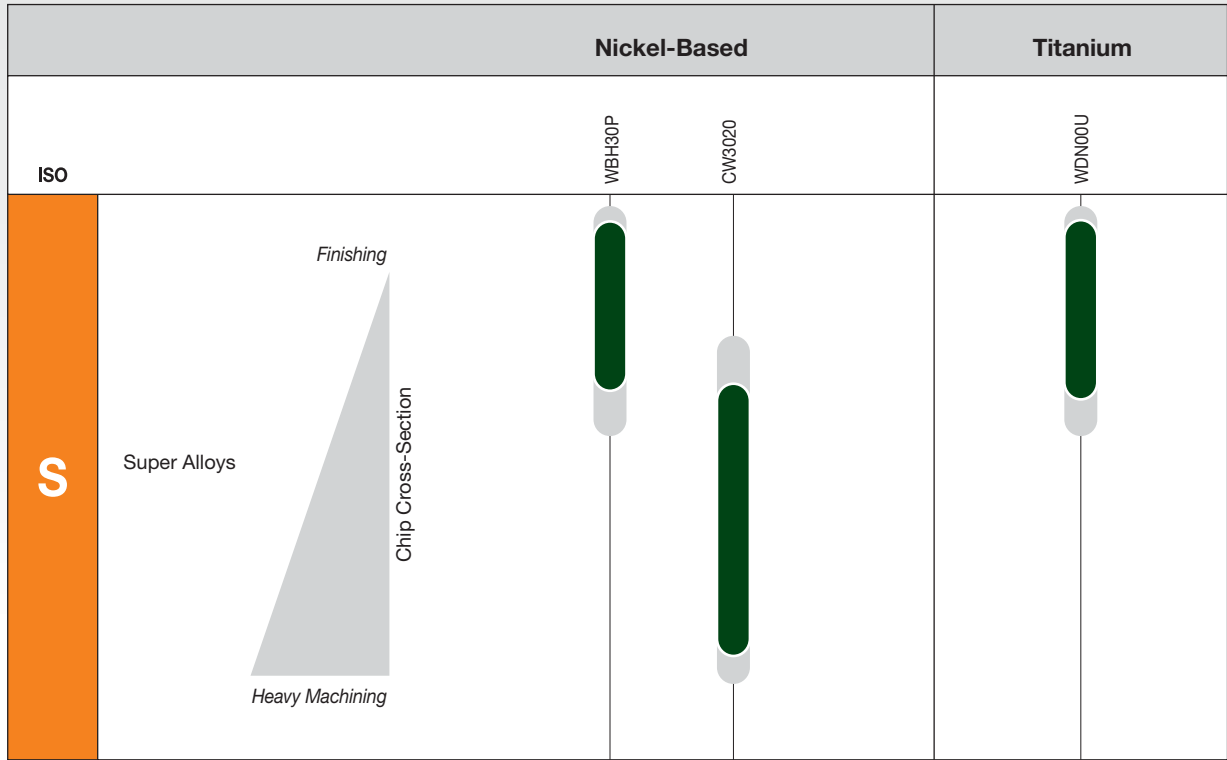

Advanced Materials for Non-Ferrous Machining

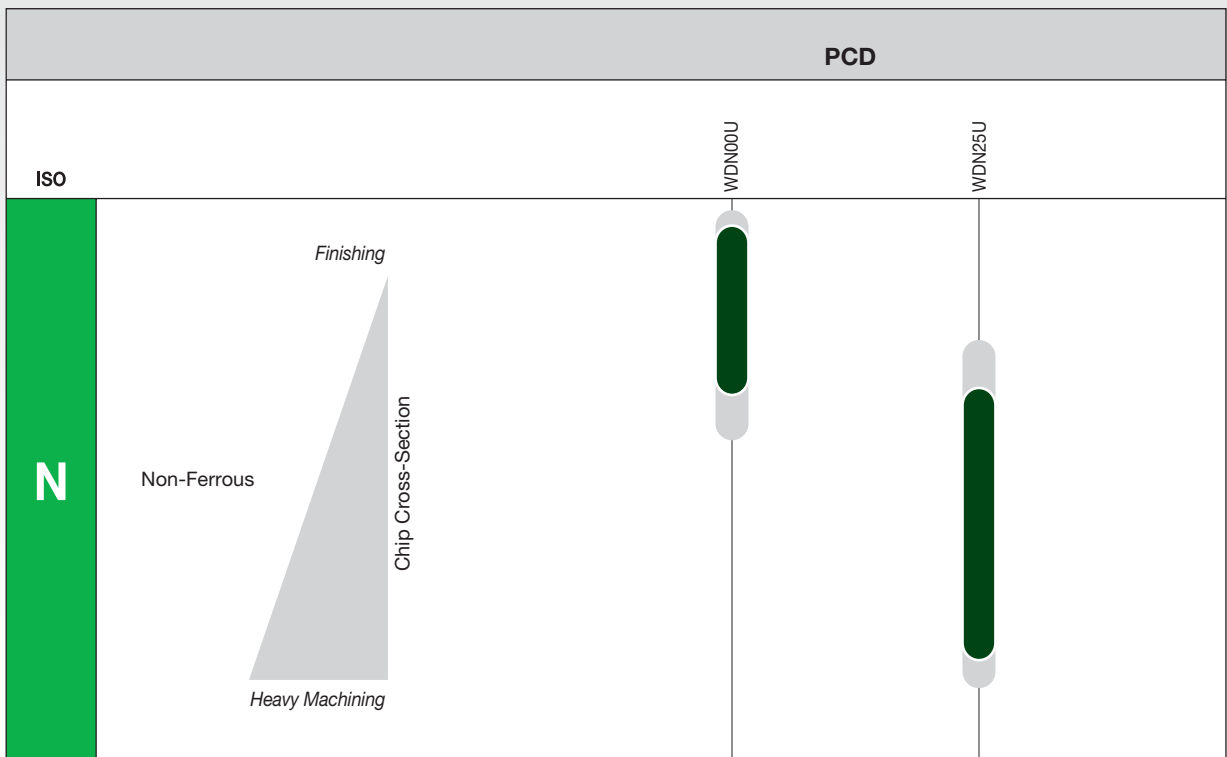

INDEXABLE MILLING

SOLID END MILLING

HOLEMAKING

TAPPING

TURNING

Grades and Grade Descriptions

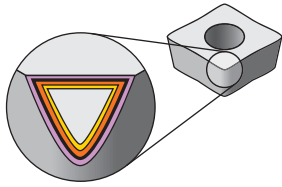

Reduce cycle times. High speed and feed capability. Long tool life. New multi-layer coating provides better wear resistance.

P	Steel
M	Stainless Steel
K	Cast Iron
N	Non-Ferrous
S	High-Temp Alloys
H	Hardened Materials

Grade	Coating	Grade Description	wear resistance ← → toughness																		
			05	10	15	20	25	30	35	40	45										
CW2015		Mixed (black) ceramic. Matrix Al ₂ O ₃ and TiCN. Good toughness properties combined with good wear resistance. Semi-finishing and finishing. For hardened iron base materials and gray cast iron (finishing).																			
	CM-H10																				
CW5025		Silicon-nitride ceramic. Extraordinary toughness properties. Roughing, also in heavily interrupted cuts. Capable of high-performance turning. To be used with or without coolant. For gray cast iron.																			
	CN-K15																				
CW3020		Whisker ceramic with a matrix of Al ₂ O ₃ + SiCw. The SiC whiskers embedded in the micro-structure give this ceramic excellent toughness for cutting high-temp alloys and cast materials with high Brinell hardness.																			
	C4																				
WBK40U		A high-content CBN, solid CBN insert with multiple cutting edges. Applied in roughing to finishing of fully pearlitic gray cast iron, chilled irons, high-chrome alloyed steels, sintered powdered metals, and heavy cuts in hardened steels (>45 HRC). Use for finishing chilled and fully pearlitic cast iron. Solid inserts offer better security and shock resistance than tipped inserts, while also enabling deeper depth-of-cut capability.																			
	BN-K40																				
WBH10P		A low-content CBN grade with a PVD-AlTiN coating for added wear resistance. Designed for precision machining of hardened steels (>45 HRC); the harder the steel the better. PVD coating offers improved wear resistance and excellent surface finish capability. Effectively applied on bearing steels, hot and cold work tool steels, high-speed steels, die steels, case-hardened steels, carburized and nitrided irons, and some hard coatings.																			
	BN-H10																				

INDEXABLE MILLING

SOLID END MILLING

HOLEMAKING

TAPPING

TURNING

Grades and Grade Descriptions

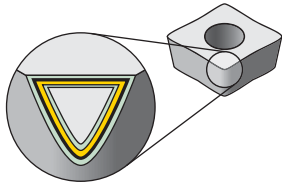

Reduce cycle times. High speed and feed capability. Long tool life. New multi-layer coating provides better wear resistance.

P	Steel
M	Stainless Steel
K	Cast Iron
N	Non-Ferrous
S	High-Temp Alloys
H	Hardened Materials

wear resistance ← → toughness

Grade	Coating	Grade Description	Wear Resistance / Toughness																		
			05	10	15	20	25	30	35	40	45										
WBH20P		A PVD-AlTiN coating over a low-content, CBN tip brazed onto a carbide insert. Designed for roughing to finishing of hardened steels (>45 HRC). Use on bearing steel, hot and cold work tool steels, high-speed steels, die steels, case-hardened steels, carburized and nitrided irons, and some hard coatings.																			
	BN-H25																				
WBH30P		A PVD-AlTiN coating over a low-content, CBN tip brazed onto a carbide insert. Designed for roughing to finishing in interrupted cuts on hardened steels (>45 HRC). Applied on gray cast iron, chilled irons, high-chrome alloyed steels, high-temp alloys, and sintered powdered metals.																			
	BN-H30																				
WDN00U		An ultra-fine grained polycrystalline diamond (PCD) tip brazed onto a carbide substrate. Designed for general-purpose turning of primarily non-ferrous materials. Applied over a wide range of continuous to interrupted cuts where superior surface finish is needed. Use on low to medium silicon content aluminum alloys, non-metallics, copper, brass, and zinc-based alloys. The ultra-fine grained diamond particle size enables superior surface finishes while ensuring the best mechanical shock resistance of any PCD cutting tool.																			
	DP-N10																				
WDN25U		A multi-modal PCD grade with a range of grain sizes brazed onto a carbide substrate. Engineered for extreme abrasion resistance and good edge strength for demanding applications. An ideal choice for high-silicon aluminum alloys, bi-metallic (AL/GI) materials, MMC, carbon-fiber reinforced plastics, and other abrasive non-metallic materials.																			
	DP-N25																				

*Grade available as custom solution only.

Speed and Feed Chart • Ceramics • Metric

Material Group		Cutting Speed – vc m/min								
		CW2015			CW3020			CW5025		
		min	Start	max	min	Start	max	min	Start	max
ap [mm]		0,5		4,0	0,5		4,0	1,0		8,0
f [mm/rev]		0,2		0,4	0,1		0,5	0,2		0,6
P	0	-	-	-	-	-	-	-	-	-
	1	-	-	-	-	-	-	-	-	-
	2	-	-	-	-	-	-	-	-	-
	3	-	-	-	-	-	-	-	-	-
	4	-	-	-	-	-	-	-	-	-
	5	-	-	-	-	-	-	-	-	-
M	1	-	-	-	-	-	-	-	-	-
	2	-	-	-	-	-	-	-	-	-
	3	-	-	-	-	-	-	-	-	-
K	1	250	475	725	-	-	-	250	760	1000
	2	300	550	800	-	-	-	275	365	490
	3	250	400	600	-	-	-	275	335	440
N	1	-	-	-	-	-	-	-	-	-
	2	-	-	-	-	-	-	-	-	-
	3	-	-	-	-	-	-	-	-	-
	4	-	-	-	-	-	-	-	-	-
	5	-	-	-	-	-	-	-	-	-
	6	-	-	-	-	-	-	-	-	-
	7	-	-	-	-	-	-	-	-	-
	8	-	-	-	-	-	-	-	-	-
S	1	-	-	-	170	200	375	-	-	-
	2	-	-	-	170	200	375	-	-	-
	3	-	-	-	190	250	375	-	-	-
	4	-	-	-	-	-	-	-	-	-
H	1	60	100	140	45	85	125	-	-	-
	2	60	100	140	45	85	125	-	-	-
	3	60	100	140	45	85	125	-	-	-
	4	60	100	140	45	85	125	-	-	-

INDEXABLE MILLING

SOLID END MILLING

HOLEMAKING

TAPPING

TURNING

Speed and Feed Chart • PcBN PCD • Metric

Material Group		Cutting Speed – vc m/min																	
		WBH10P			WBH20P			WBH30P			WBK40U			WDN00U			WDN25U		
		min	Start	max	min	Start	max	min	Start	max	min	Start	max	min	Start	max	min	Start	max
ap [mm]		0,10		0,50	0,10		0,50	0,08		0,40	0,10		1,50	0,20		2,00	0,20		2,00
f [mm/rev]		0,06		0,25	0,05		0,20	0,05		0,20	0,08		0,20	0,10		0,30	0,10		0,25
P	0/1	-	-	-	-	-	-	-	-	-	-	-	-	-	-	-	-	-	-
	2	-	-	-	-	-	-	-	-	-	-	-	-	-	-	-	-	-	-
	3	-	-	-	-	-	-	-	-	-	-	-	-	-	-	-	-	-	-
	4	-	-	-	-	-	-	-	-	-	-	-	-	-	-	-	-	-	-
	5	-	-	-	-	-	-	-	-	-	-	-	-	-	-	-	-	-	-
	6	-	-	-	-	-	-	-	-	-	-	-	-	-	-	-	-	-	-
M	1	-	-	-	-	-	-	-	-	-	-	-	-	-	-	-	-	-	-
	2	-	-	-	-	-	-	-	-	-	-	-	-	-	-	-	-	-	-
	3	-	-	-	-	-	-	-	-	-	-	-	-	-	-	-	-	-	-
K	1	-	-	-	-	-	-	400	600	800	650	800	1200	-	-	-	-	-	-
	2	-	-	-	-	-	-	-	-	-	-	-	-	-	-	-	-	-	-
	3	-	-	-	-	-	-	-	-	-	-	-	-	-	-	-	-	-	-
N	1	-	-	-	-	-	-	-	-	-	-	-	-	500	765	2500	500	765	2500
	2	-	-	-	-	-	-	-	-	-	-	-	-	-	-	-	350	580	1000
	3	-	-	-	-	-	-	-	-	-	-	-	-	250	520	1000	250	520	1000
	4	-	-	-	-	-	-	-	-	-	-	-	-	250	400	750	250	400	750
	5	-	-	-	-	-	-	-	-	-	-	-	-	550	760	1000	550	760	1000
	6	-	-	-	-	-	-	-	-	-	-	-	-	400	460	850	400	365	750
	7	-	-	-	-	-	-	-	-	-	-	-	-	-	-	-	-	-	-
S	1	-	-	-	-	-	-	120	160	200	-	-	-	-	-	-	-	-	-
	2	-	-	-	-	-	-	120	160	200	-	-	-	-	-	-	-	-	-
	3	-	-	-	-	-	-	120	160	200	-	-	-	-	-	-	-	-	-
	4	-	-	-	-	-	-	-	-	-	-	-	-	100	180	320	-	-	-
H	1	80	170	260	80	160	230	60	120	220	60	120	220	-	-	-	-	-	-
	2	80	170	260	80	160	230	60	120	220	60	120	220	-	-	-	-	-	-
	3	80	170	260	80	160	230	60	120	220	60	120	220	-	-	-	-	-	-
	4	80	170	260	80	160	230	60	120	220	60	120	220	-	-	-	-	-	-

Ceramic Inserts • CNGA

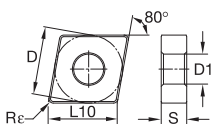
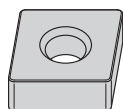

- first choice
- alternate choice

P	■	■	■	■
M	■	■	■	■
K	■	●	■	●
N	■	■	■	■
S	■	■	■	■
H	■	●	■	■
	■	■	■	■

ISO catalogue number	D	L10	S	Re	D1	CW2015	CW3020	CW5025
CNGA120404T02020	12,70	12,90	4,76	0,4	5,16	2952526	■	■
CNGA120408T02020	12,70	12,90	4,76	0,8	5,16	2952527	■	2952159
CNGA120412T02020	12,70	12,90	4,76	1,2	5,16	2952528	■	2952161
CNGA120416T02020	12,70	12,90	4,76	1,6	5,16	■	■	2952173
CNGA160612T02020	15,88	16,12	6,35	1,2	6,35	2952529	■	■
CNGA160616T02020	15,88	16,12	6,35	1,6	6,35	■	■	2952175

Ceramic Inserts • CNGA-FW

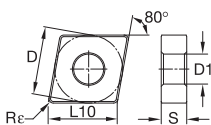
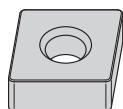

- first choice
- alternate choice

P	■	■	■	■
M	■	■	■	■
K	■	●	■	●
N	■	■	■	■
S	■	■	■	■
H	■	●	■	■
	■	■	■	■

ISO catalogue number	D	L10	S	Re	D1	CW2015	CW3020	CW5025
CNGA120412T01020FW	12,70	12,90	4,76	1,2	5,16	■	■	2952160

Ceramic Inserts • CNGN/CNG

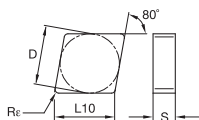
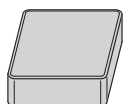

- first choice
- alternate choice

P	■	■	■	■
M	■	■	■	■
K	■	●	■	●
N	■	■	■	■
S	■	■	●	■
H	■	●	■	■

ISO catalogue number	D	L10	S	Rε	CW2015	CW3020	CW5025
CNGN120404T02020	12,70	12,90	4,76	0,4	2952551	■	■
CNGN120408T01020	12,70	12,90	4,76	0,8	■	3869578	■
CNGN120408T02020	12,70	12,90	4,76	0,8	2952552	■	■
CNGN120412T01020	12,70	12,90	4,76	1,2	■	3869579	■
CNGN120412T02020	12,70	12,90	4,76	1,2	2952603	■	■
CNGN120712T01020	12,70	12,90	7,94	1,2	■	3869581	■
CNGN120712T02020	12,70	12,90	7,94	1,2	2952605	■	2952115

Ceramic Inserts • CNGX

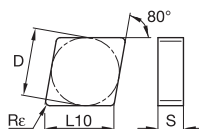
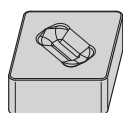

- first choice
- alternate choice

P	■	■	■	■
M	■	■	■	■
K	■	●	■	●
N	■	■	■	■
S	■	■	●	■
H	■	●	■	■

ISO catalogue number	D	L10	S	Rε	CW2015	CW3020	CW5025
CNGX120712T02020	12,70	12,90	7,94	1,2	■	■	2952119

Ceramic Inserts • CNMX

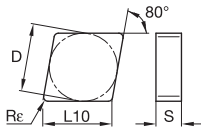
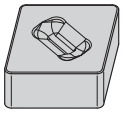

- first choice
- alternate choice

P	■	■	■	■
M	■	■	■	■
K	■	●	■	●
N	■	■	■	■
S	■	■	●	■
H	■	●	■	■

ISO catalogue number	D	L10	S	R _ε	CW2015	CW3020	CW5025
CNMX120712T02020	12,70	12,90	7,94	1,2	■	■	2952122
CNMX120716T02020	12,70	12,90	7,94	1,6	■	■	2952123

Ceramic Inserts • DNGA

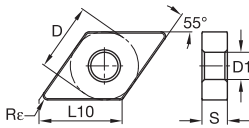
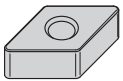

- first choice
- alternate choice

P	■	■	■	■
M	■	■	■	■
K	■	●	■	●
N	■	■	■	■
S	■	■	●	■
H	■	●	■	■

ISO catalogue number	D	L10	S	R _ε	D1	CW2015	CW3020	CW5025
DNGA150404T02020	12,70	15,50	4,76	0,4	5,16	2952532	■	■
DNGA150408T02020	12,70	15,50	4,76	0,8	5,16	2952533	■	■
DNGA150412T02020	12,70	15,50	4,76	1,2	5,16	2952534	■	■
DNGA150604T02020	12,70	15,50	6,35	0,4	5,16	2952535	■	■
DNGA150608T02020	12,70	15,50	6,35	0,8	5,16	2952536	■	■
DNGA150612T02020	12,70	15,50	6,35	1,2	5,16	2952537	■	2952185

INDEXABLE MILLING

Ceramic Inserts • DNGX

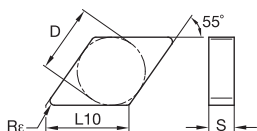
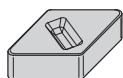

- first choice
- alternate choice

P	■	■	■	■
M	■	■	■	■
K	■	●	■	●
N	■	■	■	■
S	■	■	●	■
H	■	●	■	■

ISO catalogue number	D	L10	S	Rε	CW2015	CW3020	CW5025
DNGX120712T02020	10,00	12,21	7,94	1,2	■	■	2952124
DNGX150712T02020	12,70	15,50	7,94	1,2	■	■	2952127
DNGX150716T02020	12,70	15,50	7,94	1,6	■	■	2952128

SOLID END MILLING

HOLEMAKING

TAPPING

Ceramic Inserts • ENGN/ENG

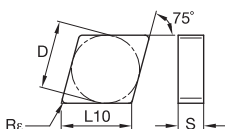
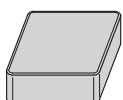

- first choice
- alternate choice

P	■	■	■	■
M	■	■	■	■
K	■	●	■	●
N	■	■	■	■
S	■	■	●	■
H	■	●	■	■

ISO catalogue number	D	L10	S	Rε	CW2015	CW3020	CW5025
ENGN130712T02020	12,70	13,15	7,94	1,2	2952613	■	■

TURNING

Ceramic Inserts • RCGX/RCGV

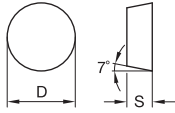
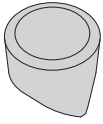

- first choice
- alternate choice

P	■	■	■	■
M	■	■	■	■
K	■	●	■	●
N	■	■	■	■
S	■	■	■	■
H	■	●	■	■

ISO catalogue number	D	S	CW2015	CW3020	CW5025
RCGX060400T01020	6,35	4,76	-	3869746	■
RCGX090700T02020	9,53	7,92	2952694	■	■
RCGX090700T07015	9,53	7,92	2952695	■	■
RCGX090700T01020	9,53	7,94	2952693	3869747	■
RCGX120700T01020	12,70	7,92	-	3869748	■
RCGX120700T02020	12,70	7,92	2952697	■	■
RCGX120700T20015	12,70	7,92	2952698	■	■

INDEXABLE MILLING

SOLID END MILLING

HOLEMAKING

TAPPING

TURNING

INDEXABLE MILLING

SOLID END MILLING

HOLE/MAKING

TAPPING

TURNING

Ceramic Inserts • RNGN/RNG

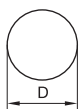
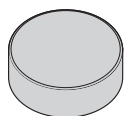

- first choice
- alternate choice

P	■	■	■	■
M	■	■	■	■
K	●	■	■	■
N	■	■	■	■
S	■	■	■	■
H	●	■	■	■

ISO catalogue number	D	S	CW2015	CW3020	CW5025
RNGN090300T01020	9,53	3,18	-	3869749	-
RNGN090400T02020	9,53	4,76	2952615	-	-
RNGN120400T01020	12,70	4,76	-	3869750	-
RNGN120400T02020	12,70	4,76	2952616	-	2952131
RNGN120700T01020	12,70	7,94	-	3869751	-
RNGN120700T02020	12,70	7,94	2952617	-	-
RNGN120700T10015	12,70	7,94	2952618	-	-
RNGN120700T20015	12,70	7,94	2952619	-	-

Ceramic Inserts • RPGX/RPGV

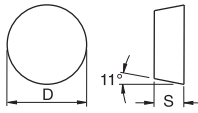
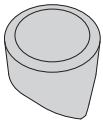

- first choice
- alternate choice

P	■	■	■	■
M	■	■	■	■
K	■	●	■	●
N	■	■	■	■
S	■	■	●	■
H	■	●	■	■
	■	■	■	■

ISO catalogue number	D	S	CW2015	CW3020	CW5025
RPGX060400T01020	6,35	4,78	-	3869753	-
RPGX090700T01020	9,53	7,92	-	3869754	-
RPGX120700T01020	12,70	7,94	-	3869755	-

INDEXABLE MILLING

SOLID END MILLING

HOLEMAKING

TAPPING

TURNING

Ceramic Inserts • SNGN/SNG

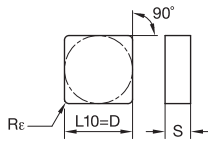
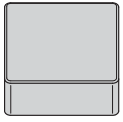

- first choice
- alternate choice

P	■	■	■	■	■
M	■	■	■	■	■
K	●	●	●	●	●
N	■	■	■	■	■
S	■	■	■	■	■
H	●	●	●	●	●

ISO catalogue number	D	L10	S	Rε	CW2015	CW3020	CW5025
SNGN120408T00520	12,70	12,70	4,76	0,8	2952750	■	■
SNGN120408T02020	12,70	12,70	4,76	0,8	2952751	■	■
SNGN120412T01020	12,70	12,70	4,76	1,2	-	3869756	■
SNGN120412T02020	12,70	12,70	4,76	1,2	2952752	■	2952136
SNGN120708T02020	12,70	12,70	7,94	0,8	2952825	■	■
SNGN120712T02020	12,70	12,70	7,94	1,2	2952826	■	■
SNGN120716T00520	12,70	12,70	7,94	1,6	2953340	■	■
SNGN190720K20015	19,05	19,05	7,94	2,0	2952832	■	■

INDEXABLE MILLING

SOLID END MILLING

HOLEMAKING

TAPPING

TURNING

Ceramic Inserts • SNGA

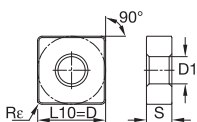
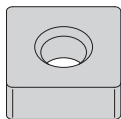

- first choice
- alternate choice

P	■	■	■	■
M	■	■	■	■
K	■	●	■	●
N	■	■	■	■
S	■	■	●	■
H	■	●	■	■

ISO catalogue number	D	L10	S	R _ε	D1	CW2015	CW3020	CW5025
SNGA120408T02020	12,70	12,70	4,76	0,8	5,16	2952538	■	■
SNGA120412T02020	12,70	12,70	4,76	1,2	5,16	2952539	■	■

Ceramic Inserts • SNGX

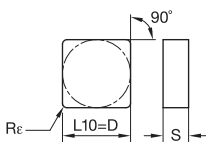
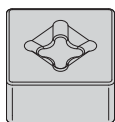

- first choice
- alternate choice

P	■	■	■	■
M	■	■	■	■
K	■	●	■	●
N	■	■	■	■
S	■	■	●	■
H	■	●	■	■

ISO catalogue number	D	L10	S	R _ε	CW2015	CW3020	CW5025
SNGX120712T02020	12,70	12,70	7,94	1,2	■	■	2952142

INDEXABLE MILLING

Ceramic Inserts • SNMX

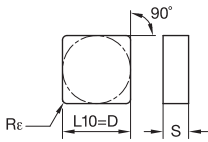
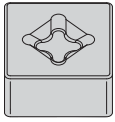

- first choice
- alternate choice

P	■	■	■	■
M	■	■	■	■
K	■	●	■	●
N	■	■	■	■
S	■	■	●	■
H	■	●	■	■

ISO catalogue number	D	L10	S	Rε	CW2015	CW3020	CW5025
SNMX120712T02020	12,70	12,70	7,94	1,2			2952069
SNMX120716T02020	12,70	12,70	7,94	1,6			2952070

SOLID END MILLING

HOLE/MAKING

Ceramic Inserts • SPGN/SPG

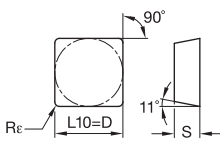
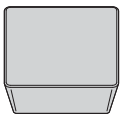

- first choice
- alternate choice

P	■	■	■	■
M	■	■	■	■
K	■	●	■	●
N	■	■	■	■
S	■	■	●	■
H	■	●	■	■

ISO catalogue number	D	L10	S	Rε	CW2015	CW3020	CW5025
SPGN120308T01020	12,70	12,70	3,18	0,8	2952702		

TAPPING

TURNING

Ceramic Inserts • TNGA

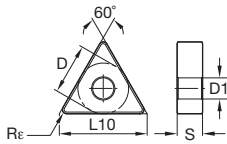
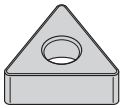

- first choice
- alternate choice

P	■	■	■	■
M	■	■	■	■
K	■	●	■	●
N	■	■	■	■
S	■	■	●	■
H	■	●	■	■

ISO catalogue number	D	L10	S	Rε	D1	CW2015	CW3020	CW5025
TNGA160408T02020	9,53	16,50	4,76	0,8	3,81	2952541	■	2952195
TNGA160412T02020	9,53	16,50	4,76	1,2	3,81	2952542	■	■
TNGA220408T02020	12,70	22,00	4,76	0,8	5,16	2952544	■	■

Ceramic Inserts • TNGN/TNG

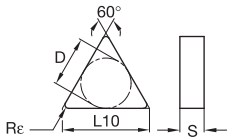
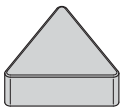

- first choice
- alternate choice

P	■	■	■	■
M	■	■	■	■
K	■	●	■	●
N	■	■	■	■
S	■	■	●	■
H	■	●	■	■

ISO catalogue number	D	L10	S	Rε	CW2015	CW3020	CW5025
TNGN160404T02020	9,53	16,50	4,76	0,4	2952835	■	■
TNGN160408T01020	9,53	16,50	4,76	0,8	■	3869761	■
TNGN160408T02020	9,53	16,50	4,76	0,8	2952836	■	■
TNGN160712T02020	9,53	16,50	7,94	1,2	2952840	■	■
TNGN220408T02020	12,70	22,00	4,76	0,8	2952841	■	■

INDEXABLE MILLING

SOLID END MILLING

HOLEMAKING

TAPPING

TURNING

Ceramic Inserts • TPGN/TPG

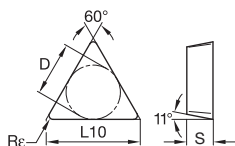
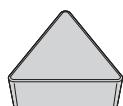

- first choice
- alternate choice

P	■	■	■	■
M	■	■	■	■
K	■	●	■	●
N	■	■	■	■
S	■	■	●	■
H	■	●	■	■

ISO catalogue number	D	L10	S	Rε	CW2015	CW3020	CW5025
TPGN110304T01020	6,35	11,00	3,18	0,4	2952706	■	■
TPGN110308T01020	6,35	11,00	3,18	0,8	2952707	■	■
TPGN160304T00520	9,53	16,50	3,18	0,4	2952709	■	■
TPGN160304T01020	9,53	16,50	3,18	0,4	2952710	■	■
TPGN160308T00520	9,53	16,50	3,18	0,8	2952711	■	■
TPGN160308T01020	9,53	16,50	3,18	0,8	2952712	■	■

Ceramic Inserts • VNGA

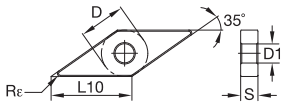
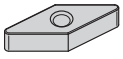

- first choice
- alternate choice

P	■	■	■	■
M	■	■	■	■
K	■	●	■	●
N	■	■	■	■
S	■	■	●	■
H	■	●	■	■

ISO catalogue number	D	L10	S	Rε	D1	CW2015	CW3020	CW5025
VNGA160404T02020	9,53	16,61	4,76	0,4	3,81	2952545	■	■
VNGA160408T02020	9,53	16,61	4,76	0,8	3,81	2952546	■	■
VNGA160412T02020	9,53	16,61	4,76	1,2	3,81	2952547	■	■

Ceramic Inserts • WNGA

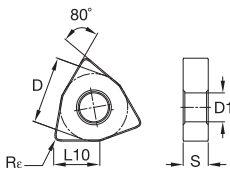
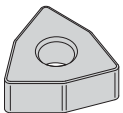

- first choice
- alternate choice

P	■	■	■	■
M	■	■	■	■
K	■	●	■	●
N	■	■	■	■
S	■	■	●	■
H	■	●	■	■

ISO catalogue number	D	L10	S	Rε	D1	CW2015	CW3020	CW5025
WNGA080408T02020	12,70	8,69	4,76	0,8	5,16	■	■	2952199
WNGA080412T02020	12,70	8,69	4,76	1,2	5,16	■	■	2952200

INDEXABLE MILLING

Polycrystalline Diamond Inserts (PCD) • CCGW-FST

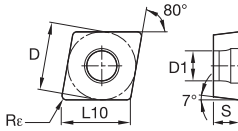
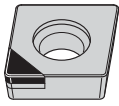

- first choice
- alternate choice

P	■	■	■
M	■	■	■
K	■	■	■
N	■	●	●
S	■	●	■
H	■	■	■

SOLID END MILLING

ISO catalogue number	D	L10	S	Rε	D1	WDN00U	WDN25U
CCGW060204FST	6,35	6,45	2,38	0,4	2,80	5885722	3898746
CCGW09T304FST	9,53	9,67	3,97	0,4	4,40	5885723	3898749
CCGW09T308FST	9,53	9,67	3,97	0,8	4,40	5885724	3898750

HOLEMAKING

TAPPING

Polycrystalline Diamond Inserts (PCD) • CCMW-FST

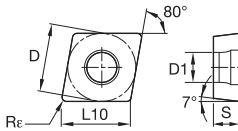
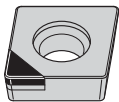

- first choice
- alternate choice

P	■	■	■
M	■	■	■
K	■	■	■
N	■	●	●
S	■	●	■
H	■	■	■

ISO catalogue number	D	L10	S	Rε	D1	WDN00U	WDN25U
CCMW09T304FST	9,53	9,67	3,97	0,4	4,40	3883134	3883136
CCMW09T308FST	9,53	9,67	3,97	0,8	4,40	3883136	3883136

TURNING

Polycrystalline Diamond Inserts (PCD) • CDHB-FST

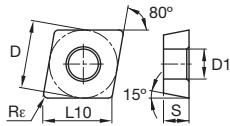

- first choice
- alternate choice

P	■	■	■	■
M	■	■	■	■
K	■	■	■	■
N	■	●	●	■
S	■	●	■	■
H	■	■	■	■

ISO catalogue number	D	L10	S	Rε	D1		
						WDN00U	WDN25U
CDHBS4T0X0FST	3,97	4,03	1,02	0,1	2,13	○	3898745
CDHBS4T002FST	3,97	4,03	1,02	0,2	2,13	○	3898744

Polycrystalline Diamond Inserts (PCD) • CNGA-FST

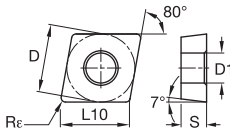
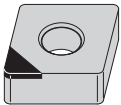

- first choice
- alternate choice

P	■	■	■	■
M	■	■	■	■
K	■	■	■	■
N	■	●	●	■
S	■	●	■	■
H	■	■	■	■

ISO catalogue number	D	L10	S	Rε	D1		
						WDN00U	WDN25U
CNGA120404FST	12,70	12,90	4,76	0,4	5,16	○	3898726
CNGA120408FST	12,70	12,90	4,76	0,8	5,16	●	3898727

Polycrystalline Diamond Inserts (PCD) • CPGW-FWST

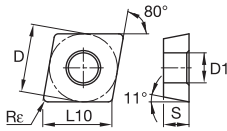
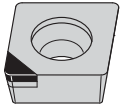

- first choice
- alternate choice

P	■	■	■
M	■	■	■
K	■	■	■
N	■	●	●
S	■	●	■
H	■	■	■

ISO catalogue number	D	L10	S	R ϵ	D1	WDN00U	WDN25U
CPGW060204FWST	6,35	6,45	2,38	0,4	2,80	5885768	1

Polycrystalline Diamond Inserts (PCD) • CPGW-FST

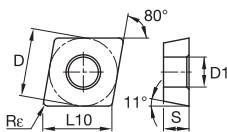
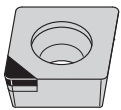

- first choice
- alternate choice

P	■	■	■
M	■	■	■
K	■	■	■
N	■	●	●
S	■	●	■
H	■	■	■

ISO catalogue number	D	L10	S	R ϵ	D1	WDN00U	WDN25U
CPGW060204FST	6,35	6,45	2,38	0,4	2,80	1	3898752
CPGW060208FST	6,35	6,45	2,38	0,8	2,80	1	3898753

INDEXABLE MILLING

SOLID END MILLING

HOLEMAKING

TAPPING

TURNING

Polycrystalline Diamond Inserts (PCD) • DCGW-FST

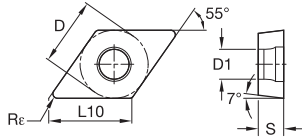
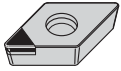

- first choice
- alternate choice

P	■	■	■
M	■	■	■
K	■	■	■
N	■	●	●
S	■	●	■
H	■	■	■

ISO catalogue number	D	L10	S	Rε	D1	Material	
						WDN00U	WDN25U
DCGW070204FST	6,35	7,75	2,38	0,4	2,80	■	3898761
DCGW11T304FST	9,53	11,63	3,97	0,4	4,40	■	3898762

Polycrystalline Diamond Inserts (PCD) • DCMW-FST

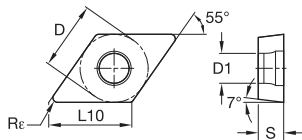
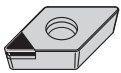

- first choice

P	■	■	■
M	■	■	■
K	■	■	■
N	■	●	●
S	■	●	■
H	■	■	■

ISO catalogue number	D	L10	S	Rε	D1	Material	
						WDN00U	WDN25U
DCMW070204FST	6,35	7,75	2,38	0,4	2,80	■	3883142
DCMW11T304FST	9,53	11,63	3,97	0,4	4,40	■	3883122
DCMW11T308FST	9,53	11,63	3,97	0,8	4,40	■	3883143

INDEXABLE MILLING

Polycrystalline Diamond Inserts (PCD) • DNGA-FST

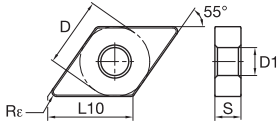
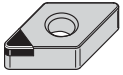

- first choice
- alternate choice

P	■	■	■
M	■	■	■
K	■	■	■
N	■	●	●
S	■	●	■
H	■	■	■

SOLID END MILLING

ISO catalogue number	D	L10	S	Rε	D1	WDN00U	WDN25U
DNGA150408FST	12,70	15,50	4,76	0,8	5,16	5885775	3898731

HOLEMAKING

Polycrystalline Diamond Inserts (PCD) • DPGW-FST

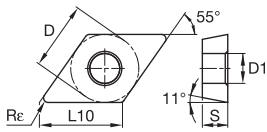
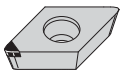

- first choice
- alternate choice

P	■	■	■
M	■	■	■
K	■	■	■
N	■	●	●
S	■	●	■
H	■	■	■

TAPPING

ISO catalogue number	D	L10	S	Rε	D1	WDN00U	WDN25U
DPGW070202FST	6,35	7,75	2,38	0,2	2,80	5885778	1

TURNING

Polycrystalline Diamond Inserts (PCD) • DPGW-FWST

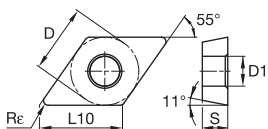
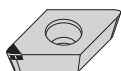

- first choice
- alternate choice

P	■	■	■	■
M	■	■	■	■
K	■	■	■	■
N	■	■	●	●
S	■	■	●	■
H	■	■	■	■

ISO catalogue number	D	L10	S	Rε	D1	Material	
						WDN00U	WDN25U
DPGW11T304FWST	9,53	11,63	3,97	0,4	4,40	5885791	1

Polycrystalline Diamond Inserts (PCD) • TCGW-FST

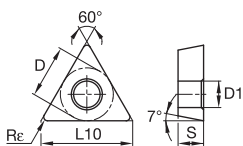

- first choice
- alternate choice

P	■	■	■	■
M	■	■	■	■
K	■	■	■	■
N	■	■	●	●
S	■	■	●	■
H	■	■	■	■

ISO catalogue number	D	L10	S	Rε	D1	Material	
						WDN00U	WDN25U
TCGW110204FST	6,35	11,00	2,38	0,4	2,80	3898768	1
TCGW16T304FST	9,53	16,50	3,97	0,4	4,40	3898769	1

INDEXABLE MILLING

Polycrystalline Diamond Inserts (PCD) • TCMW-FST

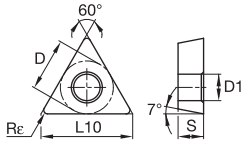
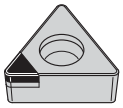

- first choice
- alternate choice

P	■	■	■
M	■	■	■
K	■	■	■
N	■	●	●
S	■	●	■
H	■	■	■

SOLID END MILLING

ISO catalogue number	D	L10	S	Rε	D1	WDN00U	WDN25U
TCMW110204FST	6,35	11,00	2,38	0,4	2,80	I	3883144

HOLEMAKING

Polycrystalline Diamond Inserts (PCD) • TNMS-FST

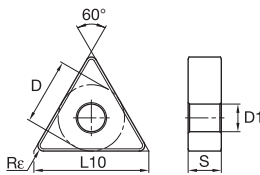
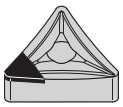

- first choice
- alternate choice

P	■	■	■
M	■	■	■
K	■	■	■
N	■	●	●
S	■	●	■
H	■	■	■

TAPPING

ISO catalogue number	D	L10	S	Rε	D1	WDN00U	WDN25U
TNMS160404FST	9,53	16,50	4,76	0,4	3,81	I	3888734

TURNING

Polycrystalline Diamond Inserts (PCD) • TPGN / TPG

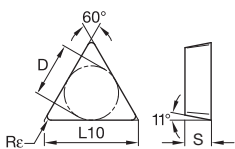

- first choice
- alternate choice

P	■	■	■
M	■	■	■
K	■	■	■
N	■	●	●
S	■	●	■
H	■	■	■

ISO catalogue number	D	L10	S	Rε	WDN00U	WDN25U
TPGN160304F	9,53	16,50	3,18	0,4	■	■

Polycrystalline Diamond Inserts (PCD) • TPGW-FST

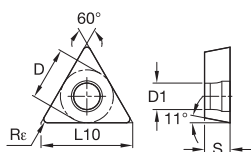

- first choice
- alternate choice

P	■	■	■
M	■	■	■
K	■	■	■
N	■	●	●
S	■	●	■
H	■	■	■

ISO catalogue number	D	L10	S	Rε	D1	WDN00U	WDN25U
TPGW16T304FST	9,53	16,50	3,97	0,4	4,40	■	■

INDEXABLE MILLING

SOLID END MILLING

HOLEMAKING

TAPPING

TURNING

INDEXABLE MILLING

Polycrystalline Diamond Inserts (PCD) • VBGW-FST

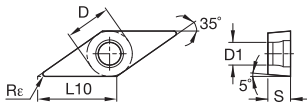
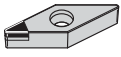

- first choice
- alternate choice

P	■	■	■
M	■	■	■
K	■	■	■
N	■	●	●
S	■	●	■
H	■	■	■

SOLID END MILLING

ISO catalogue number	D	L10	S	Rε	D1	WDN00U	WDN25U
VBGW110304FST	6,35	11,07	3,18	0,4	2,80	3898774	3898775
VBGW160404FST	9,53	16,61	4,76	0,4	4,40	3898775	3898775

HOLEMAKING

Polycrystalline Diamond Inserts (PCD) • VNMS-FST

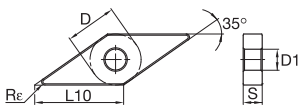
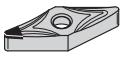

- first choice
- alternate choice

P	■	■	■
M	■	■	■
K	■	■	■
N	■	●	●
S	■	●	■
H	■	■	■

TAPPING

ISO catalogue number	D	L10	S	Rε	D1	WDN00U	WDN25U
VNMS160408FST	9,53	16,61	4,76	0,8	3,81	3898739	3898739

TURNING

Polycrystalline Diamond Inserts (PCD) • WNGA-FST

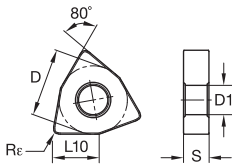
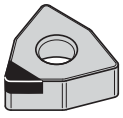

- first choice
- alternate choice

P	■	■	■	■
M	■	■	■	■
K	■	■	■	■
N	■	■	●	●
S	■	■	●	■
H	■	■	■	■

ISO catalogue number	D	L10	S	Rε	D1	WDN00U	WDN25U
WNGA080408FST	12,70	8,69	4,76	0,8	5,16	■	●

Cubic Boron Nitride (CBN) Inserts • CCGW-M

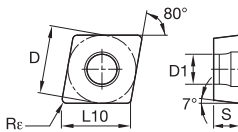
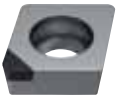

- first choice
- alternate choice

P	■	■	■	■
M	■	■	■	■
K	■	■	■	■
N	■	■	■	●
S	■	■	■	●
H	■	●	●	●

ISO catalogue number	D	L10	S	Rε	D1	WBH10P	WBH20P	WBH30P	WBK40U
CCGW09T308S01015M	9,53	9,67	3,99	0,8	4,40	■	●	■	■

INDEXABLE MILLING

SOLID END MILLING

HOLEMAKING

TAPPING

TURNING

Cubic Boron Nitride (CBN) Inserts • CCGW-MT

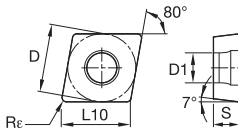
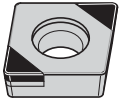

- first choice
- alternate choice

P	■				
M	■				
K	■			●	●
N	■				
S	■			●	
H	■	●	●	●	●

ISO catalogue number	D	L10	S	Re	D1	WBH10P	WBH20P	WBH30P	WBK40U
CCGW09T304S01015MT	9,53	9,67	3,99	0,4	4,40	3883507	6904777	●	●
CCGW09T308S01015MT	9,53	9,67	3,99	0,8	4,40	3883508	6904776	●	●
CCGW120408S01015MT	12,70	12,90	4,78	0,8	5,50	6904775	●	●	●

Cubic Boron Nitride (CBN) Inserts • CNGA-EMT

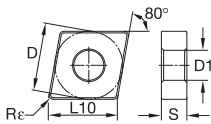
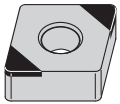

- first choice
- alternate choice

P	■				
M	■				
K	■			●	●
N	■				
S	■			●	
H	■	●	●	●	●

ISO catalogue number	D	L10	S	Re	D1	WBH10P	WBH20P	WBH30P	WBK40U
CNGA120408EMT	12,70	12,90	4,76	0,8	5,16	6904778	●	●	●

Cubic Boron Nitride (CBN) Inserts • CNGA-MT

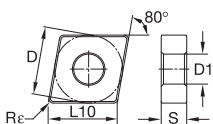

- first choice
- alternate choice

P	■				
M	■				
K	■			●	●
N	■				
S	■			●	
H	■	●	●	●	●

ISO catalogue number	D	L10	S	Re	D1	WBH10P	WBH20P	WBH30P	WBK40U
CNGA120404S01025MT	12,70	12,90	4,78	0,4	5,16	3883509	6904779	■	■
CNGA120408S01025MT	12,70	12,90	4,78	0,8	5,16	3883510	6904780	6018008	■
CNGA120412S01020MT	12,70	12,90	4,78	1,2	5,16	■	■	6018009	■
CNGA120412S01025MT	12,70	12,90	4,78	1,2	5,16	■	6904821	6018010	■

Cubic Boron Nitride (CBN) Inserts • CPGW-C

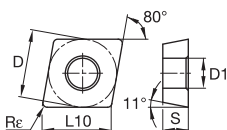

- first choice
- alternate choice

P	■				
M	■				
K	■			●	●
N	■				
S	■			●	
H	■	●	●	●	●

ISO catalogue number	D	L10	S	Re	D1	WBH10P	WBH20P	WBH30P	WBK40U
CPGW060204S01015C	6,35	6,45	2,38	0,4	2,80	■	■	6018082	■

INDEXABLE MILLING

Cubic Boron Nitride (CBN) Inserts • CPGW-MT

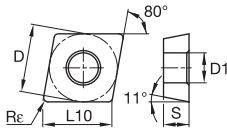

- first choice
- alternate choice

P	■				
M	■				
K	■			●	●
N	■				
S	■			●	
H	■	●	●	●	●

ISO catalogue number	D	L10	S	Rε	D1	WBH10P	WBH20P	WBH30P	WBK40U
CPGW09T308S01015MT	9,53	9,67	3,99	0,8	4,40	■	■	6018085	■

SOLID END MILLING

HOLEMAKING

Cubic Boron Nitride (CBN) Inserts • DCGW-C

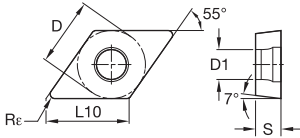
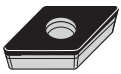

- first choice
- alternate choice

P	■				
M	■				
K	■			●	●
N	■				
S	■			●	
H	■	●	●	●	●

ISO catalogue number	D	L10	S	Rε	D1	WBH10P	WBH20P	WBH30P	WBK40U
DCGW070202S01015C	6,35	7,75	2,38	0,2	2,80	3883528	■	■	■
DCGW070204S01015C	6,35	7,75	2,38	0,4	2,80	3883529	■	■	■

TAPPING

TURNING

Cubic Boron Nitride (CBN) Inserts • DCGW-MT

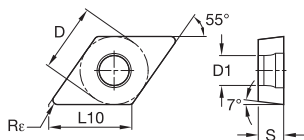
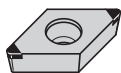

- first choice
- alternate choice

P	■				
M	■				
K	■				
N	■			●	●
S	■			●	
H	■	●	●	●	●

ISO catalogue number	D	L10	S	R _ε	D1	WBH10P	WBH20P	WBH30P	WBK40U
DCGW11T304S01015MT	9,53	11,63	3,99	0,4	4,40	3883530	6904823	6018088	—
DCGW11T308S01015MT	9,53	11,63	3,99	0,8	4,40	3883531	6904824	—	—

Cubic Boron Nitride (CBN) Inserts • DCMW-MT

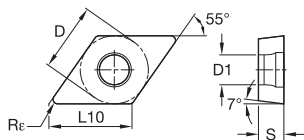
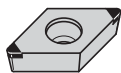

- first choice
- alternate choice

P	■				
M	■				
K	■				
N	■			●	●
S	■			●	
H	■	●	●	●	●

ISO catalogue number	D	L10	S	R _ε	D1	WBH10P	WBH20P	WBH30P	WBK40U
DCMW070204S01020MT	6,35	7,74	2,38	0,4	2,80	—	6904822	—	—

INDEXABLE MILLING

SOLID END MILLING

HOLEMAKING

TAPPING

TURNING

Cubic Boron Nitride (CBN) Inserts • DNGA-EMT

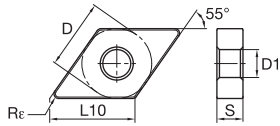

- first choice
- alternate choice

P	■	■	■	■
M	■	■	■	■
K	■	■	■	■
N	■	■	■	■
S	■	■	■	■
H	●	●	●	●

ISO catalogue number	D	L10	S	R _ε	D1	WBH10P	WBH20P	WBH30P	WBK40U
DNGA150408EMT	12,70	15,50	4,76	0,8	5,16	■	6904825	■	■
DNGA150412EMT	12,70	15,50	4,76	1,2	5,16	■	6904826	■	■

Cubic Boron Nitride (CBN) Inserts • DNGA-MT

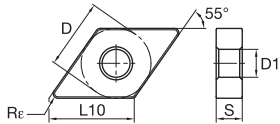
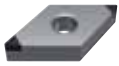

- first choice
- alternate choice

P	■	■	■	■
M	■	■	■	■
K	■	■	■	■
N	■	■	■	■
S	■	■	■	■
H	●	●	●	●

ISO catalogue number	D	L10	S	R _ε	D1	WBH10P	WBH20P	WBH30P	WBK40U
DNGA150404S01025MT	12,70	15,50	4,78	0,4	5,16	■	3863532	■	■
DNGA150408S01025MT	12,70	15,50	4,78	0,8	5,16	■	6904829	5108479	■
DNGA150608S01225MT	12,70	15,50	6,37	0,8	5,16	■	6904830	■	■

Cubic Boron Nitride (CBN) Inserts • DNMA-ST

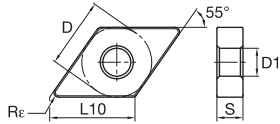
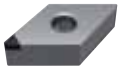

- first choice
- alternate choice

P	■				
M	■				
K	■			●	●
N	■				
S	■			●	
H	■	●	●	●	●

ISO catalogue number	D	L10	S	Rε	D1	WBH10P	WBH20P	WBH30P	WBK40U
DNMA150604S01020ST	12,70	15,50	6,35	0,4	5,16	■	6904827	■	■

Cubic Boron Nitride (CBN) Inserts • RNGN/RNG

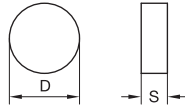

- first choice
- alternate choice

P	■				
M	■				
K	■			●	●
N	■				
S	■			●	
H	■	●	●	●	●

ISO catalogue number	D	S	WBH10P	WBH20P	WBH30P	WBK40U
RNGN120400S01020	12,70	4,76	■	6904851	■	■

INDEXABLE MILLING

SOLID END MILLING

HOLE/MAKING

TAPPING

TURNING

INDEXABLE MILLING

SOLID END MILLING

HOLEMAKING

TAPPING

TURNING

Cubic Boron Nitride (CBN) Inserts • RNMN/RNM

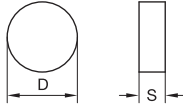

- first choice
- alternate choice

P	■				
M	■				
K	■			●	●
N	■				
S	■			●	
H	■	●	●	●	●

ISO catalogue number	D	S	WBH10P	WBH20P	WBH30P	WBK40U
RNMN090300S02020	9,53	3,18	○	○	○	3883315
RNMN120300S02020	12,70	3,18	○	○	○	3883316
RNMN120400S02020	12,70	4,76	○	○	○	3883317

Cubic Boron Nitride (CBN) Inserts • SNGA-MT

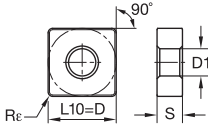
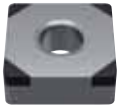

- first choice
- alternate choice

P	■				
M	■				
K	■			●	●
N	■				
S	■			●	
H	■	●	●	●	●

ISO catalogue number	D	L10	S	R _c	D1	WBH10P	WBH20P	WBH30P	WBK40U
SNGA120408S01025MT	12,70	12,70	4,78	0,8	5,16	○	6904852	○	○

Cubic Boron Nitride (CBN) Inserts • TCGW-MT

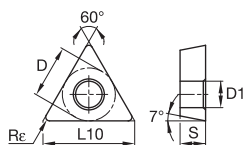
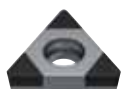

- first choice
- alternate choice

P	■				
M	■				
K	■			●	●
N	■				
S	■			●	
H	■	●	●	●	●

ISO catalogue number	D	L10	S	Rε	D1	WBH10P	WBH20P	WBH30P	WBK40U
TCGW110204S01015MT	6,35	11,00	2,40	0,4	2,80	○	6904853	○	○
TCGW110208S01015MT	6,35	11,00	2,40	0,8	2,80	○	6904854	○	○
TCGW16T308S01015MT	9,53	16,50	3,99	0,8	4,40	○	6904855	○	○

Cubic Boron Nitride (CBN) Inserts • TNGA-MT

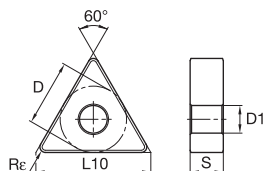

- first choice
- alternate choice

P	■				
M	■				
K	■			●	●
N	■				
S	■			●	
H	■	●	●	●	●

ISO catalogue number	D	L10	S	Rε	D1	WBH10P	WBH20P	WBH30P	WBK40U
TNGA160404S01025MT	9,53	16,50	4,78	0,4	3,81	○	6904856	○	○
TNGA160408S01025MT	9,53	16,50	4,78	0,8	3,81	○	6904857	○	○
TNGA160412S01225MT	9,53	16,50	4,78	1,2	3,81	○	6904866	○	○

INDEXABLE MILLING

SOLID END MILLING

HOLEMAKING

TAPPING

TURNING

Cubic Boron Nitride (CBN) Inserts • TPGW-C

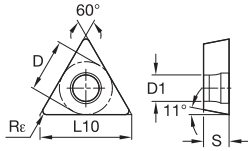

- first choice
- alternate choice

P	■				
M	■				
K	■			●	●
N	■				
S	■			●	
H	■	●	●	●	●

ISO catalogue number	D	L10	S	Re	D1	WBH10P	WBH20P	WBH30P	WBK40U
TPGW110204S01015C	6,35	11,00	2,38	0,4	2,80	○	○	● 6018092	○
TPGW110208S01015C	6,35	11,00	2,38	0,8	2,80	○	○	● 6018093	○

Cubic Boron Nitride (CBN) Inserts • VBGW-MT

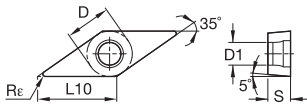
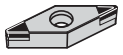

- first choice
- alternate choice

P	■				
M	■				
K	■			●	●
N	■				
S	■			●	
H	■	●	●	●	●

ISO catalogue number	D	L10	S	Re	D1	WBH10P	WBH20P	WBH30P	WBK40U
VBGW160404S01015MT	9,53	16,61	4,78	0,4	4,40	● 3883536	○	● 6018094	○
VBGW160408S01015MT	9,53	16,61	4,78	0,8	4,40	○	○	● 6018095	○

Cubic Boron Nitride (CBN) Inserts • VNGA-MT

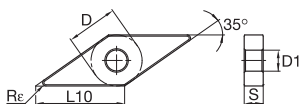

- first choice
- alternate choice

P	■				
M	■				
K	■			●	●
N	■				
S	■			●	
H	■	●	●	●	●

ISO catalogue number	D	L10	S	Rr	D1	WBH10P	WBH20P	WBH30P	WBK40U
VNGA160404S01025MT	9,53	16,61	4,78	0,4	3,81	3883538	6904868	6018096	■
VNGA160408S01025MT	9,53	16,61	4,78	0,8	3,81	■	6018097	■	
VNGA160408S01225MT	9,53	16,61	4,78	0,8	3,81	■	6904869	■	

Cubic Boron Nitride (CBN) Inserts • WNGA-MT

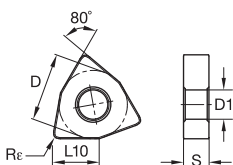
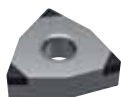

- first choice
- alternate choice

P	■				
M	■				
K	■			●	●
N	■				
S	■			●	
H	■	●	●	●	●

ISO catalogue number	D	L10	S	Rr	D1	WBH10P	WBH20P	WBH30P	WBK40U
WNGA080404S01015MT	12,70	8,69	4,78	0,4	5,16	■	6904870	■	■
WNGA080408S01225MT	12,70	8,69	4,78	0,8	5,16	■	6904871	■	■

Tools for External Turning

External Toolholder

WIDIA™ offers an extensive range of toolholders for external turning to meet even the most exacting production demands across a broad spectrum of workpieces, shapes, and sizes.

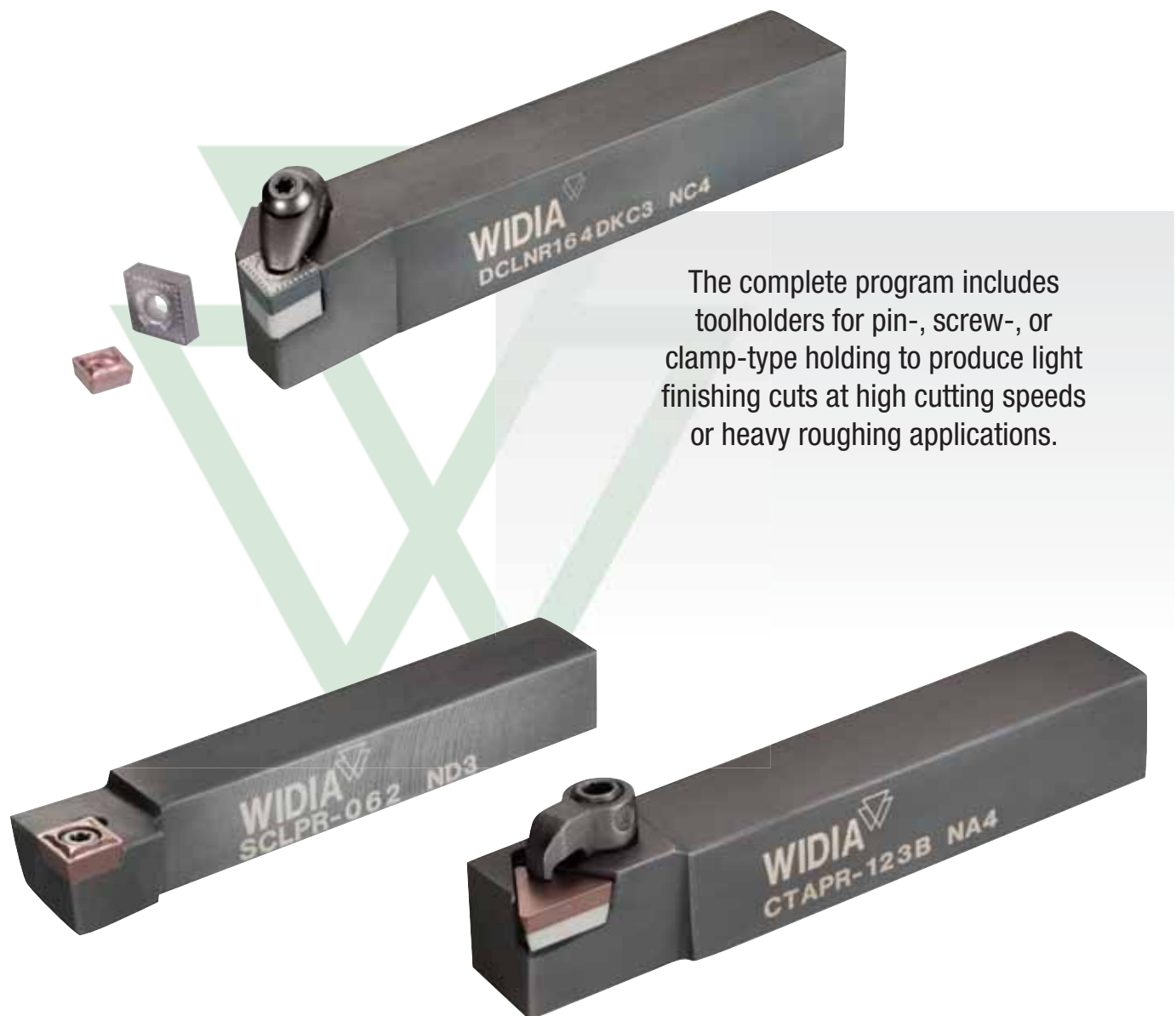

TOOLS FOR EXTERNAL TURNING

D-STYLE CLAMPING

- Used for negative style inserts.
- Clamp assembly contains clamp, screw, and retaining ring.
- Quick insert indexing.
- Ensures insert repeatability and seating.
- Reduced chatter and extended tool life.

P-STYLE CLAMPING

- Lever-type clamping system for negative indexable inserts.
- No interference to chip flow.
- Fast insert changes.
- P-style available in metric sizes only.

S-STYLE CLAMPING

- Screw clamping system for positive indexable inserts.
- Compact design for high reliability and cost efficiency.
- Carbide shim for additional tool protection.

C-STYLE CLAMPING

- Height-adjustable clamp permits use of additional chipbreakers.
- Universal clamping system for positive and negative flat top inserts.
- Robust engineering makes it easy to handle.
- Carbide shim for extra tool protection.

APPLICATIONS



TURNING



FACING



PROFILING



CHAMFERING

INDUSTRY



Toolholder Selection Guide

Each unique clamping system offers product options to fill your specific toolholder needs. Find the illustration that fits your application and navigate to the corresponding page to get the correct solution.

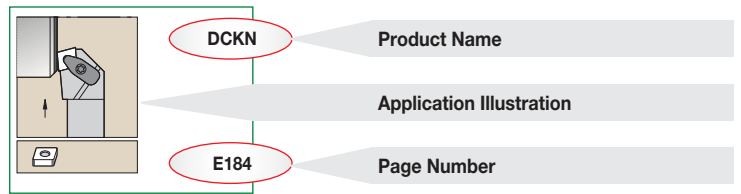

D-Style Clamping

D

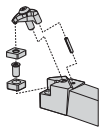

One-piece clamp assembly holder for use with negative style inserts. An extremely rigid clamping system. The tool is protected by a carbide shim.

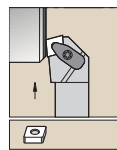

DCKN
75°
Page:
E184

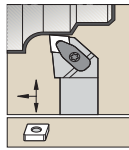

DCLN
95°
Page:
E184



DCRN
75°
Page:
E185

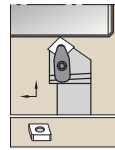

DCSN
45°
Page:
E186

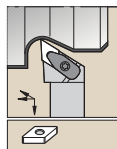

DDJN
93°
Page:
E186

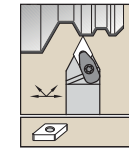

DDNN
63°
Page:
E187

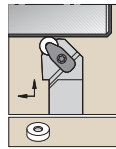

DRGN
Page:
E187

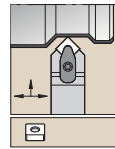

DSDN
45°
Page:
E188

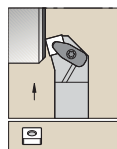

DSKN
75°
Page:
E188

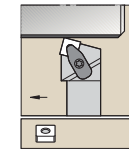

DSRN
75°
Page:
E189

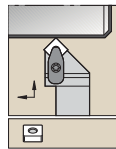

DSSN
45°
Page:
E189

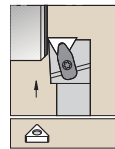

DTFN
90°
Page:
E222

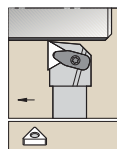

DTGN
90°
Page:
E190

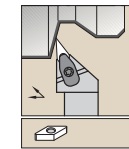

DVJN
93°
Page:
E190

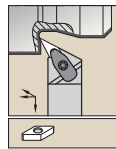

DVON
117,5°
Page:
E191

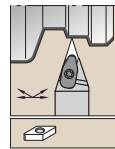

DVTN
72,5°
Page:
E191

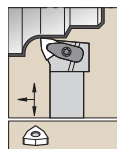

DWLN
95°
Page:
E192

P-Style Clamping

P

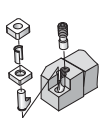

Lever-type clamping system for negative indexable inserts with hole to DIN 4988 and positive round inserts more than 20mm in diameter. Inserts with one- and two-side chip control geometries have positive rakes from 6° to 18°. Advantages of this system are fast insert changes and no interference with chip flow.

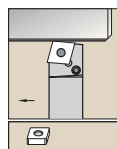

PCBN
75°
Page:
E193

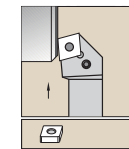

PCKN
75°
Page:
E193

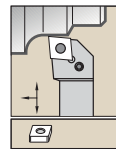

PCLN
95°
Page:
E194

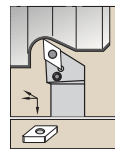

PDJN
93°
Page:
E194

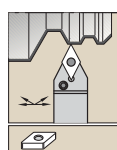

PDNN
62,5°
Page:
E195

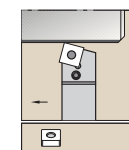

PSBN
75°
Page:
E195

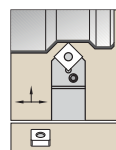

PSDN
45°
Page:
E196

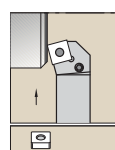

PSKN
75°
Page:
E196

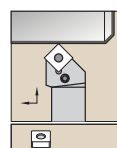

PSSN
45°
Page:
E197

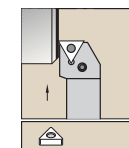

PTFN
90°
Page:
E197

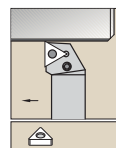

PTGN
90°
Page:
E198

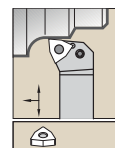

PWLN
95°
Page:
E198

C-Style Clamping

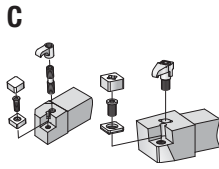

Top clamping system for negative and positive indexable inserts to DIN 4968. This universal clamping system is robust and easy to handle. Some height-adjustable clamps enable the use of additional chip-breakers. A carbide shim provides additional tool protection. Toolholders with cutting edge heights upwards of 16mm and insert iCs greater than 6,35mm.

	CCLN-MX 95° Page: E199		CCLN-MN 95° Page: E199		CCLN-MF 95° Page: —		CDJN-MX 93° Page: —
	CDJN-MN 93° Page: —		CELN-MF 97,5° Page: —		CELN-MN 97,5° Page: —		CKJN Page: E200
	CRDN-MN Page: E201		CRSN-MN Page: E200		CSBP 75° Page: E202		CSDP 45° Page: E203
	CSSP 45° Page: E203		CTCP 90° Page: E204		CTDP 45° Page: E204		CTFP 90° Page: E230
	CTGP 90° Page: E205		CRDP* Page: E205		CRGP* Page: —		

*Exact Clamping System not shown.

S-Style Clamping

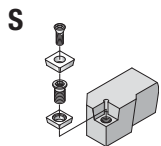









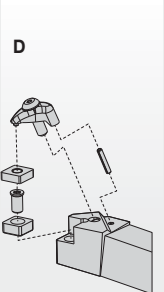





























Screw clamping system for positive indexable inserts with countersunk hole to DIN 4967. Compact design using a minimum of spare parts for high reliability and cost efficiency. A carbide shim provides additional tool protection. Toolholders with cutting edge heights upwards of 16mm and insert iCs from 9,52mm are secured by means of a threaded bushing.

	SCLC 95° Page: E207		SCDP 45° Page: —		SCLP 95° Page: E233-E234		SDHC 107,5° Page: E207
	SDJC 93° Page: E208		SDNC 62,5° Page: E208		SRDC Page: E209		SSBC 75° Page: E209
	SSSC 45° Page: E210		STFC 90° Page: E210		SVHB 107,5° Page: E211		SVJB 93° Page: E211
	SVVB 72,5° Page: E212						

Catalog Numbering System

Each character in our catalog number signifies a specific trait of that product. Use the following key columns and corresponding images to easily identify which attributes apply.

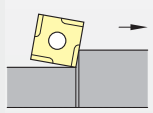
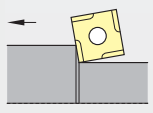
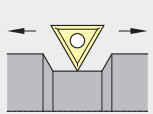
D	C	L	N	R	
Insert Holding Method	Insert Shape	Tool Style or Lead Angle	Insert Clearance Angle	Hand of Tool	Additional Information
<p>D</p> 	<p>A </p> <p>B </p> <p>C </p> <p>D </p> <p>E </p> <p>H </p> <p>K </p> <p>L </p> <p>M </p> <p>O </p> <p>P </p> <p>R </p> <p>S </p> <p>T </p> <p>V </p> <p>W </p>	<p>A  L </p> <p>B  P </p> <p>C  Q </p> <p>D  R </p> <p>E  S </p> <p>F  U </p> <p>G  V </p> <p>Y </p>	<p>N </p> <p>B </p> <p>C </p> <p>P </p> <p>D </p> <p>E </p> <p>F </p>	<p>R = Right hand</p> <p>L = Left hand</p> <p>N = Neutral</p> <p>R</p>  <p>L</p>  <p>N</p> 	<p>C = Deep pocket for ceramic insert</p> <p>S = Single pocket locating wall</p> <p>F = Straight shank, no offset</p>

Catalog Numbering System

(continued)

25

Shank Dimensions

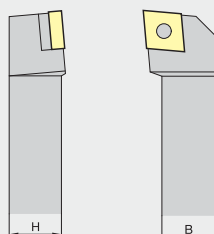

The seventh and eighth position shall be a significant two-digit number that indicates the holder cross section.

- If the dimension for the width "B" or the height "H" is represented by a one-digit number, a 0 (zero) will be used in front of it.

Example: 8,0mm = 08

25

M

Tool Length

L1	ISO
32	A
40	B
50	C
60	D
70	E
80	F
90	G
100	H
110	J
125	K
140	L
150	M
160	N
170	P
180	Q
200	R
250	S
300	T
350	U
400	V
450	W
500	Y
Special Design	X

12

Insert Size

KC

Additional Information

KC =
D-Style Clamping

04

Insert Thickness (optional)

04 = 4,76mm
06 = 6,35mm

Cutting Edge Length

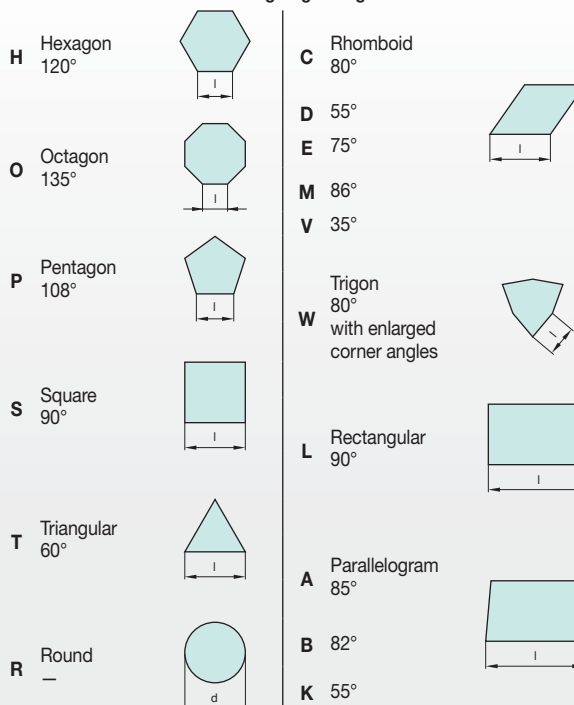

INDEXABLE MILLING

SOLID END MILLING

HOLE/MAKING

TAPPING

TURNING

DCKN 75°

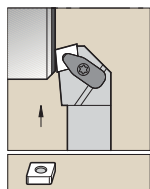

See pages E28–E42, E145, E159, E168–E169 for inserts.

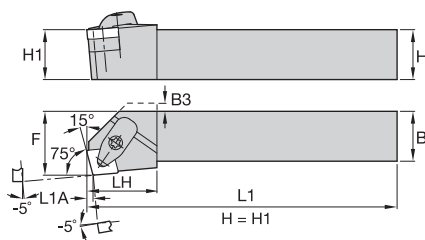

order number	catalogue number	H	B	F	L1	LH	L1A	B3	gage insert
right hand									
5697856	DCKNR2020K12KC04	20	20	25,0	125	32,0	3,1	6,0	CN..120408
5697857	DCKNR2525M12KC04	25	25	32,0	150	32,0	3,1	—	CN..120408
left hand									
5697854	DCKNL2525M12KC04	25	25	32,0	150	32,0	3,1	—	CN..120408

DCLN 95°

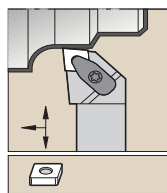

See pages E28–E42, E145, E159, E168–E169 for inserts.

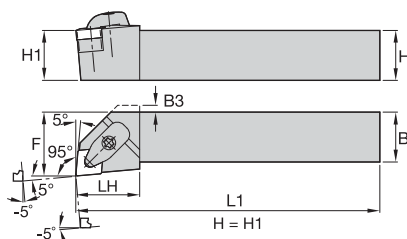

order number	catalogue number	H	B	F	L1	LH	B3	gage insert
right hand								
5697891	DCLNR2020K09KC03	20	20	25,0	125	30,0	2,0	CN..090308
5697892	DCLNR2020K12KC04	20	20	25,0	125	32,0	4,0	CN..120408
5697893	DCLNR2525M12KC04	25	25	32,0	150	32,0	—	CN..120408
5697894	DCLNR2525M16KC06	25	25	32,0	150	33,0	—	CN..160612
5697895	DCLNR3232P16KC06	32	32	40,0	170	33,0	—	CN..160612
5697896	DCLNR3232P19KC06	32	32	40,0	170	40,0	—	CN..190612
5697897	DCLNR4040S19KC06	40	40	50,0	250	40,0	—	CN..190612
5697898	DCLNR4040S25KC09	40	40	50,0	250	51,0	—	CN..250924
left hand								
5697883	DCLNL2020K12KC04	20	20	25,0	125	32,0	4,0	CN..120408
5697884	DCLNL2525M12KC04	25	25	32,0	150	32,0	—	CN..120408
5697885	DCLNL2525M16KC06	25	25	32,0	150	33,0	—	CN..160612
5697886	DCLNL3232P16KC06	32	32	40,0	170	33,0	—	CN..160612
5697887	DCLNL3232P19KC06	32	32	40,0	170	40,0	—	CN..190612
5697888	DCLNL4040S19KC06	40	40	50,0	250	40,0	—	CN..190612

DCLN 5°

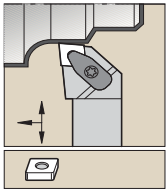

See pages E28–E42, E145, E159, E168–E169 for inserts.

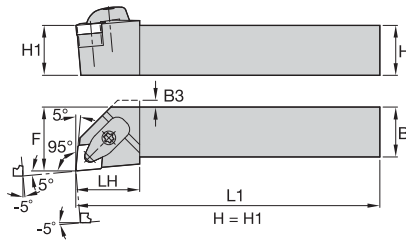

order number	catalogue number	H	B	F	L1	LH	B3	gage insert
right hand								
5564319	DCLNR124BKC3	.75	.75	1.000	4.50	1.25	.15	CN..432
5564321	DCLNR164DKC3	1.00	1.00	1.250	6.00	1.25	—	CN..432
5564322	DCLNR165DKC4	1.00	1.00	1.250	6.00	1.38	—	CN..543
5564323	DCLNR166DKC4	1.00	1.00	1.250	6.00	1.38	—	CN..643
5564324	DCLNR204DKC3	1.25	1.25	1.500	6.00	1.25	—	CN..432
5564325	DCLNR205DKC4	1.25	1.25	1.500	6.00	1.38	—	CN..543
5564326	DCLNR206DKC4	1.25	1.25	1.500	6.00	1.63	—	CN..643
5564333	DCLNR3225P12KC04	1.26	.98	1.260	6.69	1.26	—	CN..120408
5564327	DCLNR244DKC3	1.50	1.50	2.000	6.00	1.25	—	CN..432
5564328	DCLNR245DKC4	1.50	1.50	2.000	6.00	1.38	—	CN..543
left hand								
5564295	DCLNL123BKC3	.75	.75	1.000	4.50	1.12	.06	CN..322
5564296	DCLNL124BKC3	.75	.75	1.000	4.50	1.25	.15	CN..432
5564298	DCLNL164DKC3	1.00	1.00	1.250	6.00	1.25	—	CN..432
5564299	DCLNL165DKC4	1.00	1.00	1.250	6.00	1.38	—	CN..543
5564310	DCLNL166DKC4	1.00	1.00	1.250	6.00	1.63	—	CN..643
5564311	DCLNL204DKC3	1.25	1.25	1.500	6.00	1.25	—	CN..432
5564312	DCLNL205DKC4	1.25	1.25	1.500	6.00	1.38	—	CN..543
5564313	DCLNL206DKC4	1.25	1.25	1.500	6.00	1.63	—	CN..643
5564331	DCLNL3225P12KC04	1.26	.98	1.260	6.69	1.26	—	CN..120408
5564315	DCLNL244DKC3	1.50	1.50	2.000	6.00	1.25	—	CN..432
5564316	DCLNL245DKC4	1.50	1.50	2.000	6.00	1.38	—	CN..543

DCRN 75°

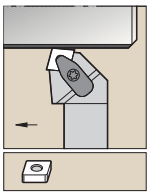

See pages E28–E42, E145, E159, E168–E169 for inserts.

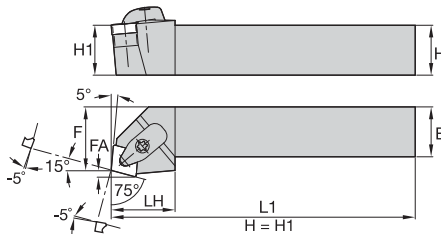

order number	catalogue number	H	B	F	L1	LH	FA	gage insert
right hand								
5697904	DCRNR2525M12KC04	25	25	32,0	150	32,0	3,3	CN..120408
left hand								
5697900	DCRNL2525M12KC04	25	25	32,0	150	32,0	3,3	CN..120408
5697902	DCRNL3232P16KC06	32	32	40,0	170	38,0	4,1	CN..160612

External Machining • D-Style Toolholders for Negative Inserts

INDEXABLE MILLING

SOLID END MILLING

DCSN 45°

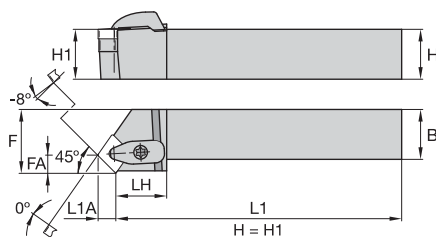
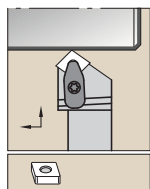

See pages E28–E42,
E145, E159, E168–
E169 for inserts.

order number	catalogue number	H	B	F	L1	LH	FA	L1A	gage insert
right hand									
5697913	DCSNR2525M12KC04	25	25	32,0	150	35,0	8,2	8,5	CN..120408

HOLEMAKING

TAPPING

TURNING

DDJN 93°

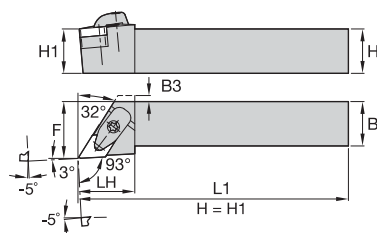
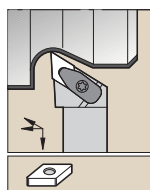

See pages E49–E60,
E147, E162, E172–
E173 for inserts.

order number	catalogue number	H	B	F	L1	LH	B3	gage insert
right hand								
5697924	DDJNR2020K11KC04	20	20	25,0	125	30,0	2,0	DN..110408
5697926	DDJNR2020K15KC06	20	20	25,0	125	32,0	4,0	DN..150608
5697928	DDJNR2525M11KC04	25	25	32,0	150	30,0	—	DN..110408
5697930	DDJNR2525M15KC06	25	25	32,0	150	32,0	—	DN..150608
5697932	DDJNR3225P15KC06	32	25	32,0	170	32,0	—	DN..150608
5564336	DDJNR3232P15KC06	32	32	40,0	170	32,0	—	DN..150608
left hand								
5697915	DDJNL2020K11KC04	20	20	25,0	125	30,0	2,0	DN..110408
5697916	DDJNL2020K15KC06	20	20	25,0	125	32,0	4,0	DN..150608
5697918	DDJNL2525M11KC04	25	25	32,0	150	30,0	—	DN..110408
5697920	DDJNL2525M15KC06	25	25	32,0	150	32,0	—	DN..150608
5697922	DDJNL3225P15KC06	32	25	32,0	170	32,0	—	DN..150608
5564335	DDJNL3232P15KC06	32	32	40,0	171	32,0	—	DN..150608

DDNN 63°

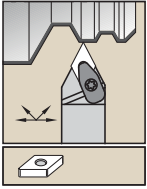

See pages E49–E60,
E147, E162, E172–E173
for inserts.

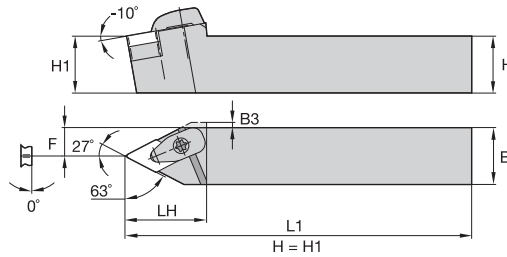

order number	catalogue number	H	B	F	L1	LH	B3	gage insert
right hand								
5697940	DDNNR2020K15KC06	20	20	10,0	125	40,0	2,5	DN..150608
5697942	DDNNR2525M15KC06	25	25	13,0	150	40,0	—	DN..150608
left hand								
5697936	DDNNL2525M15KC06	25	25	13,0	150	40,0	—	DN..150608
5697938	DDNNL3225P15KC06	32	25	13,0	170	40,0	—	DN..150608

DRGN

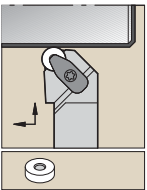

See pages E62–
E63 for inserts.

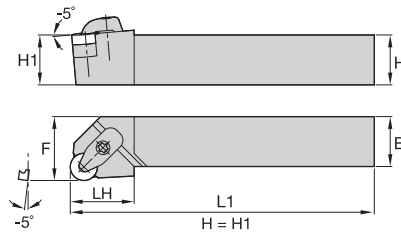

order number	catalogue number	H	B	F	L1	LH	gage insert
right hand							
5697948	DRGNR2525M12KC04	25	25	32,0	150	32,0	RN..120400

DSDN 45°

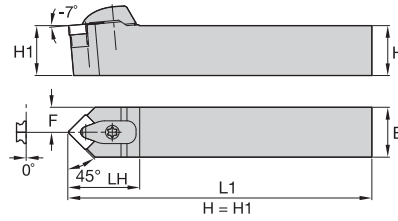
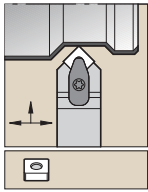

See pages E67–E78, E153, E174 for inserts.

order number	catalogue number	H	B	F	L1	LH	gage insert
neutral hand							
5697954	DSDNN2020K12KC04	20	20	10,0	125	36,0	SN..120408
5697955	DSDNN2525M12KC04	25	25	12,0	150	36,0	SN..120408
5697959	DSDNN3225P12KC04	32	25	12,0	170	36,0	SN..120408
5697961	DSDNN3232P19KC06	32	32	15,5	170	44,0	SN..190612
5697963	DSDNN4040S25KC09	40	40	19,5	250	59,0	SN..250924

DSKN 75°

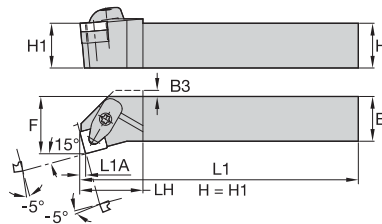
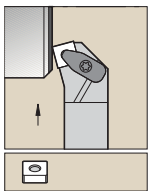

See pages E67–E78, E153, E174 for inserts.

order number	catalogue number	H	B	F	L1	LH	L1A	B3	gage insert
right hand									
5696686	DSKNR2525M12KC04	25	25	32,0	150	32,0	3,1	4,0	SN..120408
5696688	DSKNR3232P15KC06	32	32	40,0	170	32,0	3,8	–	SN..150612

DSRN 75°

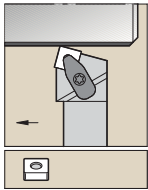

See pages E67–E78, E153, E174 for inserts.

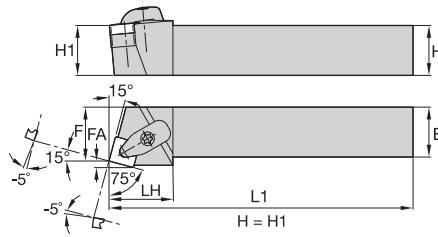

order number	catalogue number	H	B	F	L1	LH	FA	gage insert
right hand								
5696704	DSRNR2525M12KC04	25	25	27,0	150	32,0	3,3	SN..120408
5696706	DSRNR3232P19KC06	32	32	35,0	170	42,0	4,8	SN..190612
left hand								
5696700	DSRNL2525M12KC04	25	25	27,0	150	32,0	3,3	SN..120408
5696701	DSRNL3232P15KC06	32	32	35,0	170	38,0	4,0	SN..150612

DSSN 45°

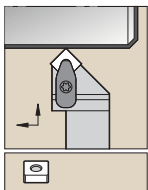

See pages E67–E78, E153, E174 for inserts.

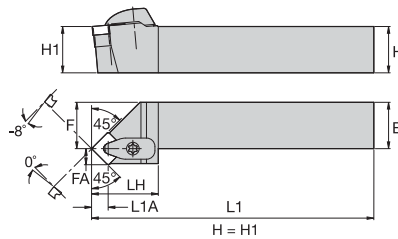

order number	catalogue number	H	B	F	L1	LH	FA	L1A	gage insert
right hand									
5696713	DSSNR2020K12KC04	20	20	25,0	125	36,0	8,4	8,7	SN..120408
5696714	DSSNR2525M12KC04	25	25	32,0	150	36,0	8,4	8,7	SN..120408
5696718	DSSNR3232P19KC06	32	32	40,0	170	44,0	12,7	10,7	SN..190612

DTGN 90°

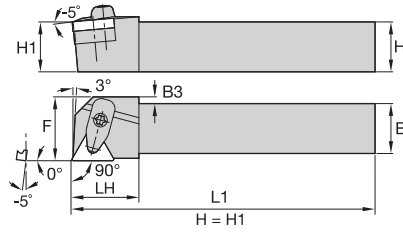
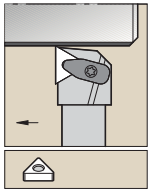

See pages E86–E95, E155, E164, E175 for inserts.

order number	catalogue number	H	B	F	L1	LH	B3	gage insert
right hand								
5696729	DTGNR2020K16KC04	20	20	25,0	125	25,0	6,5	TN..160408
5696730	DTGNR2525M16KC04	25	25	32,0	150	25,0	–	TN..160408
left hand								
5696728	DTGNL2525M16KC04	25	25	32,0	150	25,0	–	TN..160408

DVJN 93°

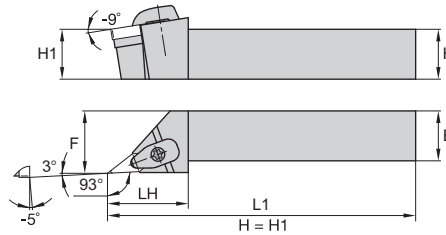
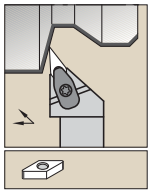

See pages E102–E108, E157, E166, E177 for inserts.

order number	catalogue number	H	B	F	L1	LH	gage insert
right hand							
5696737	DVJNR2020K16KC04	20	20	25,0	125	46,0	VN..160408
5696738	DVJNR2525M16KC04	25	25	32,0	150	46,0	VN..160408
5696740	DVJNR3225P16KC04	32	25	32,0	170	46,0	VN..160408
left hand							
5696732	DVJNL2020K16KC04	20	20	25,0	125	46,0	VN..160408
5696733	DVJNL2525M16KC04	25	25	32,0	150	46,0	VN..160408
5696735	DVJNL3225P16KC04	32	25	32,0	170	46,0	VN..160408

DVON 117,5°

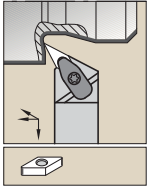

See pages E102–E108, E157, E166, E177 for inserts.

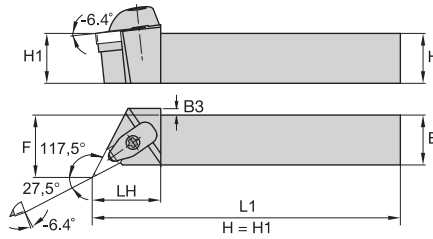

order number	catalogue number	H	B	F	L1	LH	B3	gage insert
right hand								
5696745	DVONR2020K16KC04	20	20	27,0	125	38,0	5,0	VN..160408
5696746	DVONR2525M16KC04	25	25	32,0	150	38,0	—	VN..160408
5696747	DVONR3225P16KC04	32	25	9,5	170	38,0	—	VN..160408
left hand								
5696742	DVONL2020K16KC04	20	20	27,0	125	38,0	5,0	VN..160408
5696743	DVONL2525M16KC04	25	25	32,0	150	38,0	—	VN..160408

DVON 117,5°

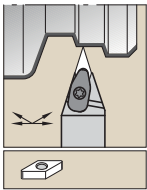

See pages E102–E108, E157, E166, E177 for inserts.

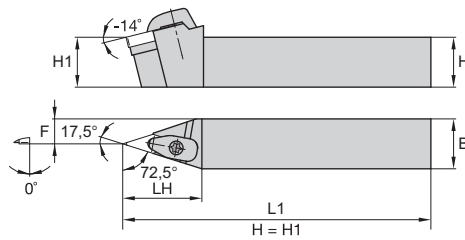

order number	catalogue number	H	B	F	L1	LH	gage insert	
neutral hand								
5696748	DVVNN2020K16KC04	20	20	10,0	125	48,0	VN..160408	
5696749	DVVNN2525M16KC04	25	25	12,0	150	48,0	VN..160408	
5696750	DVVNN3225P16KC04	32	25	12,0	170	48,0	VN..160408	

External Machining • D-Style Toolholders for Negative Inserts

INDEXABLE MILLING

SOLID END MILLING

HOLEMAKING

TAPPING

TURNING

DWLN 95°

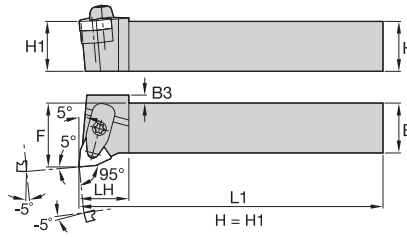
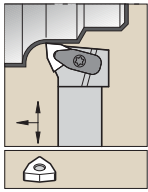

See pages E108–E116, E157, E167, E177 for inserts.

order number	catalogue number	H	B	F	L1	LH	B3	gage insert
right hand								
5696757	DWLN R2020K06KC04	20	20	25,0	125	31,0	—	WN..060408
5696758	DWLN R2020K08KC04	20	20	25,0	125	33,0	—	WN..080408
5696759	DWLN R2525M06KC04	25	25	32,0	150	25,0	—	WN..060408
5696760	DWLN R2525M08KC04	25	25	32,0	150	25,0	4,0	WN..080408
5696762	DWLN R3232P08KC04	32	32	40,0	170	25,0	—	WN..080408
left hand								
5696751	DWLN L2020K06KC04	20	20	25,0	125	31,0	—	WN..060408
5696752	DWLN L2020K08KC04	20	20	25,0	125	33,0	—	WN..080408
5696753	DWLN L2525M06KC04	25	25	32,0	150	25,0	—	WN..060408
5696754	DWLN L2525M08KC04	25	25	32,0	150	25,0	4,0	WN..080408
5696756	DWLN L3232P08KC04	32	32	40,0	170	25,0	—	WN..080408

PCBN 75°

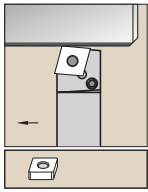

See pages E28–E42, E145, E159, E168–E169 for inserts.

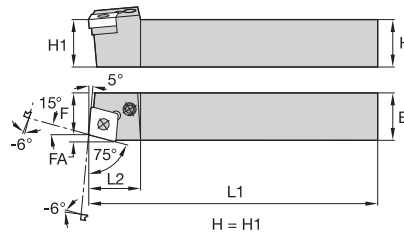

order number	catalogue number	H	B	F	L1	L2	FA	gage insert
right hand								
3878356	PCBNR2525M12	25	25	22,0	150	26,0	3,1	CN..120408
3878366	PCBNR2525M16	25	25	22,0	150	26,0	4,2	CN..160612
left hand								
3878360	PCBNL2020K12	20	20	17,0	125	26,0	3,1	CN..120408
3878354	PCBNL2525M12	25	25	22,0	150	26,0	3,1	CN..120408
3878365	PCBNL2525M16	25	25	22,0	150	26,0	4,2	CN..160612
3878355	PCBNL3232P16	32	32	27,0	170	38,0	4,2	CN..160612
3878357	PCBNL3232P19	32	32	27,0	170	40,0	4,6	CN..190612

PCKN 75°

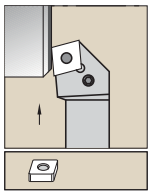

See pages E28–E42, E145, E159, E168–E169 for inserts.

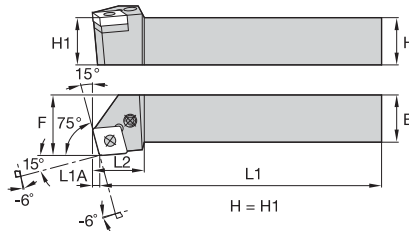

order number	catalogue number	H	B	F	L1	L2	L1A	gage insert
right hand								
3878372	PCKNR2020K12	20	20	25,0	125	23,0	3,1	CN..120408
3878370	PCKNR2525M12	25	25	32,0	150	23,0	3,1	CN..120408
3878374	PCKNR2525M16	25	25	32,0	150	30,0	3,8	CN..160612
3899889	PCKNR3232P16	32	32	40,0	170	38,0	3,8	CN..160612
left hand								
3878373	PCKNL2020K12	20	20	25,0	125	23,0	3,1	CN..120408
3878369	PCKNL2525M12	25	25	32,0	150	23,0	3,1	CN..120408
3878377	PCKNL2525M16	25	25	32,0	150	30,0	3,8	CN..160612
3899888	PCKNL3232P16	32	32	40,0	170	38,0	3,8	CN..160612
3878368	PCKNL3232P19	32	32	40,0	170	40,0	4,6	CN..190612

PCLN 95°

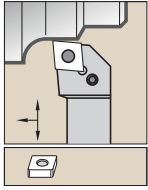

See pages E28–E42, E145, E159, E168–E169 for inserts.

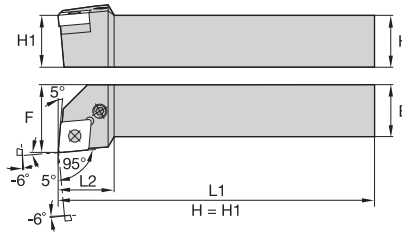

order number	catalogue number	H	B	F	L1	L2	gage insert
right hand							
3878400	PCLNR1616H12	16	16	20,0	100	26,0	CN..120408
3878422	PCLNR2020K12	20	20	25,0	125	26,0	CN..120408
3878419	PCLNR2525M12	25	25	32,0	150	26,0	CN..120408
3878401	PCLNR2525M16	25	25	32,0	150	28,0	CN..160612
3878402	PCLNR3225P12	32	25	32,0	170	26,0	CN..120408
3878421	PCLNR3225P16	32	25	32,0	170	38,0	CN..160612
3878396	PCLNR3232P16	32	32	40,0	170	36,0	CN..160612
3878414	PCLNR3232P19	32	32	40,0	170	36,0	CN..190612
3878417	PCLNR4040S19	40	40	50,0	250	36,0	CN..190612
left hand							
3878379	PCLNL1616H12	16	16	20,0	100	26,0	CN..120408
3878418	PCLNL2020K12	20	20	25,0	125	26,0	CN..120408
3878398	PCLNL2525M12	25	25	32,0	150	26,0	CN..120408
3878380	PCLNL2525M16	25	25	32,0	150	28,0	CN..160612
3878397	PCLNL3225P12	32	25	32,0	170	26,0	CN..120408
3878415	PCLNL3232P16	32	32	40,0	170	36,0	CN..160612
3878393	PCLNL3232P19	32	32	40,0	170	36,0	CN..190612
3878416	PCLNL4040S19	40	40	50,0	250	36,0	CN..190612

PDJN 93°

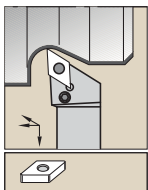

See pages E49–E60, E147, E162, E172–E173 for inserts.

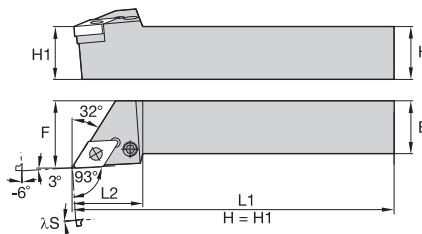

order number	catalogue number	H	B	F	L1	L2	λS°	gage insert
right hand								
3878424	PDJNR1616H11	16	16	20,0	100	22,0	-6,0	DN..110408
3878429	PDJNR2020K11	20	20	25,0	125	30,0	-7,0	DN..110408
3879318	PDJNR2020K15	20	20	25,0	125	36,0	-7,0	DN..150608
3879151	PDJNR2525M11	25	25	32,0	150	30,0	-7,0	DN..110408
3878425	PDJNR3225P15	32	25	32,0	170	38,0	-7,0	DN..150608
3879152	PDJNR3232P15	32	32	40,0	170	38,0	-7,0	DN..150608
3878426	PDJNR4025R15	40	25	32,0	200	38,0	-7,0	DN..150608
left hand								
3878427	PDJNL2020K11	20	20	25,0	125	30,0	-7,0	DN..110408
3879317	PDJNL2020K15	20	20	25,0	125	36,0	-7,0	DN..150608
3878428	PDJNL2525M11	25	25	32,0	150	30,0	-7,0	DN..110408
3879314	PDJNL2525M15	25	25	32,0	150	—	-7,0	DN..150608
3878423	PDJNL3225P15	32	25	32,0	170	38,0	-7,0	DN..150608
3879315	PDJNL3232P15	32	32	40,0	170	38,0	-7,0	DN..150608

PDNN 62,5°

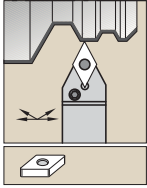

See pages E49–E60, E147, E162, E172–E173 for inserts.

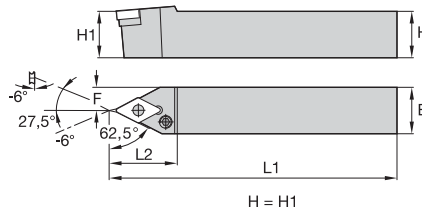

order number	catalogue number	H	B	F	L1	L2	gage insert
right hand							
3879319	PDNNR2525M15	25	25	12,5	150	36,0	DN..150608
left hand							
3879320	PDNNL2525M15	25	25	12,5	150	36,0	DN..150608

PSBN 75°

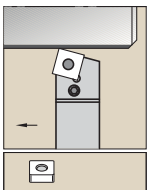

See pages E67–E78, E153, E174 for inserts.

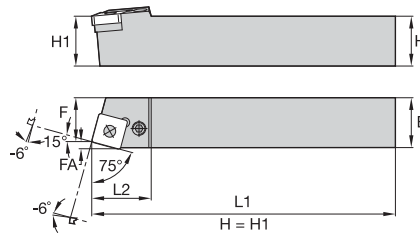

order number	catalogue number	H	B	F	L1	L2	FA	gage insert
right hand								
3879324	PSBNR2020K12	20	20	17,0	125	26,0	3,1	SN..120408
3879327	PSBNR3232P19	32	32	27,0	170	40,0	4,6	SN..190612
3879334	PSBNR4040S19	40	40	35,0	250	38,0	4,6	SN..190612
3879331	PSBNR4040S25	40	40	35,0	250	47,0	5,9	SN..250724
left hand								
3879329	PSBNL2525M15	25	25	22,0	150	36,0	3,8	SN..150612
3879328	PSBNL3232P19	32	32	27,0	170	40,0	4,6	SN..190612
3879323	PSBNL4040S19	40	40	35,0	250	38,0	4,6	SN..190612
3879326	PSBNL4040S25	40	40	35,0	250	47,0	5,9	SN..250724
3900159	PSBNL5050T25	50	50	43,0	300	50,0	—	SN..250724

PSDN 45°

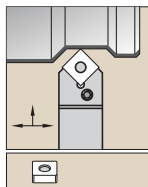

See pages E67–E78, E153, E174 for inserts.

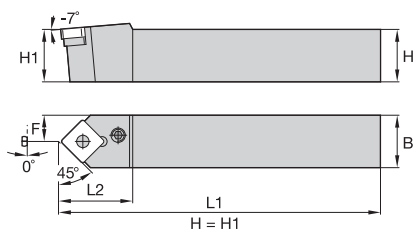

order number	catalogue number	H	B	F	L1	L2	gage insert
neutral hand							
3879335	PSDNN2020K12	20	20	10,0	125	26,0	SN..120408
3879337	PSDNN2525M12	25	25	12,5	150	26,0	SN..120408
3900161	PSDNN3232P15	32	32	16,0	170	33,0	SN..150612
3879338	PSDNN4040S25	40	40	20,0	250	47,0	SN..250724

PSKN 75°

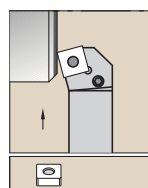

See pages E67–E78, E153, E174 for inserts.

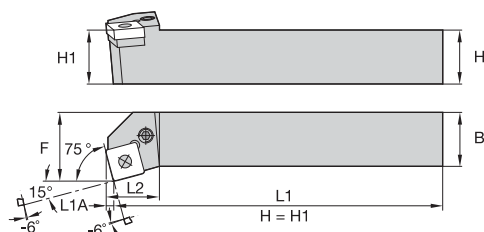

order number	catalogue number	H	B	F	L1	L2	L1A	gage insert
right hand								
3879340	PSKNR2020K12	20	20	25,0	125	23,0	3,1	SN..120408
3879341	PSKNR2525M12	25	25	32,0	150	23,0	3,1	SN..120408
3879710	PSKNR4040S19	40	40	50,0	250	37,5	4,6	SN..190612
left hand								
3879345	PSKNL4040S19	40	40	50,0	250	37,5	4,6	SN..190612

PSSN 45°

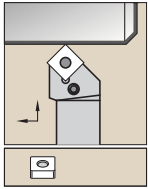

See pages E67–E78, E153, E174 for inserts.

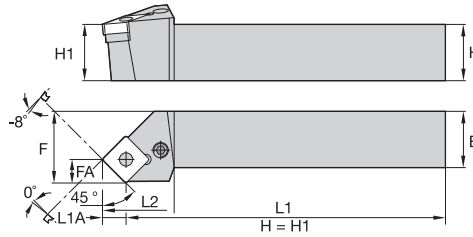

order number	catalogue number	H	B	F	L1	L2	FA	L1A	gage insert
right hand									
3879351	PSSNR1616H09	16	16	20,0	100	23,0	6,1	6,1	SN..090308
3879348	PSSNR2020K12	20	20	25,0	125	28,0	8,3	9,6	SN..120408
3879352	PSSNR2525M12	25	25	32,0	150	28,0	8,3	9,6	SN..120408
3879349	PSSNR2525M15	25	25	32,0	150	32,0	10,2	10,2	SN..150612
3879360	PSSNR3225P12	32	25	32,0	170	29,0	8,3	9,6	SN..120408
3879362	PSSNR3225P15	32	25	32,0	170	32,0	10,2	10,2	SN..150612
3879354	PSSNR3232P15	32	32	40,0	170	32,0	10,0	11,5	SN..150612
3879350	PSSNR3232P19	32	32	40,0	170	37,5	12,5	13,7	SN..190612
3879361	PSSNR4040S19	40	40	50,0	250	37,5	12,5	12,5	SN..190612
left hand									
3879347	PSSNL2020K12	20	20	25,0	125	28,0	8,3	9,6	SN..120408
3879353	PSSNL2525M12	25	25	32,0	150	28,0	8,3	9,6	SN..120408
3879358	PSSNL3225P12	32	25	32,0	170	29,0	8,3	9,6	SN..120408
3879356	PSSNL3232P19	32	32	40,0	170	37,5	12,5	13,7	SN..190612
3879357	PSSNL4040S19	40	40	50,0	250	37,5	12,5	12,5	SN..190612
3879711	PSSNL4040S25	40	40	50,0	250	50,0	16,0	16,0	SN..250724

PTFN 90°

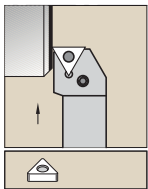

See pages E86–E95, E155, E164, E175 for inserts.

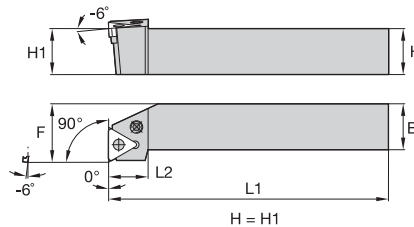

order number	catalogue number	H	B	F	L1	L2	gage insert
right hand							
3879367	PTFNR2020K16	20	20	25,0	125	20,0	TN..160408
left hand							
3879366	PTFNL2020K16	20	20	25,0	125	20,0	TN..160408

External Machining • P-Style Toolholders for Negative Inserts

INDEXABLE MILLING

SOLID END MILLING

HOLEMAKING

TAPPING

TURNING

PTGN 90°

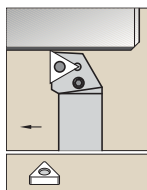

See pages E86–E95, E155, E164, E175 for inserts.

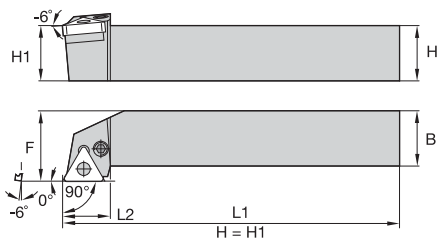

order number	catalogue number	H	B	F	L1	L2	gage insert
right hand							
3879385	PTGNR1616H16	16	16	20,0	100	20,0	TN..160408
3879389	PTGNR2020K16	20	20	25,0	125	20,0	TN..160408
3879390	PTGNR2525M16	25	25	32,0	150	20,0	TN..160408
3879387	PTGNR2525M22	25	25	32,0	150	26,0	TN..220408
3879846	PTGNR3225P22	32	25	32,0	170	28,0	TN..220408
3900163	PTGNR4040T27	40	40	50,0	300	31,0	TN..270612
left hand							
3879388	PTGNL2525M16	25	25	32,0	150	20,0	TN..160408
3879386	PTGNL2525M22	25	25	32,0	150	26,0	TN..220408
3879392	PTGNL3232P22	32	32	40,0	170	26,0	TN..220408
3900162	PTGNL4040T27	40	40	50,0	300	31,0	TN..270612

PWLN 95°

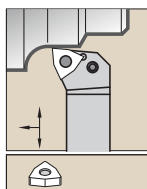

See pages E108–E116, E157, E167, E177 for inserts.

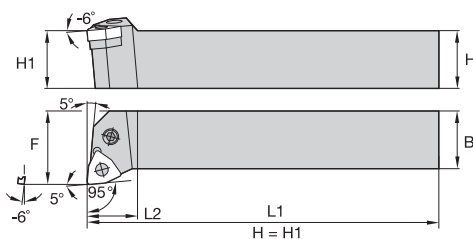

order number	catalogue number	H	B	F	L1	L2	gage insert
right hand							
3879405	PWLN1616H06	16	16	20,0	100	14,0	WN..060408
3879407	PWLN1616H06	20	20	25,0	125	14,0	WN..060408
3879408	PWLN1616H06	20	20	25,0	125	20,0	WN..080408
3900167	PWLN1616H06	25	25	32,0	150	20,0	WN..060408
3879409	PWLN1616H06	25	25	32,0	150	26,0	WN..080408
3900164	PWLN1616H06	32	32	40,0	170	26,0	WN..080408
left hand							
3879403	PWLN1616H06	20	20	25,0	125	20,0	WN..080408
3900166	PWLN1616H06	25	25	32,0	150	20,0	WN..060408
3879404	PWLN1616H06	25	25	32,0	150	26,0	WN..080408
3900165	PWLN1616H06	32	32	40,0	170	26,0	WN..080408

CCLN-MX 95°

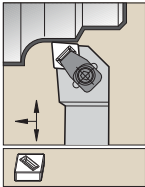

See page E146 for inserts.

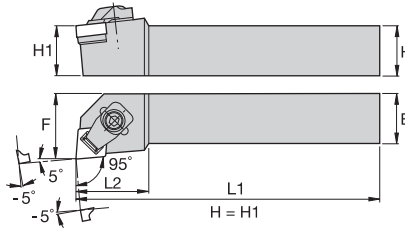

order number	catalogue number	H	B	F	L1	L2	gage insert
right hand 3032691	CCLNR2525M12MX7	25	25	32,0	150	32,0	CN.X120708

NOTE: MX – clamping version is shown.

CCLN-MN 95°

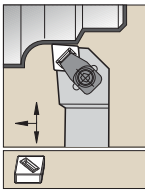

See page E146 for inserts.

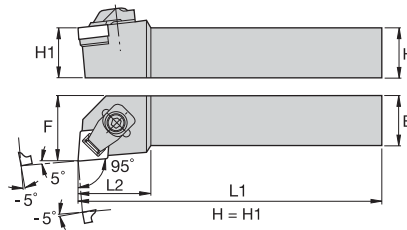

order number	catalogue number	H	B	F	L1	L2	gage insert
right hand 3032715	CCLNR2525M12MN4	25	25	32,0	150	32,0	CN.N120408

NOTE: MX – clamping version is shown.

CRSN-MN

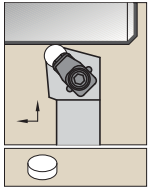

See pages E150, E173 for inserts.

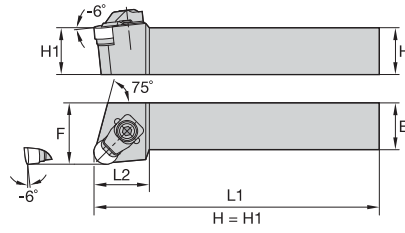

order number	catalogue number	H	B	F	L1	L2	gage insert
right hand							
3032677	CRSNR2525M12MN7	25	25	32,0	150	26,0	RN.N120700
3032675	CRSNR3225P12MN4	32	25	32,0	170	26,0	RN.N120400
left hand							
3032676	CRSNL3225P12MN4	32	25	32,0	170	26,0	RN.N120400
3032680	CRSNL3225P12MN7	32	25	32,0	170	26,0	RN.N120700

NOTE: MN – clamping version is shown.

CRDN-MN

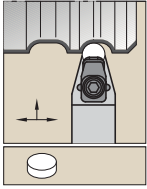

See pages E150, E173 for inserts.

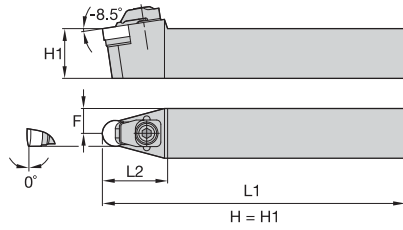

order number	catalogue number	H	B	F	L1	L2	gage insert
neutral hand							
3032549	CRDNN2525M12MN4	25	25	12,5	150	30,0	RN.N120400
3032551	CRDNN2525M12MN7	25	25	12,5	150	30,0	RN.N120700
3032550	CRDNN3225P12MN4	32	25	12,5	170	30,0	RN.N120400
3032552	CRDNN3225P12MN7	32	25	12,5	170	30,0	RN.N120700

NOTE: MN — clamping version is shown.

MTEN-S 60°

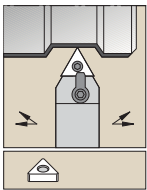

See pages E86-E95, E155, E164, E175 for inserts.

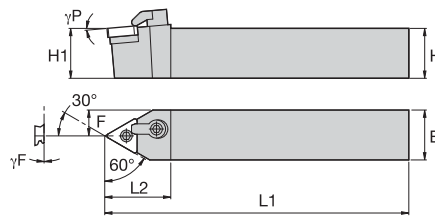

NOTE: H = H1

order number	catalogue number	H	B	F	L1	L2	γF°	γP°	gage insert
neutral hand									
3852753	MTENNS3225P22	32	25	12,3	170	35,0	0.0	-10.0	TN..220408

MWLN 95°

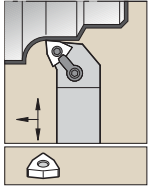

See pages E108–E116, E157, E167, E177 for inserts.

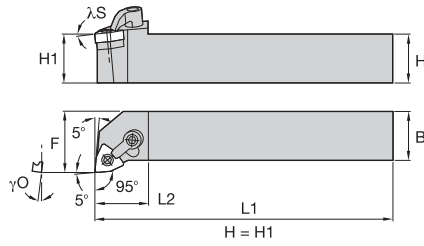

order number	catalogue number	H	B	F	L1	λS°	γO°	gage insert
left hand								
2023778	MWLN3232P08	32	32	40,0	170	-5	-5	WN..0804..

CSBP 75°

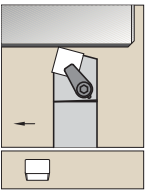

See pages E79, E81–E82, E154 for inserts.

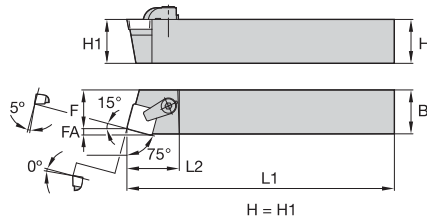

order number	catalogue number	H	B	F	L1	L2	FA	gage insert
right hand								
3870069	CSBPR2525M12	25	25	22,0	150	30,0	3,1	SP..120308

CSDP 45°

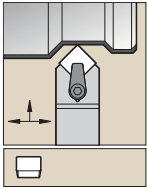

See pages E79, E81–E82, E154 for inserts.

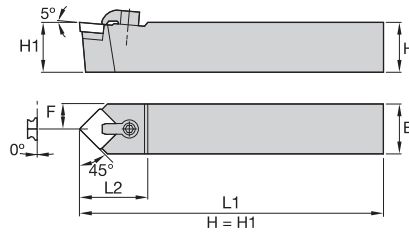

order number	catalogue number	H	B	F	L1	L2	gage insert
neutral hand							
3870071	CSDPN2020K12	20	20	10,0	125	32,0	SP..120308
3870072	CSDPN2525M12	25	25	12,5	150	32,0	SP..120308

CSSP 45°

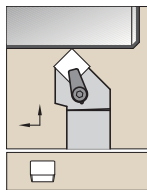

See pages E79, E81–E82, E154 for inserts.

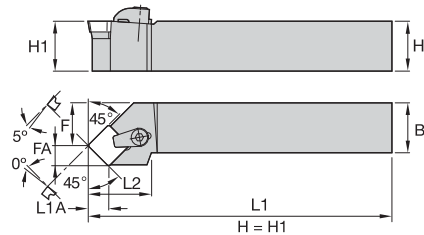

order number	catalogue number	H	B	F	L1	L2	FA	L1A	gage insert
right hand									
3870074	CSSPR2020K12	20	20	25,0	125	32,0	8,7	8,3	SP..120308

CTCPN 90°

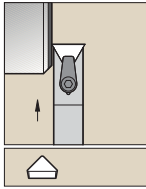

See pages E96, E98, E165 for inserts.

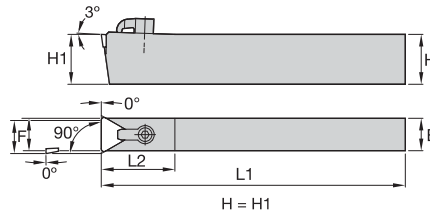

order number	catalogue number	H	B	F	L1	L2	gage insert
neutral hand 3870076	CTCPN2510M11	25	10	10,0	150	26,0	TP..110304

CTDTP 45°

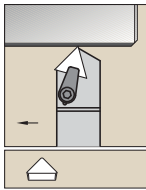

See pages E96, E98, E165 for inserts.

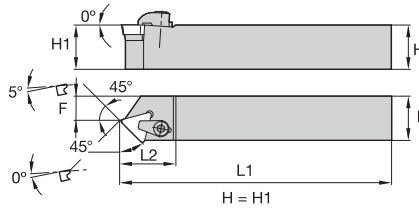

order number	catalogue number	H	B	F	L1	L2	gage insert
right hand 3870083	CTDPR1212F11	12	12	6,0	80	22,0	TP..110304

CTGP 90°

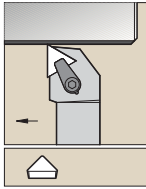

See pages E96, E98, E165 for inserts.

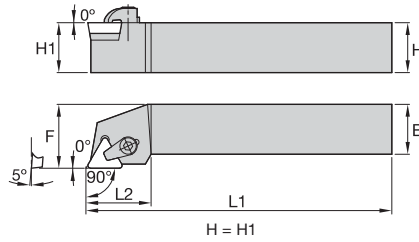

order number	catalogue number	H	B	F	L1	L2	gage insert
right hand							
3870092	CTGPR1212F11	12	12	16,0	80	20,0	TP..110304
3870104	CTGPR2020K11	20	20	25,0	125	20,0	TP..110304
3870105	CTGPR2020K16	20	20	25,0	125	26,0	TP..160308
3870106	CTGPR2525M16	25	25	32,0	150	26,0	TP..160308

CRDP

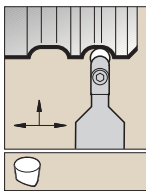

See page E151 for inserts.

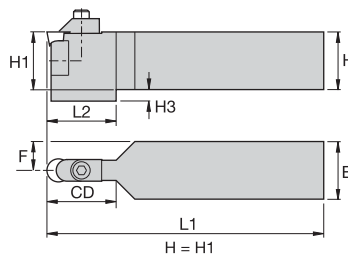

order number	catalogue number	H	B	F	L1	L2	H3	CD	gage insert
neutral hand									
3871510	CRDPN2525M06V	25	25	12,5	150	—	—	19,0	R..X060400E
3871511	CRDPN2525M09V	25	25	12,5	150	—	—	29,0	R..X090700E
3871513	CRDPN2525M12V	25	25	12,5	150	38,1	6,4	38,0	R..X120700E

NOTE: CRDP toolholders are able to use RPGX and RCGX insert styles.

SVN 72.5°

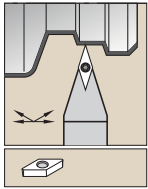

See pages E67–E78, E153, E174 for inserts.

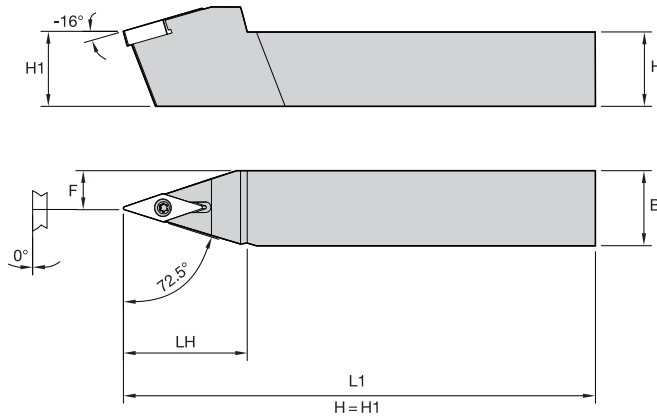

order number	catalogue number	H	B	F	L1	γ_F°	γ_P°	gage insert
neutral hand								
2552265	SVN2020K12	.79	.79	.394	4.92	0.0	-16.0	VNM..12T304
2552264	SVN2525M12	.98	.98	.492	5.91	0.0	-16.0	VNM..12T304

SVJN 93°

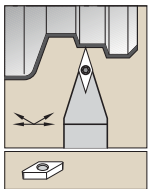

See pages E67–E78, E153, E174 for inserts.

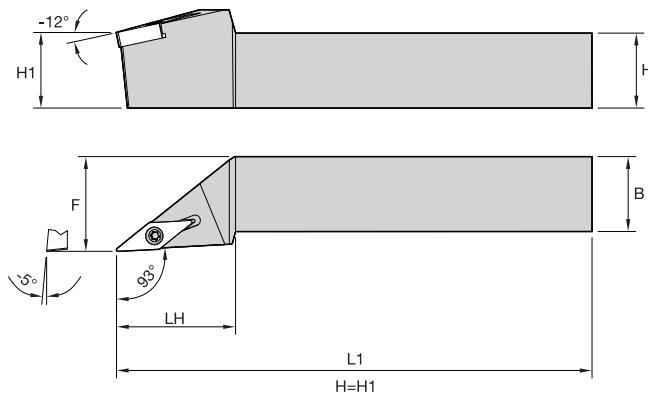

order number	catalogue number	H	B	F	L1	γ_F°	γ_P°	gage insert
right hand								
2552272	SVJNR1616H12	.63	.63	.787	3.94	-5.0	-12.0	VNM..12T304
2552270	SVJNR2020K12	.79	.79	.984	4.92	-5.0	-12.0	VNM..12T304
2552268	SVJNR2525M12	.98	.98	1.260	5.91	-5.0	-12.0	VNM..12T304
left hand								
2552269	SVJNL2020K12	.79	.79	.984	4.92	-5.0	-12.0	VNM..12T304
2552267	SVJNL2525M12	.98	.98	1.260	5.91	-5.0	-12.0	VNM..12T304

SCLC 95°

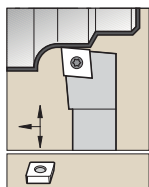

See pages E22–E27, E122, E158, E167–E168 for inserts.

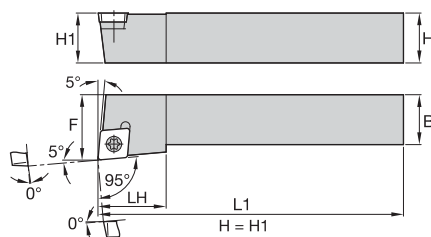

order number	catalogue number	H	B	F	L1	LH	gage insert
right hand							
3900169	SCLCR1010E06	10	10	12,0	70	—	CC..060204
3900172	SCLCR1212F06	12	12	16,0	80	—	CC..060204
3900170	SCLCR1212F09	12	12	16,0	80	—	CC..09T308
3879416	SCLCR1616H09	16	16	20,0	100	15,8	CC..09T308
3879417	SCLCR2020K09	20	20	25,0	125	15,8	CC..09T308
3879414	SCLCR2020K12	20	20	25,0	125	19,8	CC..120408
3879418	SCLCR2525M12	25	25	32,0	150	20,0	CC..120408
left hand							
3900171	SCLCL1010E06	10	10	12,0	70	—	CC..060204
3900168	SCLCL1212F09	12	12	16,0	80	16,0	CC..09T308
3879411	SCLCL1616H09	16	16	20,0	100	15,8	CC..09T308
3879412	SCLCL2020K09	20	20	25,0	125	15,8	CC..09T308
3879415	SCLCL2020K12	20	20	25,0	125	19,8	CC..120408
3879413	SCLCL2525M12	25	25	32,0	150	20,0	CC..120408

SDHC 107,5°

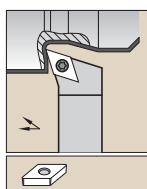

See pages E44–E48, E123, E161, E170–E171 for inserts.

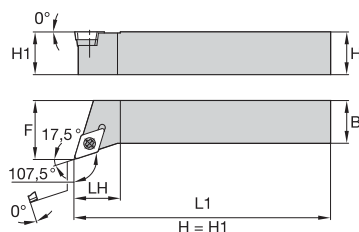

order number	catalogue number	H	B	F	L1	LH	gage insert
right hand							
3879435	SDHCR1616H11	16	16	20,0	100	20,0	DC..11T308
3879437	SDHCR2020K11	20	20	25,0	125	20,0	DC..11T308
3879440	SDHCR2525M11	25	25	32,0	150	20,0	DC..11T308
3879436	SDHCR2525M15	25	25	32,0	150	25,0	DC..150408
left hand							
3879433	SDHCL1616H11	16	16	20,0	100	20,0	DC..11T308
3879439	SDHCL2020K11	20	20	25,0	125	20,0	DC..11T308
3879438	SDHCL2525M11	25	25	32,0	150	20,0	DC..11T308
3879434	SDHCL2525M15	25	25	32,0	150	25,0	DC..150408

SDJC 93°

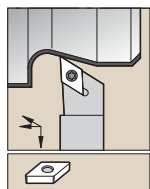

See pages E44–E48, E123, E161, E170–E171 for inserts.

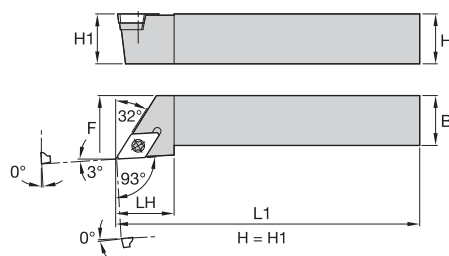

order number	catalogue number	H	B	F	L1	LH	gage insert
right hand							
3879464	SDJCR1010M07	10	10	12,0	150	16,0	DC..070204
3899890	SDJCR1212F07	12	12	16,0	80	—	DC..070204
3900177	SDJCR1212F11	12	12	16,0	80	—	DC..11T308
3879456	SDJCR1616H07	16	16	20,0	100	16,0	DC..070204
3879459	SDJCR1616H11	16	16	20,0	100	22,0	DC..11T308
3879458	SDJCR2020K07	20	20	25,0	125	16,0	DC..070204
3879460	SDJCR2020K11	20	20	25,0	125	22,0	DC..11T308
3879457	SDJCR2020K15	20	20	25,0	125	32,0	DC..150408
3879461	SDJCR2525M11	25	25	32,0	150	22,1	DC..11T308
3879463	SDJCR2525M15	25	25	32,0	150	32,0	DC..150408
3900175	SDJCR3225P15	32	25	32,0	170	—	DC..150408
left hand							
3899892	SDJCL1010E07	10	10	12,0	70	—	DC..070204
3899891	SDJCL1212F07	12	12	16,0	80	—	DC..070204
3900176	SDJCL1212F11	12	12	16,0	80	—	DC..11T308
2024450	SDJCL1616H11	16	16	20,0	100	—	DC..11T3..
3879454	SDJCL1616H11	16	16	20,0	100	22,0	DC..11T308
3879442	SDJCL2020K07	20	20	25,0	125	16,0	DC..070204
3879462	SDJCL2020K11	20	20	25,0	125	22,0	DC..11T308
3879453	SDJCL2525M11	25	25	32,0	150	22,1	DC..11T308
3879455	SDJCL2525M15	25	25	32,0	150	32,0	DC..150408
3900174	SDJCL3225P15	32	25	32,0	170	—	DC..150408

SDNC 62,5°

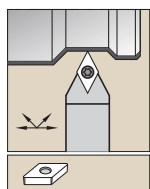

See pages E44–E48, E123, E161, E170–E171 for inserts.

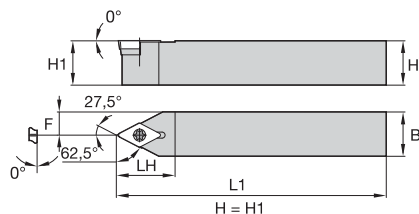

order number	catalogue number	H	B	F	L1	LH	gage insert
neutral hand							
3879468	SDNCN0808L07	8	8	4,0	140	16,0	DC..070204
3900178	SDNCN1212F11	12	12	6,0	80	—	DC..11T308
3879465	SDNCN1616H11	16	16	8,0	100	22,0	DC..11T308
3879467	SDNCN2020K11	20	20	10,0	125	22,0	DC..11T308
3879849	SDNCN2525M11	25	25	12,5	150	24,9	DC..11T308
3879466	SDNCN2525M15	25	25	12,5	150	28,0	DC..150408
3900179	SDNCN3225P15	32	25	12,5	170	—	DC..150408

SRDC

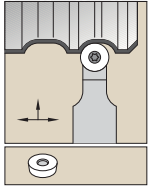

See pages E61–E62,
E123 for inserts.

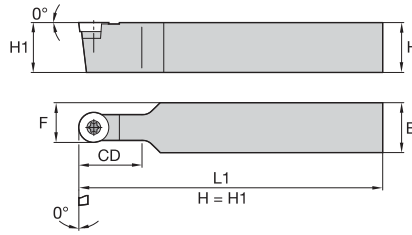

order number	catalogue number	H	B	F	L1	CD	gage insert
neutral hand							
3879735	SRDCN1616H06	16	16	11,0	100	16,0	RC..0602M0
3879702	SRDCN1616H08	16	16	12,0	100	16,0	RC..0803M0
3900182	SRDCN2020K06	20	20	12,5	125	19,7	RC..0602M0
3879733	SRDCN2020K08	20	20	14,0	125	20,0	RC..0803M0
3879736	SRDCN2020K10	20	20	15,0	125	20,0	RC..10T3M0
3900183	SRDCN2525M06	25	25	15,0	150	19,7	RC..0602M0
3879737	SRDCN2525M08	25	25	16,5	150	25,0	RC..0803M0
3879734	SRDCN2525M10	25	25	17,5	150	25,0	RC..10T3M0
3879738	SRDCN2525M12	25	25	18,5	150	25,0	RC..1204M0
3900181	SRDCN3225P12	32	25	8,0	170	28,0	RC..1204M0
3900180	SRDCN3225P16	32	25	20,0	170	35,0	RC..1605M0

SSBC 75°

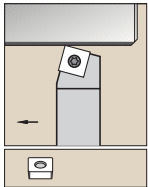

See pages E64–
E67 for inserts.

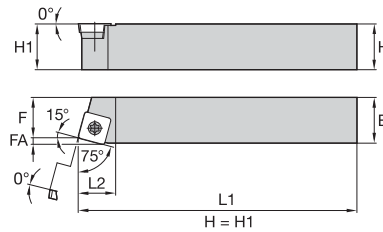

order number	catalogue number	H	B	F	L1	L2	FA	gage insert
right hand								
3879741	SSBCR2020K12	20	20	17,0	125	—	3,1	SC..120408
3879740	SSBCR2525M12	25	25	22,0	150	21,0	3,1	SC..120408
left hand								
3879739	SSBCL1616H09	16	16	13,0	100	16,0	2,2	SC..09T308
3879852	SSBCL2020K12	20	20	17,0	125	—	3,1	SC..120408

SSSC 45°

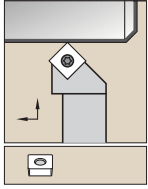

See pages E64–E67 for inserts.

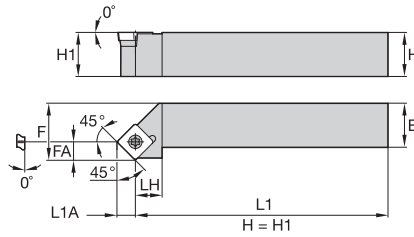

order number	catalogue number	H	B	F	L1	LH	FA	L1A	gage insert
right hand									
3879747	SSSCR1616H09	16	16	20,0	100	18,0	6,1	6,1	SC..09T308
3879746	SSSCR2020K12	20	20	25,0	125	25,0	8,3	8,3	SC..120408
3879744	SSSCR2525M12	25	25	32,0	150	25,0	8,3	8,3	SC..120408
left hand									
3879742	SSSCL2525M12	25	25	32,0	150	25,0	8,3	8,3	SC..120408

STFC 90°

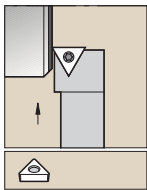

See pages E83–E85, E124, E163–E164, E175 for inserts.

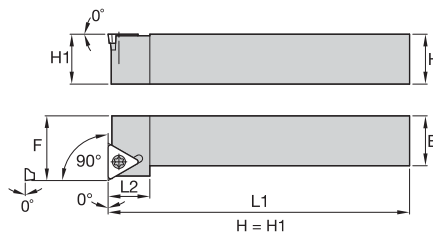

order number	catalogue number	H	B	F	L1	L2	gage insert
right hand							
3879763	STFCR2020K16	20	20	25,0	125	20,0	TC..16T308
3879750	STFCR2525M16	25	25	32,0	150	20,0	TC..16T308
left hand							
3879752	STFCL2525M16	25	25	32,0	150	20,0	TC..16T308

SVHB 107,5°

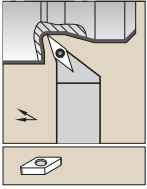

See pages E99–E101, E125, E166, E176 for inserts.

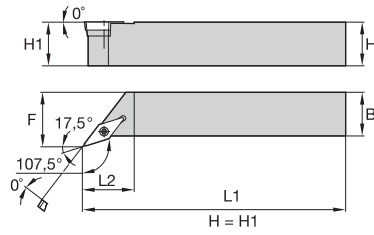

order number	catalogue number	H	B	F	L1	L2	gage insert
right hand							
3879767	SVHBR2020K16	20	20	25,0	125	28,0	VB..160408
3879765	SVHBR2525M16	25	25	32,0	150	28,0	VB..160408
3879853	SVHBR3225P16	32	25	32,0	170	25,0	VB..160408
left hand							
3879764	SVHBL2020K16	20	20	25,0	125	28,0	VB..160408
3879766	SVHBL2525M16	25	25	32,0	150	28,0	VB..160408
3879768	SVHBL3225P16	32	25	32,0	170	25,0	VB..160408

SVJB 93°

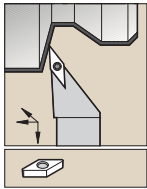

See pages E99–E101, E125, E166, E176 for inserts.

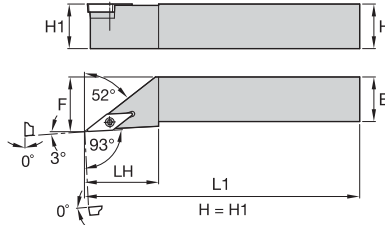

order number	catalogue number	H	B	F	L1	LH	gage insert
right hand							
3879769	SVJBR1616H16	16	16	20,0	100	35,0	VB..160408
3879776	SVJBR2020K16	20	20	25,0	125	35,0	VB..160408
3879775	SVJBR2525M16	25	25	32,0	150	35,0	VB..160408
3879773	SVJBR3225P16	32	25	32,0	170	35,0	VB..160408
left hand							
3879772	SVJBL1616H16	16	16	20,0	100	35,0	VB..160408
3879770	SVJBL2020K16	20	20	25,0	125	35,0	VB..160408
3879774	SVJBL2525M16	25	25	32,0	150	35,0	VB..160408
3879771	SVJBL3225P16	32	25	32,0	170	35,0	VB..160408

SVVB 72,5°

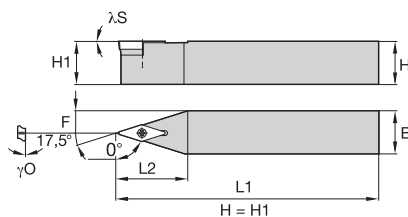
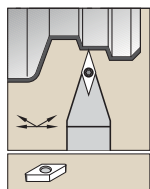

See pages E99–E101, E125, E166, E176 for inserts.

order number	catalogue number	H	B	F	L1	L2	gage insert
neutral hand							
3879777	SVBN2020K16	20	20	10,0	125	33,0	VB..160408
3879778	SVBN2525M16	25	25	12,5	150	33,0	VB..160408
3879779	SVBN3225P16	32	25	12,5	170	33,0	VB..160408



Tools for Internal Boring

Boring Bars

WIDIA™ offers an extensive range of toolholders for internal boring to meet even the most precise production demands across a broad spectrum of workpiece shapes and sizes.



WIDIA boring bars, available with both a conventional steel shank or a vibration-resistant carbide shank and coolant hole, guarantee consistent results and enhanced production reliability.

TOOLS FOR INTERNAL BORING

D-STYLE CLAMPING

- Used for negative style inserts.
- Clamp assembly contains clamp, screw, and retaining ring.
- Quick insert indexing.
- Ensures insert repeatability and seating.
- Reduced chatter and extended tool life.

P-STYLE CLAMPING

- Lever-type clamping system for negative indexable inserts.
- No interference to chip flow.
- Fast insert changes.
- P-style available in metric sizes only.

S-STYLE CLAMPING

- Screw clamping system for positive indexable inserts.
- Compact design for high reliability and cost efficiency.
- Carbide shim for additional tool protection.

C-STYLE CLAMPING

- Height-adjustable clamp permits use of additional chipbreakers.
- Universal clamping system for positive and negative flat top inserts.
- Robust engineering makes it easy to handle.
- Carbide shim for extra tool protection.

APPLICATIONS



BORING

INDUSTRY



Boring Bar Selection Guide

Each unique clamping system offers product options to fill your specific toolholder needs. Find the illustration that fits your application and navigate to the corresponding page to get the correct solution.

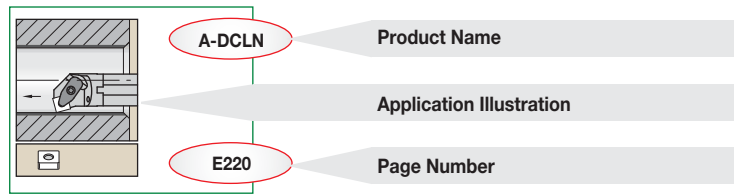

D-Style Clamping

D

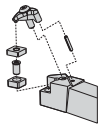

One-piece clamp assembly holder for use with negative style inserts. An extremely rigid clamping system. The tool is protected by a carbide shim.

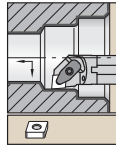

A-DCLN
95°
Page:
E220

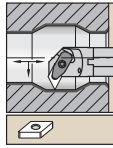

A-DDPN
117,5°
Page:
E220

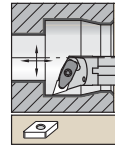

A-DDQN
107,5°
Page:
E221

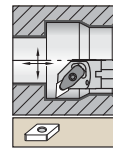

A-DDUN
93°
Page:
E221

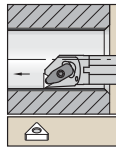

A-DTFN
90°
Page:
E222

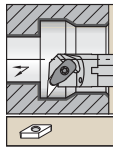

DVUN
93°
Page:
E222

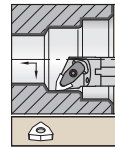

A-DWLN
95°
Page:
E223

P-Style Clamping

P

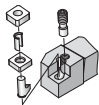

Lever-type clamping system for negative indexable inserts with hole to DIN 4988 and positive round inserts more than 20mm in diameter. Inserts with one- and two-side chip control geometries have positive rakes from 6° to 18°. Advantages of this system are fast insert changes and no interference with chip flow.

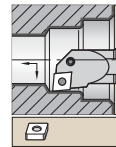

A-PCLN
95°
Page:
E224

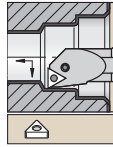

A-PTFN
90°
Page:
E224

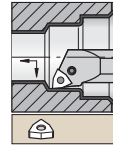

A-PWLN
95°
Page:
E225

C-Style Clamping

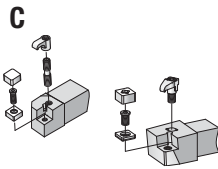

Top clamping system for negative and positive indexable inserts to DIN 4968. This universal clamping system is robust and easy to handle. Some height-adjustable clamps enable the use of additional chipbreakers. A carbide shim provides additional tool protection. Toolholders with cutting edge heights upwards of 16mm and insert iCs greater than 6,35mm.

	S-CCLN-MX 95° Page: E226		S-CCLN-MN 95° Page: E226		S-CDQN-MX Page: —		S-CSSN-MX 45° Page: —
	S-CSYN-MN 85° Page: —		S-CWLN-MX 95° Page: —		A-CTFP 90° Page: E231		

S-Style Clamping

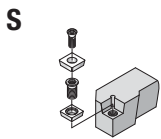









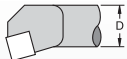
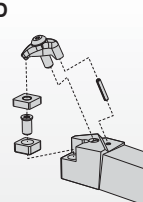











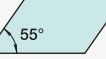



Screw clamping system for positive indexable inserts with countersunk hole to DIN 4967. Compact design using a minimum of spare parts for high reliability and cost efficiency. A carbide shim provides additional tool protection. Toolholders with cutting edge heights upwards of .625" and insert iCs from .375" are secured by means of a threaded bushing.

	A-SCFP 90° Page: —		E-SCFC 90° Page: E232		E-SCFP 90° Page: E232		A-SCLC 95° Page: E229
	E-SCLC 95° Page: E233		A-SCLP 95° Page: E233		E-SCLP 95° Page: E234		A-SDQC 107,5° Page: E229
	E-SDQC 107,5° Page: E234		A-SDQP Page: E235		A-SDUC 93° Page: E230		E-SDUC 93° Page: E235
	A-SDUP 93° Page: —		E-SDUP 93° Page: —		A-SDXP 95° Page: —		A-STFC 90° Page: E236
	E-STFC 90° Page: E236		A-STFP 90° Page: E237		E-STFP 90° Page: —		A-STWP 60° Page: —
	A-SVQB 107,5° Page: E231		A-SVUB 93° Page: E230				





















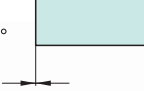
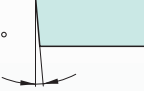
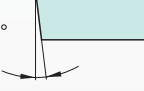
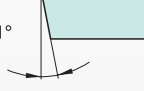

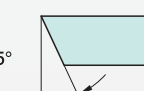
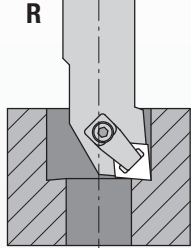
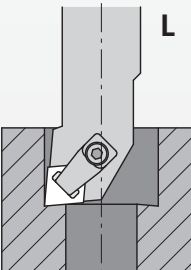
Catalog Numbering System

Each character in our catalog number signifies a specific trait of that product. Use the following key columns and corresponding images to easily identify which attributes apply.

A	32	S	D	C
Bar Type	Bar Diameter	Bar Length**	Insert Holding Method	Insert Shape
<p>A</p>  <p>Steel bar with coolant</p>	<p>32</p>  <p>Metric: A two-digit number indicates the bar diameter in mm. If the diameter is represented by a one digit number, a 0 (zero) will be used in front of it. Example: 8mm = 08</p>	<p>S</p> <p>3 = F 3.5 = G 4 = H 4.5 = J 5 = K 5.5 = L 6 = M 6.5 = N 7 = Q 8 = R 10 = S 12 = T 14 = U 16 = V 18 = W 20 = Y</p> <p>**Used only when more than one length is available or a special length is required.</p>	<p>D</p> 	<p>A</p> 
<p>S</p>  <p>Steel bar without coolant</p>			<p>B</p> 	
<p>C</p>  <p>Carbide bar</p>			<p>C</p> 	
<p>D</p>  <p>DeVibrator bar with coolant</p>			<p>D</p> 	
<p>D</p>  <p>Tunable bar with coolant</p>			<p>E</p> 	
<p>E</p>  <p>Carbide bar with coolant</p>			<p>H</p> 	
<p>B</p>  <p>DeVibrator</p>			<p>K</p> 	
<p>H</p>  <p>Interchangeable head</p>			<p>L</p> 	
<p>L</p>  <p>Heavy metal bar with coolant</p>			<p>M</p> 	
			<p>O</p> 	
	<p>P</p> 			
	<p>R</p> 			
	<p>S</p> 			
	<p>T</p> 			
	<p>V</p> 			
	<p>W</p> 			

Catalog Numbering System

(continued)

L	N	L	12	KC04
Bar Style or Lead Angle	Insert Clearance Angle	Hand of Tool	Insert Size Cutting Edge Length L10	Additional Information
<p>E </p> <p>F </p> <p>K </p> <p>L </p> <p>(E-style inserts)</p> <p>L </p> <p>P </p> <p>Q </p> <p>S </p> <p>U </p> <p>X </p>	<p>N 0° </p> <p>B 5° </p> <p>C 7° </p> <p>P 11° </p> <p>D 15° </p> <p>E 20° </p> <p>F 25° </p>	<p>R = Right-hand boring bar</p> <p>R </p> <p>L = Left-hand boring bar</p> <p>L </p>	<p>H </p> <p>O </p> <p>P </p> <p>S </p> <p>T </p> <p>CDE M V </p> <p>W </p> <p>L </p> <p>A B K </p> <p>R </p>	<p>M... = M., MF, MN, MX, for ceramic and PcBN inserts</p> <p>KC = D-Style Clamping</p> <p>+ = Insert thickness</p>

INDEXABLE MILLING

SOLID END MILLING

HOLEMAKING

TAPPING

TURNING

A-DCLN 95°

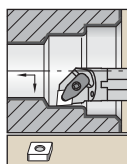

See pages E28–E42, E145, E159, E168–E169 for inserts.

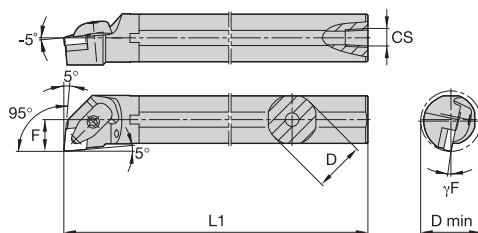

Steel shank with through coolant.

order number	catalogue number	D	D min	F	L1	CS	γF°	gage insert
right hand								
5696071	A25RDCLNR12KC04	25	32,0	17,0	200	1/4-18 NPT	-12,0	CN.120408
5696073	A32SDCLNR12KC04	32	40,0	22,0	250	1/4-18 NPT	-12,0	CN.120408
5696075	A40TDCLNR12KC04	40	50,0	27,0	300	1/4-18 NPT	-9,0	CN..120408
5696077	A40TDCLNR16KC06	40	50,0	27,0	300	1/4-18 NPT	-12,0	CN..160612
left hand								
5696072	A25RDCLNL12KC04	25	32,0	17,0	200	1/4-18 NPT	-12,0	CN.120408
5696074	A32SDCLNL12KC04	32	40,0	22,0	250	1/4-18 NPT	-12,0	CN.120408
5696076	A40TDCLNL12KC04	40	50,0	27,0	300	1/4-18 NPT	-9,0	CN.120408

A-DDPN-KC 117,5°

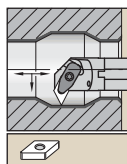

See pages E49–E60, E147, E162, E172–E173 for inserts.

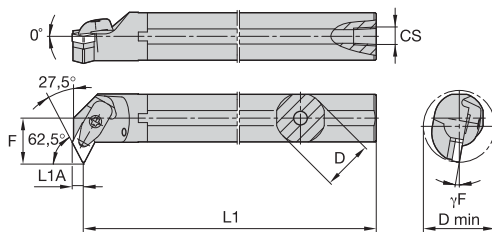

Steel shank with through coolant.

order number	catalogue number	D	D min	F	L1	L1A	CS	γF°	gage insert
right hand									
5696082	A40TDDPNR15KC06	40	52,0	30,0	300	6,6	1/4-18 NPT	-10,0	DN..150608
left hand									
5696081	A32SDDPNL15KC06	32	45,0	27,0	250	6,5	1/4-18 NPT	-12,0	DN..150608

A-DDQN 107,5°

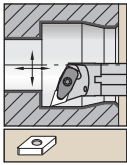

See pages E49–E60, E147, E162, E172–E173 for inserts.

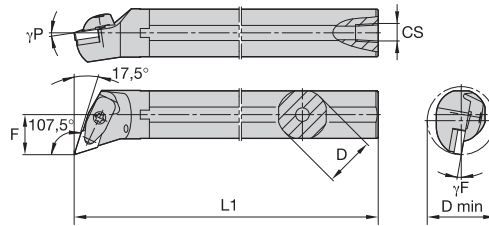

Steel shank with through coolant.

order number	catalogue number	D	D min	F	L1	CS	γF°	γP°	gage insert
right hand									
5696085	A32SDDQNR15KC06	32	40,0	22,0	250	1/4-18 NPT	-12,0	-10,0	DN..150608
5696087	A40TDDQNR15KC06	40	50,0	27,0	300	1/4-18 NPT	-10,0	-10,0	DN..150608
left hand									
5696086	A32SDDQNL15KC06	32	40,0	22,0	250	1/4-18 NPT	-12,0	-10,0	DN..150608
5696088	A40TDDQNL15KC06	40	50,0	27,0	300	1/4-18 NPT	-10,0	-10,0	DN..150608

A-DDUN 93°

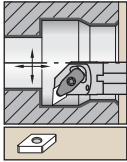

See pages E49–E60, E147, E162, E172–E173 for inserts.

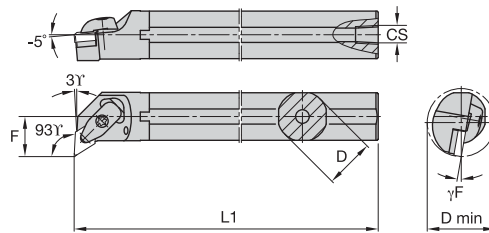

Steel shank with through coolant.

order number	catalogue number	D	D min	F	L1	CS	γF°	gage insert
right hand								
5696089	A25RDDUNR11KC04	25	32,0	17,0	200	1/4-18 NPT	-12,0	DN..110408
5696211	A32SDDUNR11KC04	32	40,0	22,0	250	1/4-18 NPT	-12,0	DN..110408
5696213	A32SDDUNR15KC06	32	40,0	22,0	250	1/4-18 NPT	-12,0	DN..150608
5696215	A40TDDUNR15KC06	40	50,0	27,0	300	1/4-18 NPT	-9,0	DN..150608
5696217	A50UDDUNR15KC06	50	63,0	35,0	350	1/4-18 NPT	-7,0	DN..150608
left hand								
5696214	A32SDDUNL15KC06	32	40,0	22,0	250	1/4-18 NPT	-12,0	DN..150608
5696216	A40TDDUNL15KC06	40	50,0	27,0	300	1/4-18 NPT	-9,0	DN..150608
5696218	A50UDDUNL15KC06	50	63,0	35,0	350	1/4-18 NPT	-7,0	DN..150608

A-DTFN 90°

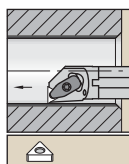

See pages E86–E95, E155, E164, E175 for inserts.

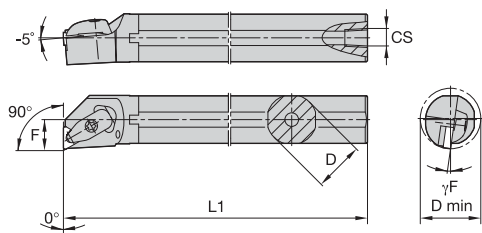

Steel shank with through coolant.

order number	catalogue number	D	D min	F	L1	CS	γF°	gage insert
right hand								
5696219	A25RDTFNR16KC04	25	32,0	17,0	200	1/4-18 NPT	-14.0	TN..160408
5696261	A32SDTFNR16KC04	32	40,0	22,0	250	1/4-18 NPT	-12.0	TN..160408
left hand								
5696260	A25RDTFNL16KC04	25	32,0	17,0	200	1/4-18 NPT	-14.0	TN..160408

A-DVUN 93°

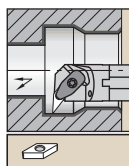

See pages E102–E108, E157, E166, E177 for inserts.

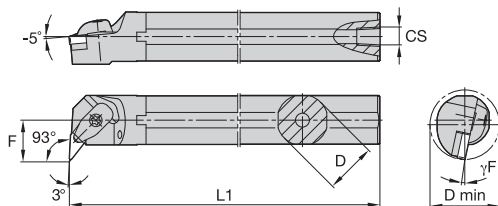

Steel shank with through coolant.

order number	catalogue number	D	D min	F	L1	CS	γF°	gage insert
right hand								
5696263	A32SDVUNR16KC04	32	40,0	22,0	250	1/4-18 NPT	-10.5	VN..160408
5696265	A40TDVUNR16KC04	40	50,0	27,0	300	1/4-18 NPT	-10.0	VN..160408

A-DWLN 95°

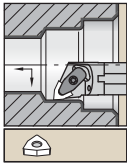

See pages E108–
E116, E157, E167,
E177 for inserts.

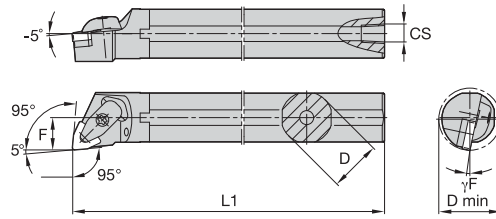

Steel shank with through coolant.

order number	catalogue number	D	D min	F	L1	CS	γ_F°	gage insert
right hand								
5696269	A25RDWLN08KC04	25	32,0	17,0	200	1/4-18 NPT	-12,0	WN..080408
5696281	A32SDWLN08KC04	32	40,0	22,0	250	1/4-18 NPT	-14,0	WN..080408
5696283	A40TDWLN08KC04	40	50,0	27,0	300	1/4-18 NPT	-14,0	WN..080408
left hand								
5696268	A25RDWLN06KC04	25	32,0	17,0	200	1/4-18 NPT	-14,0	WN..060408
5696280	A25RDWLN08KC04	25	32,0	17,0	200	1/4-18 NPT	-12,0	WN..080408
5696282	A32SDWLN08KC04	32	40,0	22,0	250	1/4-18 NPT	-14,0	WN..080408
5696284	A40TDWLN08KC04	40	50,0	27,0	300	1/4-18 NPT	-14,0	WN..080408

A-PCLN 95°

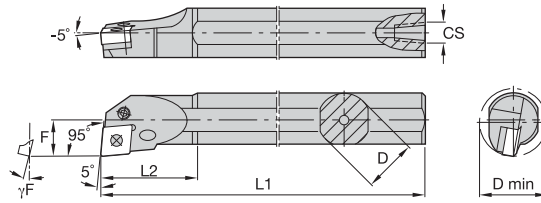
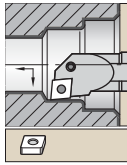

Steel shank with through coolant.

See pages E28–E42, E145, E159, E168–E169 for inserts.

order number	catalogue number	D	D min	F	L1	L2	CS	γ_F°	gage insert
right hand									
3883468	A25TPCLNR12	25	32,0	17,0	300	40	1/4-18 NPT	-12,0	CN..120408
3883466	A32UPCLNR12	32	40,0	22,0	350	50	1/4-18 NPT	-10,0	CN..120408
3883463	A40TPCLNR12	40	50,0	27,0	400	55	1/4-18 NPT	-10,0	CN..120408
3883442	A40TPCLNR16	40	50,0	27,0	400	55	1/4-18 NPT	-11,0	CN..160612
left hand									
3883469	A25TPCLNL12	25	32,0	17,0	300	40	1/4-18 NPT	-12,0	CN..120408
3883467	A32UPCLNL12	32	40,0	22,0	350	50	1/4-18 NPT	-10,0	CN..120408
3883465	A40TPCLNL12	40	50,0	27,0	400	55	1/4-18 NPT	-10,0	CN..120408

A-PTFN 90°

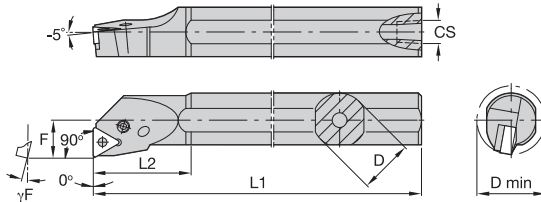
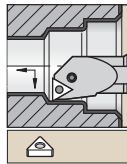

Steel shank with through coolant.

See pages E86–E95, E155, E164, E175 for inserts.

order number	catalogue number	D	D min	F	L1	L2	CS	γ_F°	gage insert
right hand									
3883263	A25TPTFNR16	25	32,0	17,0	300	40	1/4-18 NPT	-12,0	TN..160408
3883151	A32UPTFNR16	32	40,0	22,0	350	50	1/4-18 NPT	-10,0	TN..160408
3883149	A40VPTFNR22	40	48,0	27,0	400	55	1/4-18 NPT	-10,0	TN..220408

A-PWLN 95°

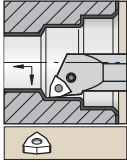

See pages E108–E116, E157, E167, E177 for inserts.

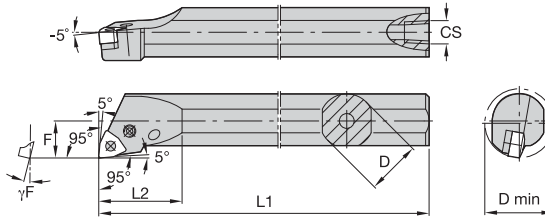

Steel shank with through coolant.

order number	catalogue number	D	D min	F	L1	L2	CS	γ_F°	gage insert
right hand									
3883459	A16RPWLN06	16	27,0	11,0	200	32	1/8-27 NPT	-12,0	WN..060404
3883455	A20SPWLN06	20	25,0	13,0	250	—	1/8-27 NPT	-14,0	WN..060408
3883458	A25RPWLN08	25	32,0	17,0	200	—	1/4-18 NPT	-12,0	WN..080408
3883454	A32SPWLN08	32	40,0	22,0	250	50	1/4-18 NPT	-10,0	WN..080408
left hand									
3883461	A16RPWLN06	16	27,0	11,0	200	32	1/8-27 NPT	-12,0	WN..060404
3883457	A20SPWLN06	20	25,0	13,0	250	—	1/8-27 NPT	-14,0	WN..060408
3883456	A32SPWLN08	32	40,0	22,0	250	50	1/4-18 NPT	-10,0	WN..080408

S-CCLN-MX 95°

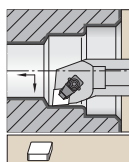

See page E146 for inserts.

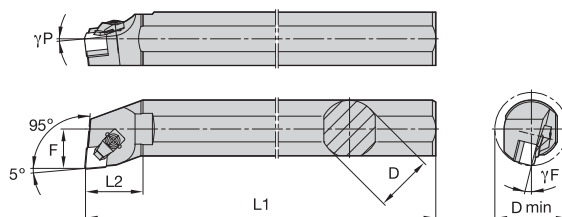

Steel shank with through coolant.

order number	catalogue number	D	D min	F	L1	L2	γ_F°	γ_P°	gage insert
right hand									
3883565	S32SCCLNR12MX7	32	40,0	22,0	251	43	-14.0	-5.0	CN.X120708

NOTE: MN – clamping version is shown.

S-CCLN-MN 95°

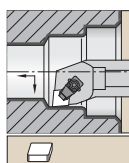

See page E146 for inserts.

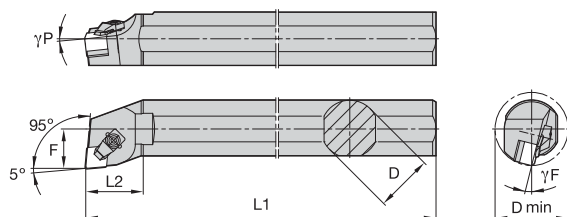

Steel shank with through coolant.

order number	catalogue number	D	D min	F	L1	L2	γ_F°	γ_P°	gage insert
right hand									
3029011	S40TCCLNR12MN4	40	55,0	27,0	300	40	-14.0	-6.0	CN.N120408

NOTE: MN – clamping version is shown.

A-MCLN 95°



Steel shank with through coolant
See pages E28-E42, E145, E159, E168-E169 for inserts.

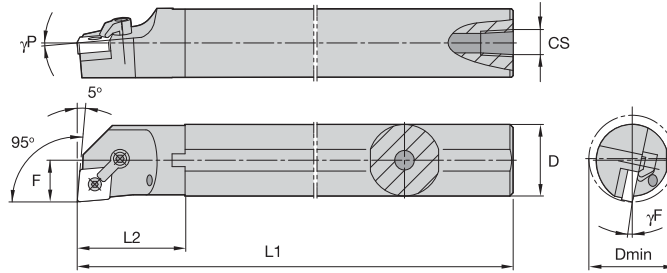

order number	catalogue number	D	D min	F	L1	CS	γF°	γP°	gage insert
right hand									
3852651	A50UMCLNR12	50	63,0	35,0	350	1/4-18 NPT	-7.0	-5.0	CN..120408
3852663	A50UMCLNR16	50	63,0	35,0	350	1/4-18 NPT	-8.0	-5.0	CN..160612
3852664	A50UMCLNR19	50	63,0	35,0	350	1/4-18 NPT	-8.0	-5.0	CN..190612
left hand									
3852652	A50UMCLNL12	50	63,0	35,0	350	1/4-18 NPT	-7.0	-5.0	CN..120408

A-MVUN 93°

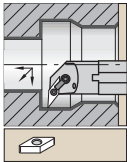

Steel shank with through coolant
See pages E102-E108, E157, E166, E177 for inserts.

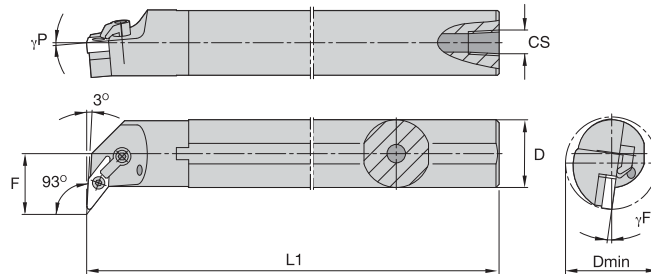

order number	catalogue number	D	D min	F	L1	CS	γF°	γP°	gage insert
right hand									
3852690	A25RMVUNR16	25	37,0	22,0	200	1/4-18 NPT	-12.0	-5.0	VN..160408

A-MTFN 90°



Steel shank with through coolant
See pages E86-E95, E155, E164, E175 for inserts.

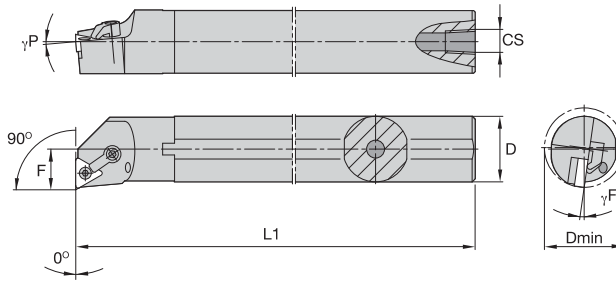

order number	catalogue number	D	D min	F	L1	CS	γF°	γP°	gage insert
left hand									
3852685	A40TMTFNL16	40	50,0	27,0	300	1/4-18 NPT	-9.0 deg	-5.0	TN..160408

A-SCLC 95°

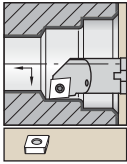

See pages E22–E27, E122, E158, E167–E168 for inserts.

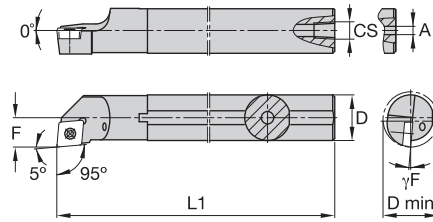

Steel shank with through coolant.

order number	catalogue number	D	D min	F	L1	A	CS	γF°	gage insert
right hand									
3883285	A08JSCLCR06	8	11,0	6,0	110	2,4	—	-8,0	CC..060204
3883283	A10KSCLCR06	10	13,0	7,0	125	3,2	—	-7,0	CC..060204
3883271	A16RSCLCR09	16	20,0	11,0	200	—	1/8-27 NPT	-7,0	CC..09T308
3883269	A20SSCLCR09	20	25,0	13,0	250	4,0	1/8-27 NPT	-5,0	CC..09T308
3883265	A25TSCLCR12	25	32,0	17,0	300	6,4	1/4-18 NPT	-7,0	CC..120408
3883266	A32TSCLCR12	32	40,0	22,0	300	6,4	1/4-18 NPT	-7,0	CC..120408
left hand									
3883286	A08JSCLCL06	8	11,0	6,0	110	2,4	—	-8,0	CC..060204
3883284	A10KSCLCL06	10	13,0	7,0	125	3,2	—	-7,0	CC..060204
3883272	A16RSCLCL09	16	20,0	11,0	200	4,0	1/8-27 NPT	-7,0	CC..09T308
3883270	A20SSCLCL09	20	25,0	13,0	250	—	1/8-27 NPT	-5,0	CC..09T308
3883267	A25TSCLCL12	25	32,0	17,0	300	6,4	1/4-18 NPT	-7,0	CC..120408
3883268	A32TSCLCL12	32	40,0	22,0	300	6,4	1/4-18 NPT	-7,0	CC..120408

A-SDQC 107,5°

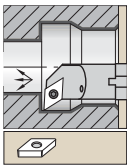

See pages E44–E48, E123, E161, E170–E171 for inserts.

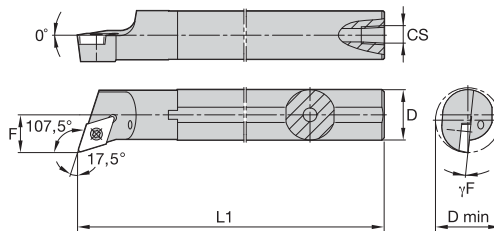

Steel shank with through coolant.

order number	catalogue number	D	D min	F	L1	CS	γF°	gage insert
right hand								
3883476	A16RSDQCR07	16	20,0	11,0	200	1/8-27 NPT	-5,0	DC..070204
3883474	A20SSDQCR11	20	25,0	13,0	250	1/8-27 NPT	-5,0	DC..11T308
3883462	A25TSDQCR11	25	32,0	17,0	300	1/4-18 NPT	-4,0	DC..11T308
left hand								
3883475	A20SSDQCL11	20	25,0	13,0	250	1/8-27 NPT	-5,0	DC..11T308
3883473	A25TSDQCL11	25	32,0	17,0	300	1/4-18 NPT	-4,0	DC..11T308

A-SDUC 93°

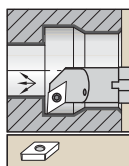

See pages E44-E48, E123, E161, E170-E171 for inserts.

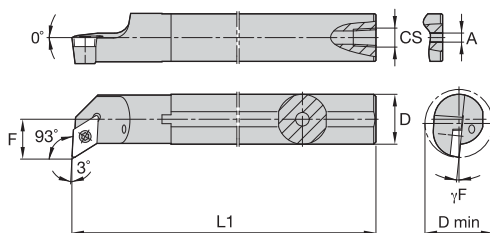

Steel shank with through coolant.

order number	catalogue number	D	D min	F	L1	A	CS	γF°	gage insert
right hand									
3883297	A10KSDUCR07	10	13,0	7,0	125	3,2	—	-7,0	DC..070204
3883294	A16RSDUCR07	16	20,0	11,0	200	—	1/8-27 NPT	-4,0	DC..070204
3883293	A16RSDUCR11	16	20,0	11,0	200	—	1/8-27 NPT	-6,0	DC..11T308
3883291	A20SSDUCR11	20	25,0	13,0	250	—	1/8-27 NPT	-5,0	DC..11T308
3883288	A25TSDUCR11	25	32,0	17,0	300	—	1/8-27 NPT	-4,0	DC..11T308
3883287	A32TSDUCR15	32	40,0	22,0	300	—	1/4-18 NPT	-7,0	DC..150408
left hand									
3883298	A10KSDUCL07	10	13,0	7,0	125	3,2	—	-7,0	DC..070204
3883296	A16RSDUCL07	16	20,0	11,0	200	—	1/8-27 NPT	-4,0	DC..070204
3883295	A16RSDUCL11	16	20,0	11,0	200	—	1/8-27 NPT	-6,0	DC..11T308
3883292	A20SSDUCL11	20	25,0	13,0	250	—	1/8-27 NPT	-5,0	DC..11T308
3883290	A25TSDUCL11	25	32,0	17,0	300	—	1/8-27 NPT	-4,0	DC..11T308
3883289	A32TSDUCL15	32	40,0	22,0	300	—	1/8-27 NPT	-7,0	DC..150408

A-SVUB 93°

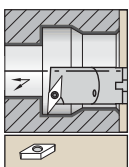

See pages E99-E101, E125, E166, E176 for inserts.

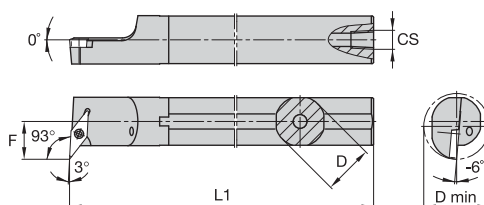

Steel shank with through coolant.

order number	catalogue number	D	D min	F	L1	CS	gage insert
right hand							
3883440	A20SSVUBR11	20	25,0	13,0	250	1/8-27 NPT	VB..110304
3883438	A25TSVUBR16	25	32,0	17,0	300	1/4-18 NPT	VB..160408
left hand							
3883439	A25TSVUBL16	25	32,0	17,0	300	1/4-18 NPT	VB..160408

A-SVQB 107,5°

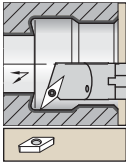

See pages E99-
E101, E125,
E166, E176 for
inserts.

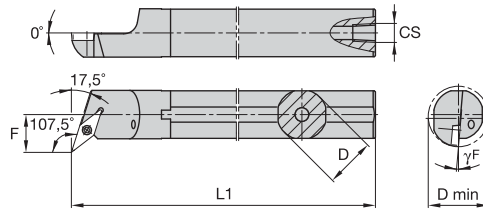

Steel shank with through coolant.

order number	catalogue number	D	D min	F	L1	CS	γF°	gage insert
right hand								
3883436	A16RSVQBR11	16	20,0	11,0	200	1/8-27 NPT	-7.0	VB..110304
3883434	A25TSVQBR16	25	32,0	17,0	300	1/4-18 NPT	-6.0	VB..160408
left hand								
3883435	A25TSVQBL16	25	32,0	17,0	300	1/4-18 NPT	-6.0	VB..160408

A-CTFP 90°

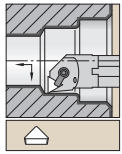

See pages E96,
E98, E165 for
inserts.

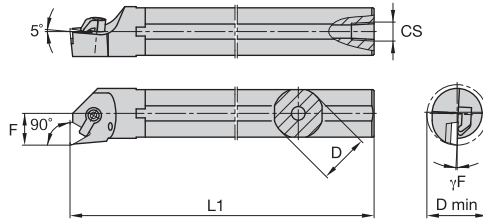

Steel shank with through coolant.

order number	catalogue number	D	D min	F	L1	CS	γF°	gage insert
right hand								
3883451	A16RCTFPR11	16	20,0	11,0	200	1/8-27 NPT	-4.0	TP..110304
3883450	A25RCTFPR16	25	32,0	17,0	200	1/4-18 NPT	-3.0	TP..160308

E-SCFC 90°

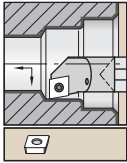

See pages E22–E27, E122, E158, E167–E168 for inserts.

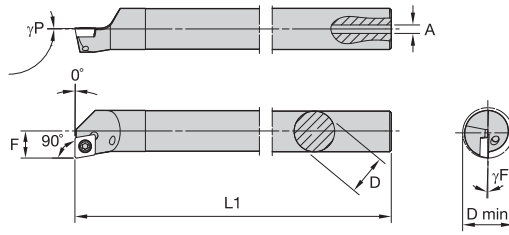

Carbide shank with through coolant.

order number	catalogue number	D	D min	F	L1	A	γF°	γP°	gage insert
right hand 2023600	E08KSCFCR06	8	11,0	6,0	125	3,0	-12,0	0,0	CC..060204
left hand 2031019	E08KSCFCL06	8	11,0	6,0	125	3,0	-12,0	0,0	CC..060204

E-SCFP 90°

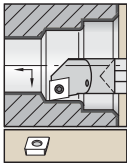

See pages E43, E160, E169–E170 for inserts.

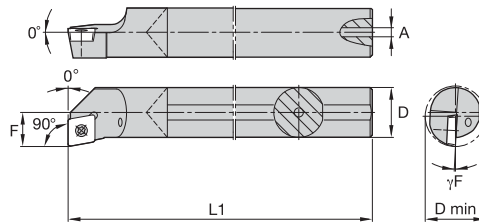

Carbide shank with through coolant.

order number	catalogue number	D	D min	F	L1	A	γF°	gage insert
right hand 2010047	E06JSCFPR04	6	8,0	4,5	110,0	2,0	-10,0	CP..04T104
5092759	E08KSCFPR06A	8	11,0	5,9	124,3	2,4	-8,0	CP..060204
5092921	E10MSCFPR06A	10	13,0	6,9	149,3	7,1	-4,0	CP..060204

E-SCLC 95°

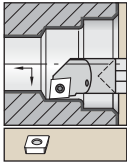

See pages E22–E27, E122, E158, E167–E168 for inserts.

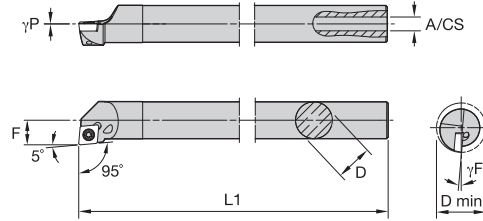

Carbide shank with through coolant.

order number	catalogue number	D	D min	F	L1	A	CS	γF°	γP°	gage insert
right hand										
2010068	E08KSCLCR06	8	11,0	6,0	125	3,0	—	-12,0	0,0	CC..060204
2023603	E08KSCLCR065	8	10,0	5,0	125	3,0	—	-15,0	0,0	CC..060204
2031021	E10MSCLCR06	10	13,0	7,0	151	3,2	—	-10,0	0,0	CC..060204
2023608	E12QSCLCR06	12	16,0	9,0	180	4,5	—	-8,0	0,0	CC..060204
2010139	E16RSCLCR09	16	20,0	11,0	200	4,5	—	-7,0	0,0	CC..090308
2023614	E16RSCLCR09T3	16	20,0	11,0	200	4,5	—	-7,0	0,0	CC..09T308
2023621	E20SSCLCR09	20	25,0	13,0	250	—	G1/8	-5,0	0,0	CC..090308
2010184	E20SSCLCR09T3	20	25,0	13,0	250	—	G1/8	-5,0	0,0	CC..09T308
2010224	E25TSCLCR09T3	25	32,0	17,0	300	—	G1/4	-3,0	0,0	CC..09T308
2023632	E32USCLCR12	32	40,0	22,0	350	—	G1/4	-10,0	0,0	CC..120408
left hand										
2023601	E08KSCLCL06	8	11,0	6,0	125	3,0	—	-12,0	0,0	CC..060204
2031020	E08KSCLCL065	8	10,0	5,0	125	3,0	—	-15,0	0,0	CC..060204
2031022	E10MSCLCL06	10	13,0	7,0	151	3,2	—	-10,0	0,0	CC..060204
2023607	E12QSCLCL06	12	16,0	9,0	180	4,5	—	-8,0	0,0	CC..060204
2023613	E16RSCLCL09	16	20,0	11,0	200	4,5	—	-7,0	0,0	CC..090308
2031026	E20SSCLCL09	20	25,0	13,0	250	—	G1/8	-5,0	0,0	CC..090308
2010215	E25TSCLCL09	25	32,0	17,0	300	—	G1/4	-3,0	0,0	CC..090308

A-SCLP 95°

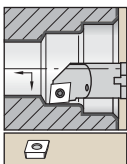

See pages E43, E160, E169–E170 for inserts.

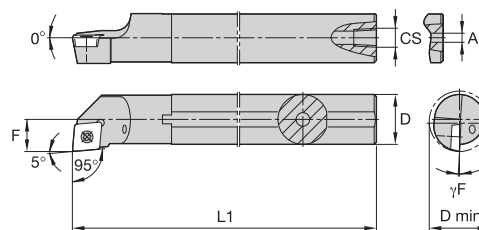

Steel shank with through coolant.

order number	catalogue number	D	D min	F	L1	A	CS	γF°	gage insert
right hand									
5077645	A10KSCLPR06	10	13,0	7,0	125	3,2	—	-4,0	CP..0602..
5077681	A12MSCLPR06	12	16,0	9,0	150	4,0	—	-3,0	CP..0602..
5077694	A16RSCLPR06	16	20,0	11,0	200	—	1/8-27 NPT	-5,0	CC..0602..
left hand									
5077680	A12MSCLPL06	12	16,0	9,0	150	4,0	—	-3,0	CP..0602..

E-SCLP 95°

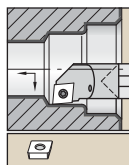

See pages E43,
E160, E169–E170
for inserts.

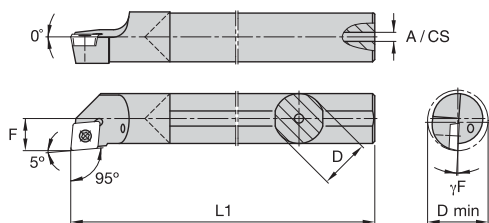

Carbide shank with through coolant.

order number	catalogue number	D	D min	F	L1	A	γ_F°	gage insert
right hand								
2023598	E06JSCLPR04	6	8,0	4,5	110	2,0	-10,0	CP..04T104
5093094	E08KSCLPR06A	8	11,0	5,9	123	2,4	-6,0	CP..060204
5093185	E20SSCLPR09	20	25,0	12,9	251	7,1	-2,0	CP..09T308
left hand								
2023597	E06JSCLPL04	6	8,0	4,5	110	2,0	-10,0	CP..04T104

E-SDQC 107,5°

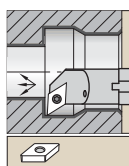

See pages E44–
E48, E123, E161,
E170–E171 for
inserts.

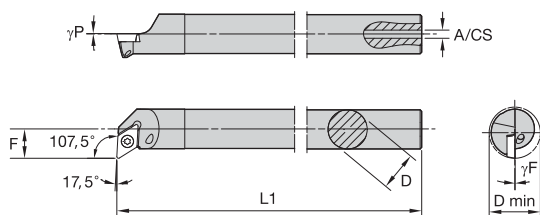

Carbide shank with through coolant.

order number	catalogue number	D	D min	F	L1	A	CS	γ_F°	γ_P°	gage insert
right hand										
2010111	E12QSDQCR07	12	16,0	9,0	180	4,5	—	-7,0	0,0	DC..070204
2031025	E16RSDQCR07	16	20,0	11,0	200	5,5	—	-5,0	0,0	DC..070204
2023623	E20SSDQCR11	20	25,0	13,0	250	—	G1/8	-7,0	0,0	DC..11T308
left hand										
2031023	E12QSDQCL07	12	16,0	9,0	180	4,5	—	-7,0	0,0	DC..070204
2010148	E16RSDQCL07	16	20,0	11,0	200	5,5	—	-5,0	0,0	DC..070204
2023622	E20SSDQCL11	20	25,0	13,0	250	—	G1/8	-7,0	0,0	DC..11T308

A-SDQP

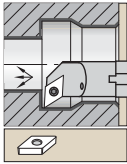

See pages E162–E163 for inserts.

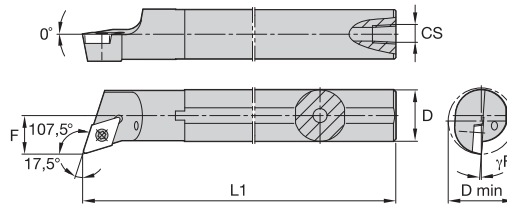

Steel shank with through coolant.

order number	catalogue number	D	D min	F	L1	CS	γ_F°	gage insert
right hand								
5078298	A20SSDQPR11	20	25,0	13,0	250	1/8-27 NPT	2.0	DP..11T3..

E-SDUC 93°

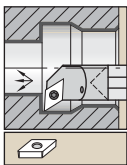

See pages E44–E48, E123, E161, E170–E171 for inserts.

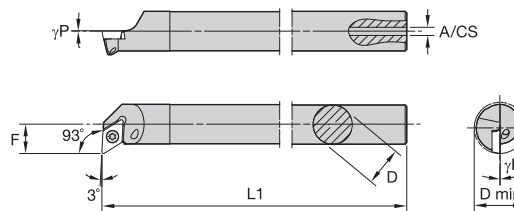

Carbide shank with through coolant.

order number	catalogue number	D	D min	F	L1	A	CS	γ_F°	γ_P°	gage insert
right hand										
2023611	E12QSDUCR07	12	16,0	9,0	180	4,5	—	-7.0	0.0	DC..070204
2010157	E16RSDUCR07	16	20,0	11,0	200	4,5	—	-5.0	0.0	DC..070204
2023624	E20SSDUCR11	20	25,0	13,0	250	—	G1/8	-7.0	0.0	DC..11T308
2023630	E25TSDUCR11	25	32,0	17,0	300	—	G1/4	-5.0	0.0	DC..11T308
left hand										
2023610	E12QSDUCL07	12	16,0	9,0	180	4,5	—	-7.0	0.0	DC..070204
2023617	E16RSDUCL07	16	20,0	11,0	200	4,5	—	-5.0	0.0	DC..070204
2010193	E20SSDUCL11	20	25,0	13,0	250	—	G1/8	-7.0	0.0	DC..11T308
2023629	E25TSDUCL11	25	32,0	17,0	300	—	G1/4	-5.0	0.0	DC..11T308

A-STFC 90°

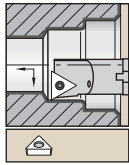

See pages
E83–E85, E124,
E163–E164, E175
for inserts.

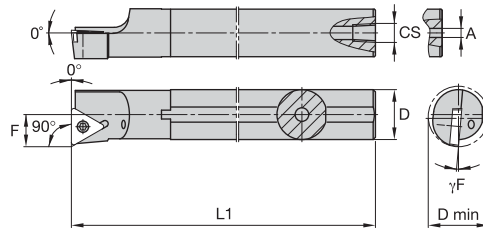

Steel shank with through coolant.

order number	catalogue number	D	D min	F	L1	A	γF°	gage insert
right hand								
3883382	A10KSTFCR11	10	13,0	7,0	125	3,2	-7,0	TC..110204

E-STFC 90°

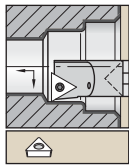

See pages
E83–E85, E124,
E163–E164, E175
for inserts.

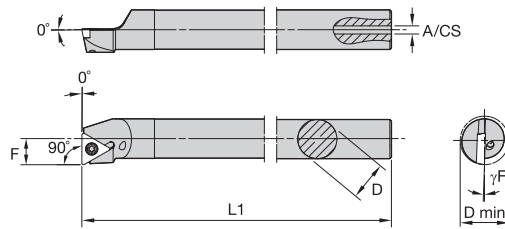

Carbide shank with through coolant.

order number	catalogue number	D	D min	F	L1	A	CS	γF°	gage insert
right hand									
2031888	E10MSTFCR11	10	13,0	7,0	150	3,5	—	-10,0	TC..110204
2031024	E12QSTFCR11	12	16,0	9,0	180	4,5	—	-8,0	TC..110204
2010174	E16RSTFCR16	16	20,0	11,0	200	4,5	—	-9,0	TC..16T308
2023626	E20SSTFCR16	20	25,0	13,0	250	—	G1/8	-7,0	TC..16T308
2023631	E25TSTFCR16	25	32,0	17,0	300	—	G1/4	-5,0	TC..16T308
left hand									
2010090	E10MSTFCL11	10	13,0	7,0	150	3,5	—	-10,0	TC..110204
2010120	E12QSTFCL11	12	16,0	9,0	180	4,5	—	-8,0	TC..110204
2023618	E16RSTFCL16	16	20,0	11,0	200	4,5	—	-9,0	TC..16T308
2023625	E20SSTFCL16	20	25,0	13,0	250	—	G1/8	-7,0	TC..16T308
2010233	E25TSTFCL16	25	32,0	17,0	300	—	G1/4	-5,0	TC..16T308

A-STFP 90°

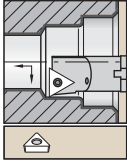

See page E97 for inserts.

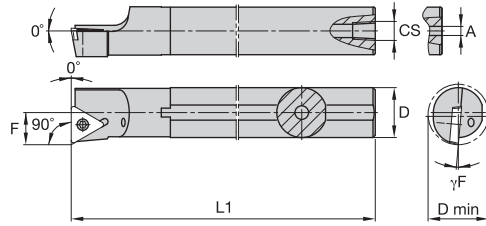

Steel shank with through coolant.

order number	catalogue number	D	D min	F	L1	A	CS	γ_F°	gage insert
right hand									
3883446	A10KSTFPR11	10	13,0	7,0	125	3,2	—	-4.0	TP..110204
5086802	A12MSTFPR11	12	16,0	9,0	150	4,0	—	-2.0	TP..110204
3883444	A16RSTFPR11	16	20,0	11,0	200	—	1/16-27 NPT	0.0	TP..110204

INDEXABLE MILLING

SOLID END MILLING

HOLEMAKING

TAPPING

TURNING

Cartridges

Cartridges for Negative and Positive Inserts

Standard WIDIA™ cartridges are ideal for turning tools with one or several cutting edges. A wide range of cartridge sizes and styles provides numerous combinations and application possibilities.

Same clamping systems as standard turning toolholders. Overall sizes to DIN and ISO are ideal for single- and multi-tooth turning, boring, and spotting tools.

Precise axial and radial positioning by adjustment screws.



CARTRIDGES

P-STYLE CLAMPING

- Lever-type clamping system for negative indexable inserts with hole to DIN 4988 and positive round inserts more than 20mm in diameter.
- Inserts with one- and two-side chip control geometries have positive rakes from 6° to 18°.
- Advantages of this system are fast insert changes and no interference with chip flow.
- P-style available in metric sizes only.

S-STYLE CLAMPING

- Screw clamping system for positive indexable inserts with countersunk hole to DIN 4967.
- Compact design using a minimum of spare parts for high reliability and cost efficiency.
- A carbide shim provides additional tool protection.
- Toolholders with cutting edge heights upwards of 16mm (.625") and insert iCs from 9,52mm (.375") are secured by means of a threaded bushing.

APPLICATIONS



BORING

I. D.
CHAMFERING

I. D. FACING

INDUSTRY



P-Style Clamping

P

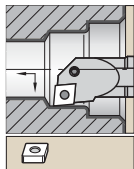
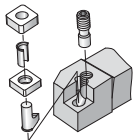

PCLN

95°

Page:

E194

Lever-type clamping system for negative indexable inserts with hole to DIN 4988 and positive round inserts more than 20mm in diameter. Inserts with one- and two-side chip control geometries have positive rakes from 6° to 18°. Advantages of this system are fast insert changes and no interference with chip flow.

Clamping System S

S

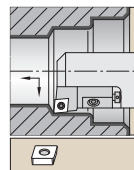
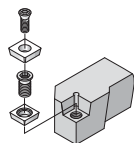

SCLC

95°

Page:

E207

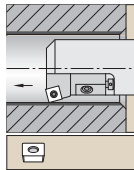

SSKC

75°

Page:

E244

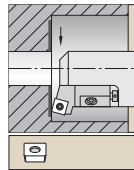

SSRC

75°

Page:

E245

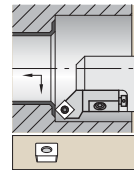

SSSC

45°











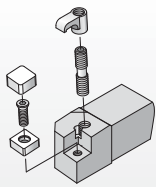





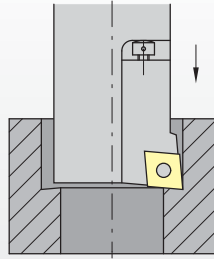
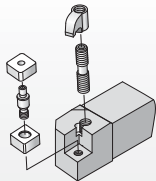

Page:

E245

Combined pin/wedge clamp for negative inserts. An extremely sturdy clamping system, specially designed for interrupted cuts. The tool is protected by a carbide shim.

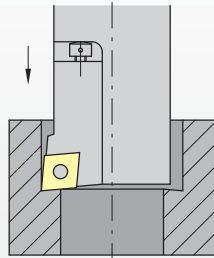
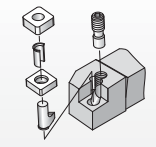
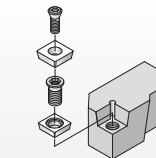

Catalog Numbering System

Each character in our catalog number signifies a specific trait of that product. Use the following key columns and corresponding images to easily identify which attributes apply.

M	C	F	N	R
<p>Insert Clamping System</p>	<p>Insert Shape</p>	<p>Cartridge Style</p>	<p>Insert Clearance Angle</p>	<p>Hand of Tool</p>
<p>C</p>  <p>Top clamping by clamping finger for inserts without hole.</p>	<p>C </p> <p>D </p>	<p>F  K </p> <p>L  J </p>	<p>C </p> <p>N </p> <p>P </p>	<p>Right-hand cartridge</p> <p>R</p> 
<p>M</p>  <p>Top and hole clamping for inserts with hole.</p>	<p>R </p> <p>S </p> <p>T </p> <p>W </p>	<p>Q  R </p> <p>S  G </p>	<p>Left-hand cartridge</p> <p>L</p> 	
<p>P</p>  <p>Insert clamping by toggle lever for insert hole.</p>				
<p>S</p>  <p>Center clamping by screw for inserts with hole.</p>				

Catalog Numbering System

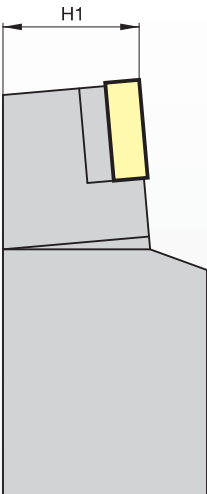
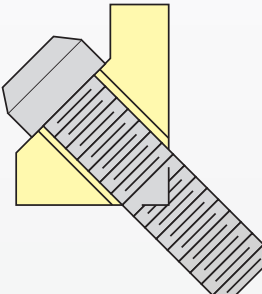
(continued)

10	C	A	3	
Cartridge Size	Identifying Code of Cartridge	Mounting Design of Cartridge	Insert Size	Additional Information
	<p>C = Cartridge</p>	<p>A-design conforming to ISO 5611</p> 	 <p>Insert iC Number of 1/8ths of "D"</p>	
<p>H1 = Cutting edge height of cartridge, in inches</p>				

PCLN 95°

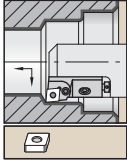

See pages E28–E42, E145, E159, E168–E169 for inserts.

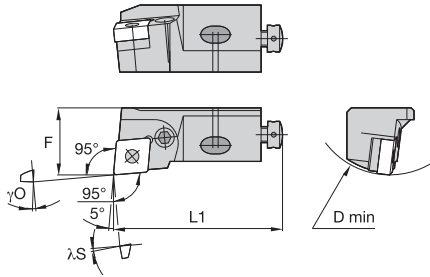

order number	catalogue number	D min	F	L1	λS°	γO°	gage insert
right hand 3871290	PCLNR16CA12	60	25,0	63	-6.0	-7.0	CN..120408/CN..432

INDEXABLE MILLING

SOLID END MILLING

HOLEMAKING

TAPPING

TURNING

SCLC 95°

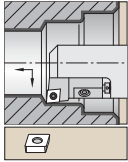

See pages E22–E27, E122, E158, E167–E168 for inserts.

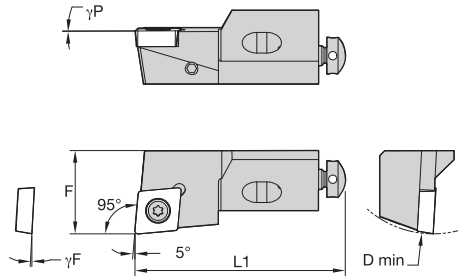

order number	catalogue number	D min	F	L1	γ_F°	γ_P°	gage insert
left hand							
3871267	SCLCL12CA12	50	20,0	55	-3.0	0.0	CC..120408/CC..432

SSKC 75°

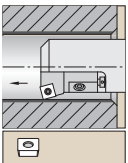

See pages E64–E67 for inserts.

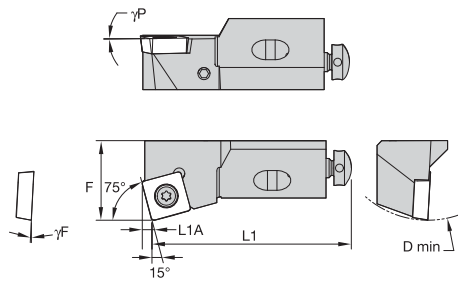

order number	catalogue number	D min	F	L1	L1A	γ_F°	γ_P°	gage insert
right hand								
3871191	SSKCR12CA12	50	20,0	55	3	-3.0	0.0	SC..120408/SC..432

SSRC 75°

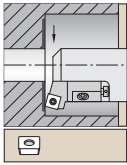

See pages E64–E67 for inserts.

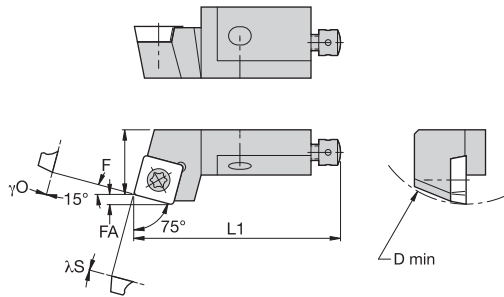

order number	catalogue number	D min	F	FA	L1	λS°	γO°	gage insert
left hand 3870391	SSRCL12CA12	50	20,0	3,1	55	-3.0	0.0	SC..120408/SC..432

SSSC 45°

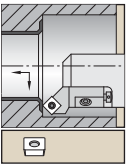

See pages E64–E67 for inserts.

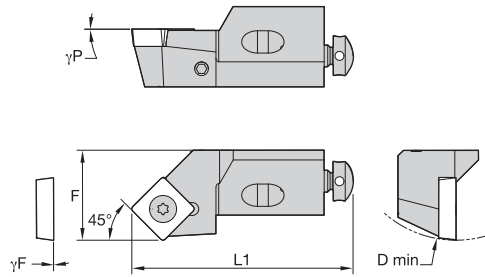

order number	catalogue number	D min	F	L1	γF°	γP°	gage insert
right hand 3870385	SSSCR12CA12	50	20,0	47	-3.0	0.0	SC..120408/SC..432

Railway Wheelset Reconditioning Tools

Wheel Reprofilng/Wheelset Turning

Toolholders and indexable inserts for all types of wheel lathes used in the railroad industry.

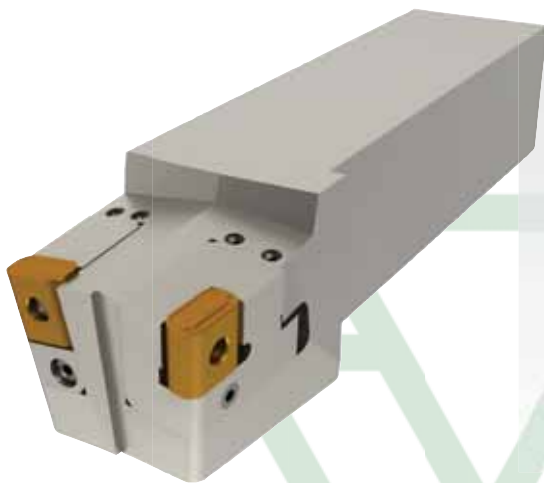

TOOLHOLDERS

- Robust lever clamping design with no top clamp to interfere with chip flow.
- Toolholders are made from heat-treated alloy steel, providing rigid support to the insert to withstand severe roughing cuts on work-hardened wheels.



INSERTS

- Upended inserts are neutral and common for either hand of the toolholder.
- Multiple chipbreaker profiles and highly wear-resistant coated carbide grades
- Grades are available to machine the wheels in a range of wear conditions.

WIDIA™ TOOLS FOR RAILWAY WHEEL MACHINING

WIDIA offers toolholders and indexable inserts for all types of wheel lathes being used in the Industry.

- The tooling for wheelset reprofiling/reconditioning has been developed in close cooperation with machine tool builders and railway workshops.
- The wheel profile wears during usage and also due to skidding, mismatched wheels, etc.
- Different chipbreaker profiles and grades are available to machine the wheels with different wear conditions.
- The upended design of inserts enhances the insert strength and the chipbreakers are designed to provide optimum performance with efficient chipbreaking while machining the profile.
- The toolholders adopt the robust lever clamping system.

WIDIA tooling solutions for heavy-duty turning have a proven history of success in these extremely demanding applications around the world. Customers looking for maximum material removal and improved productivity can rely on WIDIA to provide the right tool, inserts, and grades for their workpiece, machine tool, and applications.

APPLICATIONS



TURNING



FACING



PROFILING

INDUSTRY

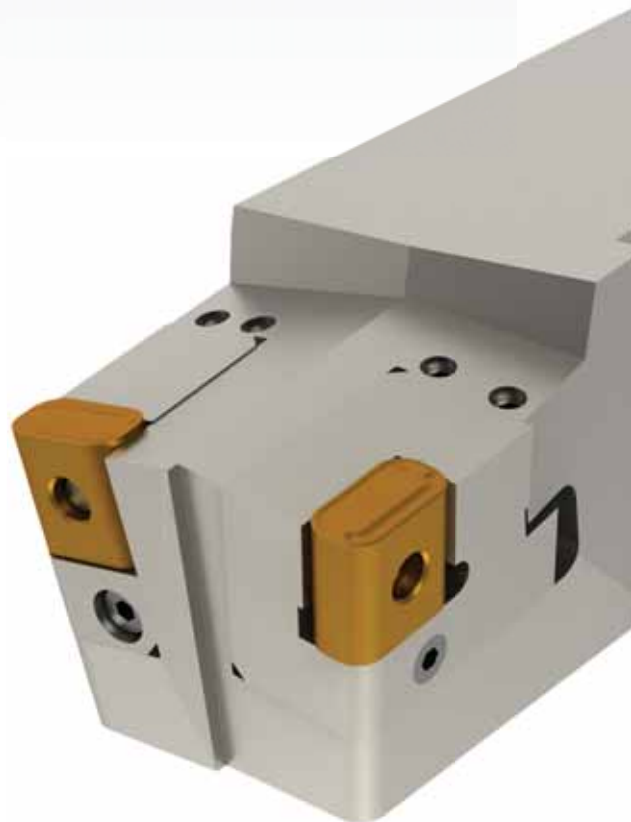

Railway Wheel Reprofilng Inserts • LNUX-16

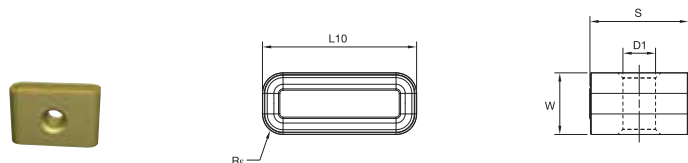

- first choice
- alternate choice

P	<input type="checkbox"/>	<input type="checkbox"/>	<input type="checkbox"/>
M	<input type="checkbox"/>	<input type="checkbox"/>	<input type="checkbox"/>
K	<input type="checkbox"/>	<input checked="" type="checkbox"/>	<input type="checkbox"/>
N	<input type="checkbox"/>	<input type="checkbox"/>	<input type="checkbox"/>
S	<input type="checkbox"/>	<input type="checkbox"/>	<input type="checkbox"/>
H	<input type="checkbox"/>	<input type="checkbox"/>	<input type="checkbox"/>

ISO catalogue number	W	L10	S	Re	D1	WK20CT	WP15CT
LNUX30194016	12,00	30,00	19,05	4,0	6,35	6128295	1

Railway Wheel Reprofilng Inserts • LNUX-13

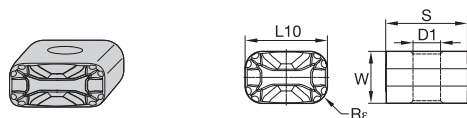

- first choice
- alternate choice

P	<input type="checkbox"/>	<input type="checkbox"/>	<input type="checkbox"/>
M	<input type="checkbox"/>	<input type="checkbox"/>	<input type="checkbox"/>
K	<input type="checkbox"/>	<input checked="" type="checkbox"/>	<input type="checkbox"/>
N	<input type="checkbox"/>	<input type="checkbox"/>	<input type="checkbox"/>
S	<input type="checkbox"/>	<input type="checkbox"/>	<input type="checkbox"/>
H	<input type="checkbox"/>	<input type="checkbox"/>	<input type="checkbox"/>

ISO catalogue number	W	L10	S	Re	D1	WK20CT	WP15CT
LNUX19194013	10,00	19,05	19,05	4,0	6,35	4170966	1
LNUX30194013	12,00	30,00	19,05	4,0	6,35	4170968	1

Railway Wheel Reprofilng Inserts • LNUX-T

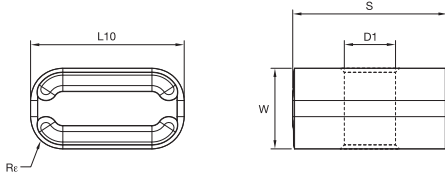

- first choice
- alternate choice

P	■	○	●
M	■	○	●
K	■	○	●
N	■	○	●
S	■	○	●
H	■	○	●

ISO catalogue number	W	L10	S	Rr	D1	4170967	6128294
LNUX191940T	10,00	19,05	19,05	4,0	6,35	WK20CT	WP15CT
LNUX301940T	12,00	30,00	19,05	4,0	6,35	4170969	-

INDEXABLE MILLING

SOLID END MILLING

HOLEMAKING

TAPPING

TURNING

Railway Toolholder • Wheel Turning Lathe • Left Hand • LNUX19 Inserts

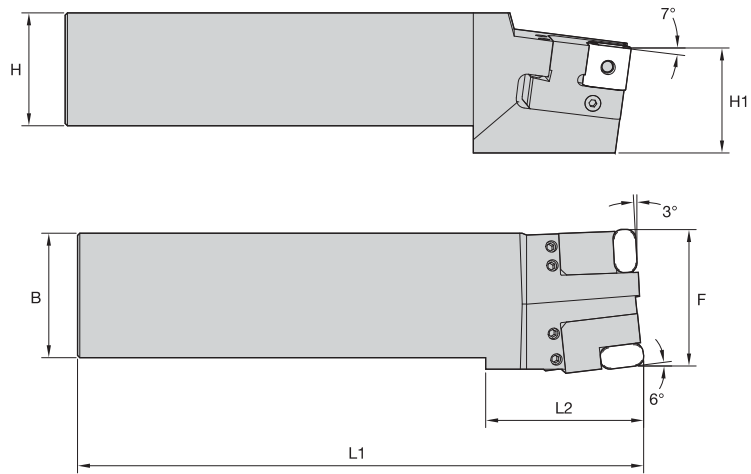

order number	catalogue number	B	F	H	H1	L1	L2
left hand							
2552320	6939143120	55,00	60,00	50,00	46,00	250,00	70,00

Railway Toolholder • Wheel Turning Lathe • Left Hand • LNUX30 Inserts

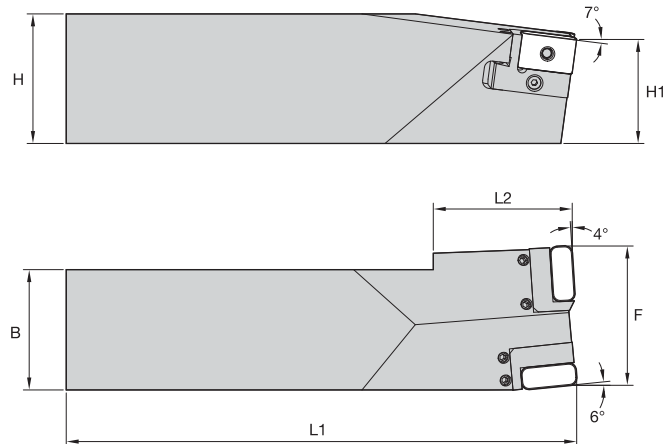

order number	catalogue number	B	F	H	H1	L1	L2
left hand							
2552318	6939145820	65,00	75,00	70,00	56,00	276,00	77,78

Railway Toolholder • Wheel Turning Lathe • Right Hand • LNUX19 Inserts

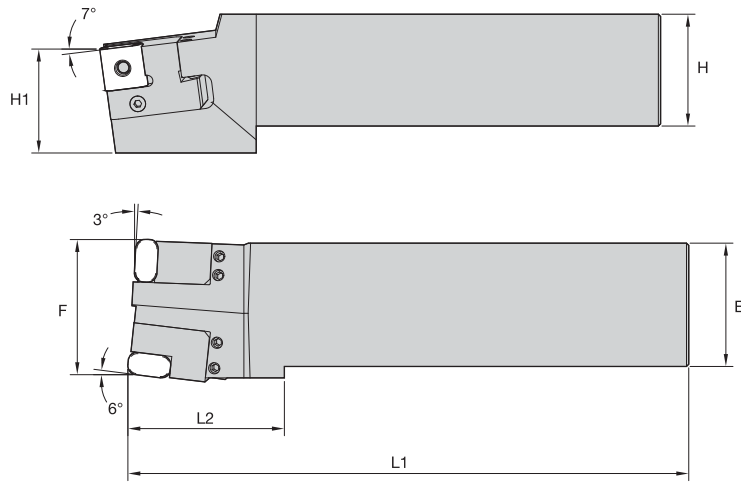

order number	catalogue number	B	F	H	H1	L1	L2
right hand 2552321	6939143110	55,00	60,00	50,00	46,00	250,00	70,00

Railway Toolholder • Wheel Turning Lathe • Right Hand • LNUX30 Inserts

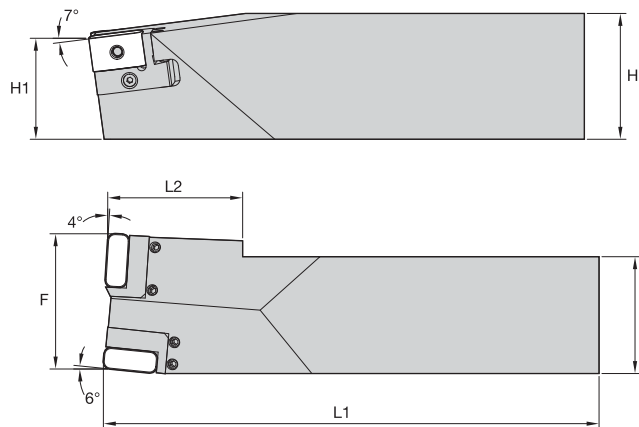

order number	catalogue number	B	F	H	H1	L1	L2
right hand 2552319	6939145810	65,00	75,00	70,00	56,00	276,00	77,78

Railway Turning Cassette • Wheel Turning Lathe • Left Hand • LNUX30 Inserts

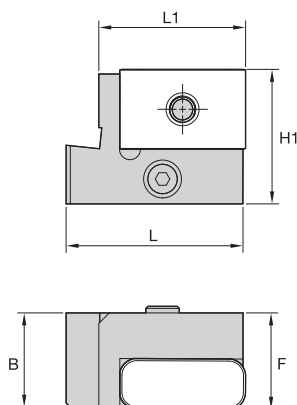

order number	catalogue number	B	F	L	L1	H1	gage insert
left hand							
2035331	6939318620	22,50	23,00	42,20	35,00	32,10	LNUX301940

Railway Turning Cassette • Wheel Turning Lathe • Left Hand • LNUX30 Inserts

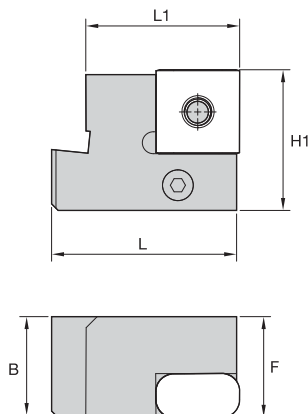

order number	catalogue number	B	F	L	L1	H1	gage insert
left hand							
2276948	6939318620	22,55	23,00	42,20	35,00	32,00	LNUX191940

Railway Turning Cassette • Wheel Turning Lathe • Right Hand • LNUX19 Inserts

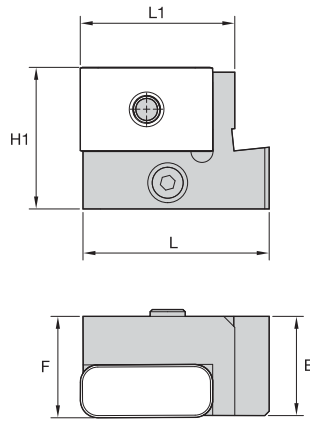

order number	catalogue number	B	F	L	L1	H1	gage insert
right hand 2039208	6939318610	22,50	23,00	42,20	35,00	32,00	LNUX301940

Railway Turning Cassette • Wheel Turning Lathe • Right Hand • LNUX30 Inserts

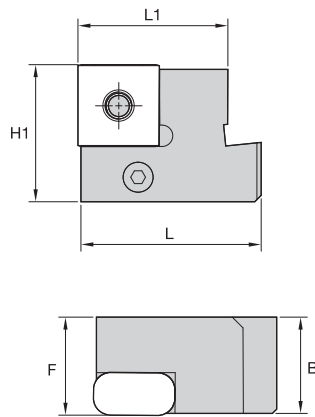

order number	catalogue number	B	F	L	L1	H1	gage insert
right hand 2276947	6939318710	22,55	23,00	42,20	35,00	32,00	LNUX191940

INDEXABLE MILLING

SOLID END MILLING

HOLEMAKING

TAPPING

TURNING

INDEXABLE MILLING

SOLID END MILLING

HOLEMAKING

TAPPING

TURNING

Railway Facing Cassette • Wheel Turning Lathe • Left Hand • LNUX19 Inserts

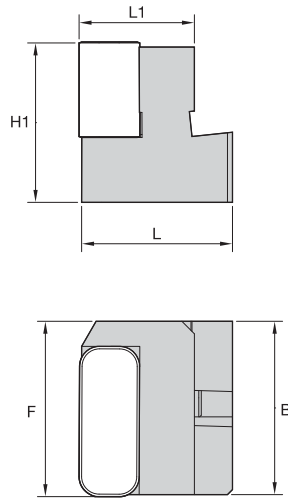

order number	catalogue number	B	F	L	L1	H1	gage insert
left hand 2403738	6939322020	34,60	35,00	30,10	23,00	32,00	LNUX301940

Railway Facing Cassette • Wheel Turning Lathe • Right Hand • LNUX19 Inserts

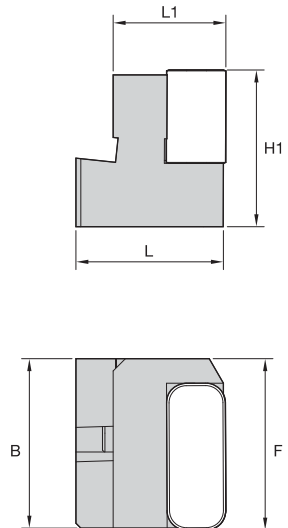

order number	catalogue number	B	F	L	L1	H1	gage insert
right hand 2403739	6939322110	34,60	35,00	30,10	23,00	32,00	LNUX301940

WIDIA™ Tools for Bar Peeling Applications

Bar peeling is a unique and economical machining operation for the production of cylindrical surfaces on blank bars (e.g., round bars, wires, blocks, and pipes) with high surface finishes and dimensional accuracies.

During the bar peeling process, scales, cracks, and sand inclusion are removed. Bar peeling is faster than conventional turning. It is used when high volumes, high quality, and high productivity with good surface finish are required.



New bar peeling machines demand high performance from cutting tools. WIDIA offers a wide variety of inserts in different grades for cost-effective bar peeling operations in different types of steels, stainless steels, etc. WIDIA also offers toolholders and cartridges for bar peeling as a custom solution.

- Ideal in high feed rate applications, WIDIA bar peeling tools enable economical machining operations for the production of cylindrical surfaces on bright bars.
- High surface finishes, dimensional accuracy, and most efficient removal of scales, cracks, sand enclosures, and other errors.



Application Range of WIDIA™ Bar Peeling Tools

Bar peeling machines require a high level of utilization and demand high performance from the cutting tools. WIDIA offers specially developed tools with indexable inserts for bar peeling, which are capable of meeting these demands, making manufacturing more cost-efficient.

WIDIA Victory™ CVD-Coated Grades

WP15CT

Coated carbide. MT-CVD/CVD — TiN-TiCN-Al₂O₃-ZrCN. Good balance of wear resistance and toughness properties. High productivity machining on smooth to lightly interrupted cuts. For steels.

WP25CT

Coated carbide. MT-CVD/CVD — TiN-TiCN-Al₂O₃-ZrCN. Good toughness properties. Excellent first choice for steel machining. Provides high-productivity metal removal for all but the harshest interrupted cuts.

WP35CT

Coated carbide. MT-CVD/CVD — TiN-TiCN-Al₂O₃-ZrCN. Proven on all roughing and heavy roughing operations, wet or dry, on interrupted and uninterrupted cuts.

WM25CT

Coated carbide. MT-CVD/CVD — TiN-TiCN-Al₂O₃-ZrCN. Good balance of wear resistance and toughness properties. Light and medium machining. For austenitic stainless steel AISI series.

For more information on heavy-duty tooling, contact your local sales representative.

Small Hole Boring

Micro Boring Bars

The WIDIA™ line of micro boring bars provides accurate holemaking tooling in diameters as small as 4,57mm. These economical, indexable inserts are available in both steel and carbide shanks and are stocked in both metric and inch sizes. Ideal for a wide range of applications, including precision micro boring.



Inserts are available in multiple styles and grades, including polycrystalline diamond tipped, for all machining applications.

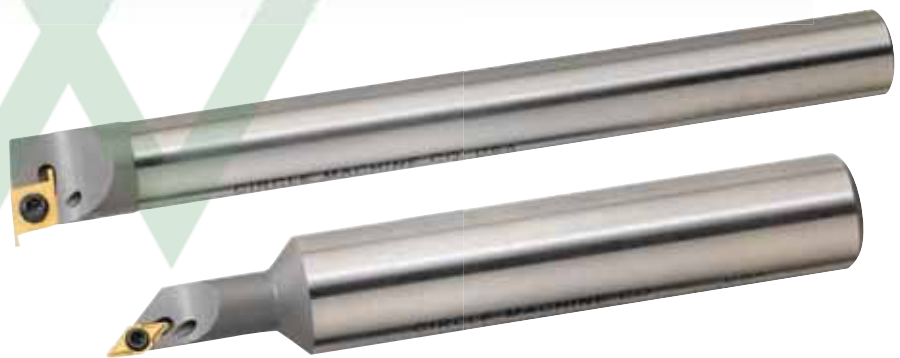

I.D. INDEXABLE INSERT TOOLING



80° DIAMOND INSERT BORING BARS

- Available in shanks as small as 4mm to bore >4,57mm diameter.
- Positive rake geometry for free cutting.
- Superior, unobstructed chip evacuation.
- Stocked in multiple grades to bore a wide range of materials.



THREADING AND GROOVING BORING BARS

- Easy insert changes for threading and grooving.
- Thread down to a 48 TPI, 1,3mm TP (pitch).
- Thread and groove capabilities to an inside bore diameter of 6,91mm.



TRIANGLE INSERT BORING BARS

- Designed for less obstruction and greater chip evacuation.
- Positive rake geometry to bore holes >6,98mm diameter.
- Stocked in all grades, including diamond-tipped and borazon-tipped styles.
- Stocked in shanks as small as 6mm for 7,06mm minimum bore diameter.

APPLICATIONS



BORING

INDUSTRY



Choosing the Correct Small Hole Boring Bar

1 Check the Hole Size to be bored (D min) in the component.
(To check suitability of the product platform)

2 Determine boring bar (D).

- A Select shank size (D) based on your machine's requirements.
- B Determine bore depth (how far the boring bar extends from the holder). Multiply bar diameter by 4. If bore depth is less, use a steel bar. If bore depth exceeds 4:1 ratio, use a carbide bar. Use L1 or L4 depending on bar selected. (See recommended maximum overhang chart on page E297.) For indexable tooling, go to step 3. For all other tooling systems, go directly to step 4.
- C Determine lead angle (KRA). Zero degree lead angle is used when maximum stability is required. Lead angle may vary based on changing conditions, such as boring in a blind hole.

Small Hole Boring Bars for Turning

CCBM • STEPPED

order number	catalogue number	K20	D	D min	F	L1	L4	A	°	°	°	group insert
right hand	CCBM4M1625R	30	16.00	5.78	2.84	89.72	37.25	3.18	0°	0°	0°	CG 547302

C **A** **B**

3 Determine which chipbreaker is best for the material to be machined.

Consult the Small Hole Boring Chipbreaker Geometry charts on page E266.

Small Hole Boring

Chipbreaker Geometries • Single-Sided, Positive Inserts

- JHB:** Flat inserts. Peripheral ground for best surface quality and reduced cutting forces. Very stable cutting edge offers maximum rigidity.
- HT:** Peripheral ground insert chipbreaker. Good chip control. Suitable for general purpose applications.
- CCBM-51:** Cubic Bore Inserts (CBI) or Poly-crystalline Diamond (PCD) for high-temp alloy and non-ferrous machining. Very stable cutting edge offers maximum rigidity.

4 Determine which grade is best for the material to be machined.

Consult the Grades and Grade Descriptions charts on pages E268–E269.

Grades and Grade Descriptions

Small Hole Boring Inserts

Coatings provide high-speed capability and are engineered for finishing to light roughing.

Coating	Grade Description	wear resistance → toughness								
		05	10	15	20	25	30	35	40	45
CBI HW 825	Uncoated carbide. A very tough, ultra-fine grain alloyed substrate. For general purpose machining of most steels, stainless steels, high-temperature alloys, titanium, iron, and non-ferrous materials. Performs best at low speeds and will handle interruptions and high feed rates. Use when C2, C3, or C35 fail due to chipping or breaking.	P								
		M								
		K								
		N								
		O								

Choosing the Correct Small Hole Boring Bar

(continued)

5 Select the appropriate insert based on style, grade, and geometry.

Small Hole Boring • Positive Inserts

CDHB

● first choice

○ alternative choice

Material Group	C2	C25	C3	CG5	CG55
P	●	●	●	●	●
M	○	○	○	○	○
K	○	○	○	○	○
L	○	○	○	○	○
H	○	○	○	○	○

ISO catalogue number	D	1.10	1.00	0.05	2.13	max DOC	C2	C25	C3	CG5	CG55
CDHB4T000	3.07	4.00	1.00	0.05	2.13	—	●	●	●	●	●
CDHB4T00M	3.07	4.00	1.00	0.20	2.13	1.00	○	○	○	○	○
CDHB4T002	3.07	4.00	1.00	0.18	2.13	—	●	●	●	●	●
CDHB4T002M	3.07	4.00	1.00	0.18	2.13	0.08	○	○	○	○	○
CDHB4T004	3.07	4.00	1.00	0.36	2.13	—	●	●	●	●	●

NOTE: Max.DOC only applies to tapered inserts, which are designated with an "M" at the end of the catalog number.

6 Determine the Speed and Feed Chart with the appropriate cutting data.

- A Based on grade and edge geometry, identify starting speed (vc) and feed (fz). The first choice starting feed is in bold.
- B Use the corresponding speed located in the same column below the feed information.

Speed and Feed Chart







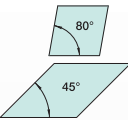
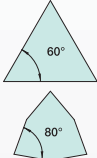
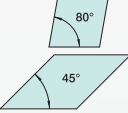
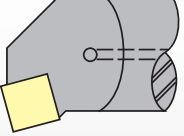
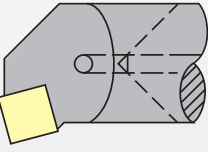

Positive Inserts • Metric

Cutting Speed — vc m/min

Material Group	C2			C25			C3			CG5			CG55			
	min	Start	max	min	Start	max	min	Start	max	min	Start	max	min	Start	max	
P	ap [mm]	—	—	—	—	—	—	—	—	0.251	0.326	0.051	0.300	—	0.300	
	f [mm/rev]	—	—	—	—	—	—	—	—	0.025	0.030	0.005	0.005	—	0.005	
	1	95	115	140	105	130	155	—	—	—	—	—	—	—	—	
M	ap [mm]	0.051	—	0.300	0.051	—	0.300	0.051	—	0.300	0.051	—	0.300	0.051	—	0.300
	f [mm/rev]	0.025	—	0.300	0.025	—	0.300	0.025	—	0.300	0.025	—	0.300	0.025	—	0.300
	1	55	70	85	60	80	95	80	80	95	75	90	110	80	100	120
K	ap [mm]	0.051	—	0.300	0.051	—	0.300	0.051	—	0.300	0.051	—	0.300	0.051	—	0.300
	f [mm/rev]	0.025	—	0.300	0.025	—	0.300	0.025	—	0.300	0.025	—	0.300	0.025	—	0.300
	1	55	65	80	60	70	85	60	70	85	60	70	90	65	80	100
L	ap [mm]	0.051	—	0.300	0.051	—	0.300	0.051	—	0.300	0.051	—	0.300	0.051	—	0.300
	f [mm/rev]	0.025	—	0.300	0.025	—	0.300	0.025	—	0.300	0.025	—	0.300	0.025	—	0.300
	1	400	505	605	400	505	605	400	505	605	400	505	605	445	555	665
H	ap [mm]	0.051	—	0.300	0.051	—	0.300	0.051	—	0.300	0.051	—	0.300	0.051	—	0.300
	f [mm/rev]	0.025	—	0.300	0.025	—	0.300	0.025	—	0.300	0.025	—	0.300	0.025	—	0.300
	1	295	370	440	295	370	445	295	370	445	295	370	445	325	405	490
S	ap [mm]	0.051	—	0.300	0.051	—	0.300	0.051	—	0.300	0.051	—	0.300	0.051	—	0.300
	f [mm/rev]	0.025	—	0.300	0.025	—	0.300	0.025	—	0.300	0.025	—	0.300	0.025	—	0.300
	1	30	35	45	30	35	45	30	35	45	30	35	45	35	40	50
T	ap [mm]	0.025	—	0.121	0.025	—	0.121	0.025	—	0.121	0.025	—	0.121	0.025	—	0.121
	f [mm/rev]	0.025	—	0.121	0.025	—	0.121	0.025	—	0.121	0.025	—	0.121	0.025	—	0.121
	1	25	30	35	25	30	35	25	30	35	25	30	35	25	30	35

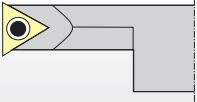
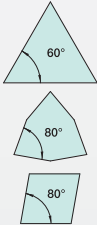
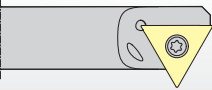
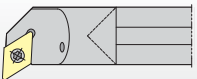
Catalog Numbering System

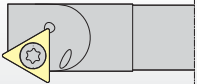
Each character in our catalog number signifies a specific trait of that product. Use the following key columns and corresponding images to easily identify which attributes apply.

C	S	B	M	
Series Type	Bar Type	Bar Style Designation	Units	Insert Shape (optional)
<p>C</p>  <p>F</p>  <p>G</p> 	<p>S = Steel (with coolant)</p>  <p>C = Carbide (with coolant)</p> 		<p>M = Metric</p>	<p>C</p>  <p>W</p> 
<p>L</p> 	<p>B Boring Bar</p> 	<p>O Offset Boring Bar</p> 		
<p>Q</p> 	<p>C External Chamfering Bar</p> 	<p>P Profiling Bar</p> 		
<p>S</p> 	<p>I Internal Threading Bar</p> 	<p>R Reverse Chamfer or Back Chamfer Bar</p> 		
	<p>M Offset Internal Grooving Bar</p> 			

Catalog Numbering System

(continued)

52

Head Diameter shown as "D2"

Metric

- 7 = 6,60mm
- 8 = 8,18mm/8,20mm
- 10 = 9,78mm
- 13 = 12,70mm/
12,95mm
- 45 = 4,57mm
- 48 = 4,80mm
- 52 = 5,16mm
- 53 = 5,30mm
- 64 = 6,60mm
- 66 = 6,55mm/6,60mm
- 82 = 8,15mm
- 95 = 9,50mm
- 99 = 9,91mm
- 159 = 15,88mm

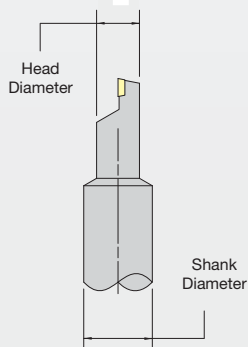

NOTE: Only shown on stepped-style bars.

10

Shank Diameter shown as "D"

Metric

- 4 = 4,00mm
- 5 = 5,00mm
- 6 = 6,00mm
- 8 = 8,00mm
- 10 = 10,00mm
- 12 = 12,00mm
- 16 = 16,00mm

12

Length/Depth shown as "L1/L4"

Bore Length for Step Bars
Thread Depth for Threading Bars
Overall Length for Straight Shank Bars

Metric

- 12 = 12,70mm
- 19 = 19,05mm
- 22 = 22,23mm
- 25 = 25,40mm
- 32 = 31,75mm
- 38 = 38,10mm
- 48 = 47,63mm
- 51 = 50,80mm
- 63 = 63,50mm
- 64 = 64,00mm
- 76 = 76,00mm
- 79 = 79,38mm
- 100 = 100,58mm/
101,50mm/
101,60mm
- 102 = 101,60mm
- 127 = 127,00mm
- 152 = 152,00mm
152,40mm
- 178 = 177,80mm
179,90mm
- 203 = 203,20mm
- 254 = 254,00mm

5

Lead Angle*

0 = 90°
Used for Threading/
Grooving Bars

- 3 = 3°
- 5 = 5°
- 7 = 7°
- 225 = 22.5°
- 30 = 30°
- 45 = 45°
- 60 = 60°

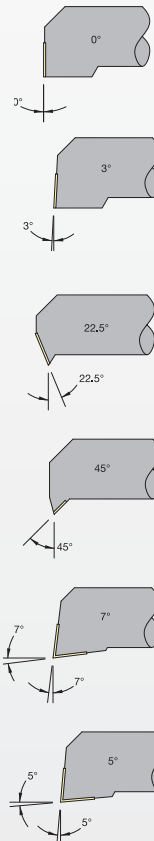

*NOTE: Shown as "KRI" for metric bars.

R

Hand of Tool

R = Right hand
L = Left hand

Right-hand boring bar

R

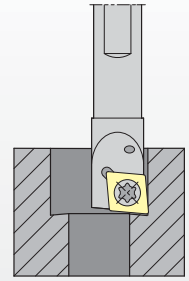

Left-hand boring bar

L

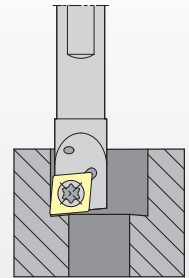

Catalog Numbering System

Each character in our catalog number signifies a specific trait of that product. Use the following key columns and corresponding images to easily identify which attributes apply.

C

Insert Shape

T 60°

C 80°

G 45°

W 80°

D

Insert Clearance Angle

B 5°

C 7°

D 15°

P 11°

H

Tolerance Class

Tolerances apply prior to edge prep and coating.

D = Theoretical diameter of the insert inscribed circle
S = Thickness
B = See figures below

B

Insert Features

S4

Size

"D" mm	Code for metric cutting edge length "L10"			
	C	G	T	W
3,97	S4	05	06	—
4,06	—	—	07	—
4,76	04	06	08	S3
6,35	06	—	11	04
9,53	09	—	16	06
9,80	—	—	17	—

tolerance class	tolerance on "D"	tolerance on "B"	tolerance on "S"
C	±0,025	±0,013	±0,025
H	±0,013	±0,013	±0,025
E	±0,025	±0,025	±0,025
G	±0,025	±0,025	±0,013
M	See tables on next page		±0,013
U	See tables on next page		±0,013

Partly cylindrical hole, 40–60° countersink, single-sided	W	without chipbreaker	
	T	with chipbreaker	

Partly cylindrical hole, 70–90° countersink, single-sided	B	without chipbreaker	
	H	with chipbreaker	

Catalog Numbering System

(continued)

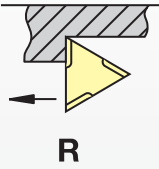
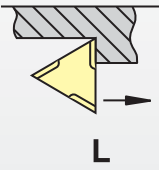
TO		02							
Thickness		Corner Radius "Re"		Hand of Insert (optional)		Cutting Edge Condition or Chip Control Features (optional)		Tip Style (optional)	
symbol mm	thickness mm	symbol mm	corner radius mm	R = Right hand		HP = High positive		Symbol	
T0	1,00; 1,02	X0	0,04; 0,05	L = Left hand		LF = Light finishing		M	
01	1,59; 1,58	01	0,1					Usage	
T1	1,98; 1,91	02	0,2; 0,18					Mini tip	
02	2,38; 2,36	04	0,4; 0,38						
03	3,18	05	0,5						
T3	3,97	08	0,8						
S1	1,19	09	0,9						
		12	1,2						
		16	1,6						
									

"D"	± Tolerance on "D"				"D"	± Tolerance on "B"			
	Class M Tolerance			Class U Tolerance		Class M Tolerance			Class U Tolerance
	Shapes S, T, C, R, & W	Shape D	Shape V	Shapes S, T, & C		Shapes S, T, C, R, & W	Shape D	Shape V	Shapes S, T, & C
mm	mm	mm	mm	mm	mm	mm	mm	mm	mm
3,97	0,05	-	-	-	3,97	0,08	-	-	-
4,76	0,05	-	-	0,08	4,76	0,08	-	-	0,13
5,56	0,05	0,05	0,05	0,08	5,56	0,08	0,11	-	0,13
6,35	0,05	0,05	0,05	0,08	6,35	0,08	0,11	-	0,13
7,94	0,05	0,05	0,05	0,08	7,94	0,08	0,11	-	0,13
9,52	0,05	0,05	0,05	0,08	9,52	0,08	0,11	0,18	0,13
11,11	0,08	0,08	0,08	0,13	11,11	0,13	0,15	-	-
12,70	0,08	0,08	0,08	0,13	12,70	0,13	0,15	0,25	0,20
14,29	0,08	0,08	0,08	0,13	14,29	0,13	0,15	-	-
15,88	0,10	0,10	0,10	0,18	15,88	0,15	0,18	-	0,27
17,46	0,10	0,10	0,10	0,18	17,46	0,15	0,18	-	0,27
19,05	0,10	0,10	0,10	0,18	19,05	0,15	0,18	-	0,27
22,22	0,13	-	-	0,25	22,22	0,15	-	-	0,38
25,40	0,13	-	-	0,25	25,40	0,18	-	-	0,38
31,75	0,15	-	-	0,25	31,75	0,20	-	-	0,38

INDEXABLE MILLING

SOLID END MILLING

HOLEMAKING

TAPPING

TURNING

Small Hole Boring • Insert Selection Guide

INDEXABLE MILLING

The WIDIA™ three-step insert selection system makes choosing and applying the most productive tool easy. Tool recommendations are based on six workpiece material groups.

- 1 Select the Insert Geometry:**
Based on the needed depth of cut and feed rate, choose the geometry that best matches your needs.
- 2 Select the Grade:**
Determine your cutting conditions, and choose the proper grade.

SOLID END MILLING

HOLEMAKING

TAPPING

TURNING

TN7–CM1 for Steel

ISO 513	P				
	01	10	20	30	40
Hard Metal Coated					
		TN7			
		ALO			
		CG6			
		CG55			
			CG5		
			CM1		

wear resistance = harder

- TN7** — High edge strength and wear-resistant cermet. Finishing to semi-finishing of carbon, alloy, and stainless steels at medium to high speeds.
- ALO** — Can withstand light interruptions. Alumina coating enables higher cutting speeds.
- CG6** — High-speed, general-purpose grade for all kinds of steel and cast iron.
- CG55** — High edge strength and wear resistance. Reduces problems with built-up edge. Superior thermal deformation resistance and depth-of-cut notch resistance.
- CG5** — Best at low speeds. Will handle interruptions and high feed rates.
- CM1** — For heavy turning and heavily interrupted cuts.

toughness = softer

ALO–CM1 for Stainless Steel

ISO 513	M				
	01	10	20	30	40
Hard Metal Coated					
		ALO			
		C3 and C25			
		C2			
		CG6			
		CG55			
			CG5		
		CM1			

wear resistance = harder

- ALO** — Can withstand light interruptions. Alumina coating enables higher cutting speeds.
- C3 and C25** — Good wear resistance with some toughness.
- C2** — Excellent abrasion resistance for machining cast irons, austenitic stainless steels, non-ferrous metals, non-metals, and most high-temperature alloys.
- CG6** — High-speed, general-purpose grade for all kinds of steel and cast iron.
- CG55** — High edge strength and wear resistance. Reduces problems with built-up edge. Superior thermal deformation resistance and depth-of-cut notch resistance.
- CG5** — Best at low speeds. Will handle interruptions and high feed rates.
- CM1** — For heavy turning and heavily interrupted cuts.

toughness = softer

3 Select the Cutting Speed:

In the foldout speed and feed chart, establish your cutting speed and obtain your optimal starting conditions and range.

P	Steel
M	Stainless Steel
K	Cast Iron
N	Non-Ferrous
S	High-Temp Alloys
H	Hardened Materials

TN7–CM1 for Cast Iron

ISO 513	K				
	01	10	20	30	40
Hard Metal Coated	TN7				
	ALO				
	CG6				
	CG55				
	C3 and C25				
	C2				
	CG5				
	CM1				

wear resistance = harder

TN7 — High edge strength and wear-resistant cermet.

ALO — Can withstand light interruptions. Alumina coating enables higher cutting speeds.

CG6 — High-speed, general-purpose grade for all kinds of steel and cast iron.

CG55 — High edge strength and wear resistance. Reduces problems with built-up edge. Superior thermal deformation resistance and depth-of-cut notch resistance.

C3 and C25 — Good wear resistance with some toughness.

C2 — Excellent abrasion resistance for machining cast irons, austenitic stainless steels, non-ferrous metals, non-metals, and most high-temperature alloys.

CG5 — Best at low speeds. Will handle interruptions and high feed rates.

CM1 — For heavy turning and heavily interrupted cuts.

toughness = softer

C3–CM1 for High-Temperature Alloys

ISO 513	S				
	01	10	20	30	40
Hard Metal Coated	C3 and C25				
	C2				
	CG5				
	CM1				

wear resistance = harder

C3 and C25 — Good wear resistance with some toughness.

C2 — Excellent abrasion resistance for machining cast irons, austenitic stainless steels, non-ferrous metals, non-metals, and most high-temperature alloys.

CG5 — Best at low speeds. Will handle interruptions and high feed rates.

CM1 — For heavy turning and heavily interrupted cuts.

toughness = softer

Chipbreaker Geometries • Single-Sided, Positive Inserts

INDEXABLE MILLING

SOLID END MILLING

HOLEMAKING

TAPPING

TURNING

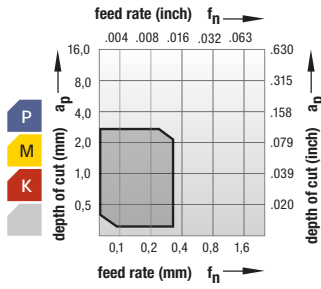

..HB
Flat inserts. Peripheral ground for best surface quality and reduced cutting pressure. Very stable cutting edge offers maximum rigidity.

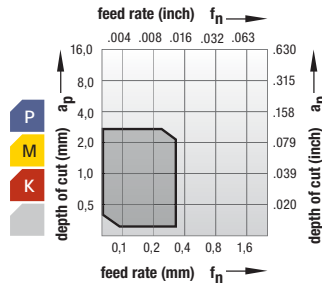

..HT
Peripheral ground insert chipbreaker. Good chip control. Geometry for general-purpose applications.

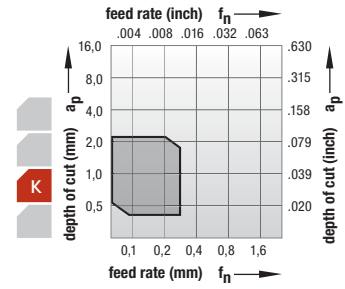

..HB-M
Cubic Boron Nitride (CBN) or Polycrystalline Diamond (PCD) tip for high-temp alloys and non-ferrous machining. Very stable cutting edge offers maximum rigidity.

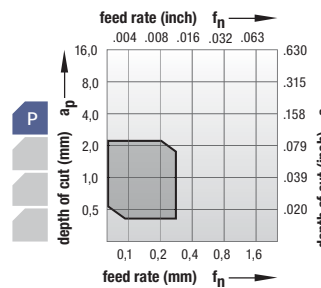

..LF
Geometry for general-purpose applications. Very good chip control. Recommended for general finish machining.

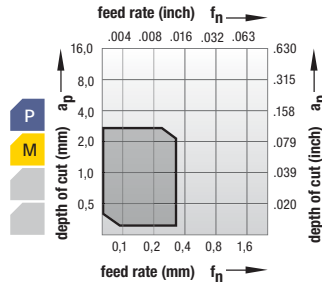

..HH
Peripheral ground for best surface quality and reduced cutting pressure. For fine to medium finishes.

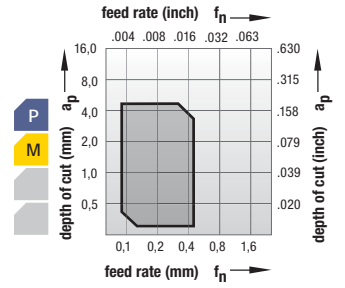

HP
High positive-type chipbreaker. Peripheral ground for best surface quality and reduced cutting pressure. Recommended for high-temp alloys and non-ferrous machining.

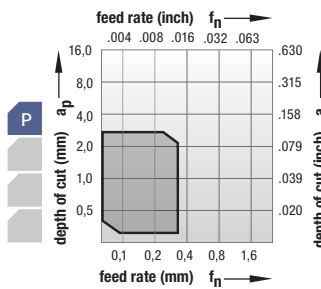

..HH-R/L
Ground-in chipbreaker. Peripheral ground for best surface quality and reduced cutting pressure.
*Right-hand inserts used in left-hand bars ONLY. Left-hand inserts used in right-hand bars ONLY.

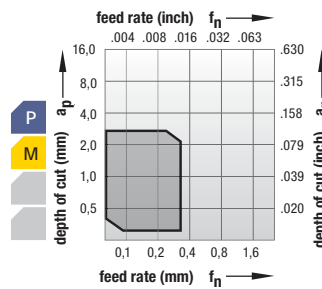

..HW
Flat insert for profiling. Very stable cutting edge offers maximum rigidity.

Chipbreaker Geometries • Geometry Selection Criteria

Flat Top-Type Inserts

Chipbreaker Geometry ..HB, ..HB-M, ..HW

- Suitable for interrupted cuts.
- Use when chip control is not critical.

Pressed Chipbreaker-Type Inserts

Chipbreaker Geometry ..LF

- Suitable for moderate interruption of cuts.
- Use when chip control is a concern.

Pressed Chipbreaker-Type Inserts with Ground Periphery

Chipbreaker Geometry ..HH, ..HT, HP

- Suitable for light to moderate interruption of cuts.
- Use when chip control is a concern.
- Superior surface finish and closer tolerance on workpiece.

Ground-In Chipbreaker-Type Inserts

Chipbreaker Geometry ..HH-R/L

- Suitable for smooth cuts.
- Use when chip control is a concern.
- Superior surface finish and closer tolerance on workpiece.

INDEXABLE MILLING

SOLID END MILLING

HOLEMAKING

TAPPING

TURNING

Small Hole Boring Inserts

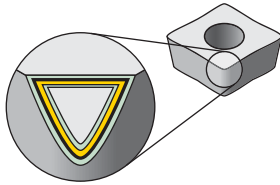

Coatings provide high-speed capability and are engineered for finishing to light roughing.

P	Steel
M	Stainless Steel
K	Cast Iron
N	Non-Ferrous
S	High-Temp Alloys
H	Hardened Materials

wear resistance ← → toughness

Grade	Coating	Grade Description	Material Group																		
			P	M	K	N	S	H	05	10	15	20	25	30	35	40	45				
CM1		Uncoated carbide. A very tough, ultra-fine grain unalloyed substrate. For general-purpose machining of most steels, stainless steels, high-temperature alloys, titanium, irons, and non-ferrous materials. Performs best at low speeds and will handle interruptions and high feed rates. Use when C2, C3, or C25 fail due to chipping or breaking.	P																		
	HW-S25		M																		
C2		Uncoated carbide. A hard, low binder content, unalloyed WC/Co fine-grained grade. General-purpose grade for non-ferrous materials. Has excellent abrasion resistance for machining cast irons, austenitic stainless steels, non-ferrous metals, non-metals, and most high-temperature alloys.	K																		
	HW-N15		N																		
C3 and C25		Uncoated carbide. Has excellent abrasion resistance for machining cast irons, aluminum, and non-ferrous metals. Good wear resistance with some toughness. Harder than C2, resulting in greater edge wear resistance. Suitable for finishing operations.	S																		
	HW-K15		M																		
TN7		A highly wear-resistant (TiC/TiN-based) cermet grade. High edge strength and wear-resistant cermet offers improved tool life over uncoated/coated carbides and resists material build-up on cutting edge. Finishing to semi-finishing of carbon, alloy, and stainless steels at medium to high speeds. Can also be used on non-ferrous materials.	K																		
	HT-P15		P																		
ALO		Coated carbide. CVD — TiCN-TiC-Al ₂ O ₃ . A thin alumina coating over a hard, deformation-resistant substrate. High-speed finishing of gray cast irons and medium-speed finishing of alloy steels that are in a hardness range of 35–50 HRC. Can withstand light interruptions. Alumina coating enables higher cutting speeds.	K																		
	HC-K15		M																		

Small Hole Boring Inserts

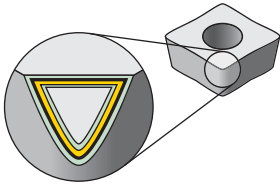

Coatings provide high-speed capability and are engineered for finishing to light roughing.

P	Steel
M	Stainless Steel
K	Cast Iron
N	Non-Ferrous
S	High-Temp Alloys
H	Hardened Materials

Grade	Coating	Grade Description	wear resistance ← → toughness																			
			05	10	15	20	25	30	35	40	45											
CG6	 HC-P10	Coated carbide. CVD — TiC-TiCN-TiN. Tri-phase coating on a hard, low binder content, fine-grained grade. High-speed, general-purpose grade for all kinds of steel. Gold in color.	P																			
			M																			
CG5	 HC-S25	A PVD-TiN-coated grade. Straight 9.5% Co substrate. Submicron grain. For general-purpose machining of most steels, stainless steels, high-temperature alloys, titanium, irons, and non-ferrous materials. Performs best at low speeds and will handle interruptions and high feed rates.	P																			
			M																			
CG55	 HC-M20	A PVD-TiN coating over a very wear-resistant, unalloyed carbide substrate. For general-purpose machining of most steels, stainless steels, high-temperature alloys, titanium, irons, and non-ferrous materials. Grade provides combination of high edge strength and wear resistance. Coating increases wear resistance and reduces problems with built-up edge. The substrate offers superior thermal deformation resistance and depth-of-cut notch resistance.	P																			
			M																			
CBN6	 BN-H25	PcBN tip brazed onto a carbide insert. Recommended for machining hardened steel (45–65 HRC). Use on bearing steel, hot and cold work tool steels, high-speed steels, die steels, case-hardened steels, carburized and nitrided irons, and some hard coatings. Can be run both dry and wet.	P																			
			M																			
CPD1	 DP-N10	Polycrystalline diamond (PCD) compact grade provides exceptional hardness and abrasion resistance. CPD1 is a superior finish boring grade that will significantly improve workpiece tolerances, surface finishes, and insert tool life in high-silicon aluminum, copper, aluminum carbon graphite, hard rubber, plastics, and/or wood.	P																			
			M																			

INDEXABLE MILLING

SOLID END MILLING

HOLEMAKING

TAPPING

TURNING

Speed and Feed Chart

Positive Inserts • Metric

Material Group		Cutting Speed – vc m/min																	
		C2			C25			C3			CG5			CG55			CG6		
		min	Start	max	min	Start	max	min	Start	max	min	Start	max	min	Start	max	min	Start	max
P	ap [mm]	-	-	-	-	-	-	-	-	-	0,051	-	0,300	0,051	-	0,300	0,051	-	0,300
	f [mm/rev]	-	-	-	-	-	-	-	-	-	0,025	-	0,300	0,025	-	0,300	0,025	-	0,300
	0/1	-	-	-	-	-	-	-	-	-	95	115	140	105	130	155	125	155	190
	2	-	-	-	-	-	-	-	-	-	60	75	90	65	85	100	80	100	125
	3	-	-	-	-	-	-	-	-	-	60	75	90	65	85	100	80	100	125
	4	-	-	-	-	-	-	-	-	-	45	60	70	50	65	80	65	80	95
	5	-	-	-	-	-	-	-	-	-	60	75	90	65	85	100	80	100	125
6	-	-	-	-	-	-	-	-	-	40	50	60	45	55	70	55	65	80	
M	ap [mm]	0,051	-	0,300	0,051	-	0,300	0,051	-	0,300	0,051	-	0,300	0,051	-	0,300	0,051	-	0,300
	f [mm/rev]	0,025	-	0,300	0,025	-	0,300	0,025	-	0,300	0,025	-	0,300	0,025	-	0,300	0,025	-	0,300
	1	55	70	80	60	80	95	60	80	95	75	90	110	80	100	120	95	115	140
	2	50	60	75	55	70	85	55	70	85	65	80	100	75	90	110	85	105	125
3	35	45	55	45	50	65	45	50	65	50	60	75	55	65	80	60	80	95	
K	ap [mm]	0,051	-	0,300	0,051	-	0,300	0,051	-	0,300	0,051	-	0,300	0,051	-	0,300	0,051	-	0,300
	f [mm/rev]	0,025	-	0,300	0,025	-	0,300	0,025	-	0,300	0,025	-	0,300	0,025	-	0,300	0,025	-	0,300
	1	50	65	80	60	70	85	60	70	85	60	75	90	65	80	100	75	90	110
	2	65	80	100	75	90	110	75	90	110	75	95	115	85	105	125	95	115	140
3	50	60	75	55	65	80	55	65	80	55	70	80	60	75	90	65	85	100	
N	ap [mm]	0,051	-	0,300	0,051	-	0,300	0,051	-	0,300	0,051	-	0,300	0,051	-	0,300	-	-	-
	f [mm/rev]	0,025	-	0,300	0,025	-	0,300	0,025	-	0,300	0,025	-	0,300	0,025	-	0,300	-	-	-
	1	400	505	605	400	505	605	400	505	605	400	505	605	445	555	665	-	-	-
	2	295	370	440	295	370	445	295	370	445	295	370	445	325	405	490	-	-	-
	3	70	85	105	70	85	105	70	85	105	85	105	125	90	115	135	-	-	-
	4	310	380	465	310	385	465	310	385	465	140	175	210	155	190	230	-	-	-
	5	145	185	220	145	185	220	145	185	220	175	220	265	195	240	290	-	-	-
	6	140	175	210	140	175	210	140	175	210	170	210	255	185	235	280	-	-	-
7	240	295	355	240	300	360	240	300	360	245	305	365	265	335	400	-	-	-	
S	ap [mm]	0,025	-	0,200	0,025	-	0,200	0,025	-	0,200	0,025	-	0,200	0,025	-	0,200	-	-	-
	f [mm/rev]	0,025	-	0,127	0,025	-	0,127	0,025	-	0,127	0,025	-	0,127	0,025	-	0,127	-	-	-
	1	30	35	45	30	35	45	30	35	45	30	35	45	35	40	50	-	-	-
	2	25	30	35	25	30	35	25	30	35	25	30	35	25	35	40	-	-	-
	3	25	30	35	25	30	35	25	30	35	30	40	50	35	45	55	-	-	-
4	25	30	35	25	30	35	25	30	35	-	-	-	-	-	-	-	-	-	
H	ap [mm]	-	-	-	-	-	-	-	-	-	-	-	-	-	-	-	-	-	-
	f [mm/rev]	-	-	-	-	-	-	-	-	-	-	-	-	-	-	-	-	-	-
	1	-	-	-	-	-	-	-	-	-	-	-	-	-	-	-	-	-	-
	2	-	-	-	-	-	-	-	-	-	-	-	-	-	-	-	-	-	-
	3	-	-	-	-	-	-	-	-	-	-	-	-	-	-	-	-	-	-
4	-	-	-	-	-	-	-	-	-	-	-	-	-	-	-	-	-	-	

NOTE: Speed and feed rates and depth of cut may vary depending on materials and machining conditions including, but not limited to, tool overhang, tool size, and finished surface requirements.

INDEXABLE MILLING

SOLID END MILLING

HOLEMAKING

TAPPING

TURNING

Positive Inserts • Metric

Material Group		Cutting Speed – vc m/min														
		CM1			ALO			TN7			CBN6			CPD1		
		min	Start	max	min	Start	max	min	Start	max	min	Start	max	min	Start	max
P	ap [mm]	0,051	–	0,300	0,051	–	0,300	0,051	–	0,300	–	–	–	–	–	–
	f [mm/rev]	0,025	–	0,300	0,025	–	0,300	0,025	–	0,300	–	–	–	–	–	–
	0/1	55	65	80	165	205	245	200	245	295	–	–	–	–	–	–
	2	35	45	55	105	135	160	130	160	190	–	–	–	–	–	–
	3	35	45	55	105	135	160	130	160	190	–	–	–	–	–	–
	4	25	35	40	85	105	125	100	125	150	–	–	–	–	–	–
	5	35	45	55	105	135	160	130	160	190	–	–	–	–	–	–
6	25	30	35	70	90	105	85	105	130	–	–	–	–	–	–	
M	ap [mm]	0,051	–	0,300	0,051	–	0,300	0,051	–	0,300	–	–	–	–	–	–
	f [mm/rev]	0,025	–	0,300	0,025	–	0,300	0,025	–	0,300	–	–	–	–	–	–
	1	55	65	80	105	130	160	105	130	155	–	–	–	–	–	–
	2	50	60	75	95	120	145	95	115	140	–	–	–	–	–	–
K	ap [mm]	0,051	–	0,300	0,051	–	0,300	0,051	–	0,300	–	–	–	–	–	–
	f [mm/rev]	0,025	–	0,300	0,025	–	0,300	0,025	–	0,300	–	–	–	–	–	–
	1	45	60	70	125	155	185	80	105	125	–	–	–	–	–	–
	2	60	75	90	160	200	240	105	130	160	–	–	–	–	–	–
N	ap [mm]	0,051	–	0,300	–	–	–	0,051	–	0,300	–	–	–	0,051	–	0,300
	f [mm/rev]	0,025	–	0,300	–	–	–	0,025	–	0,300	–	–	–	0,025	–	0,300
	1	400	505	605	–	–	–	400	505	605	–	–	–	855	1065	1280
	2	295	370	445	–	–	–	295	370	445	–	–	–	650	810	975
	3	70	85	105	–	–	–	80	100	120	–	–	–	365	455	550
	4	100	125	150	–	–	–	195	240	290	–	–	–	325	405	490
	5	145	185	220	–	–	–	195	245	295	–	–	–	340	425	510
	6	140	175	210	–	–	–	175	220	265	–	–	–	335	420	505
7	240	295	360	–	–	–	240	300	365	–	–	–	525	660	790	
S	ap [mm]	0,025	–	0,200	–	–	–	–	–	–	0,025	–	0,200	–	–	–
	f [mm/rev]	0,025	–	0,127	–	–	–	–	–	–	0,025	–	0,127	–	–	–
	1	25	30	40	–	–	–	–	–	–	90	110	135	–	–	–
	2	20	25	30	–	–	–	–	–	–	70	85	105	–	–	–
	3	25	35	40	–	–	–	–	–	–	100	120	145	–	–	–
H	ap [mm]	–	–	–	–	–	–	–	–	–	0,025	–	0,200	–	–	–
	f [mm/rev]	–	–	–	–	–	–	–	–	–	0,025	–	0,127	–	–	–
	1	–	–	–	–	–	–	–	–	–	110	135	165	–	–	–
	2	–	–	–	–	–	–	–	–	–	105	130	155	–	–	–
	3	–	–	–	–	–	–	–	–	–	100	120	145	–	–	–
4	–	–	–	–	–	–	–	–	–	90	110	135	–	–	–	

NOTE: Speed and feed rates and depth of cut may vary depending on materials and machining conditions including, but not limited to, tool overhang, tool size, and finished surface requirements.

Insert Cross Reference Chart

WIDIA-CIRCLE™ catalog number	New ISO/ANSI catalog number
CDCD	CDHB
CDCG	CDHH
CDCT	CDHH
CPCA	CPHB
CPCM	CPHH
GCCD	GCHW
GCCT	GCHT
GPCD	GPHW
GPCT	GPHT
TD6P	TPHB
TDAB	TDHB
TDAT	TDHH
TDCG	TDHH
TPCB	TPHB
TPCG	TPHH
TPCH	TPHH
TPGH	TPHH
TPMT	TPMT
WPGT	WPHT



Hardware

Insert Screws

order number	ISO catalogue number	Torx/hex	internal thread
2840098	MSM46	2 mm	M4X0.7
2892513	BS832	5/64	—
2832635	CT11	T6	#1-72
2830477	FC11	T7	—
2828337	GT21	T7	#2-56
2825941	QTM20	T7	M2.5X0.45
2825948	QTM26	T7	M2.5X0.45
2826005	QC15	T8	#3-48
2826038	QC21	T9	#4-40
2823203	STM31	T15	M3.5 X 0.6
2832641	CT15	T16	#1-72

Wrenches

order number	ISO catalogue number	Torx/hex
2832628	CKEY	T6
2830492	FKEY	T7
2825982	QKEY	T9
2823182	SKEY	T10

Drive Bits

order number	ISO catalogue number	Torx/hex
2832661	CBIT	T6
2830497	FBIT	T7

Wedges

order number	ISO catalogue number
2840192	AW250/AW-250

INDEXABLE MILLING

SOLID END MILLING

HOLEMAKING

TAPPING

TURNING

CDHB

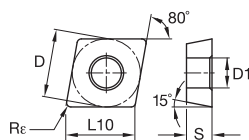
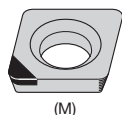

● first choice

○ alternate choice

P	●	○	○	○	○	○	○	○	○	○	○	○	○	○	○	○	○	○
M	○	○	○	○	○	○	○	○	○	○	○	○	○	○	○	○	○	○
K	○	○	○	○	○	○	○	○	○	○	○	○	○	○	○	○	○	○
N	○	○	○	○	○	○	○	○	○	○	○	○	○	○	○	○	○	○
S	○	○	○	○	○	○	○	○	○	○	○	○	○	○	○	○	○	○
H	○	○	○	○	○	○	○	○	○	○	○	○	○	○	○	○	○	○

ISO catalogue number	D	L10	S	Rε	D1	max DOC	C2	C25	C3	CG5	CG55	CG6	CM1	ALO	TN7	CBN6	CPD1
CDHBS4T0X0	3,97	4,03	1,02	0,05	2,13	—	—	2830897	—	3884731	—	2830888	2830881	—	—	—	—
CDHBS4T0X0M	3,97	4,03	1,02	0,05	2,13	1,90	—	—	—	—	—	—	—	—	—	2830746	—
CDHBS4T002	3,97	4,03	1,02	0,18	2,13	—	—	2830864	—	3884732	—	2830853	2830848	—	—	2830843	—
CDHBS4T002M	3,97	4,03	1,02	0,18	2,13	0,96	—	—	—	—	—	—	—	—	—	2830741	—
CDHBS4T004	3,97	4,03	1,02	0,38	2,13	—	—	2830830	—	2830788	—	2830817	2830813	—	—	2830803	—

NOTE: Max DOC only applies to tipped inserts, which are designated with an "M" at the end of the catalog number.

INDEXABLE MILLING

SOLID END MILLING

HOLE-MAKING

TAPPING

TURNING

CDHH • R/L

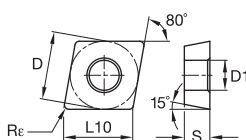
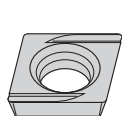

● first choice

○ alternate choice

P					●	○	○	○	○	○	○	○	○	○	○	○	○	○	○
M					○	○	○	○	○	○	○	○	○	○	○	○	○	○	○
K					●	●	●	●	●	○	○	○	○	○	○	○	○	○	○
N					●	●	●	●	○	○	○	○	○	○	○	○	○	○	○
S					○	○	○	○	○	○	○	○	○	○	○	○	○	○	○
H					○	○	○	○	○	○	○	○	○	○	○	○	○	○	○

ISO catalogue number	D	L10	S	Rε	D1	C2	C25	C3	CG5	CG55	CG6	CM1	ALO	TN7	CBN6	CPD1	
right hand																	
CDHHS4T002R	3,97	4,03	1,02	0,18	2,13				2830731			2830706					
CDHHS4T004R	3,97	4,03	1,02	0,38	2,13				2830682								
left hand																	
CDHHS4T002L	3,97	4,03	1,02	0,18	2,13				2830724			2830712 2830700					
CDHHS4T004L	3,97	4,03	1,02	0,38	2,13				2830678								

CDHH

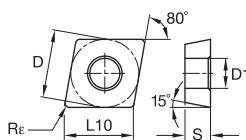
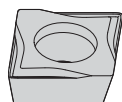

● first choice

○ alternate choice

P					●	○	○	○	○	○	○	○	○	○	○	○	○	○
M					○	○	○	○	○	○	○	○	○	○	○	○	○	○
K					●	●	●	●	○	○	○	○	○	○	○	○	○	○
N					●	●	●	●	○	○	○	○	○	○	○	○	○	○
S					○	○	○	○	○	○	○	○	○	○	○	○	○	○
H					○	○	○	○	○	○	○	○	○	○	○	○	○	○

ISO catalogue number	D	L10	S	Rε	D1	C2	C25	C3	CG5	CG55	CG6	CM1	ALO	TN7	CBN6	CPD1	
neutral hand																	
CDHHS4T002	3,97	4,03	1,02	0,18	2,13				2830632			2830638					
CDHHS4T004	3,97	4,10	1,02	0,38	2,13				2830619								

Small Hole Boring • Positive Inserts

INDEXABLE MILLING

CPHB

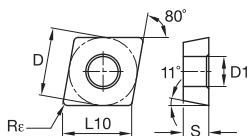

- first choice
- alternate choice

P	●	○	○	○	○	○	○	○	○	○	○	○	○	○	○	○	○	○	○	○
M	○	○	○	○	○	○	○	○	○	○	○	○	○	○	○	○	○	○	○	○
K	○	○	○	○	○	○	○	○	○	○	○	○	○	○	○	○	○	○	○	○
N	○	○	○	○	○	○	○	○	○	○	○	○	○	○	○	○	○	○	○	○
S	○	○	○	○	○	○	○	○	○	○	○	○	○	○	○	○	○	○	○	○
H	○	○	○	○	○	○	○	○	○	○	○	○	○	○	○	○	○	○	○	○

ISO catalogue number	D	L10	S	Rε	D1	C2	C25	C3	CG5	CG55	CG6	CM1	ALO	TN7	CBN6	CPD1
CPHB06T102	6,35	6,45	1,90	0,18	2,79	○	○	○	○	○	○	○	○	○	○	○
CPHB06T104	6,35	6,45	1,90	0,38	2,79	○	○	○	○	○	○	○	○	○	○	○

SOLID END MILLING

HOLEMAKING

CPHH

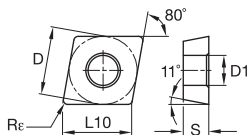
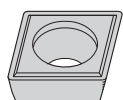

- first choice
- alternate choice

P	○	○	○	○	○	○	○	○	○	○	○	○	○	○	○	○	○	○	○	○
M	○	○	○	○	○	○	○	○	○	○	○	○	○	○	○	○	○	○	○	○
K	○	○	○	○	○	○	○	○	○	○	○	○	○	○	○	○	○	○	○	○
N	○	○	○	○	○	○	○	○	○	○	○	○	○	○	○	○	○	○	○	○
S	○	○	○	○	○	○	○	○	○	○	○	○	○	○	○	○	○	○	○	○
H	○	○	○	○	○	○	○	○	○	○	○	○	○	○	○	○	○	○	○	○

ISO catalogue number	D	L10	S	Rε	D1	C2	C25	C3	CG5	CG55	CG6	CM1	ALO	TN7	CBN6	CPD1
CPHH06T102	6,35	6,45	1,91	0,18	2,79	○	○	○	○	○	○	○	○	○	○	○
CPHH06T104	6,35	6,45	1,91	0,38	2,80	○	○	○	○	○	○	○	○	○	○	○

TAPPING

TURNING

CPMT-LF

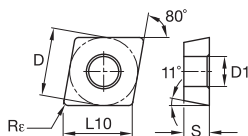
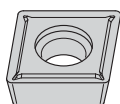

● first choice
○ alternate choice

P	●	○	○	○	○	○	○	○	○	○	○	○	○	○	○	○	○
M	○	○	○	○	○	○	○	○	○	○	○	○	○	○	○	○	○
K	○	○	○	○	○	○	○	○	○	○	○	○	○	○	○	○	○
N	○	○	○	○	○	○	○	○	○	○	○	○	○	○	○	○	○
S	○	○	○	○	○	○	○	○	○	○	○	○	○	○	○	○	○
H	○	○	○	○	○	○	○	○	○	○	○	○	○	○	○	○	○

ISO catalogue number	D	L10	S	Rε	D1	C2	C25	C3	CG5	CG55	CG6	CM1	ALO	TN7	CBN6	CPD1	
CPMT09T302LF	9,53	9,67	3,97	0,20	4,40	○	○	○	○	○	○	○	○	○	○	○	○
CPMT09T304LF	9,53	9,67	3,97	0,40	4,40	○	○	○	○	○	○	○	○	○	○	○	○
CPMT09T308LF	9,53	9,67	3,97	0,80	4,40	○	○	○	○	○	○	○	○	○	○	○	○

GCHW

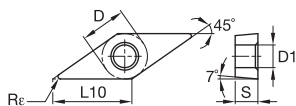
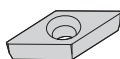

● first choice
○ alternate choice

P	●	○	○	○	○	○	○	○	○	○	○	○	○	○	○	○	○
M	○	○	○	○	○	○	○	○	○	○	○	○	○	○	○	○	○
K	○	○	○	○	○	○	○	○	○	○	○	○	○	○	○	○	○
N	○	○	○	○	○	○	○	○	○	○	○	○	○	○	○	○	○
S	○	○	○	○	○	○	○	○	○	○	○	○	○	○	○	○	○
H	○	○	○	○	○	○	○	○	○	○	○	○	○	○	○	○	○

ISO catalogue number	D	L10	S	Rε	D1	C2	C25	C3	CG5	CG55	CG6	CM1	ALO	TN7	CBN6	CPD1
GCHW060202	4,76	6,73	2,36	0,18	2,39	○	○	○	○	○	○	○	○	○	○	○
GCHW060204	4,76	6,73	2,36	0,38	2,39	○	○	○	○	○	○	○	○	○	○	○

INDEXABLE MILLING
SOLID END MILLING
HOLEMAKING
TAPPING
TURNING

Small Hole Boring • Positive Inserts

INDEXABLE MILLING

GCHT

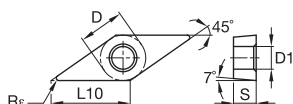
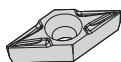

- first choice
- alternate choice

P	●	○	○	○	○	○	○	○	○	○	○	○	○	○	○	○	○	○	○
M	○	○	○	○	○	○	○	○	○	○	○	○	○	○	○	○	○	○	○
K	○	○	○	○	○	○	○	○	○	○	○	○	○	○	○	○	○	○	○
N	○	○	○	○	○	○	○	○	○	○	○	○	○	○	○	○	○	○	○
S	○	○	○	○	○	○	○	○	○	○	○	○	○	○	○	○	○	○	○
H	○	○	○	○	○	○	○	○	○	○	○	○	○	○	○	○	○	○	○

ISO catalogue number	D	L10	S	Rε	D1	C2	C25	C3	CG5	CG55	CG6	CM1	ALO	TN7	CBN6	CPD1
GCHT060202	4,83	6,83	2,36	0,18	2,39				2827537							
GCHT060204	4,76	6,83	2,36	0,38	2,39				2827525			2827531				

SOLID END MILLING

HOLEMAKING

GPHW

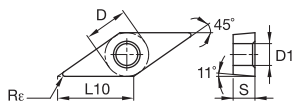
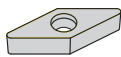

- first choice
- alternate choice

P	○	○	○	○	○	○	○	○	○	○	○	○	○	○	○	○	○	○	○
M	○	○	○	○	○	○	○	○	○	○	○	○	○	○	○	○	○	○	○
K	○	○	○	○	○	○	○	○	○	○	○	○	○	○	○	○	○	○	○
N	○	○	○	○	○	○	○	○	○	○	○	○	○	○	○	○	○	○	○
S	○	○	○	○	○	○	○	○	○	○	○	○	○	○	○	○	○	○	○
H	○	○	○	○	○	○	○	○	○	○	○	○	○	○	○	○	○	○	○

ISO catalogue number	D	L10	S	Rε	D1	C2	C25	C3	CG5	CG55	CG6	CM1	ALO	TN7	CBN6	CPD1
GPHW050102	3,97	5,61	1,59	0,18	2,13				2827631		2827625	2827637				
GPHW050104	3,97	5,61	1,59	0,38	2,13				2827615		2827608	2827621				

TAPPING

TURNING

GPHT

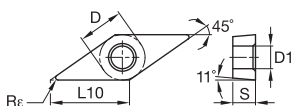
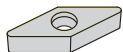

● first choice
○ alternate choice

P	●				●	○	○	○	○	○	○	○	○	○	○	○	○
M	○	○	○	○	○	○	○	○	○	○	○	○	○	○	○	○	○
K	○	○	○	○	○	○	○	○	○	○	○	○	○	○	○	○	○
N	○	○	○	○	○	○	○	○	○	○	○	○	○	○	○	○	○
S	○	○	○	○	○	○	○	○	○	○	○	○	○	○	○	○	○
H	○	○	○	○	○	○	○	○	○	○	○	○	○	○	○	○	○

ISO catalogue number	D	L10	S	Rε	D1	C2	C25	C3	CG5	CG55	CG6	CM1	ALO	TN7	CBN6	CPD1
GPHT050102	3,97	5,76	1,57	0,18	2,13				2827560	2827560						
GPHT050104	4,08	5,76	1,57	0,38	2,13				2827548	2827566	2827566	2827554				

TBHB

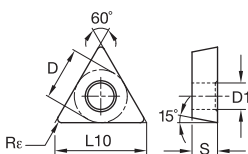
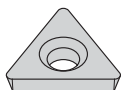

● first choice
○ alternate choice

P	●				●	○	○	○	○	○	○	○	○	○	○	○	○
M	○	○	○	○	○	○	○	○	○	○	○	○	○	○	○	○	○
K	○	○	○	○	○	○	○	○	○	○	○	○	○	○	○	○	○
N	○	○	○	○	○	○	○	○	○	○	○	○	○	○	○	○	○
S	○	○	○	○	○	○	○	○	○	○	○	○	○	○	○	○	○
H	○	○	○	○	○	○	○	○	○	○	○	○	○	○	○	○	○

ISO catalogue number	D	L10	S	Rε	D1	C2	C25	C3	CG5	CG55	CG6	CM1	ALO	TN7	CBN6	CPD1
TBHB07S1X0	4,06	7,04	1,19	0,05	2,39				2828556	2828556						
TBHB110201	6,35	11,00	2,38	0,10	3,33				2824266	2824266						

Small Hole Boring • Positive Inserts

TDHB

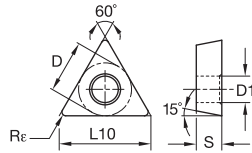
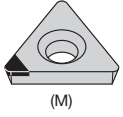

- first choice
- alternate choice

P																				
M																				
K																				
N																				
S																				
H																				

ISO catalogue number	D	L10	S	Rε	D1	max DOC	C2	C25	C3	CG5	CG55	CG6	CM1	ALO	TN7	CBN6	CPD1
TDHB07S102M	4,06	7,04	1,19	0,18	2,39	1,27											
TDHB07S104M	4,06	7,04	1,19	0,38	2,39	1,27											
TDHB07S1X0	4,06	7,04	1,19	0,05	2,41	—		2828784		2828796							
TDHB07S102	4,06	7,04	1,19	0,18	2,41	—		2828732		2828755		2828749	2828727			2828720	
TDHB07S104	4,06	7,04	1,19	0,38	2,41	—		2828697		2828708		2828702	2828693			2828688	
TDHB07S108	4,06	7,04	1,19	0,79	2,41	—				2828682							

NOTE: Max DOC only applies to tipped inserts, which are designated with an "M" at the end of the catalog number.

INDEXABLE MILLING

SOLID END MILLING

HOLE MAKING

TAPPING

TURNING

TPHB

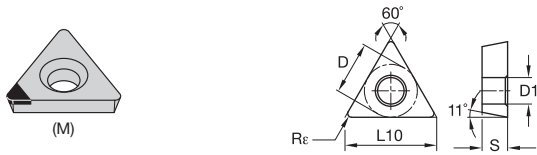

- first choice
- alternate choice

P	●	○	○	○	○	○	○	○	○	○	○	○	○	○	○	○	○	○	○	○
M	○	○	○	○	○	○	○	○	○	○	○	○	○	○	○	○	○	○	○	○
K	○	○	○	○	○	○	○	○	○	○	○	○	○	○	○	○	○	○	○	○
N	○	○	○	○	○	○	○	○	○	○	○	○	○	○	○	○	○	○	○	○
S	○	○	○	○	○	○	○	○	○	○	○	○	○	○	○	○	○	○	○	○
H	○	○	○	○	○	○	○	○	○	○	○	○	○	○	○	○	○	○	○	○

ISO catalogue number	D	L10	S	Re	D1	max DOC	C2	C25	C3	CG5	CG55	CG6	CM1	ALO	TN7	CBN6	CPD1
TPHB1102X0	6,35	11,00	2,38	0,05	3,30	—	○	○	○	○	○	○	○	○	○	○	○
TPHB1102X0M	6,35	11,00	2,38	0,05	3,30	1,62	○	○	○	○	○	○	○	○	○	○	○
TPHB110202	6,35	11,00	2,38	0,18	3,30	—	○	○	○	○	○	○	○	○	○	○	○
TPHB110202M	6,35	11,00	2,38	0,18	3,30	1,62	○	○	○	○	○	○	○	○	○	○	○
TPHB110204M	6,35	11,00	2,38	0,40	3,30	1,62	○	○	○	○	○	○	○	○	○	○	○
TPHB110204	6,35	11,00	2,38	0,38	3,30	—	○	○	○	○	○	○	○	○	○	○	○
TPHB110208	6,35	11,00	2,38	0,79	3,30	—	○	○	○	○	○	○	○	○	○	○	○
TPHB1603X0	9,53	16,50	3,18	0,05	3,30	—	○	○	○	○	○	○	○	○	○	○	○
TPHB160302	9,53	16,50	3,18	0,18	3,30	—	○	○	○	○	○	○	○	○	○	○	○
TPHB160304	9,53	16,50	3,18	0,38	3,30	—	○	○	○	○	○	○	○	○	○	○	○
TPHB160308	9,53	16,50	3,18	0,79	3,30	—	○	○	○	○	○	○	○	○	○	○	○
TPCB160302	9,53	—	3,23	0,18	3,30	—	○	○	○	○	○	○	○	○	○	○	○

NOTE: Max DOC only applies to tipped inserts, which are designated with an "M" at the end of the catalog number.

TPHH • R/L

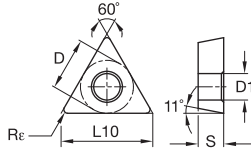
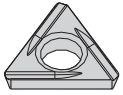

● first choice
○ alternate choice

P	●	○	○	○	○	○	○	○	○	○	○	○	○	○	○	○	○	○
M	○	○	○	○	○	○	○	○	○	○	○	○	○	○	○	○	○	○
K	○	○	○	○	○	○	○	○	○	○	○	○	○	○	○	○	○	○
N	○	○	○	○	○	○	○	○	○	○	○	○	○	○	○	○	○	○
S	○	○	○	○	○	○	○	○	○	○	○	○	○	○	○	○	○	○
H	○	○	○	○	○	○	○	○	○	○	○	○	○	○	○	○	○	○

ISO catalogue number	D	L10	S	Rε	D1	C2	C25	C3	CG5	CG55	CG6	CM1	ALO	TN7	CBN6	CPD1	
right hand																	
TPHH110202R	6,35	11,00	2,38	0,18	3,33				2823812								
TPHH160302R	9,53	16,50	3,18	0,18	3,33				2821213								
TPHH160304R	9,53	16,50	3,18	0,38	3,33				2821168								
TPHH160308R	9,53	16,50	3,18	0,79	3,33				2821121								
left hand																	
TPHH110202L	6,35	11,00	2,38	0,18	3,33				2823805					2823767			
TPHH110204L	6,35	11,00	2,38	0,38	3,33				2823753		2823739						
TPHH160302L	9,53	16,50	3,18	0,18	3,33				2821208								
TPHH160304L	9,53	16,50	3,18	0,38	3,33				2821162		2821150						
TPHH160308L	9,53	16,50	3,18	0,79	3,33				2821115								

INDEXABLE MILLING

SOLID END MILLING

HOLEMAKING

TAPPING

TURNING

TPHH

INDEXABLE MILLING

SOLID END MILLING

HOLEMAKING

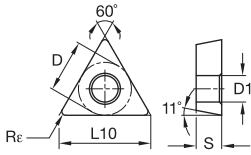
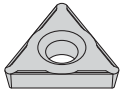

- first choice
- alternate choice

	P	M	K	N	S	H	C2	C25	C3	CG5	CG55	CG6	CM1	ALO	TN7	CBN6	CPD1
TPHH110202																	
TPHH110204																	
TPCH110204																	

TPHH-LF

TAPPING

TURNING

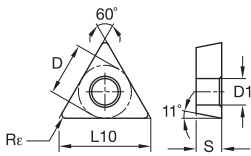
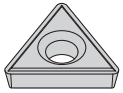

- first choice
- alternate choice

	P	M	K	N	S	H	C2	C25	C3	CG5	CG55	CG6	CM1	ALO	TN7	CBN6	CPD1
TPHH160304																	
TPHH160304LF																	
TPHH160308																	
TPHH160308																	
TPHH17T309LF																	

TPGT-HP

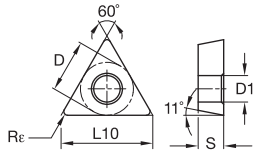
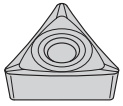

● first choice
○ alternate choice

	C2	C25	C3	CG5	CG55	CG6	CM1	ALO	TN7	CBN6	CPD1
P	●	○	○	○	○	○	○	○	○	○	○
M	○	○	○	○	○	○	○	○	○	○	○
K	○	○	○	○	○	○	○	○	○	○	○
N	○	○	○	○	○	○	○	○	○	○	○
S	○	○	○	○	○	○	○	○	○	○	○
H	○	○	○	○	○	○	○	○	○	○	○

ISO catalogue number	D	L10	S	Rε	D1	C2	C25	C3	CG5	CG55	CG6	CM1	ALO	TN7	CBN6	CPD1
TPGT110202HP	6,35	11,00	2,38	0,20	2,90	○	○	○	○	○	○	○	○	○	○	○
TPGT110204HP	6,35	11,00	2,38	0,40	2,90	○	○	○	○	○	○	○	○	○	○	○
TPGT16T304HP	9,53	16,50	3,97	0,40	4,40	○	○	○	○	○	○	○	○	○	○	○

TPMT-LF

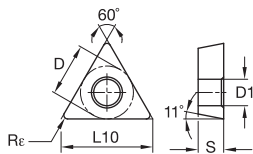
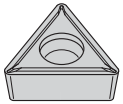

● first choice
○ alternate choice

	C2	C25	C3	CG5	CG55	CG6	CM1	ALO	TN7	CBN6	CPD1
P	○	○	○	○	○	○	○	○	○	○	○
M	○	○	○	○	○	○	○	○	○	○	○
K	○	○	○	○	○	○	○	○	○	○	○
N	○	○	○	○	○	○	○	○	○	○	○
S	○	○	○	○	○	○	○	○	○	○	○
H	○	○	○	○	○	○	○	○	○	○	○

ISO catalogue number	D	L10	S	Rε	D1	C2	C25	C3	CG5	CG55	CG6	CM1	ALO	TN7	CBN6	CPD1
TPMT110202LF	6,35	11,00	2,38	0,20	2,80	○	○	○	○	○	○	○	○	○	○	○
TPMT110204LF	6,35	11,00	2,38	0,40	2,90	○	○	○	○	○	○	○	○	○	○	○
TPMT160304LF	9,53	16,50	3,18	0,40	4,40	○	○	○	○	○	○	○	○	○	○	○
TPMT160308LF	9,53	16,50	3,18	0,79	4,40	○	○	○	○	○	○	○	○	○	○	○

WPHT

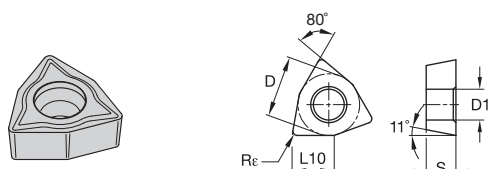

● first choice
○ alternate choice

ISO catalogue number	D	L10	S	R ϵ	D1																
						C2	C25	C3	CG5	CG55	CG6	CM1	ALO	TN7	CBN6	CPD1					
WPHTS30101	4,76	3,26	1,59	0,10	2,16					●	○	○	○	○	○	○	○	○	○	○	
WPHTS30102	4,76	3,26	1,59	0,20	2,16					○	○	○	○	○	○	○	○	○	○	○	
WPHTS30104	4,76	3,26	1,59	0,40	2,16					○	○	○	○	○	○	○	○	○	○	○	
WPGT040202UF	6,35	4,34	2,38	0,20	2,79							○	○	○	○	○	○	○	○	○	
WPHT040201	6,35	4,34	2,38	0,10	2,80							○	○	○	○	○	○	○	○	○	
WPHT040204	6,35	4,34	2,38	0,40	2,80							○	○	○	○	○	○	○	○	○	

WPMT-LF

- first choice
- alternate choice

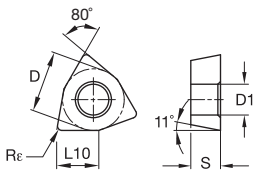
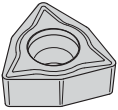

	P	M	K	N	S	H
C2	●	○	○	○	○	○
C25	○	○	○	○	○	○
C3	○	○	○	○	○	○
CG5	○	○	○	○	○	○
CG55	○	○	○	○	○	○
CG6	○	○	○	○	○	○
CM1	○	○	○	○	○	○
ALO	○	○	○	○	○	○
TN7	○	○	○	○	○	○
CBN6	○	○	○	○	○	○
CPD1	○	○	○	○	○	○

ISO catalogue number	D	L10	S	Rε	D1	C2	C25	C3	CG5	CG55	CG6	CM1	ALO	TN7	CBN6	CPD1
WPMTS3T104LF	4,76	3,26	1,98	0,40	2,15	○	○	○	○	○	○	○	○	○	○	○
WPMT040204LF	6,35	4,34	2,38	0,40	2,90	○	○	○	○	○	○	○	○	○	○	○
WPMT06T304LF	9,53	6,52	3,97	0,40	4,40	○	○	○	○	○	○	○	○	○	○	○
WPMT06T308LF	9,53	6,52	3,97	0,80	4,40	○	○	○	○	○	○	○	○	○	○	○

CDG • R/L

- first choice
- alternate choice

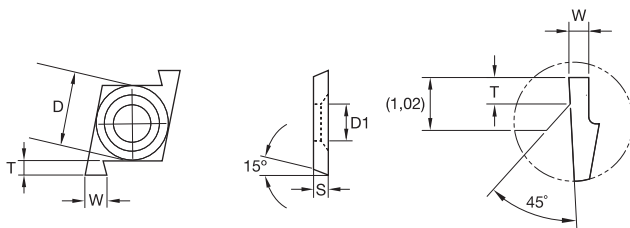
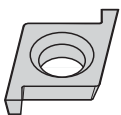

NOTE: Detail of 0,38 insert.

	P	M	K	N	S	H
C2	○	○	○	○	○	○
C25	○	○	○	○	○	○
C3	○	○	○	○	○	○
CG5	○	○	○	○	○	○
CG55	○	○	○	○	○	○
CG6	○	○	○	○	○	○
CM1	○	○	○	○	○	○
ALO	○	○	○	○	○	○
TN7	○	○	○	○	○	○
CBN6	○	○	○	○	○	○
CPD1	○	○	○	○	○	○

ISO catalogue number right hand	D	S	T	W	D1	C2	C25	C3	CG5	CG55	CG6	CM1	ALO	TN7	CBN6	CPD1
CDG50252R	3,97	1,27	1,02	0,64	2,13	○	○	○	○	○	○	○	○	○	○	○
CDG50302R	3,97	1,27	1,02	0,76	2,13	○	○	○	○	○	○	○	○	○	○	○

Small Hole Boring • Positive Inserts

CPG • R/L

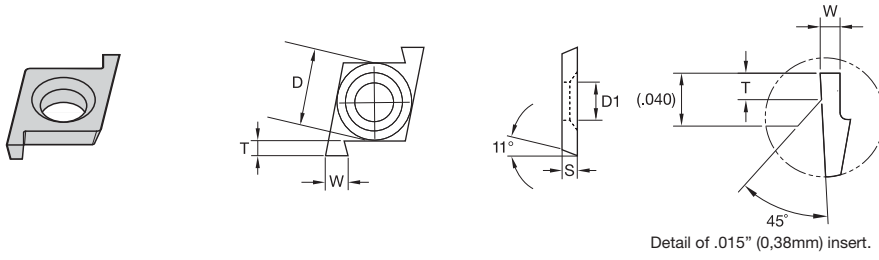

● first choice
○ alternate choice

P						●	○	○	○	○	○	○	○	○
M	●	○	○	○	○	○	○	○	○	○	○	○	○	○
K	○	●	●	●	●	○	○	○	○	○	○	○	○	○
N	○	○	○	○	○	○	○	○	○	○	○	○	○	○
S	○	○	○	○	○	○	○	○	○	○	○	○	○	○
H														○

ISO catalogue number	D	S	T	W	D1	C2	C25	C3	CG5	CG55	CG6	CM1	ALO	TN7	CBN6	CPD1
right hand																
CPG2032R	6,35	1,91	1,65	0,76	2,79				2824546							
CPG2062R	6,35	1,91	1,65	1,52	2,79				2824531							

CDT • R/L

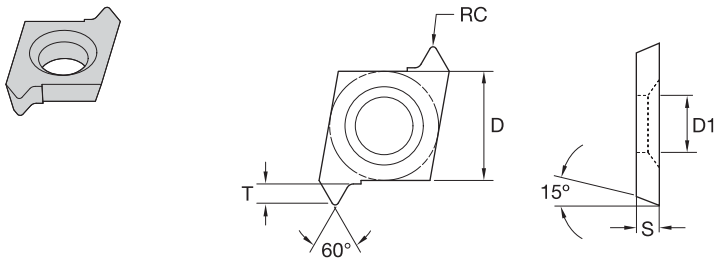

● first choice
○ alternate choice

P						○	○	○	○	○	○	○	○	○
M	○	○	○	○	○	○	○	○	○	○	○	○	○	○
K	○	○	○	○	○	○	○	○	○	○	○	○	○	○
N	○	○	○	○	○	○	○	○	○	○	○	○	○	○
S	○	○	○	○	○	○	○	○	○	○	○	○	○	○
H														○

catalogue number	D	S	T	RC	D1	TP min	TP max	TPI min	TPI max	C2	C25	C3	CG5	CG55	CG6	CM1	ALO	TN7	CBN6	CPD1
CDT50022R	3,97	1,27	0,76	0,05	2,11	0,5	1,0	24,0	48,0				2830567							

CPT • R/L

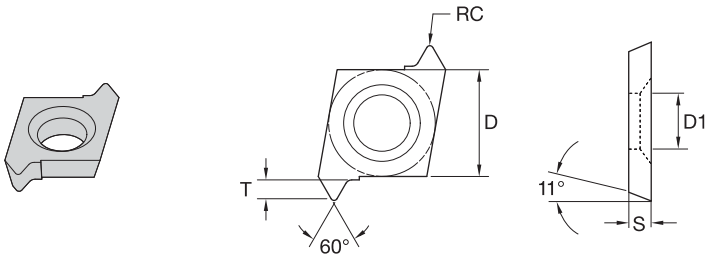

● first choice
○ alternate choice

P						●														
M	●										●									
K						●					●									
N		●								●										●
S										●				●						
H																			●	

ISO catalogue number	D	S	T	RC	D1	TPI min	TPI max	TP min	TP max	C2	C25	C3	CG5	CG55	CG6	CM1	ALO	TN7	CBN6	CPD1	
CPT20052R	6,35	1,91	1,65	0,13	2,79	10	24	1,0	2,5	-	-	-	2824516	-	-	2824523	-	-	-	-	-

INDEXABLE MILLING

SOLID END MILLING

HOLEMAKING

TAPPING

TURNING

CCBM • STEPPED

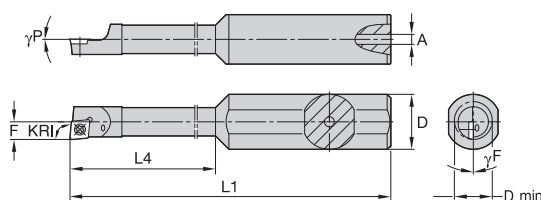

order number	catalogue number	KRI	D	D min	F	L1	L4	A	γ_F°	γ_P°	gage insert
right hand											
3896015	CCBM4816225R	95	16,00	5,28	2,64	85,72	22,23	3,18	0.0°	5.0°	CD..S4T002

CSBM • STEPPED

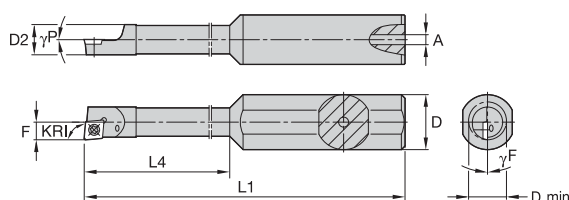

order number	catalogue number	KRI	D	D min	D2	F	L1	L4	A	γ_F°	γ_P°	gage insert
right hand												
2831606	CSBM5210250R	90	10,00	5,94	5,16	3,10	70,00	25,72	1,02	0.0°	5.0°	CD..S4T002
2831639	CSBM5210125R	95	10,00	5,78	5,16	2,95	70,00	12,30	1,02	0.0°	5.0°	CD..S4T002
2831468	CSBM6412325R	95	12,00	7,24	6,60	3,68	70,00	31,75	1,02	0.0°	5.0°	CD..S4T002

CCBM

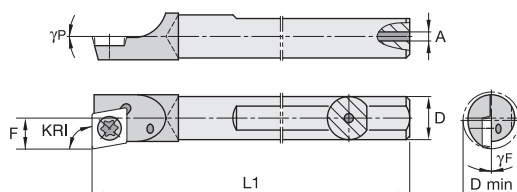

order number	catalogue number	KRI	D	D min	F	L1	A	γ_F°	γ_P°	gage insert
right hand										
2831801	CCBM51000R	90	5,00	5,94	3,18	100,58	1,02	0.0°	5.0°	CD..S4T002
3896025	CCBM61000R	90	6,00	7,08	3,73	100,33	1,19	0.0°	5.0°	CD..S4T002
2831277	CCBM81520R	90	8,00	9,04	4,70	152,15	2,36	0.0°	5.0°	CD..S4T002
2831826	CCBM51005R	95	5,00	5,94	3,02	100,58	1,02	0.0°	5.0°	CD..S4T002
2831311	CCBM61525R	95	6,00	7,08	3,73	152,15	1,19	0.0°	5.0°	CD..S4T002
2831821	CCBM61005R	95	6,00	7,09	3,73	100,33	1,19	0.0°	5.0°	CD..S4T002
2831289	CCBM81525R	95	8,00	9,04	4,70	152,40	2,36	0.0°	5.0°	CD..S4T002
2831832	CCBM41007R	97	3,96	4,57	2,41	100,33	1,02	0.0°	0.0°	CD..S4T002
2831324	CCBM41527R	97	4,00	4,57	2,41	152,00	1,02	0.0°	0.0°	CD..S4T002

CSBM

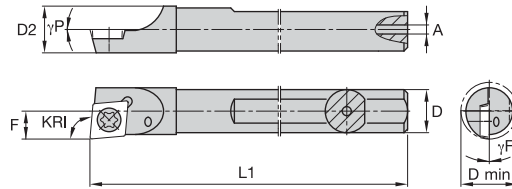

order number	catalogue number	KRI	D	D min	D2	F	L1	A	γ_F°	γ_P°	gage insert
right hand											
3896205	CSBM5650R	90	5,00	5,94	5,16	3,10	63,50	1,02	0.0°	5.0°	CD..S4T002
2831441	CSBM5655R	95	5,00	5,79	5,16	2,95	63,50	1,02	0.0°	5.0°	CD..S4T002
2831687	CSBM6655R	95	6,00	7,09	6,20	3,73	63,50	1,02	0.0°	5.0°	CD..S4T002
2831666	CSBM8765R	95	8,00	9,04	8,18	4,70	76,20	1,52	0.0°	5.0°	CD..S4T002
2831701	CSBM4657R	97	4,00	4,57	4,22	2,41	63,50	1,02	0.0°	0.0°	CD..S4T002
left hand											
2831695	CSBM4657L	97	4,00	4,57	4,22	2,41	63,50	1,02	0.0°	0.0°	CD..S4T002

QSBMW

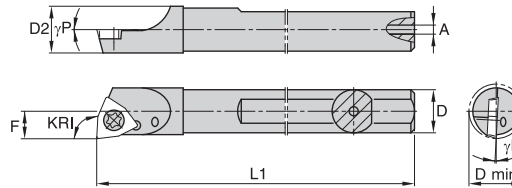

order number	catalogue number	KRI	D	D min	D2	F	L1	A	γ_F°	γ_P°	gage insert
right hand											
3393828	QSBMW121523R	93	12,00	12,90	12,19	6,55	152,40	4,00	-3.0°	0.0°	WP..040204

GSBMW

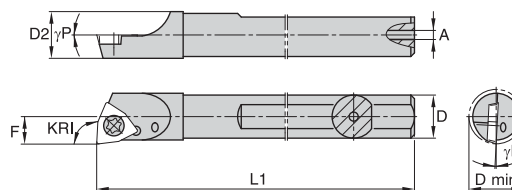

order number	catalogue number	KRI	D	D min	D2	F	L1	A	γ_F°	γ_P°	gage insert
right hand											
2828122	GSBMW61003R	93	6,00	6,78	6,21	3,43	101,60	1,02	-3.0°	0.0°	WP..S30104

Small Hole Boring Bars for Turning

INDEXABLE MILLING

SOLID END MILLING

HOLEMAKING

TAPPING

TURNING

QSBM

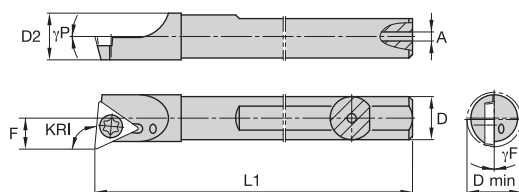

order number	catalogue number	KRI	D	D min	D2	F	L1	A	γ_F°	γ_P°	gage insert
right hand 3886552	QSBM101275R	95	10,00	11,15	10,21	5,79	127,00	3,20	0.0°	5.0°	TP..110202

SDBM

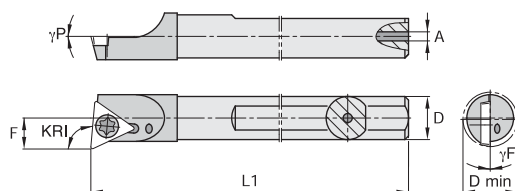

order number	catalogue number	KRI	D	D min	D2	F	L1	A	γ_F°	γ_P°	gage insert
right hand 2822085	SDBM162545R	95	16,00	17,25	16,13	8,89	254,00	5,51	0.0°	5.0°	TP..160302

QCBM

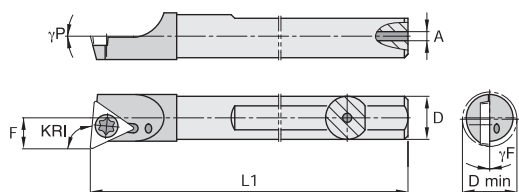

order number	catalogue number	KRI	D	D min	F	L1	A	γ_F°	γ_P°	gage insert
right hand 2824747	QCBM122545R	95	12,00	13,16	6,81	254,00	4,70	0.0°	5.0°	TP..110202

FCBM

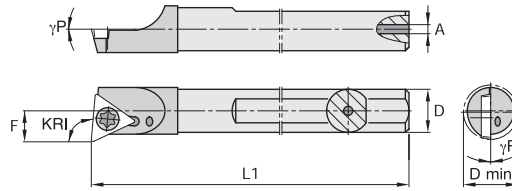

order number	catalogue number	KRI	D	D min	F	L1	A	γ_F°	γ_P°	gage insert
right hand										
3896031	FCBM61520R	90	6,00	7,06	3,70	152,40	1,19	0.0°	5.0°	TD..07S102
2829356	FCBM81520R	90	8,00	9,16	4,80	152,40	2,36	0.0°	5.0°	TD..07S102
2829390	FCBM61525R	95	6,00	7,06	3,71	152,40	1,19	0.0°	5.0°	TD..07S102

FSBM

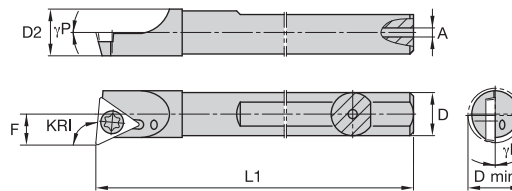

order number	catalogue number	KRI	D	D min	D2	F	L1	A	γ_F°	γ_P°	gage insert
right hand											
2829566	FSBM61005R	95	6,00	7,06	6,20	3,71	101,60	1,02	0.0°	5.0°	TD..07S102

INDEXABLE MILLING

SOLID END MILLING

HOLEMAKING

TAPPING

TURNING

Small Hole Boring Bars for Profiling

INDEXABLE MILLING

SOLID END MILLING

HOLEMAKING

TAPPING

TURNING

CSPM

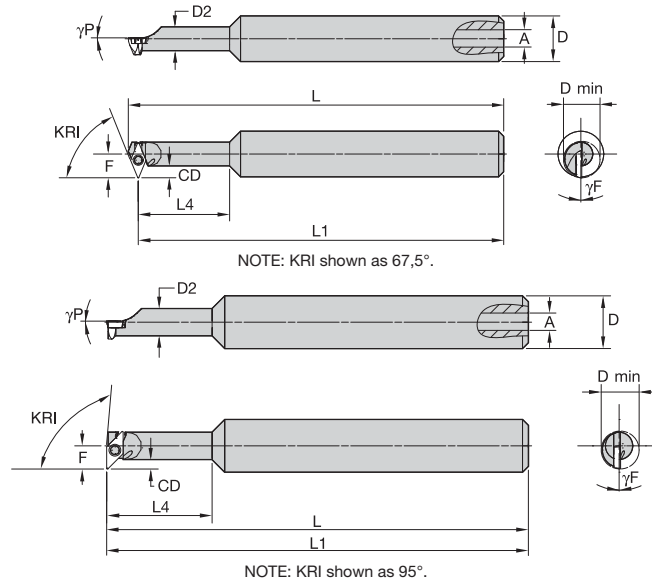

order number	catalogue number	KRI	D	D min	D2	F	CD	L	L1	L4	A	$\gamma^{\circ}F$	$\gamma^{\circ}P$	gage insert
right hand 2831411	CSPM712255R	95.0	12,00	9,14	6,60	5,59	2,29	101,60	101,60	25,40	1,02	0.0°	0.0°	GC..050102
left hand 2831394	CSPM71225225L	67.5	12,00	10,16	6,60	6,60	3,30	104,00	101,60	25,40	1,02	0.0°	0.0°	GPHW050102

CCPM

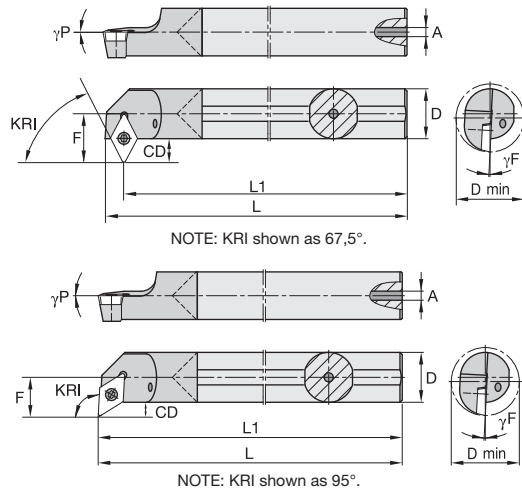

order number	catalogue number	KRI	D	D min	F	CD	L	L1	A	$\gamma^{\circ}F$	$\gamma^{\circ}P$	gage insert
right hand 2831020	CCPM61525R	95.0	6,00	9,14	5,59	2,49	152,40	152,40	1,19	0.0°	0.0°	GP..050102
left hand 3896022	CCPM81525L	95.0	8,00	10,74	6,38	2,28	152,40	152,40	2,23	0.0°	0.0°	GP..050102

LR Series 53° Toolholder

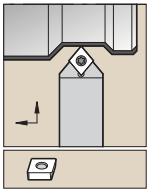

See pages E22-E27, E122, E158, E167-E168 for inserts.

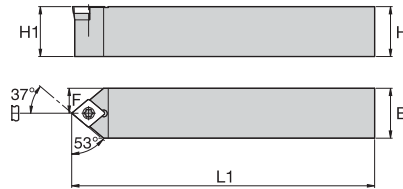

order number	catalogue number	B	F	H	H1	L1	gage insert
left hand 2028218	12157210300	8,00	4,50	8,00	6,00	32,00	CC..0602..

LR Series 45° Boring Bar

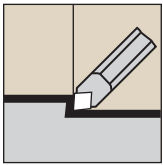

Steel shank without through coolant
See pages E64-E67 for inserts.

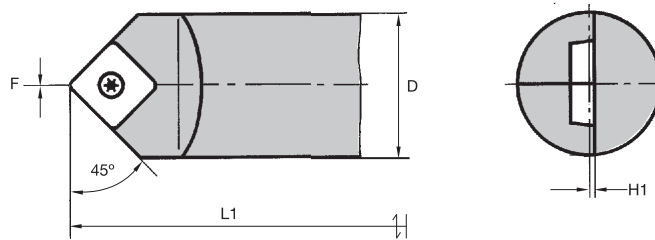

order number	catalogue number	D	F	H1	L1	gage insert
neutral hand 2031213	S30MSSDCN12	30,00	0,00	0,50	150,00	SC..1204..

LR Series 50° Boring Bar

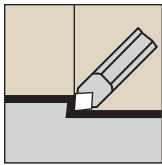

Steel shank without through coolant
See pages E22-E27, E122, E158, E167-E168 for inserts.

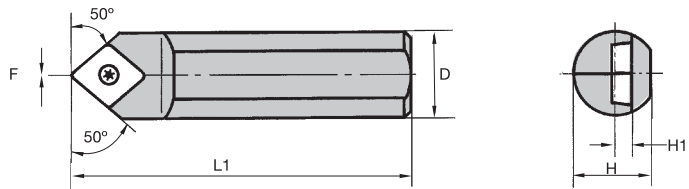

order number	catalogue number	D	F	H	H1	L1	gage insert
neutral hand							
2024091	S08ASCMCN065	8,00	0,00	7,00	6,00	32,00	CC..0602..
2012035	S10BSCMCN06	10,00	0,00	9,00	7,00	40,00	CC..0602..
2031113	S12DSCMCN06	12,00	0,00	11,00	8,00	60,00	CC..0602..
2030994	12157301800	16,00	0,00	15,00	10,00	80,00	CC..09T3..

LR Series 90° Boring Bar

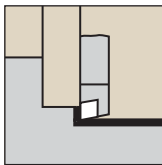

Steel shank without through coolant
See pages E22-E27, E122, E158, E167-E168 for inserts.

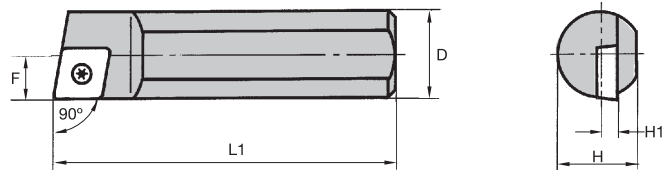

order number	catalogue number	D	F	H	H1	L1	gage insert
right hand							
2031103	S10BSCACR06	10,00	5,30	9,00	7,00	40,00	CC..0602..
left hand							
2031102	S10BSCACL06	10,00	5,30	9,00	7,00	40,00	CC..0602..

LR Series 90° Boring Bar • TC

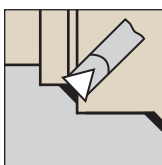

Steel shank without through coolant
See pages E83-E85, E124, E163-E164, E175 for inserts.

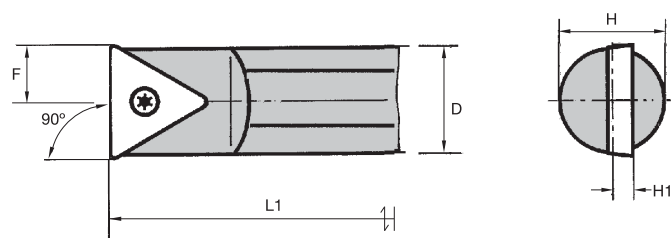

order number	catalogue number	D	F	H	H1	L1	gage insert
neutral hand							
2031104	S10BSTCCN11	10,00	5,20	9,00	2,00	40,00	TC..1102..

Setup Recommendations

Setup Recommendations for Bar Overhang

WIDIA-CIRCLE™ cutting tools are the finest quality boring, grooving, profiling, and threading tools available. For more than 50 years, WIDIA-CIRCLE has been the industry leader in solving small-diameter hole machining problems in major manufacturing plants worldwide.

A common problem associated with any cutting tool is extending the tool beyond its support point. This condition of excessive overhang can cause chatter, poor finishes, or inadequate tool life.

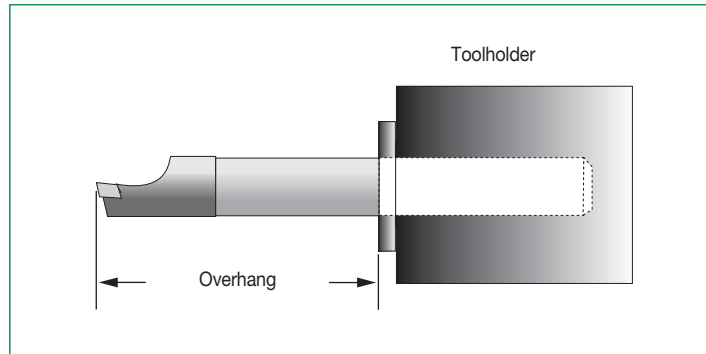

We recommend a 4:1 ratio (4 times bar diameter) overhang when using steel shank bars and up to a 10:1 (10 times bar diameter) overhang when using carbide shank bars. The overhang ratios are affected by many factors:

- Type(s) of material(s) being machined.
- Depth of cut(s).
- Feed rate(s).

Recommended conditions may still be unsatisfactory because of chatter. Chatter can be induced by non-rigid setups or harmonics from the machine or machining conditions. In many cases, changing the RPM of the machine can reduce chatter.

shank diameter (mm)	steel shank ratio 4:1 (mm)	carbide shank ratio 10:1 (mm)
4,00mm	16,00mm	40,00mm
5,00mm	20,00mm	50,00mm
6,00mm	24,00mm	60,00mm
8,00mm	32,00mm	80,00mm
10,00mm	40,00mm	100,00mm
12,00mm	48,00mm	120,00mm
16,00mm	64,00mm	160,00mm
20,00mm	80,00mm	200,00mm
25,00mm	100,00mm	250,00mm
32,00mm	128,00mm	320,00mm

INDEXABLE MILLING

SOLID END MILLING

HOLEMAKING

TAPPING

TURNING

The most versatile tool in the market for grooving, profiling, and cut-off operations.



4 BENEFITS IN 1

VERSATILITY

Single-sided versatile grooving, cut-off, and profiling solution for all materials.

STABILITY

Secure seating and clamping for reliability in demanding groove-turn applications.

PRODUCTIVITY

Higher speeds and feeds due to better chip evacuation and low cutting forces. Optimized chip breaker design and through coolant capability.

SIMPLICITY

Easy to select and apply for all grooving, cut-off, and profiling applications.

GROOVING

PRECISION MOLDED AND GROUND



P M N S

PT-Positive Rake

PRECISION MOLDED



P M K H

PN-Negative Rake

CUT-OFF

PRECISION MOLDED AND GROUND



P M N S

F-Fine

PRECISION MOLDED



P K

M-Medium



P M

R-Rough

Profiling

PRECISION GROUND





P M N S

PC-Full Radius

NOTE: Use the NOVO™ software to select appropriate toolholder and insert.

WIDIA™ GROOVING AND CUT-OFF

INSERTS

APPLICATION	TYPES	GROOVE WIDTH	INSERT GEOMETRY	MATERIALS
GROOVING		2,00–10,13mm (0.084–0.399")	PT-Positive Rake	P M K N S
			PN-Negative Rake	P M K S
CUT-OFF		1,4–8,0mm (0.055–0.315")	F-Fine	P M K N S
			M-Medium	P M K S
			R-Rough	P M K S
PROFILING		2,0–8,0mm (0.079–0.315")	PC-Full Radius	P M K N S

APPLICATIONS



TURNING



PROFILING



FACING



CHAMFERING



GROOVING



CUT-OFF



DEEP
GROOVING



THROUGH
COOLANT

INDUSTRY

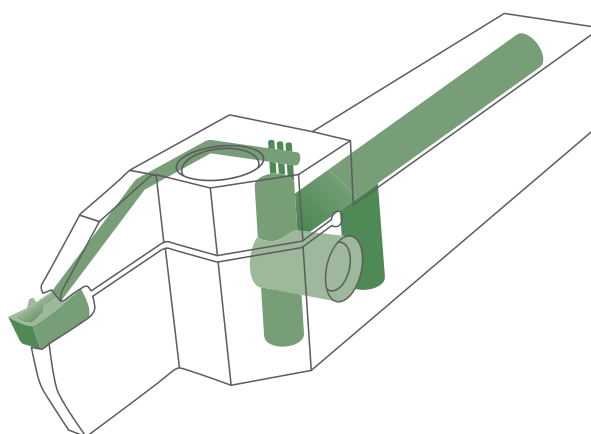

Grooving and Cut-Off • WGC

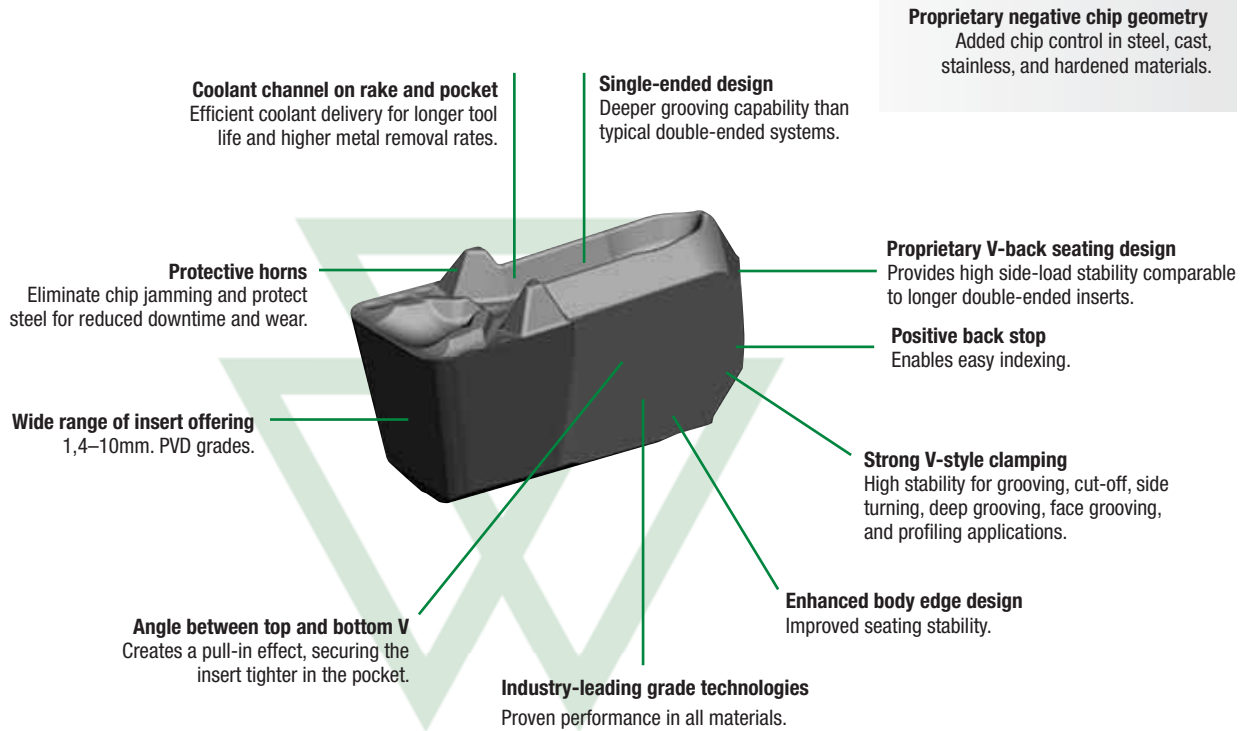

Catalog Numbering System

Each character in our catalog number signifies a specific trait of that product.
Use the following key columns and corresponding images to easily identify which attributes apply.

W	G	0312	M	03	U	02	PT																																																										
Family Name	Insert Type	Groove Width	Unit	Seat Size	Tolerance	Corner Radius	Chipbreaker/ Edge Condition																																																										
WGC	G = Square R = Full Radius	Metric = 1/100mm Inch = 1/1000"	M = Metric I = Inch	<table border="1"> <thead> <tr> <th rowspan="2">seat size (SSC)</th> <th colspan="2">groove width</th> </tr> <tr> <th>mm</th> <th>inch</th> </tr> </thead> <tbody> <tr><td>1B</td><td>1,40</td><td>.055</td></tr> <tr><td>1F</td><td>1,60–1,99</td><td>.063–.078</td></tr> <tr><td>02</td><td>2,00–2,99</td><td>.079–.117</td></tr> <tr><td>03</td><td>3,00–3,99</td><td>.118–.156</td></tr> <tr><td>04</td><td>4,00–4,99</td><td>.157–.196</td></tr> <tr><td>05</td><td>5,00–5,99</td><td>.197–.235</td></tr> <tr><td>06</td><td>6,00–7,99</td><td>.236–.314</td></tr> <tr><td>08</td><td>8,00–8,99</td><td>.315–.353</td></tr> <tr><td>10</td><td>9,00–10,12</td><td>.354–.398</td></tr> </tbody> </table> <p><i>*.312" = seat size 08</i></p>	seat size (SSC)	groove width		mm	inch	1B	1,40	.055	1F	1,60–1,99	.063–.078	02	2,00–2,99	.079–.117	03	3,00–3,99	.118–.156	04	4,00–4,99	.157–.196	05	5,00–5,99	.197–.235	06	6,00–7,99	.236–.314	08	8,00–8,99	.315–.353	10	9,00–10,12	.354–.398	U = Precision Molded P = Precision Ground	<table border="1"> <thead> <tr><th colspan="2">mm</th></tr> </thead> <tbody> <tr><td>00</td><td>full radius</td></tr> <tr><td>01</td><td>0,1</td></tr> <tr><td>02</td><td>0,2</td></tr> <tr><td>04</td><td>0,4</td></tr> <tr><td>08</td><td>0,8</td></tr> <tr><td>12</td><td>1,2</td></tr> </tbody> </table> <table border="1"> <thead> <tr><th colspan="2">inch</th></tr> </thead> <tbody> <tr><td>00</td><td>full radius</td></tr> <tr><td>05</td><td>.008</td></tr> <tr><td>1</td><td>.016</td></tr> <tr><td>2</td><td>.032</td></tr> <tr><td>3</td><td>.047</td></tr> </tbody> </table>	mm		00	full radius	01	0,1	02	0,2	04	0,4	08	0,8	12	1,2	inch		00	full radius	05	.008	1	.016	2	.032	3	.047	PT = Groove-Turn Universal Positive PN = Groove-Turn Universal Negative
seat size (SSC)	groove width																																																																
	mm	inch																																																															
1B	1,40	.055																																																															
1F	1,60–1,99	.063–.078																																																															
02	2,00–2,99	.079–.117																																																															
03	3,00–3,99	.118–.156																																																															
04	4,00–4,99	.157–.196																																																															
05	5,00–5,99	.197–.235																																																															
06	6,00–7,99	.236–.314																																																															
08	8,00–8,99	.315–.353																																																															
10	9,00–10,12	.354–.398																																																															
mm																																																																	
00	full radius																																																																
01	0,1																																																																
02	0,2																																																																
04	0,4																																																																
08	0,8																																																																
12	1,2																																																																
inch																																																																	
00	full radius																																																																
05	.008																																																																
1	.016																																																																
2	.032																																																																
3	.047																																																																

W	C	030	M	03	N	00	F	02																																																																		
Family Name	Insert Type	Cutting Edge Width	Unit	Seat Size	Hand of Insert	Approach Angle	Chipbreaker	Corner Radius																																																																		
WGC	C = Cut-Off	<table border="1"> <thead> <tr><th></th><th>mm</th><th>inch</th></tr> </thead> <tbody> <tr><td>014</td><td>1,4</td><td>.055</td></tr> <tr><td>020</td><td>2,0</td><td>.079</td></tr> <tr><td>030</td><td>3,0</td><td>.118</td></tr> <tr><td>040</td><td>4,0</td><td>.157</td></tr> <tr><td>050</td><td>5,0</td><td>.197</td></tr> <tr><td>060</td><td>6,0</td><td>.236</td></tr> <tr><td>070</td><td>7,0</td><td>.279</td></tr> <tr><td>080</td><td>8,0</td><td>.315</td></tr> </tbody> </table>		mm	inch	014	1,4	.055	020	2,0	.079	030	3,0	.118	040	4,0	.157	050	5,0	.197	060	6,0	.236	070	7,0	.279	080	8,0	.315	M = Metric I = Inch	<table border="1"> <thead> <tr><th></th><th>mm</th><th>inch</th></tr> </thead> <tbody> <tr><td>1B</td><td>1,4</td><td>.055</td></tr> <tr><td>1F</td><td>2,0</td><td>.079</td></tr> <tr><td>02</td><td>3,0</td><td>.118</td></tr> <tr><td>03</td><td>4,0</td><td>.157</td></tr> <tr><td>04</td><td>5,0</td><td>.197</td></tr> <tr><td>05</td><td>6,0</td><td>.236</td></tr> <tr><td>06</td><td>7,0</td><td>.279</td></tr> <tr><td>08</td><td>8,0</td><td>.315</td></tr> </tbody> </table>		mm	inch	1B	1,4	.055	1F	2,0	.079	02	3,0	.118	03	4,0	.157	04	5,0	.197	05	6,0	.236	06	7,0	.279	08	8,0	.315	N = Neutral L = Left hand R = Right hand	00 = Neutral 06 = 6°	F = Cut-Off Low Feed M = Cut-Off Fine R = Cut-Off Rough	<table border="1"> <thead> <tr><th></th><th>mm</th><th>inch</th></tr> </thead> <tbody> <tr><td>01</td><td>0,1</td><td>.004</td></tr> <tr><td>02</td><td>0,2</td><td>.008</td></tr> <tr><td>04</td><td>0,4</td><td>.016</td></tr> </tbody> </table>		mm	inch	01	0,1	.004	02	0,2	.008	04	0,4	.016
	mm	inch																																																																								
014	1,4	.055																																																																								
020	2,0	.079																																																																								
030	3,0	.118																																																																								
040	4,0	.157																																																																								
050	5,0	.197																																																																								
060	6,0	.236																																																																								
070	7,0	.279																																																																								
080	8,0	.315																																																																								
	mm	inch																																																																								
1B	1,4	.055																																																																								
1F	2,0	.079																																																																								
02	3,0	.118																																																																								
03	4,0	.157																																																																								
04	5,0	.197																																																																								
05	6,0	.236																																																																								
06	7,0	.279																																																																								
08	8,0	.315																																																																								
	mm	inch																																																																								
01	0,1	.004																																																																								
02	0,2	.008																																																																								
04	0,4	.016																																																																								

Grades and Grade Descriptions

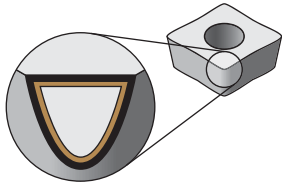

Coatings provide high-speed capability and are engineered for finishing to heavy roughing.

P	Steel
M	Stainless Steel
K	Cast Iron
N	Non-Ferrous
S	High-Temp Alloys
H	Hardened Materials

Coating	Grade Description	wear resistance ← → toughness									
			05	10	15	20	25	30	35	40	45
WU10PT	<p>Composition: An advanced multilayer PVD coating over a very deformation-resistant unalloyed carbide substrate. The new and improved coating improves edge stability with wide range speed and feed capabilities.</p> <p>Application: The WU10PT™ grade is ideal for finishing to general machining of most workpiece materials at a wide range of speed and feed capabilities. Excellent for machining most steels, stainless steels, cast irons, non-ferrous materials, and super alloys with improved edge toughness and higher cutting speed/feed capability.</p>	P									
		M									
		K									
		N									
		S									
		H									
WU25PT	<p>Composition: An advanced PVD-TiAlN-coated grade with a tough, ultra-fine grain, unalloyed substrate.</p> <p>Application: For general-purpose machining of most steels, stainless steels, high-temperature alloys, titanium, irons, and non-ferrous materials. Speeds may vary from low to medium and will handle interruptions and high feed rates.</p>	P									
		M									
		K									
		N									
		S									
		H									
WU35PT	<p>Composition: A multilayer PVD-coated carbide grade with an advanced AlTiN-TiN coating over a super-tough substrate.</p> <p>Application: WU35PT is an excellent grade for machining stainless steels, all types of steels, super alloys in turning, and cut-off applications. The substrate provides improved toughness while the coating layers offer excellent abrasion resistance and dependability at a wide range of speeds and feeds. Improved edge toughness provides security in interrupted cuts.</p>	P									
		M									
		K									
		N									
		S									
		H									

Plunge Feed Rates

- first choice
- alternate choice

P Steel	K Cast Iron	S High-Temp Alloys
M Stainless Steel	N Non-Ferrous	H Hardened Materials

Chip Control	Description	Insert Geometry	Seat Size (SSC)	Corner Radius mm	Starting Conditions mm	Plunge Feed Rates mm/rev							
						0,05	0,10	0,15	0,20	0,25	0,30	0,35	
-PT 	Positive rake angle for lower cutting forces.		1F	0,2	0,06	○							
			2	0,2	0,08	○	○						
			3	0,2	0,09	○	○	○					
			4	0,4	0,11	○	○	○	○				
				0,8	0,12	○	○	○	○	○			
			5	0,4	0,15	○	○	○	○	○	○		
				0,8	0,16	○	○	○	○	○	○	○	
			6	0,4	0,15	○	○	○	○	○	○	○	○
				0,8	0,18	○	○	○	○	○	○	○	○
			8	1,2	0,20	○	○	○	○	○	○	○	○
1,2	0,22	○		○	○	○	○	○	○	○			
10	1,2	0,24	○	○	○	○	○	○	○	○			
	1,2	0,24	○	○	○	○	○	○	○	○			
-PN 	Stable negative cutting edge allowing for more aggressive applications.		1F	0,2	0,06	○							
			2	0,2	0,08	○	○						
			3	0,2	0,09	○	○	○					
			4	0,4	0,11	○	○	○	○				
				0,8	0,12	○	○	○	○	○			
			5	0,4	0,15	○	○	○	○	○			
				0,8	0,16	○	○	○	○	○	○		
			6	0,4	0,15	○	○	○	○	○	○	○	
				0,8	0,18	○	○	○	○	○	○	○	
			8	1,2	0,20	○	○	○	○	○	○	○	
1,2	0,20	○		○	○	○	○	○	○				
10	1,2	0,22	○	○	○	○	○	○	○				
	1,2	0,24	○	○	○	○	○	○	○				

Cut-Off Feed Rates

Geometry	Description	Insert Geometry	Seat Size (SSC)	Starting Conditions mm	Cut-Off Feed Rates mm/rev							
					0,05	0,10	0,15	0,20	0,25	0,30	0,35	0,40
-F 	Positive geometry for reduced cutting forces.		1B	0,06	○							
			2	0,07	○	○						
			3	0,09	○	○	○					
			4	0,11	○	○	○	○				
			5	0,13	○	○	○	○	○			
-M 	Stable cutting edge for aggressive feed rates. Primarily in cast iron.		1B	0,06	○							
			2	0,07	○	○						
			3	0,09	○	○	○					
			4	0,11	○	○	○	○				
			5	0,14	○	○	○	○	○			
			8	0,14	○	○	○	○	○	○		
-R 	Most stable cutting edge for steel.		2	0,10	○							
			3	0,14	○	○						
			4	0,16	○	○	○					
			5	0,19	○	○	○	○				
			8	0,23	○	○	○	○	○	○	○	

NOTE: For cut-off inserts with a lead angle, maximum feed rate should be reduced by up to 40%.

Maximum Feed Rate Values

Data above is for P and K material groups. Maximum feed rates should be adjusted by multiplying max feed rate values by following factors for shown material groups.	Material Group	Feed Factor
	M	0.8
	N	1.2
	S	0.8
	H	0.5

I.D. and Face Grooving

For I.D. and face grooving applications, reduce feed rate by 20%.

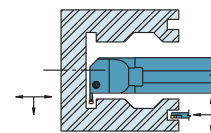

Turn and Profile Feed Rates

Seat Size 1F

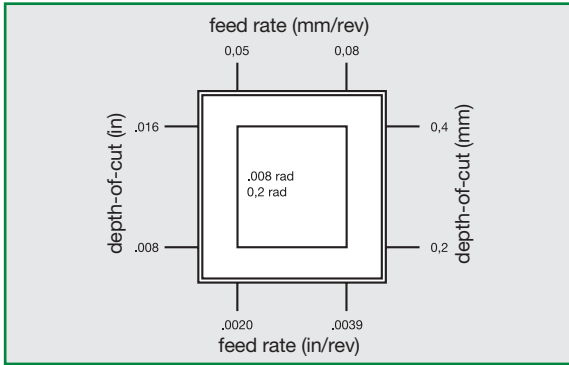

Seat Size 2

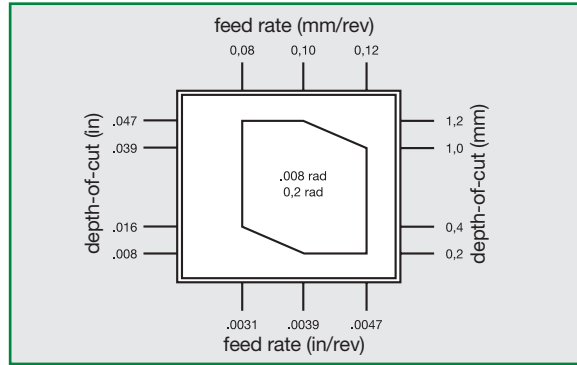

Seat Size 3

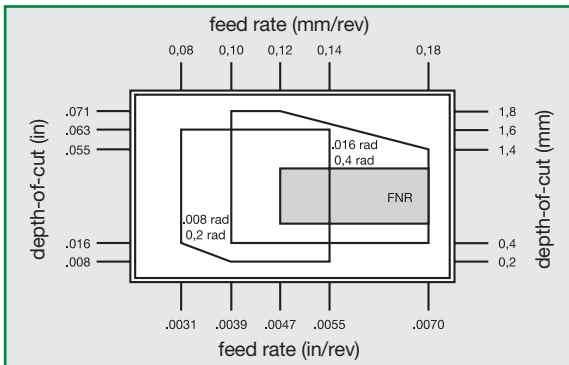

Seat Size 4

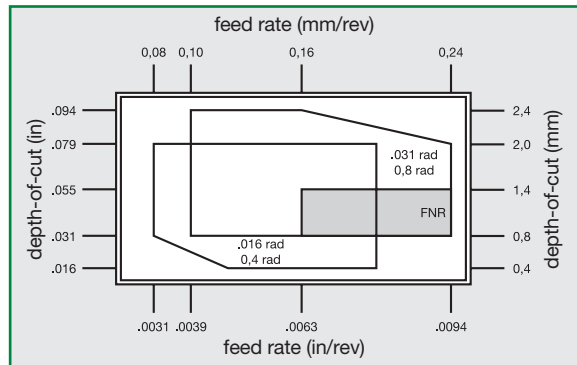

Seat Size 5

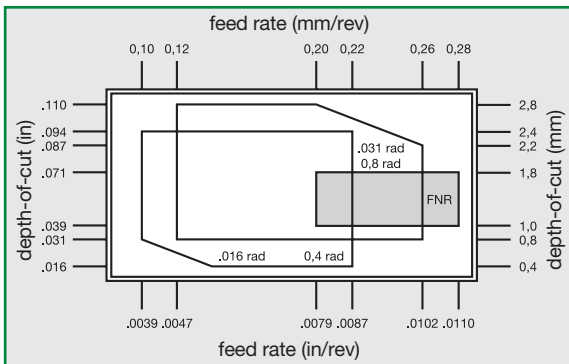

Seat Size 6

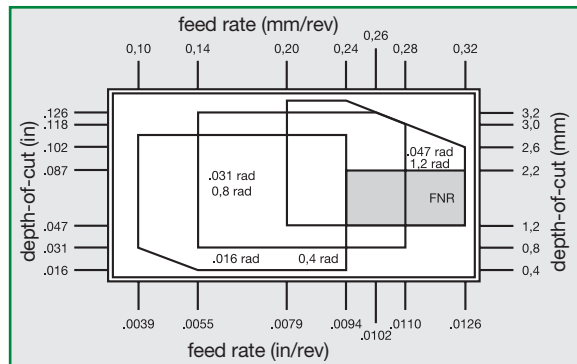

Seat Size 8

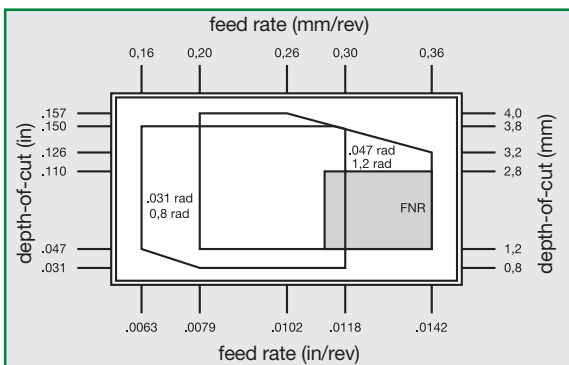

Seat Size 10

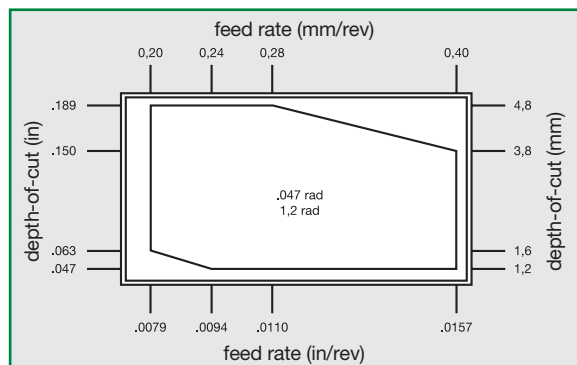

* FNR = Full Nose Radius

Recommended Starting Speeds • Metric

Material Group		WU25PT			WU10PT			WU35PT		
P	0-1	110	225	270	140	280	350	90	180	213
	2	110	160	260	140	200	300	90	130	155
	3	110	125	235	140	155	245	90	100	155
	4	60	90	160	75	110	170	50	70	110
	5	100	160	210	120	200	260	80	130	165
	6	85	120	185	110	150	230	70	100	145
M	1	90	170	245	140	210	280	75	120	135
	2	90	150	245	120	200	245	75	110	135
	3	90	140	210	120	180	245	75	90	135
K	1	100	145	225	120	180	245	—	—	—
	2	70	120	170	90	150	240	—	—	—
	3	50	85	120	60	110	150	—	—	—
N	1-2	120	440	780	150	550	975	—	—	—
	3	—	—	—	—	—	—	—	—	—
	4	100	290	490	120	365	700	—	—	—
	5	70	135	195	90	170	245	—	—	—
S	6	100	170	245	120	210	305	—	—	—
	1	8	40	60	15	55	135	8	35	60
	2	8	30	75	15	60	135	8	30	60
	3	15	40	75	15	70	150	15	35	60
H	4	8	50	110	15	70	170	15	45	90
	1	—	—	—	30	45	60	—	—	—
	2	—	—	—	15	30	45	—	—	—
H	3	—	—	—	—	—	—	—	—	—

NOTE: First choice starting speeds are in **bold** type.
As the average chip thickness increases, the speed should be decreased.

INDEXABLE MILLING

SOLID END MILLING

HOLEMAKING

TAPPING

TURNING

WGC Cut-Off Inserts • F Precision Molded • Metric



Left Hand



Neutral



Right Hand

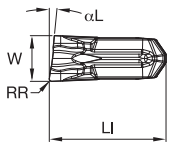

Left Hand

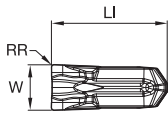

Neutral

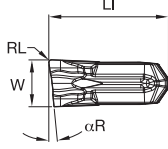

Right Hand

- first choice
- alternate choice

P	●	○	●	●
M	●	○	●	●
K	●	○	●	●
N	●	○	●	●
S	●	○	●	●
H	○	○	○	○

catalogue number	SSC	W	W tol ±	LI	αR	αL	RR	RL	WU10PT	WU25PT	WU35PT
WC014M1BL06F01	1B	1,40	0,050	9,00	—	6	0,15	—	●	●	●
WC014M1BN00F01	1B	1,40	0,050	9,00	—	—	0,15	0,15	○	○	○
WC014M1BR06F01	1B	1,40	0,050	9,02	6	—	—	0,15	●	●	●
WC020M02L06F02	2	2,00	0,050	9,00	—	6	0,20	—	○	○	○
WC020M02N00F02	2	2,00	0,050	9,00	—	—	0,20	0,20	○	○	○
WC020M02R06F02	2	2,00	0,050	9,00	6	—	—	0,20	●	●	●
WC030M03L06F02	3	3,00	0,075	9,60	—	6	0,20	—	○	○	○
WC030M03N00F02	3	3,00	0,075	9,63	—	—	0,20	0,20	○	○	○
WC030M03R06F02	3	3,00	0,075	9,60	6	—	—	—	●	●	●
WC040M04L06F02	4	4,00	0,075	10,19	—	6	0,20	—	○	○	○
WC040M04N00F02	4	4,00	0,075	10,19	—	—	0,20	0,20	○	○	○
WC040M04R06F02	4	4,00	0,075	10,19	6	—	—	0,20	●	●	●
WC050M05N00F03	5	5,00	0,075	12,24	—	—	0,30	0,30	○	○	○

NOTE: SSC = To correspond with the SSC on the toolholder.

INDEXABLE MILLING

SOLID END MILLING

HOLEMAKING

TAPPING

TURNING

WGC Cut-Off Inserts • F Precision Ground • Inch

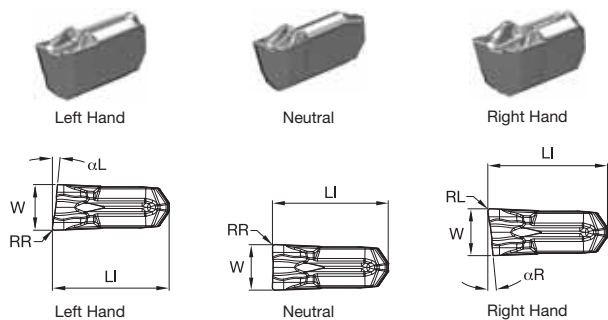

● first choice
○ alternate choice

P	●	○	●	○
M	●	○	●	○
K	●	○	●	○
N	●	○	●	○
S	●	○	●	○
H	○	○	○	○

catalogue number	SSC	W	W tol ±	LI	αR	αL	RR	RL	WU10PT	WU25PT	WU35PT
WC014M1BPR06F00	1B	1,40	0,025	9,00	6	—	—	—	—	6686392	—
WC014M1BPR12F00	1B	1,40	0,025	9,00	12	—	—	—	—	6686394	—
WC094I02PL06F00	2	2,39	0,025	8,95	—	6	—	—	—	6686395	—
WC094I02PL12F00	2	2,39	0,025	8,95	—	12	—	—	—	6686396	—
WC094I02PN00F00	2	2,39	0,025	8,95	—	—	—	—	—	6686398	—
WC094I02PR06F00	2	2,39	0,025	8,95	6	—	—	—	—	6686411	—
WC094I02PR12F00	2	2,39	0,025	8,95	—	12	—	—	—	6686413	—
WC094I02PL06F0	2	2,39	0,025	9,04	—	6	0,10	0,10	—	—	6686474
WC094I02PN00F0	2	2,39	0,025	9,04	—	—	0,10	0,10	—	—	6686475
WC094I02PN00F05	2	2,39	0,025	9,04	—	—	0,20	0,20	6686067	6686399	—
WC094I02PR06F0	2	2,39	0,025	9,04	6	—	0,10	0,10	—	6686400	—
WC094I02PR06F05	2	2,39	0,025	9,04	6	—	0,20	0,20	6686082	6686412	—

INDEXABLE MILLING

SOLID END MILLING

HOLEMAKING

TAPPING

TURNING

WGC Cut-Off Inserts • F Precision Ground • Inch

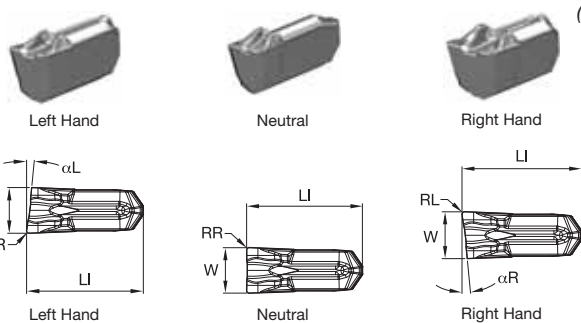

(continued)

- first choice
- alternate choice

P	●	○	●	●
M	●	○	●	●
K	●	○	○	○
N	●	○	○	○
S	●	○	○	○
H	○	○	○	○

catalogue number	SSC	W	W tol ±	LI	αR	αL	RR	RL	WU10PT	WU25PT	WU35PT
WC025M02PR06F01	2	2,50	0,025	9,04	6	—	0,15	0,15	●	●	●
WC030M03PN00F02	3	3,00	0,075	9,63	—	—	0,20	0,20	●	●	●
WC125I03PL06F00	3	3,18	0,025	9,48	—	6	—	—	○	○	○
WC125I03PL12F00	3	3,18	0,025	9,48	—	12	—	—	○	○	○
WC125I03PN00F00	3	3,18	0,025	9,48	—	—	—	—	●	●	●
WC125I03PR06F00	3	3,18	0,025	9,48	6	—	—	—	●	●	●
WC125I03PL06F0	3	3,18	0,025	9,63	—	6	0,10	0,10	○	○	○
WC125I03PL06F05	3	3,18	0,025	9,63	—	6	0,20	0,20	○	○	○
WC125I03PN00F0	3	3,18	0,025	9,63	—	—	0,10	0,10	●	●	●
WC125I03PN00F05	3	3,18	0,025	9,63	—	—	0,20	0,20	●	●	●
WC125I03PR06F0	3	3,18	0,025	9,63	6	—	0,10	0,10	●	●	●
WC125I03PR06F05	3	3,18	0,025	9,63	6	—	0,20	0,20	●	●	●

INDEXABLE MILLING

SOLID END MILLING

HOLEMAKING

TAPPING

TURNING

WGC Cut-Off Inserts • F Precision Ground • Inch

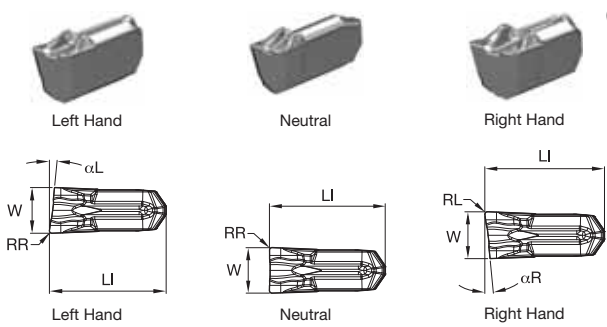

● first choice
○ alternate choice

P	●	○	●	○
M	●	○	●	○
K	●	○	○	○
N	●	○	○	○
S	●	○	○	○
H	○	○	○	○

catalogue number	SSC	W	W tol ±	LI	αR	αL	RR	RL	WU10PT	WU25PT	WU55PT
WC125I03PR12F00	3	3,18	0,025	9,75	12	—	—	—	●	○	○
WC040M04PR06F00	4	4,00	0,025	10,01	6	—	—	—	○	○	○
WC040M04PR12F00	4	4,00	0,025	10,01	12	—	—	—	○	○	○
WC188I04PR12F00	4	4,75	0,025	10,01	12	—	—	—	○	○	○
WC188I04PR06F00	4	4,76	0,025	10,01	6	—	—	—	○	○	○
WC188I04PL06F00	4	4,76	0,025	10,02	—	6	—	—	○	○	○
WC188I04PN00F00	4	4,76	0,025	10,02	—	—	—	—	○	○	○
WC188I04PN00F05	4	4,76	0,025	10,16	—	—	0,20	0,20	○	○	○
WC188I04PR06F05	4	4,76	0,025	10,17	6	—	0,20	0,20	○	○	○

NOTE: SSC = To correspond with the SSC on the toolholder.

INDEXABLE MILLING

SOLID END MILLING

HOLEMAKING

TAPPING

TURNING

WGC Cut-Off Inserts • M Precision Molded • Metric



Left Hand



Neutral



Right Hand

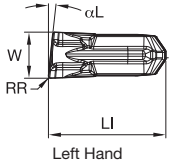

Left Hand

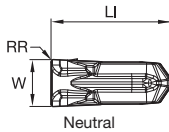

Neutral

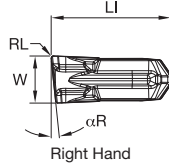

Right Hand

- first choice
- alternate choice

P	●	○	●	○
M	●	○	●	○
K	●	○	●	○
N	●	○	●	○
S	●	○	●	○
H	○	○	○	○

catalogue number	SSC	W	W tol ±	LI	αR	αL	RR	RL	WU10PT	WU25PT	WU35PT
WC014M1BL06M02	1B	1,40	0,050	9,02	—	6	—	0,20	●	●	●
WC014M1BN00M01	1B	1,40	0,050	9,01	—	—	0,15	0,15	○	○	○
WC014M1BR06M02	1B	1,40	0,050	9,02	6	—	—	0,20	●	●	●
WC020M02L06M02	2	2,00	0,050	8,97	—	6	—	0,20	○	○	○
WC020M02N00M02	2	2,00	0,050	8,98	—	—	0,20	0,20	○	○	○
WC020M02R06M02	2	2,00	0,050	9,00	6	—	—	0,20	●	●	●
WC030M03L06M02	3	3,00	0,075	9,61	—	6	—	0,20	○	○	○
WC030M03N00M02	3	3,00	0,075	9,60	—	—	0,20	0,20	○	○	○
WC030M03R06M02	3	3,00	0,075	9,61	6	—	—	0,20	●	●	●
WC040M04L06M02	4	4,00	0,075	10,19	—	6	0,20	—	○	○	○
WC040M04N00M02	4	4,00	0,075	10,20	—	—	0,20	0,20	○	○	○
WC040M04R06M02	4	4,00	0,050	10,20	6	—	—	0,20	●	●	●

INDEXABLE MILLING

SOLID END MILLING

HOLEMAKING

TAPPING

TURNING

WGC Cut-Off Inserts • M Precision Molded • Metric



Left Hand



Neutral



Right Hand

(continued)

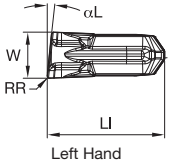

Left Hand

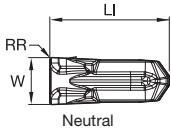

Neutral

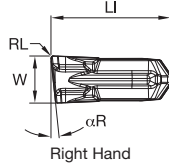

Right Hand

- first choice
- alternate choice

P	●	○	○	○
M	●	○	○	○
K	○	○	○	○
N	○	○	○	○
S	○	○	○	○
H	○	○	○	○

catalogue number	SSC	W	W tol ±	LI	αR	αL	RR	RL	WU10PT	WU25PT	WU35PT
WC050M05N00M03	5	5,00	0,075	12,25	—	—	0,30	0,30		6461870	
WC060M06N00M03	6	6,00	0,075	14,59	—	—	0,30	0,30		6461881	
WC080M08N00M04	8	8,00	0,075	17,46	—	—	0,40	0,40		6461882	

NOTE: SSC = To correspond with the SSC on the toolholder.

INDEXABLE MILLING

SOLID END MILLING

HOLEMAKING

TAPPING

TURNING

WGC Cut-Off Inserts • R Precision Molded • Metric

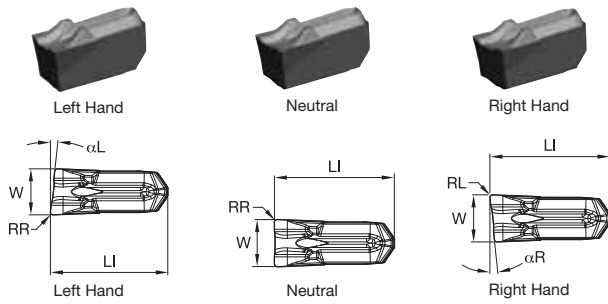

● first choice
○ alternate choice

P	●	○	●	○
M	●	○	●	○
K	○	○	○	○
N	○	○	○	○
S	○	○	○	○
H	○	○	○	○

catalogue number	SSC	W	W tol ±	LI	αR	αL	RR	RL	WU10PT	WU25PT	WU35PT
WC020M02L06R02	2	2,00	0,050	8,97	—	6	0,20	—	●	○	○
WC020M02N00R02	2	2,00	0,050	8,98	—	—	0,20	0,20	○	○	○
WC020M02R06R02	2	2,00	0,050	8,97	6	—	—	0,20	○	○	○
WC030M03L06R02	3	3,00	0,075	9,61	—	6	0,20	—	●	○	○
WC030M03N00R02	3	3,00	0,075	9,60	—	—	0,20	0,20	○	○	○
WC030M03R06R02	3	3,00	0,075	9,61	6	—	—	0,20	○	○	○
WC040M04N00R02	4	4,00	0,075	10,20	—	—	0,20	0,20	○	○	○
WC050M05N00R03	5	5,00	0,075	12,25	—	—	0,30	0,30	○	○	○
WC060M06N00R03	6	6,00	0,075	14,59	—	—	0,30	0,30	○	○	○
WC080M08N00R04	8	8,00	0,075	17,46	—	—	0,40	0,40	○	○	○

NOTE: SSC = To correspond with the SSC on the toolholder.

INDEXABLE MILLING

SOLID END MILLING

HOLEMAKING

TAPPING

TURNING

WGC Grooving Inserts • PT Precision Molded • Metric

● first choice
○ alternate choice

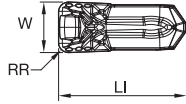

P	<input checked="" type="checkbox"/>	<input checked="" type="checkbox"/>	<input checked="" type="checkbox"/>	<input checked="" type="checkbox"/>
M	<input checked="" type="checkbox"/>	<input checked="" type="checkbox"/>	<input checked="" type="checkbox"/>	<input checked="" type="checkbox"/>
K	<input checked="" type="checkbox"/>	<input checked="" type="checkbox"/>	<input checked="" type="checkbox"/>	<input checked="" type="checkbox"/>
N	<input checked="" type="checkbox"/>	<input checked="" type="checkbox"/>	<input checked="" type="checkbox"/>	<input checked="" type="checkbox"/>
S	<input checked="" type="checkbox"/>	<input checked="" type="checkbox"/>	<input checked="" type="checkbox"/>	<input checked="" type="checkbox"/>
H	<input checked="" type="checkbox"/>	<input checked="" type="checkbox"/>	<input checked="" type="checkbox"/>	<input checked="" type="checkbox"/>

catalogue number	SSC	W	W tol ±	RR	LI	WU10PT	WU25PT	WU35PT
WG0212M02U02PT	2	2,13	0,050	0,20	8,97	•	•	•
WG0251M02U02PT	2	2,51	0,050	0,20	8,97	•	•	•
WG0312M03U02PT	3	3,13	0,075	0,20	9,60	•	•	•
WG0312M03U04PT	3	3,13	0,075	0,40	9,60	•	•	•
WG0412M04U04PT	4	4,13	0,075	0,40	10,19	•	•	•
WG0412M04U08PT	4	4,13	0,075	0,80	10,19	•	•	•
WG0512M05U04PT	5	5,13	0,075	0,40	12,25	•	•	•
WG0512M05U08PT	5	5,13	0,075	0,80	12,25	•	•	•
WG0612M06U04PT	6	6,13	0,075	0,40	14,59	•	•	•
WG0612M06U08PT	6	6,13	0,075	0,80	14,59	•	•	•
WG0712M06U08PT	6	7,13	0,075	0,80	14,59	•	•	•
WG0812M08U08PT	8	8,13	0,075	0,80	17,45	•	•	•
WG0812M08U12PT	8	8,13	0,075	1,20	17,45	•	•	•
WG1012M10U12PT	10	10,13	0,075	1,20	20,75	•	•	•

NOTE: SSC = To correspond with the SSC on the toolholder.

INDEXABLE MILLING

SOLID END MILLING

HOLEMAKING

TAPPING

TURNING

WGC Grooving Inserts • PT Precision Molded • Inch

INDEXABLE MILLING

SOLID END MILLING

HOLE/MAKING

TAPPING

TURNING

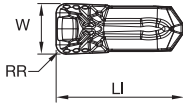

- first choice
- alternate choice

P	●	○	○	○
M	●	○	○	○
K	●	○	○	○
N	●	○	○	○
S	●	○	○	○
H	○	○	○	○

catalogue number	SSC	W	W tol ±	RR	LI	WU10PT	WU25PT	WU35PT
WG130I03U1PT	3	3,30	0,075	0,40	9,60	●	●	●
WG130I03U05PT	3	3,30	0,075	0,20	9,60	○	○	○
WG192I04U1PT	4	4,88	0,075	0,40	10,19	●	●	●
WG192I04U2PT	4	4,88	0,075	0,78	10,19	○	○	○
WG255I06U1PT	6	6,48	0,075	0,40	14,58	●	●	●
WG255I06U2PT	6	6,48	0,075	0,80	14,58	○	○	○
WG317I08U3PT	8	8,05	0,075	1,19	17,46	●	●	●
WG380I10U3PT	10	9,65	0,075	1,19	20,75	○	○	○

NOTE: SSC = To correspond with the SSC on the toolholder.

WGC Grooving Inserts • PT Precision Ground • Metric

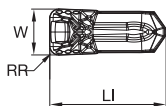
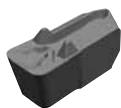

● first choice
○ alternate choice

P	<input checked="" type="checkbox"/>	<input checked="" type="checkbox"/>	<input checked="" type="checkbox"/>	<input checked="" type="checkbox"/>
M	<input checked="" type="checkbox"/>	<input checked="" type="checkbox"/>	<input checked="" type="checkbox"/>	<input checked="" type="checkbox"/>
K	<input checked="" type="checkbox"/>	<input checked="" type="checkbox"/>	<input checked="" type="checkbox"/>	<input checked="" type="checkbox"/>
N	<input checked="" type="checkbox"/>	<input checked="" type="checkbox"/>	<input checked="" type="checkbox"/>	<input checked="" type="checkbox"/>
S	<input checked="" type="checkbox"/>	<input checked="" type="checkbox"/>	<input checked="" type="checkbox"/>	<input checked="" type="checkbox"/>
H	<input checked="" type="checkbox"/>	<input checked="" type="checkbox"/>	<input checked="" type="checkbox"/>	<input checked="" type="checkbox"/>

catalogue number	SSC	W	W tol ±	RR	LI	WU10PT	WU25PT	WU35PT
WG0200M02P02PT	2	2,00	0,025	0,20	8,92	•	•	•
WG0300M03P02PT	3	3,00	0,025	0,20	9,55	•	•	•
WG0300M03P04PT	3	3,00	0,025	0,40	9,55	•	•	•
WG0400M04P04PT	4	4,00	0,025	0,40	10,15	•	•	•
WG0400M04P08PT	4	4,00	0,025	0,80	10,15	•	•	•
WG0500M05P04PT	5	5,00	0,025	0,40	12,18	•	•	•
WG0500M05P08PT	5	5,00	0,025	0,08	12,20	•	•	•
WG0600M06P04PT	6	6,00	0,025	0,40	14,53	•	•	•
WG0600M06P08PT	6	6,00	0,025	0,80	14,54	•	•	•

NOTE: SSC = To correspond with the SSC on the toolholder.

INDEXABLE MILLING

SOLID END MILLING

HOLEMAKING

TAPPING

TURNING

WGC Grooving Inserts • PT Precision Ground • Inch

INDEXABLE MILLING

SOLID END MILLING

HOLEMAKING

TAPPING

TURNING

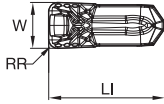
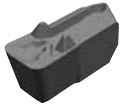

- first choice
- alternate choice

P	●	○	●	○
M	●	○	●	○
K	●	○	●	○
N	●	○	●	○
S	●	○	●	○
H	○	○	○	○

catalogue number	SSC	W	W tol ±	RR	LI	WU10PT	WU25PT	WU35PT
WG125I03P05PT	3	3,18	0,075	0,20	9,55	●	●	○
WG188I04P08PT	4	4,76	0,025	0,32	10,14	●	●	○
WG250I06P08PT	6	6,35	0,075	0,32	14,53	●	●	○

NOTE: SSC = To correspond with the SSC on the toolholder.

WGC Grooving Inserts • PN Precision Molded • Metric

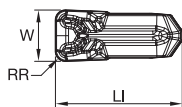

- first choice
- alternate choice

P	●	○	●	○
M	●	○	●	○
K	●	○	●	○
N	●	○	●	○
S	●	○	●	○
H	○	○	○	○

catalogue number	SSC	W	W tol ±	RR	LI	WU10PT	WU25PT	WU35PT
WG0212M02U02PN	2	2,13	0,050	0,20	8,97	●	●	○
WG0251M02U02PN	2	2,51	0,050	0,20	8,97	○	○	○
WG0312M03U02PN	3	3,13	0,075	0,20	9,60	○	○	○
WG0312M03U04PN	3	3,13	0,075	0,40	9,60	○	○	○
WG0412M04U04PN	4	4,13	0,075	0,40	10,20	○	○	○
WG0412M04U08PN	4	4,13	0,075	0,80	10,20	○	○	○
WG0512M05U04PN	5	5,13	0,075	0,40	12,24	○	○	○
WG0512M05U08PN	5	5,13	0,075	0,80	12,24	○	○	○
WG0612M06U04PN	6	6,13	0,075	0,40	14,59	○	○	○
WG0612M06U08PN	6	6,13	0,075	0,80	14,59	○	○	○
WG0812M08U08PN	8	8,13	0,075	0,80	17,46	○	○	○
WG0812M08U12PN	8	8,13	0,075	1,20	17,46	○	○	○
WG1012M10U12PN	10	10,13	0,075	1,20	20,75	○	○	○

NOTE: SSC = Pocket Seat Reference. To correspond with the SSC on the toolholder.

INDEXABLE MILLING

SOLID END MILLING

HOLEMAKING

TAPPING

TURNING

WGC Grooving Inserts • PN Precision Molded • Inch

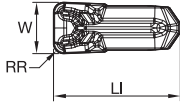

- first choice
- alternate choice

P	●	○	●	○
M	●	○	●	○
K	●	○	●	○
N	●	○	●	○
S	●	○	●	○
H	○	○	○	○

catalogue number	SSC	W	W tol ±	RR	LI	WU10PT	WU25PT	WU35PT
WG125I03U1PN	3	3,18	0,075	0,40	9,60	●	●	○
WG125I03U05PN	3	3,18	0,075	0,20	9,60	○	○	○
WG130I03U1PN	3	3,30	0,075	0,40	9,60	●	●	○
WG130I03U05PN	3	3,30	0,075	0,20	9,60	○	○	○
WG187I04U1PN	4	4,75	0,075	0,40	10,19	●	●	○
WG187I04U2PN	4	4,75	0,075	0,80	10,20	○	○	○
WG192I04U1PN	4	4,88	0,075	0,40	10,20	●	●	○
WG192I04U2PN	4	4,88	0,075	0,80	10,20	○	○	○
WG250I06U1PN	6	6,35	0,075	0,40	14,58	●	●	○
WG250I06U2PN	6	6,35	0,075	0,80	14,58	○	○	○
WG255I06U1PN	6	6,48	0,075	0,40	14,58	●	●	○
WG255I06U2PN	6	6,48	0,075	0,80	14,58	○	○	○

INDEXABLE MILLING

SOLID END MILLING

HOLE/MAKING

TAPPING

TURNING

WGC Grooving Inserts • PN Precision Molded • Inch

(continued)

- first choice
- alternate choice

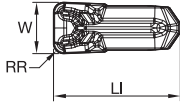

P	●	○	○	○
M	●	○	○	○
K	●	○	○	○
N	●	○	○	○
S	●	○	○	○
H	○	○	○	○

catalogue number	SSC	W	W tol ±	RR	LI	WU10PT	WU25PT	WU35PT
WG312I08U3PN	8	7,93	0,075	1,20	17,46	●	●	●
WG317I08U3PN	8	8,05	0,075	1,19	17,46	●	●	●
WG375I10U3PN	10	9,53	0,075	1,20	20,75	●	●	●
WG380I10U3PN	10	9,65	0,075	1,20	20,70	●	●	●

NOTE: SSC = To correspond with the SSC on the toolholder.

INDEXABLE MILLING

SOLID END MILLING

HOLEMAKING

TAPPING

TURNING

WGC Grooving Inserts • PC Full Radius Precision Ground • Metric

INDEXABLE MILLING

SOLID END MILLING

HOLEMAKING

TAPPING

TURNING

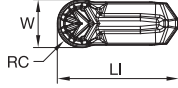

- first choice
- alternate choice

P	●	○	●	○
M	●	○	●	○
K	●	○	●	○
N	●	○	●	○
S	●	○	●	○
H	○	○	○	○

catalogue number	SSC	W	W tol ±	RC	LI	WU10PT	WU25PT	WU35PT
WR0200M02P00PC	2	2,00	0,025	1,00	8,91	●	●	●
WR0300M03P00PC	3	3,00	0,025	1,50	9,54	●	●	●
WR0400M04P00PC	4	4,00	0,025	2,00	10,13	●	●	●
WR0500M05P00PC	5	5,00	0,025	2,50	12,18	●	●	●
WR0600M06P00PC	6	6,00	0,025	3,00	14,52	●	●	●
WR0800M08P00PC	8	8,00	0,025	4,00	17,41	●	●	●

NOTE: SSC = Pocket Seat Reference. To correspond with the SSC on the toolholder.

WGC Grooving Inserts • PC Full Radius Precision Ground • Inch

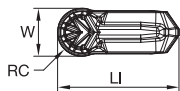

● first choice
○ alternate choice

P	●	○	●	○
M	●	○	●	○
K	●	○	●	○
N	●	○	●	○
S	●	○	●	○
H	○	○	○	○

catalogue number	SSC	W	W tol ±	RC	LI	WU10PT	WU25PT	WU35PT
WR125I03P00PC	3	3,18	0,025	1,59	9,54		6470263	
WR187I04P00PC	4	4,76	0,025	2,38	10,13		6470264	
WR250I06P00PC	6	6,35	0,025	3,18	14,54		6470265	
WR312I08P00PC	8	7,92	0,025	3,96	17,40		6470266	

NOTE: SSC = To correspond with the SSC on the toolholder.

INDEXABLE MILLING

SOLID END MILLING

HOLEMAKING

TAPPING

TURNING

Catalog Numbering System • Grooving

Each character in our catalog number signifies a specific trait of that product. Use the following key columns and corresponding images to easily identify which attributes apply.

WGC	S	M	L	1616	K	02	08	C
Family Name	Tool Style	Support Type	Hand	Shank Size	Tool Length	Seat Size	Max Groove Depth	Coolant
WIDIA™ Grooving and Cut-Off	S = Straight mount	<p>M = Maximum support for specific groove width and straight clearance for unlimited workpiece diameter</p> <p>A = Face grooving — inboard sweep</p> <p>B = Face grooving — outboard sweep</p>	<p>L = Left hand</p> <p>R = Right hand</p>	<p>Metric = Height x Width in mm letter indicates tool length according to ISO</p>	<p>K = 125</p> <p>M = 150</p>	<p>1B</p> <p>1F</p> <p>02</p> <p>03</p> <p>04</p> <p>05</p> <p>06</p> <p>08</p> <p>10</p>	in millimeters	<p>C = Through the pocket coolant capable</p>

Catalog Numbering System • Cut-Off Blades

Each character in our catalog number signifies a specific trait of that product. Use the following key columns and corresponding images to easily identify which attributes apply.

A	16	M	WGC	E	M	R	03	07	M																						
Steel Bar with Coolant	Bar Diameter	Bar Length	Platform	Tool Type	Support Type	Hand of Tool	Insert Seat Size	Max Cutting Depth	Tool Units																						
Steel boring bar with through coolant capability.	Metric = Diameter in mm Inch = Diameter in 1/16" increments		WIDIA™ Grooving and Cut-Off	E = End mount (90°)	M = Maximum support	L = Left hand R = Right hand	1F 02 03 04 05 06 08 10	in millimeters	M = Metric I = Inch																						
		<table border="1"> <thead> <tr> <th>symbol</th> <th>mm</th> <th>inch</th> </tr> </thead> <tbody> <tr> <td>K</td> <td>125</td> <td>5</td> </tr> <tr> <td>M</td> <td>150</td> <td>6</td> </tr> <tr> <td>Q</td> <td>180</td> <td>7</td> </tr> <tr> <td>R</td> <td>200</td> <td>8</td> </tr> <tr> <td>S</td> <td>250</td> <td>10</td> </tr> <tr> <td>T</td> <td>300</td> <td>12</td> </tr> </tbody> </table>		symbol	mm	inch	K	125	5	M	150	6	Q	180	7	R	200	8	S	250	10	T	300	12							
symbol	mm	inch																													
K	125	5																													
M	150	6																													
Q	180	7																													
R	200	8																													
S	250	10																													
T	300	12																													

INDEXABLE MILLING

SOLID END MILLING

HOLEMAKING

TAPPING

TURNING

Catalog Numbering System • Modular Toolholders

Each character in our catalog number signifies a specific trait of that product. Use the following key columns and corresponding images to easily identify which attributes apply.

WGC	M	S	L	2525M	50	C
Family Name	Modular	Tool Style	Hand	Shank Size	Blade Size	Coolant
WIDIA™ Grooving and Cut-Off		S = Straight Mount E = End Mount (90°)	L = Left hand R = Right hand	Metric = Height x Width in mm letter indicates tool length according to ISO	50 65	C = Through coolant capable

INDEXABLE MILLING

SOLID END MILLING

HOLEMAKING

TAPPING

TURNING

Catalog Numbering System • Modular Toolholders

Each character in our catalog number signifies a specific trait of that product. Use the following key columns and corresponding images to easily identify which attributes apply.

WGC	M	50	L	03	14	M	C
Family Name	Modular	Blade Size	Hand	Seat Size	Max Groove Depth	Support Type	Coolant
WIDIA™ Grooving and Cut-Off		50 65	L = Left hand R = Right hand	1B 1F 02 03 04 05 06 08 10	in millimeters	M = Maximum support for specific groove width and straight clearance for unlimited diameter	C = Through the pocket coolant capable

INDEXABLE MILLING

SOLID END MILLING

HOLEMAKING

TAPPING

TURNING

WGCSM-NTC Integral Toolholders • Integral Straight • Metric

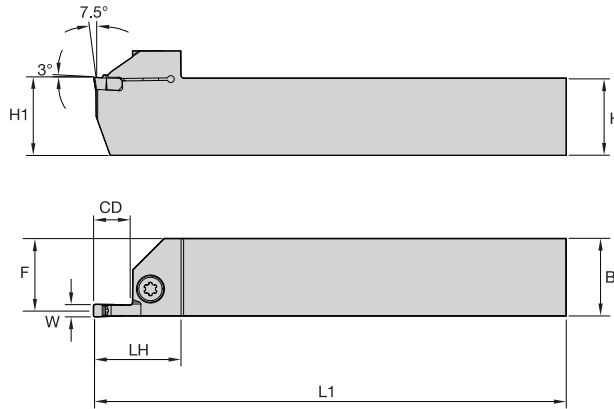

order number	catalogue number	SSC	CD	H1	H	B	F	L1	W	LH
right hand										
6949415	WGCSMR1616K0208	2	8	16	16	16	16	128	2	23
6949416	WGCSMR2020K0208	2	8	20	20	20	20	128	2	23
6949417	WGCSMR2525M0208	2	8	25	25	25	25	153	2	23
6949418	WGCSMR2020K0310	3	10	20	20	20	20	128	3	26
6949419	WGCSMR2525M0310	3	10	25	25	25	25	153	3	26
6949420	WGCSMR2020K0316	3	16	20	20	20	20	128	3	32
6949442	WGCSMR2525M0316	3	16	25	25	25	25	153	3	32
6949444	WGCSMR2525M0412	4	12	25	25	25	25	153	4	28
6949443	WGCSMR2020K0412	4	28	20	20	20	20	128	4	28
left hand										
6949445	WGCSML1616K0208	2	8	16	16	16	16	128	2	23
6949446	WGCSML2020K0208	2	8	20	20	20	20	128	2	23
6949447	WGCSML2525M0208	2	8	25	25	25	25	153	2	23
6949448	WGCSML2020K0310	3	10	20	20	20	20	128	3	10
6949449	WGCSML2525M0310	3	10	25	25	25	25	153	3	26
6949450	WGCSML2020K0316	3	16	20	20	20	20	128	3	32
6949701	WGCSML2525M0316	3	16	25	25	25	25	153	3	32
6949703	WGCSML2525M0412	4	12	25	25	25	25	153	4	28
6949702	WGCSML2020K0412	4	28	20	20	20	20	128	4	28

NOTE: SSC = Pocket Seat Reference. To correspond with the SSC on the insert.

INDEXABLE MILLING

SOLID END MILLING

HOLEMAKING

TAPPING

TURNING

WGC Integral Toolholders • Straight • Metric

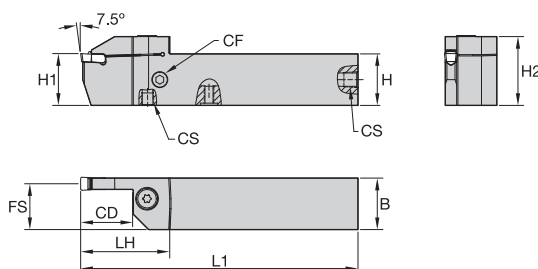
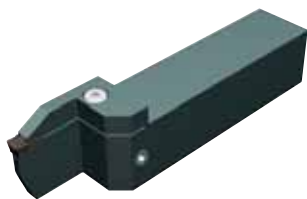

order number	catalogue number	SSC	CD	H1	H	B	H2	L1	FS	LH	CF	CS
right hand												
6461946	WGCSMR2020K0216	2	16	20	20	20	27	125	19	31	—	—
6461948	WGCSMR2525M0216	2	16	25	25	25	32	150	24	31	—	—
6461950	WGCSMR2020K0222	2	22	20	20	20	29	125	19	38	—	—
6461952	WGCSMR2525M0226	2	26	25	25	25	34	150	24	42	—	—
6462003	WGCSMR2020K0316C	3	16	20	20	20	29	125	19	37	M8X1	M8X1
6462004	WGCSMR2525M0316C	3	16	25	25	25	34	150	24	37	G 1/8	G 1/8
6462005	WGCSMR2020K0322C	3	22	20	20	20	30	125	19	43	M8X1	M8X1
6462006	WGCSMR2525M0326C	3	26	25	25	25	35	150	24	47	G 1/8	G 1/8
6462007	WGCSMR2020K0416C	4	16	20	20	20	29	125	18	37	M8X1	M8X1
6462008	WGCSMR2525M0416C	4	16	25	25	25	34	150	23	37	G 1/8	G 1/8
6462009	WGCSMR2020K0422C	4	22	20	20	20	30	125	18	43	M8X1	M8X1
6462010	WGCSMR2525M0426C	4	26	25	25	25	35	150	23	47	G 1/8	G 1/8
6462061	WGCSMR3232P0426C	4	26	32	32	32	42	170	30	47	G 1/8	G 1/8
6462062	WGCSMR3232P0432C	4	32	32	32	32	42	170	30	53	G1/8-28	G1/8-28
6462063	WGCSMR2525M0516C	5	16	25	25	25	34	150	23	37	G 1/8	G 1/8
6462064	WGCSMR2525M0526C	5	26	25	25	25	35	150	23	47	G1/8-28	G1/8-28
6462065	WGCSMR3232P0526C	5	26	32	32	32	42	170	30	47	G 1/8	G 1/8
6462066	WGCSMR3232P0532C	5	32	32	32	32	42	170	30	53	G 1/8	G 1/8
6462067	WGCSMR2525M0616C	6	16	25	25	25	34	150	22	37	G 1/8	G 1/8
6462068	WGCSMR2525M0626C	6	26	25	25	25	35	150	22	47	G1/8-28	G1/8-28
6462069	WGCSMR3232P0626C	6	26	32	32	32	42	170	29	47	G 1/8	G 1/8
6462070	WGCSMR3232P0632C	6	32	32	32	32	44	170	29	55	G 1/8	G 1/8
6462071	WGCSMR4040R0640C	6	40	40	40	40	52	200	37	63	G 1/8	G 1/8
6462072	WGCSMR2525M0826C	8	26	25	25	25	36	150	21	49	G 1/8	G 1/8
6462073	WGCSMR3232P0826C	8	26	32	32	32	43	170	28	49	G 1/8	G 1/8
6462074	WGCSMR3232P0832C	8	32	32	32	32	44	170	28	55	G 1/8	G 1/8
6462075	WGCSMR4040R0840C	8	40	40	40	40	52	200	36	63	G1/8-28	G1/8-28
6462076	WGCSMR3232P1032C	10	32	32	32	32	44	170	28	55	G 1/8	G 1/8
6462077	WGCSMR4040R1040C	10	40	40	40	40	52	200	36	63	G 1/8	G 1/8
left hand												
6461954	WGCSML2020K0216	2	16	20	20	20	27	125	19	31	—	—
6461956	WGCSML2525M0216	2	16	25	25	25	32	150	24	31	—	—
6461958	WGCSML2020K0222	2	22	20	20	20	29	125	19	38	—	—
6461960	WGCSML2525M0226	2	26	25	25	25	34	150	24	42	—	—
6462078	WGCSML2020K0316C	3	16	20	20	20	29	125	19	37	M8X1	M8X1
6462079	WGCSML2525M0316C	3	16	25	25	25	34	150	24	37	G 1/8	G 1/8
6462080	WGCSML2020K0322C	3	22	20	20	20	30	125	19	43	M8X1	M8X1
6462091	WGCSML2525M0326C	3	26	25	25	25	35	150	24	47	G 1/8	G 1/8
6462092	WGCSML2020K0416C	4	16	20	20	20	29	125	18	37	M8X1	M8X1
6462093	WGCSML2525M0416C	4	16	25	25	25	34	150	23	37	G 1/8	G 1/8
6462094	WGCSML2020K0422C	4	22	20	20	20	30	125	18	43	M8X1	M8X1
6462095	WGCSML2525M0426C	4	26	25	25	25	35	150	23	47	G 1/8	G 1/8
6462096	WGCSML3232P0426C	4	26	32	32	32	42	170	30	47	G1/8-28	G1/8-28
6462097	WGCSML3232P0432C	4	32	32	32	32	42	170	30	53	G 1/8	G 1/8
6462098	WGCSML2525M0516C	5	16	25	25	25	34	150	23	37	G1/8-28	G1/8-28
6462099	WGCSML2525M0526C	5	26	25	25	25	35	150	23	47	G 1/8	G 1/8
6462100	WGCSML3232P0526C	5	26	32	32	32	42	170	30	47	G 1/8	G 1/8
6462101	WGCSML3232P0532C	5	32	32	32	32	42	170	30	53	G 1/8	G 1/8
6462102	WGCSML2525M0616C	6	16	25	25	25	34	150	22	37	G 1/8	G 1/8
6462103	WGCSML2525M0626C	6	26	25	25	25	35	150	22	47	G 1/8	G 1/8
6462104	WGCSML3232P0626C	6	26	32	32	32	42	170	29	47	G 1/8	G 1/8
6462105	WGCSML3232P0632C	6	32	32	32	32	44	170	29	55	G 1/8	G 1/8
6462106	WGCSML4040R0640C	6	40	40	40	40	52	200	37	63	G1/8-28	G1/8-28
6462107	WGCSML2525M0826C	8	26	25	25	25	36	150	21	49	G1/8-28	G1/8-28
6462108	WGCSML3232P0826C	8	26	32	32	32	43	170	28	49	G 1/8	G 1/8
6462109	WGCSML3232P0832C	8	32	32	32	32	44	170	28	55	G1/8-28	G1/8-28
6462110	WGCSML4040R0840C	8	40	40	40	40	52	200	36	63	G 1/8	G 1/8
6462111	WGCSML3232P1032C	10	32	32	32	32	44	170	28	55	G 1/8	G 1/8
6462112	WGCSML4040R1040C	10	40	40	40	40	52	200	36	63	G 1/8	G 1/8

NOTE: SSC = Pocket Seat Reference. To correspond with the SSC on the insert.

WGCSCF • Integral Toolholders • Reinforced Front Clamp • Metric

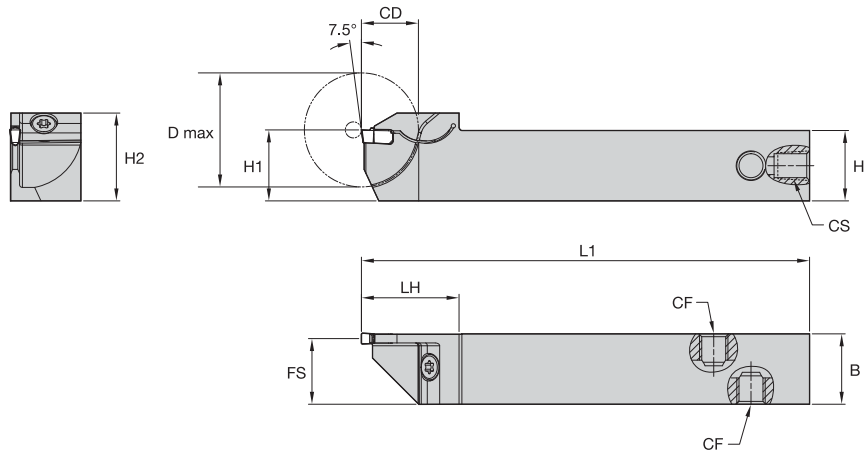

order number	catalogue number	SSC	CD	D max	H1	H	B	H2	L1	FS	LH	CF
right hand												
6765977	WGCSCFR1010K0210	2	10	20	10	10	10	14	125	9	21	—
6765978	WGCSCFR1212K0216	2	16	32	12	12	12	16	125	11	27	—
6765980	WGCSCFR1616K0216	2	16	32	16	16	16	21	125	15	27	—
6766062	WGCSCFR2020K0216	2	16	32	20	20	20	25	125	19	27	—
6765979	WGCSCFR1212K0316C	3	16	32	12	12	12	17	125	11	28	M8X1
6766061	WGCSCFR1616K0316C	3	16	32	16	16	16	18	125	15	28	M8X1
6766063	WGCSCFR2020K0316C	3	16	32	20	20	20	25	125	19	28	M8X1
left hand												
6766064	WGCSCFL1010K0210	2	10	20	10	10	10	14	125	9	21	—
6766065	WGCSCFL1212K0216	2	16	32	12	12	12	16	125	11	27	—
6766067	WGCSCFL1616K0216	2	16	32	16	16	16	21	125	15	27	—
6766069	WGCSCFL2020K0216	2	16	32	20	20	20	25	125	19	27	—
6766066	WGCSCFL1212K0316C	3	16	32	12	12	12	17	125	11	28	M8X1
6766068	WGCSCFL1616K0316C	3	16	32	16	16	16	21	125	15	28	M8X1
6766070	WGCSCFL2020K0316C	3	16	32	20	20	20	25	125	19	28	M8X1

NOTE: SSC = Pocket Seat Reference. To correspond with the SSC on the insert.

INDEXABLE MILLING

SOLID END MILLING

HOLEMAKING

TAPPING

TURNING

WGC • Modular Toolholder • Straight • with Coolant • Metric

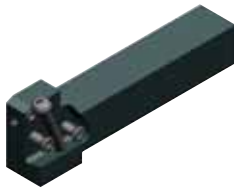

M50 Blade
Right Hand

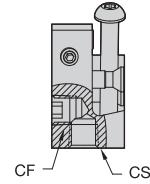
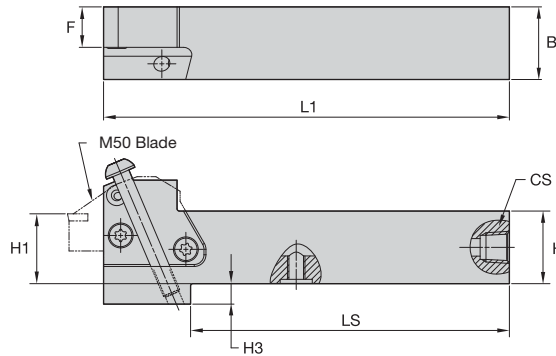

M65 Blade
Left Hand

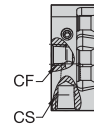
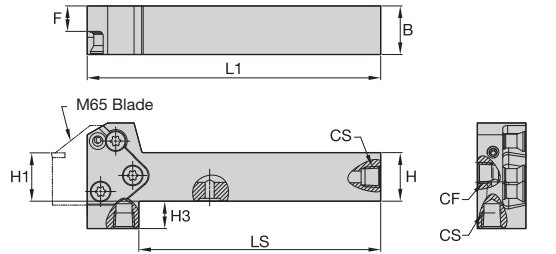

order number	catalogue number	B	H	H1	L1	F	CS	CF	LS	H3	blade size
right hand											
6499222	WGCMSR2525M50C	25	25	25	138,75	13,84	G 1/8-28	G 1/8-28	109,00	7,00	50
6499223	WGCMSR2525M65C	25	25	25	150,00	13,00	G 1/8-28	G 1/8-28	122,00	—	65
6499224	WGCMSR3232P50C	32	32	32	158,75	20,08	G 1/8-28	G 1/8-28	133,62	—	50
6499225	WGCMSR3232P65C	32	32	32	170,00	20,00	G 1/8-28	G 1/8-28	142,00	21,75	65
left hand											
6499226	WGCMSL2525M50C	25	25	25	138,75	13,84	G 1/8-28	G 1/8-28	109,00	7,00	50
6499227	WGCMSL2525M65C	25	25	25	150,00	13,00	G 1/8-28	G 1/8-28	122,00	29,00	65
6499228	WGCMSL3232P50C	32	32	32	158,75	20,08	G 1/8-28	G 1/8-28	133,62	—	50
6499229	WGCMSL3232P65C	32	32	32	170,00	20,00	G 1/8-28	G 1/8-28	142,00	21,75	65

NOTE: WGCMS.: Right-hand holder uses right-hand blades.
 WGCME.: Right-hand holder uses left-hand blades.
 M50 blade and clamp screw torque equals 71–88 in. lbs. (8–10 Nm).
 M65 blade and clamp screw torque equals 159–177 in. lbs. (18–20 Nm).

screw catalogue number	screw order number	torque		thread	socket	wrench catalogue number	wrench order number
		Nm	in. lbs.				
MS1160	1099645	7	62	M5	T20	KT20	1022703
MS1162	1127019	9	80	M6	T25	KT25	1022725
MS1163	1124104	18	159	M8	T30	KT30L	1099676
MS1273	1020977	4	35.4	M4	T15	KT15	1022701
MS1490	2263299	17	151	M8	T45	KT45	1018227
MS1595	1094300	12	106	M6	T30	KT30	1099676
MS1970	1106668	12	106	M6	T30	KT30	1099676
MS2002	1621087	9	80	M6	T25	KT25	1022725
MS2091	1931147	9	80	M5	25IP	K25IP	2050113

WGC • Modular Toolholder • Endmount • with Coolant • Metric



M50 Blade
Right Hand

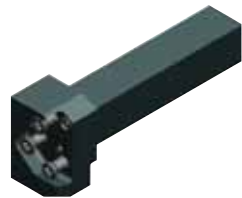

M65 Blade
Left Hand

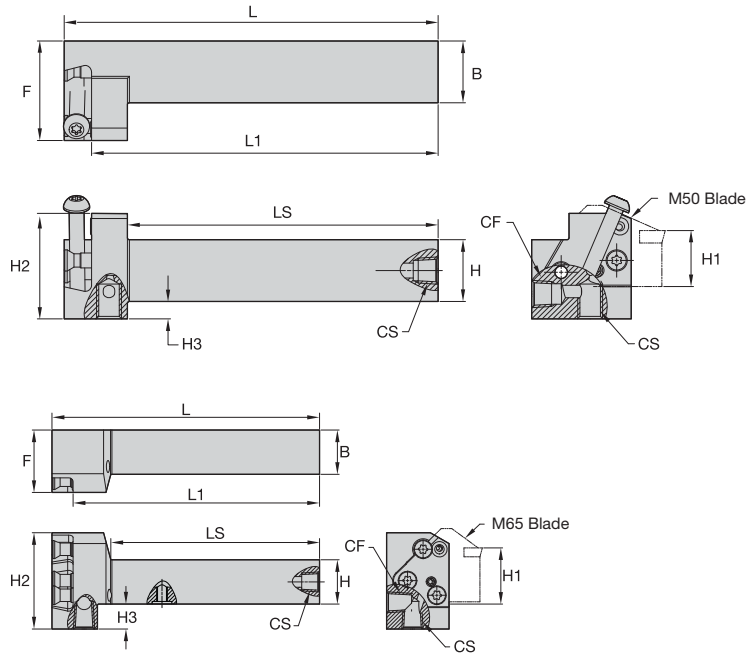

order number	catalogue number	B	H	H1	L	L1	LS	F	CS	CF	H2	H3	blade size
right hand													
6498953	WGCMER2525M65C	25	25	25	150,00	138,15	117,00	35,00	G 1/8-28	G 1/8-28	54,00	14,00	65
6498954	WGCMER2525M50C	25	25	25	150,25	139,25	125,25	0,98	G 1/8-28	G 1/8-28	42,41	7,00	50
6498955	WGCMER3232P65C	32	32	32	170,00	158,15	137,00	35,00	G 1/8-28	G 1/8-28	54,00	7,00	65
6498956	WGCMER3232P50C	32	32	32	170,25	159,25	145,25	0,98	G 1/8-28	G 1/8-28	42,41	—	50
left hand													
6498957	WGCME2525M65C	25	25	25	150,00	138,15	117,00	35,00	G 1/8-28	G 1/8-28	54,00	14,00	65
6498958	WGCME2525M50C	25	25	25	150,25	139,25	125,25	0,98	G 1/8-28	G 1/8-28	42,41	7,00	50
6498959	WGCME3232P65C	32	32	32	170,00	158,15	137,00	35,00	G 1/8-28	G 1/8-28	54,00	7,00	65
6498960	WGCME3232P50C	32	32	32	170,25	159,25	145,25	0,98	G 1/8-28	G 1/8-28	42,41	—	50

NOTE: WGCMS.: Right-hand holder uses right-hand blades.
 WGCME.: Right-hand holder uses left-hand blades.
 M50 blade and clamp screw torque equals 71–88 in. lbs. (8–10 Nm).
 M65 blade and clamp screw torque equals 159–177 in. lbs. (18–20 Nm).

screw catalogue number	screw order number	torque Nm	torque in. lbs.	thread	socket	wrench catalogue number	wrench order number
MS1160	1099645	7	62	M5	T20	KT20	1022703
MS1162	1127019	9	80	M6	T25	KT25	1022725
MS1163	1124104	18	159	M8	T30	KT30L	1099676
MS1273	1020977	4	35.4	M4	T15	KT15	1022701
MS1490	2263299	17	151	M8	T45	KT45	1018227
MS1595	1094300	12	106	M6	T30	KT30	1099676
MS1970	1106668	12	106	M6	T30	KT30	1099676
MS2002	1621087	9	80	M6	T25	KT25	1022725
MS2091	1931147	9	80	M5	25IP	K25IP	2050113

INDEXABLE MILLING

SOLID END MILLING

HOLEMAKING

TAPPING

TURNING

WGC Integral Boring Bars



Right Hand

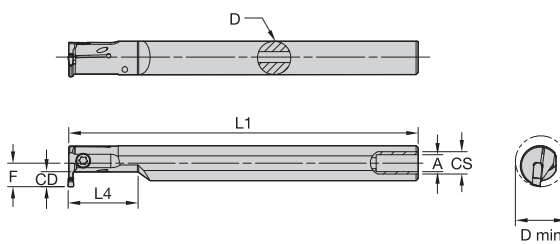

Right Hand



Left Hand

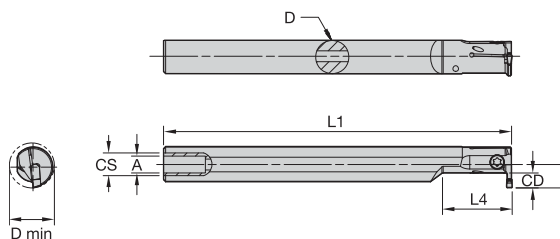

Left Hand

order number	catalogue number	SSC	D	D min	CD	F	L1	LS
right hand								
6948205	A12KWGCCEMR0205M	2	12	16	5	9	125	108
6948206	A16MWGCCEMR0207M	2	16	20	7	11	150	126
6948207	A20QWGCCEMR0207M	2	20	25	7	13	180	149
6948208	A25RWGCCEMR0210M	2	25	32	10	17	200	167
6948209	A16MWGCCEMR0307M	3	16	20	7	11	150	126
6948210	A20QWGCCEMR0307M	3	20	25	7	13	180	153
6948361	A25RWGCCEMR0310M	3	25	32	10	17	200	169
6948362	A25RWGCCEMR0410M	4	25	32	10	17	200	167
left hand								
6948363	A12KWGCCEML0205M	2	12	16	5	9	125	108
6948364	A16MWGCCEML0207M	2	16	20	7	11	150	126
6948365	A20QWGCCEML0207M	2	20	25	7	13	180	149
6948366	A25RWGCCEML0210M	2	25	32	10	17	200	167
6948367	A16MWGCCEML0307M	3	16	20	7	11	150	126
6948368	A20QWGCCEML0307M	3	20	25	7	13	180	153
6948369	A25RWGCCEML0310M	3	25	32	10	17	200	169
6948370	A25RWGCCEML0410M	4	25	32	10	17	200	167

NOTE: SSC = Pocket Seat Reference. To correspond with the SSC on the insert.

WGC • Double-Ended Cut-Off Blade

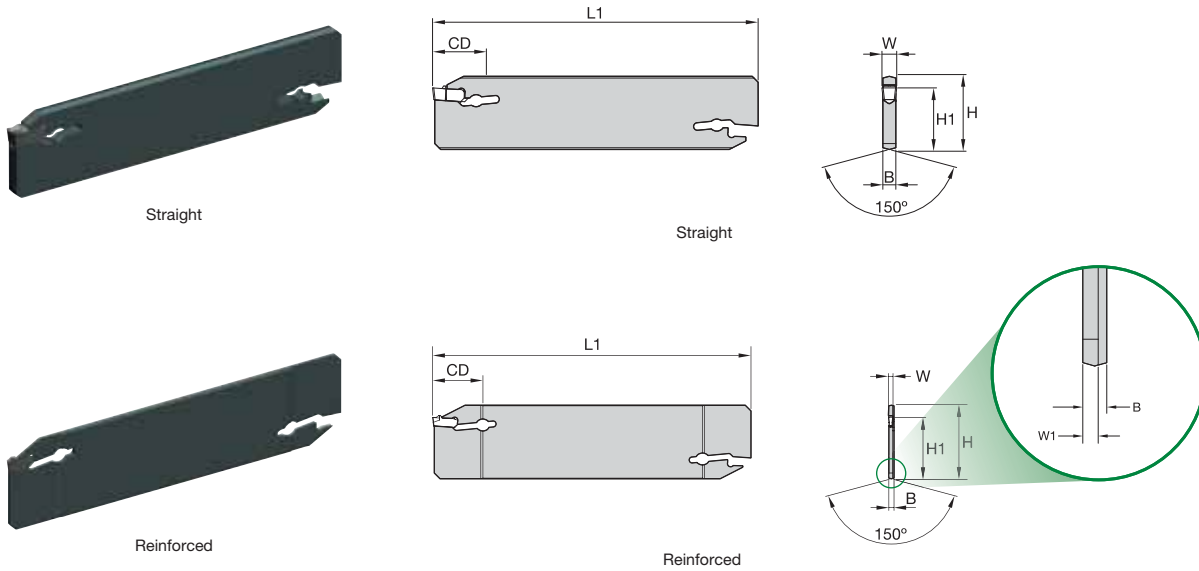

order number	catalogue number	SSC	H	W	W1	H1	L1	B	CD
neutral hand									
6498987	WGCBNS19G1B14	1B	19	1,4	1,15	15,5	90	1,80	14
6498988	WGCBNS26J1B15	1B	26	1,4	1,15	21,5	110	1,80	15
6498989	WGCBNS19G1F16	1F	19	1,6	1,30	15,5	90	1,80	16
6498990	WGCBNS26J1F17	1F	26	1,6	1,30	21,5	110	1,80	17
6499211	WGCBNS19G0220	2	19	2,0	—	15,5	90	1,65	20
6499212	WGCBNS26J0230	2	26	2,0	—	21,5	110	1,65	30
6499213	WGCBNS32M0250	2	32	2,0	—	25,1	150	1,65	50
6499214	WGCBNS26J0340	3	26	3,0	2,40	21,5	110	2,40	40
6499215	WGCBNS32M0350	3	32	3,0	2,40	25,1	150	2,40	50
6499216	WGCBNS26J0440	4	26	4,0	3,40	21,5	110	3,40	40
6499217	WGCBNS32M0450	4	32	4,0	3,40	25,1	150	3,40	50
6499218	WGCBNS32M0560	5	32	5,0	4,40	25,1	150	4,40	60
6499219	WGCBNS32M0660	6	32	6,0	5,40	25,1	150	5,40	60
6499220	WGCBNS32M0860	8	32	8,0	7,00	25,1	150	7,00	60
6499221	WGCBNS52X08120	8	53	8,0	7,00	45,3	260	7,00	120

NOTE: SSC = Pocket Seat Reference. To correspond with the SSC on the insert.

WGCM-S-C • WGC Modular Straight Blade with Coolant



Left Hand

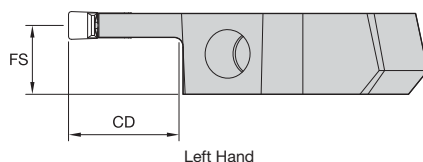

Left Hand

order number	catalogue number	SSC	CD	FS	blade size
right hand					
6498457	WGCM50R1F12M	1F	12,0	11,00	50
6498458	WGCM50R0212M	2	12,0	10,88	50
6498459	WGCM50R0216M	2	16,0	10,88	50
6498460	WGCM50R0312MC	3	12,0	10,43	50
6498861	WGCM50R0322MC	3	22,0	10,43	50
6498862	WGCM50R0412MC	4	12,0	9,93	50
6498863	WGCM50R0422MC	4	22,0	9,93	50
6498864	WGCM50R0432MC	4	32,0	9,93	50
6498865	WGCM50R0512MC	5	12,0	9,43	50
6498866	WGCM50R0516MC	5	16,0	9,43	50
6498867	WGCM50R0526MC	5	26,0	9,43	50
6498868	WGCM50R0532MC	5	32,0	9,43	50
6498869	WGCM65R0616MC	6	16,0	9,88	65
6498870	WGCM65R0626MC	6	26,0	9,88	65
6498881	WGCM65R0632MC	6	32,0	9,88	65
6498882	WGCM65R0816MC	8	16,0	9,00	65
6498883	WGCM65R0826MC	8	26,0	9,00	65
left hand					
6498884	WGCM50L1F12M	1F	12,0	11,00	50
6498885	WGCM50L0212M	2	12,0	10,88	50
6498886	WGCM50L0216M	2	16,0	10,88	50
6498887	WGCM50L0312MC	3	12,0	10,43	50
6498888	WGCM50L0322MC	3	22,0	10,43	50
6498889	WGCM50L0412MC	4	12,0	9,93	50
6498890	WGCM50L0422MC	4	22,0	9,93	50
6498891	WGCM50L0432MC	4	32,0	9,93	50
6498892	WGCM50L0512MC	5	12,0	9,43	50
6498893	WGCM50L0516MC	5	16,0	9,43	50
6498894	WGCM50L0526MC	5	26,0	9,43	50
6498895	WGCM50L0532MC	5	32,0	9,43	50
6498896	WGCM65L0616MC	6	16,0	9,88	65
6498897	WGCM65L0626MC	6	26,0	9,88	65
6498898	WGCM65L0632MC	6	32,0	9,88	65
6498899	WGCM65L0816MC	8	16,0	9,00	65
6498900	WGCM65L0826MC	8	26,0	9,00	65

NOTE: SSC = Pocket Seat Reference. To correspond with the SSC on the insert.
Through the pocket coolant available in seat sizes 3 and higher.

WGC • Blade Holders • Metric

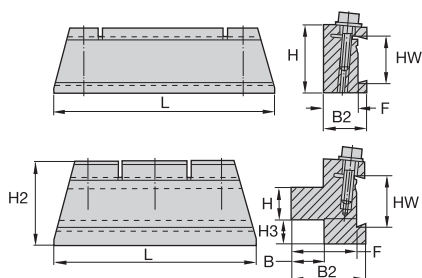

order number	catalogue number	HW	H	B	F	H2	B2	H3	L
2007826	12251222000	26	20,0	18,0	33,0	40	38	8	100
2021635	12251222500	32	25,0	20,0	35,0	50	40	10	125
2008159	12251233200	53	32,0	25,0	50,0	82	57	30	160
2021723	12251234000	53	40,0	40,0	58,0	82	65	22	160

Universal Style Toolholder • 76mm Bar Capacity

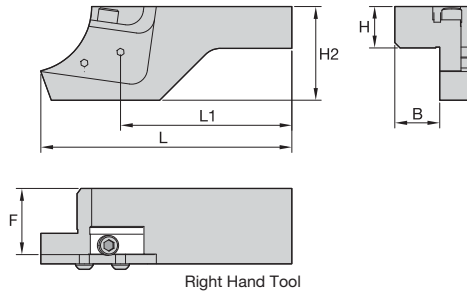

Right Hand Tool



order number	catalogue number	B	H	H2	F	L1	L	support blade screw	clamp screw
right hand									
3538739	206411	27,00	25,00	56,36	39,78	102,96	150,85	MS1072	MS352
3615306	206443	27,00	32,00	56,36	39,78	102,96	150,85	MS1072	MS1294

NOTE: Support blade requires two screws.
Order blades separately.

Components

W	L1	FS	left hand clamp	support blade	right hand clamp
3.0	57,05	1,27	435137	309111	435136
4.0	57,05	1,84	435106	309105	435103

NOTE: All components ship separately.

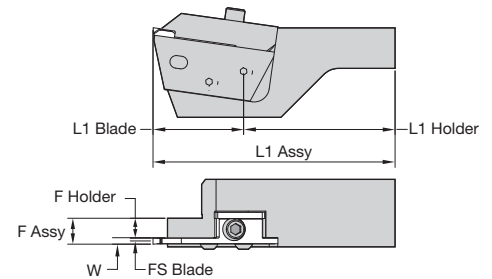

L1 Assy = L1 (holder) + L1 (blade)
F Assy = F (holder) + FS (blade) + W/2

INDEXABLE MILLING

SOLID END MILLING

HOLEMAKING

TAPPING

TURNING

Coolant Kit

Kit Description	Order Number	Shank Size	Coolant Pressure	Component Description													
				Component Order Number													
				1/16 NPTF MALE TO JIC MALE	1/8 NPTF MALE TO JIC MALE	M8 X 1.25 MALE TO JIC MALE	M8 X 1.0 MALE TO JIC MALE	G1/8 MALE TO JIC MALE	M10 MALE TO JIC MALE	MALE JIC TO FEMALE JIC ELBOW	HEAVY-DUTY 200MM COOLANT HOSE	HEAVY-DUTY 300MM COOLANT HOSE	UNIV 200MM FLEX COOLANT HOSE	UNIV 300MM FLEX COOLANT HOSE	M8X1.0 BANJO 200MM FLEX HOSE	G1/8 BANJO 200MM FLEX HOSE	M8X1.0 BANJO 300MM FLEX HOSE
6145374	6145375	6145378	6475041	6145376	6145377	6145379	6145380	6145381	6432549	6432550	6475043	6475045	6475047	6475049			
<i>Universal 200mm flex hose coolant kit</i>	6475019	12–40mm 1/2–1-1/2"	200 Bar 2901 psi		•	•	•	•	•	•		•					
<i>Universal 300mm flex hose coolant kit</i>	6475021	12–40mm 1/2–1-1/2"	200 Bar 2901 psi	•	•	•	•	•	•			•					
<i>M8x1.0 banjo 200mm flex hose coolant kit</i>	6475023	12–20mm 1/2–3/4"	200 Bar 2901 psi					•	•	•					•		
<i>M8x1.0 banjo 300mm flex hose coolant kit</i>	6475025	12–20mm 1/2–3/4"	200 Bar 2901 psi					•	•	•							•
<i>G 1/8 banjo 200mm flex hose coolant kit</i>	6475027	25–40mm 1–1-1/2"	200 Bar 2901 psi					•	•	•							•
<i>G 1/8 banjo 300mm flex hose coolant kit</i>	6475029	25–40mm 1–1-1/2"	200 Bar 2901 psi					•	•	•							•
<i>Universal 200mm heavy-duty coolant kit</i>	6145372	25–40mm 1–1-1/2"	350 Bar* 5076 psi*	•	•			•	•	•	•						
<i>Universal 300mm heavy-duty coolant kit</i>	6145373	25–40mm 1–1-1/2"	350 Bar* 5076 psi*	•	•			•	•	•		•					

* Max pressure for seat size 02 holders is 200 bar/2901 psi.

Individual Kit Component List



order number	catalogue number	description
6145374	1-16NPTF-JIC	Straight fitting, 1/16 NPTF male thread to JIC male thread
6145375	1-8NPTF-JIC	Straight fitting, 1/8 NPTF male thread to JIC male thread
6145378	M8X1.25-JIC	Straight fitting, M8 x 1.25 male thread to JIC male thread
6475041	M8X1-JIC	Straight fitting, M8 x 1.0 male thread to JIC male thread
6145376	G18-JIC	Straight fitting, G 1/8 male thread to JIC male thread
6145377	M10X1.5-JIC	Straight fitting, M10 x 1.5 male thread to JIC male thread
6145379	JICM-JICF-ELB	Elbow fitting, male JIC thread to female JIC thread
6145380	COOL-HOSE-200-HD	Heavy Duty 200mm Coolant hose with JIC female fitting both ends
6145381	COOL-HOSE-300-HD	Heavy Duty 300mm Coolant hose with JIC female fitting both ends
6432549	COOL-HOSE-200-FLEX	Flexible braided 200mm Coolant hose with JIC female fitting both ends
6432550	COOL-HOSE-300-FLEX	Flexible braided 300mm Coolant hose with JIC female fitting both ends
6475043	M8X1-BAN-JIC-HOSE-200	Flexible braided 200mm Coolant hose, M8 x 1.0 male thread to JIC female thread. Contains (1) M8x1.0 banjo bolt and (2) M8 bonded washers
6475045	G18-BAN-JIC-HOSE-200	Flexible braided 200mm Coolant hose, G 1/8 male thread to JIC female thread. Contains (1) G 1/8 banjo bolt and (2) G 1/8 bonded washers
6475047	M8X1-BAN-JIC-HOSE-300	Flexible braided 300mm Coolant hose, M8 x 1.0 male thread to JIC female thread. Contains (1) M8x1.0 banjo bolt and (2) M8 bonded washers
6475049	G18-BAN-JIC-HOSE-300	Flexible braided 300mm Coolant hose, G 1/8 male thread to JIC female thread. Contains (1) G 1/8 banjo bolt and (2) G 1/8 bonded washers

Individual Kit Component List

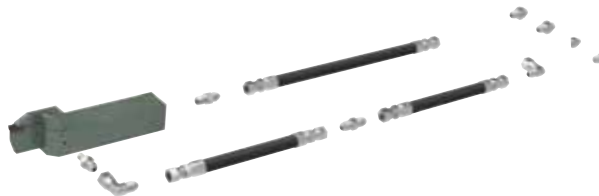

The items shown below are not part of any coolant kits shown on previous pages.

order number	catalogue number	description
6145382	M6X1-JIC	Straight fitting, M6 x 1.0 male thread to JIC male thread
6145383	JICM-JICM-STR	Straight fitting, JIC male thread to JIC male thread
6145386	G14-G18-RED	Straight fitting, G 1/4 male thread to G 1/8th male thread
6475058	R18-JIC	Straight fitting, 1/8 BSPT male thread to JIC male thread
6475059	R14-JIC	Straight fitting, 1/4 BSPT male thread to JIC male thread

Coolant Spare Parts

Included in kits; part of components.

order number	catalogue number	description
6475051	M8X1-BAN-BOLT	Banjo bolt, M8 x 1.0 male thread
6475053	G18-BAN-BOLT	Banjo bolt, G1/8 male thread
6475060	M6-BON-WASHER	M6 bonded washer
6475055	M8-BON-WASHER	M8 bonded washer
6475061	M10-BON-WASHER	M10 bonded washer
6475056	G18-BON-WASHER	G 1/8 bonded washer

Internal Coolant Delivery Guidelines

1. WGC system capable of 5076 psi (350 bar).
2. Toolholder delivered with four entry holes.
3. A quality filtration system is necessary to prevent blockages in the toolholder that will affect coolant flow and performance.
4. Machines without a proper filtering system may require modification or an inline filter.
 - For pressure >1015 psi [70 bar], use 10–20 µm filter.
 - For pressure <1015 psi [70 bar], 50–100 µm.
 - Using fine filters in low-pressure applications may affect flow rate.

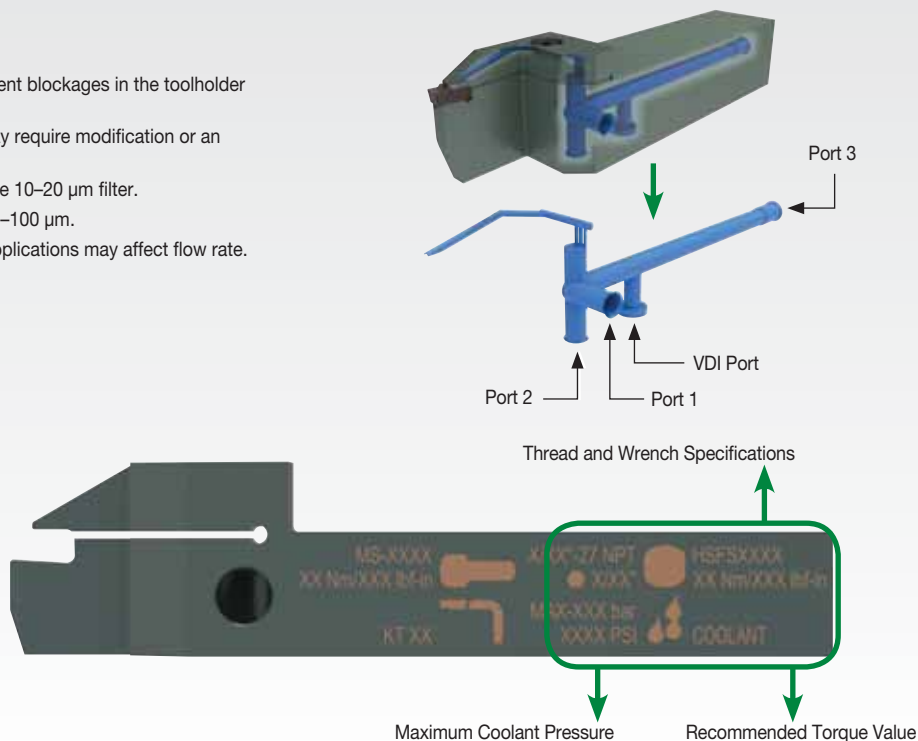

General Safety Guidelines

1. All safety doors and mechanisms must be in place before trying out the internal coolant to avoid any danger to the operator in the event of a failure.
2. Use the correct pipe fittings to connect the holders to the system. Ensure the maximum pressure recommended for the fittings are not exceeded.
3. While implementing pressure >1160 psi [80 bar], increase the pressure in steps to ensure proper functioning of insert clamping and leak-free joints.
4. While indexing inserts, ensure the pocket is free from chips and/or dirt. Also, inspect the insert and make sure there are no blockages in the coolant canal.
5. Periodically check all hoses and fittings for damage and wear for proper functioning of the system. This check should also include filters.

Internal Coolant Delivery Performance

Internal coolant offers a clear advantage in tool life and chip forming/evacuation vs. external coolant in difficult conditions and in high-pressure coolant.

Example: Chipbreaking in plunging of steel.

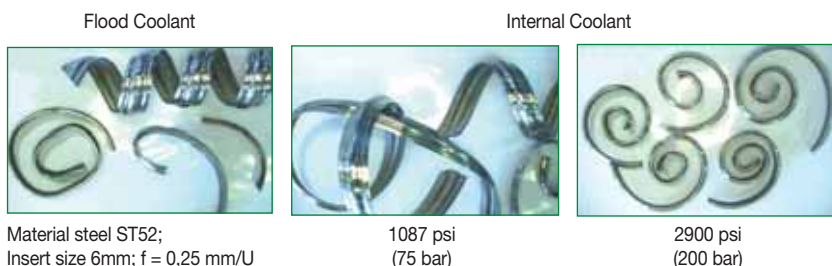

Low Pressure — If performance is at risk due to low coolant pressure, apply internal coolant in combination with external coolant to increase volume.

Recommendation to improve tool life and/or productivity: Apply high-pressure coolant: 80–350 bar recommended.

VDI Assemblies

The WGC internal coolant delivery can be leveraged with VDI holding systems with both traditional or Quick-Change coolant connections.



The WMT platform is the economical and reliable option for grooving, cut-off, turning, and profiling applications.

The WMT system, with its extra-long clamping area and precise insert positioning, ensures exceptionally fast and accurate machining, and is an all-in-one tool for demanding operations.

- Specifically designed to increase speeds and feeds.
- Versatile geometry for even your most demanding deep-grooving applications.
- The WMT system enables heavy stock removal in turning applications.
- Ensures finer surface finishes and a long, reliable tool life.
- Extra-long clamping area for unsurpassed grooving and turning stability.
- Interchangeable grooving and cut-off inserts designed for excellent chip control.



FIVE AVAILABLE CHIPBREAKER STYLES

CM

Cut-Off Medium

CM-W

Cut-Off Medium
with Wiper

PT

Groove, Plunge, and Turn

PC







Plunge and Contour

PH

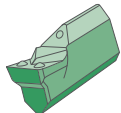
Groove, Plunge,
and Turn

RELIABLE ACCURACY WITH WMT™

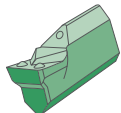
INSERTS

APPLICATION	TYPES	GROOVE WIDTH	INSERT GEOMETRY	GRADE	MATERIALS
GROOVING		2,0–8,0mm	PT, PH	WU10PT, WU25PT	
FACE GROOVING		3,0–6,35mm	PT, PH	WU10HT	
CUT-OFF		1,5–4,0mm	CM CM-W	WP10CT, WP25CT	
PROFILING		3,0–8,0mm	PC - Full Radius		

APPLICATIONS



TURNING



GROOVING



I.D. GROOVING



FACE
GROOVING



CUT-OFF



PROFILING

INDUSTRY

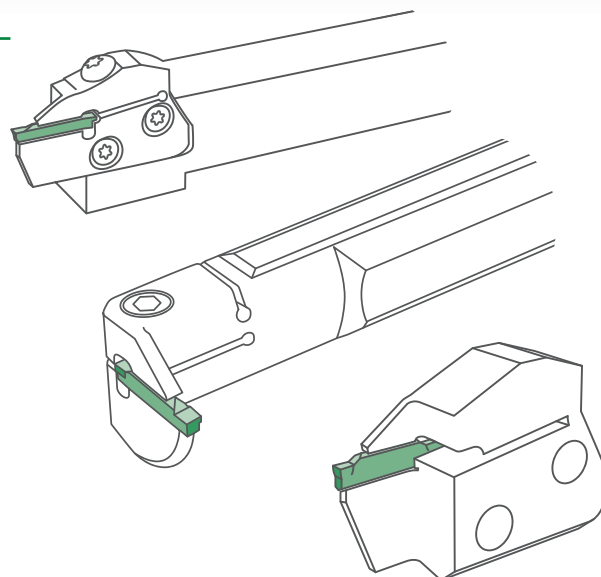

Choosing the Correct WMT Tooling

The Most Advanced Turning Solutions in the Industry

For unsurpassed quality, value, and performance, look no further than the WIDIA™ comprehensive line of specially engineered and dependable grooving and cut-off solutions. All the tools you need from the reliable name you can trust!

The WMT system, with its extra-long clamping area and precise insert positioning, ensures exceptionally fast and accurate machining, all-in-one tool, for your most demanding grooving, cut-off, turning, and profiling applications.

It is perfect for all general-purpose operations, including both shallow and deep grooving.

Utilize this handy, easy-to-use guide to identify and select the appropriate grooving and cut-off tools for your specific needs.

1 Choose the application to be performed:

Groove depth, width, and profile.

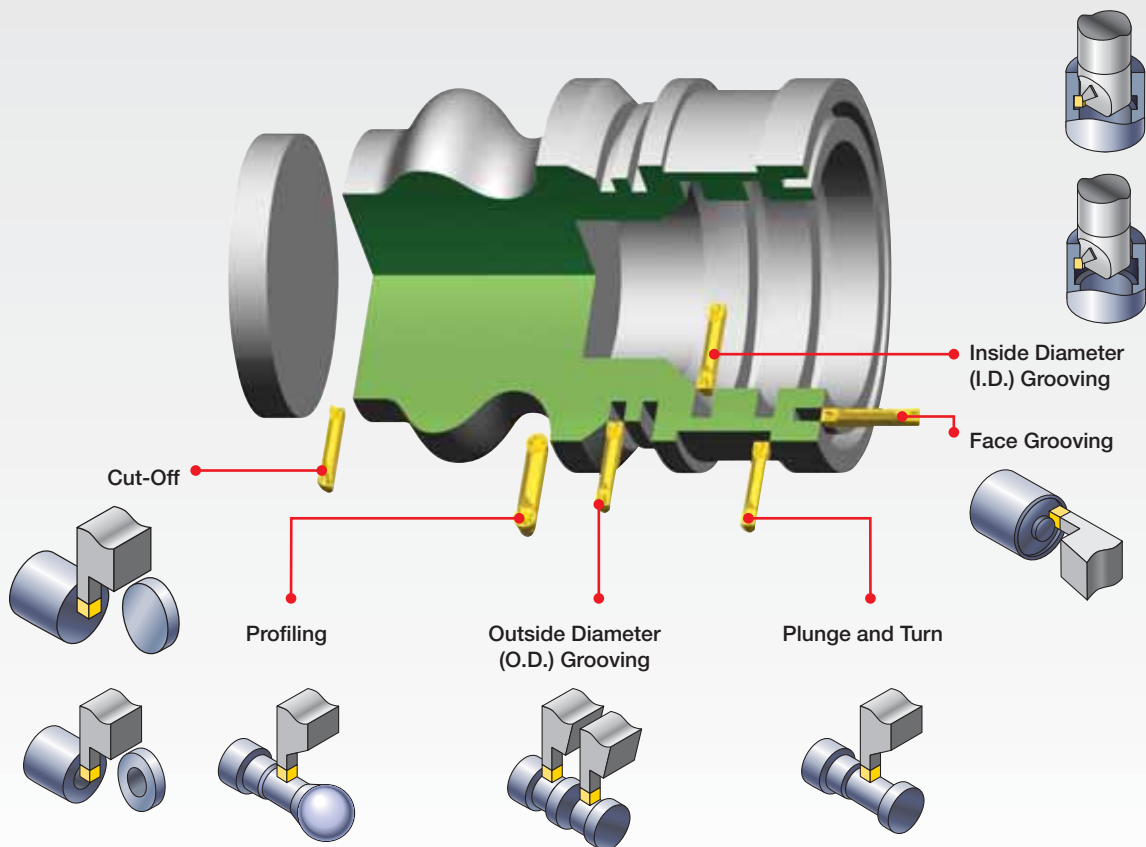

2 Identify the material to be machined:

Each tool has a material grid marked with a letter indicating the materials that can be machined.

P	Steel
M	Stainless Steel
K	Cast Iron
N	Non-Ferrous
S	High-Temp Alloys
H	Hardened Materials

Choosing the Correct WMT Tooling

3 Select your toolholder based on the application:

- A Choose the appropriate width “W” required for the application.
- B Choose the shortest cutting depth “CD” dimension for increased tool rigidity.
- C Select the largest toolholder shank “H” and “B” dimensions for maximum rigidity.

Grooving and Cut-Off • WMT™

WMT Integral Toolholders • Metric

Order number	Catalogue number	ISO	A	H	B	CD	F	HD	L1	L2
Right Hand										
2550116	WMTSR220M119	1	1.50	35.0	25.0	11	25.0	—	150	116
2550152	WMTSR1212H213	2	2.00	12.0	12.0	—	12.0	—	150	74
2944677	WMTSR1212H215	2	2.00	12.0	12.0	—	12.0	—	150	70
3550436	WMTSR1818K218	2	1.00	18.0	18.0	11	18.0	8	125	90
3550438	WMTSR2020K218	2	1.00	20.0	20.0	11	20.0	8	125	94
3550558	WMTSR2222M215	2	1.00	22.0	22.0	11	22.0	8	150	118
3550112	WMTSR1919K2019	2	1.50	19.0	19.0	11	19.0	8	125	98
3550174	WMTSR2020K2019	2	1.50	20.0	20.0	11	20.0	8	125	98
3550460	WMTSR1616K211	2	1.00	16.0	16.0	11	16.0	8	125	88
3550462	WMTSR1616K322	2	1.00	16.0	16.0	22	16.0	8	125	85
3550468	WMTSR2020K311	2	1.00	20.0	20.0	11	20.0	8	125	98
3550470	WMTSR2020K322	2	1.00	20.0	20.0	22	20.0	8	125	95
3550478	WMTSR2525M311	3	1.00	25.0	25.0	11	25.0	8	150	118
3550481	WMTSR2525M322	3	1.00	25.0	25.0	22	25.0	8	150	119
3550502	WMTSR1818K411	4	1.00	18.0	18.0	11	18.0	8	125	92
3550484	WMTSR1818K422	4	1.00	18.0	18.0	22	18.0	8	125	92
3550701	WMTSR2020K22	2	1.00	20.0	20.0	22	20.0	8	125	88
3550504	WMTSR2020K411	4	1.00	20.0	20.0	11	20.0	8	125	92
3550702	WMTSR2525M411	4	1.00	25.0	25.0	11	25.0	8	150	117
3550483	WMTSR2020M322	4	1.00	20.0	20.0	22	20.0	8	125	106
3550473	WMTSR2020K314	3	1.00	20.0	20.0	14	20.0	8	125	88
3550475	WMTSR2020L225	3	1.00	20.0	20.0	25	20.0	8	140	85
3550485	WMTSR2020M414	4	1.00	20.0	20.0	14	20.0	8	140	114
3550487	WMTSR2525M522	5	1.00	25.0	25.0	22	25.0	8	150	121
3550437	WMTSR2020L414	4	1.00	20.0	20.0	14	20.0	8	140	103
3550489	WMTSR2020M614	6	1.00	20.0	20.0	14	20.0	8	150	119
3550491	WMTSR2020M624	6	1.00	20.0	20.0	24	20.0	8	150	119

		application	conventional toolholders	modular blades
		O.D. Grooving and Cut-Off	E364–E366	E372
		Face Grooving	E367–E368	E371
		I.D. Grooving	E369	—
		Plunge and Turn	E364–E366	E372

Choosing the Correct WMT Tooling

4 Select chipbreaker style for the application:

- CM** Cut-Off Medium
- CM-W** Cut-Off Medium with Wiper
- PT** Groove, Plunge, and Turn
- PC** Plunge and Contour
- PH** Groove, Plunge, and Turn

NOTE: Chart shows recommended starting feed rates.

WMT™ Turning, Grooving, Cut-off, and Profiling

Feed Values for Grooving Inserts

CM Cut-Off Medium

- Double-ended, V bottom, and top, mechanically clamped
- Neutral, right, and left hand lead angles up to 12°
- Designed to increase speed and feed
- Chip geometry designed for excellent chip control and minimized cutting pressure on various materials



CM-W Cut-Off Medium with Wiper

- Wiper flats where surface finish is critical
- Double-ended, V bottom, and top, mechanically clamped
- Neutral, right, and left hand lead angles up to 12°
- Designed to increase speed and feed
- Chip geometry designed for excellent chip control and minimized cutting pressure on various materials
- Ideal for 300 Series stainless steel, tool steel, titanium, INCONEL™, and other nickel-based alloys at moderate speeds and feeds



PT Plunge, Groove, and Turn Inserts

- High positive rake geometry for low cutting force, especially in soft materials
- Deep grooving tool for plunge and turn O.D. and face grooving operations
- Delivers chip control over full range of DOC when turning
- Cut in both axial and radial directions



PC Grooving and Profiling Inserts

- Superior chip control
- Full nose radius geometry for plunge and contour operations
- Effective cutting edge geometry exceeds 192° for increased versatility



PH Plunge, Groove, and Turn Inserts

- Excellent performance in greater than 35 HRC
- Deep grooving tool for plunge and turn O.D. and face grooving operations
- Delivers chip control over full range of DOC when turning
- Delivers superior chip control in interrupted cuts



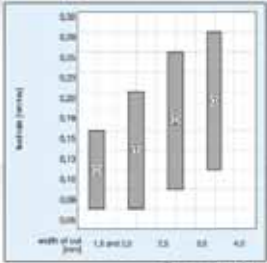

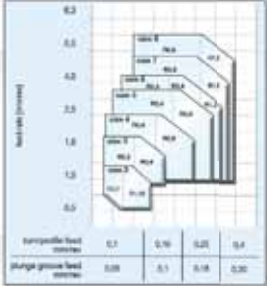

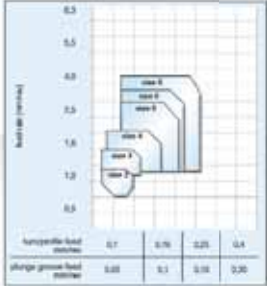

- A** Choose the appropriate insert width “W” for your specific application.
- B** Select the required corner radius value “RR”.

Grooving and Cut-Off • WMT™

WMT Cut-Off Inserts • F Precision Milled



Right Hand

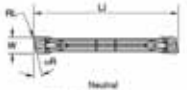

Neutral

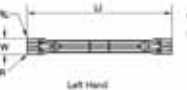

Left Hand

● first choice
○ alternate choice

P	●	●	●	●	●	●	●	●	●
M	●	●	●	●	●	●	●	●	●
K	●	●	●	●	●	●	●	●	●
N	●	●	●	●	●	●	●	●	●
S	●	●	●	●	●	●	●	●	●
H	●	●	●	●	●	●	●	●	●

RR = RL on neutral inserts

catalogue number	SSC	A W	B RR	RL	LJ	VL	VR	WMT19PT	WMT25PT	WMT30PT	WMT35PT	WMT40PT
WMTCD19R12CM68	1	1,50	0,08	0,08	18,28	—	12	●	●	●	●	●
WMTCD19R12CM68	1	1,50	0,08	0,08	18,30	—	—	●	●	●	●	●

Choosing the Correct WMT Tooling

5 Select grade:

Grooving cutting condition		Recommended Grades					
		steel	stainless steel	cast iron	non-ferrous metals	high-temp alloys	hardened materials
heavily interrupted cut		WU25PT	WU25PT	WU25PT	WU25PT	WU25PT	-
lightly interrupted cut		WP25CT/ WU25PT	WU25PT	WP25CT/ WU25PT	WU25PT	WU25PT	-
varying depth of cut, casting, or forging skin		WU10PT	WU10PT	WP10CT/ WU10PT	WU10PT	WU10HT/ WU10PT	WU10PT
smooth cut, pre-turned surface		WP10CT/ WU10PT	WU10PT	WP10CT/ WU10PT	WU10PT	WU10HT/ WU10PT	WU10PT

Cut-Off cutting condition		Recommended Grades					
		steel	stainless steel	cast iron	non-ferrous metals	high-temp alloys	hardened materials
heavily interrupted cut		WU25PT	WU25PT	WU25PT	WU25PT	WU25PT	-
lightly interrupted cut		WU25PT	WU25PT	WU25PT	WU25PT	WU25PT	-
varying depth of cut, casting, or forging skin		WU25PT	WU25PT	WU25PT	WU25PT	WU25PT	WU25PT
smooth cut, pre-turned surface		WU25PT	WU25PT	WU25PT	WU25PT	WU25PT	WU25PT

NOTE: See page E347 for Grades and Grade Descriptions.

6 Determine cutting data:

- A Based on material group and grade, identify starting speed (vc).
- B First choice starting speed is in bold.

NOTE: See page E349 for cutting data.

Grooving and Cut-Off • WMT™

Recommended Cutting Speeds • Metric

Material Group	Cutting Speed - vc m/min															
	WU10HT			WU10PT			WU25PT			WP10CT			WP25CT			
	min	Start	max	min	Start	max	min	Start	max	min	Start	max	min	Start	max	
A	0/1	100	100	110	190	200	210	170	175	180	210	225	240	170	175	180
	2	95	95	105	185	195	190	160	165	170	210	220	230	165	165	205
	3	90	90	100	180	190	185	155	160	165	210	220	230	160	160	200
	4	70	70	75	165	170	175	135	140	145	190	195	205	155	155	195
M	1	85	90	95	170	175	180	140	150	155	190	195	155	165	170	
	2	50	50	50	100	100	110	70	75	80	70	75	80	70	75	80
	3	30	30	30	35	40	45	20	20	20	20	20	20	20	20	20
K	1	95	90	95	190	200	210	155	165	170	215	225	235	180	185	195
	2	75	75	80	185	190	200	155	165	175	205	215	225	175	185	195
	3	75	75	80	175	175	180	140	150	160	210	225	240	180	200	210
G	1	70	75	80	140	150	160	110	120	130	--	--	--	--	--	--
	2	70	75	80	140	150	160	110	120	130	--	--	--	--	--	--
	3	70	75	80	140	150	160	110	120	130	--	--	--	--	--	--

Catalog Numbering System

Each character in our catalog number signifies a specific trait of that product. Use the following key columns and corresponding images to easily identify which attributes apply.

Cut-Off

WMT	C	015	N	00	CM	08
Tooling System	Cut-Off	W in mm* 10	Hand of Insert	Main Cutting Edge Lead Angle	Chipbreaker Geometry CM = Cut-Off Medium CM-W = Cut-Off Medium with Wiper	Corner Radius in mm* 10

Groove, Plunge, Turn, and Contour Inserts

WMT	S	205	M	2	U	02	PT
Tooling System	Square	mm* 10 inch* 1000	Unit of Measurement for Width M = mm I = inch	Seat Size	Insert Tolerance	Corner Radius in mm* 10	Chipbreaker Geometry PT = Groove, Plunge, and Turn PH = Groove, Plunge, and Turn PC = Plunge and Contour

P = Precision ground grooving width tolerance:
± .001" (0,025mm)

U = Utility molded grooving width tolerance:

3,05–4,05:	$\frac{+.006"}{-0}$	$\frac{(+0,15\text{mm})}{-0}$
5,05–10,05:	$\frac{+.010"}{-0}$	$\frac{(+0,25\text{mm})}{-0}$

Grades and Grade Descriptions

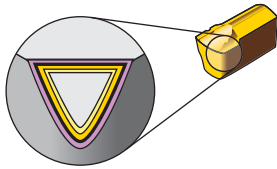

Coatings provide high-speed capability and are engineered for finishing to heavy roughing.

P	Steel
M	Stainless Steel
K	Cast Iron
N	Non-Ferrous
S	High-Temp Alloys
H	Hardened Materials

wear resistance ← → toughness

Grade	Coating	Grade Description	Material Groups																		
			P	M	K	N	S	H	05	10	15	20	25	30	35	40	45				
WU10PT		An advanced PVD-TiAlN coating over a very deformation-resistant unalloyed carbide substrate. The WU10PT™ grade's new and improved coating enables speeds to be increased by 50-100%. The WU10PT grade is ideal for finishing to general machining of most workpiece materials at higher speeds. Excellent for machining most steels, stainless steels, cast irons, non-ferrous materials, and super alloys under stable conditions. It also performs well machining hardened and short chipping materials.	P																		
	HC-P15		M																		
WU25PT		An advanced PVD-TiAlN-coated grade with a tough, ultra-fine-grain, unalloyed substrate. For general-purpose machining of most steels, stainless steels, high-temperature alloys, titanium, irons, and non-ferrous materials. Speeds may vary from low to medium and will handle interruptions and high feed rates.	P																		
	HC-P30		M																		
WU10HT		A hard, low binder content, unalloyed WC/Co fine-grained uncoated grade. Exceptional edge wear resistance combined with very high strength for machining titanium, cast irons, austenitic stainless steels, non-ferrous metals, non-metals, and most high-temperature alloys. Superior thermal deformation and depth-of-cut notch resistance. The grain structure is well controlled for minimal pits and flaws, which contributes to long, reliable service.																			
	HW-K15		M																		
WP10CT		A specially engineered, proprietary, cobalt-enriched carbide grade with thick K-MTCVD-TiCN coating layer, an Al ₂ O ₃ layer of controlled grain size, and outer layers of TiCN and TiN for maximum wear resistance. An excellent finishing to medium machining grade for a variety of workpiece materials including most steels, ferritic and martensitic stainless steels, and cast irons. The specially engineered cobalt-enriched substrate offers a balanced combination of deformation resistance and edge toughness, while the thick coating layers offer outstanding abrasion resistance and crater wear resistance for high-speed machining. The smooth coating provides good resistance to edge build-up and microchipping and produces excellent surface finishes.	P																		
	HC-P10		K																		
WP25CT		A tough cobalt-enriched carbide grade with a newly designed multilayer K-MTCVD TiCN-Al ₂ O ₃ -TiCN/TiN coating with superior interlayer adhesion. This is the industry's best general-purpose turning grade for most steels and ferritic and martensitic stainless steels. The substrate design, with cobalt-enrichment, ensures adequate deformation resistance along with excellent bulk toughness and insert edge strength. The coating layers offer good wear resistance over a wide range of machining conditions. The smoothness of the coating leads to reduced frictional heat, minimizes microchipping, and improves workpiece surface finishes.	P																		
	HC-P25		K																		

INDEXABLE MILLING

SOLID END MILLING

HOLEMAKING

TAPPING

TURNING

Feed Values for Grooving Inserts

CM Cut-Off Medium

- Double-ended, V-bottom, and top, mechanically clamped.
- Neutral, right-, and left-hand lead angles up to 12°.
- Designed to increase speed and feed.
- Chip geometry designed for excellent chip control and minimized cutting pressure on various materials.



CM-W Cut-Off Medium with Wiper

- Wiper flats where surface finish is critical.
- Double-ended, V-bottom, and top, mechanically clamped.
- Neutral, right-, and left-hand lead angles up to 12°.
- Designed to increase speed and feed.
- Chip geometry designed for excellent chip control and minimized cutting pressure on various materials.
- Ideal for 300 Series stainless steel, tool steel, titanium, INCONEL®, and other nickel-based alloys at moderate speeds and feeds.



PT Plunge, Groove, and Turn Inserts

- High positive rake geometry for low cutting force, especially in soft materials.
- Deep grooving tool for plunge and turn O.D. and face grooving operations.
- Deliver chip control over full range of DOC when turning.
- Cut in both axial and radial directions.



PC Grooving and Profiling Inserts

- Superior chip control.
- Full nose radius geometry for plunge and contour operations.
- Effective cutting edge geometry exceeds 180° for increased versatility.



PH Plunge, Groove, and Turn Inserts

- Excellent performance in greater than 35 HRC.
- Deep grooving tool for plunge and turn O.D. and face grooving operations.
- Deliver chip control over full range of DOC when turning.
- Deliver superior chip control in interrupted cuts.

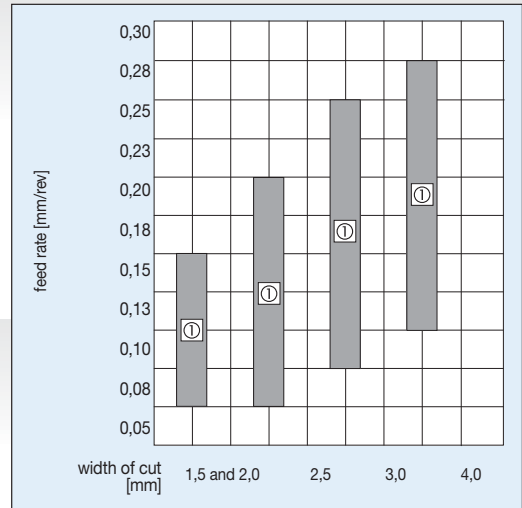

① Recommended Starting Feed

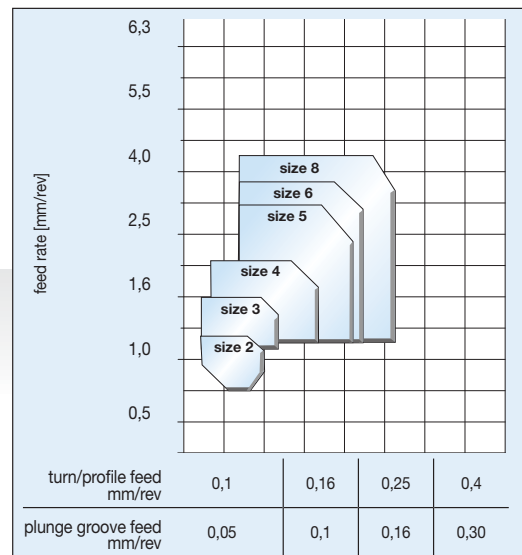
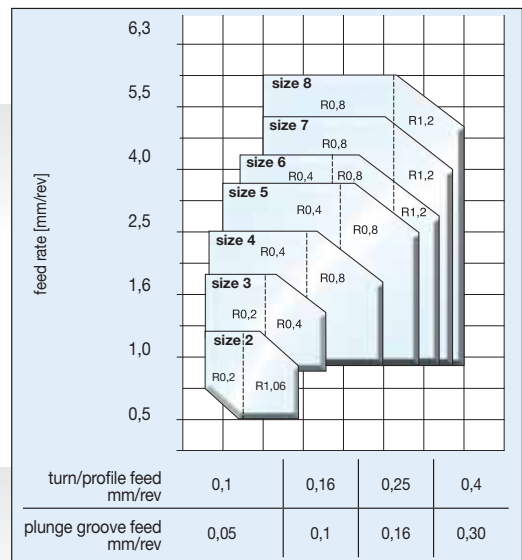

Recommended Cutting Speeds • Metric

Material Group		Cutting Speed – vc m/min														
		WU10HT			WU10PT			WU25PT			WP10CT			WP25CT		
		min	Start	max	min	Start	max	min	Start	max	min	Start	max	min	Start	max
P	0/1	100	100	110	190	200	210	170	175	180	210	225	240	170	175	180
	2	95	95	105	180	185	190	150	160	170	210	220	230	185	195	205
	3	95	95	105	180	185	190	150	160	170	210	220	230	185	195	205
	4	70	70	75	165	170	175	135	145	155	140	145	155	125	125	135
	5	85	90	95	170	175	180	140	150	160	180	190	195	155	165	170
	6	50	50	50	140	150	160	120	125	130	70	75	80	70	75	80
M	1	70	75	80	120	125	130	120	125	130	-	-	-	-	-	-
	2	50	50	50	100	100	110	70	75	80	-	-	-	-	-	-
	3	50	50	50	95	100	105	85	90	95	-	-	-	-	-	-
K	1	85	90	95	190	200	210	155	165	170	215	225	235	180	190	195
	2	75	75	80	185	190	200	155	165	175	205	215	225	175	185	195
	3	70	75	80	170	175	180	140	150	160	210	225	240	190	200	210
N	1	70	75	80	140	150	160	110	120	130	-	-	-	-	-	-
	2	70	75	80	140	150	80	110	120	80	-	-	-	-	-	-
	3	70	75	80	140	150	80	110	120	80	-	-	-	-	-	-
	4	70	75	80	140	150	80	110	120	80	-	-	-	-	-	-
	5	70	75	80	140	150	80	110	120	80	-	-	-	-	-	-
	6	70	75	80	140	150	80	110	120	80	-	-	-	-	-	-
	7	70	75	80	140	150	120	110	120	105	-	-	-	-	-	-
S	1	20	25	30	70	75	80	60	65	65	-	-	-	-	-	-
	2	20	25	30	65	65	70	50	50	50	-	-	-	-	-	-
	3	50	50	50	100	100	110	70	75	80	-	-	-	-	-	-
	4	-	-	-	70	75	80	50	50	50	-	-	-	-	-	-
H	1	-	-	-	15	30	60	15	30	60	-	-	-	-	-	-
	2	-	-	-	15	30	60	15	30	60	-	-	-	-	-	-
	3	-	-	-	15	30	60	15	30	60	-	-	-	-	-	-
	4	-	-	-	15	30	60	15	30	60	-	-	-	-	-	-

INDEXABLE MILLING

SOLID END MILLING

HOLEMAKING

TAPPING

TURNING

WMT Cut-Off Inserts • F Precision Molded

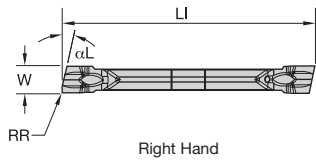

Right Hand

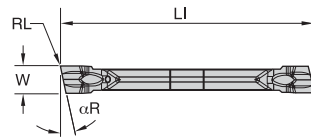

Neutral

RR = RL on neutral inserts

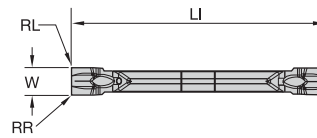

Left Hand

● first choice
○ alternate choice

P	●	○	○	○	○	○	○	○	○
M	●	○	○	○	○	○	○	○	○
K	●	○	○	○	○	○	○	○	○
N	●	○	○	○	○	○	○	○	○
S	●	○	○	○	○	○	○	○	○
H	○	○	○	○	○	○	○	○	○

catalogue number	SSC	W	RR	RL	LI	αL	αR	WU10PT	WU25PT	WP10CT	WP25CT	WU10HT
WMTC015R12CM08	1	1,50	0,08	0,08	19,28	—	12	●	○	○	○	○
WMTC015N00CM08	1	1,50	0,08	0,08	19,30	—	—	○	○	○	○	○
WMTC015R05CM08	1	1,50	0,08	0,08	19,31	—	5	○	○	○	○	○
WMTC015L05CM08	1	1,50	0,08	0,08	19,31	5	—	○	○	○	○	○
WMTC020L05CM08	2	1,99	0,08	0,08	19,21	5	—	○	○	○	○	○
WMTC020R05CM08	2	1,99	0,08	0,08	19,21	—	5	○	○	○	○	○
WMTC020N00CM08	2	2,00	0,08	0,08	19,21	—	—	○	○	○	○	○
WMTC020L12CM08	2	2,00	0,08	0,08	19,25	12	—	○	○	○	○	○
WMTC020R12CM08	2	2,00	0,08	0,08	19,26	—	12	○	○	○	○	○
WMTC094R12CM13	2B	2,39	0,13	0,13	22,28	—	12	○	○	○	○	○
WMTC094N00CM13	2B	2,39	0,13	0,13	22,32	—	—	○	○	○	○	○
WMTC094R05CM13	2B	2,39	0,13	0,13	22,32	—	5	○	○	○	○	○

WMT Cut-Off Inserts • F Precision Molded

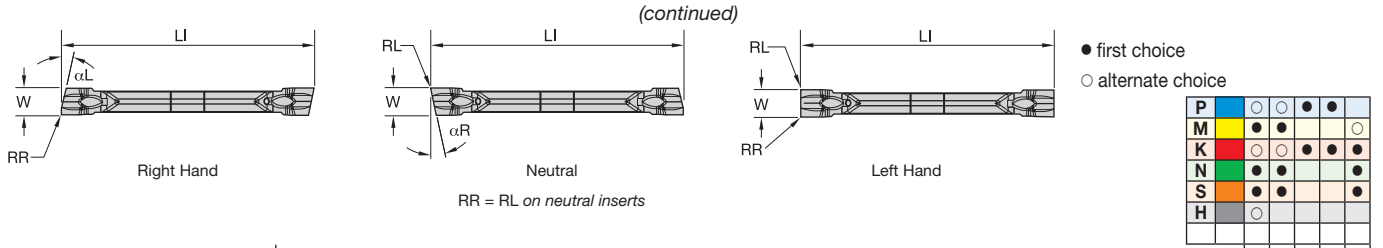

catalogue number	SSC	W	RR	RL	LI	αL	αR	WU10PT	WU25PT	WP10CT	WP25CT	WU10HT
WMTC030R05CM17	3	3,00	0,17	0,17	25,40	—	5	<input type="checkbox"/>	<input type="checkbox"/>	<input type="checkbox"/>	<input type="checkbox"/>	<input type="checkbox"/>
WMTC030R12CM17	3	3,00	0,17	0,17	25,40	—	12	<input type="checkbox"/>	<input type="checkbox"/>	<input type="checkbox"/>	<input type="checkbox"/>	<input type="checkbox"/>
WMTC030L12CM17	3	3,00	0,17	0,17	25,40	12	—	<input type="checkbox"/>	<input type="checkbox"/>	<input type="checkbox"/>	<input type="checkbox"/>	<input type="checkbox"/>
WMTC030N00CM17	3	3,00	0,17	0,17	25,40	—	—	<input type="checkbox"/>	<input type="checkbox"/>	<input type="checkbox"/>	<input type="checkbox"/>	<input type="checkbox"/>
WMTC030L05CM17	3	3,00	0,17	0,17	25,40	5	—	<input type="checkbox"/>	<input type="checkbox"/>	<input type="checkbox"/>	<input type="checkbox"/>	<input type="checkbox"/>
WMTC125R05CM17	3	3,17	0,17	0,17	25,40	—	5	<input type="checkbox"/>	<input type="checkbox"/>	<input type="checkbox"/>	<input type="checkbox"/>	<input type="checkbox"/>
WMTC125N00CM17	3	3,17	0,17	0,17	25,41	—	—	<input type="checkbox"/>	<input type="checkbox"/>	<input type="checkbox"/>	<input type="checkbox"/>	<input type="checkbox"/>
WMTC125R12CM17	3	3,18	0,17	0,17	25,40	—	12	<input type="checkbox"/>	<input type="checkbox"/>	<input type="checkbox"/>	<input type="checkbox"/>	<input type="checkbox"/>
WMTC040L12CM17	4	4,00	0,17	0,17	25,40	12	—	<input type="checkbox"/>	<input type="checkbox"/>	<input type="checkbox"/>	<input type="checkbox"/>	<input type="checkbox"/>
WMTC040N00CM17	4	4,00	0,17	0,17	25,40	—	—	<input type="checkbox"/>	<input type="checkbox"/>	<input type="checkbox"/>	<input type="checkbox"/>	<input type="checkbox"/>
WMTC040R12CM17	4	4,00	0,17	0,17	25,40	—	12	<input type="checkbox"/>	<input type="checkbox"/>	<input type="checkbox"/>	<input type="checkbox"/>	<input type="checkbox"/>
WMTC040R05CM17	4	4,00	0,17	0,17	25,40	—	5	<input type="checkbox"/>	<input type="checkbox"/>	<input type="checkbox"/>	<input type="checkbox"/>	<input type="checkbox"/>
WMTC040L05CM17	4	4,00	0,17	0,17	25,40	5	—	<input type="checkbox"/>	<input type="checkbox"/>	<input type="checkbox"/>	<input type="checkbox"/>	<input type="checkbox"/>

NOTE: SSC = Pocket Seat Reference. To correspond with the SSC on the insert.

WMT Cut-Off Inserts • F Precision Molded

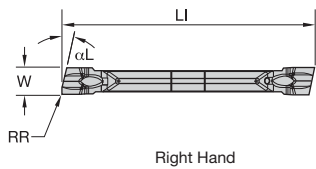

Right Hand

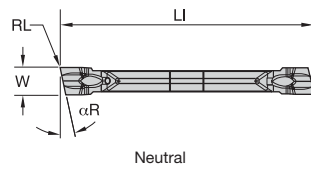

Neutral

RR = RL on neutral inserts

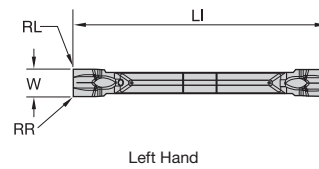

Left Hand

- first choice
- alternate choice

P	●	○	○	○	○	○	○	○	○
M	●	○	○	○	○	○	○	○	○
K	●	○	○	○	○	○	○	○	○
N	●	○	○	○	○	○	○	○	○
S	●	○	○	○	○	○	○	○	○
H	○	○	○	○	○	○	○	○	○

catalogue number	SSC	W	RR	RL	LI	αL	αR	WU10PT	WU25PT	WP10CT	WP25CT	WU10HT
WMTC015N00CMW08	1	1,50	0,08	0,08	19,30	—	—	●	●	○	○	○
WMTC020R05CMW08	2	2,00	0,08	0,08	19,20	—	5	●	●	○	○	○
WMTC020N00CMW08	2	2,00	0,08	0,08	19,21	—	—	●	●	○	○	○
WMTC020L12CMW08	2	2,00	0,08	0,08	19,27	12	—	●	●	○	○	○
WMTC020R12CMW08	2	2,00	0,08	0,08	19,27	—	12	●	●	○	○	○
WMTC094R12CMW13	2B	2,39	0,13	0,13	22,29	—	12	●	●	○	○	○
WMTC094N00CMW13	2B	2,39	0,13	0,13	22,32	—	—	●	●	○	○	○
WMTC094R05CMW13	2B	2,39	0,13	0,13	22,32	—	5	●	●	○	○	○
WMTC030R05CMW17	3	3,00	0,17	0,17	25,40	—	5	●	●	○	○	○
WMTC030R12CMW17	3	3,00	0,17	0,17	25,40	—	12	●	●	○	○	○
WMTC030L12CMW17	3	3,00	0,17	0,17	25,40	12	—	●	●	○	○	○
WMTC030N00CMW17	3	3,00	0,17	0,17	25,40	—	—	●	●	○	○	○

INDEXABLE MILLING

SOLID END MILLING

HOLEMAKING

TAPPING

TURNING

WMT Cut-Off Inserts • F Precision Molded

(continued)

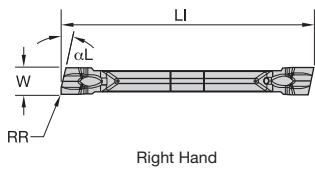

Right Hand

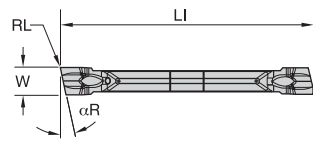

Neutral

RR = RL on neutral inserts

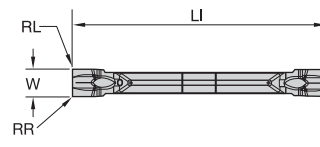

Left Hand

- first choice
- alternate choice

P	●	○	○	○	○	○	○	○
M	●	○	○	○	○	○	○	○
K	●	○	○	○	○	○	○	○
N	●	○	○	○	○	○	○	○
S	●	○	○	○	○	○	○	○
H	○	○	○	○	○	○	○	○

catalogue number	SSC	W	RR	RL	LI	αL	αR	WU10PT	WU25PT	WP10CT	WP25CT	WU10HT
WMTC030L05CMW17	3	3,00	0,17	0,17	25,40	5	—	●	○	○	○	○
WMTC125R05CMW17	3	3,17	0,17	0,17	25,41	—	5	○	○	○	○	○
WMTC125R12CMW17	3	3,17	0,17	0,17	25,41	—	12	○	○	○	○	○
WMTC125N00CMW17	3	3,18	0,17	0,17	25,41	—	—	○	○	○	○	○
WMTC040N00CMW17	4	4,00	0,17	0,17	25,40	—	—	○	○	○	○	○

NOTE: SSC = Pocket Seat Reference. To correspond with the SSC on the insert.

INDEXABLE MILLING

SOLID END MILLING

HOLEMAKING

TAPPING

TURNING

INDEXABLE MILLING

SOLID END MILLING

HOLEMAKING

TAPPING

TURNING

WMT Grooving Inserts • PT Precision Molded

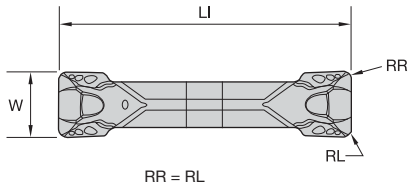

- first choice
- alternate choice

P	●	○	○	○	○	○	○	○	○
M	●	○	○	○	○	○	○	○	○
K	●	○	○	○	○	○	○	○	○
N	●	○	○	○	○	○	○	○	○
S	●	○	○	○	○	○	○	○	○
H	○	○	○	○	○	○	○	○	○

catalogue number	SSC	W	RR	LI	4117263	4117261	4117255	4117253	4116150	4116148	4113579	4113577	4113571	4113570	4113569	4113568	4116131	4116132	4169564	4169555	4169557	4169556	4169560	4169561	4169562	4169563	4169566	4169567	4169568	4169569	4169570	4169571	4169572	4169573	4169574	4169575					
WMTS205M2U02PT	2	2,13	0,15	19,23	○	○	○	○	○	○	○	○	○	○	○	○	○	○	○	○	○	○	○	○	○	○	○	○	○	○	○	○	○	○	○	○	○				
WMTS305M3U03PT	3	3,13	0,31	25,81	○	○	○	○	○	○	○	○	○	○	○	○	○	○	○	○	○	○	○	○	○	○	○	○	○	○	○	○	○	○	○	○	○	○			
WMTS305M3U06PT	3	3,13	0,61	25,78	○	○	○	○	○	○	○	○	○	○	○	○	○	○	○	○	○	○	○	○	○	○	○	○	○	○	○	○	○	○	○	○	○	○	○		
WMTS405M4U03PT	4	4,13	0,31	25,53	○	○	○	○	○	○	○	○	○	○	○	○	○	○	○	○	○	○	○	○	○	○	○	○	○	○	○	○	○	○	○	○	○	○	○		
WMTS405M4U06PT	4	4,13	0,61	25,53	○	○	○	○	○	○	○	○	○	○	○	○	○	○	○	○	○	○	○	○	○	○	○	○	○	○	○	○	○	○	○	○	○	○	○	○	
WMTS505M5U03PT	5	5,13	0,30	28,76	○	○	○	○	○	○	○	○	○	○	○	○	○	○	○	○	○	○	○	○	○	○	○	○	○	○	○	○	○	○	○	○	○	○	○	○	
WMTS505M5U06PT	5	5,13	0,61	28,76	○	○	○	○	○	○	○	○	○	○	○	○	○	○	○	○	○	○	○	○	○	○	○	○	○	○	○	○	○	○	○	○	○	○	○	○	○
WMTS605M6U03PT	6	6,13	0,30	28,76	○	○	○	○	○	○	○	○	○	○	○	○	○	○	○	○	○	○	○	○	○	○	○	○	○	○	○	○	○	○	○	○	○	○	○	○	○
WMTS605M6U06PT	6	6,13	0,59	28,76	○	○	○	○	○	○	○	○	○	○	○	○	○	○	○	○	○	○	○	○	○	○	○	○	○	○	○	○	○	○	○	○	○	○	○	○	○
WMTS805M8U06PT	8	8,13	0,61	28,70	○	○	○	○	○	○	○	○	○	○	○	○	○	○	○	○	○	○	○	○	○	○	○	○	○	○	○	○	○	○	○	○	○	○	○	○	○
WMTS805M8U15PT	8	8,13	1,50	28,71	○	○	○	○	○	○	○	○	○	○	○	○	○	○	○	○	○	○	○	○	○	○	○	○	○	○	○	○	○	○	○	○	○	○	○	○	○

NOTE: SSC = Pocket Seat Reference. To correspond with the SSC on the insert.

WMT Grooving Inserts • PT Precision Ground

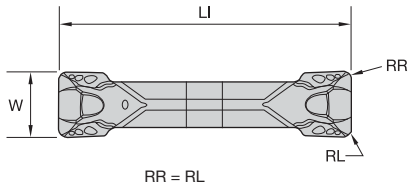

- first choice
- alternate choice

P	●	○	○	○	○	○	○
M	●	○	○	○	○	○	○
K	●	○	○	○	○	○	○
N	●	○	○	○	○	○	○
S	●	○	○	○	○	○	○
H	○	○	○	○	○	○	○

catalogue number	SSC	W	RR	LI	WU10PT	WU25PT	WP10CT	WP25CT	WU10HT
WMTS200M2P02PT	2	2,00	0,15	19,10	4116129	4116130	○	○	○
WMTS094I2BP02PT	2B	2,38	0,15	22,15	4118451	4118452	○	○	○
WMTS094I2BP04PT	2B	2,38	0,38	22,14	4118583	4118584	○	○	○
WMTS300M3P03PT	3	3,00	0,31	25,65	4113563	4113564	○	○	4113566
WMTS300M3P06PT	3	3,00	0,61	25,65	4113565	4113567	○	○	○
WMTS125I3P03PT	3	3,17	0,23	25,40	4118585	4118586	○	○	○
WMTS125I3P08PT	3	3,17	0,76	25,40	4118587	4118588	○	○	○
WMTS400M4P03PT	4	4,00	0,31	25,40	4113572	4113574	○	○	4113573
WMTS400M4P06PT	4	4,00	0,60	25,40	4113575	4113576	○	○	○
WMTS188I5P03PT	5	4,76	0,26	28,63	4118589	4118590	○	○	○
WMTS188I5P08PT	5	4,77	0,76	28,63	4118591	4118592	○	○	○
WMTS500M5P03PT	5	5,00	0,30	28,63	4116143	4116144	○	○	4116145

INDEXABLE MILLING

SOLID END MILLING

HOLEMAKING

TAPPING

TURNING

INDEXABLE MILLING

SOLID END MILLING

HOLEMAKING

TAPPING

TURNING

WMT Grooving Inserts • PT Precision Ground

(continued)

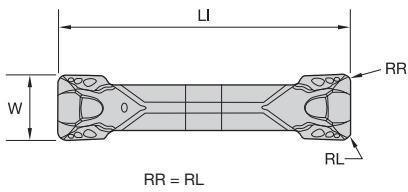

- first choice
- alternate choice

P	Blue	○	○	●	●	○
M	Yellow	●	●	○	○	○
K	Red	○	○	●	●	●
N	Green	●	●	○	○	○
S	Orange	●	●	○	○	○
H	Grey	○	○	○	○	○

catalogue number	SSC	W	RR	LI	WU10PT	WU25PT	WP10CT	WP25CT	WU10HT
WMTS500M5P06PT	5	5,00	0,61	28,63	4116146	4116147	●	●	○
WMTS600M6P03PT	6	6,00	0,30	28,63	4117239	4117240	●	●	○
WMTS600M6P06PT	6	6,00	0,58	28,63	4117241	4117242	●	●	○
WMTS250I6P08PT	6	6,34	0,76	28,63	4118595	4118596	●	●	○
WMTS250I6P03PT	6	6,35	0,25	28,63	4118593	4118594	●	●	○
WMTS800M8P06PT	8	8,00	0,61	28,57	4117258	4117259	●	●	○
WMTS800M8P15PT	8	8,00	1,50	28,57	4117260	4117261	●	●	○

NOTE: SSC = Pocket Seat Reference. To correspond with the SSC on the insert.

WMT Grooving Inserts • PC Full Radius Precision Molded

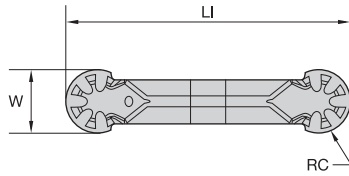

- first choice
- alternate choice

P	●	○	○	○	○	○	○	○	○
M	●	○	○	○	○	○	○	○	○
K	●	○	○	○	○	○	○	○	○
N	●	○	○	○	○	○	○	○	○
S	●	○	○	○	○	○	○	○	○
H	○	○	○	○	○	○	○	○	○

catalogue number	SSC	W	RC	LI	WU10PT	WU25PT	WP10CT	WP25CT	WU10HT
WMTR305M3UPC	3	3,13	1,53	25,53	4170172	4170173	4170174	●	○
WMTR405M4UPC	4	4,13	2,03	25,58	4170177	4170178	4170179	●	○
WMTR505M5UPC	5	5,13	2,53	29,01	4170182	4170183	4170184	●	○
WMTR605M6UPC	6	6,12	3,03	28,77	4170187	4170188	4170189	●	○
WMTR805M8UPC	8	8,13	4,03	29,22	4170192	4170193	4170194	●	○

NOTE: SSC = Pocket Seat Reference. To correspond with the SSC on the insert.

INDEXABLE MILLING

SOLID END MILLING

HOLEMAKING

TAPPING

TURNING

WMT Grooving Inserts • PC Full Radius Precision Ground

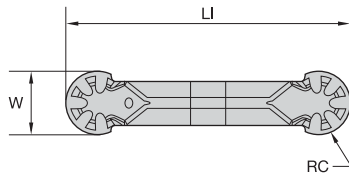

- first choice
- alternate choice

P	Blue	○	○	●	●	●	●
M	Yellow	●	●	●	●	●	○
K	Red	○	○	●	●	●	●
N	Green	●	●	●	●	●	●
S	Orange	●	●	●	●	●	●
H	Grey	○	○	○	○	○	○

catalogue number	SSC	W	RC	LI	WU10PT	WU25PT	WP10CT	WP25CT	WU10HT
WMTR300M3PPC	3	3,00	1,50	25,40	4170170	4170171	●	●	○
WMTR400M4PPC	4	4,00	2,00	25,45	4170175	4170176	●	●	○
WMTR188I5PPC	5	4,78	2,39	28,65	4170119	4170120	●	●	○
WMTR500M5PPC	5	5,00	2,50	28,88	4170180	4170181	●	●	○
WMTR600M6PPC	6	6,00	3,00	28,65	4170185	4170186	●	●	○
WMTR250I6PPC	6	6,36	3,18	29,01	4170121	4170122	●	●	○
WMTR312I8PPC	8	7,94	3,96	29,00	4170163	4170164	●	●	○
WMTR800M8PPC	8	8,00	4,00	29,08	4170190	4170191	●	●	○

NOTE: SSC = Pocket Seat Reference. To correspond with the SSC on the insert.

INDEXABLE MILLING

SOLID END MILLING

HOLEMAKING

TAPPING

TURNING

WMT Grooving Inserts • PH Precision Molded

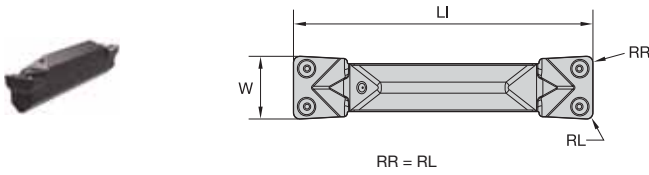

- first choice
- alternate choice

P	●	○	○	○	○	○	○	○	○
M	●	○	○	○	○	○	○	○	○
K	●	○	○	○	○	○	○	○	○
N	●	○	○	○	○	○	○	○	○
S	●	○	○	○	○	○	○	○	○
H	○	○	○	○	○	○	○	○	○

catalogue number	SSC	W	RR	LI	5346392	5346393	5346394	5346395	5346396	5346397	5346398	5346399	5346400	5346401	5346402	5346403	5346404	5346405	5346406	5346407	5346410	5346411	5346408	5346409
					WU10PT	WU25PT																		
WMTS305M3U03PH	3	3,13	0,30	25,81	●	○	○	○	○	○	○	○	○	○	○	○	○	○	○	○	○	○	○	○
WMTS305M3U06PH	3	3,13	0,60	25,81	○	○	○	○	○	○	○	○	○	○	○	○	○	○	○	○	○	○	○	○
WMTS405M4U03PH	4	4,13	0,30	25,53	○	○	○	○	○	○	○	○	○	○	○	○	○	○	○	○	○	○	○	○
WMTS405M4U06PH	4	4,13	0,60	25,53	○	○	○	○	○	○	○	○	○	○	○	○	○	○	○	○	○	○	○	○
WMTS505M5U03PH	5	5,13	0,30	28,76	○	○	○	○	○	○	○	○	○	○	○	○	○	○	○	○	○	○	○	○
WMTS505M5U06PH	5	5,13	0,60	28,76	○	○	○	○	○	○	○	○	○	○	○	○	○	○	○	○	○	○	○	○
WMTS605M6U03PH	6	6,13	0,30	28,76	○	○	○	○	○	○	○	○	○	○	○	○	○	○	○	○	○	○	○	○
WMTS605M6U06PH	6	6,13	0,60	28,76	○	○	○	○	○	○	○	○	○	○	○	○	○	○	○	○	○	○	○	○
WMTS805M8U03PH	8	8,13	0,30	28,70	○	○	○	○	○	○	○	○	○	○	○	○	○	○	○	○	○	○	○	○
WMTS805M8U06PH	8	8,13	0,60	28,70	○	○	○	○	○	○	○	○	○	○	○	○	○	○	○	○	○	○	○	○

NOTE: SSC = Pocket Seat Reference. To correspond with the SSC on the insert.

INDEXABLE MILLING

SOLID END MILLING

HOLEMAKING

TAPPING

TURNING

INDEXABLE MILLING

SOLID END MILLING

HOLEMAKING

TAPPING

TURNING

WMT Grooving Inserts • PH Precision Ground

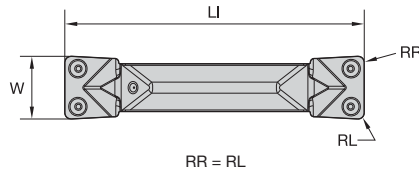

- first choice
- alternate choice

P	■	■	○	○	●	●	○
M	■	■	○	○	●	●	○
K	■	■	○	○	●	●	○
N	■	■	○	○	●	●	○
S	■	■	○	○	●	●	○
H	■	■	○	○	●	●	○

catalogue number	SSC	W	RR	LI	WU10PT	WU25PT	WP10CT	WP25CT	WU10HT
WMTS300M3P03PH	3	3,00	0,30	25,65	5346412	5346413	■	■	5346414
WMTS300M3P06PH	3	3,00	0,60	25,65	5346415	5346416	■	■	5346417
WMTS125I3P03PH	3	3,18	0,25	25,40	5345914	5291300	■	■	■
WMTS125I3P08PH	3	3,18	0,75	25,40	5345915	5331093	■	■	■
WMTS156I4P03PH	4	3,95	0,30	25,40	5345916	5345917	■	■	■
WMTS156I4P08PH	4	3,96	0,75	25,40	5345918	5345919	■	■	■
WMTS400M4P03PH	4	4,00	0,30	25,40	5346418	5346419	■	■	5346420
WMTS400M4P06PH	4	4,00	0,60	25,40	5346421	5346422	■	■	5346423
WMTS188I5P03PH	5	4,77	0,25	28,63	5345980	5331095	■	■	■
WMTS188I5P08PH	5	4,77	0,75	28,63	5345981	5331097	■	■	■
WMTS500M5P03PH	5	5,00	0,30	28,63	■	5346425	■	■	5346426
WMTS500M5P06PH	5	5,00	0,60	28,63	5346427	5346428	■	■	5346429

WMT Grooving Inserts • PH Precision Ground

(continued)

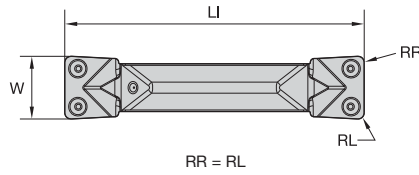

- first choice
- alternate choice

P	●	○	○	○	○	○	○	○	○
M	○	○	○	○	○	○	○	○	○
K	○	○	○	○	○	○	○	○	○
N	○	○	○	○	○	○	○	○	○
S	○	○	○	○	○	○	○	○	○
H	○	○	○	○	○	○	○	○	○

catalogue number	SSC	W	RR	LI	WU10PT	WU25PT	WP10CT	WP25CT	WU10HT
WMTS600M6P03PH	6	6,00	0,30	28,63	5346430	5346431	●	●	○
WMTS600M6P06PH	6	6,00	0,60	28,63	5346432	5346433	●	●	○
WMTS250I6P08PH	6	6,32	0,75	28,63	5345984	5327621	●	●	○
WMTS250I6P03PH	6	6,35	0,25	28,63	5345983	5327620	●	●	○
WMTS312I8P03PH	8	7,92	0,25	28,57	5345985	5345986	●	●	○
WMTS312I8P08PH	8	7,92	0,75	28,57	5345987	5345988	●	●	○
WMTS800M8P03PH	8	8,00	0,30	28,57	5346437	5346438	●	●	○
WMTS800M8P06PH	8	8,00	0,60	28,57	5346435	5346436	●	●	○

NOTE: SSC = Pocket Seat Reference. To correspond with the SSC on the insert.

INDEXABLE MILLING

SOLID END MILLING

HOLEMAKING

TAPPING

TURNING

Catalog Numbering System

Our WMT Toolholders now have a smart new naming system. Here are some examples of the improved nomenclature for our WMT Toolholders.

Integral Toolholders

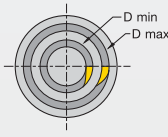
WMT	B	R	2525	M	3	13	—	038-052
Tooling System	Tool Style	Hand	Shank Size	Tool Length	Seat Size	Max Grooving Depth		Face Grooving Diameter
WMT = Groove and Turn (WMT Insert)	<p>S = Straight</p> <p>C = Straight with circular support</p> <p>E = End mount</p> <p>A = Straight, face grooving curve in</p> <p>B = Straight, face grooving curve out</p>	<p>R = Right hand</p> <p>L = Left hand</p>	Height x Width in mm	<p>H = 100</p> <p>J = 110</p> <p>K = 125</p> <p>L = 140</p> <p>M = 150</p> <p>P = 170</p>	<p>1</p> <p>2</p> <p>2B</p> <p>3</p> <p>4</p> <p>5</p> <p>6</p> <p>8</p>	CD max in mm	<p>D min – D max in mm (e.g., 70–100 = 70mm D min 100 mm D max)</p>	<p>Diameters are min and max for outer face groove diameter 999 = unlimited D max</p>
								

Modular Blades

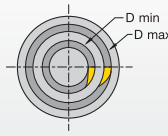
WMT	WGM	R	3	16	B	070-100
Tooling System	Connection Type	Hand	Seat Size	Max Grooving Depth	Tool Style	Face Grooving Diameter
		<p>R = Right hand</p> <p>L = Left hand</p>			<p>A = Curve In</p> <p>B = Curve Out</p>	

Catalog Numbering System

Our WMT Toolholders now have a smart new naming system. Here are some examples of the improved nomenclature for our WMT Toolholders.

Modular Toolholders

WGM	S	R	2525
Tooling System	Tool Style	Hand	Shank Size
<p>MDG = Modular Deep Grooving</p> <p>WGM = Modular Serrated Locking System</p>	<p>S = Straight</p> <p>E = End mount</p>	<p>R = Right hand</p> <p>L = Left hand</p>	

Integral Boring Bars

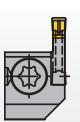
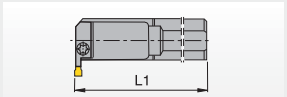
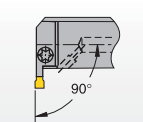
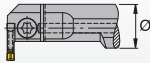
A	25	R	WMT	E	R	03	16	M																																				
Steel Bar with Coolant	Bar Diameter	Bar Length	WMT Groove & Turn System	Tool Style	Hand	Seat Size	Max Grooving Depth	Tool Units																																				
					<p>R = Right hand</p> <p>L = Left hand</p>			<p>N = Inch</p> <p>M = Metric</p>																																				
		<table border="1"> <tr> <th>metric bars:</th> <th>inch bars:</th> </tr> <tr> <td>R = 200mm</td> <td>R = 8"</td> </tr> <tr> <td>S = 250mm</td> <td>S = 10"</td> </tr> <tr> <td>T = 300mm</td> <td>T = 12"</td> </tr> </table>	metric bars:	inch bars:	R = 200mm	R = 8"	S = 250mm	S = 10"	T = 300mm	T = 12"		E = End mounted (90°)		<table border="1"> <tr> <th>pocket seat size</th> <th>cutting width (mm)</th> </tr> <tr> <td>02</td> <td>2,00-2,62</td> </tr> <tr> <td>2B</td> <td>2,39-2,62</td> </tr> <tr> <td>03</td> <td>3,0-3,05</td> </tr> <tr> <td>04</td> <td>4,0-4,05</td> </tr> <tr> <td>05</td> <td>5,0-5,05</td> </tr> <tr> <td>06</td> <td>6,0-6,05</td> </tr> <tr> <td>08</td> <td>8,0-8,05</td> </tr> <tr> <td>10</td> <td>10,0-10,05</td> </tr> </table>	pocket seat size	cutting width (mm)	02	2,00-2,62	2B	2,39-2,62	03	3,0-3,05	04	4,0-4,05	05	5,0-5,05	06	6,0-6,05	08	8,0-8,05	10	10,0-10,05		<p>conversions:</p> <table border="1"> <tr> <th>mm</th> <th>inch</th> </tr> <tr> <td>7mm</td> <td>.28"</td> </tr> <tr> <td>10mm</td> <td>.39"</td> </tr> <tr> <td>12mm</td> <td>.47"</td> </tr> <tr> <td>16mm</td> <td>.63"</td> </tr> </table>	mm	inch	7mm	.28"	10mm	.39"	12mm	.47"	16mm	.63"
metric bars:	inch bars:																																											
R = 200mm	R = 8"																																											
S = 250mm	S = 10"																																											
T = 300mm	T = 12"																																											
pocket seat size	cutting width (mm)																																											
02	2,00-2,62																																											
2B	2,39-2,62																																											
03	3,0-3,05																																											
04	4,0-4,05																																											
05	5,0-5,05																																											
06	6,0-6,05																																											
08	8,0-8,05																																											
10	10,0-10,05																																											
mm	inch																																											
7mm	.28"																																											
10mm	.39"																																											
12mm	.47"																																											
16mm	.63"																																											
	 <table border="1"> <tr> <th>metric bars:</th> <th>inch bars:</th> </tr> <tr> <td>Bar diameter in millimeters</td> <td>A two-digit number which indicates the bar diameter in 1/16" increments.</td> </tr> </table>	metric bars:	inch bars:	Bar diameter in millimeters	A two-digit number which indicates the bar diameter in 1/16" increments.																																							
metric bars:	inch bars:																																											
Bar diameter in millimeters	A two-digit number which indicates the bar diameter in 1/16" increments.																																											

WMT Integral Toolholders • Metric

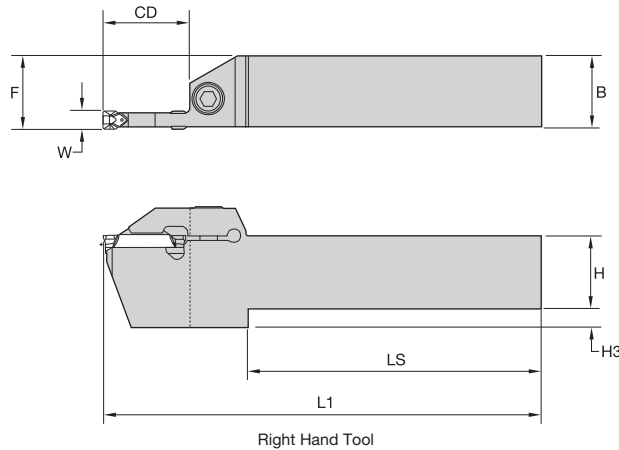
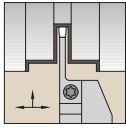

Right Hand Tool

order number	catalogue number	SSC	W	H	B	CD	F	H3	L1	LS
right hand										
3650516	WMTSR2525M116	1	1,50	25,0	25,0	17	25,0	—	150	116
3539162	WMTCR1212H213	2	2,00	12,0	12,0	—	12,0	—	100	74
5964677	WMTCR1212H216	2	2,00	12,0	12,0	—	12,0	—	100	70
3650456	WMTSR1616K216	2	2,00	16,0	16,0	17	16,0	6	125	93
3650458	WMTSR2020K216	2	2,00	20,0	20,0	17	20,0	—	125	93
3650506	WMTSR2525M216	2	2,00	25,0	25,0	17	25,0	—	150	118
3539172	WMTSR1616K2B19	2B	2,38	16,0	16,0	24	15,9	5	125	88
3539174	WMTSR2020K2B19	2B	2,38	20,0	20,0	24	19,9	5	125	88
3539221	WMTCR2525M2B19	2B	2,38	25,0	25,4	24	24,9	—	150	113
3650460	WMTSR1616K311	3	3,00	16,0	16,0	11	16,0	—	125	93
3650462	WMTSR1616K322	3	3,00	16,0	16,0	22	16,0	5	125	85
3650468	WMTSR2020K311	3	3,00	20,0	20,0	11	20,0	—	125	93
3650470	WMTSR2020K322	3	3,00	20,0	20,0	22	20,0	5	125	85
3650479	WMTSR2525M311	3	3,00	25,0	25,0	11	25,0	—	150	118
3650481	WMTSR2525M322	3	3,00	25,0	25,0	22	25,0	—	150	110
3650502	WMTSR1616K411	4	4,00	16,0	16,0	11	16,0	—	125	92
3650464	WMTSR1616K422	4	4,00	16,0	16,0	22	16,0	5	125	83
3653751	WMTSR2020K22	4	4,00	20,0	20,0	22	20,0	5	125	83
3650504	WMTSR2020K411	4	4,00	20,0	20,0	11	20,0	—	125	92
3653752	WMTSR2525M411	4	4,00	25,0	25,0	11	25,0	—	150	117
3650483	WMTSR2525M422	4	4,00	25,0	25,0	22	25,0	—	150	109
3650473	WMTSR2020K514	5	5,00	20,0	20,0	14	20,0	—	125	88
3650475	WMTSR2020L525	5	5,00	20,0	20,0	25	20,0	5	140	93
3650485	WMTSR2525M514	5	5,00	25,0	25,0	14	25,0	—	150	115
3650487	WMTSR2525M525	5	5,00	25,0	25,0	25	25,0	—	150	104
3650477	WMTSR2020L614	6	6,00	20,0	20,0	14	20,0	—	140	103
3650489	WMTSR2525M614	6	6,00	25,0	25,0	14	25,0	—	150	113
3650491	WMTSR2525M625	6	6,00	25,0	25,0	25	25,0	—	150	104
3650494	WMTSR2525M814	8	8,00	25,0	25,0	14	25,0	—	150	113
3650496	WMTSR2525M825	8	8,00	25,0	25,0	25	25,0	—	150	104
3650498	WMTSR3232M814	8	8,00	32,0	32,0	14	32,0	—	150	113
3650500	WMTSR3232M825	8	8,00	32,0	32,0	25	32,0	—	150	104
left hand										
3653332	WMTSL2525M116	1	1,50	25,0	25,0	17	25,0	—	150	116
3539163	WMTCL1212H213	2	2,00	12,0	12,0	—	12,0	—	100	74
3650457	WMTSL1616K216	2	2,00	16,0	16,0	17	16,0	6	125	93
3650459	WMTSL2020K216	2	2,00	20,0	20,0	17	20,0	—	125	93
3650507	WMTSL2525M216	2	2,00	25,0	25,0	17	25,0	—	150	118
3539173	WMTSL1616K2B19	2B	2,38	16,0	16,0	24	15,9	5	125	88
3539175	WMTSL2020K2B19	2B	2,38	20,0	20,0	24	19,9	5	125	88
3650461	WMTSL1616K311	3	3,00	16,0	16,0	11	16,0	—	125	93
3650463	WMTSL1616K322	3	3,00	16,0	16,0	22	16,0	5	125	85
3650469	WMTSL2020K311	3	3,00	20,0	20,0	11	20,0	—	125	93
3650471	WMTSL2020K322	3	3,00	20,0	20,0	22	20,0	5	125	85
3650480	WMTSL2525M311	3	3,00	25,0	25,0	11	25,0	—	150	118
3650482	WMTSL2525M322	3	3,00	25,0	25,0	22	25,0	—	150	110
3650465	WMTSL1616K422	4	4,00	16,0	16,0	22	16,0	5	125	83
3650472	WMTSL2020K22	4	4,00	20,0	20,0	22	20,0	5	125	83
3650505	WMTSL2020K411	4	4,00	20,0	20,0	11	20,0	—	125	92
3653763	WMTSL2525M411	4	4,00	25,0	25,0	11	25,0	—	150	117
3650484	WMTSL2525M422	4	4,00	25,0	25,0	22	25,0	—	150	109

WMT Integral Toolholders • Metric

(continued)

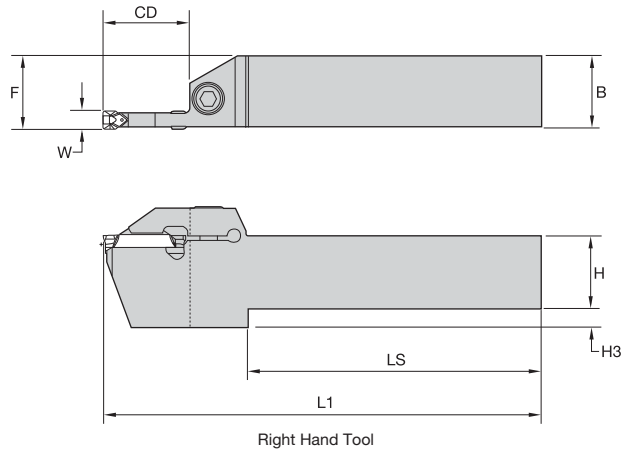
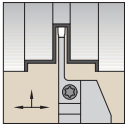

Right Hand Tool

order number	catalogue number	SSC	W	H	B	CD	F	H3	L1	LS
3650467	WMTSL1616K514	5	5,00	16,0	16,0	14	16,0	—	125	88
3650474	WMTSL2020K514	5	5,00	20,0	20,0	14	20,0	—	125	88
3650486	WMTSL2525M514	5	5,00	25,0	25,0	14	25,0	—	150	113
3650488	WMTSL2525M525	5	5,00	25,0	25,0	25	25,0	—	150	104
3650490	WMTSL2525M614	6	6,00	25,0	25,0	14	25,0	—	150	114
3650493	WMTSL2525M625	6	6,00	25,0	25,0	25	25,0	—	150	104
3650495	WMTSL2525M814	8	8,00	25,0	25,0	14	25,0	—	150	113
3650497	WMTSL2525M825	8	8,00	25,0	25,0	25	25,0	—	150	104
3650499	WMTSL3232M814	8	8,00	32,0	32,0	14	32,0	—	150	113
3650501	WMTSL3232M825	8	8,00	32,0	32,0	25	32,0	—	150	104

NOTE: SSC = Pocket Seat Reference. To correspond with the SSC on the insert.

INDEXABLE MILLING

SOLID END MILLING

HOLEMAKING

TAPPING

TURNING

WMT Integral Toolholders for Swiss-Style Machines • Metric

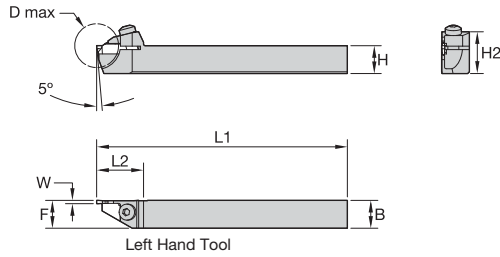
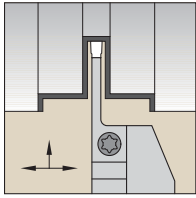

Left Hand Tool

order number	catalogue number	SSC	W	H	B	F	D max	H2	L1	L2
right hand										
3650508	WMTCR1010H110	1	1,50	10,0	10,0	10,0	20	16	100	21
3650510	WMTCR1212H110	1	1,50	12,0	12,0	12,0	20	18	100	21
3650512	WMTCR1616K113	1	1,50	16,0	15,9	16,0	26	24	125	24
3650514	WMTCR2020K113	1	1,50	20,0	19,9	20,0	26	28	125	24
3653413	WMTCR1010H210	2	2,00	10,0	10,0	10,0	20	16	100	21
3653415	WMTCR1212H210	2	2,00	12,0	12,0	12,0	20	18	100	21
3653417	WMTCR1616K213	2	2,00	16,0	15,8	16,0	26	24	125	24
3653419	WMTCR2020K213	2	2,00	20,0	19,8	20,0	26	28	125	24
3539170	WMTCR1212H2B16	2B	2,38	12,0	11,7	11,9	32	23	100	30
left hand										
3650509	WMTCL1010H110	1	1,50	10,0	10,0	10,0	20	16	100	21
3650511	WMTCL1212H110	1	1,50	12,0	12,0	12,0	20	18	100	21
3650513	WMTCL1616K113	1	1,50	16,0	15,9	16,0	26	24	125	24
3650515	WMTCL2020K113	1	1,50	20,0	19,9	20,0	26	28	125	24
3653414	WMTCL1010H210	2	2,00	10,0	10,0	10,0	20	16	100	21
3653416	WMTCL1212H210	2	2,00	12,0	12,0	12,0	20	18	100	21
3653418	WMTCL1616K213	2	2,00	16,0	15,8	16,0	26	24	125	24
3653420	WMTCL2020K213	2	2,00	20,0	19,8	20,0	26	28	125	24
3539171	WMTCL1212H2B16	2B	2,38	12,0	11,7	11,9	32	23	100	30

NOTE: Insert exterior edge in line with toolholder edge for 10mm and 12mm shank toolholders.
SSC = Pocket Seat Reference. To correspond with the SSC on the insert.

INDEXABLE MILLING

SOLID END MILLING

HOLEMAKING

TAPPING

TURNING

WMT Integral Toolholders for Face Grooving • Curve Out • Metric

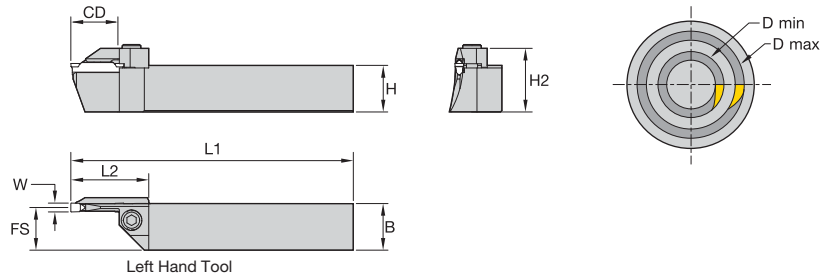
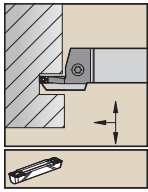

order number	catalogue number	SSC	W	H	B	FS	CD	D max	D min	H2	L1	L2
right hand												
3653421	WMTBR2525M313-038-052	3	3,00	25,0	25,0	23,5	13	52	38	32	150	34
3653423	WMTBR2525M316-052-070	3	3,00	25,0	25,0	23,5	16	70	52	32	150	34
3653425	WMTBR2525M316-070-100	3	3,00	25,0	25,0	23,5	16	100	70	32	150	34
3653427	WMTBR2525M319-100-205	3	3,00	25,0	25,0	23,5	19	205	100	32	150	37
3653764	WMTBR2525M412-032-052	4	4,00	25,0	25,0	23,0	13	52	32	32	150	34
3653766	WMTBR2525M415-052-070	4	4,00	25,0	25,0	23,0	16	70	52	32	150	34
3653768	WMTBR2525M415-070-100	4	4,00	25,0	25,0	23,0	16	100	70	32	150	34
3653770	WMTBR2525M418-100-205	4	4,00	25,0	25,0	23,0	19	205	100	32	150	37
3653433	WMTBR2525M519-070-100	5	5,00	25,0	25,0	22,5	19	100	70	34	150	42
3653435	WMTBR2525M525-100-205	5	5,00	25,0	25,0	22,5	25	205	100	34	150	42
left hand												
3653422	WMTBL2525M313-038-052	3	3,00	25,0	25,0	23,5	13	52	38	32	150	34
3653424	WMTBL2525M316-052-070	3	3,00	25,0	25,0	23,5	16	70	52	32	150	34
3653426	WMTBL2525M316-070-100	3	3,00	25,0	25,0	23,5	16	100	70	32	150	34
3653428	WMTBL2525M319-100-205	3	3,00	25,0	25,0	23,5	19	205	100	32	150	37
3653771	WMTBL2525M418-100-205	4	4,00	24,8	24,8	23,0	19	205	100	32	150	37
3653436	WMTBL2525M525-100-205	5	5,00	24,8	24,8	22,5	25	205	100	34	150	42
3653444	WMTBL2525M625-100-205	6	6,00	24,8	24,8	22,0	25	205	100	34	150	42

NOTE: Insert cutting edge for WMT Face Grooving system is positioned +0,75mm above center.
 The WMT Face Grooving system is not designed to cut diameters of less than 12,6mm.
 Toolholders that accept 3mm width inserts have an integral clamp.
 Toolholders that accept 5mm and 6mm width inserts are supplied with a detachable clamp.
 SSC = Pocket Seat Reference. To correspond with the SSC on the insert.

Blade Style	Part Shape		Left Hand	Right Hand
Curve Out				

WMT Integral Toolholders for Face Grooving • Curve In • Metric

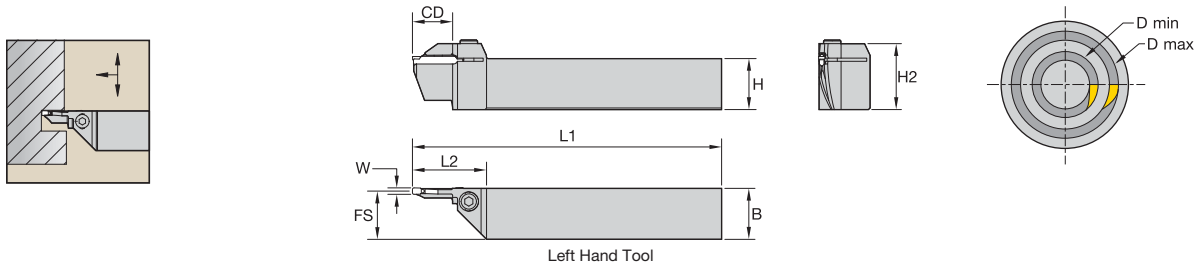

order number	catalogue number	SSC	W	H	B	FS	CD	D max	D min	H2	L1	L2
right hand												
3634282	WMTAR2525M316-070-100	3	3,00	24,8	24,8	23,5	16	100	70	32	150	34
3634284	WMTAR2525M319-100-205	3	3,00	24,8	24,8	23,5	19	205	100	32	150	37
3634290	WMTAR2525M619-070-100	6	6,00	24,8	24,8	22,0	19	100	70	34	150	42
left hand												
3634285	WMTAL2525M319-100-205	3	3,00	24,8	24,8	23,5	19	205	100	32	150	37
3634287	WMTAL2525M519-070-100	5	5,00	24,8	24,8	22,5	19	100	70	34	150	42

NOTE: Insert cutting edge for WMT Face Grooving system is positioned +0,75mm above center.
 The WMT Face Grooving system is not designed to cut diameters of less than 12,6mm.
 Toolholders that accept 3mm width inserts have an integral clamp.
 Toolholders that accept 5mm and 6mm width inserts are supplied with a detachable clamp.
 SSC = Pocket Seat Reference. To correspond with the SSC on the insert.

Blade Style	Part Shape		Left Hand	Right Hand
Curve In				

INDEXABLE MILLING

SOLID END MILLING

HOLEMAKING

TAPPING

TURNING

WMT Integral I.D. Grooving Boring Bars • Metric

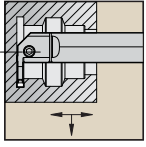

Steel shank with through coolant.



Right Hand Tool

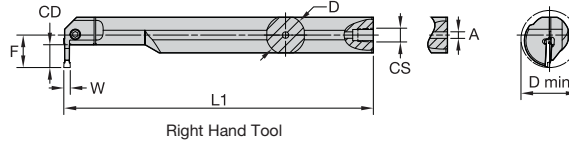

Right Hand Tool

order number	catalogue number	SSC	W	F	CD	D	D min	L1	A	CS
right hand										
5423874	A25RWMTER0316M	3	3,00	26,0	16	25,00	41	200	6,40	1/4-18 NPT
5423875	A32SWMTER0319M	3	3,00	29,0	19	32,00	47	250	6,40	1/4-18 NPT
5423876	A25RWMTER0416M	4	4,00	26,0	16	25,00	41	200	6,40	1/4-18 NPT
5423877	A32SWMTER0419M	4	4,00	29,0	19	32,00	47	250	6,40	1/4-18 NPT
5423878	A32SWMTER0519M	5	5,00	29,0	19	32,00	47	250	6,40	1/4-18 NPT
5423879	A40TWMTER0522M	5	5,00	32,0	22	40,00	54	300	6,40	1/4-18 NPT
5423880	A32SWMTER0619M	6	6,00	29,0	19	32,00	47	250	6,40	1/4-18 NPT
5423881	A40TWMTER0622M	6	6,00	31,8	22	40,00	54	300	6,40	1/4-18 NPT
left hand										
5423882	A25RWMTEL0316M	3	3,00	26,0	16	25,00	41	200	6,40	1/4-18 NPT
5423883	A32SWMTEL0319M	3	3,00	29,0	19	32,00	47	250	6,40	1/4-18 NPT
5423884	A25RWMTEL0416M	4	4,00	26,0	16	25,00	41	200	6,40	1/4-18 NPT
5423885	A32SWMTEL0419M	4	4,00	29,0	19	32,00	47	250	6,40	1/4-18 NPT
5423886	A32SWMTEL0519M	5	5,00	29,0	19	32,00	47	250	6,40	1/4-18 NPT
5423887	A40TWMTEL0522M	5	5,00	32,0	22	40,00	54	300	6,40	1/4-18 NPT
5423888	A32SWMTEL0619M	6	6,00	29,0	19	32,00	47	250	6,40	1/4-18 NPT
5423889	A40TWMTEL0622M	6	6,00	31,8	22	40,00	54	300	6,40	1/4-18 NPT

NOTE: SSC = Pocket Seat Reference. To correspond with the SSC on the insert.

INDEXABLE MILLING

SOLID END MILLING

HOLEMAKING

TAPPING

TURNING

WMT Modular Toolholders • Straight Mount • Grooving, Cut-Off, Face Grooving • Metric



Right Hand Tool
2 blade screws required

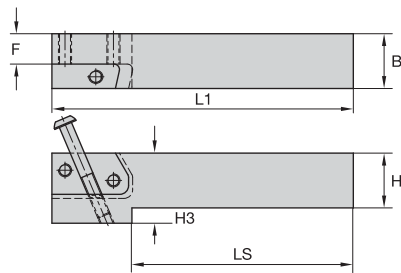

Right Hand Tool
2 blade screws required

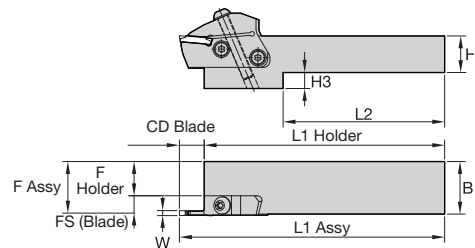

$$F \text{ Assy} = F \text{ (Holder)} + FS \text{ (Blade)} + W/2$$

$$L1 \text{ Assy} = L1 \text{ (Holder)} + CD \text{ (Blade)}$$

order number	catalogue number	H	B	L1	LS	F	H3
right hand							
5349628	WGMSR2020	20	20	108,0	68,00	8,84	12
5349629	WGMSR2525	25	25	126,0	95,78	13,84	7
5349641	WGMSR3232	32	32	126,0	69,85	20,81	—
left hand							
5349627	WGMSL2525	25	25	126,0	95,78	13,84	7

NOTE: Use the larger seat size toolholder for optimal performance.

WMT Modular Toolholders • End Mount • Grooving, Cut-Off, Face Grooving • Metric



Right Hand Tool

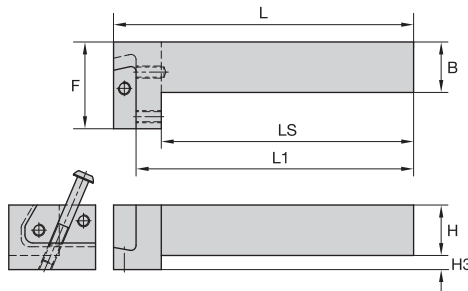

Right Hand Tool

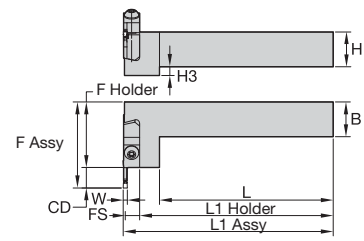

$$F \text{ Assy} = F \text{ (Holder)} + CD \text{ (Blade)}$$

$$L1 \text{ Assy} = L1 \text{ (Holder)} + FS \text{ (Blade)} + W/2$$

order number	catalogue number	H	B	L	L1	LS	F	H3
right hand								
5514979	WGMR2525	25	25	150,3	139,3	125,25	42,75	9
left hand								
5514978	WGME2525	25	25	150,3	139,3	125,25	42,75	9

Toolholder Style	Hand of Holder	Hand of Blade
WGMS — Straight Mount	Right	Right
	Left	Left
WGME — End Mount	Right	Left
	Left	Right



Grooving and Cut-Off Blades
found on page E38



Face Grooving Blades
found on page E39

WMT • Face Grooving • Metric

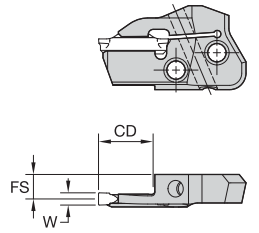
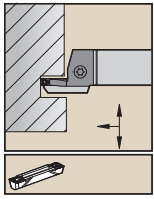

Right Hand Tool

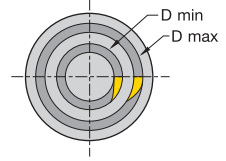

order number	catalogue number	SSC	D min	D max	CD	W	FS
right hand							
5359150	WMTWGMR313B038-052	3	38,00	52,00	12,70	3,00	11,00
5359151	WMTWGMR316B052-070	3	52,00	70,00	15,88	3,00	11,00
5359152	WMTWGMR316B070-100	3	70,00	100,00	15,88	3,00	11,00
5359153	WMTWGMR319B100-205	3	100,00	205,00	19,05	3,00	11,00
5359154	WMTWGMR416B052-070	4	52,00	70,00	15,88	4,00	10,50
5359155	WMTWGMR416B070-100	4	70,00	100,00	15,88	4,00	10,50
5359156	WMTWGMR419B100-205	4	100,00	205,00	19,05	4,00	10,50
5359157	WMTWGMR522B100-205	5	100,00	205,00	22,00	5,00	10,00
5359158	WMTWGMR622B100-205	6	100,00	205,00	22,00	6,00	10,00
left hand							
5359134	WMTWGML313B038-052	3	38,00	52,00	12,70	3,00	11,00
5359135	WMTWGML316B052-070	3	52,00	70,00	15,88	3,00	11,00
5359136	WMTWGML316B070-100	3	70,00	100,00	15,88	3,00	11,00
5359137	WMTWGML319B100-205	3	100,00	205,00	19,05	3,00	11,00
5359138	WMTWGML413B038-052	4	38,00	52,00	12,70	4,00	10,50
5359139	WMTWGML416B052-070	4	52,00	70,00	15,88	4,00	10,50
5359141	WMTWGML419B100-205	4	100,00	205,00	19,05	4,00	10,50
5359142	WMTWGML516B038-052	5	38,00	52,00	15,88	5,00	10,00
5359143	WMTWGML519B052-070	5	52,00	70,00	19,05	5,00	10,00
5359144	WMTWGML519B070-100	5	70,00	100,00	19,05	5,00	10,00
5359145	WMTWGML522B100-205	5	100,00	205,00	22,00	5,00	10,00
5359147	WMTWGML619B052-070	6	52,00	70,00	19,05	6,00	10,00
5359148	WMTWGML619B070-100	6	70,00	100,00	19,05	6,00	10,00
5359149	WMTWGML622B100-205	6	100,00	205,00	22,00	6,00	10,00

NOTE: Blade and clamp screw torque equals 8–10 Nm.

Toolholder Style	Hand of Holder	Hand of Blade
WGMS – Straight Mount	Right	Right
	Left	Left
WGME – End Mount	Right	Left
	Left	Right

WMT Grooving and Cut-Off • Metric

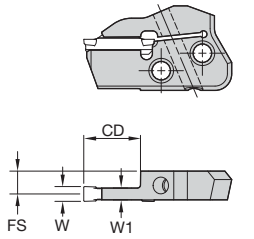
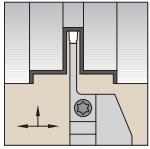

Right Hand Blade



order number	catalogue number	SSC	CD	W	FS	W1
right hand						
5359127	WMTWGMR114S	1	14,00	1,50	11,04	1,22
5359128	WMTWGMR213S	2	13,00	2,00	10,81	1,68
5359129	WMTWGMR2B16S	2B	16,50	2,39	10,71	1,88
5359130	WMTWGMR319S	3	19,00	3,00	10,38	2,54
5359131	WMTWGMR419S	4	19,00	4,00	10,00	3,30
5359132	WMTWGMR522S	5	22,00	5,00	9,82	3,66
5359133	WMTWGMR622S	6	22,00	6,00	9,26	4,78
left hand						
5359121	WMTWGML213S	2	13,00	2,00	10,81	1,68
5359122	WMTWGML2B16S	2B	16,50	2,39	10,71	1,88
5359123	WMTWGML319S	3	19,00	3,00	10,38	2,54
5359124	WMTWGML419S	4	19,00	4,00	10,00	3,30
5359125	WMTWGML522S	5	22,00	5,00	9,82	3,66
5359126	WMTWGML622S	6	22,00	6,00	9,26	4,78

NOTE: Blade and clamp screw torque equals 8–10 Nm (71–88 in. lbs.).
SSC = Pocket Seat Reference. To correspond with the SSC on the toolholder.

Toolholder Style	Hand of Holder	Hand of Blade
WGMS – Straight Mount	Right	Right
	Left	Left
WGME – End Mount	Right	Left
	Left	Right

WMT Modular Toolholders • End Mount • Grooving, Cut-Off, Face Grooving • Inch

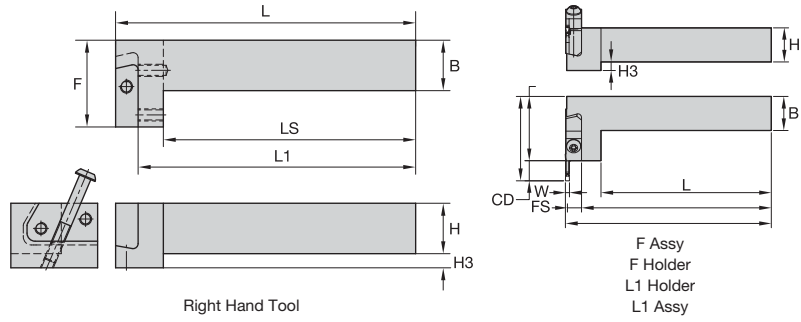

order number	catalogue number	H	B	L	L1	LS	F	H3
right hand								
5514977	WGMR16	1.00	1.00	5.96	5.53	4.96	1.70	.24
5515022	WGMR2050	1.25	1.25	5.96	5.53	4.96	1.70	—
left hand								
5514976	WGML16	1.00	1.00	5.96	5.53	4.96	1.70	.24
5515023	WGML2050	1.25	1.25	5.96	5.53	4.96	1.70	—

INDEXABLE MILLING

SOLID END MILLING

HOLEMAKING

TAPPING

TURNING

The WIDIA™ TopGroove clamping system is perfect for shallow grooving operations and features an extensive carbide grade selection to meet the most demanding application requirements. With maximum clamping rigidity and superior versatility, TopGroove inserts employ a unique top rake chip control geometry that efficiently evacuates chips and produces better quality parts.

- TopGroove clamping design features a rugged bridge clamp, which locates in a groove molded into the insert, to provide superior resistance to side and radial cutting forces.
- TopGroove inserts are available for shallow grooving, deep grooving, light turning, profiling, shallow and deep face grooving, back turning, undercutting, and Poly-Vee grooving.
- The proprietary WIDIA chip control design works in multidirectional turning as well as radial feed applications to provide excellent chip evacuation in deep grooving applications.

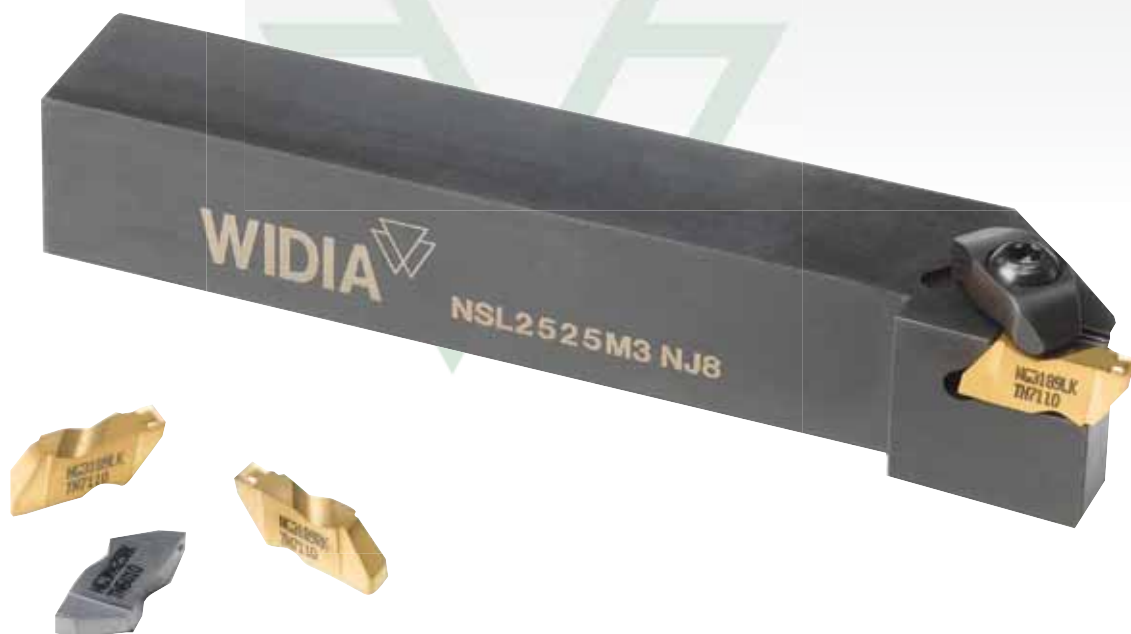

RIGID



















Inserts feature a top rake chip control geometry for maximum clamping rigidity.

VERSATILE

The TopGroove clamping system provides a complete line of grooving geometries and an extensive grade selection to meet even the most demanding application requirements.

SHALLOW GROOVING CLAMPING SYSTEM

INSERTS

INSERT STYLE	APPLICATION	RAKE ANGLE	INSERT STYLE	APPLICATION	RAKE ANGLE
NG 	<ul style="list-style-type: none"> General-purpose grooving. O-ring grooving. Circlip grooving. 	Neutral	NFD-KI* 	<ul style="list-style-type: none"> Internal deep face grooving with chip control. For use in boring bars for internal face grooves. 	10° positive
NG-K 	<ul style="list-style-type: none"> Chip control geometry. General-purpose grooving. O-ring grooving. Circlip grooving. Light turning. 	10° positive	NP-K 	<ul style="list-style-type: none"> Turning. Back turning positive. Profiling with chip control. 	10° positive
NGC-K* 	<ul style="list-style-type: none"> Combined groove and chamfered edge break in one positive plunge with chip control. Designed for DIN 471/472 standard circlip grooves. 	10° positive	NR 	<ul style="list-style-type: none"> Full radius grooving. Turning and profiling. 	Neutral
NGD* 	<ul style="list-style-type: none"> Deep grooving. 	Neutral	NR-K 	<ul style="list-style-type: none"> Chip control geometry. Full radius grooving, turning, and profiling. 	10° positive
NGD-K 	<ul style="list-style-type: none"> Chip control geometry. Deep grooving. Light turning. 	10° positive	NRD 	<ul style="list-style-type: none"> Deep grooving. Full radius end-form. 	Neutral
NGP 	<ul style="list-style-type: none"> General-purpose grooving. O-ring grooving. Circlip grooving. 	5° positive	NRP* 	<ul style="list-style-type: none"> Full radius grooving. Light-turning profiling. 	5° positive
NF* 	<ul style="list-style-type: none"> Face grooving. Additional side clearance. 	Neutral	NU* 	<ul style="list-style-type: none"> Undercutting. 	Neutral
NF-K 	<ul style="list-style-type: none"> Face grooving with chip control. Additional side clearance. 	10° positive	NV* 	<ul style="list-style-type: none"> Poly-Vee grooving. 	Neutral
NFD-K 	<ul style="list-style-type: none"> Deep face grooving with chip control. Additional side clearance. 	10° positive	NB/NBD 	<ul style="list-style-type: none"> Blanks. Blanks for deep grooving. Available in uncoated grades only. 	—

*Inserts are available as custom solutions.

INDUSTRY



APPLICATIONS

FACE
GROOVING

GROOVING

I.D.
GROOVING

Choosing the Correct TopGroove Cutter

The Most Advanced Turning Solutions in the Industry

Perfect for shallow grooving operations, the WIDIA™ TopGroove clamping system provides a complete line of grooving geometries and an extensive grade selection to meet even the most demanding application requirements. For increased rigidity, versatility, chip control, and carbide grade options, the TopGroove clamping system is the proven solution.

With maximum clamping rigidity and superior versatility, TopGroove inserts employ a unique top rake chip control geometry that efficiently evacuates chips and produces better quality parts, faster than ever before.

Use this comprehensive, easy-to-use guide for the information necessary to identify, choose, and select the appropriate cutting tools for your specific needs.

What you need to know:

- Material being machined.
- Groove depth, width, and profile.
- Application to be performed (face, O.D., or I.D. grooving).
- Toolholder requirements (e.g., KM™, ERICKSON™, square shank, right/left).

1 Choose the application to be performed:

Groove depth, width, and profile.

TopGroove is the best choice for groove depth-to-width ratios of 1.5 or less.

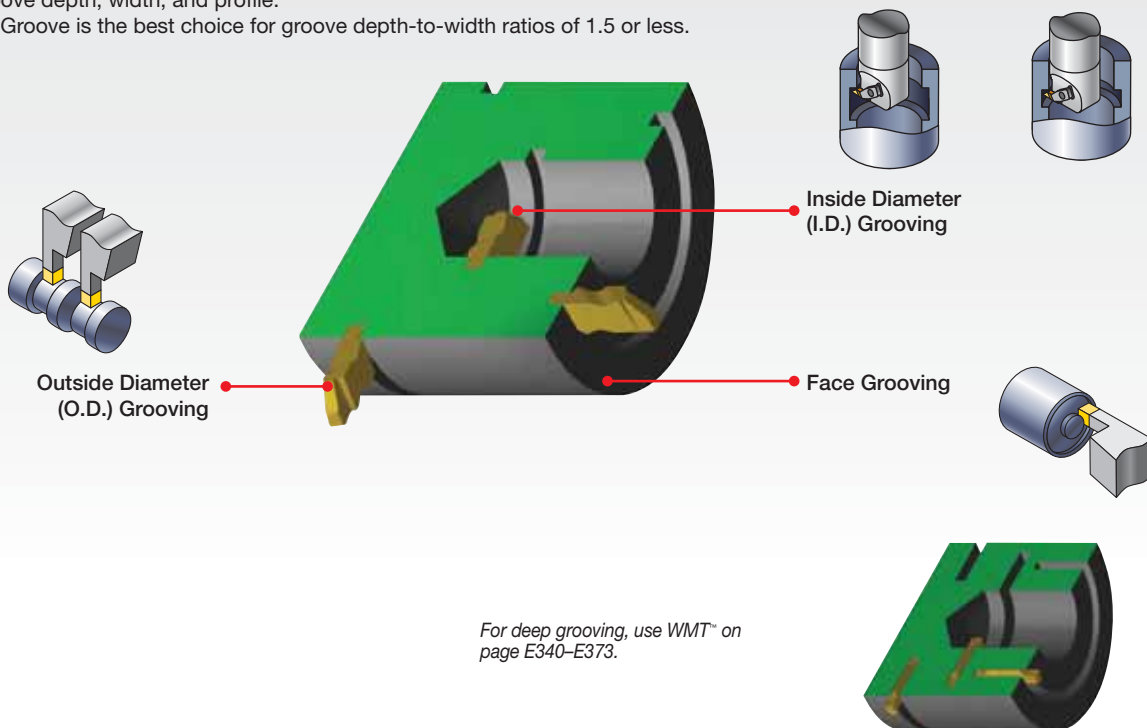

TopGroove for Internal, External, and Face Grooving Applications

system capabilities		minimum	maximum	
	O.D./I.D. Grooving	width	0,50mm	9,53mm
		depth	—	12,7mm
	Face Grooving	width	3,2mm	6,35mm
		depth	—	12,7mm
	Internal Grooving	diameter	11,2mm	—
	Face Grooving Diameter	standard	23,9mm	—
		deep	—	—
	Deep O.D./I.D. Grooving	width	1,50mm	6,35mm
		depth	—	12,7mm
	Deep Face Grooving	width	3,18mm	6,35mm
		depth	—	12,7mm

Choosing the Correct TopGroove Cutter

2 Identify the material to be machined:

Each tool has a material grid marked with a letter indicating the materials that can be machined.

P	Steel
M	Stainless Steel
K	Cast Iron
N	Non-Ferrous
S	High-Temp Alloys
H	Hardened Materials

3 Select your toolholder based on the application:

- A** Choose the appropriate gage insert (width) required for the application.
- B** Choose the shortest cutting depth "CD" dimension for increased tool rigidity.
- C** Select the largest toolholder shank "H" and "B" dimensions for maximum rigidity.

Grooving and Cut-Off • TopGroove™

Integral Toolholders • NS • Metric

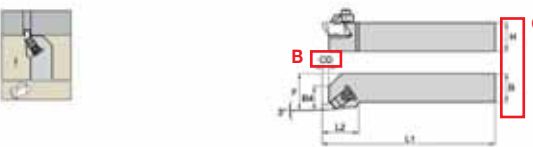

order number	catalog number	H	B	F	L1	L2	R4	CD	gage insert
3641880	NSR1212F2	12.0	12.0	16.0	80	15	9	A	N.28
3630542	NSR1616H2	16.0	16.0	20.0	100	18	9	A	N.28
3630588	NSR2020K2	20.0	20.0	25.0	125	18	9	A	N.30
3630686	NSR2525K3	25.0	25.0	25.0	150	20	10	A	N.30
3630990	NSR2525M2	25.0	25.0	32.0	150	18	9	A	N.30
3630536	NSR2525M3	25.0	25.0	32.0	150	20	10	D	N.30
3630540	NSR2525M4	25.0	25.0	32.0	150	20	14	F	N.40
3641668	NSR3232P3	32.0	32.0	40.0	175	22	10	B	N.30
3641669	NSR3232P4	32.0	32.0	40.0	175	22	14	F	N.40
3639643	NSL2020K2	20.0	20.0	25.0	125	18	9	A	N.21
3639648	NSL2020K3	20.0	20.0	25.0	125	20	10	B	N.21
3639647	NSL2525M2	25.0	25.0	32.0	150	18	9	A	N.21
3630539	NSL2525M3	25.0	25.0	32.0	150	20	10	D	N.21
3630544	NSL2525M4	25.0	25.0	32.0	150	20	14	F	N.21

NOTE: F dimension measured over sharp point of insert.

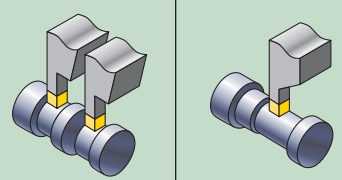
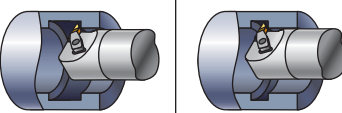
		application	conventional toolholders	modular blades
		O.D. Grooving and Plunge and Turn	E364–E366	E372
		I.D. Grooving	E369	—

Choosing the Correct TopGroove Cutter

4 Select chipbreaker style for the application:

See application guide on page E382 for a complete list of insert styles.

NOTE: Chart shows recommended starting feed rates.

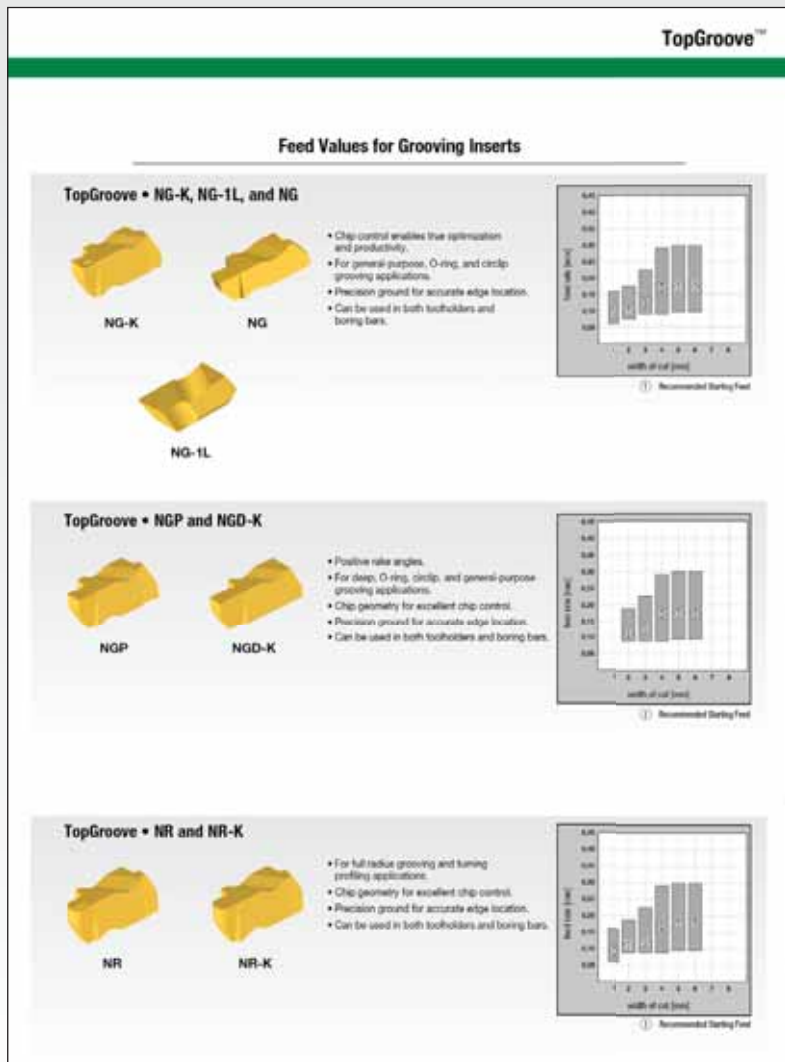

- A Choose the appropriate insert width “W” for your specific application.
- B Select the required corner radius value “RR”.

Grooving and Cut-Off • TopGroove™

Grooving and Turning Inserts • NG • Grooving • Neutral

right hand	catalogue number	SSC	W	RR	T	TH004.0	TH005.0	TH006.0	TH007.0
	NG203R	2	0.79	0.25	1.27				
	NG204R	2	1.54	0.25	1.27				

Legend: ● first choice, ○ alternate choice

Choosing the Correct TopGroove Cutter

5 Select grade:

cutting condition		Recommended Grades					
		steel	stainless steel	cast iron	non-ferrous metals	high-temp alloys	hardened materials
smooth cut, pre-turned surface		TN7110	TN6010	TN7110	TN6010/THM	TN6010	TN6010
varying depth of cut, casting, or forging skin		TN6010	TN6010	TN6010	TN6010/THM	TN6010	TN6010
lightly interrupted cut		TN6025	TN6025	TN6025	TN6010/THM	TN6010	TN6025
heavily interrupted cut		TN6025	TN6025	TN6025	TN6010/THM	TN6010	TN6025

See page E347 for Grades and Grade Descriptions.

6 Determine cutting data:

- A Based on material group and grade, identify starting speed (vc).
- B First choice starting speed is in bold.

See page E384 for cutting data.

TopGroove™

Recommended Cutting Speeds • Metric

Material Group		Cutting Speed – vc m/min								
		TN6010			TN6025			THM		
		min	Start	max	min	Start	max	min	Start	max
S/1	1	140	175	210	130	140	150	90	95	100
	2	115	140	175	110	140	175	75	100	125
	3	115	140	175	110	140	175	75	100	125
	4	75	100	120	75	85	115	55	65	80
M	1	105	140	170	100	128	145	70	88	100
	2	85	95	110	80	95	110	55	65	75
	3	65	85	105	60	80	100	45	55	65
	4	45	60	75	40	55	65	30	40	45
K	1	90	118	140	80	78	90	60	75	90
	2	55	70	90	40	60	50	30	40	70
	3	65	85	95	40	50	60	40	50	55
	4	170	150	160	60	60	90	70	90	100
H	1	120	150	180	60	75	85	50	65	80
	2	110	140	170	60	78	90	65	75	80
	3	110	140	170	60	78	90	65	75	80
	4	600	730	900	600	730	900	600	730	900
G	1	525	685	835	525	685	835	500	650	800
	2	230	300	370	200	300	370	100	150	200
	3	135	180	225	130	160	200	50	60	80
	4	70	90	110	70	90	110	25	30	37
F	1	445	565	690	445	565	690	150	200	250
	2	550	700	850	550	700	850	150	200	250
	3	35	45	50	25	35	40	25	35	45
	4	20	25	30	15	20	25	10	15	20
D	1	60	75	90	40	60	70	15	25	30
	2	30	35	45	20	30	35	10	15	20
	3	15	20	30	15	20	30	10	15	20
	4	15	20	30	15	20	30	10	15	20

Catalog Numbering System

Each character in our catalog number signifies a specific trait of that product. Use the following key columns and corresponding images to easily identify which attributes apply.

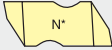
N	G	D	2	M	150	R		K																
Type of Insert	Insert Style	Additional Information	Insert Size	Size Identification	Groove Size**	Hand of Insert	Cutting Depth	Chipbreaker Design	Definition of Inserts															
<p>N – TopGroove</p> 	<p>D – Deep grooving</p> <p>P – Positive</p> <p>C – Groove and chamfer</p>	<p>D – Deep grooving</p> <p>P – Positive</p> <p>C – Groove and chamfer</p>	<p>2 – Metric insert groove width</p> <p>C – Circlip groove insert width is nominal circlip size</p> <p>Blank – Indicates inch width insert</p>	<p>M – Metric insert groove width</p> <p>C – Circlip groove insert width is nominal circlip size</p> <p>Blank – Indicates inch width insert</p>	<p>150 – Groove size</p>	<p>L – Left hand</p> <p>R – Right hand</p>	<p>Shown for groove and chamfer inserts in 0,01mm increments.</p>	<p>K – Standard chip control</p> <p>E – Hone only</p>	<p>Groove size</p> <p>J or L – Poly-Vee inserts</p> <p>I – Internal face grooving</p>															
	<p>B – Blank (for special forms)</p> <p>F – Face grooving</p> <p>G – Grooving</p> <p>P – Back turning</p> <p>R – Full radius</p> <p>U – Undercutting (or relieving)</p> <p>V – Poly-Vee</p>		<table border="1"> <thead> <tr> <th>insert number</th> <th>W1 mm</th> </tr> </thead> <tbody> <tr> <td>1</td> <td>2,54</td> </tr> <tr> <td>2</td> <td>3,81</td> </tr> <tr> <td>3</td> <td>4,95</td> </tr> <tr> <td>4</td> <td>6,98</td> </tr> <tr> <td>5</td> <td>9,65</td> </tr> <tr> <td>6</td> <td>9,73</td> </tr> </tbody> </table>	insert number	W1 mm	1	2,54	2	3,81	3	4,95	4	6,98	5	9,65	6	9,73						<p>Position pertains to groove width for F-, G-, and U-style inserts, radii for R-style grooving inserts, and circlip size for groove and chamfer inserts. Dimension in 0,01mm.</p> <p>Metric example: 3,25mm width groove or radius equals "325" catalog position number.</p> <p>Width Tolerance: ±0,025mm unless otherwise specified.</p>	
insert number	W1 mm																							
1	2,54																							
2	3,81																							
3	4,95																							
4	6,98																							
5	9,65																							
6	9,73																							

**Omit position for TopGroove NB-style blanks.

TopGroove/TopThread Threading and Grooving Insert Dimensions

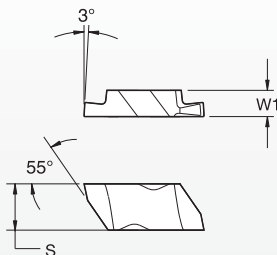

insert size	S		W1	
	mm	inch	mm	Inch
1	2,54	.100	2,54	.100
2	5,56	.219	3,81	.150
3	8,74	.344	4,95	.195
4	11,51	.453	6,48	.255
5	17,48	.688	9,65	.380
6	11,51	.453	9,73	.383
8	7,93	.312	11,13	.438

TopGroove/TopThread Holder Design

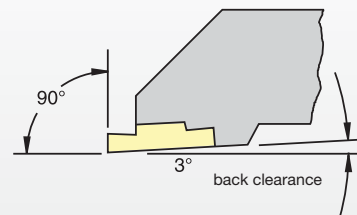

NOTE: Holders are designed to locate insert inclined to 3° to provide back clearance down open side.

WIDIA™ TopGroove and TopThread™ tooling technology combine to bring you the very best threading and grooving system available in the world today.

Grades and Grade Descriptions

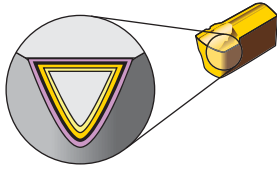

Coatings provide high-speed capability and are engineered for finishing to heavy roughing.

P	Steel
M	Stainless Steel
K	Cast Iron
N	Non-Ferrous
S	High-Temp Alloys
H	Hardened Materials

Grade	Coating	Grade Description	wear resistance ← → toughness																				
				05	10	15	20	25	30	35	40	45											
TN6010	HC-S10	An advanced PVD TiAlN coating over a very deformation-resistant unalloyed carbide substrate. TN6010 is ideal for finishing to general machining of most workpiece materials at higher speeds. Excellent for machining most steels, stainless steels, cast irons, non-ferrous materials, and super alloys under stable conditions. It also performs well machining hardened and short chipping materials.	P																				
			M																				
			K																				
			N																				
			S																				
			H																				
TN6025	HC-S25	An advanced PVD TiAlN-coated grade with a tough, ultra-fine-grain unalloyed substrate. For general-purpose machining of most steels, stainless steels, high-temp alloys, titanium, irons, and non-ferrous materials. Speeds may vary from low to medium and will handle interruptions and high feed rates.	P																				
			M																				
			K																				
			N																				
			S																				
			H																				
THM	HW-K15	Uncoated carbide. Extraordinarily good balance of hardness, wear resistance, edge stability, and toughness. Light and medium machining. For cast iron and all non-ferrous metals and non-metals. Useful in unfavorable conditions.	P																				
			M																				
			K																				
			N																				
			S																				
			H																				

INDEXABLE MILLING

SOLID END MILLING

HOLEMAKING

TAPPING

TURNING

Application Guide

insert style	application	rake angle	page(s)	insert style	application	rake angle	page(s)
NG 	<ul style="list-style-type: none"> General-purpose grooving. O-ring grooving. Circlip grooving. 	neutral	E386–E388	NFD-KI* 	<ul style="list-style-type: none"> Internal deep face grooving with chip control. For use in boring bars for internal face grooves. 	10° positive	—
NG-K 	<ul style="list-style-type: none"> Chip control geometry. General-purpose grooving. O-ring grooving. Circlip grooving. Light turning. 	10° positive	E389–E397	NP-K 	<ul style="list-style-type: none"> Turning. Back turning positive. Profiling with chip control. 	10° positive	E404
NGC-K* 	<ul style="list-style-type: none"> Combined groove and chamfered edge break in one positive plunge with chip control. Designed for DIN 471/472 standard circlip grooves. 	10° positive	—	NR 	<ul style="list-style-type: none"> Full radius grooving. Turning and profiling. 	neutral	E405–E408
NGD* 	<ul style="list-style-type: none"> Deep grooving. 	neutral	—	NR-K 	<ul style="list-style-type: none"> Chip control geometry. Full radius grooving, turning, and profiling. 	10° positive	E409
NGD-K 	<ul style="list-style-type: none"> Chip control geometry. Deep grooving. Light turning. 	10° positive	E398–E400	NRD 	<ul style="list-style-type: none"> Deep grooving. Full radius end-form. 	neutral	E410
NGP 	<ul style="list-style-type: none"> General-purpose grooving. O-ring grooving. Circlip grooving. 	5° positive	E401	NRP* 	<ul style="list-style-type: none"> Full radius grooving. Light-turning profiling. 	5° positive	—
NF* 	<ul style="list-style-type: none"> Face grooving. Additional side clearance. 	neutral	—	NU* 	<ul style="list-style-type: none"> Undercutting. 	neutral	—
NF-K 	<ul style="list-style-type: none"> Face grooving with chip control. Additional side clearance. 	10° positive	E402	NV* 	<ul style="list-style-type: none"> Poly-Vee grooving. 	neutral	—
NFD-K 	<ul style="list-style-type: none"> Deep face grooving with chip control. Additional side clearance. 	10° positive	E403	NB/NBD 	<ul style="list-style-type: none"> Blanks. Blanks for deep grooving. Available in uncoated grades only. 	—	E385

*Inserts are available as custom solutions.

Feed Values for Grooving Inserts

TopGroove • NG-K, NG-1L, and NG



NG-K

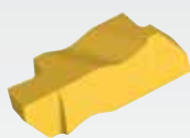

NG

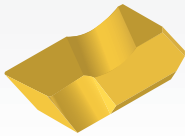

NG-1L

- Chip control enables true optimization and productivity.
- For general-purpose, O-ring, and circlip grooving applications.
- Precision ground for accurate edge location.
- Can be used in both toolholders and boring bars.

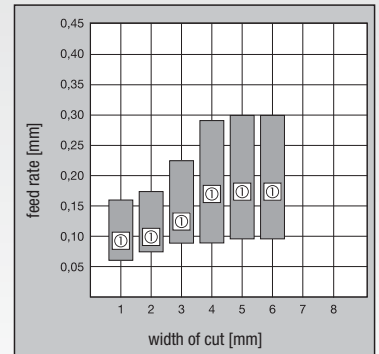

① Recommended Starting Feed

TopGroove • NGP and NGD-K

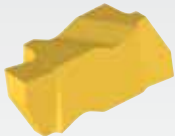

NGP

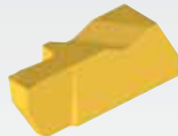

NGD-K

- Positive rake angles.
- For deep, O-ring, circlip, and general-purpose grooving applications.
- Chip geometry for excellent chip control.
- Precision ground for accurate edge location.
- Can be used in both toolholders and boring bars.

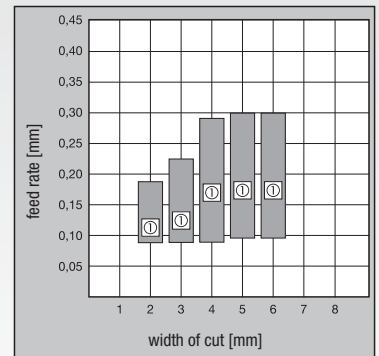

① Recommended Starting Feed

TopGroove • NR and NR-K

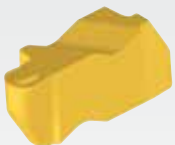

NR

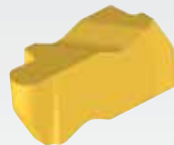

NR-K

- For full radius grooving and turning profiling applications.
- Chip geometry for excellent chip control.
- Precision ground for accurate edge location.
- Can be used in both toolholders and boring bars.

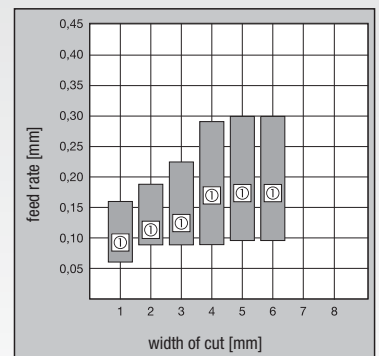

① Recommended Starting Feed

Recommended Cutting Speeds • Metric

Material Group		Cutting Speed – vc m/min								
		TN6010			TN6025			THM		
		min	Start	max	min	Start	max	min	Start	max
P	0/1	140	175	210	130	140	150	90	95	100
	2	115	145	175	110	145	175	75	100	125
	3	115	145	175	110	145	175	75	100	125
	4	75	100	120	75	95	115	55	65	80
	5	105	140	170	100	125	145	70	85	100
	6	45	60	75	40	55	65	30	40	45
M	1	90	115	140	60	75	90	60	75	90
	2	55	70	90	40	50	55	50	60	75
	3	60	80	95	40	50	60	40	50	55
K	1	120	150	180	60	80	90	70	90	100
	2	120	150	180	60	75	85	50	65	80
	3	110	140	170	60	75	90	60	70	80
N	1	600	750	900	600	750	900	600	750	900
	2	535	685	835	535	685	835	500	650	800
	3	230	300	370	230	300	370	600	750	900
	4	135	180	225	135	180	225	500	650	800
	5	70	90	110	70	90	110	230	300	370
	6	445	565	690	445	565	690	150	200	250
	7	550	700	850	550	700	850	150	200	250
S	1	35	40	50	25	35	40	25	35	45
	2	20	20	30	15	20	20	20	30	35
	3	60	70	80	40	60	70	15	25	30
	4	30	35	45	20	30	35	10	15	20
H	1	15	30	60	15	30	60	10	20	35
	2	15	30	60	15	30	60	10	20	35
	3	15	30	60	15	30	60	10	20	35
	4	15	30	60	15	30	60	10	20	35

Grooving and Turning Inserts • NB • Blanks

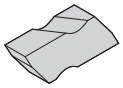

Right-hand insert shown; left-hand insert is mirror image.

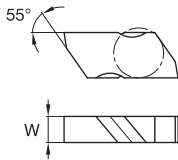

- first choice
- alternate choice

P	●	●	●	○
M	●	●	●	○
K	●	○	○	○
N	●	○	○	○
S	●	●	●	○
H	○	○	○	○

	catalogue number	SSC	W	TN6010	TN6025	THM
right hand	NB2R	2	3,84	●	●	3607064
left hand	NB2L	2	3,84	○	○	3607016
	NB3L	3	4,95	○	○	3607017

INDEXABLE MILLING

SOLID END MILLING

HOLE/MAKING

TAPPING

TURNING

Grooving and Turning Inserts • NG • Grooving • Neutral

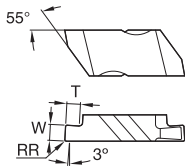
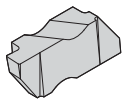

- first choice
- alternate choice

P	●	●	●	●	●
M	●	●	●	●	●
K	●	○	○	○	○
N	●	○	○	○	○
S	●	●	●	●	●
H	○	○	○	○	○

catalogue number	SSC	W	RR	T	TN6010	TN6025	THM
right hand							
NG2031R	2	0,79	0,09	1,27	● 3607153	○ 3607495	○
NG2041R	2	1,04	0,09	1,27	○	● 3607330	○
NG2058R	2	1,47	0,19	1,27	○	● 3607450	○
NG2062R	2	1,58	0,19	2,79	● 3607167	● 3607453	○
NG3047R	3	1,19	0,19	1,91	● 3607157	● 3607416	○
NG3062R	3	1,58	0,19	2,39	● 3607109	● 3607403	○ 3607014
NG3094R	3	2,39	0,19	3,81	● 3607137	● 3607406	○ 3607018
NG3125R	3	3,18	0,19	3,81	● 3607110	● 3607375	○ 3607020
NG4250R	4	6,35	0,57	6,35	○	● 3607382	○
left hand							
NG2031L	2	0,79	0,09	1,27	○	● 3607482	○
NG2058L	2	1,47	0,19	1,27	○	● 3607498	○
NG2062L	2	1,58	0,19	2,79	○	● 3607481	○
NG3047L	3	1,19	0,19	1,91	● 3607179	● 3607501	○
NG3062L	3	1,57	0,19	2,38	● 3607158	● 3607459	○

INDEXABLE MILLING

SOLID END MILLING

HOLEMAKING

TAPPING

TURNING

Grooving and Turning Inserts • NG • Grooving • Neutral

(continued)

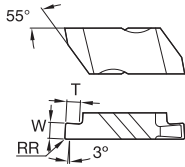
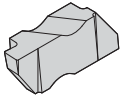

- first choice
- alternate choice

P	●	●	●	○
M	●	●	●	○
K	●	○	○	●
N	●	○	○	○
S	●	●	●	○
H	○	○	○	○

catalogue number	SSC	W	RR	T	TN6010	TN6025	THM
NG3094L	3	2,39	0,19	3,81	3607160	3607323	—
NG3125L	3	3,18	0,19	3,81	3607152	3607445	—
NG4250L	4	6,35	0,57	6,35	—	3607513	—

NOTE: SSC = To correspond with the SSC on the toolholder.

INDEXABLE MILLING

SOLID END MILLING

HOLEMAKING

TAPPING

TURNING

Grooving and Turning Inserts • NG-1L • Grooving

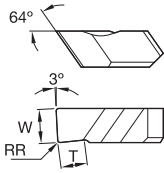
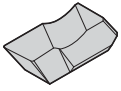

- first choice
- alternate choice

P	●	●	●	○
M	●	●	●	○
K	●	○	○	●
N	●	○	○	○
S	●	●	●	○
H	○	○	○	○

catalogue number	SSC	W	RR	T	cutting edges	TN6010	TN6025	THM
left hand								
NG1047L	1	1,19	0,19	1,91	1	●	○	○
NG1062L	1	1,58	0,19	1,91	1	●	○	○
NG1094L	1	2,39	0,19	1,91	1	●	○	○

NOTE: SSC = To correspond with the SSC on the toolholder.
Width tolerance is +/- .003" (+/- 0,076mm) on NG-1L inserts.

INDEXABLE MILLING

SOLID END MILLING

HOLEMAKING

TAPPING

TURNING

Grooving and Turning Inserts • NG-K • Grooving with Chip Breaker

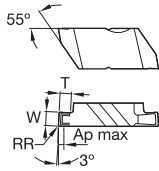
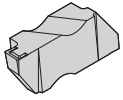

- first choice
- alternate choice

P	●	●	●	●
M	●	●	●	○
K	●	○	○	●
N	●	○	○	○
S	●	●	●	○
H	○	○	○	○

catalogue number	SSC	W	Ap max	RR	T	TN6010	TN6025	THM
right hand								
NG2M050RK	2	0,50	0,64	0,09	0,64	3606991	3607394	●
NG2031RK	2	0,79	0,76	0,09	1,27	3607090	3607313	●
NG2M080RK	2	0,80	0,76	0,09	1,27	3606903	3607291	●
NG2M100RK	2	1,00	0,76	0,09	1,28	3607129	3607218	●
NG2M120RK	2	1,20	0,76	0,09	1,27	3606679	3607299	●
NG2047RK	2	1,19	0,76	0,09	1,27	3607123	3607404	●
NG2M140RK	2	1,40	0,76	0,09	1,28	3607151	3607318	●
NG2M150RK	2	1,50	1,09	0,19	2,81	●	3607234	●
NG2062RK	2	1,56	1,09	0,19	2,79	3607089	3607215	●
NG2M170RK	2	1,70	1,09	0,19	2,81	●	3607242	●
NG2M175RK	2	1,75	1,09	0,19	2,81	●	3607379	●

INDEXABLE MILLING

SOLID END MILLING

HOLEMAKING

TAPPING

TURNING

Grooving and Turning Inserts • NG-K • Grooving with Chip Breaker

(continued)

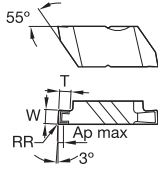
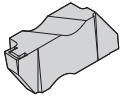

- first choice
- alternate choice

P	●	●	●	●	●
M	●	●	●	●	●
K	●	○	○	○	○
N	●	○	○	○	○
S	●	○	○	○	○
H	○	○	○	○	○

catalogue number	SSC	W	Ap max	RR	T	TN6010	TN6025	THM
NG2M195RK	2	1,95	1,09	0,19	2,81	3606829	3607417	●
NG2M200RK	2	2,00	1,09	0,19	2,81	3607100	3607071	○
NG2M220RK	2	2,20	1,09	0,19	2,81	-	3607521	○
NG2M225RK	2	2,25	1,09	0,19	2,81	3606828	3607411	○
NG2094RK	2	2,39	1,09	0,19	2,79	3607146	3607317	○
NG2M250RK	2	2,50	1,09	0,19	2,81	-	3607324	○
NG2M275RK	2	2,75	1,09	0,19	2,81	3606916	3607409	○
NG2M300RK	2	3,00	1,09	0,19	2,81	3606676	3607340	○
NG2125RK	2	3,18	1,09	0,19	2,79	3607155	3607381	○
NG2M325RK	2	3,25	1,09	0,19	2,79	-	3607533	○
NG3M100RK	3	1,00	0,76	0,20	1,91	-	3607219	○
NG3M120RK	3	1,20	0,76	0,19	1,91	-	3607412	○

INDEXABLE MILLING

SOLID END MILLING

HOLEMAKING

TAPPING

TURNING

Grooving and Turning Inserts • NG-K • Grooving with Chip Breaker

(continued)

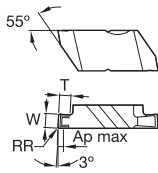
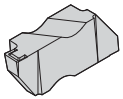

- first choice
- alternate choice

P	●	●	●	●
M	●	●	●	○
K	●	○	○	●
N	●	○	○	○
S	●	●	●	○
H	○	○	○	○

catalogue number	SSC	W	Ap max	RR	T	TN6010	TN6025	THM
NG3047RK	3	1,19	0,76	0,19	1,91	3607084	3607238	●
NG3M150RK	3	1,50	1,02	0,19	2,39	3607221	3607238	○
NG3062RK	3	1,57	1,02	0,19	2,39	3607055	3607070	○
NG3M175RK	3	1,75	1,02	0,19	2,39	3607418	3607238	○
NG3072RK	3	1,83	1,02	0,19	2,39	3607332	3607332	○
NG3078RK	3	1,98	1,02	0,19	2,39	3607111	3607309	○
NG3M200RK	3	2,00	1,02	0,19	2,39	3607208	3607208	○
NG3M220RK	3	2,20	1,02	0,19	2,39	3607336	3607336	○
NG3M225RK	3	2,24	1,02	0,19	2,39	3606674	3607310	○
NG3094RK	3	2,39	1,02	0,19	3,81	3606660	3607069	○
NG3M250RK	3	2,50	1,02	0,19	3,81	3607217	3607217	○
NG3M275RK	3	2,75	1,02	0,19	3,81	3606677	3607337	○

INDEXABLE MILLING

SOLID END MILLING

HOLEMAKING

TAPPING

TURNING

Grooving and Turning Inserts • NG-K • Grooving with Chip Breaker

(continued)

- first choice
- alternate choice

P	●	●	●	●
M	●	●	●	○
K	●	○	○	●
N	●	○	○	○
S	●	●	●	○
H	○	○	○	○

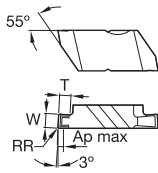
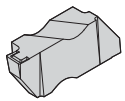

catalogue number	SSC	W	Ap max	RR	T	TN6010	TN6025	THM
NG3M300RK	3	3,00	1,02	0,19	3,81	●	●	○
NG3125RK	3	3,18	1,02	0,19	3,81	○	○	○
NG3M320RK	3	3,20	1,02	0,19	3,81	○	○	○
NG3M350RK	3	3,50	2,92	0,32	3,81	○	○	○
NG3156RK	3	3,96	2,92	0,19	3,81	○	○	○
NG3M400RK	3	4,00	2,92	0,32	3,81	○	○	○
NG3M425RK	3	4,25	2,92	0,32	3,81	○	○	○
NG3M450RK	3	4,50	2,92	0,32	3,81	○	○	○
NG3189RK	3	4,80	2,92	0,57	3,81	○	○	○
NG4M300RK	4	3,00	1,02	0,19	3,81	○	○	○
NG4125RK	4	3,18	1,06	0,19	3,81	○	○	○
NG4M350RK	4	3,50	2,92	0,57	6,35	○	○	○

INDEXABLE MILLING

SOLID END MILLING

HOLEMAKING

TAPPING

TURNING

Grooving and Turning Inserts • NG-K • Grooving with Chip Breaker

(continued)

- first choice
- alternate choice

P	●	●	●	●	●
M	●	●	●	●	○
K	●	○	○	○	○
N	●	○	○	○	○
S	●	○	○	○	○
H	○	○	○	○	○

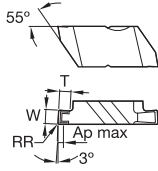
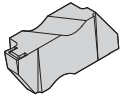

catalogue number	SSC	W	Ap max	RR	T	TN6010	TN6025	THM
NG4M400RK	4	4,00	2,92	0,57	6,35	3606908	●	●
NG4M450RK	4	4,50	2,92	0,57	6,35	3607390	○	○
NG4189RK	4	4,80	2,92	0,57	6,35	3607103	○	○
NG4M550RK	4	5,50	3,81	0,58	6,35	3607383	○	○
NG4250RK	4	6,35	3,81	0,57	6,35	3607304	○	○
left hand								
NG2M050LK	2	0,50	0,64	0,09	0,64	3607112	○	○
NG2031LK	2	0,79	0,76	0,09	1,27	3607443	○	○
NG2M080LK	2	0,80	0,76	0,09	1,27	3606911	○	○
NG2M100LK	2	1,00	0,76	0,09	1,27	3607239	○	○
NG2M120LK	2	1,20	0,76	0,09	1,27	3606827	○	○
NG2047LK	2	1,19	0,76	0,09	1,27	3607376	○	○

INDEXABLE MILLING

SOLID END MILLING

HOLEMAKING

TAPPING

TURNING

Grooving and Turning Inserts • NG-K • Grooving with Chip Breaker

(continued)

- first choice
- alternate choice

P	●	●	●	●
M	●	●	●	○
K	●	○	○	●
N	●	○	○	○
S	●	●	●	○
H	○	○	○	○

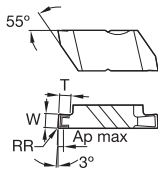
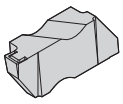

catalogue number	SSC	W	Ap max	RR	T	TN6010	TN6025	THM
NG2M140LK	2	1,40	0,76	0,09	1,27	3606904	3607338	●
NG2M150LK	2	1,50	1,09	0,19	2,79	3607294	3607307	○
NG2062LK	2	1,58	1,09	0,19	2,79	3607126	3607307	○
NG2M170LK	2	1,70	1,09	0,19	2,79	3606905	3607327	○
NG2M175LK	2	1,75	1,09	0,19	2,79	3607420	3607421	○
NG2M195LK	2	1,95	1,09	0,19	2,79	3607420	3607421	○
NG2M200LK	2	2,00	1,09	0,19	2,79	3607144	3607207	○
NG2M220LK	2	2,20	1,09	0,19	2,79	3607367	3607367	○
NG2M225LK	2	2,25	1,09	0,19	2,79	3607149	3607413	○
NG2094LK	2	2,39	1,09	0,19	2,79	3607380	3607413	○
NG2M250LK	2	2,50	1,09	0,19	2,79	3607518	3607518	○
NG2M275LK	2	2,75	1,09	0,19	2,80	3607292	3607518	○

INDEXABLE MILLING

SOLID END MILLING

HOLEMAKING

TAPPING

TURNING

Grooving and Turning Inserts • NG-K • Grooving with Chip Breaker

(continued)

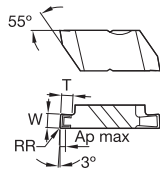
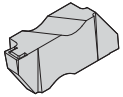

- first choice
- alternate choice

P	●	●	●	●
M	●	●	●	○
K	●	○	○	●
N	●	○	○	○
S	●	●	●	○
H	○	○	○	○

catalogue number	SSC	W	Ap max	RR	T	TN6010	TN6025	THM
NG2M300LK	2	3,00	1,09	0,19	2,80	●	○	○
NG2125LK	2	3,18	1,09	0,19	2,79	○	○	○
NG2M325LK	2	3,25	1,09	0,19	2,79	○	○	○
NG3M100LK	3	1,00	0,76	0,20	1,91	○	○	○
NG3M120LK	3	1,20	0,76	0,19	1,91	○	○	○
NG3047LK	3	1,19	0,76	0,19	1,90	○	○	○
NG3M150LK	3	1,50	1,02	0,19	2,39	○	○	○
NG3062LK	3	1,58	1,02	0,19	2,39	○	○	○
NG3M175LK	3	1,75	1,02	0,19	2,39	○	○	○
NG3072LK	3	1,83	1,02	0,19	2,39	○	○	○
NG3078LK	3	1,98	1,02	0,19	2,39	○	○	○
NG3M200LK	3	2,00	1,02	0,19	2,39	○	○	○

INDEXABLE MILLING

SOLID END MILLING

HOLEMAKING

TAPPING

TURNING

Grooving and Turning Inserts • NG-K • Grooving with Chip Breaker

(continued)

- first choice
- alternate choice

P	●	●	●	●
M	●	●	●	○
K	●	○	○	●
N	●	○	○	○
S	●	●	●	○
H	○	○	○	○

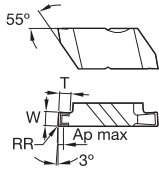
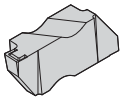

catalogue number	SSC	W	Ap max	RR	T	TN6010	TN6025	THM
NG3M220LK	3	2,20	1,02	0,19	2,39	●	●	○
NG3M225LK	3	2,25	1,02	0,19	2,39	○	○	○
NG3094LK	3	2,39	1,02	0,19	3,81	○	○	○
NG3M250LK	3	2,50	1,02	0,19	3,81	○	○	○
NG3M275LK	3	2,75	1,02	0,19	3,81	○	○	○
NG3M300LK	3	3,00	1,02	0,19	3,81	○	○	○
NG3125LK	3	3,18	1,02	0,19	3,81	○	○	○
NG3M320LK	3	3,20	1,02	0,19	3,81	○	○	○
NG3M325LK	3	3,25	1,02	0,19	3,81	○	○	○
NG3M350LK	3	3,50	2,92	0,32	3,81	○	○	○
NG3156LK	3	3,96	2,92	0,19	3,81	○	○	○
NG3M400LK	3	4,00	2,92	0,32	3,81	○	○	○

INDEXABLE MILLING

SOLID END MILLING

HOLEMAKING

TAPPING

TURNING

Grooving and Turning Inserts • NG-K • Grooving with Chip Breaker

(continued)

- first choice
- alternate choice

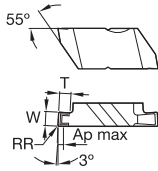
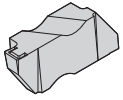

P	●	●	●	●
M	●	●	●	○
K	●	○	○	●
N	●	○	○	○
S	●	●	●	○
H	○	○	○	○

catalogue number	SSC	W	Ap max	RR	T	TN6010	TN6025	THM
NG3M450LK	3	4,50	2,92	0,32	3,81		3607369	
NG3189LK	3	4,80	2,92	0,57	3,81	3607107	3607320	
NG4125LK	4	3,18	1,06	0,19	3,81		3607448	
NG4M400LK	4	4,00	2,92	0,57	6,35		3607363	
NG4189LK	4	4,80	2,92	0,57	6,35	3607140	3607377	
NG4M600LK	4	6,00	3,81	0,57	6,34		3607387	
NG4250LK	4	6,35	3,81	0,57	6,35		3607311	

NOTE: SSC = To correspond with the SSC on the toolholder.

INDEXABLE MILLING

SOLID END MILLING

HOLEMAKING

TAPPING

TURNING

Grooving and Turning Inserts • NGD-K • Deep Grooving with Chip Breaker

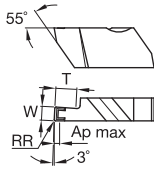
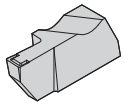

- first choice
- alternate choice

P	●	●	●	●
M	●	●	●	○
K	●	○	○	●
N	●	●	○	○
S	●	●	●	○
H	○	○	○	○

catalogue number	SSC	W	Ap max	RR	T	cutting edges	TN6010	TN6025	THM
right hand									
NGD2M150RK	2	1,50	1,09	0,19	4,06	1	●	○	○
NGD2M200RK	2	2,00	1,09	0,19	5,08	1	○	○	○
NGD2M250RK	2	2,50	1,09	0,19	5,08	1	○	○	○
NGD3062RK	3	1,58	1,02	0,19	3,18	2	○	○	○
NGD3M200RK	3	2,00	1,02	0,19	4,06	1	○	○	○
NGD3094RK	3	2,39	1,02	0,19	6,35	1	○	○	○
NGD3M250RK	3	2,50	1,02	0,19	6,35	1	○	○	○
NGD3M300RK	3	3,00	1,02	0,19	6,35	1	○	○	○
NGD3125RK	3	3,18	1,02	0,19	6,35	1	○	○	○
NGD3M350RK	3	3,50	2,92	0,32	6,35	1	○	○	○
NGD3M400RK	3	4,00	2,92	0,32	6,35	1	○	○	○

INDEXABLE MILLING

SOLID END MILLING

HOLEMAKING

TAPPING

TURNING

Grooving and Turning Inserts • NGD-K • Deep Grooving with Chip Breaker

(continued)

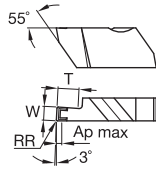
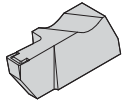

- first choice
- alternate choice

P	●	●	●	●
M	●	●	●	○
K	●	○	○	●
N	●	○	○	○
S	○	○	○	○
H	○	○	○	○

catalogue number	SSC	W	Ap max	RR	T	cutting edges	TN6010		TN6025		THM
							3607170	3607170	3607373	3607373	
NGD3189RK	3	4,80	2,92	0,58	6,35	1	●	●	○	○	●
NGD4125RK	4	3,18	1,02	0,19	6,35	2	○	○	○	○	○
NGD4M400RK	4	4,00	2,92	0,57	9,53	1	○	○	○	○	○
NGD4M450RK	4	4,50	2,92	0,57	12,70	1	○	○	○	○	○
NGD4189RK	4	4,80	2,92	0,57	9,53	1	○	○	○	○	○
NGD4M500RK	4	5,00	2,92	0,57	12,70	1	○	○	○	○	○
NGD4250RK	4	6,35	3,81	0,57	12,70	1	○	○	○	○	○
left hand											
NGD2M150LK	2	1,50	1,09	0,19	4,06	1	○	○	○	○	○
NGD2M200LK	2	2,00	1,09	0,19	5,08	1	○	○	○	○	○
NGD2M250LK	2	2,50	1,09	0,19	5,08	1	○	○	○	○	○
NGD3062LK	3	1,57	1,02	0,19	3,18	2	○	○	○	○	○

INDEXABLE MILLING

SOLID END MILLING

HOLEMAKING

TAPPING

TURNING

Grooving and Turning Inserts • NGD-K • Deep Grooving with Chip Breaker

(continued)

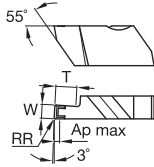
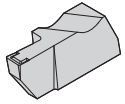

- first choice
- alternate choice

P	●	●	●	●
M	●	●	●	○
K	●	○	○	●
N	●	●	○	○
S	●	●	●	○
H	○	○	○	○

catalogue number	SSC	W	Ap max	RR	T	cutting edges	TN6010	TN6025	THM
NGD3M200LK	3	2,00	1,02	0,19	4,06	1	3606941	3607487	3607035
NGD3094LK	3	2,39	1,02	0,19	6,34	1	3607096	3607240	3607035
NGD3M250LK	3	2,50	1,02	0,19	6,35	1	3606942	3607423	
NGD3M300LK	3	3,00	1,02	0,19	6,35	1	3606943	3607400	
NGD3125LK	3	3,18	1,02	0,19	6,35	1	3607097	3607209	
NGD3M350LK	3	3,50	2,92	0,32	6,35	1	3607488	3607424	
NGD3M400LK	3	4,00	2,92	0,32	6,35	1	3607148	3607410	
NGD3189LK	3	4,80	2,92	0,57	6,35	1	3607148	3607410	
NGD4125LK	4	3,18	1,02	0,19	6,35	2	3607316	3607316	
NGD4M400LK	4	4,00	2,92	0,58	9,52	1	3607489	3607490	
NGD4M450LK	4	4,50	2,92	0,57	12,70	1	3607489	3607490	
NGD4189LK	4	4,80	2,92	0,57	9,53	1	3607147	3607314	
NGD4M500LK	4	5,00	2,92	0,58	12,70	1	3607491	3607491	
NGD4250LK	4	6,35	3,80	0,57	12,70	1	3607422	3607422	

NOTE: SSC = To correspond with the SSC on the toolholder.

Grooving and Turning Inserts • NGP • Grooving • Positive

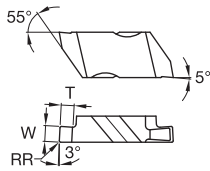
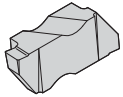

- first choice
- alternate choice

P	●	●	●	●
M	●	●	●	○
K	●	○	○	●
N	●	○	○	○
S	●	●	●	○
H	○	○	○	○

catalogue number	SSC	W	RR	T	TN6010	TN6025	THM
right hand							
NGP2M150R	2	1,50	0,19	2,79			3607045
NGP2062R	2	1,58	0,19	2,79	3607128		
NGP2M200R	2	2,00	0,19	2,79			3607046
NGP2M300R	2	3,00	0,19	2,79	3606978		
NGP3M150R	3	1,50	0,19	1,90	3606979		
left hand							
NGP2062L	2	1,57	0,19	2,79	3607182		
NGP2M200L	2	2,00	0,19	2,79	3606968		
NGP3M250L	3	2,50	0,19	3,81	3606973		

NOTE: SSC = To correspond with the SSC on the toolholder.

INDEXABLE MILLING

SOLID END MILLING

HOLE/MAKING

TAPPING

TURNING

Grooving and Turning Inserts • NF-K • Face Grooving with Chip Breaker

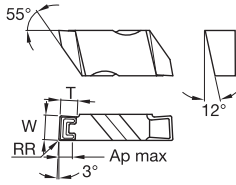
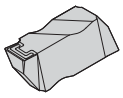

- first choice
- alternate choice

P	●	●	●	●
M	●	●	●	○
K	●	○	○	●
N	●	○	○	○
S	●	●	●	○
H	○	○	○	○

catalogue number	SSC	W	Ap max	RR	T	TN6010	TN6025	THM
right hand								
NF3M200RK	3	2,00	1,02	0,19	1,78	●	○	○
NF3M300RK	3	3,00	1,02	0,19	3,81	○	○	○
NF3125RK	3	3,18	1,02	0,19	3,81	○	○	○
left hand								
NF3M200LK	3	2,00	1,02	0,19	1,78	○	○	○
NF3M300LK	3	3,00	1,02	0,19	3,81	○	○	○
NF3125LK	3	3,18	1,02	0,19	3,81	○	○	○
NF3156LK	3	3,96	2,92	0,19	3,81	○	○	○

NOTE: SSC = To correspond with the SSC on the toolholder.

INDEXABLE MILLING

SOLID END MILLING

HOLEMAKING

TAPPING

TURNING

Grooving and Turning Inserts • NFD-K • Deep Face Grooving with Chip Breaker

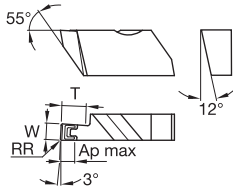
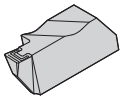

- first choice
- alternate choice

P	●	●	●	●
M	●	●	●	○
K	●	○	○	○
N	●	○	○	○
S	●	●	○	○
H	○	○	○	○

catalogue number	SSC	W	Ap max	RR	T	cutting edges	TN6010	TN6025	THM
right hand									
NFD3M300RK	3	3,00	1,02	0,19	6,35	1		3607523	
NFD3125RK	3	3,18	1,02	0,19	6,35	1		3607296	
NFD4189RK	4	4,80	2,92	0,57	9,53	1		3607325	
left hand									
NFD3M300LK	3	3,00	1,02	0,19	6,35	1		3607464	
NFD3125LK	3	3,18	1,02	0,19	6,35	1		3607293	
NFD4189LK	4	4,80	2,92	0,57	9,53	1		3607415	

NOTE: SSC = To correspond with the SSC on the toolholder.

INDEXABLE MILLING

SOLID END MILLING

HOLEMAKING

TAPPING

TURNING

Grooving and Turning Inserts • NP-K • Profiling with Chip Control

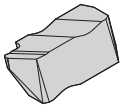

Right-hand insert shown; left-hand insert is mirror image.

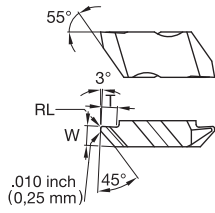

- first choice
- alternate choice

P	●	●	●	●
M	●	●	○	○
K	●	○	○	○
N	●	○	○	○
S	●	●	○	○
H	○	○	○	○

catalogue number	SSC	W	Ap max	RL	T	TN6010	TN6025	THM
right hand								
NP2002RK	2	3,73	2,75	0,09	2,81	3607136	3607477	—
NP3002RK	3	4,88	3,84	0,09	5,08	3607154	3607493	—
NP3012RK	3	4,90	3,86	0,34	5,08	—	3607328	—

INDEXABLE MILLING

SOLID END MILLING

HOLEMAKING

TAPPING

TURNING

Grooving and Turning Inserts • NR • Full Radius

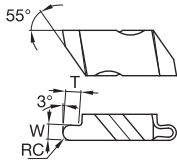
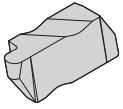

● first choice
○ alternate choice

P	●	●	●	●
M	●	●	●	○
K	●	○	○	●
N	●	○	○	○
S	●	●	●	○
H	○	○	○	○

catalogue number	SSC	W	RC	T	TN6010	TN6025	THM
right hand							
NR2M050R	2	1,00	0,50	1,27	3606957	3607393	—
NR2M075R	2	1,50	0,75	2,79	3606929	3607469	—
NR2031R	2	1,58	0,79	2,79	3607174	3607301	—
NR2M100R	2	2,00	1,00	2,79	3606830	3607470	—
NR2047R	2	2,39	1,19	2,79	—	3607494	—
NR2M150R	2	3,00	1,50	2,79	—	3607472	—
NR2M175R	2	3,50	1,75	2,79	—	3607483	—
NR3031R	3	1,58	0,79	2,39	3607125	3607475	—
NR3M100R	3	2,00	1,00	2,39	3606958	3607397	—
NR3047R	3	2,39	1,19	3,81	3607093	3607502	—
NR3M125R	3	2,50	1,25	3,81	—	3607439	—

INDEXABLE MILLING

SOLID END MILLING

HOLEMAKING

TAPPING

TURNING

Grooving and Turning Inserts • NR • Full Radius

(continued)

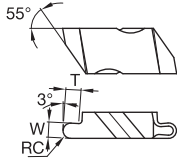
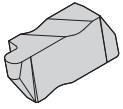

● first choice
○ alternate choice

P	●	●	●	●
M	●	●	●	○
K	●	○	○	○
N	●	○	○	○
S	●	●	●	○
H	○	○	○	○

catalogue number	SSC	W	RC	T	TN6010	TN6025	THM
NR3M150R	3	3,00	1,50	3,81	3606960	3607440	■
NR3062R	3	3,18	1,59	3,81	3607131	3607473	■
NR3M175R	3	3,50	1,75	3,81	■	3607441	■
NR3M200R	3	4,00	2,00	3,81	■	3607398	■
NR3M225R	3	4,50	2,25	3,81	■	3607442	■
NR3094R	3	4,78	2,39	3,81	3607180	3607476	■
NR4M200R	4	4,00	2,00	6,35	■	3607484	■
NR4M250R	4	5,00	2,50	6,35	■	3607486	■
NR4125R	4	6,35	3,18	6,35	3607130	3607500	■
left hand							
NR2M050L	2	1,00	0,50	1,27	3606924	3606948	■
NR2M075L	2	1,50	0,75	2,79	3607430	3607401	■

INDEXABLE MILLING

SOLID END MILLING

HOLEMAKING

TAPPING

TURNING

Grooving and Turning Inserts • NR • Full Radius

(continued)

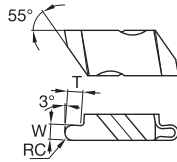
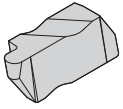

- first choice
- alternate choice

P	●	●	●	●
M	●	●	●	○
K	●	○	○	●
N	●	○	○	○
S	●	●	●	○
H	○	○	○	○

catalogue number	SSC	W	RC	T	TN6010	TN6025	THM
NR2031L	2	1,58	0,79	2,79	3607176	3607319	●
NR2M100L	2	2,00	1,00	2,79	●	3607431	●
NR2047L	2	2,39	1,19	2,79	●	3607446	●
NR2M125L	2	2,50	1,25	2,79	●	3607432	●
NR2M150L	2	3,00	1,50	2,79	3606927	3607433	●
NR2M175L	2	3,50	1,75	2,79	●	3607434	●
NR3031L	3	1,58	0,79	2,39	3607139	3607478	●
NR3M100L	3	2,00	1,00	2,39	3606949	●	●
NR3047L	3	2,39	1,19	3,81	3607135	3607479	●
NR3M125L	3	2,50	1,25	3,81	●	3607435	●
NR3M150L	3	3,00	1,50	3,81	●	3607436	●
NR3062L	3	3,18	1,59	3,81	3607171	3607497	3607032

INDEXABLE MILLING

SOLID END MILLING

HOLEMAKING

TAPPING

TURNING

Grooving and Turning Inserts • NR • Full Radius

(continued)

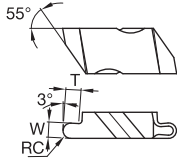
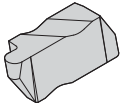

- first choice
- alternate choice

P	●	●	●	○
M	●	●	○	○
K	●	○	○	○
N	●	○	○	○
S	●	●	○	○
H	○	○	○	○

catalogue number	SSC	W	RC	T	TN6010	TN6025	THM
NR3M175L	3	3,50	1,75	3,81		3607437	
NR3M200L	3	4,00	2,00	3,81	3606953	3607396	
NR3M225L	3	4,50	2,25	3,81		3607438	
NR3094L	3	4,78	2,39	3,81		3607339	
NR4M250L	4	5,00	2,50	6,35	3606956		
NR4125L	4	6,35	3,18	6,35		3607514	

NOTE: SSC = To correspond with the SSC on the toolholder.

INDEXABLE MILLING

SOLID END MILLING

HOLEMAKING

TAPPING

TURNING

Grooving and Turning Inserts • NR-K • Full Radius with Chip Breaker

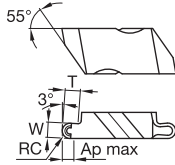
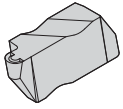

- first choice
- alternate choice

P	●	●	●	●
M	●	●	●	○
K	●	○	○	●
N	●	○	○	○
S	●	●	●	○
H	○	○	○	○

catalogue number	SSC	W	Ap max	RC	T	TN6010	TN6025	THM
right hand								
NR3031RK	3	1,57	1,97	0,79	2,39	3607062	3607206	—
NR3047RK	3	2,39	1,91	1,19	3,81	3607086	3607214	—
NR3062RK	3	3,18	2,92	1,59	3,81	3607056	3607236	—
NR3078RK	3	3,97	2,54	1,98	3,81	—	3607407	—
NR4062RK	4	3,18	2,92	1,59	3,81	—	3607461	—
NR4125RK	4	6,35	3,81	3,18	6,35	—	3607303	—
left hand								
NR3031LK	3	1,58	1,98	0,79	2,39	3607095	3607222	—
NR3047LK	3	2,39	3,81	1,20	3,81	3607102	3607408	—
NR3062LK	3	3,18	2,92	1,59	3,81	3607091	3607216	—
NR3078LK	3	3,96	2,54	1,98	3,81	3607172	3607306	—
NR4062LK	4	3,18	2,92	1,59	3,81	3607156	—	—
NR4094LK	4	4,79	3,81	2,39	6,35	3607150	3607452	—
NR4125LK	4	6,36	3,81	3,18	6,35	—	3607458	—

NOTE: SSC = To correspond with the SSC on the toolholder.

INDEXABLE MILLING

SOLID END MILLING

HOLEMAKING

TAPPING

TURNING

Grooving and Turning Inserts • NRD • Deep Grooving • Full Radius

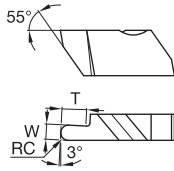
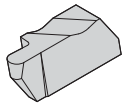

- first choice
- alternate choice

P	●	●	●	●
M	●	●	●	●
K	●	○	○	○
N	●	○	○	○
S	●	●	●	●
H	○	○	○	○

catalogue number	SSC	W	RC	T	cutting edges	TNG010	TNG025	THM
right hand								
NRD3031R	3	1,58	0,79	3,18	2	3607087	3607457	—
NRD3062R	3	3,17	1,59	6,35	1	3607099	3607474	—
NRD4062R	4	3,18	1,59	6,35	2	—	3607499	—
NRD4125R	4	6,35	3,18	12,70	1	—	3607496	—
left hand								
NRD3031L	3	1,58	0,79	3,18	2	3607085	3607455	—
NRD3062L	3	3,17	1,59	6,35	1	3607124	3607462	—
NRD4062L	4	3,18	1,59	6,35	2	—	3607295	—

NOTE: SSC = To correspond with the SSC on the toolholder.

INDEXABLE MILLING







SOLID END MILLING

HOLEMAKING

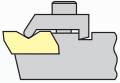
TAPPING

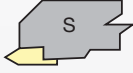
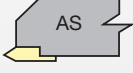
TURNING

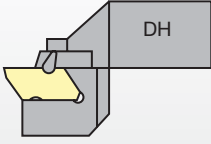
TopGroove Holder • Catalog Numbering System

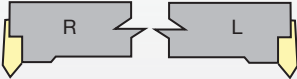
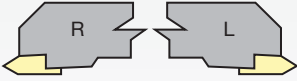
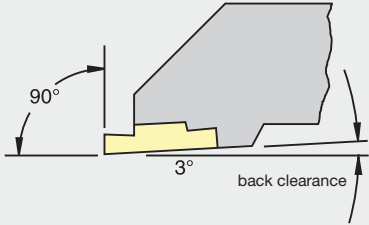
N	S	R		2525	M	4																																																																	
Insert Holding Method	Insert Mounting Location	Hand of Tool	Drop Head	Shank Size	Tool Length	Insert Size	Qualified Surface and Length																																																																
<p>N – TopGroove*</p>  <p>*Proprietary standard only.</p>	<p>End mount</p>  <p>Side mount Offset</p>  <p>Side mount No offset for swiss machining</p>  <p>NRR undercut</p> 		<p>DH = Drop Head</p> 	<p>Shank height and width in mm and holder length according to ISO standard.</p>	<table border="1"> <thead> <tr> <th>L1</th> <th>ISO</th> </tr> </thead> <tbody> <tr><td>32</td><td>A</td></tr> <tr><td>40</td><td>B</td></tr> <tr><td>50</td><td>C</td></tr> <tr><td>60</td><td>D</td></tr> <tr><td>70</td><td>E</td></tr> <tr><td>80</td><td>F</td></tr> <tr><td>90</td><td>G</td></tr> <tr><td>100</td><td>H</td></tr> <tr><td>110</td><td>I</td></tr> <tr><td>125</td><td>J</td></tr> <tr><td>140</td><td>K</td></tr> <tr><td>150</td><td>L</td></tr> <tr><td>160</td><td>M</td></tr> <tr><td>170</td><td>N</td></tr> <tr><td>180</td><td>P</td></tr> <tr><td>200</td><td>Q</td></tr> <tr><td>250</td><td>R</td></tr> <tr><td>300</td><td>S</td></tr> <tr><td>350</td><td>T</td></tr> <tr><td>400</td><td>U</td></tr> <tr><td>450</td><td>V</td></tr> <tr><td>500</td><td>W</td></tr> <tr><td>Special Length</td><td>Y</td></tr> <tr><td></td><td>X</td></tr> </tbody> </table>	L1	ISO	32	A	40	B	50	C	60	D	70	E	80	F	90	G	100	H	110	I	125	J	140	K	150	L	160	M	170	N	180	P	200	Q	250	R	300	S	350	T	400	U	450	V	500	W	Special Length	Y		X	 <table border="1"> <thead> <tr> <th>insert size</th> <th>W1</th> </tr> </thead> <tbody> <tr><td>2</td><td>3,81mm</td></tr> <tr><td>3</td><td>4,95mm</td></tr> <tr><td>4</td><td>6,98mm</td></tr> <tr><td>5</td><td>9,65mm</td></tr> <tr><td>6</td><td>9,73mm</td></tr> <tr><td>8</td><td>11,13mm</td></tr> </tbody> </table>	insert size	W1	2	3,81mm	3	4,95mm	4	6,98mm	5	9,65mm	6	9,73mm	8	11,13mm	
L1	ISO																																																																						
32	A																																																																						
40	B																																																																						
50	C																																																																						
60	D																																																																						
70	E																																																																						
80	F																																																																						
90	G																																																																						
100	H																																																																						
110	I																																																																						
125	J																																																																						
140	K																																																																						
150	L																																																																						
160	M																																																																						
170	N																																																																						
180	P																																																																						
200	Q																																																																						
250	R																																																																						
300	S																																																																						
350	T																																																																						
400	U																																																																						
450	V																																																																						
500	W																																																																						
Special Length	Y																																																																						
	X																																																																						
insert size	W1																																																																						
2	3,81mm																																																																						
3	4,95mm																																																																						
4	6,98mm																																																																						
5	9,65mm																																																																						
6	9,73mm																																																																						
8	11,13mm																																																																						
				<p>End mount</p>  <p>Side mount</p> 		<p>Q – qualified metric holder</p>  <p>NOTE: Holders are designed to locate insert inclined to 3° to provide back clearance down open side.</p>																																																																	

INDEXABLE MILLING

SOLID END MILLING

HOLEMAKING

TAPPING

TURNING

TopGroove Boring Bar • Catalog Numbering System







INDEXABLE MILLING

SOLID END MILLING

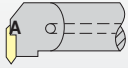
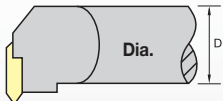
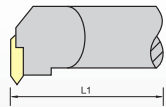
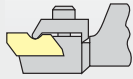
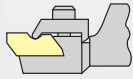
HOLEMAKING

TAPPING

TURNING

A	25	R	N	N	T	0	R	2																													
Bar Type	Bar Diameter	Bar Length	Insert Holding Method	Insert Shape	Insert Location	Rake Angle	Hand of Tool	Insert Size																													
Steel with coolant 			N – TopGroove 		End mount  Side mount 	Right hand  Left hand 																															
			<table border="1"> <thead> <tr> <th colspan="2">Metric Bars</th> </tr> </thead> <tbody> <tr> <td>M</td> <td>150mm</td> </tr> <tr> <td>Q</td> <td>180mm</td> </tr> <tr> <td>R</td> <td>200mm</td> </tr> <tr> <td>S</td> <td>250mm</td> </tr> <tr> <td>T</td> <td>300mm</td> </tr> <tr> <td>U</td> <td>350mm</td> </tr> </tbody> </table>		Metric Bars		M	150mm	Q	180mm	R	200mm	S	250mm	T	300mm	U	350mm	<table border="1"> <thead> <tr> <th>insert size</th> <th>W1</th> </tr> </thead> <tbody> <tr> <td>1</td> <td>3,54mm</td> </tr> <tr> <td>2</td> <td>3,81mm</td> </tr> <tr> <td>3</td> <td>5,35mm</td> </tr> <tr> <td>4</td> <td>6,40mm</td> </tr> <tr> <td>5</td> <td>9,65mm</td> </tr> <tr> <td>6</td> <td>9,73mm</td> </tr> <tr> <td>8</td> <td>11,13mm</td> </tr> </tbody> </table>			insert size	W1	1	3,54mm	2	3,81mm	3	5,35mm	4	6,40mm	5	9,65mm	6	9,73mm	8	11,13mm
Metric Bars																																					
M	150mm																																				
Q	180mm																																				
R	200mm																																				
S	250mm																																				
T	300mm																																				
U	350mm																																				
insert size	W1																																				
1	3,54mm																																				
2	3,81mm																																				
3	5,35mm																																				
4	6,40mm																																				
5	9,65mm																																				
6	9,73mm																																				
8	11,13mm																																				

Integral Toolholders • NS • Metric

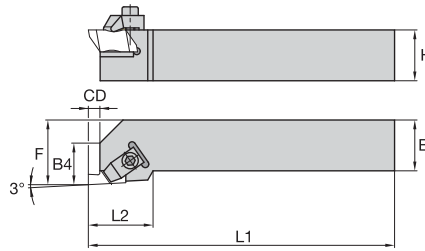
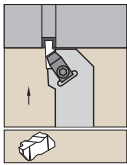

order number	catalogue number	H	B	F	L1	L2	B4	CD	gage insert
right hand									
3641660	NSR1212F2	12,0	12,0	16,0	80	19	9	4	N.2R
3636542	NSR1616H2	16,0	16,0	20,0	100	19	9	4	N.2R
3638589	NSR2020K2	20,0	20,0	25,0	125	19	9	4	N.2R
3638588	NSR2020K3	20,0	20,0	25,0	125	32	13	5	N.3R
3638590	NSR2525M2	25,0	25,0	32,0	150	19	9	4	N.2R
3636536	NSR2525M3	25,0	25,0	32,0	150	32	13	5	N.3R
3636540	NSR2525M4	25,0	25,0	32,0	150	35	14	7	N.4R
3641666	NSR3232P3	32,0	32,0	40,0	170	32	13	5	N.3R
3641669	NSR3232P4	32,0	32,0	40,0	170	35	14	7	N.4R
left hand									
3639045	NSL2020K2	20,0	20,0	25,0	125	19	9	4	N.2L
3639046	NSL2020K3	20,0	20,0	32,0	125	32	13	5	N.3L
3639047	NSL2525M2	25,0	25,0	32,0	150	19	9	4	N.2L
3636539	NSL2525M3	25,0	25,0	32,0	150	32	13	5	N.3L
3636544	NSL2525M4	25,0	25,0	32,0	150	35	14	7	N.4L

NOTE: F dimension measured over sharp point of insert.

Integral Toolholders • NAS • Metric

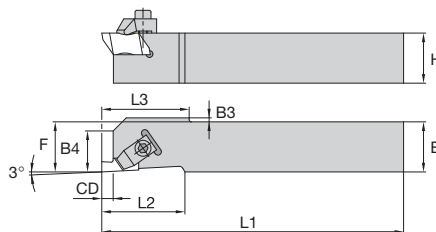
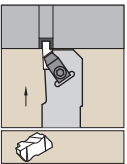

order number	catalogue number	H	B	F	L1	L2	B4	CD	gage insert
right hand									
3641662	NASR1212M2Q	12,0	12,0	12,0	150	19	9	3,5	N.2R
3639048	NASR1616K3Q	16,0	16,0	16,0	125	32	12	5,3	N.3R

NOTE: F dimension measured over sharp point of insert.

Integral Toolholders • NE • Metric

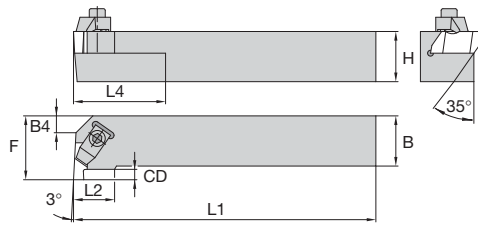
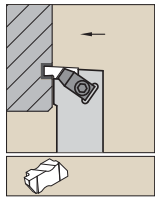

Right-hand toolholder shown.

order number	catalogue number	H	B	F	L1	L2	L4	B4	CD	gage insert
right hand										
3641658	NER2020K2	20,0	20,0	25,0	125	15	25	6	4	N.2L
3641665	NER2525M2	25,0	25,0	32,0	150	15	25	12	4	N.2L
3636541	NER2525M3	25,0	25,0	32,0	150	22	51	—	5	N.3L
3641672	NER2525M4	25,0	25,0	35,0	150	24	51	—	7	N.4L
left hand										
3641677	NEL2020K2	20,0	20,0	25,0	125	15	25	6	4	N.2R
3641676	NEL2525M2	25,0	25,0	32,0	150	15	25	12	4	N.2R
3636543	NEL2525M3	25,0	25,0	32,0	150	22	51	—	5	N.3R
3641668	NEL2525M4	25,0	25,0	35,0	150	24	51	—	7	N.4R

NOTE: F dimension measured over sharp point of insert.

Integral I.D. Grooving Boring Bars • A-NNT • Metric

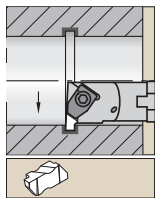

Steel shank with through coolant.

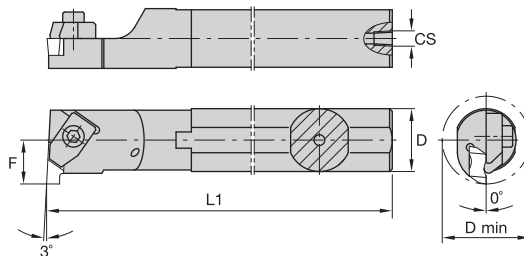

Right-hand toolholder shown.

order number	catalogue number	D	D min	L1	F	CS	gage insert
right hand							
3641644	A12MNNTOR2	12	18,5	150	11	1/16-27 NPT	NG2L
3641643	A16MNNTOR2	16	22,0	150	11	1/8-27 NPT	N.2L
3641645	A20QNNTOR2	20	26,0	180	13	1/8-27 NPT	N.2L
3641651	A25RNNTOR2	25	34,0	200	17	1/4-18 NPT	N.2L
3641622	A25RNNTOR3	25	34,0	200	17	1/4-18 NPT	N.3L
3641646	A32SNNTOR3	32	44,0	250	22	1/4-18 NPT	N.3L
3641653	A40TNNTOR3	40	54,0	300	27	1/4-18 NPT	N.3L
3641654	A40TNNTOR4	40	54,0	300	27	1/4-18 NPT	N.4L
left hand							
3641655	A12MNNTOL2	12	18,5	150	11	1/16-27 NPT	NG2R
3641649	A16MNNTOL2	16	22,0	150	11	1/8-27 NPT	N.2R
3641652	A20QNNTOL2	20	26,0	180	13	1/8-27 NPT	N.2R
3641657	A25RNNTOL2	25	34,0	200	17	1/4-18 NPT	N.2R
3641650	A25RNNTOL3	25	34,0	200	17	1/4-18 NPT	N.3R
3641656	A32SNNTOL3	32	44,0	250	22	1/4-18 NPT	N.3R
3641659	A40TNNNTOL3	40	54,0	300	27	1/4-18 NPT	N.3R

NOTE: Minimum bore capability varies with depth of groove. See page E418 for details.
F dimension measured over sharp point of insert.

Integral I.D. Grooving Boring Bars • A-NNT-1 • Metric

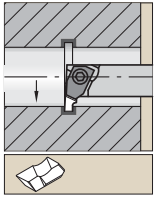

Necked steel shank with through coolant.

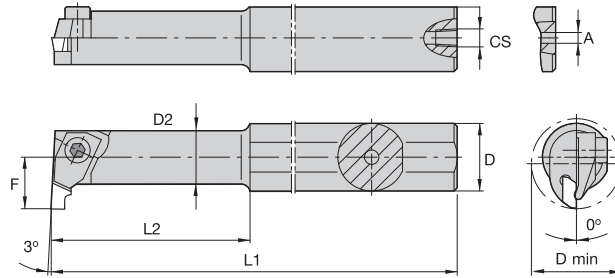

Right-hand toolholder shown.

order number	catalogue number	D	D min	D2	L1	L2	F	A	CS	gage insert
right hand										
3641648	A10KNNTOR1	10	11,5	10,0	125	—	7	3,2	—	NG1L
3641647	A12MNNTOR1	12	11,5	8,7	150	31,30	7	4,0	1/16-27 NPT	N.1L

NOTE: Minimum bore capability varies with depth of groove. See page E418 for details.
F dimension measured over sharp point of insert.

INDEXABLE MILLING

SOLID END MILLING

HOLEMAKING







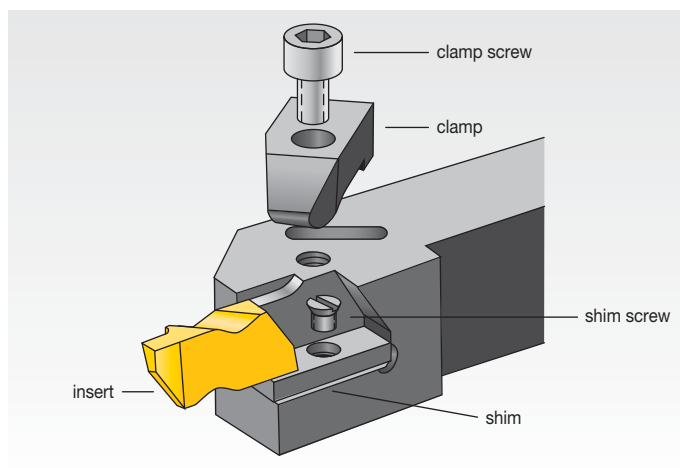

TAPPING

TURNING

Hardware

TopGroove Toolholders and Boring Bars



insert size and style	 clamp	 clamp screw	 shim	 shim screw
NG-1L 	CM-109	S-304	–	–
NG-2R	CM-182	S-310	–	–
NG-2L	CM-183	S-310	–	–
NG-2R 	CM-74	S-310	–	–
NG-2L	CM-75	S-310	–	–
NG-3R	CM-184	S-412	–	–
NG-3L	CM-185	S-412	–	–
NG-3R	CM-72	S-412	–	–
NG-3L 	CM-73	S-412	–	–
NG-3R*	CM-78	S-412	–	–
NG-3L*	CM-70	S-412	–	–
NG-4R	CM-72	S-412	SM-420	SL-344
NG-4L 	CM-73	S-412	SM-420	SL-344
NG-5R	CM-80	S-352	–	–
NG-5L 	CM-81	S-352	–	–
NG-6R	CM-120	S-412	SM-416	S-111
NG-6L 	CM-121	S-412	SM-416	S-111
TopGroove relief grooving				
NU-3125R	CM-72	S-412	–	–
NU-3125L	CM-73	S-412	–	–
NU-3125R**	CM-72	S-618	–	–
NU-3125L**	CM-73	S-618	–	–
Utility threading				
NTU-4R	CM-72	S-412	–	–
NTU-4L	CM-73	S-412	–	–

*25mm diameter boring head.

**Boring head.

Grooving Tool Failure and Solution Guide

Practical Solutions to Common Grooving Problems

Holder Position for Grooving Operation

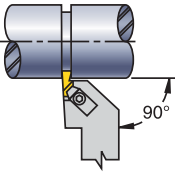

How to Cut a Groove Slightly Wider than the Groove Tool

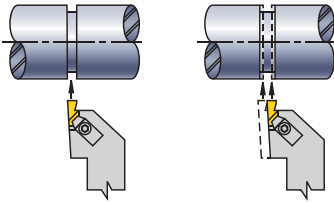

1. Plunge the center of the groove.
2. Plunge each side of the groove to get the specified width. Use a slower feed rate when cutting groove sides.

How to Cut Wider Grooves

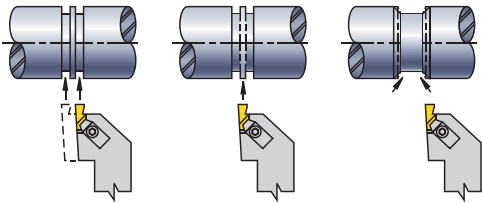

1. Plunge out both sides of groove width.
2. Plunge center area to remove web of material remaining.
3. Plunge both sides of groove at the required angle, using approximately one-half the width of the grooving tool for maximum width of cut.

Finish Turning the Groove

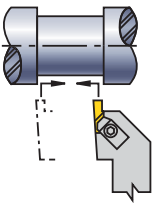

1. Follow recommendations explained above.
2. To avoid insert chipping and to achieve groove wall perpendicularity, follow the tool path outlined here.
3. Use the lightest depth of cut that still enables good chip surface finishing.

problem	solution
bur	<ol style="list-style-type: none"> 1. Ensure tool center height. 2. Use sharp tool (index more often). 3. Use positive rake PVD-coated insert. 4. Use correct grade for workpiece material. 5. Use correct geometry (e.g., positive rake for work-hardening material). 6. Chamfer before grooving. 7. Change tool path.
poor surface finish	<ol style="list-style-type: none"> 1. Increase speed. 2. Use sharp tool (index more often). 3. Dwell tool in bottom 1–3 revolutions (max). 4. Use proper chip control geometry. 5. Increase coolant flow/concentration. 6. Ensure proper setup (overhang, shank size). 7. Use correct geometry (e.g., positive rake for work-hardening material).
groove bottom that is not flat	<ol style="list-style-type: none"> 1. Use sharp tool (index more often). 2. Dwell tool in bottom 1–3 revolutions (max). 3. Reduce tool overhang (increase rigidity). 4. Ensure correct tool alignment. 5. Reduce feed rate at groove bottom. 6. Use a wider insert. 7. Ensure tool center height.
poor chip control	<ol style="list-style-type: none"> 1. Use “K” chip control geometry insert. 2. Use sharp tool (index more often). 3. Increase coolant concentration. 4. Adjust feed rate (usually increase first).
chatter	<ol style="list-style-type: none"> 1. Reduce tool and workpiece overhang. 2. Adjust speed and feed (usually increase first). 3. Ensure center height.
insert chipping	<ol style="list-style-type: none"> 1. Use correct grade for workpiece material. 2. Increase speed. 3. Reduce feed. 4. Use a stronger grade. 5. Increase tool and setup rigidity.
side walls not straight	<ol style="list-style-type: none"> 1. Check tool alignment for square. 2. Use correct insert hand. 3. Reduce workpiece and tool overhang. 4. Use sharp insert (index more often).

Machining Guidelines

Machining Guidelines for Chip Control • Grooving

When the proper cutter diameter is not available, proper cutter positioning will provide positive results.

- Center height of insert should be positioned at the center of the workpiece or up to 0,13mm above.
- Dwell time in the bottom of the groove (more than three revolutions) is not recommended.
- Chip control is feed rate related and should be adjusted to fit the particular situation. Recommended feed range is 0,08–0,3 mm/rev.

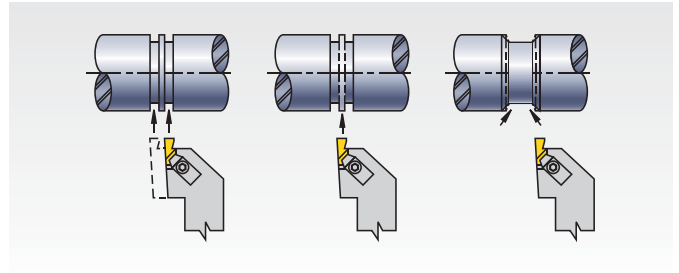

Machining Guidelines for Chip Control • Turning/Profiling

Maximum depth of cut for side cutting (turning/profiling) depends on the material being cut and the width of the tool.

- 0,79–1,6mm wide insert can cut up to 0,6mm deep.
- 1,7–3,3mm wide insert can cut up to 1mm deep.
- 3,5–4,8mm wide insert can cut up to 2mm deep.
- 5–6,35mm wide insert can cut up to 3mm deep.

Finish Turning the Groove

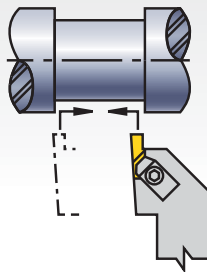

1. Plunge both sides of groove width.
2. Plunge center area to remove web of material remaining.
3. To avoid insert chipping and to achieve groove wall perpendicularity, follow the tool path outlined.
4. Use the lightest depth of cut that still allows good chipbreaking, tool life, and surface finish.

Groove Limits

insert catalogue number	Groove Limits	
	maximum internal groove depth mm	minimum bore diameter mm
NG-1094L	1,91	20,32
—	1,02	11,18
NG-2031R/L	1,27	18,54
NG-2041R/L	—	—
NG-2047R/L	—	—
NG-2058R/L	—	—
—	2,79	63,50
NG-2062R/L	2,59	44,45
NG-2094R/L	2,49	38,10
NG-2125R/L	2,03	25,40
—	1,40	18,54
NG-3047R/L	—	—
NG-3062R/L	2,39	44,45
NG-3072R/L	2,29	41,28
NG-3078R/L	1,91	34,93
NG-3088R/L	—	—
NG-3094R/L	—	—
NG-3097R/L	3,81	60,33
NG-3105R/L	—	—
NG-3110R/L	3,68	53,98
NG-3122R/L	—	—
NG-3125R/L	3,51	47,63
NG-3142R/L	—	—
NG-3156R/L	3,18	41,28
NG-3178R/L	—	—
NG-3185R/L	2,79	34,93
NG-3189R/L	—	—
NG-4125R/L	3,81	69,85
—	6,35	146,05
NG-4189R/L	6,22	127,00
NG-4213R/L	6,10	114,30
NG-4219R/L	5,54	82,55
NG-4250R/L	5,08	63,50

NOTE: The same maximum groove depth and minimum bore diameter values also apply to metric, NG-K (chip control), and NR (full radius) inserts of similar size. The same internal grooving depth limits are a function of bar clearance versus bore diameters.

Machining Guidelines

Internal Groove Depth versus Bar Interference

NOTE: Internal grooving depth limits are a function of bar clearance versus bore diameters.

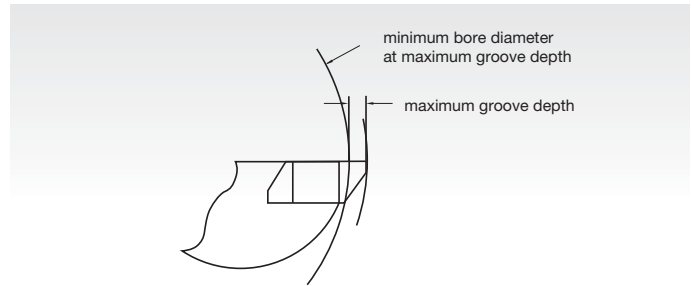

Machining Guidelines for Back Turning/ Turning/Profiling

The NP-K-style TopGroove inserts were engineered specifically for back turning on small automatic lathes, but they also find applications for other light turning and profiling operations. For general applications, maximum depth of cut should not exceed 2,74mm for size 2 inserts or 3,84mm for size 3 inserts.

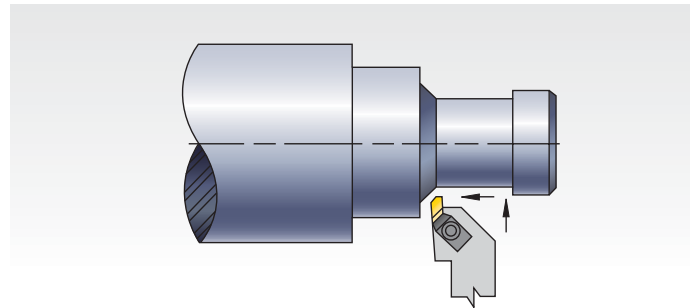

Machining Guidelines for Using TopGroove Deep Grooving Inserts (NGD)

Typically, those NGD- and NRD-style inserts with two cutting edges require no machine offset changes. However, those inserts with only one cutting edge do require offset changes. Refer to the chart here to ensure proper offset adjustments.

insert catalogue number	add to C dimension	add to F dimension
	mm	mm
NGD-3062	0,00	0,00
NGD-3094	2,54	2,54
NGD-3125	2,54	2,54
NGD-3189	2,54	2,54
NGD-4125	0,00	0,00
NGD-4189	3,18	3,18
NGD-4250	6,35	6,35
NRD-3031	0,00	0,00
NRD-3062	2,54	2,54
NRD-4062	0,00	0,00
NRD-4094	6,35	6,35
NRD-4125	6,35	6,35

TopGroove Insert Selection Guide

- All TopGroove inserts are precision ground to provide accurate edge location and secure locking of the insert in the toolholder pocket.
- TopGroove inserts can be used in either toolholders or boring bars.
- Right-hand TopGroove toolholders use right-hand inserts. Left-hand TopGroove toolholders use left-hand inserts.
- Right-hand TopGroove boring bars use left-hand inserts. Left-hand TopGroove boring bars use right-hand inserts.

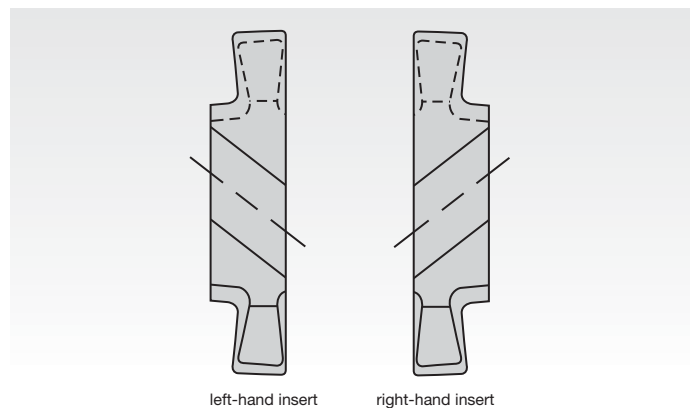

left-hand insert

right-hand insert

Machining Guidelines

Machining Guidelines for Poly-Vee Grooving with Custom Solution and TopGroove NV Inserts (NV3-J and NV4-L)

- To machine cross section “J”, use insert NV3-J.
- To machine cross section “L”, use insert NV4-L.

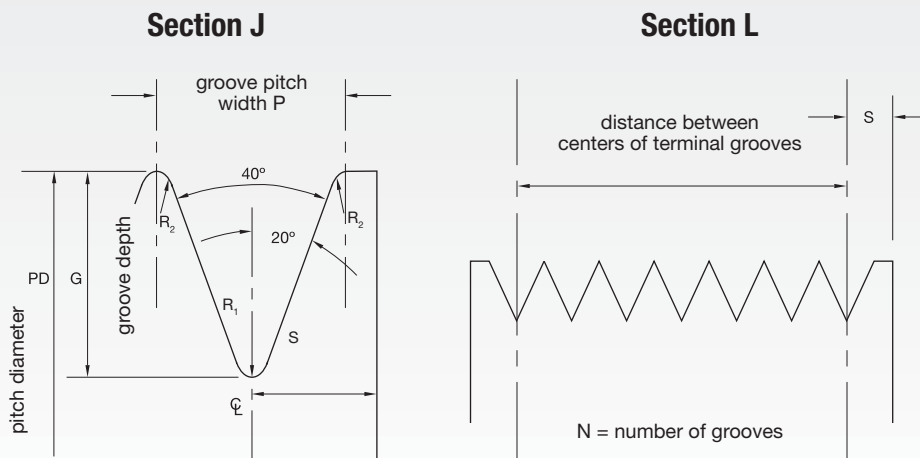

Groove Dimensions and Tolerances for Sheaves

groove cross section	pitch width (P)	groove depth (G)	minimum radius (R2)	radius (R1)	terminal distance	distance between centers of terminal grooves and maximum accumulated tolerance
J	2,34 ±0,03	2,21 ±0,13	0,20	0,32 ±0,06	3,18	(N-1)4,88 ±0,25
L	4,70 ±0,05	5,11 ±0,13	0,38	0,32 ±0,06	3,18	(N-1)4,70 ±0,25

Machining Guidelines

Machining Guidelines for Undercutting Operations Performed with Custom Solution and TopGroove NU Inserts (NU3094, NU3125, and NU3156)

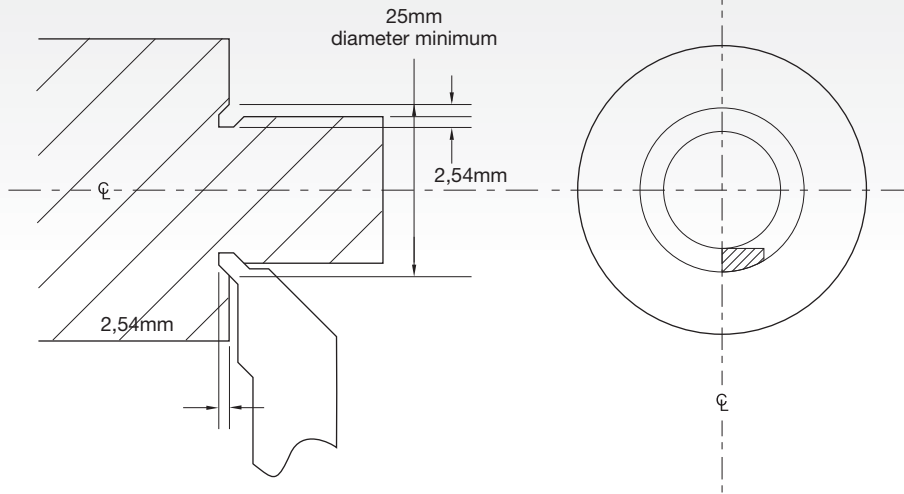

INDEXABLE MILLING

SOLID END MILLING

HOLEMAKING

TAPPING

TURNING

Machining Guidelines

Machining Guidelines for Face Grooving Operations • External

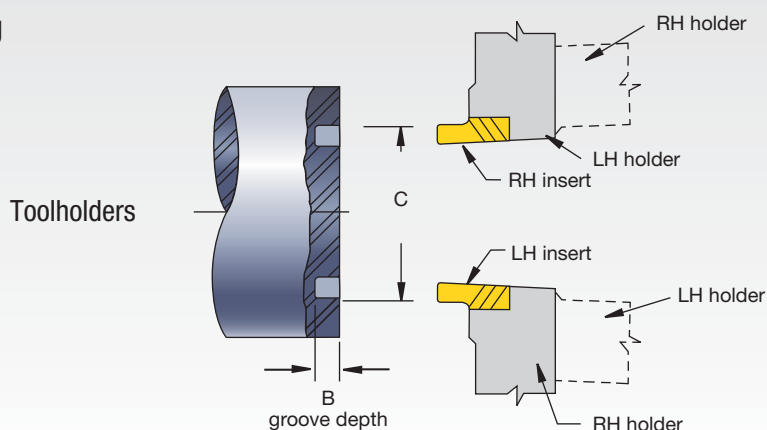

Standard NF/NDF Inserts

insert family	maximum groove depth B	minimum groove diameter C
	mm	mm
NF-3	1,52	23,9
NF-3	2,39	30,5
NF-3	3,18	36,1
NF-3	3,81	41,3
NFD-3	6,35	47,6
NFD-4	9,53	57,2
NFD-4	12,70	57,2

Machining Guidelines for Face Grooving Operations • External

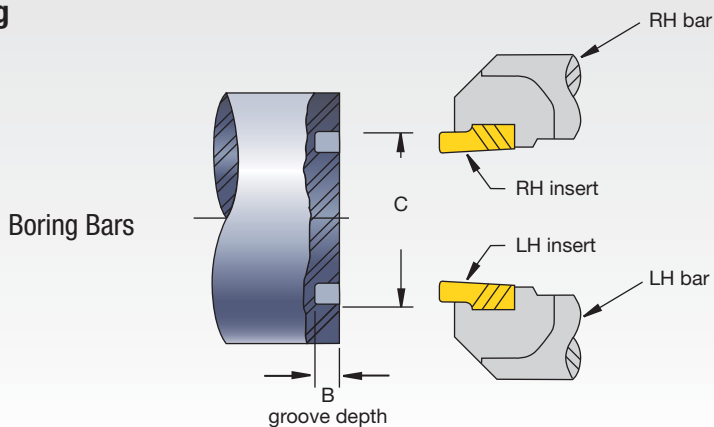

Standard NG/NGD Inserts

insert family	maximum groove depth B	minimum groove diameter C
	mm	mm
NG-2	1,27	54,0
NG-2	2,79	88,9
NG-3	2,39	101,6
NG-3	3,18	127,0
NG-3	3,81	139,7
NGD-3	6,35	174,6
NG-4	3,81	152,4
NG-4	6,35	209,6
NGD-4	9,53	222,3
NGD-4	12,70	222,3

Machining Guidelines

Machining Guidelines for Face Grooving Operations • Internal

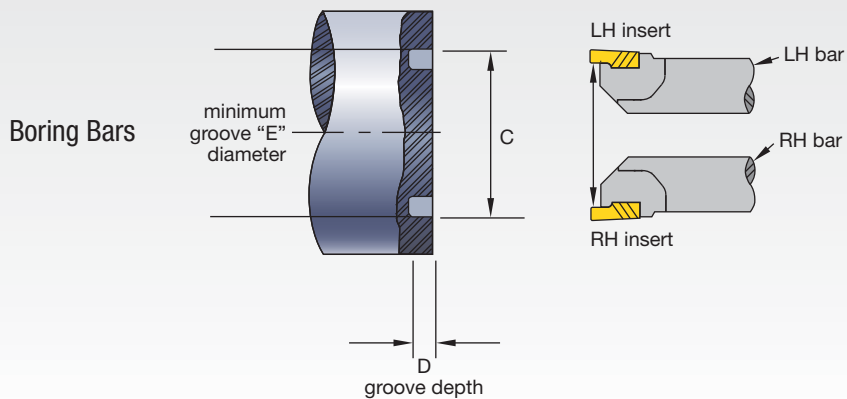

Standard NG/NGD Inserts

insert family	maximum groove depth B mm	minimum groove diameter C mm
NFD-3-KI	6,35	63,5

NOTE: Also check minimum bore diameter of boring bar. See page E418.

INDEXABLE MILLING

SOLID END MILLING

HOLE/MAKING

TAPPING

TURNING

INDEXABLE MILLING

SOLID END MILLING

HOLEMAKING

TAPPING

TURNING

Grooving and Turning Inserts • WGT-N

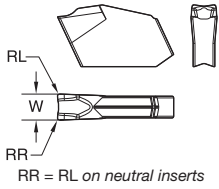

- first choice
- alternate choice

P	<input checked="" type="checkbox"/>	<input checked="" type="checkbox"/>	<input type="checkbox"/>	<input type="checkbox"/>
M	<input checked="" type="checkbox"/>	<input checked="" type="checkbox"/>	<input type="checkbox"/>	<input type="checkbox"/>
K	<input checked="" type="checkbox"/>	<input type="checkbox"/>	<input type="checkbox"/>	<input checked="" type="checkbox"/>
N	<input checked="" type="checkbox"/>	<input type="checkbox"/>	<input type="checkbox"/>	<input type="checkbox"/>
S	<input checked="" type="checkbox"/>	<input checked="" type="checkbox"/>	<input type="checkbox"/>	<input type="checkbox"/>
H	<input type="checkbox"/>	<input type="checkbox"/>	<input type="checkbox"/>	<input type="checkbox"/>

catalogue number	W		RL		TN6010	TN6025	THM
	mm	in	mm	in			
WGTN2	2,25	.089	0,18	.007		4103785	
WGTN3	3,05	.120	0,22	.009		4103784	
WGTN3W	3,05	.120	0,22	.009		4103798	
WGTN4	4,05	.159	0,24	.009		4103787	
WGTN48	4,80	.189	0,26	.010		4103797	
WGTN5	5,05	.199	0,26	.010		4103792	

Grooving and Turning Inserts • WGF

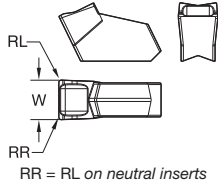

- first choice
- alternate choice

P	●	●	●	●
M	●	●	○	○
K	●	○	○	○
N	●	○	○	○
S	●	●	○	○
H	○	○	○	○

catalogue number	W		RL		TN6010	TN6025	THM
	mm	in	mm	in			
WGFN2	2,20	.087	0,16	.006		4109153	
WGFN24	2,40	.095	0,16	.006		4109154	
WGFN3	3,00	.118	0,25	.010		4109097	
WGFN4	4,10	.161	0,28	.011		4109102	
WGFN6	6,39	.251	0,35	.014		4109164	

INDEXABLE MILLING

SOLID END MILLING

HOLEMAKING

TAPPING

TURNING

LG Grooving

Large-Width Grooving

The LG Grooving platform is designed for large-width grooving using periphery ground inserts for close tolerances. (+/- .05mm)



- Inserts available from 8.15–16.20mm.
- Inserts feature a bottom 'V' for secure seating on the pocket seat.
- Grade WU35CT with easy-wear identification.
- The chip groove design with positive rake enables good chip control and reduced forces.



Primarily used in the Energy segment for grooving operations on turbine rotors.

BENEFITS

VERSATILITY

Single-sided, versatile grooving and cut-off solution with smooth surface finish.

STABILITY

Insert seating and clamping mechanism ensures stability and reliability in heavy-duty applications.

APPLICATIONS



O.D.
GROOVING



DEEP
GROOVING

Grades and Grade Descriptions

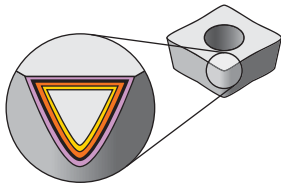

Coatings provide high-speed capability and are engineered for finishing to heavy roughing.

P	Steel
M	Stainless Steel
K	Cast Iron
N	Non-Ferrous
S	High-Temp Alloys
H	Hardened Materials

Grade	Coating	Grade Description	wear resistance ← → toughness																	
			05	10	15	20	25	30	35	40	45									
WU35CT		Coated carbide MT-CVD/CVD – TiN-TiCN-Al ₂ O ₃ -TiN. A good combination of tough substrate and wear-resistant, multi-layer CVD coating. Suitable for rough turning in most steels and also stainless steel.	P																	
			M																	

Feed Values for Grooving Inserts

LG System • 0



...0
 Inserts with wide range of applications in grooving and deep grooving. With additional chip control element for good chip control, even with varying widths of cut.

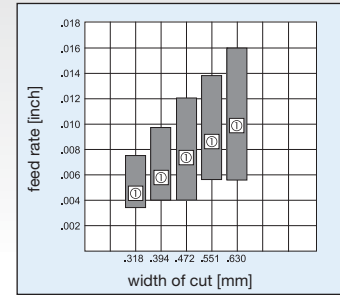

① Recommended Starting Feed

Recommended Cutting Speeds • Metric

Material Group	Cutting Speed – vc		
	m/min		
	WU35CT		
P	0/1	min 140	max 210
	2	115	175
	3	115	145
	4	75	100
	5	105	140
	6	45	60
M	1	90	110
	2	75	90
	3	55	70

Integral Toolholders • LG • Metric

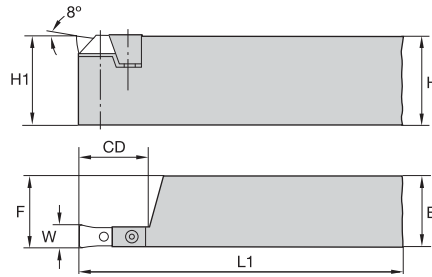

Right Hand Tool

order number	catalogue number	SSC	W	CD	H	B	F	L1	H1
right hand									
2022446	12250110100	1	8,00	20,0	32	25,0	25,5	170	32
2008147	12250110300	1	10,00	20,0	32	25,0	25,5	170	32
2021719	12250110500	1	12,00	25,0	40	32,0	33,0	200	40
2021721	12250110700	1	14,00	28,0	40	32,0	33,0	200	40
2008521	12250110900	1	16,00	32,0	40	32,0	33,0	200	40
left hand									
2022447	12250110200	1	8,00	20,0	32	25,0	25,5	170	32
2008144	12250110400	1	10,00	20,0	32	25,0	25,5	170	32
2021718	12250110600	1	12,00	25,0	40	32,0	33,0	200	40
2021722	12250111000	1	16,00	32,0	40	32,0	33,0	200	40

NOTE: SSC = To correspond with the SSC on the insert.

FOR SPARE PARTS, PLEASE VISIT WIDIA.COM OR WIDIANOVO.COM.

MOUNTING SCREWS ARE NOT INCLUDED IN STANDARD PACKAGING.

Grooving and Turning Inserts • LG LGNO

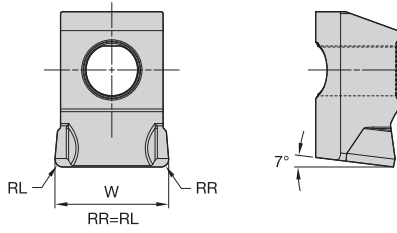

- first choice
- alternate choice

P	<input checked="" type="checkbox"/>
M	<input type="checkbox"/>
K	<input type="checkbox"/>
N	<input type="checkbox"/>
S	<input type="checkbox"/>
H	<input type="checkbox"/>

catalogue number	W	RR	
123568080	8,15	0,80	6909025
123568100	10,15	0,80	6909026
123568120	12,20	0,80	6909027
123568140	14,20	0,80	6909028
123568160	16,20	0,80	6909029

WU35CT

6909025

6909026

6909027

6909028

6909029

INDEXABLE MILLING

SOLID END MILLING

HOLEMAKING

TAPPING

TURNING

Count on the WIDIA™ TopThread system for when high heat, high edge-line load concentrated to a small nose radius, and high feed rates combine to place tremendous demands on carbide threading inserts. TopThread insert technology brings superior chip control to high-demand applications like machining Acme, Buttress, and API threads.



TOOLHOLDERS

- Reduced inconsistencies and better workpiece finish.
- TopThread inserts are precision-ground to provide accurate edge location and secure locking of the insert in the toolholder pocket.
- Excellent choice for special thread forms and toolholder designs.
- TopThread inserts are available in TN6010™ and TN6025™ grades to withstand the demands placed on the cutting edge of the threading insert.



INSERTS

- Rigid design for increased stability during threading applications.
- Good quality threads, improved tool life, and improved surface finishes.
- Locking forces in three directions for superior resistance to tangential force.
- Unique 3° insert relief angle for back clearance.
- Available in partial profile inserts for 60° thread forms.

THE SIMPLE SOLUTION

VERSATILE



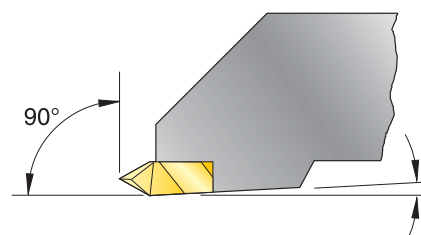

The versatility of the TopThread steel enables you to use both threading and grooving inserts in the same toolholder.



NOTE: Holders are designed to locate inserts inclined to 3° to provide back clearance down open side.

HIGH-DEMAND APPLICATION THREADING

TopThread™

INSERT STYLE	OPTIMUM CUTTING CONDITIONS	FIRST CHOICE	MATERIALS
Chip control or neutral 	TN6010 160–750	TN6025 130–650	P
Chip control or positive 	TN6010 160–600	TN6025 130–450	M
Neutral 	TN6010 230–700	TN6025 200–475	K
Positive 	–	TN6025 160–1150	N
Positive 	TN6010 65–400	TN6025 35–330	S

INDUSTRY

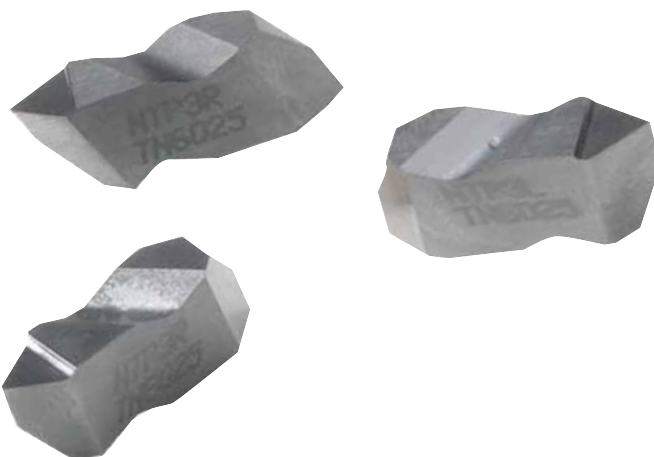

Threading Selection Guide

Step 1 • Select Threading Method and Hand of Tooling

Required Information:

- External/internal operation.
- Spindle rotation/hand of thread.
- Feed direction.



Feed direction toward the chuck • RECOMMENDED

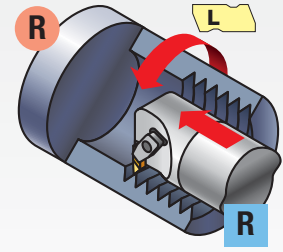
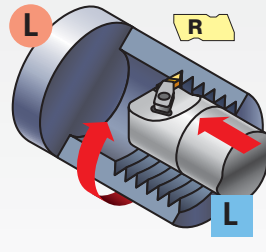
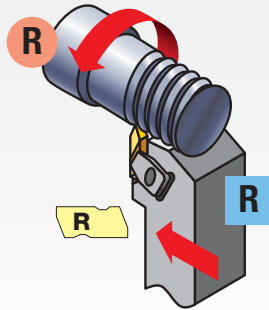
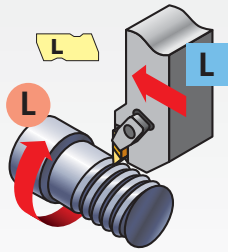

Feed direction away from the chuck

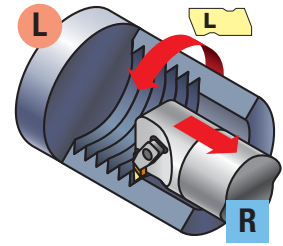
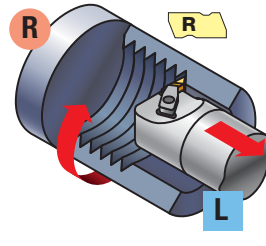
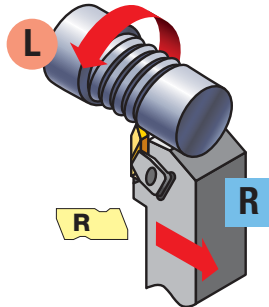
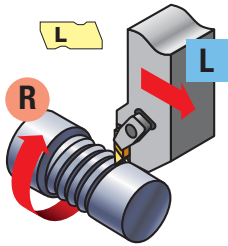

Step 2 • Select Holder from Catalog Page

The insert size must match the gage insert size of your toolholder selection:

Required Information:

- External/internal operation.
- Minimum bore diameter (for internal operations).
- Hand of tool.
- Insert size (gage insert).

catalogue number	gage insert
NSR-163D	N.3R
NSR-164D	N.4R

NOTE: TopThread toolholders and boring bars are listed with a gage insert to indicate the size and hand required. They are compatible with both grooving and threading inserts of the same size.

Select the appropriate holder for the insert size and hand:

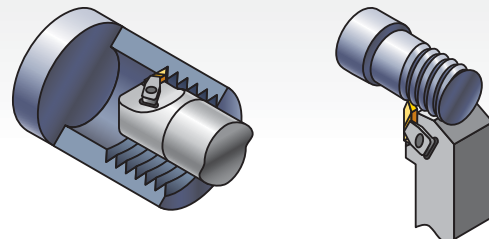

NOTE: Optimize your threading operation by using the proper infeed method and the recommended infeed values.

See the Technical section on pages E502–E503 of this catalog.

For internal threading, minimum bore varies depending on thread type. See page E418 for details.

Threading Selection Guide



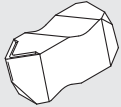

Step 3 • Choose Insert for Application

- See threading insert overview on page E434.
- Select cresting inserts for fully controlled thread form including diameter control. Cresting inserts eliminate the need for deburring.
- Non-cresting partial profile inserts can cut a variety of thread pitches.
- Note insert size for toolholder selection.

	insert size	catalog number	TN6025	TN6010
	2	NT-2RK	•	•
	3	NT-3RK	•	•
	4	NT-4RK	•	•

Step 4 • Select Grade and Speed

Recommendations for Grade and Speed Selection — m/min (SFM)

workpiece material	steel	stainless steel	cast iron	non-ferrous metals	high-temp alloys
insert style	chip control or neutral 	chip control or positive 	neutral 	positive 	positive 
optimum cutting conditions	TN6010 160–750	TN6010 160–600	TN6010 230–700	–	TN6010 65–400
first choice	TN6025 130–650	TN6025 130–450	TN6025 200–475	TN6025 160–1150	TN6025 35–330

Examples:

Chip Control: NT-K or NT-CK (partial profile only)

Neutral: NT, NT-C, NTF, NTC, NJ, NJF, NDC-V, NA, NDC, NTB-A/B

Positive: NTP, NTK, NJP, NJK

TopThread Threading Example:

application: 8 TPI Acme internal right-hand thread

material: alloy steel

workpiece diameter: 114,3mm
good cutting conditions
feed towards the chuck

Recommendation:

insert: NA3L8

grade: TN6010

insert size: 3

boring bar: A40NER3

gage insert: N.3L





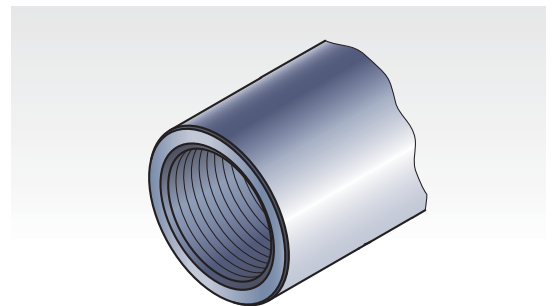





speed: 150 m/min

infeed passes*: 12 passes

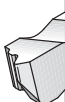

* Infeed recommendations provided in technical data section on pages E502–E503.

Insert Overview

chip control — K		style			thread profile	standard	tolerance class	cresting	application	page(s)
		neutral	positive							
NT-K		NT		NTP	Partial Profile 60°	–	–	N	General use for 60° thread forms, such as ISO and UN, where non-cresting inserts are desired to cut a variety of pitches.	E438–E441
NT-CK					Partial Profile 60° — coarse pitch	–	–	N	Coarse pitch 60° thread forms, such as ISO and UN, where non-cresting inserts are desired to cut a variety of pitches.	E442
		NTF		NTK	Partial Profile 60° — fine pitch	–	–	N	Fine pitch 60° thread forms, such as ISO and UN, where non-cresting inserts are desired to cut a variety of pitches — able to thread close to shoulders.	E442–E443
		NTC			American UN	ANSI B1.1:74	2A/2B	Y	Widely used inch-based 60° V-form for all industries.	E444
				NJP	UNJ	SAEA588791	3A/3B	N	Controlled root radius on external threads for military and aerospace industries.	E445
				NJK	UNJ — fine pitch	SAEA588790	3A/3B	N	Controlled root radius on external threads for military and aerospace industries — able to thread close to shoulders.	E445
		NDC-V			NPT	ANSI/ACME B1.201:1983	Standard NPT	Y	National Pipe Thread standard forms for pipe fittings.	custom solution
		NDC-V-M			NPT — multi-tooth	ANSI/ACME B1.201:1983	Standard NPT	Y	High-productivity multi-tooth threading inserts for NPT threads.	custom solution
		NWC-E			Whitworth, BSW, BSP	BS 84:1956, ISO 228/1:1982, DIN 259	Medium Class A	Y	Widely used 55° form for gas and water connections.	E446
		NDC-RD			API Round	API STD. 5B:1979	Standard API RD	Y	60° V-form with large radius for casing, tubing, and line pipe in the oil and gas industry, including 8 and 10 round forms.	E446
		NA			Acme	ANSI B1.5:1988	3G	N	29° truncated thread form for motion applications in a wide variety of industries.	E447
		NAS			Stub Acme	ANSI B1.8:1988	2G	N	Shallow depth 29° truncated thread form for motion applications in a wide variety of industries.	E448
		NTB-B			American Buttress — 45° clearance flank leading (Pull)	ANSI B1.9:1973	Class 2	N	Sawtooth form for axial load bearing applications in a variety of industries — use the “B” style when the 45° clearance flank is the leading flank.	E448

Grades and Grade Descriptions

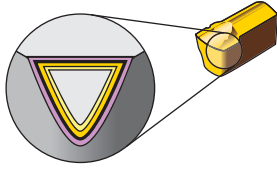

Coatings provide high-speed capability and are engineered for finishing to light roughing.

- Reduce cycle times — high-speed capability.
- Longer tool life — new multilayer coating provides better wear resistance.

P	Steel
M	Stainless Steel
K	Cast Iron
N	Non-Ferrous
S	High-Temp Alloys
H	Hardened Materials

wear resistance ← → toughness



Grade	Coating	Grade Description																				
				05	10	15	20	25	30	35	40	45										
TN6010 HC-P10		An advanced PVD TiAlN coating over a very deformation-resistant unalloyed carbide substrate. TN6010 is ideal for finishing to general machining of most workpiece materials at higher speeds. Excellent for machining most steels, stainless steels, cast irons, non-ferrous materials, and super alloys under stable conditions. It also performs well machining hardened and short chipping materials.	P																			
			M																			
			K																			
			N																			
			S																			
			H																			
TN6025 HC-P25		An advanced PVD TiAlN-coated grade with a tough, ultra-fine-grain unalloyed substrate. For general-purpose machining of most steels, stainless steels, high-temp alloys, titanium, irons, and non-ferrous materials. Speeds may vary from low to medium and will handle interruptions and high feed rates.	P																			
			M																			
			K																			
			N																			
			S																			
THM HW-K15		Uncoated carbide for light and medium machining. For cast iron, all non-ferrous metals, and non-metals. Also capable of machining hardened materials at low cutting speeds.																				
			K																			
			N																			
			S																			

- All TopThread inserts are precision-ground to provide accurate edge location and secure locking of the insert in the toolholder pocket.
- TopThread inserts can be used in either toolholders or boring bars.
- All non-cresting-type threading inserts can be used for either external or internal applications. All cresting-type inserts are designated specifically for external or internal use.
- Right-hand TopThread toolholders use right-hand inserts. Left-hand TopThread toolholders use left-hand inserts.

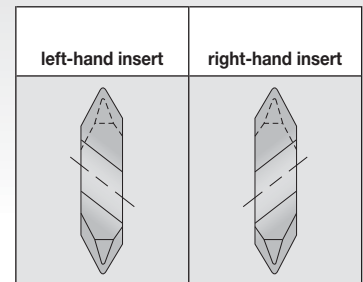
- Right-hand TopThread boring bars use left-hand inserts. Left-hand TopThread boring bars use right-hand inserts.
- See this page for carbide grade selection and more technical information.

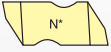
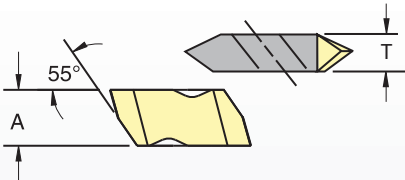

Catalog Numbering System

N	D	C	3	8RD	R	75																									
Type of Insert	Insert	Additional Information	Insert Size	Industry Thread Identification	Hand of Insert	Definition of Insert	Additional Information																								
<p>N – TopThread</p> 		<p>B – Buttress F – Fine pitch S – Stub Acme C – Cresting P – Positive rake K – Fine pitch, positive</p>		<p>Indicates API or drilling industry form designation (e.g., 10RD, 8RD, .038) or controlled root radius threading inserts indicate the root radius in .001" increments (NJ, NJF, NJP, NJK) or M indicates metric ISO thread</p>	<p>R – Right hand L – Left hand</p>																										
<p>A – Acme D – API or NPT J – UNJ thread T – 60° V thread W – 55° V Whitworth</p>				 <p>TopThread insert dimensions</p> <table border="1" data-bbox="448 1379 943 1697"> <thead> <tr> <th>insert size</th> <th>A mm</th> <th>T mm</th> </tr> </thead> <tbody> <tr><td>1</td><td>2,54</td><td>2,54</td></tr> <tr><td>2</td><td>5,56</td><td>3,81</td></tr> <tr><td>3</td><td>8,74</td><td>4,95</td></tr> <tr><td>4</td><td>11,51</td><td>6,48</td></tr> <tr><td>5</td><td>17,48</td><td>9,65</td></tr> <tr><td>6</td><td>11,51</td><td>9,73</td></tr> <tr><td>8</td><td>7,93</td><td>11,13</td></tr> </tbody> </table>	insert size	A mm	T mm	1	2,54	2,54	2	5,56	3,81	3	8,74	4,95	4	11,51	6,48	5	17,48	9,65	6	11,51	9,73	8	7,93	11,13	<ul style="list-style-type: none"> • Threads per inch or pitch (for metric) • "A" or "B" type Buttress insert • Taper per foot – API threads 		
insert size	A mm	T mm																													
1	2,54	2,54																													
2	5,56	3,81																													
3	8,74	4,95																													
4	11,51	6,48																													
5	17,48	9,65																													
6	11,51	9,73																													
8	7,93	11,13																													
					<p>I – Internal thread E – External thread (used only if internal and external thread forms are different) M – Multiple tooth K – Standard chip control C – Coarse pitch D – Dryseal</p>																										
							<p>NJF NDC-V-M NTC</p>  <p>NA NT NT-K</p> 																								

Recommended Cutting Speeds • Metric

Material Group		Cutting Speed – vc m/min								
		TN6010			TN6025			THM		
		min	Start	max	min	Start	max	min	Start	max
P	0/1	140	175	210	130	140	150	90	95	100
	2	115	145	175	110	145	175	75	100	125
	3	115	145	175	110	145	175	75	100	125
	4	75	100	120	75	95	115	55	65	80
	5	105	140	170	100	125	145	70	85	100
	6	45	60	75	40	55	65	30	40	45
M	1	90	115	140	60	75	90	60	75	90
	2	55	70	90	40	50	55	50	60	75
	3	60	80	95	40	50	60	40	50	55
K	1	120	150	180	60	80	90	70	90	100
	2	120	150	180	60	75	85	50	65	80
	3	110	140	170	60	75	90	60	70	80
N	1	600	750	900	600	750	900	600	750	900
	2	535	685	835	535	685	835	500	650	800
	3	230	300	370	230	300	370	600	750	900
	4	135	180	225	135	180	225	500	650	800
	5	70	90	110	70	90	110	230	300	370
	6	445	565	690	445	565	690	150	200	250
	7	550	700	850	550	700	850	150	200	250
S	1	35	40	50	25	35	40	25	35	45
	2	20	20	30	15	20	20	20	30	35
	3	60	70	80	40	60	70	15	25	30
	4	30	35	45	20	30	35	10	15	20
H	1	15	30	60	-	-	-	-	-	-
	2	15	30	60	-	-	-	-	-	-
	3	15	30	60	-	-	-	-	-	-
	4	15	30	60	-	-	-	-	-	-

INDEXABLE MILLING

SOLID END MILLING

HOLEMAKING

TAPPING

TURNING

Threading Inserts • NT-K

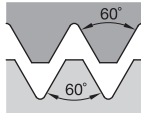
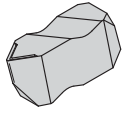

Partial Profile 60°

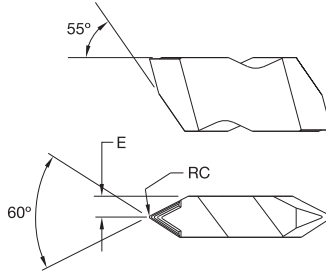

- first choice
- alternate choice

P	●	●	●	●
M	●	●	●	●
K	●	●	●	●
N	●	○	○	○
S	●	●	○	○
H	○	○	○	○

catalogue number	RC	E	SSC	external thread pitch mm	internal thread pitch mm	external TPI	internal TPI	TN6010	TN6025	THM
right hand										
NT2RK	0,10	1,90	2	0,70-3,0	1,25-3,5	8-36	7-20	3607651	3607837	●
NT4RK	0,16	3,24	4	1,25-6,25	2,0-6,25	4-20	4-12	3607846	3607846	●
NT3RK	0,17	2,49	3	1,25-4,0	2,0-5,0	6-20	5-12	3607643	3607824	●
left hand										
NT2LK	0,10	1,90	2	0,70-3,0	1,25-3,5	8-36	7-20	3607674	3607833	●
NT3LK	0,17	2,49	3	1,25-4,0	2,0-5,0	6-20	5-12	3607645	3607828	●

NOTE: SSC = To correspond with the SSC on the toolholder.

Threading Inserts • NT-K

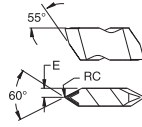
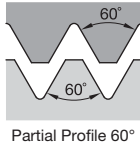
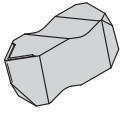

- first choice
- alternate choice

P	●	●	●	●
M	●	●	●	●
K	●	○	○	○
N	●	○	○	○
S	●	○	○	○
H	○	○	○	○

catalogue number	RC	E	SSC	external thread pitch mm	internal thread pitch mm	external TPI	internal TPI	TN6010	TN6025	THM
left hand										
NT2LK	0,10	1,90	2	0,70-3,0	1,25-3,5	8-36	7-20	3607674	3607833	—
right hand										
NT2RK	0,10	1,90	2	0,70-3,0	1,25-3,5	8-36	7-20	3607651	3607837	—
NT4RK	0,16	3,24	4	1,25-6,25	2,0-6,25	4-20	4-12	—	3607846	—
NT3RK	0,17	2,49	3	1,25-4,0	2,0-5,0	6-20	5-12	3607643	3607824	—
left hand										
NT3LK	0,17	2,49	3	1,25-4,0	2,0-5,0	6-20	5-12	3607645	3607828	—

NOTE: SSC = To correspond with the SSC on the toolholder.

Threading Inserts • NT-1L

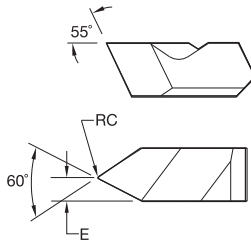
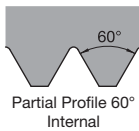
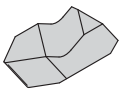

- first choice
- alternate choice

P	●	●	●	●
M	●	●	●	●
K	●	○	○	○
N	●	○	○	○
S	●	○	○	○
H	○	○	○	○

catalogue number	RC	E	SSC	external thread pitch mm	internal thread pitch mm	external TPI	internal TPI	TN6010	TN6025	THM
left hand										
NT1L	0,08	1,09	1	—	1,0-2,0	—	12-24	3636551	3636555	—

NOTE: SSC = To correspond with the SSC on the toolholder.

INDEXABLE MILLING

SOLID END MILLING

HOLEMAKING

TAPPING

TURNING

Threading Inserts • NT

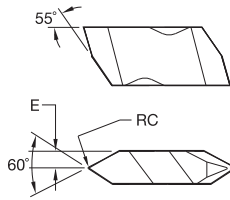
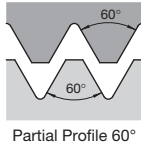
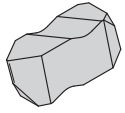

- first choice
- alternate choice

P	●	●	●	●
M	●	●	●	●
K	●	○	○	○
N	●	○	○	○
S	●	○	○	○
H	○	○	○	○

catalogue number	RC	E	SSC	external thread pitch mm	internal thread pitch mm	external TPI	internal TPI	TNG610	TNG625	THM
right hand										
NT2R	0,10	1,90	2	0,70-3,0	1,25-3,5	8-36	7-20	3607647	3607843	—
NT3R	0,17	2,49	3	1,25-4,0	2,0-5,0	6-20	5-12	3607530	3607825	—
NT4R	0,17	3,25	4	1,25-6,25	2,0-6,25	4-20	4-12	3607676	3607834	—
left hand										
NT2L	0,10	1,90	2	0,70-3,0	1,25-3,5	8-36	7-20	3607675	3607835	—
NT3L	0,17	2,49	3	1,25-4,0	2,0-5,0	6-20	5-12	3607532	3607826	—
NT4L	0,17	3,25	4	1,25-6,25	2,0-6,25	4-20	4-12	—	3607849	—

NOTE: SSC = To correspond with the SSC on the toolholder.

Threading Inserts • NTP

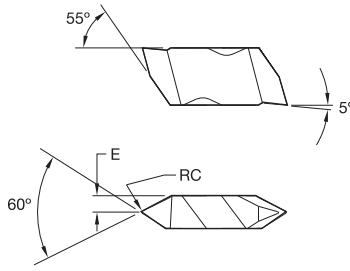
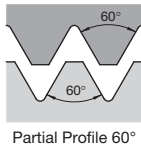
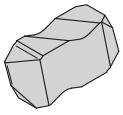

- first choice
- alternate choice

P	●	●	●	●
M	●	●	●	●
K	●	○	○	○
N	●	○	○	○
S	●	○	○	○
H	○	○	○	○

catalogue number	RC	E	SSC	external thread pitch mm	internal thread pitch mm	external TPI	internal TPI	TN6010	TN6025	THM
right hand										
NTP2R	0,10	1,91	2	0,70-3,0	1,25-3,5	8-36	7-20	3607677	3607841	—
NTP3R	0,17	2,49	3	1,25-4,0	2,0-5,0	6-20	5-12	3607644	3607823	—
NTP4R	0,17	3,25	4	1,25-6,25	2,0-6,25	4-20	4-12	—	3607839	—
left hand										
NTP2L	0,10	1,91	2	0,70-3,0	1,25-3,5	8-36	7-20	3607678	3607840	—
NTP3L	0,17	2,49	3	1,25-4,0	2,0-5,0	6-20	5-12	3607650	3607831	—

NOTE: SSC = To correspond with the SSC on the toolholder.

INDEXABLE MILLING

SOLID END MILLING

HOLEMAKING

TAPPING

TURNING

Threading Inserts • NT-CK

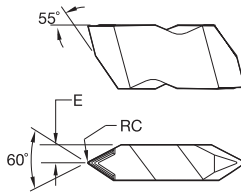
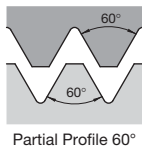
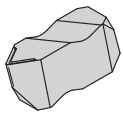

- first choice
- alternate choice

P	●	●	●	●
M	●	●	●	●
K	●	○	○	●
N	●	○	○	○
S	●	○	○	○
H	○	○	○	○

catalogue number	RC	E	SSC	external thread pitch mm	internal thread pitch mm	external TPI	internal TPI	TN6010	TN6025	THM
right hand										
NT3RCK	0,34	2,46	3	2,5-4,0	4,0	6-11	6	●	○	○

NOTE: SSC = To correspond with the SSC on the toolholder.

Threading Inserts • NTF

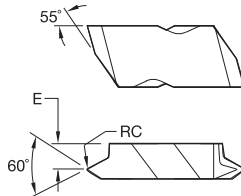
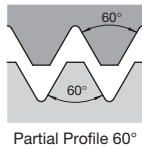
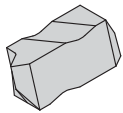

- first choice
- alternate choice

P	●	●	●	●
M	●	●	●	●
K	●	○	○	●
N	●	○	○	○
S	●	○	○	○
H	○	○	○	○

catalogue number	RC	E	SSC	external thread pitch mm	internal thread pitch mm	external TPI	internal TPI	TN6010	TN6025	THM
right hand										
NTF2R	0,08	2,79	2	0,60-1,75	1,0-2,0	14-44	12-24	○	○	○
NTF3R	0,08	3,58	3	0,60-2,5	1,0-2,5	10-44	9-24	○	○	○
left hand										
NTF3L	0,08	3,58	3	0,60-2,5	1,0-2,5	10-44	9-24	○	○	○

NOTE: SSC = To correspond with the SSC on the toolholder.

Threading Inserts • NTK

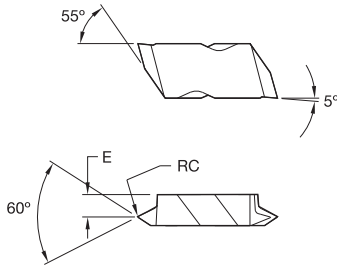
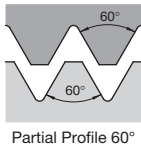
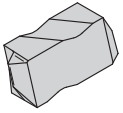

- first choice
- alternate choice

P	●	●	●
M	●	●	●
K	●	○	●
N	●	○	○
S	●	●	○
H	○	○	○

catalogue number	RC	E	SSC	external thread pitch mm	internal thread pitch mm	external TPI	internal TPI	TNG6010	TNG6025	THM
right hand										
NTK2R	0,08	2,79	2	0,60-1,75	1,0-2,0	14-44	12-24	3607646	3607836	1
NTK3R	0,08	3,58	3	0,60-2,50	1,0-2,5	10-44	9-24	3607528	3607827	1
left hand										
NTK3L	0,08	3,58	3	0,60-2,50	1,0-2,5	10-44	9-24	3607853		1

NOTE: SSC = To correspond with the SSC on the toolholder.

INDEXABLE MILLING

SOLID END MILLING

HOLEMAKING

TAPPING

TURNING

INDEXABLE MILLING

SOLID END MILLING

HOLEMAKING

TAPPING

TURNING

Threading Inserts • NTC-E

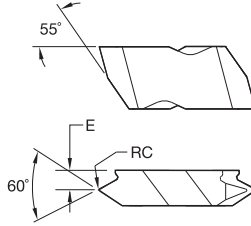
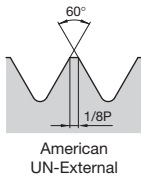
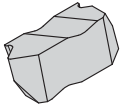

- first choice
- alternate choice

P	●	●	●	●
M	●	●	●	●
K	●	○	○	●
N	●	○	○	○
S	●	●	○	○
H	○	○	○	○

catalogue number	RC	E	SSC	external thread pitch mm	internal thread pitch mm	external TPI	internal TPI	TN6010	TN6025	THM
right hand										
NTC3R16E	0,19	3,76	3	—	—	16	—	—	3636557	—
NTC3R14E	0,22	3,76	3	—	—	14	—	3636554	—	—
NTC3R12E	0,25	3,76	3	—	—	12	—	3636549	3636562	—

NOTE: SSC = To correspond with the SSC on the toolholder.

Threading Inserts • NTC-I

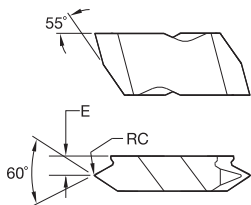
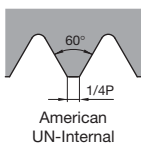
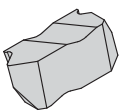

- first choice
- alternate choice

P	●	●	●	●
M	●	●	●	●
K	●	○	○	●
N	●	○	○	○
S	●	●	○	○
H	○	○	○	○

catalogue number	RC	E	SSC	external thread pitch mm	internal thread pitch mm	external TPI	internal TPI	TN6010	TN6025	THM
left hand										
NTC3L12I	0,10	3,76	3	—	—	—	12	—	3636556	—

NOTE: SSC = To correspond with the SSC on the toolholder.

Threading Inserts • NJP

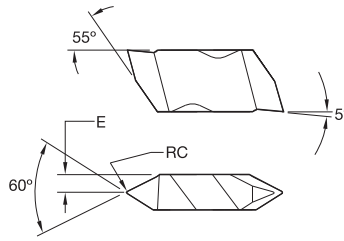
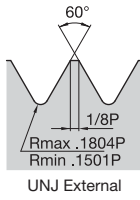
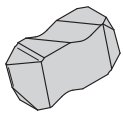

- first choice
- alternate choice

P	●	●	●	●
M	●	●	●	●
K	●	○	○	●
N	●	○	○	○
S	●	●	●	○
H	○	○	○	○

catalogue number	RC	E	SSC	external thread pitch mm	internal thread pitch mm	external TPI	internal TPI	TN6010	TN6025	THM
right hand										
NJP3014R12	0,33	2,49	3	—	—	12	—	—	3607850	—

NOTE: SSC = To correspond with the SSC on the toolholder.

Threading Inserts • NJK

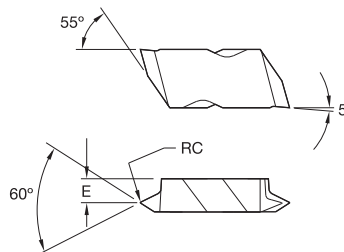
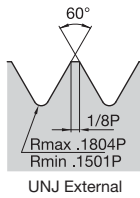
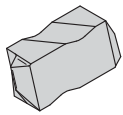

- first choice
- alternate choice

P	●	●	●	●
M	●	●	●	●
K	●	○	○	●
N	●	○	○	○
S	●	●	●	○
H	○	○	○	○

catalogue number	RC	E	SSC	external thread pitch mm	internal thread pitch mm	external TPI	internal TPI	TN6010	TN6025	THM
right hand										
NJK3008R20	0,20	3,58	3	—	—	20	—	3607648	—	—

NOTE: SSC = To correspond with the SSC on the toolholder.

INDEXABLE MILLING

SOLID END MILLING

HOLEMAKING

TAPPING

TURNING

Threading Inserts • NWC-E

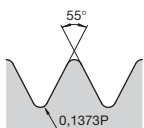
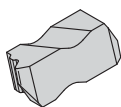

Whitworth BSW,
BSP-External

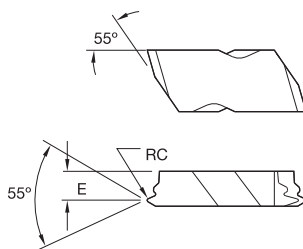

- first choice
- alternate choice

P	●	●	●	●
M	●	●	●	●
K	●	●	●	●
N	●	○	○	○
S	●	●	○	○
H	○	○	○	○

catalogue number	RC	E	SSC	TPI	TPF	TN6010	TN6025	THM
right hand								
NWC3R14E	0,24	3,43	3	14	—	●	○	○
NWC3R11E	0,30	3,43	3	11	—	○	○	○

NOTE: SSC = To correspond with the SSC on the toolholder.

Threading Inserts • NDC-RD

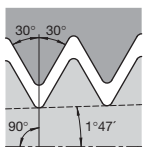
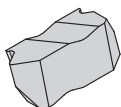

API Round

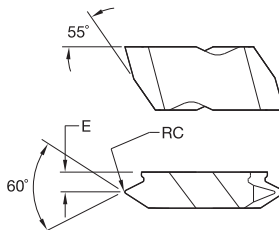

- first choice
- alternate choice

P	●	●	●	●
M	●	●	●	●
K	●	○	○	○
N	●	○	○	○
S	●	○	○	○
H	○	○	○	○

catalogue number	RC	E	SSC	TPI	TPF	TN6010	TN6025	THM
right hand								
NDC38RDR75	0,43	3,18	3	8	.750	○	○	○
left hand								
NDC310RDL75	0,36	3,18	3	10	.750	○	○	○
NDC38RDL75	0,43	3,18	3	8	.750	○	○	○

NOTE: SSC = To correspond with the SSC on the toolholder.

Threading Inserts • NA

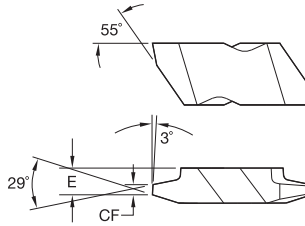
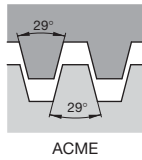
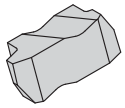

- first choice
- alternate choice

P	●	●	●	●
M	●	●	●	●
K	●	○	○	○
N	●	○	○	○
S	●	○	○	○
H	○	○	○	○

catalogue number	CF	E	SSC	TPI	TN6010	TN6025	THM
right hand							
NA3R8	1,04	3,79	3	8	●	●	●
NA3R6	1,44	3,79	3	6	○	○	○
NA3R4	2,22	3,38	3	4	○	○	○
NA4R4	2,22	5,13	4	4	○	○	○
NA6R3	3,01	7,19	6	3	○	○	○
NA6R2	4,58	7,19	6	2	○	○	○
left hand							
NA3L8	1,04	3,79	3	8	○	○	○
NA3L6	1,44	3,79	3	6	○	○	○
NA3L4	2,22	3,38	3	4	○	○	○
NA4L4	2,22	5,13	4	4	○	○	○
NA6L3	3,01	7,19	6	3	○	○	○
NA6L2	4,58	7,19	6	2	○	○	○

NOTE: SSC = To correspond with the SSC on the toolholder.

INDEXABLE MILLING

SOLID END MILLING

HOLE/MAKING

TAPPING

TURNING

Threading Inserts • NAS

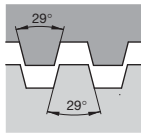
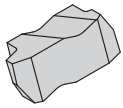

Stub ACME

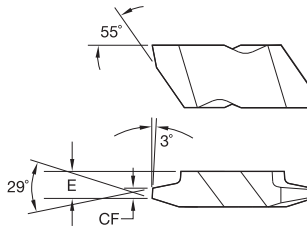

- first choice
- alternate choice

P	●	●	●	●
M	●	●	●	●
K	●	●	●	●
N	●	●	●	●
S	●	●	●	●
H	○	○	○	○

catalogue number	CF	E	SSC	TPI	TN6010	TN6025	THM
right hand							
NAS3R8	1,21	3,79	3	8	●	●	●
left hand							
NAS3L8	1,21	3,79	3	8	○	○	○
NAS3L6	1,66	3,79	3	6	○	○	○

NOTE: SSC = To correspond with the SSC on the toolholder.

Threading Inserts • NTB-B

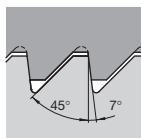
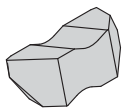

American Buttress-Pull

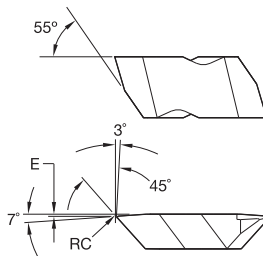

- first choice
- alternate choice

P	●	●	●	●
M	●	●	●	●
K	●	●	●	●
N	●	●	●	●
S	●	●	●	●
H	○	○	○	○

catalogue number	RC	E	SSC	TPI	TPF	TN6010	TN6025	THM
left hand								
NTB3LB	0,17	0,31	3	8-16	—	○	○	○

NOTE: SSC = To correspond with the SSC on the toolholder.

Threading Inserts • NTU

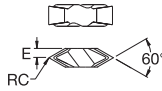
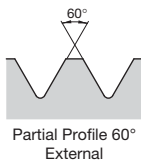
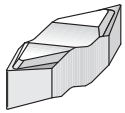

- first choice
- alternate choice

P	●	●	●	●
M	●	●	●	●
K	●	○	○	●
N	●	○	○	○
S	●	●	●	○
H	○	○	○	○

catalogue number	RC	E	SSC	external thread pitch mm	internal thread pitch mm	external TPI	internal TPI	TN6010	TN6025	THM
right hand										
NTU4R	0,11	3,18	4U	1,25-6,25	—	4-20	—	—	3811640	—

NOTE: SSC = To correspond with the SSC on the toolholder.

INDEXABLE MILLING

SOLID END MILLING

HOLEMAKING

TAPPING

TURNING

Integral Toolholders • NS • Metric

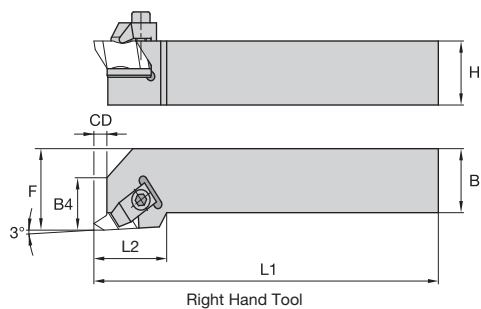
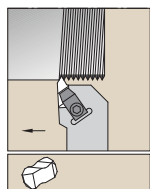

order number	catalogue number	SSC	H	B	F	L1	L2	B4	CD	gage insert
right hand										
3632147	NSR062	2	10	10	14	64	19	9	3,5	N.2R
3641660	NSR1212F2	2	12	12	16	80	19	9	3,5	N.2R
3639035	NSR082V	2	13	13	19	89	19	9	3,5	N.2R
3636542	NSR1616H2	2	16	16	20	100	19	9	3,5	N.2R
3639026	NSR122B	2	19	19	25	114	19	9	3,5	N.2R
3638589	NSR2020K2	2	20	20	25	125	19	9	3,5	N.2R
3638590	NSR2525M2	2	25	25	32	150	19	9	3,5	N.2R
3639025	NSR162C	2	25	25	32	127	19	9	3,5	N.2R
3639027	NSR123A	3	19	19	25	102	32	13	5,3	N.3R
3639023	NSR123B	3	19	19	25	114	32	13	5,3	N.3R
3638588	NSR2020K3	3	20	20	25	125	32	13	5,3	N.3R
3636536	NSR2525M3	3	25	25	32	150	32	13	5,3	N.3R
3638592	NSR163C	3	25	25	32	127	32	13	5,3	N.3R
3638591	NSR163D	3	25	25	32	152	32	13	5,3	N.3R
3639028	NSR203D	3	32	32	38	152	32	13	5,3	N.3R
3641666	NSR3232P3	3	32	32	40	170	32	13	5,3	N.3R
3636540	NSR2525M4	4	25	25	32	150	35	14	7,5	N.4R
3641669	NSR3232P4	4	32	32	40	170	35	14	7,5	N.4R
left hand										
3632145	NSL122B	2	19	19	25	114	19	9	3,5	N.2L
3639045	NSL2020K2	2	20	20	25	125	19	9	3,5	N.2L
3639047	NSL2525M2	2	25	25	32	150	19	9	3,5	N.2L
3632138	NSL162C	2	25	25	32	127	19	9	3,5	N.2L
3632152	NSL123A	3	19	19	25	102	32	13	5,3	N.3L
3639032	NSL123B	3	19	19	25	114	32	13	5,3	N.3L
3639046	NSL2020K3	3	20	20	32	125	32	13	5,3	N.3L
3636539	NSL2525M3	3	25	25	32	150	32	13	5,3	N.3L
3639029	NSL163C	3	25	25	32	127	32	13	5,3	N.3L
3639024	NSL163D	3	25	25	32	152	32	13	5,3	N.3L
3639037	NSL203D	3	32	32	38	152	32	13	5,3	N.3L
3636544	NSL2525M4	4	25	25	32	150	35	14	7,5	N.4L

NOTE: F dimension measured over sharp point of insert.

Integral Toolholders • NAS • Metric

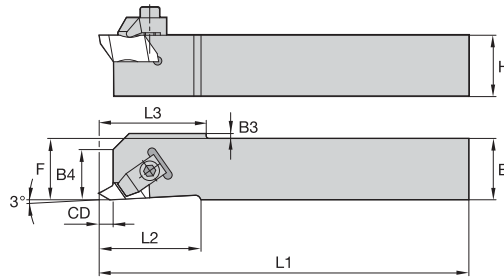
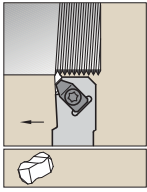

order number	catalogue number	SSC	H	B	F	L1	L2	B4	CD	gage insert
right hand										
3641662	NASR1212M2Q	2	12	12	12	150	19	9	3,5	N.2R
3639048	NASR1616K3Q	3	16	16	16	125	32	12	5,3	N.3R

NOTE: F dimension measured over sharp point of insert.

INDEXABLE MILLING

SOLID END MILLING

HOLEMAKING

TAPPING

TURNING

NAS

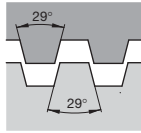
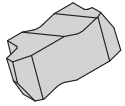

Stub ACME

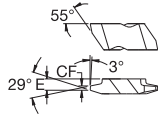

- first choice
- alternate choice

P	●	●	●	●
M	●	●	●	●
K	●	○	○	○
N	●	○	○	○
S	●	●	●	○
H	○	○	○	○

catalogue number	CF	E	SSC	TPI	TN6010	TN6025	THM
right hand							
NAS3R8	1,21	3,79	—	8	●	●	●
left hand							
NAS3L8	1,21	3,79	—	8	○	○	○
NAS3L6	1,66	3,79	—	6	○	○	○

NOTE: SSC = To correspond with the SSC on the toolholder.

INDEXABLE MILLING





SOLID END MILLING

HOLEMAKING

TAPPING

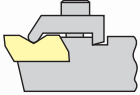
TURNING

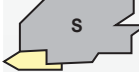
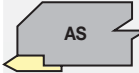
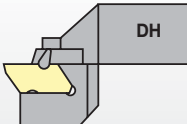
TopThread Holder • Catalog Numbering System

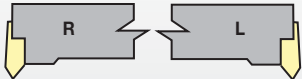
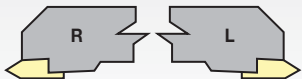
N	S	R	Drop Head	2525	M	4	Qualified Holder																																																														
<p>Insert Holding Method</p>	<p>Insert Mounting Location</p>	<p>Hand of Tool</p>	<p>Drop Head</p>	<p>Shank Size</p>	<p>Tool Length</p>	<p>Insert Size</p>	<p>Qualified Holder</p>																																																														
<p>N – TopThread</p> 	<p>End mount</p>  <p>Side mount, offset</p>  <p>Side mount, no offset</p> 	<p>Hand of Tool</p>	<p>Drop Head</p> 	<p>Shank height and width in mm and holder</p>	<table border="1"> <thead> <tr> <th>L1</th> <th>ISO</th> </tr> </thead> <tbody> <tr><td>32</td><td>A</td></tr> <tr><td>40</td><td>B</td></tr> <tr><td>50</td><td>C</td></tr> <tr><td>60</td><td>D</td></tr> <tr><td>70</td><td>E</td></tr> <tr><td>80</td><td>F</td></tr> <tr><td>90</td><td>G</td></tr> <tr><td>100</td><td>H</td></tr> <tr><td>110</td><td>J</td></tr> <tr><td>125</td><td>K</td></tr> <tr><td>140</td><td>L</td></tr> <tr><td>150</td><td>M</td></tr> <tr><td>160</td><td>N</td></tr> <tr><td>170</td><td>P</td></tr> <tr><td>180</td><td>Q</td></tr> <tr><td>200</td><td>R</td></tr> <tr><td>250</td><td>S</td></tr> <tr><td>300</td><td>T</td></tr> <tr><td>350</td><td>U</td></tr> <tr><td>400</td><td>V</td></tr> <tr><td>450</td><td>W</td></tr> <tr><td>500</td><td>Y</td></tr> <tr><td>special length</td><td>x</td></tr> </tbody> </table>	L1	ISO	32	A	40	B	50	C	60	D	70	E	80	F	90	G	100	H	110	J	125	K	140	L	150	M	160	N	170	P	180	Q	200	R	250	S	300	T	350	U	400	V	450	W	500	Y	special length	x	<p>W1</p>  <table border="1"> <thead> <tr> <th>insert size</th> <th>W1</th> </tr> </thead> <tbody> <tr><td>2</td><td>3,81</td></tr> <tr><td>3</td><td>4,95</td></tr> <tr><td>4</td><td>6,98</td></tr> <tr><td>5</td><td>9,65</td></tr> <tr><td>6</td><td>9,73</td></tr> <tr><td>8</td><td>11,13</td></tr> </tbody> </table>	insert size	W1	2	3,81	3	4,95	4	6,98	5	9,65	6	9,73	8	11,13	<p>Q – Qualified holder</p>
L1	ISO																																																																				
32	A																																																																				
40	B																																																																				
50	C																																																																				
60	D																																																																				
70	E																																																																				
80	F																																																																				
90	G																																																																				
100	H																																																																				
110	J																																																																				
125	K																																																																				
140	L																																																																				
150	M																																																																				
160	N																																																																				
170	P																																																																				
180	Q																																																																				
200	R																																																																				
250	S																																																																				
300	T																																																																				
350	U																																																																				
400	V																																																																				
450	W																																																																				
500	Y																																																																				
special length	x																																																																				
insert size	W1																																																																				
2	3,81																																																																				
3	4,95																																																																				
4	6,98																																																																				
5	9,65																																																																				
6	9,73																																																																				
8	11,13																																																																				
<p>End mount</p>  <p>Side mount</p> 																																																																					

INDEXABLE MILLING

SOLID END MILLING

HOLEMAKING

TAPPING

TURNING

TopThread Boring Bar • Catalog Numbering System







INDEXABLE MILLING

SOLID END MILLING

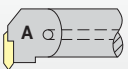
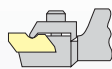
HOLEMAKING

TAPPING

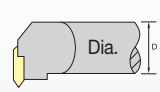
TURNING

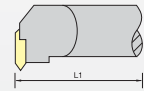
A	25	R	N	N	T	0	R	2														
Bar Type	Bar Diameter	Bar Length	Insert Holding Method	Insert Shape	Insert Location	Rake Angle 0 = 0°	Hand of Tool	Insert Size														
<p>Steel with coolant</p> 			<p>N – TopThread*</p> 		<p>End mount</p> 		<p>Right hand</p> 															
	<p>Bar in millimeters</p> 		*Proprietary standard only.		<p>Side mount</p> 		<p>Left hand</p> 	<table border="1"> <thead> <tr> <th>insert size</th> <th>W1</th> </tr> </thead> <tbody> <tr> <td>2</td> <td>3,81</td> </tr> <tr> <td>3</td> <td>4,95</td> </tr> <tr> <td>4</td> <td>6,98</td> </tr> <tr> <td>5</td> <td>9,65</td> </tr> <tr> <td>6</td> <td>9,73</td> </tr> <tr> <td>8</td> <td>11,13</td> </tr> </tbody> </table>	insert size	W1	2	3,81	3	4,95	4	6,98	5	9,65	6	9,73	8	11,13
insert size	W1																					
2	3,81																					
3	4,95																					
4	6,98																					
5	9,65																					
6	9,73																					
8	11,13																					
<p>Bars</p> <p>K = 125,0mm M = 150,0mm Q = 180,0mm R = 200,0mm S = 250,0mm T = 300,0mm U = 350,0mm</p> 																						

Integral Toolholders • NE • Metric

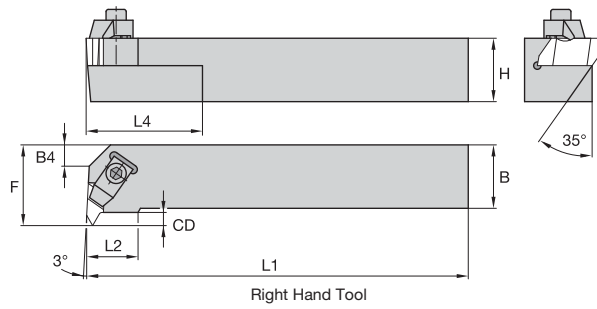
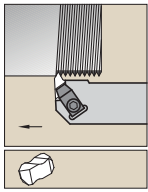

order number	catalogue number	SSC	H	B	F	L1	L2	B4	CD	gage insert
right hand										
3641658	NER2020K2	2	20	20	25	125	15	6	3,5	N.2L
3641665	NER2525M2	2	25	25	32	150	15	12	3,5	N.2L
3636541	NER2525M3	3	25	25	32	150	22	—	5,3	N.3L
3641672	NER2525M4	4	25	25	35	150	24	—	7,5	N.4L
left hand										
3641677	NEL2020K2	2	20	20	25	125	15	6	3,5	N.2R
3641676	NEL2525M2	2	25	25	32	150	15	12	3,5	N.2R
3636543	NEL2525M3	3	25	25	32	150	22	—	5,3	N.3R
3641668	NEL2525M4	4	25	25	35	150	24	—	7,5	N.4R

NOTE: F dimension measured over sharp point of insert.
SSC = To correspond with the SSC on the insert.

Integral Toolholders • NSU • Metric

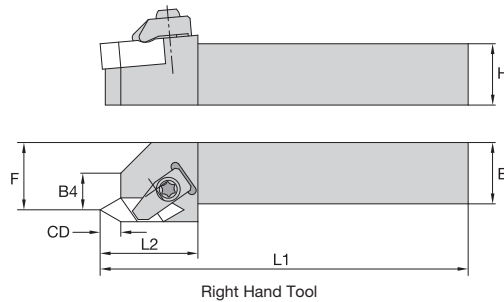
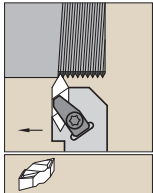

order number	catalogue number	H	B	F	L1	L2	B4	CD	gage insert
right hand									
3851387	NSUR2525M4D	25	25	28	150	32	13	6,1	NTU4R

NOTE: F dimension shown over N-style gage insert.
NSU toolholders only for NTU4 threading inserts.

Cutting Units • KM40TS • NE93° • Metric

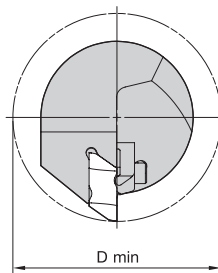
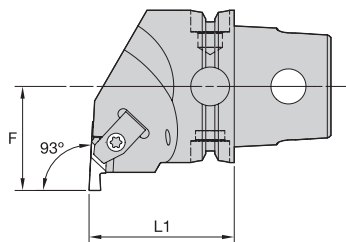

order number	catalogue number	L1		F		D min		gage insert	kg	lbs
		mm	in	mm	in	mm	in			
right hand										
3902285	KM40TSNER2	40	1.575	27	1.063	54	2.126	NG2L	0,30	.66
3902286	KM40TSNER3	40	1.575	27	1.063	54	2.126	NG3L	0,30	.67
3902287	KM40TSNER4	40	1.575	27	1.063	54	2.126	NG4L	0,30	.65
left hand										
3902132	KM40TSNEL2	40	1.575	27	1.063	54	2.126	NG2R	0,30	.66
3902283	KM40TSNEL3	40	1.575	27	1.063	54	2.126	NG3R	0,30	.67
3902284	KM40TSNEL4	40	1.575	27	1.063	54	2.126	NG4R	0,30	.65

Cutting Units • KM40TS • NS93° • Metric

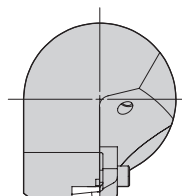
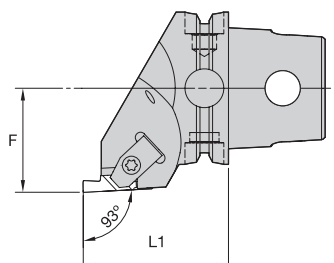

order number	catalogue number	L1		F		gage insert	kg	lbs
		mm	in	mm	in			
right hand								
3902293	KM40TSNSR2	40	1.575	27	1.063	NG2R	0,32	.70
3902294	KM40TSNSR3	47	1.850	27	1.063	NG3R	0,32	.71
3902295	KM40TSNSR4	47	1.850	27	1.063	NG4R	0,30	.66
left hand								
3902290	KM40TSNSL2	40	1.575	27	1.063	NG2L	0,32	.70
3902291	KM40TSNSL3	47	1.850	27	1.063	NG3L	0,33	.72
3902292	KM40TSNSL4	47	1.850	27	1.063	NG4L	0,30	.66

Integral I.D. Threading Boring Bars • A-NNT • Metric

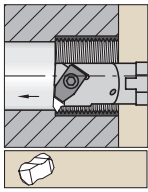

Steel shank with through coolant.

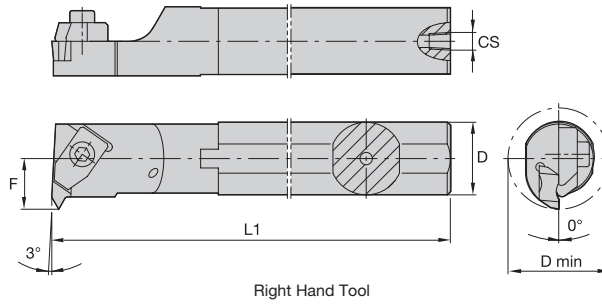

Right Hand Tool

order number	catalogue number	SSC	D	D min	L1	F	CS	gage insert
right hand								
3641644	A12MNNTOR2	2	12	18,5	150	11	1/16-27 NPT	NG2L
3641643	A16MNNTOR2	2	16	22,0	150	11	1/8-27 NPT	N.2L
3641645	A20QNNTOR2	2	20	26,0	180	13	1/8-27 NPT	N.2L
3641651	A25RNNTOR2	2	25	34,0	200	17	1/4-18 NPT	N.2L
3641622	A25RNNTOR3	3	25	34,0	200	17	1/4-18 NPT	N.3L
3641646	A32SNNTOR3	3	32	44,0	250	22	1/4-18 NPT	N.3L
3641653	A40TNNTOR3	3	40	54,0	300	27	1/4-18 NPT	N.3L
3641654	A40TNNTOR4	4	40	54,0	300	27	1/4-18 NPT	N.4L
left hand								
3641655	A12MNNTOL2	2	12	18,5	150	11	1/16-27 NPT	NG2R
3641649	A16MNNTOL2	2	16	22,0	150	11	1/8-27 NPT	N.2R
3641652	A20QNNTOL2	2	20	26,0	180	13	1/8-27 NPT	N.2R
3641657	A25RNNTOL2	2	25	34,0	200	17	1/4-18 NPT	N.2R
3641650	A25RNNTOL3	3	25	34,0	200	17	1/4-18 NPT	N.3R
3641656	A32SNNTOL3	3	32	44,0	250	22	1/4-18 NPT	N.3R
3641659	A40TNNTOL3	3	40	54,0	300	27	1/4-18 NPT	N.3R

NOTE: F dimension measured over sharp point of insert.
SSC = To correspond with the SSC on the insert.

Integral I.D. Threading Boring Bars • A-NNT-1 • Metric

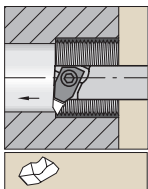

Necked steel shank with through coolant.

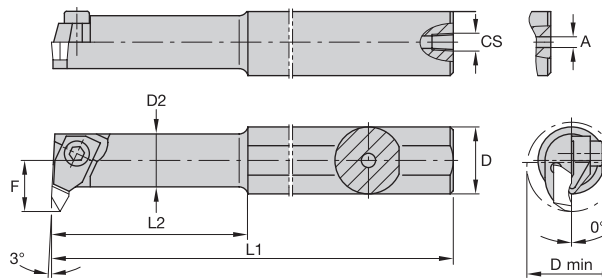

Right Hand Tool

order number	catalogue number	SSC	D	D min	D2	L1	L2	F	A	CS	gage insert
right hand											
3641647	A12MNNTOR1	1	12	11,5	8,7	150	31	7	4,0	1/16-27 NPT	N.1L
3641648	A10KNNTOR1	1	10	11,5	10,0	125	—	7	3,2	—	NG1L

NOTE: F dimension measured over sharp point of insert.
SSC = To correspond with the SSC on the insert.

Cutting Units • KM40TS • Steel • NE90° • Metric

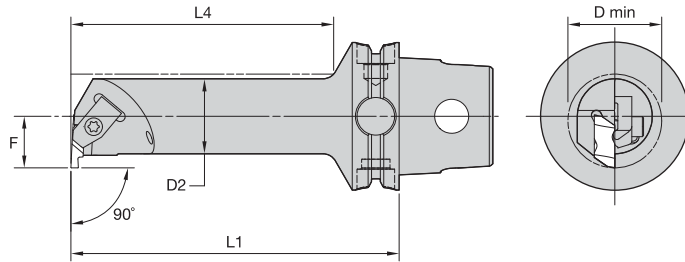

order number	catalogue number	D2		D min		F		L4		L1		gage insert	kg	lbs
		mm	in	mm	in	mm	in	mm	in	mm	in			
right hand														
3955481	KM40TSS12ENER2	12	.472	19	.73	11	.433	42	1.65	70	2.756	NG2L	0,27	.58
3955483	KM40TSS16FNER2	16	.630	20	.79	11	.433	56	2.21	80	3.150	NG2L	0,28	.62
3955485	KM40TSS20GNER2	20	.787	25	.98	13	.512	70	2.76	90	3.543	NG2L	0,35	.76
3955487	KM40TSS25ENER2	25	.984	32	1.26	17	.669	55	2.17	70	2.756	NG2L	0,34	.75
3955491	KM40TSS25ENER3	25	.984	34	1.34	17	.669	55	2.17	70	2.756	NG3L	0,35	.77
3955489	KM40TSS25HNER2	25	.984	32	1.26	17	.669	75	2.95	100	3.937	NG2L	0,49	1.08
3955493	KM40TSS25HNER3	25	.984	34	1.34	17	.669	75	2.95	100	3.937	NG3L	0,49	1.09
3955497	KM40TSS32GNER3	32	1.260	40	1.57	22	.866	76	2.99	90	3.543	NG3L	0,55	1.21
3955495	KM40TSS32JNER3	32	1.260	40	1.57	22	.866	96	3.78	110	4.331	NG3L	0,67	1.48
left hand														
3955480	KM40TSS12ENEL2	12	.472	19	.73	11	.433	42	1.65	70	2.756	NG2R	0,27	.59
3955482	KM40TSS16FNEL2	16	.630	20	.79	11	.433	56	2.21	80	3.150	NG2R	0,28	.62
3955484	KM40TSS20GNEL2	20	.787	25	.98	13	.512	70	2.76	90	3.543	NG2R	0,35	.76
3955486	KM40TSS25ENEL2	25	.984	32	1.26	17	.669	55	2.17	70	2.756	NG2R	0,34	.75
3955490	KM40TSS25ENEL3	25	.984	34	1.34	17	.669	55	2.17	70	2.756	NG3R	0,35	.77
3955488	KM40TSS25HNEL2	25	.984	32	1.26	17	.669	75	2.95	100	3.937	NG2R	0,49	1.08
3955492	KM40TSS25HNEL3	25	.984	34	1.34	17	.669	75	2.95	100	3.937	NG3R	0,49	1.09
3955496	KM40TSS32GNEL3	32	1.260	40	1.57	22	.866	76	2.99	90	3.543	NG3R	0,55	1.21
3955494	KM40TSS32JNEL3	32	1.260	40	1.57	22	.866	96	3.78	110	4.331	NG3R	0,67	1.48

Cutting Units • KM40TS • Carbide • NE90° • Metric

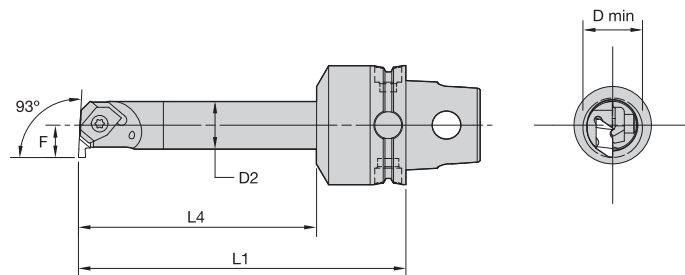

order number	catalogue number	D2		D min		F		L4		L1		gage insert	kg	lbs
		mm	in	mm	in	mm	in	mm	in	mm	in			
right hand														
3951836	KM40TSE16JNER2	16	.630	20	.79	11	.433	80	3.15	110	4.331	NG2L	0,41	.90
left hand														
3951835	KM40TSE16JNEL2	16	.630	20	.79	11	.433	80	3.15	110	4.331	NG2R	0,41	.90

INDEXABLE MILLING

SOLID END MILLING

HOLEMAKING

TAPPING

TURNING

The best solution for demanding threading applications



The WIDIA™ TopThread™ system is the best solution for demanding threading applications. With unmatched tooling technology, you can trust WIDIA TopThread tools for all of your threading and grooving needs.

- Large selection of insert geometries and grades.
- Rigid insert clamping design ensures the best tool life, surface finish, and workpiece quality.
- Ensures accurate, high-quality threads. Excellent for internal threading operations.

To learn more, contact your local Authorized Distributor or visit widia.com.

WIDIA 

Threading Custom Solutions

The WIDIA® high-performance carbide grades, coupled with our rigid TopThread clamping design, offer the metalworking industry optimum threading productivity.

When the large inventory of WIDIA standard products does not completely satisfy your productivity requirements, consider having TopThread inserts custom ground to meet your unique application needs.

The large variety of TopThread blank sizes allows maximum flexibility in threading endform design, especially for extra-wide or oil field applications.

Common examples of special forms are shown here. Please contact your local WIDIA representative for recommendations on satisfying your special threading needs.

Features and Benefits:

- Quotes are handled quickly and efficiently using state-of-the-art CAD design software and electronic database software.
- Our Carbide Custom Solutions Design Team is your link to one of the industry's largest electronic databases. They can solve your most challenging design problems.
- Where necessary or required, concept drawings are available to facilitate your engineering development.
- A large number of high-performance carbide grades are available to optimize your productivity. The option of producing standard insert styles in non-standard carbide grades allows you to optimize tool life performance.

style C2

RH shown

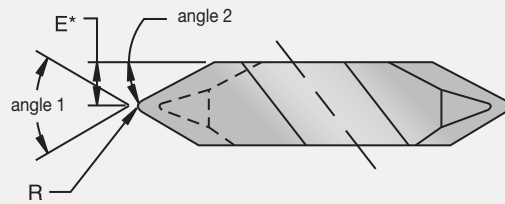

*to theoretical sharp point

style C3

RH shown

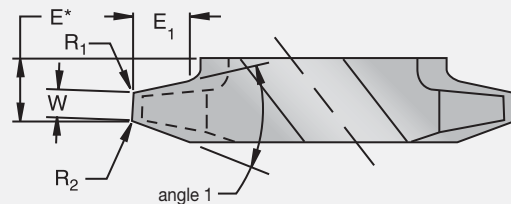

*to theoretical sharp point

style C4 (NTB-A)

RH shown

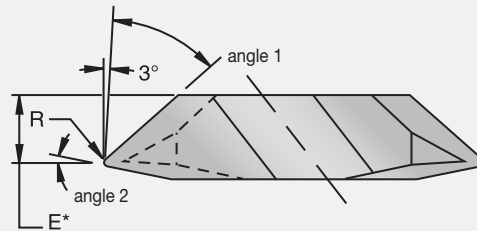

*to theoretical sharp point

style C5 (NTB-B)

RH shown

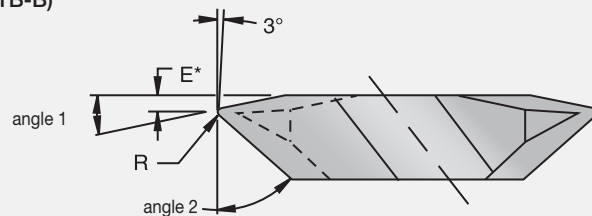

*to theoretical sharp point

style C6

RH shown

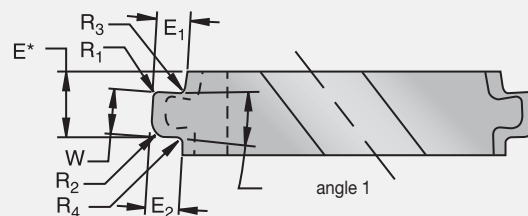





*to theoretical sharp point

NOTE: Right-hand inserts shown; left-hand inserts are also available.

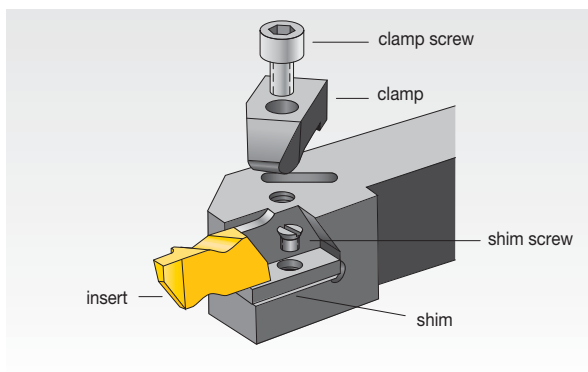
Hardware

TopThread and TopGroove Toolholders and Boring Bars



insert size and style	 clamp	 clamp screw	 shim	 shim screw
NG-1L	CM-109	S-304	-	-
NG-2R	CM-182	S-310	-	-
NG-2L	CM-183	S-310	-	-
NG-2R	CM-74	S-310	-	-
NG-2L	CM-75	S-310	-	-
NG-3R	CM-184	S-412	-	-
NG-3L	CM-185	S-412	-	-
NG-3R	CM-72	S-412	-	-
NG-3L	CM-73	S-412	-	-
NG-3R*	CM-78	S-412	-	-
NG-3L*	CM-70	S-412	-	-
NG-4R	CM-72	S-412	SM-420	SL-344
NG-4L	CM-73	S-412	SM-420	SL-344
NG-5R	CM-80	S-352	-	-
NG-5L	CM-81	S-352	-	-
NG-6R	CM-120	S-412	SM-416	S-111
NG-6L	CM-121	S-412	SM-416	S-111
NG-8R	CM-144	S-422	SM-419	S-112
NG-8L	CM-145	S-422	SM-419	S-112
NG-8R**	CM-144	S-422	SM-427	S-111
NG-8L**	CM-145	S-422	SM-427	S-111
TopGroove relief grooving				
NU-3125R	CM-72	S-412	-	-
NU-3125L	CM-73	S-412	-	-
NU-3125R**	CM-72	S-618	-	-
NU-3125L**	CM-73	S-618	-	-

*25mm diameter boring head.

**Boring head.

Laydown Threading

O.D, I.D. Threading

The Laydown Threading System offers an extensive range of inserts and toolholders, the ideal for all of threading requirements.

- Four insert sizes available to cover a wide range of thread-making operations.
- Ideal for high-helix/multi-start threads and single-point threading in small-diameter bores.
- Maximized tool life and low-profile design for unhindered chip flow and superior performance.
- Precision ground inserts to provide accurate thread forms and indexing.
- TN6025™ premium PVD TiAlN-coated grade outperforms conventional PVD grades.
- Partial- and full-profile insert options available for all common thread forms.



LAYDOWN THREADING

RELIABLE

With the WIDIA™ Laydown Threading System, you experience reliable countersunk screw locking for unhindered chip flow and precise insert positioning accuracy.

PRODUCTIVE

Laydown insert technology, with its wide range of available tools and inserts, guarantees increased tool life, minimized built-up edges, and precise cuts of most common materials.

EXTERNAL AND INTERNAL THREADING

INSERTS

FIRST CHOICE	INSERT STYLE	SPEED SELECTION — M/MIN	MATERIALS
TN6025	 Precision ground	40–200 (130–650)	P
		40–135 (130–450)	M
		60–145 (200–475)	K
		50–360 (160–1150)	N
		10–100 (35–330)	S

APPLICATIONS



THREADING



I.D. INTERNAL
THREADING

INDUSTRY



Insert Selection Guide

Step 1 • Select Threading Method and Hand of Tooling

Required Information:

- External/internal operation.
- Spindle rotation/hand of thread.
- Feed direction.



Feed direction toward the chuck • standard helix • RECOMMENDED

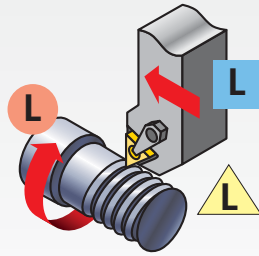

external left-hand thread

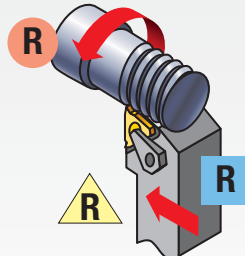

external right-hand thread

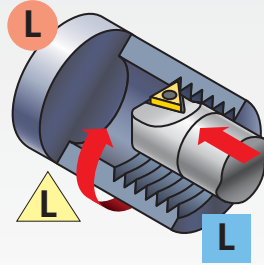

internal left-hand thread

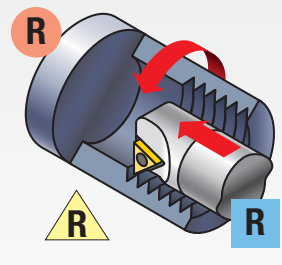

internal right-hand thread

Feed direction away from the chuck • reverse helix*

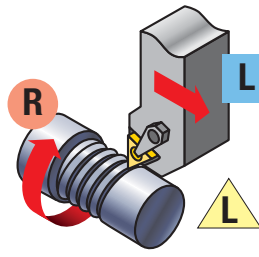

external right-hand thread

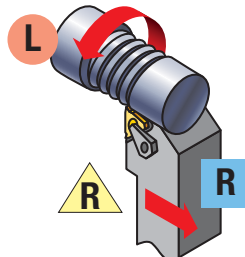

external left-hand thread

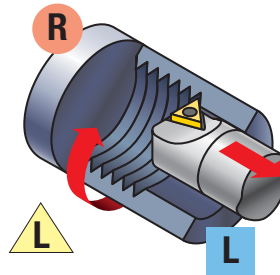

internal right-hand thread

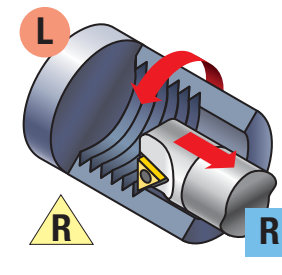

internal left-hand thread

*Negative shim required

Step 2 • Select Holder from Catalog Page

Required Information:

- External/internal operation.
- Minimum bore diameter (for internal operations).
- Hand of tool.
- Insert size (gage insert).

Select the appropriate holder for the insert size and hand:

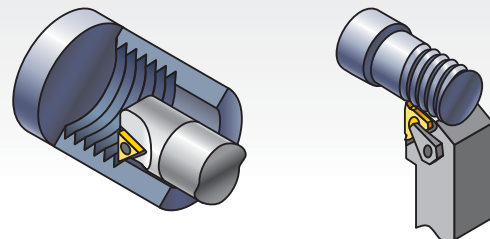

The insert size must match the gage insert size of your toolholder selection:

catalogue number	gage insert	minimum bore diameter	shim
S0812LSER2	2IRA60	16,5mm	—
S2020LSER3	3IR...	36,8mm	SM-Y13

Insert Selection Guide

Step 3 • Choose Insert for Application

- Select cresting inserts for fully controlled thread form including diameter.
- Cresting inserts eliminate the need for deburring and are optimized for the best tool life at that pitch.
- Non-cresting partial profile inserts offer the flexibility to cut a variety of thread pitches with one insert.
- Note insert size for toolholder selection.

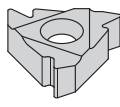
	insert size	catalogue number	TN6025
	11	2IRA60	•
	16	3IRAG60	•

See threading insert overview on page E466.

Step 4 • Select Appropriate Shim

Required Information:

- Thread form (TPI or pitch).
- Pitch diameter.
- Helix method (hand of tool, feed direction, hand of thread).
- Number of starts.

Select the proper shim: SMYE... for external RH or internal LH
SMYI... for internal RH or external LH

RH thread/RH tooling **LH thread/LH tooling**

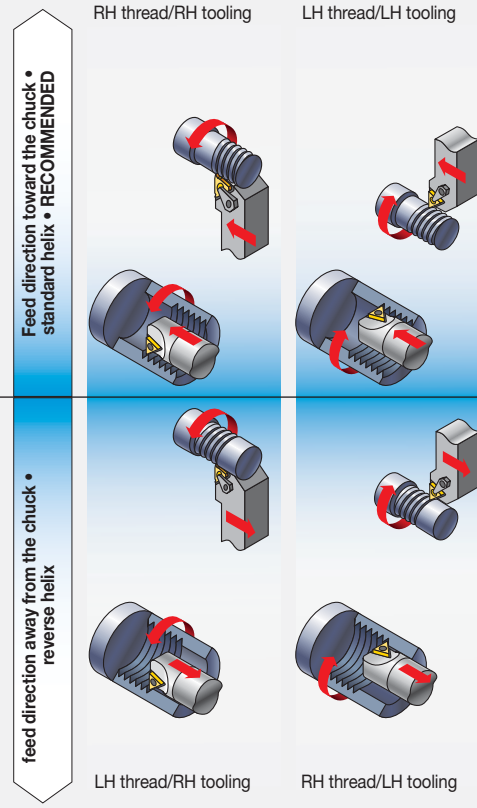

LH thread/RH tooling **RH thread/LH tooling**

Feed direction toward the chuck • standard helix • RECOMMENDED

Feed direction away from the chuck • reverse helix

insert size		external		internal		pitch diameter		pitch diameter (inch)	
standard	internal	SMYI 100-10	SMYI 100-20	SMYI 100-30	SMYI 100-40	SMYI 100-50	SMYI 100-60	SMYI 100-70	SMYI 100-80
11	16	SMYI 100-10	SMYI 100-20	SMYI 100-30	SMYI 100-40	SMYI 100-50	SMYI 100-60	SMYI 100-70	SMYI 100-80
11	16	SMYI 100-10	SMYI 100-20	SMYI 100-30	SMYI 100-40	SMYI 100-50	SMYI 100-60	SMYI 100-70	SMYI 100-80

If recommended shim is different from shim supplied with toolholder, order shim separately.



NOTE: Optimize your threading operation by using the proper infeed angle and the recommended infeed values. See the Technical Section on pages E502–E503. Also see detailed shim selection information on pages E514–E515.

Step 5 • Select Grade and Speed

Recommendations for Grade and Speed Selection — m/min (SFM)

workpiece material	steel	stainless steel	cast iron	non-ferrous metals	high-temp alloys
insert style	 precision ground				
first choice	TN6025 40–200 (130–650)	TN6025 40–135 (130–450)	TN6025 60–145 (200–475)	TN6025 50–360 (160–1150)	TN6025 10–100 (35–330)

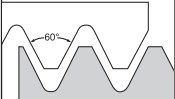
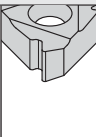
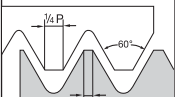
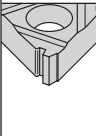
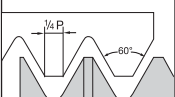
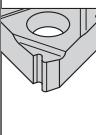
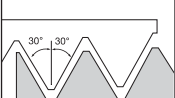
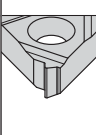
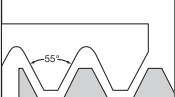
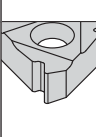
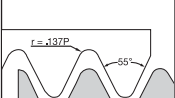
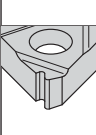
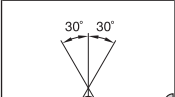
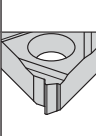
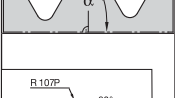
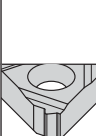
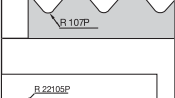
Insert Overview

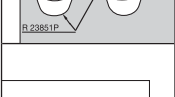
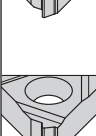
style	flat top	thread profile	standard	tolerance class	cresting	application	page(s)	
	60		Partial profile 60°	—	—	N	General use for 60° thread forms, such as ISO and UN, where non-cresting inserts are desired to cut a variety of pitches.	E470–E471
	ISO		Metric ISO	ISO R262, DIN 13	6g/6H	Y	Widely used metric 60° V-form for all industries.	E472–E475
	UN		American UN	ANSI B1.1:74	2A/2B	Y	Widely used inch-based 60° V-form for all industries.	E476–E477
	NPT		NPT	ANSI/ASME B1.20.1S1983	Standard NPT	N	National Pipe Thread standard 60° thread form for pipe fittings.	E478
	55		Partial profile 55°	—	—	N	General use for 55° thread forms such as Whitworth, BSW, and BSP where non-cresting inserts are desired to cut a variety of pitches.	E479–E489
	W		Whitworth, BSW, BSF, BSP	BS 84:1956, ISO 228/1:1982, DIN 259	Medium Class A	Y	Widely used 55° form for gas and water connections.	E481–E482
	API-RD		API round	API STD. 5B:1979	Standard API RD	Y	60° V-form with large radius for casing, tubing, and line pipe in the oil and gas industry, including 8 and 10 round forms.	custom solution
	PG		PG	DIN 404B0		Y	80° steel conduit thread.	custom solution
	RD		Round	DIN 405	7e/7H	Y	Round thread form for tube fittings in the chemical and food industries.	E482–E483
	TR		Trapez	DIN 103	7e/7H	N	30° truncated metric thread form for motion applications.	E484–E485

Grades and Grade Descriptions

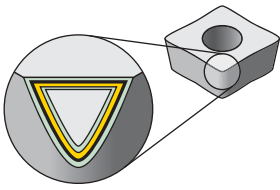

Coatings provide high-speed capability and are engineered for finishing to heavy roughing.

- Reduce cycle times — high speed capability.
- Longer tool life — new multilayer coating provides better wear resistance.

P	Steel
M	Stainless Steel
K	Cast Iron
N	Non-Ferrous
S	High-Temp Alloys
H	Hardened Materials

wear resistance ← → toughness

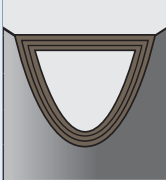
Grade	Coating	Grade Description	Performance Index											
			05	10	15	20	25	30	35	40	45			
TN6025	 HC-P25	PVD-TiAlN nano-multilayer coated carbide. General-purpose machining for steels, stainless steels, cast irons, non-ferrous materials, and difficult-to-machine materials. Recommended at low to medium cutting speeds when higher toughness is required.	P											
			M											
			K											
			N											
			S											

Laydown Threading Thread Form Guide

- All Laydown Threading inserts are precision ground to provide accurate thread forms and indexing.
- Both cresting and non-cresting partial profile inserts are specifically designed for either external or internal threading operations.
- Cresting inserts provide a fully controlled thread form, including major, minor, root, and crest for a given pitch. The need for deburring is eliminated and the inserts are optimized for the best tool life at that pitch.
- Non-cresting partial profile inserts offer the flexibility to cut a variety of thread pitches with one insert.
- Right-hand Laydown Threading toolholders use right-hand inserts. Left-hand Laydown Threading toolholders use left-hand inserts.
- Right-hand Laydown Threading boring bars use right-hand inserts. Left-hand Laydown Threading boring bars use left-hand inserts.

Catalog Numbering System

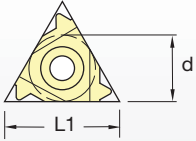
3	E	R	A	ISO																				
Insert Size	Insert Type	Hand of Insert	Thread Pitch	Thread Profile	Number of Teeth																			
	<p>E – External thread</p> <p>I – Internal thread</p>	<p>R – Right-hand thread</p> <p>L – Left-hand thread</p>			<p>Single tooth profile – No symbol</p> <p>Multi-tooth profile – Number of teeth (cutting edge and symbol)</p> <p>Multi-tooth profile with two teeth – 2M</p>																			
		Partial profile inserts																						
		<table border="1"> <thead> <tr> <th>symbol</th> <th>mm</th> </tr> </thead> <tbody> <tr> <td>A</td> <td>0,5–1,5</td> </tr> <tr> <td>AG</td> <td>0,5–3,0</td> </tr> <tr> <td>G</td> <td>1,7–3,0</td> </tr> <tr> <td>N</td> <td>3,5–5,0</td> </tr> <tr> <td>Q</td> <td>5,5–6,0</td> </tr> </tbody> </table>	symbol	mm	A	0,5–1,5	AG	0,5–3,0	G	1,7–3,0	N	3,5–5,0	Q	5,5–6,0										
symbol	mm																							
A	0,5–1,5																							
AG	0,5–3,0																							
G	1,7–3,0																							
N	3,5–5,0																							
Q	5,5–6,0																							
		Full profile inserts																						
		<table border="1"> <thead> <tr> <th>symbol</th> <th>mm</th> </tr> </thead> <tbody> <tr> <td>Actual TPI</td> <td>0,5–0,4</td> </tr> </tbody> </table>	symbol	mm	Actual TPI	0,5–0,4																		
symbol	mm																							
Actual TPI	0,5–0,4																							
				<table border="1"> <tbody> <tr> <td>55</td> <td>Partial Profile 55°</td> </tr> <tr> <td>60</td> <td>Partial Profile 60°</td> </tr> <tr> <td>ISO</td> <td>ISO Metric 60°</td> </tr> <tr> <td>TR</td> <td>Trapez DIN 103°</td> </tr> <tr> <td>UN</td> <td>ISO Inch/American UN 60°</td> </tr> <tr> <td>W</td> <td>Whitworth 55°</td> </tr> <tr> <td>NPT</td> <td>American National Pipe Thread 60°</td> </tr> <tr> <td>RD</td> <td>Round</td> </tr> <tr> <td>PG</td> <td>Steel Conduit</td> </tr> <tr> <td>APIRD</td> <td>API Round</td> </tr> </tbody> </table>	55	Partial Profile 55°	60	Partial Profile 60°	ISO	ISO Metric 60°	TR	Trapez DIN 103°	UN	ISO Inch/American UN 60°	W	Whitworth 55°	NPT	American National Pipe Thread 60°	RD	Round	PG	Steel Conduit	APIRD	API Round
55	Partial Profile 55°																							
60	Partial Profile 60°																							
ISO	ISO Metric 60°																							
TR	Trapez DIN 103°																							
UN	ISO Inch/American UN 60°																							
W	Whitworth 55°																							
NPT	American National Pipe Thread 60°																							
RD	Round																							
PG	Steel Conduit																							
APIRD	API Round																							
	 <table border="1"> <thead> <tr> <th>symbol</th> <th>d</th> <th>L1</th> </tr> </thead> <tbody> <tr> <td>2</td> <td>0.250</td> <td>11</td> </tr> <tr> <td>3</td> <td>0.375</td> <td>16</td> </tr> <tr> <td>4</td> <td>0.500</td> <td>22</td> </tr> <tr> <td>5</td> <td>0.625</td> <td>27</td> </tr> </tbody> </table>	symbol	d	L1	2	0.250	11	3	0.375	16	4	0.500	22	5	0.625	27								
symbol	d	L1																						
2	0.250	11																						
3	0.375	16																						
4	0.500	22																						
5	0.625	27																						

Recommended Cutting Speeds • Metric

		Cutting Speed — vc m/min		
		TN6025		
	Material Group	min	Start	max
P	0/1	130	140	150
	2	110	145	175
	3	110	145	175
	4	75	95	115
	5	100	125	145
	6	40	55	65
M	1	60	75	90
	2	40	50	55
	3	40	50	60
K	1	60	80	90
	2	60	75	85
	3	60	75	90
N	1	600	750	900
	2	535	685	835
	3	230	300	370
	4	135	180	225
	5	70	90	110
	6	445	565	690
	7	550	700	850
S	1	25	35	40
	2	15	20	20
	3	40	60	70
	4	20	30	35

INDEXABLE MILLING

SOLID END MILLING

HOLEMAKING

TAPPING

TURNING

Threading Inserts • ER/L-60

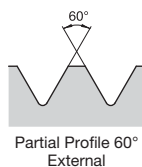
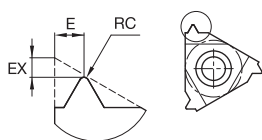
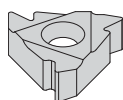

- first choice
- alternate choice

P	■	●
M	■	●
K	■	○
N	■	○
S	■	●
H	■	○

catalogue number	RC	EX	E	SSC	thread pitch mm	TPI	TPF	TNG025
right hand								
3ERA60	0,05	0,8	0,9	3	0,50-1,50	16-48	—	2018214
2ERA60	0,05	0,9	0,8	2	0,50-1,50	16-48	—	2007404
3ERAG60	0,08	1,2	1,7	3	0,50-3,0	8-48	—	2018246
3ERG60	0,28	1,2	1,7	3	1,75-3,0	8-14	—	2018222
4ERN60	0,53	1,7	2,5	4	3,5-5,0	5-7	—	2018252
left hand								
3ELAG60	0,08	1,2	1,7	3	0,50-3,0	8-48	—	2071904

NOTE: SSC = To correspond with the SSC on the toolholder.

Threading Inserts • IR/L-60

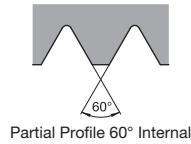
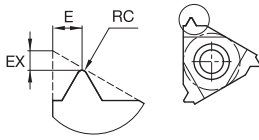
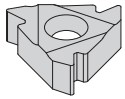

- first choice
- alternate choice

P	●
M	●
K	○
N	○
S	●
H	○

catalogue number	RC	EX	E	SSC	thread pitch mm	TPI	TPF	TN
right hand								
2IRA60	0,05	0,8	0,9	2	0,50-1,50	16-48	—	2018262
3IRA60	0,05	0,8	0,9	3	0,50-1,50	16-48	—	2018272
3IRAG60	0,05	1,2	1,7	3	0,50-3,0	8-48	—	2018284
3IRG60	0,15	1,2	1,7	3	1,75-3,0	8-14	—	2018278
5IRQ60	0,30	1,8	2,7	5	5,5-6,0	4-4,5	—	2018295
4IRN60	0,31	1,7	2,5	4	3,5-5,0	5-7	—	2018290
left hand								
2ILA60	0,05	0,8	0,9	2	0,50-1,50	16-48	—	2021656
3ILAG60	0,05	1,2	1,7	3	0,50-3,0	8-48	—	2008275
4ILN60	0,31	1,7	2,5	4	3,5-5,0	5-7	—	2100489

NOTE: SSC = To correspond with the SSC on the toolholder.

INDEXABLE MILLING

SOLID END MILLING

HOLEMAKING

TAPPING

TURNING

INDEXABLE MILLING

SOLID END MILLING

HOLEMAKING

TAPPING

TURNING

Threading Inserts • ER/L-ISO

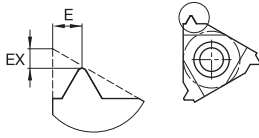
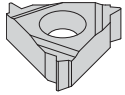

- first choice
- alternate choice

P	●
M	●
K	○
N	○
S	●
H	○

catalogue number	EX	E	SSC	thread pitch mm	TPI	TPF	TNG025
right hand							
3ER05ISO	0,6	0,4	3	0,50	—	—	2018377
3ER07ISO	0,6	0,6	3	0,70	—	—	2018389
3ER075ISO	0,6	0,6	3	0,75	—	—	2018395
3ER08ISO	0,6	0,6	3	0,80	—	—	2018403
3ER10ISO	0,7	0,7	3	1,00	—	—	2018411
3ER125ISO	0,8	0,9	3	1,25	—	—	2018421
3ER15ISO	0,8	1,0	3	1,50	—	—	2018429
3ER175ISO	0,9	1,2	3	1,75	—	—	2018445
3ER20ISO	1,0	1,3	3	2,00	—	—	2018460
3ER25ISO	1,1	1,5	3	2,50	—	—	2018472
3ER30ISO	1,2	1,6	3	3,00	—	—	2008256

Threading Inserts • ER/L-ISO

(continued)

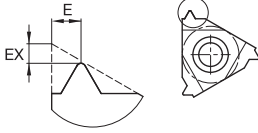
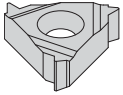

- first choice
- alternate choice

P	●
M	●
K	○
N	○
S	●
H	○

catalogue number	EX	E	SSC	thread pitch mm	TPI	TPF	TNG025
4ER35ISO	1,6	2,3	4	3,50	—	—	2018495
4ER40ISO	1,6	2,3	4	4,00	—	—	2018501
4ER45ISO	1,7	2,4	4	4,50	—	—	2018508
4ER50ISO	1,7	2,5	4	5,00	—	—	2018517
5ER55ISO	2,7	1,9	5	5,50	—	—	2018522
5ER60ISO	2,9	2,0	5	6,00	—	—	2018528
left hand							
3EL10ISO	0,7	0,7	3	1,00	—	—	2008187
3EL035ISO	0,8	0,4	3	0,35	—	—	3122015
3EL15ISO	0,8	1,0	3	1,50	—	—	2018435
3EL20ISO	1,3	1,0	3	2,00	—	—	2018466

NOTE: SSC = To correspond with the SSC on the toolholder.

INDEXABLE MILLING

SOLID END MILLING

HOLEMAKING

TAPPING

TURNING

Threading Inserts • IR/L-ISO

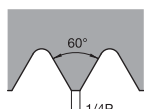
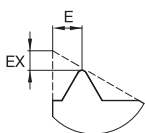
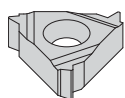

ISO Metric-Internal

- first choice
- alternate choice

P	●
M	●
K	○
N	○
S	●
H	○

catalogue number	EX	E	SSC	thread pitch mm	TPI	TPF	TNG025
right hand							
3IR05ISO	0,6	0,6	3	0,50	—	—	2018582
3IR075ISO	0,6	0,6	3	0,75	—	—	2018596
3IR10ISO	0,6	0,7	3	1,00	—	—	2018612
3IR125ISO	0,8	0,9	3	1,25	—	—	2018626
2IR15ISO	0,8	1,0	2	1,50	—	—	2018550
3IR15ISO	0,8	1,0	3	1,50	—	—	2018636
3IR175ISO	0,9	1,2	3	1,75	—	—	2018652
3IR20ISO	1,0	1,3	3	2,00	—	—	2018663
3IR25ISO	1,1	1,5	3	2,50	—	—	2018674
3IR30ISO	1,1	1,5	3	3,00	—	—	2018684
4IR35ISO	1,6	2,3	4	3,50	—	—	2018695

Threading Inserts • IR/L-ISO

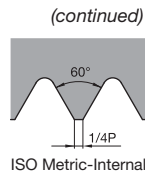
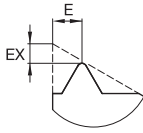
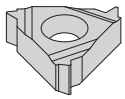

- first choice
- alternate choice

P	●
M	●
K	○
N	○
S	●
H	○

catalogue number	EX	E	SSC	thread pitch mm	TPI	TPF	TNG025
4IR40ISO	1,6	2,3	4	4,00	—	—	2018702
4IR50ISO	1,6	2,3	4	5,00	—	—	2018714
5IR55ISO	1,6	2,3	5	5,50	—	—	2021897
4IR45ISO	1,6	2,4	4	4,50	—	—	2018708
5IR60ISO	1,8	2,5	5	6,00	—	—	2018720
left hand							
3IL075ISO	0,6	0,6	3	0,75	—	—	2018598
3IL15ISO	0,8	1,0	3	1,50	—	—	2018642
3IL30ISO	1,1	1,5	3	3,00	—	—	2018688

NOTE: SSC = To correspond with the SSC on the toolholder.

INDEXABLE MILLING

SOLID END MILLING

HOLEMAKING

TAPPING

TURNING

Threading Inserts • ER/L-UN

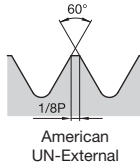
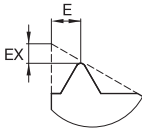
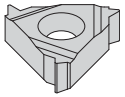

- first choice
- alternate choice

P	●
M	●
K	○
N	○
S	●
H	○

catalogue number	EX	E	SSC	thread pitch mm	TPI	TPF	TNG025
right hand							
3ER32UN	0,6	0,6	3	—	32	—	2018752
3ER28UN	0,6	0,7	3	—	28	—	2018756
3ER24UN	0,7	0,8	3	—	24	—	2018766
3ER20UN	0,8	0,9	3	—	20	—	2018772
3ER18UN	0,8	1,0	3	—	18	—	2018778
3ER16UN	0,9	1,1	3	—	16	—	2018782
3ER14UN	1,0	1,2	3	—	14	—	2018790
3ER12UN	1,1	1,4	3	—	12	—	2018802
3ER11UN	1,1	1,5	3	—	11	—	2018808
3ER10UN	1,1	1,5	3	—	10	—	2018814
3ER8UN	1,2	1,6	3	—	8	—	2018824
3ER13UN	1,3	1,0	3	—	13	—	2018796

NOTE: SSC = To correspond with the SSC on the toolholder.

INDEXABLE MILLING

SOLID END MILLING

HOLEMAKING

TAPPING

TURNING

Threading Inserts • IR/L-UN

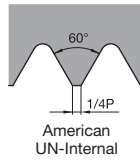
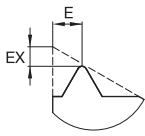
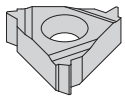

- first choice
- alternate choice

P	■	●
M	■	●
K	■	○
N	■	○
S	■	●
H	■	○
	■	○

catalogue number	EX	E	SSC	thread pitch mm	TPI	TPF	TN
right hand							216025
3IR20UN	0,8	0,9	3	—	20	—	2018938
3IR18UN	0,8	1,0	3	—	18	—	2018944
2IR18UN	0,8	1,0	2	—	18	—	2018882
3IR16UN	0,9	1,1	3	—	16	—	2018950
2IR16UN	0,9	1,1	2	—	16	—	2018886
3IR12UN	1,1	1,4	3	—	12	—	2018966
3IR8UN	1,1	1,5	3	—	8	—	2018990
left hand							2102749
3IL12UN	1,1	1,4	3	—	12	—	

NOTE: SSC = To correspond with the SSC on the toolholder.

INDEXABLE MILLING

SOLID END MILLING

HOLEMAKING

TAPPING

TURNING

INDEXABLE MILLING

SOLID END MILLING

HOLEMAKING

TAPPING

TURNING

Threading Inserts • ER/L-NPT

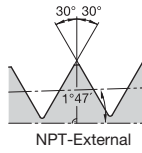
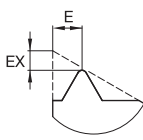
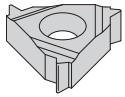

- first choice
- alternate choice

P	●
M	●
K	○
N	○
S	●
H	○

catalogue number	EX	E	SSC	thread pitch mm	TPI	TPF	TNG025
right hand							
3ER18NPT	0,8	1,0	3	—	18	.7500	2019278
3ER14NPT	0,9	1,2	3	—	14	.7500	2019288
3ER115NPT	1,1	1,5	3	—	11.5	.7500	2019298
3ER8NPT	1,3	1,8	3	—	8	.7500	2019305

NOTE: SSC = To correspond with the SSC on the toolholder.

Threading Inserts • IR/L-NPT

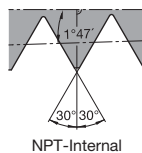
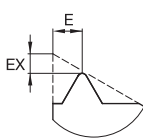
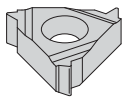

- first choice
- alternate choice

P	●
M	●
K	○
N	○
S	●
H	○

catalogue number	EX	E	SSC	thread pitch mm	TPI	TPF	TNG025
right hand							
3IR14NPT	0,9	1,2	3	—	14	.7500	2019329
3IR115NPT	1,1	1,5	3	—	11.5	.7500	2019335

NOTE: SSC = To correspond with the SSC on the toolholder.

Threading Inserts • ER/L-55

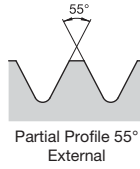
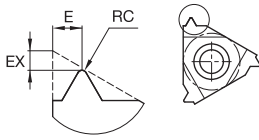
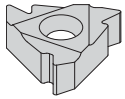

- first choice
- alternate choice

P	●
M	●
K	○
N	○
S	○
H	○

catalogue number	RC	EX	E	SSC	thread pitch mm	TPI	TPF	TNG025
right hand								
3ERAG55	0,08	1,2	1,7	3	0,50-3,0	8-48	—	2018314
3ERG55	0,20	1,2	1,7	3	1,75-3,0	8-14	—	2018308
4ERN55	0,43	1,7	2,5	4	3,5-5,0	5-7	—	2018320
left hand								
3ELG55	0,20	1,2	1,7	3	1,75-3,0	8-14	—	2008190

NOTE: SSC = To correspond with the SSC on the toolholder.

INDEXABLE MILLING

SOLID END MILLING

HOLE/MAKING

TAPPING

TURNING

Threading Inserts • IR/L-55

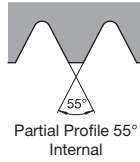
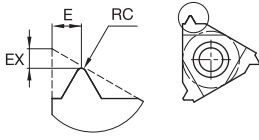
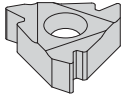

- first choice
- alternate choice

P	●
M	●
K	○
N	○
S	●
H	○

catalogue number	RC	EX	E	SSC	thread pitch mm	TPI	TPF	TNG025
right hand								
2IRA55	0,05	0,8	0,9	2	0,50-1,50	16-48	—	2018328
3IRA55	0,05	0,8	0,9	3	0,50-1,50	16-48	—	2018334
3IRAG55	0,07	1,2	1,7	3	0,50-3,0	8-48	—	2018346
3IRG55	0,21	1,2	1,7	3	1,75-3,0	8-14	—	2018340
4IRN55	0,43	1,7	2,5	4	3,5-5,0	5-7	—	2018354
left hand								
3ILA55	0,05	0,8	0,9	3	0,50-1,50	16-48	—	3122449

NOTE: SSC = To correspond with the SSC on the toolholder.

INDEXABLE MILLING

SOLID END MILLING

HOLEMAKING

TAPPING

TURNING

Threading Inserts • ER/L-W

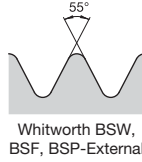
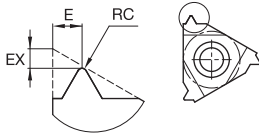
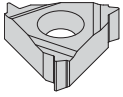

- first choice
- alternate choice

P	●
M	●
K	○
N	○
S	○
H	○

catalogue number	RC	EX	E	SSC	thread pitch mm	TPI	TPF	TN6025
right hand								
3ER32W	0,08	0,6	0,6	3	—	32	—	2019023
3ER28W	—	0,6	0,7	3	—	28	—	2019029
3ER19W	—	0,8	1,0	3	—	19	—	2019055
3ER14W	—	1,0	1,2	3	—	14	—	2019071
3ER10W	—	1,1	1,5	3	—	10	—	2019089
3ER11W	—	1,1	1,5	3	—	11	—	2019063
3ER8W	—	1,2	1,5	3	—	8	—	2019101

SSC = To correspond with the SSC on the toolholder.

INDEXABLE MILLING

SOLID END MILLING

HOLEMAKING

TAPPING

TURNING

INDEXABLE MILLING

SOLID END MILLING

HOLEMAKING

TAPPING

TURNING

Threading Inserts • IR/L-W

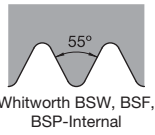
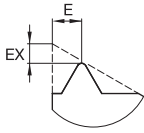
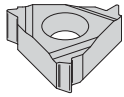

- first choice
- alternate choice

P	●
M	●
K	○
N	○
S	●
H	○

catalogue number	EX	E	SSC	thread pitch mm	TPI	TPF	TNG025
right hand							
2IR14W	0,9	1,1	2	—	14	—	2019136
3IR14W	1,0	1,2	3	—	14	—	2019189
3IR11W	1,1	1,5	3	—	11	—	2019205

NOTE: SSC = To correspond with the SSC on the toolholder.

Threading Inserts • ER/L-RD

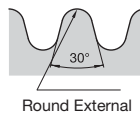
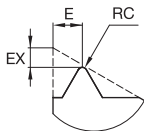
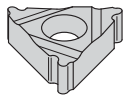

- first choice
- alternate choice

P	●
M	●
K	○
N	○
S	●
H	○

catalogue number	RC	EX	E	SSC	thread pitch mm	TPI	TPF	TNG025
right hand								
3ER8RD	0,76	1,4	1,3	3	—	8	—	2019347

NOTE: SSC = To correspond with the SSC on the toolholder.

Threading Inserts • IR/L-RD

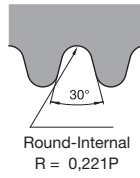
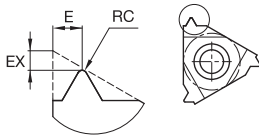
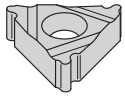

- first choice
- alternate choice

catalogue number	RC	EX	E	SSC	thread pitch mm	TPI	TPF	TN
right hand								2019381
3IR8RD	0,70	1,4	1,4	3	—	8	—	2019381
4IR4RD	1,40	2,3	2,2	4	—	4	—	2019400

NOTE: SSC = To correspond with the SSC on the toolholder.

INDEXABLE MILLING

SOLID END MILLING

HOLE/MAKING

TAPPING

TURNING

Threading Inserts • ER/L-TR

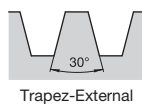
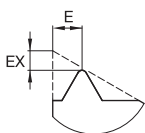
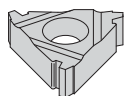

- first choice
- alternate choice

P	●
M	●
K	○
N	○
S	●
H	○

catalogue number	EX	E	SSC	thread pitch mm	TPI	TPF	TN6025
right hand							
3ER2TR	1,1	1,3	3	2,00	—	—	2019453
3ER3TR	1,3	1,5	3	3,00	—	—	2019461
4ER4TR	1,7	1,9	4	4,00	—	—	2019469
4ER5TR	2,1	2,5	4	5,00	—	—	2019479
5ER6TR	2,3	2,7	5	6,00	—	—	2019487
left hand							
3EL3TR	1,3	1,5	3	3,00	—	—	2019463

NOTE: SSC = To correspond with the SSC on the toolholder.

INDEXABLE MILLING

SOLID END MILLING

HOLEMAKING

TAPPING

TURNING

Threading Inserts • IR/L-TR

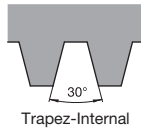
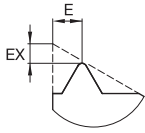
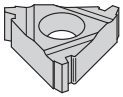

- first choice
- alternate choice

P	●
M	●
K	○
N	○
S	●
H	○

catalogue number	EX	E	SSC	thread pitch mm	TPI	TPF	TNG025
right hand							
3IR3TR	1,3	1,5	3	3,00	—	—	2019511
4IR4TR	1,7	1,9	4	4,00	—	—	2019520
4IR5TR	2,1	2,5	4	5,00	—	—	2019528
5IR6TR	2,3	2,7	5	6,00	—	—	2019534

NOTE: SSC = To correspond with the SSC on the toolholder.

INDEXABLE MILLING

SOLID END MILLING

HOLEMAKING

TAPPING

TURNING

Laydown Threading Toolholder • Catalog Numbering System

A

Toolholder
Construction

A –
Shim required

N –
Without shim

L

Tool Type

L – External Thread

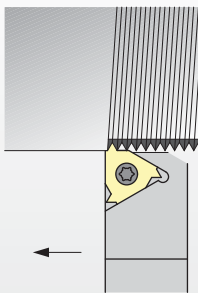

25

Shank Size

Toolholders

- First two numbers are shank height in mm.

3

Insert
Size

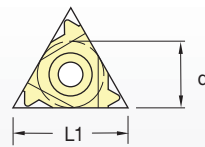

symbol	d	L1
2	6,35	11
3	9,52	16
4	12,7	22
5	15,88	27

R

Hand of
Tool

RH –
Thread symbol R

LH –
Thread symbol L

INDEXABLE MILLING

SOLID END MILLING

HOLEMAKING

TAPPING

TURNING

Laydown Threading Boring Bar • Catalog Numbering System

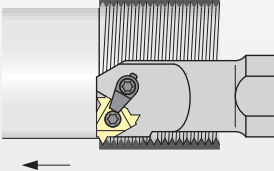
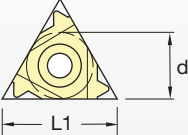
A	VR		20	3	R															
Shim Requirement	Tool Type	Coolant Capability	Shank Head Diameter	Insert Size	Hand of Tool															
<p>A – Shim required</p> <p>N – No shim required</p> <p>O – Miniature holder</p>	<p>VR – Internal round shank</p> 	<p>C – With coolant</p>	<p>10, 12, 13, 16, 20, 25, 32, 40, 50</p> <p>6.2 (Mini adjust)</p> <p>8.0 (Mini adjust)</p>		<p>RH – Thread symbol R</p> <p>LH – Thread symbol L</p>															
			<table border="1"> <thead> <tr> <th>symbol</th> <th>d</th> <th>L1</th> </tr> </thead> <tbody> <tr> <td>2</td> <td>6,35</td> <td>11</td> </tr> <tr> <td>3</td> <td>9,52</td> <td>16</td> </tr> <tr> <td>4</td> <td>12,7</td> <td>22</td> </tr> <tr> <td>5</td> <td>15,88</td> <td>27</td> </tr> </tbody> </table>			symbol	d	L1	2	6,35	11	3	9,52	16	4	12,7	22	5	15,88	27
symbol	d	L1																		
2	6,35	11																		
3	9,52	16																		
4	12,7	22																		
5	15,88	27																		

INDEXABLE MILLING

SOLID END MILLING

HOLEMAKING

TAPPING

TURNING

Integral Toolholders • N/A • Metric

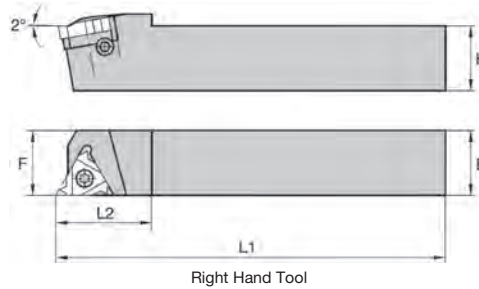
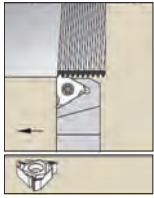

Right Hand Tool

order number	catalogue number	SSC	H	B	F	L1	L2
right hand							
2022340	NL82R	2	8	8	11	136	18
2009587	AL163R	3	16	16	16	100	25
2009591	AL203R	3	20	20	20	128	30
2009594	AL253R	3	25	25	25	153	30
2009600	AL323R	3	32	32	32	173	30
2009597	AL254R	4	25	25	25	155	36
2009603	AL324R	4	32	32	32	175	36
2022589	AL325R	5	32	32	32	176	40
left hand							
2071294	AL163L	3	16	16	16	100	25
2071295	AL203L	3	20	20	20	125	30

NOTE: SSC = To correspond with the SSC on the insert.

Cutting Units • KM40TS • LSE-N 90° • Internal Only • Metric

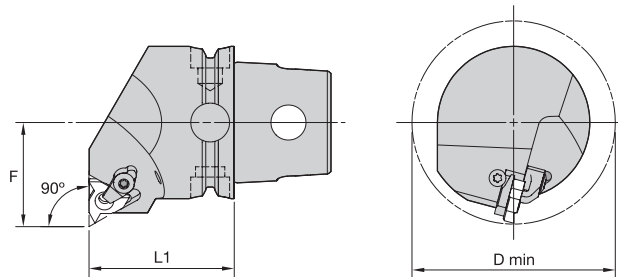
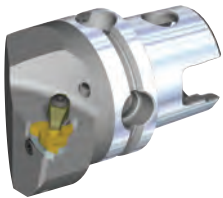

order number	catalogue number	L1		F		D min		gage insert	kg	lbs
		mm	in	mm	in	mm	in			
right hand										
3950832	KM40TSLSER16N	40	1.575	27	1.063	54	2.126	LT16NR	0,35	.78
3950854	KM40TSLSER22N	40	1.575	27	1.063	54	2.126	LT22NR	0,35	.77
left hand										
3950831	KM40TSLSEL16N	40	1.575	27	1.063	54	2.126	LT16NL	0,35	.78

NOTE: Cutting units are supplied with insert screw and clamp assembly. However, tools are designed to use either the insert screw or the clamp assembly, not both.

Integral I.D. Threading Boring Bars • N/A-VR • Metric

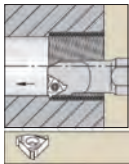

Steel shank without through coolant.

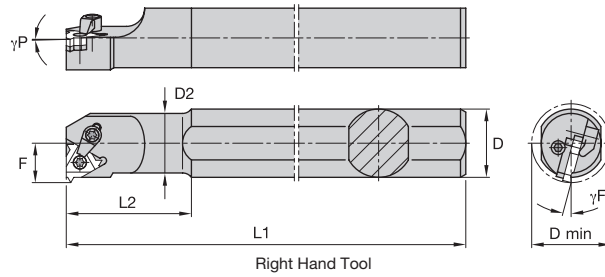

order number	catalogue number	SSC	D	D min	D2	F	L1	L2	γF°	γP°
right hand										
2025828	NVR102R	2	20	13	10	7	180	25	-15,0°	-1,5
2022342	NVR132R	2	20	16	13	9	180	32	-15,0°	-1,5
2012307	NVR163R	3	20	20	16	12	180	40	-15,0°	-1,5
2009609	AVR203R	3	20	24	20	13	180	50	-15,0°	-1,5
2009628	AVR25D3R	3	25	29	25	16	200	45	-15,0°	-1,5
2009612	AVR253R	3	32	29	25	16	250	60	-15,0°	-1,5
2009640	AVR32D3R	3	32	36	32	20	250	60	-15,0°	-1,5
2022343	NVR204R	4	20	27	20	16	180	50	-15,0°	-1,5
2009631	AVR25D4R	4	25	32	25	17	200	45	-15,0°	-1,5
2009625	AVR254R	4	32	32	25	17	250	60	-15,0°	-1,5
2009634	AVR324R	4	32	39	32	22	250	60	-15,0°	-1,5
2009637	AVR325R	5	32	40	32	22	250	60	-15,0°	-1,5
left hand										
2071317	NVR163L	3	20	20	16	12	180	40	-15,0°	-1,5
2071318	AVR203L	3	20	24	20	13	180	40	-15,0°	-1,5
2065134	AVR25D3L	3	25	29	25	16	200	45	-15,0°	-1,5
2114832	AVR253L	3	32	29	25	16	250	60	-15,0°	-1,5

NOTE: Items listed without a shim are designed for a 1.5° inclination angle.
SSC = To correspond with the SSC on the insert.

Integral I.D. Threading Boring Bars • OVR • Metric

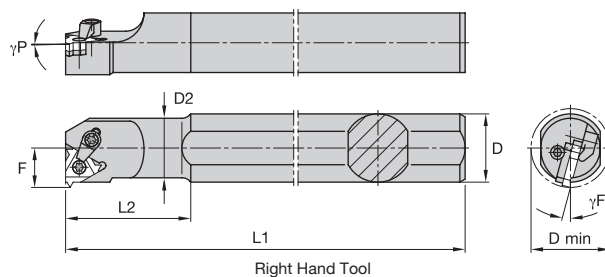
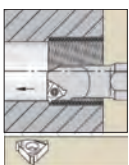

order number	catalogue number	SSC	D	D min	D2	F	L1	L2	γF°	γP°
right hand										
2012325	OVR122R	2	12	13	10	7	100	25	-15,0°	-0,5
2022345	OVR152R	2	15	16	13	9	100	32	-15,0°	-0,5

NOTE: WIDIA™ miniature holders are for use on automatic machines as used in the optical and precision mechanics industries. The shank dimensions correspond to conventional hardmetal or HSS tools. Holders with round or square shanks are available. An internal RH tool can also be used for external LH threads in the same way an internal LH tool can be used for external RH threads. Please use correct inserts. The inclination angle on this tool is 0.5°. Tools are always clamped with the shank parallel to the part.
SSC = To correspond with the SSC on the insert.

Cutting Units • KM40TS • LSE 90° • Metric

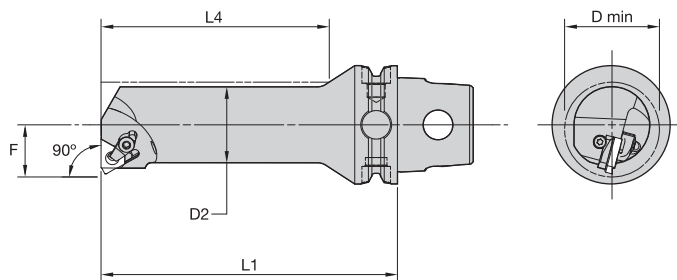

order number	catalogue number	D2		D min		F		L4		L1		gage insert	kg	lbs
		mm	in	mm	in	mm	in	mm	in	mm	in			
right hand														
3955464	KM40TSS10DLSER11	10	.394	13	.51	7	.276	35	1.38	60	2.362	LT11NR	0,22	.49
3955466	KM40TSS12ELSER11	12	.472	16	.63	9	.354	42	1.66	70	2.756	LT11NR	0,25	.56
3955468	KM40TSS16FLSER16	16	.630	20	.79	11	.433	56	2.21	80	3.150	LT16NR	0,28	.61
3955470	KM40TSS20GLSER16	20	.787	25	.98	13	.512	70	2.76	90	3.543	LT16NR	0,34	.75
3955472	KM40TSS25HLSER16	25	.984	32	1.26	17	.669	75	2.95	100	3.937	LT16NR	0,50	1.11
3955474	KM40TSS32JLSER16	32	1.260	40	1.57	22	.866	96	3.78	110	4.331	LT16NR	0,72	1.58
3955476	KM40TSS32JLSER22	32	1.260	40	1.57	22	.866	96	3.78	110	4.331	LT22NR	0,71	1.56
left hand														
3955463	KM40TSS10DLSEL11	10	.394	13	.51	7	.276	35	1.38	60	2.362	LT11NL	0,22	.49
3955465	KM40TSS12ELSEL11	12	.472	16	.63	9	.354	42	1.65	70	2.756	LT11NL	0,25	.55
3955469	KM40TSS20GLSEL16	20	.787	25	.98	13	.512	70	2.76	90	3.543	LT16NL	0,34	.75
3955471	KM40TSS25HLSSEL16	25	.984	32	1.26	17	.669	75	2.95	100	3.937	LT16NL	0,50	1.11
3955473	KM40TSS32JLSEL16	32	1.260	40	1.57	22	.866	96	3.78	110	4.331	LT16NL	0,72	1.58
3955475	KM40TSS32JLSEL22	32	1.260	40	1.57	22	.866	96	3.78	110	4.331	LT22NL	0,71	1.56

NOTE: Items listed without a shim are designed for a 1,5° inclination angle.

Cutting units are supplied with insert screw and clamp assembly. However, tools are designed to use either the insert screw or the clamp assembly, not both.

Hardware

Laydown Threading Toolholders

In all cases, the proper shim selection is important.

WIDIA™ toolholders are supplied with a shim for a 1.5° lead angle. Change the shim if your thread is more than 1° different. For more details on proper shim selections, see pages E514–E515.

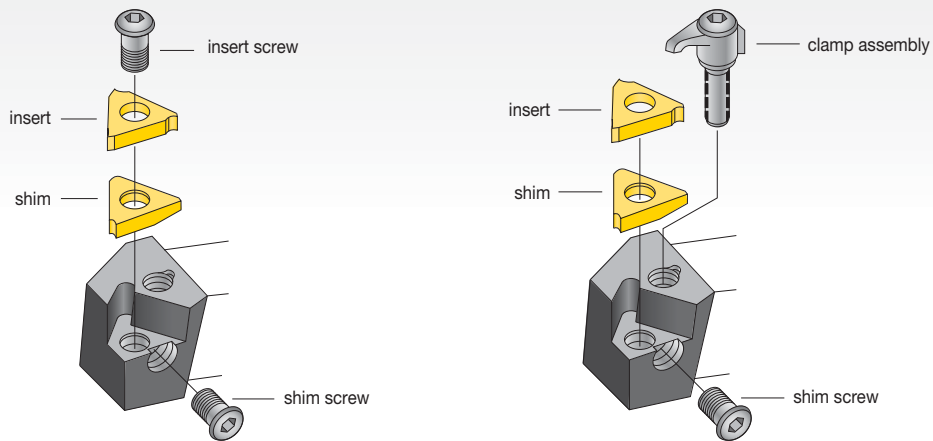

insert size and screw	insert screw	shim	shim screw and washer	clamp assembly
3ER	S-SA3T	SM-YIE3	S-SY3T	CK-C3
3EL	S-SA3T	SM-YI3	S-SY3T	CK-C3
4ER	S-SA4T	SM-YIE4	S-SY4T	CK-C4
4EL	S-SA4T	SM-YI4	S-SY4T	CK-C4
Laydown Threading boring bars				
2IR	S-SN2T	—	—	—
2IL	S-SN2T	—	—	—
3IR	S-SA3T	SM-YI3	S-SY3T	CK-C3
3IL	S-SA3T	SM-YIE3	S-SY3T	CK-C3
4IR	S-SA4T	SM-YI4	S-SY4T	CK-C4
4IL	S-SA4T	SM-YIE4	S-SY4T	CK-C4

SM

Shim

—

Y

Y-shim for Laydown standard inserts

E

E — External
I — Internal

3

iC — 16mm

—

2N

Shim Angle

2P	2° positive
1P	1° positive
—	0°
1N	1° negative
2N	2° negative
3N	3° negative

Screw Thread Definitions

resultant angle		3.5°	2.5°	1.5°	0.5°	-0.5°	-1.5°
insert size (iC)	toolholder	shim ordering code					
16mm	ex. RH/in. LH ex. LH/in. RH	SM-YE3-2P SM-YI3-2P	SM-YE3-1P SM-YI3-1P	SM-YE3 SM-YI3	SM-YE3-1N SM-YI3-1N	SM-YE3-2N SM-YI3-2N	SM-YE3-3N SM-YI3-3N
22mm	ex. RH/in. LH ex. LH/in. RH	SM-YE4-2P SM-YI4-2P	SM-YE4-1P SM-YI4-1P	SM-YE4 SM-YI4	SM-YE4-1N SM-YI4-1N	SM-YE4-2N SM-YI4-2N	SM-YE4-3N SM-YI4-3N

Slanted Shim Kit

Because you might occasionally need different shims than those supplied with our standard toolholders, we strongly recommend that shim kits be readily available in every tool shop.

insert size	shim size (D)	ordering code	contains slanted shims
3x	16mm	ABY3	SM-YE3-2P, 1P, 1N, 2N, 3N SM-YI3-2P, 1P, 1N, 2N, 3N
4x	22mm	ABY4	SM-YE4-2P, 1P, 1N, 2N, 3N SM-YI4-2P, 1P, 1N, 2N, 3N

The Helix Angle

Example:
 $d = 48,06\text{mm}$ (1.892")
 $p = 3,175\text{mm}$ (.125")

ϕ = Helix angle
 p = pitch
 d = pitch diameter

$$\phi = \arctan \left(\frac{p * \text{starts}}{\pi * \phi} \right) = 1.13^\circ$$

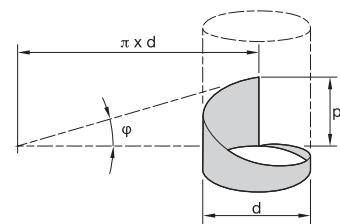

Screw Thread Definitions

1. Major diameter — The largest diameter of a straight screw thread. This applies to both internal and external threads.
2. Pitch diameter — On a straight thread, it is the diameter which passes through the thread profiles at such points which make the thread width of the groove equal to one-half of the basic pitch. On a "perfect thread," this occurs at the point where the widths of the thread and groove are equal.
3. Thread angle (included) — The included angle between the individual flanks of the thread form.
4. Minor diameter — The smallest diameter of a straight screw thread. This applies to both internal and external threads.
5. Lead angle — On a straight thread, the lead angle is the angle created by the helix of the thread at the pitch diameter with a plane perpendicular to the axis.
6. Lead — The distance a screw thread advances axially in one revolution. On a single start, the pitch and lead are identical. The lead is equal to the pitch times the number of starts.
7. Pitch — The distance from a point on a screw thread to a corresponding point on the next thread measured parallel to the thread axis.
8. Crest — The outermost most surface of the thread form which joins the flanks.
9. Root — The innermost most surface of the thread form which joins the flanks.

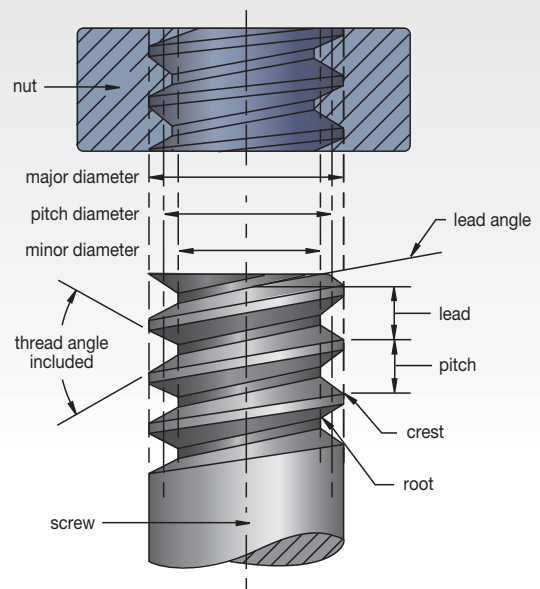

NOTE: Threads per inch (TPI) not shown:
 The number of threads per inch measured axially.
 The terms pitch and TPI are often used interchangeably. $TPI = 1/\text{pitch}$

TopThread™ Threading

TopThread External Threading

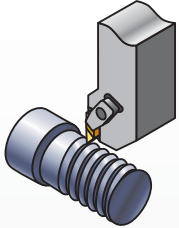

Square Shank Toolholder Sizes:

- Metric — 10–32mm

Cresting (Full Profile):

UN TPI of 32–7
ISO 1,5–3,0mm pitch

60° Partial Profile — Flat Top

(NTF and NTK):
UN 44–4.5 TPI
ISO 0,6–5,5mm pitch

TopThread Internal Threading

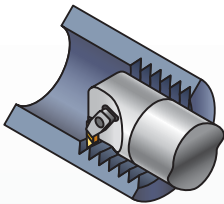

Boring Bar Diameters:

- Metric — 10–50mm
- Minimum bore — 11,5mm
- Steel

Cresting (Full Profile):

UN 16–8 TPI
ISO 1,5–3,0mm pitch

60° Partial Profile — Flat Top

(NT-1L, NTF, and NTK):
UN 24–4.5 TPI
ISO 1,0–5,5mm pitch

INDEXABLE MILLING

SOLID END MILLING

HOLE/MAKING

TAPPING

TURNING

Laydown Threading

Laydown External Threading

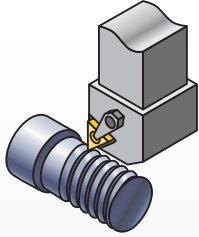
**Square Shank Toolholder Sizes:**

- Metric — 8–40mm

Cresting (Full Profile):

UN 48–8 TPI
ISO 0,5–5,0mm pitch

60° Partial Profile:

UN 48–4 TPI
ISO 0,5–6,0mm pitch

Laydown Internal Threading

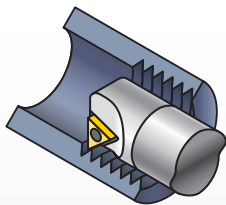
**Boring Bar Diameters:**

- Metric — 12–50mm
- Minimum bore — (13mm)
- Steel and carbide

Cresting (Full Profile) and Partial Profile:

UN 48–8 TPI
ISO 0,5–5,0mm pitch

60° Partial Profile:

UN 48–4 TPI
ISO 0,5–6,0mm pitch

55° Partial Profile:

UN 48–5 TPI
ISO 0,5–5,0mm pitch

Common Thread Forms

INDEXABLE MILLING

SOLID END MILLING

HOLEMAKING

TAPPING

TURNING

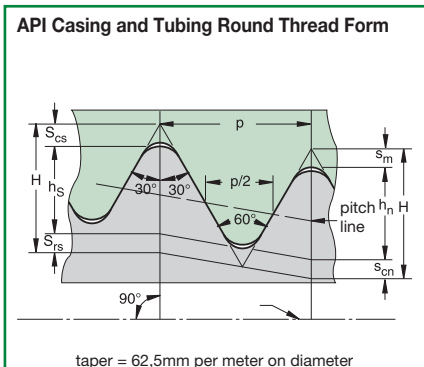
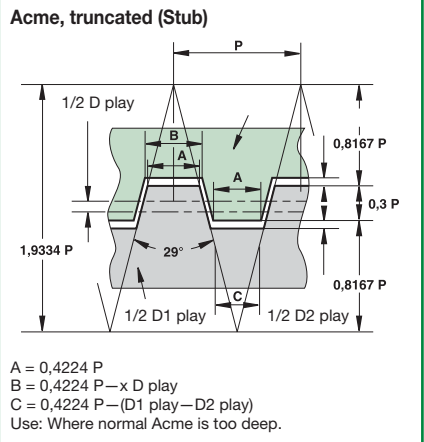
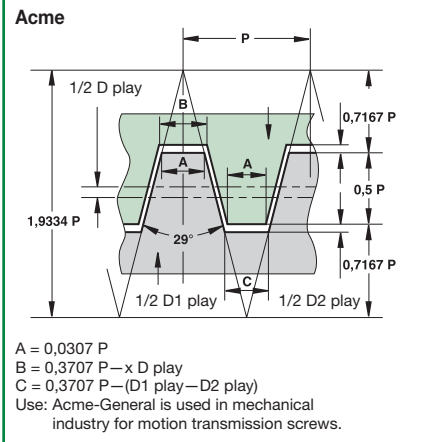
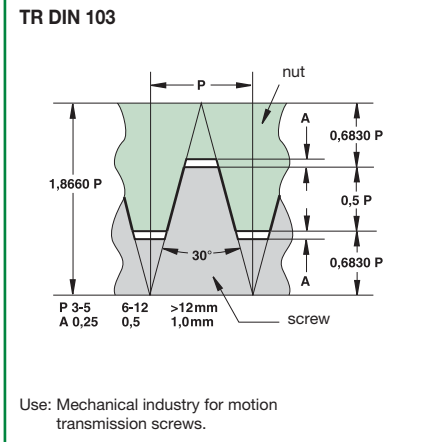
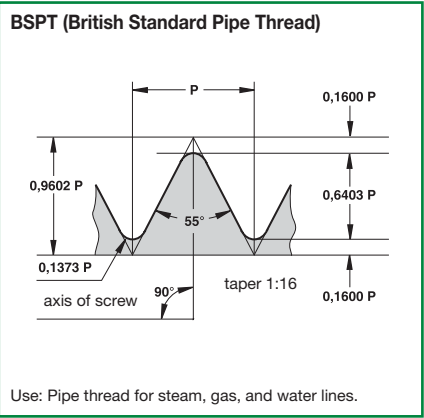
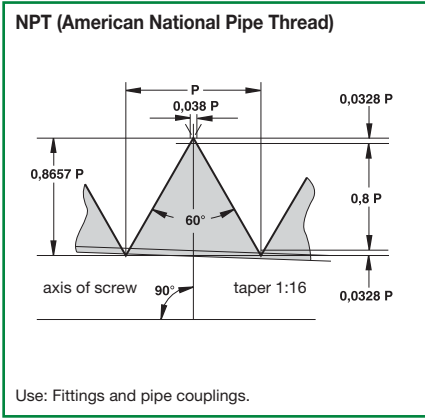
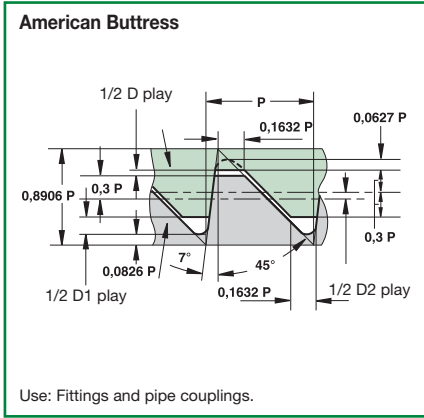
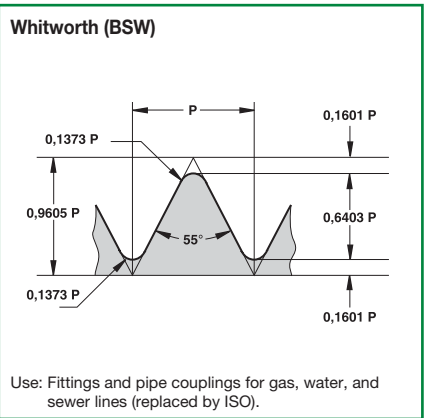
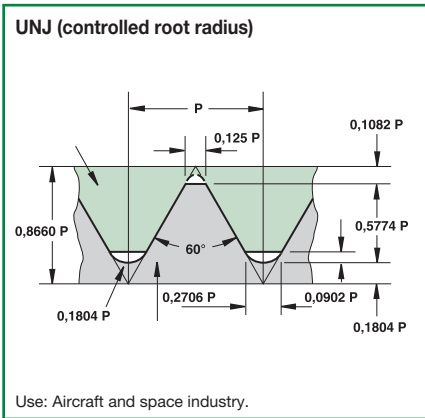
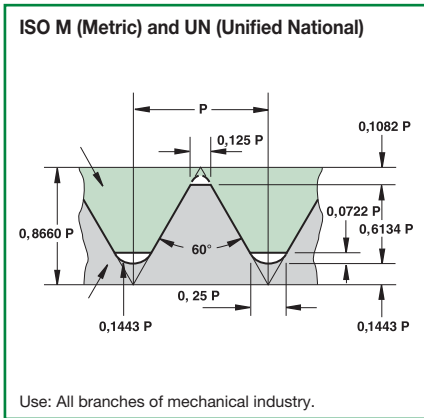

NOTE: Taper shown exaggerated.

Grade Selection Chart







Suggested Grades and Speeds for Threading Various Workpiece Materials

workpiece group	workpiece material	recommended surface speed – SFM		
		uncoated	PVD coated	
		THM	TN6010	TN6025
free-machining carbon steel	10L18, 10L45, 1213, 12L13, 12L14, 1140, 1141, 11L44, 1151, 10L50	–	91–98	45–198
plain carbon steel	10063, 1008, 1010, 1015, 1018, 1020, 1025, 1026, 1108, 1117	–	76–198	45–175
alloy steels/tool steels 150–325 HB (up to 35 HRC)	1042, 1045, 1070, 1080, 1085, 1090, 1095, 1541, 1561, 1572, 5140, 8620, W1, O1, S1, P20, H13, D2, A6, H13, L6	–	76–198	38–167
alloy steels/tool steels 330–450 HB (36–47 HRC)		–	61–160	–
martensitic/ferritic stainless/precipitation hardening	416, 420F, 440F, 405, 409, 429, 430, 434, 436, 442, PH	–	45–160	30–120
austenitic stainless steel	201, 202, 301, 302, 303, 304, 304, 305, 321, 347, 348, 310, 314, 316, 316L, 330	61–106	61–198	46–137
gray cast iron 135–270 HB	class 20, 30, 35, 45	61–91	61–237	46–122
gray cast iron 275–450 HB	class 50, 55, 60	45–76	45–175	15–76
alloy/ductile iron	A536, J434C, 60-40-18, 80-55-06, 100-70-03	45–76	45–650	100–525
free-machining aluminum alloys	2024-T4, 2014-T6, 6061-T6, 2011-T3, 3003-H18, A2, Alcan, Alcoa® 510, Duralumin	122–244	122–265	–
high-silicon aluminum alloys	A380, A390, A380-1, A390-1, A380-2	–	–	–
copper/zinc/brass		76–183	76–304	46–236
non-metallics	Graphite, Nylon, Plastics, Rubbers, Phenolics, Carbon	122–457	122–396	46–305
high-temperature alloys 125–269 HB (up to 27 HRC)	Nickel 200, MONEL®, R405, MONEL K500, INCONEL® 600, INCONEL 625/901x750/718, Waspaloy®, Hastelloy® C	24–37	24–122	13–76
high-temperature alloys 260–450 HB (26–47 HRC)	Rene 95, Waspaloy A286, INCOLOY® 800, Haynes® 188, Stellite™ F, Haynes 25	24–30	30–76	6–61
titanium alloys	Ti-6Al-4V, Ti-5Al-2.5Sn	34–55	34–99	–

NOTE: When workpiece hardness levels are at the top of a range, starting SFM should be at the lower end. Regularly inspect insert clamps for worn flats.

Edge preparation:
Uncoated – sharp
PVD coated – light hone except positive top rake, top rake-sharp

Failure and Solution Guide

problem	cause	possible solution
thread with torn finish 	<ul style="list-style-type: none"> • Burs. • Torn finish. • Steps. • Improper shim. • Improper infeed. 	<ul style="list-style-type: none"> • Use modified flank infeed. • Use full profile insert. • Increase coolant concentration. • Increase cutting speed. • Check machine "Z" travel axis. • Check insert form. • Check for correct shim in LT system. • Calculate flank clearance.
chatter 	<ul style="list-style-type: none"> • Poor rigidity. • Insert movement. • Improper infeed. • Off centerline. 	<ul style="list-style-type: none"> • Use modified flank infeed. • Minimize tool overhang. • Check for workpiece deflection. • Check insert and clamp. • Verify that tool cutting position is at workpiece centerline. • Adjust number of passes. Fewer passes reduce chatter.
built-up edge 	<ul style="list-style-type: none"> • Speed too low. • Insufficient coolant. • Chip load. 	<ul style="list-style-type: none"> • Increase cutting speed. • Increase coolant concentration and/or flow. • Adjust infeed angle. • Increase depth of cut per pass.
deformation 	<ul style="list-style-type: none"> • Wrong grade. • Speed too high. • Improper infeed angle. • Insufficient coolant. 	<ul style="list-style-type: none"> • Use modified flank infeed. • Use a more wear-resistant grade (e.g., TN6010™). • Reduce cutting speed. • Increase coolant flow.
chipping 	<ul style="list-style-type: none"> • Improper infeed. • Chip load. • Wrong grade. • Incorrect speed. • Poor rigidity. 	<ul style="list-style-type: none"> • Use modified flank infeed. • Increase or decrease number of passes. • Eliminate spring passes. • Use tougher grade (e.g., TN6025™). • Increase cutting speed if chipping on trailing edge. • Decrease cutting speed if chipping on leading edge. • Minimize tool overhang. • Check for insert movement/check clamp. Torque screw or clamp to correct value. • Check for possible part deflection. • Calculate flank clearance. • Ensure correct shim.
broken nose 	<ul style="list-style-type: none"> • Heavy chip load. • Small nose radius. • Wrong grade. • Improper infeed. 	<ul style="list-style-type: none"> • Use modified flank infeed. • Decrease chip load. • Use large nose radius if possible. • Use tougher grade (e.g., TN6025).
flank wear 	<ul style="list-style-type: none"> • Improper shim. • Wrong grade. • Insufficient coolant. • Off centerline. • Insufficient flank clearance. • Improper infeed angle. 	<ul style="list-style-type: none"> • Ensure correct shim. • Use a more wear-resistant grade (e.g., TN6025). • Increase coolant flow. • Check the centerline height of the tool. (The smaller the diameter, the more critical the need for centerline accuracy.) • Calculate flank clearance and change shim to increase clearance on worn flank. • If wear is on trailing flank, increase infeed angle clearance.

INDEXABLE MILLING

SOLID END MILLING

HOLEMAKING

TAPPING

TURNING

Failure and Solution Guide

problem	possible solution																	
	increase SFM	reduce SFM	increase chip load	decrease chip load where failure occurs	use tougher carbide grade	use harder carbide grade	apply coolant	use coated carbide	use topping insert	change infeed angle	check for insert movement and reseat	reduce tool overhang	reselect shim	apply chipbreaker style	reduce DOC	adjust center height	begin cutting threads .472" before workpiece	change infeed method
chatter	•			•							•	•				•		•
bur on crest	•								•									•
short tool life		•	•	•		•		•										•
chipped leading edge			•	•	•													
chipped trailing edge					•					•								
broken nose (first pass)	•														•	•		
broken nose (after first pass)				•	•					•			•					•
built-up on cutting edge	•		•				•	•										•
premature topping													•					
splitting threads																	•	
poor chip evacuation														•				•

INDEXABLE MILLING

SOLID END MILLING

HOLEMAKING

TAPPING

TURNING

General Machining Guidelines

WIDIA™ insert technology brings chip control to your threading operations with the TopThread™ platform. The proprietary WIDIA recessed chip groove, when used according to our recommendations, controls the chip in most applications. Our positive rake design lowers cutting pressures, which in turn lowers damaging heat generation thus providing better tool life. Long, stringy chips no longer mar the workpiece surface finish. The danger to operators when removing long chips from the workpiece and chuck is eliminated. All of these benefits combine to improve the productivity of your threading operations.

The Last Pass

Some CNC controls require the last pass to be at a 0° infeed angle because the chip will not break on the last pass. On most carbon and alloy steels, the last pass can remain at 0,127mm depth of cut and produce an acceptable finish. For some materials, a 0,025mm to 0,076mm (spring) pass may be used to improve surface finish, however, chip breaking action may be compromised.

Machine Programming

Modern CNC controls allow the programmer to easily adjust infeed angle, the number of passes, and depth of cut for each pass. The chip control threading insert performs best at an infeed angle of 29° 30', although 15° to 30° is acceptable. Also, it is important to maintain a minimum of 0,127mm depth of cut on every pass. In most applications, use of CNC canned cycles produce only marginally successful results. Custom written programs are better and are recommended.



Infeed Angle

In order to effectively and consistently break the chip, it is important to use an infeed angle between 28° and 29° 30'. Do not apply chip control inserts at infeed angles less than 15°.

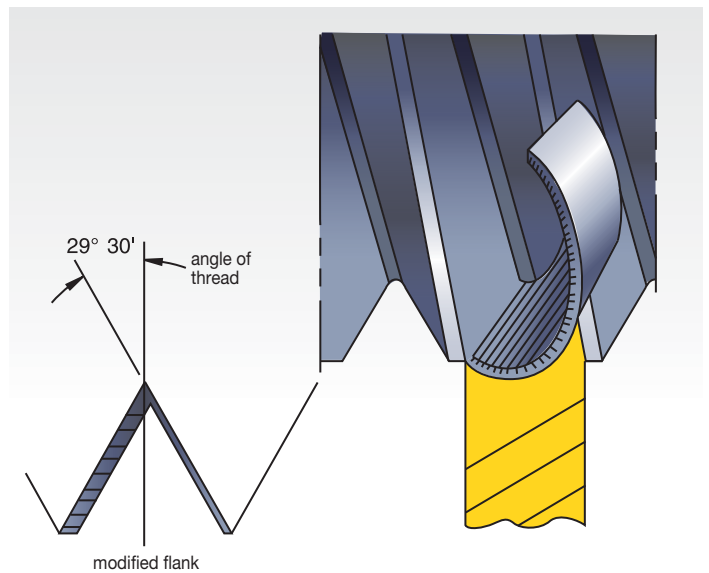

General Machining Guidelines

Radial

modified flank

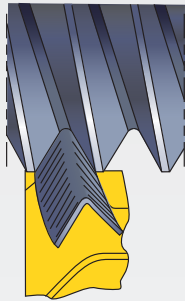
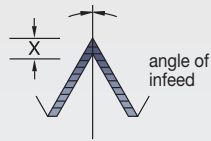

Advantage –

- Cutting on both sides of the thread form places all of the cutting edge in the cut and protects edge from chipping.
- Even wear on the insert.

Disadvantage –

- Tool develops a channel chip that may be difficult to handle.
- Tip chipping occurs when cutting high-tensile materials.
- Bur condition is increased.
- Entire cutting edge is engaged at finish of thread, causing increased tendency to chatter.

Modified flank

modified flank

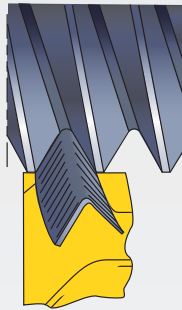
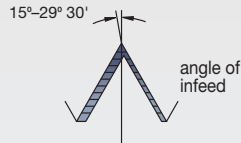

Advantage –

- Tool cuts both sides of thread form, so it is protected from chipping similar to 0° infeed. Channel-type chip develops, but uneven chip thickness helps remove the chip similar to flank infeed.
- This is the preferred method, especially when used with a chip control insert.
- Combined radial and/or alternating flank infeed.
- Results in good tool life, with wear evenly distributed over both flanks.

Disadvantage –

- Similar disadvantages as with 0° infeed, although reduced somewhat in magnitude as cutting forces are better equalized and chip flow is much less of a problem.

Alternating flank

alternating flank

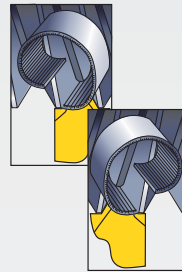
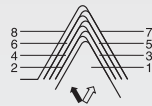

Advantage –

- Increased tool life because both edges are used equally.

NOTE: Some machine tools may require special programming techniques to achieve this method of infeed.

Disadvantage –

- Difficult to cut on conventional machinery.

Reversed modified flank

modified flank

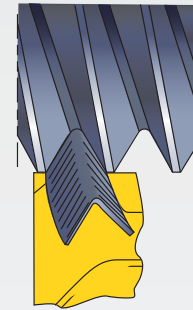
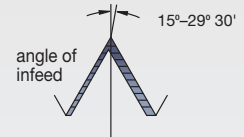

Advantage –

- Tool cuts both sides of thread form, so it is protected from chipping similar to 0° infeed. Channel-type chip develops, but uneven chip thickness helps remove the chip similar to flank infeed.
- This is the preferred method, especially when used with a chip control insert.
- Combined radial and/or alternating flank infeed.
- Results in good tool life, with wear evenly distributed over both flanks.
- As chip flow is the reversed feed direction, it is an excellent choice for internal threading.

Disadvantage –

- Programming needs to be done line by line.

Threading

Partial Profile

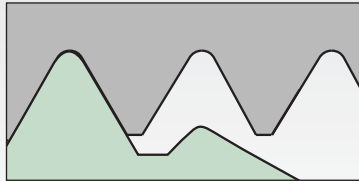

Tooth profile with universal profile shape:

- 55° or 60° without cutting edges for the tooth tapers.
- Reduced inventory.
- For various pitches in a limited range.
- Preferably one-time production.
- Major/minor diameters must be accurately pre-turned.

Full Profile

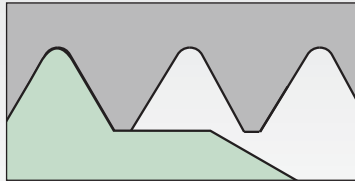

Tooth profile with full profile shape including tooth height:

- For bur-free, precise threads in the specified pitch.
- General application.
- Machining allowance for outside/core diameter around 0,1–0,15mm.

Multi-Tooth Profile

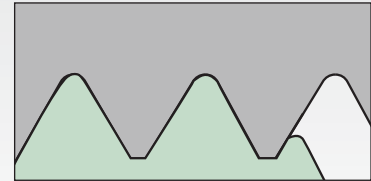

Multi-tooth full profile generally with 2–3 teeth:

- Highly productive threading with fewer passes and longer tool life.
- Requires a rigid setup and long thread pass through.
- Minimum clearance width approximately 1.25 x E as per indexable insert dimensions table.

Formulas

Metric Formula		
to find	given	formula
m/min	D (mm) RPM	$m/min = \frac{\pi \times D}{1000} \times RPM$
RPM	D (mm) m/min	$RPM = \frac{m/min \times 1000}{D \times \pi}$

Legend

- m/min = meters per minute
- RPM = revolutions per minute
- D = part diameter
- π = 3.1416

Maximum Cutting Speeds

Maximum cutting speed is often limited by the maximum travel speed (IPM or mm/min) of the tool allowed by the machine.

Check your maximum speed with the following formula:

$$\text{maximum cutting speed (m/min)} = \text{part diameter (mm)} \times 3.14 \times (1/\text{pitch}) \times \frac{\text{max mm/min}}{1000\text{mm}}$$

Flank Clearance

- γ = $\arctan(\sin(\beta/2) * \tan(\alpha))$
- g = side (flank) clearance
- β = included angle of thread form
- α = radial inclination angle

Thread	Angle	External	Internal
UN & ISO	60	5.3	8
BSW	55	4.8	7.3
TR	30	2.6	4
ACME	29	2.6	3.9
AMBUT	7	.6	.9
AMBUT	45	4	6

Threading

Recommendation for Threading Infeed Passes

TPI	48-32	28-24	20-16	14-12	11.5-9	8-6	5-4	3-2
metric pitch (mm)	0,50-0,75	0,80-1	1,25-1,5	1,75-2	2,5-3	3,5-4	4,5-6	8
Thread Type	recommended number of passes							
Common V-thread forms ISO, UN, UNJ, NPT, Whitworth, BSPT, API Rotary Shoulder	4-5	5-6	6-8	8-10	9-12	12-15	14-16	15-25
Acme, Trapez, Round, API Round	–	–	5-6	7-8	10-11	12-13	13-15	18-20
Stub Acme, API Buttress	–	–	5	5-6	7-8	8-10	10-12	14-16
American Buttress	–	–	7-8	9-10	11-12	13-15	17-19	22-24

Maintain minimum 0,05mm infeed on last passes to avoid work hardening and excessive abrasion of the threading tool.

Constant Volume Infeed Values for Threading Operations

In most applications, use of CNC canned cycles produces only marginally successful results. For example, an 8-pitch external thread has a depth of 2mm (.0789").

Formula for constant chip load infeed

$$\Delta a_{p_x} = \frac{a_p}{\sqrt{\text{nap}-1}} \cdot \sqrt{\phi}$$

Δa_p	=	radial infeed
x	=	actual pass (from 1 to the nap)
nap	=	number of passes
ϕ	=	1st pass, 0,3
		2nd pass, 1
		3rd pass and up, x-1

Using Radial Infeed

Bending stress on the cutting edge caused by V-shaped chips from long-chipping steel workpiece materials.

High cutting forces with small cutting thicknesses require sharp edges with high strength.

Using Flank Infeed

Lower bending stress and stabilized cutting edges produce more favorable chip shapes and larger cutting thicknesses.

Carbides with high hardness, good wear resistance, and temperature stability are advantageous.

Guidelines for Infeeds —

How to Determine the Number and the Size of Passes

The number of passes "s" per thread is decisive for successful threading and crest turning. The following tables give standard values for the application condition when machining steel. The proper number of passes must be determined empirically.

If insert breakage occurs, the number of passes must be increased. With increased wear, we recommend decreasing the number of passes. The chip thickness should not be less than 0,05mm. The allowance at the diameter should not exceed 0,2mm.

Threading Infeed Tables

Metric ISO, External Thread Cutting

thread pitch P (mm)	0,50	0,75	1,00	1,25	1,50	1,75	2,00	2,50	3,00	3,50	4,00	4,50	5,00
T Ap (mm)	0,305	0,457	0,610	0,762	0,914	1,067	1,219	1,524	1,829	2,159	2,464	2,769	3,073
N Ap	4	4	5	6	6	8	8	10	12	14	15	15	16
	values for flank infeed (X/Z)												
order of passes	X/Z	X/Z	X/Z	X/Z	X/Z	X/Z	X/Z	X/Z	X/Z	X/Z	X/Z	X/Z	X/Z
1	0,096	0,145	0,167	0,187	0,224	0,221	0,252	0,278	0,302	0,328	0,361	0,405	0,435
2	0,080	0,119	0,138	0,154	0,185	0,182	0,208	0,230	0,249	0,271	0,298	0,335	0,359
3	0,073	0,109	0,126	0,141	0,169	0,167	0,191	0,210	0,228	0,248	0,273	0,306	0,329
4	0,056	0,084	0,097	0,108	0,130	0,128	0,146	0,161	0,175	0,190	0,209	0,235	0,252
5			0,082	0,091	0,110	0,108	0,123	0,136	0,148	0,160	0,176	0,198	0,213
6				0,080	0,097	0,095	0,109	0,120	0,130	0,141	0,155	0,175	0,187
7						0,086	0,098	0,108	0,118	0,128	0,141	0,158	0,169
8						0,079	0,090	0,100	0,108	0,118	0,129	0,145	0,156
9								0,093	0,101	0,109	0,120	0,135	0,145
10								0,087	0,095	0,103	0,113	0,127	0,136
11									0,089	0,097	0,107	0,120	0,129
12									0,085	0,092	0,102	0,114	0,122
13										0,088	0,097	0,109	0,117
14										0,085	0,093	0,105	0,112
15											0,090	0,101	0,108
16													0,104
T Ap (mm)	0,305	0,457	0,610	0,762	0,914	1,067	1,219	1,524	1,829	2,159	2,464	2,769	3,073

NOTE: Always allow 0,08–0,13mm extra stock for full profile inserts.

Metric ISO, Internal Thread Cutting

thread pitch P (mm)	0,50	0,75	1,00	1,25	1,50	1,75	2,00	2,50	3,00	3,50	4,00	4,50	5,00
T Ap (mm)	0,279	0,406	0,533	0,686	0,813	0,940	1,092	1,346	1,626	1,905	2,159	2,438	2,718
N Ap	4	4	5	6	6	8	8	10	11	12	14	15	16
	values for flank infeed (X/Z)												
order of passes	X/Z	X/Z	X/Z	X/Z	X/Z	X/Z	X/Z	X/Z	X/Z	X/Z	X/Z	X/Z	X/Z
1	0,088	0,129	0,146	0,168	0,199	0,195	0,226	0,246	0,282	0,315	0,328	0,357	0,384
2	0,073	0,106	0,121	0,139	0,164	0,161	0,187	0,203	0,232	0,260	0,271	0,295	0,317
3	0,067	0,097	0,110	0,127	0,151	0,147	0,171	0,186	0,213	0,238	0,248	0,270	0,291
4	0,051	0,075	0,085	0,097	0,116	0,113	0,131	0,143	0,163	0,183	0,190	0,207	0,223
5			0,071	0,082	0,097	0,095	0,111	0,120	0,138	0,154	0,160	0,175	0,188
6				0,072	0,086	0,084	0,097	0,106	0,121	0,136	0,141	0,154	0,166
7						0,076	0,088	0,096	0,110	0,123	0,128	0,139	0,150
8						0,070	0,081	0,088	0,101	0,113	0,118	0,128	0,138
9								0,082	0,094	0,105	0,109	0,119	0,128
10								0,077	0,088	0,099	0,103	0,112	0,120
11									0,083	0,093	0,097	0,106	0,114
12									0,000	0,089	0,092	0,101	0,108
13										0,000	0,088	0,096	0,103
14											0,000	0,085	0,092
15												0,000	0,089
16													0,092
T Ap (mm)	0,279	0,406	0,533	0,686	0,813	0,940	1,092	1,346	1,626	1,905	2,159	2,438	2,718

NOTE: Always allow 0,08–0,13mm extra stock for full profile inserts.

Threading Infeed Tables

UN Thread, External Thread Cutting

TPI	24	20	18	16	14	12	11	10	9	8	7	6	5
T Ap (mm)	0,660	0,787	0,864	0,965	0,914	1,067	1,219	1,524	1,829	2,159	2,464	2,769	3,073
N Ap	5	6	6	7	9	9	10	11	12	13	14	15	16
	values for flank infeed (X/Z)												
order of passes	X/Z	X/Z	X/Z	X/Z	X/Z	X/Z	X/Z	X/Z	X/Z	X/Z	X/Z	X/Z	X/Z
1	0,181	0,193	0,212	0,216	0,177	0,207	0,223	0,264	0,302	0,341	0,374	0,405	0,435
2	0,149	0,159	0,175	0,178	0,146	0,171	0,184	0,218	0,249	0,282	0,309	0,335	0,359
3	0,137	0,146	0,160	0,163	0,134	0,156	0,168	0,200	0,228	0,258	0,283	0,306	0,329
4	0,105	0,112	0,123	0,125	0,103	0,120	0,129	0,153	0,175	0,198	0,217	0,235	0,252
5	0,088	0,094	0,103	0,106	0,087	0,101	0,109	0,129	0,148	0,167	0,183	0,198	0,213
6		0,083	0,091	0,093	0,076	0,089	0,096	0,114	0,130	0,147	0,161	0,175	0,187
7				0,084	0,069	0,080	0,087	0,103	0,118	0,133	0,146	0,158	0,169
8					0,063	0,074	0,080	0,095	0,108	0,122	0,134	0,145	0,156
9					0,059	0,069	0,074	0,088	0,101	0,114	0,125	0,135	0,145
10							0,070	0,083	0,095	0,107	0,117	0,127	0,136
11								0,078	0,089	0,101	0,111	0,120	0,129
12									0,085	0,096	0,105	0,114	0,122
13										0,092	0,101	0,109	0,117
14											0,097	0,105	0,112
15												0,101	0,108
16													0,104
T Ap (mm)	0,660	0,787	0,864	0,965	0,914	1,067	1,219	1,524	1,829	2,159	2,464	2,769	3,073

NOTE: Always allow 0,08–0,13mm extra stock for full profile inserts.

UN Thread, Internal Thread Cutting

TPI	24	20	18	16	14	12	11	10	9	8	7	6	5
T Ap (mm)	0,584	0,686	0,762	0,864	0,991	1,143	1,245	1,372	1,524	1,727	1,956	2,286	2,743
N Ap	5	6	6	7	8	9	9	10	11	12	13	14	15
	values for flank infeed (X/Z)												
order of passes	X/Z	X/Z	X/Z	X/Z	X/Z	X/Z	X/Z	X/Z	X/Z	X/Z	X/Z	X/Z	X/Z
1	0,160	0,168	0,187	0,193	0,205	0,221	0,241	0,250	0,264	0,285	0,309	0,347	0,402
2	0,132	0,139	0,154	0,159	0,169	0,183	0,199	0,207	0,218	0,236	0,255	0,287	0,332
3	0,121	0,127	0,141	0,146	0,155	0,167	0,182	0,189	0,200	0,216	0,234	0,263	0,304
4	0,093	0,097	0,108	0,112	0,119	0,128	0,140	0,145	0,153	0,166	0,179	0,202	0,233
5	0,078	0,082	0,091	0,094	0,100	0,108	0,118	0,123	0,129	0,140	0,151	0,170	0,196
6		0,072	0,080	0,083	0,088	0,095	0,104	0,108	0,114	0,123	0,133	0,150	0,173
7				0,075	0,080	0,086	0,094	0,098	0,103	0,111	0,120	0,135	0,156
8					0,073	0,079	0,086	0,090	0,095	0,102	0,111	0,124	0,144
9						0,074	0,080	0,084	0,088	0,095	0,103	0,116	0,134
10								0,078	0,083	0,089	0,097	0,109	0,126
11									0,078	0,085	0,092	0,103	0,119
12										0,080	0,087	0,098	0,113
13											0,083	0,094	0,108
14												0,080	0,104
15													0,100
16													
T Ap (mm)	0,584	0,686	0,762	0,864	0,991	1,143	1,245	1,372	1,524	1,727	2,036	2,286	2,743

NOTE: Always allow 0,08–0,13mm extra stock for full profile inserts.

Threading Infeed Tables

NPT Thread, External, and Internal Machining

TPI	27	18	14	11,5	8
T Ap (mm)	0,762	1,118	1,422	1,727	2,489
N Ap	6	8	10	12	14
	values for flank infeed (X/Z)				
order of passes	X/Z	X/Z	X/Z	X/Z	X/Z
1	0,187	0,231	0,260	0,285	0,378
2	0,154	0,191	0,214	0,236	0,312
3	0,141	0,175	0,196	0,216	0,286
4	0,108	0,134	0,151	0,166	0,219
5	0,091	0,113	0,127	0,140	0,185
6	0,080	0,100	0,112	0,123	0,163
7		0,090	0,101	0,111	0,147
8		0,083	0,093	0,102	0,135
9			0,087	0,095	0,126
10			0,081	0,089	0,118
11				0,085	0,112
12				0,080	0,107
13					0,102
14					0,098
15					
16					
T Ap (mm)	0,762	1,118	1,422	1,727	2,489

NOTE: Always allow 0,08–0,13mm extra stock for full profile inserts.

BSPT Thread, External, and Internal Machining

TPI	28	19	14	11
T Ap (mm)	0,584	0,864	1,168	1,448
N Ap	5	8	10	12
	values for flank infeed (X/Z)			
order of passes	X/Z	X/Z	X/Z	X/Z
1	0,160	0,179	0,213	0,239
2	0,132	0,148	0,176	0,197
3	0,121	0,135	0,161	0,181
4	0,093	0,104	0,124	0,139
5	0,078	0,087	0,104	0,117
6		0,077	0,092	0,103
7		0,070	0,083	0,093
8		0,064	0,076	0,086
9			0,071	0,080
10			0,067	0,075
11				0,071
12				0,067
13				
14				
15				
16				
T Ap (mm)	0,584	0,864	1,168	1,448

Trapezoid Thread to DIN 103, External, and Internal Machining

pitch	1,5	2	3	4	5
T Ap (mm)	1,016	1,245	1,753	2,261	2,743
N Ap	6	8	10	12	14
	values for flank infeed (X/Z)				
order of passes	X/Z	X/Z	X/Z	X/Z	X/Z
1	0,249	0,258	0,320	0,373	0,417
2	0,206	0,213	0,264	0,308	0,344
3	0,188	0,195	0,242	0,282	0,315
4	0,144	0,150	0,186	0,217	0,242
5	0,122	0,126	0,157	0,183	0,204
6	0,107	0,111	0,138	0,161	0,180
7		0,100	0,125	0,145	0,162
8		0,092	0,115	0,134	0,149
9			0,107	0,125	0,139
10			0,100	0,117	0,131
11				0,111	0,123
12				0,105	0,117
13					0,112
14					0,108
15					
16					
T Ap (mm)	1,016	1,245	1,753	2,261	2,743

NOTE: Always allow 0,08–0,13mm extra stock for full profile inserts.

Round Thread to DIN 405, External, and Internal Machining

pitch	10	8	6
T Ap (mm)	1,321	1,626	2,159
N Ap	8	10	12
	values for flank infeed (X/Z)		
order of passes	X/Z	X/Z	X/Z
1	0,273	0,297	0,357
2	0,226	0,245	0,294
3	0,207	0,224	0,270
4	0,159	0,172	0,207
5	0,134	0,145	0,174
6	0,118	0,128	0,154
7	0,107	0,116	0,139
8	0,098	0,106	0,128
9		0,099	0,119
10		0,093	0,112
11			0,106
12			0,100
13			
14			
15			
16			
T Ap (mm)	1,321	1,626	2,159

NOTE: Always allow 0,08–0,13mm extra stock for full profile inserts.

Threading Infeed Tables

Whitworth, External, and Internal Thread Cutting

TPI	28	20	19	16	14	12	11	10	9	8	7	6	5
T Ap (mm)	0,584	0,813	0,813	0,864	1,016	1,346	1,473	1,626	1,803	2,032	2,311	2,718	3,251
N Ap	5	6	6	8	8	9	9	10	11	12	14	15	16
	values for flank infeed (X/Z)												
order of passes	X/Z	X/Z	X/Z	X/Z	X/Z	X/Z	X/Z	X/Z	X/Z	X/Z	X/Z	X/Z	X/Z
1	0,160	0,199	0,199	0,179	0,210	0,261	0,285	0,297	0,312	0,336	0,351	0,398	0,460
2	0,132	0,164	0,164	0,148	0,174	0,215	0,236	0,245	0,258	0,277	0,290	0,329	0,380
3	0,121	0,151	0,151	0,135	0,159	0,197	0,216	0,224	0,236	0,254	0,266	0,301	0,348
4	0,093	0,116	0,116	0,104	0,122	0,151	0,166	0,172	0,181	0,195	0,204	0,231	0,267
5	0,078	0,097	0,097	0,087	0,103	0,128	0,140	0,145	0,153	0,164	0,172	0,195	0,225
6		0,086	0,086	0,077	0,091	0,112	0,123	0,128	0,135	0,145	0,151	0,171	0,198
7				0,070	0,082	0,102	0,111	0,116	0,122	0,131	0,137	0,155	0,179
8				0,064	0,075	0,093	0,102	0,106	0,112	0,120	0,126	0,143	0,165
9						0,087	0,095	0,099	0,104	0,112	0,117	0,133	0,153
10								0,093	0,098	0,105	0,110	0,125	0,144
11									0,093	0,099	0,104	0,118	0,136
12										0,095	0,099	0,112	0,130
13											0,095	0,107	0,124
14												0,091	0,103
15													0,099
16													0,110
T Ap (mm)	0,584	0,813	0,813	0,864	1,016	1,346	1,473	1,626	1,803	2,032	2,311	2,718	3,251

NOTE: Always allow 0,08–0,13mm extra stock for full profile inserts.

Multi-Tooth Threads, Internal

type	ISO metric						ISO UN					Whitworth	NPT		
	3M	2M	3M	2M	3M	2M	2M	3M	2M	3M	2M	2M	3M	2M	
pitch (mm)	1,0	1,5	1,5	2,0	2,0	3,0	—	—	—	—	—	—	—	—	
TPI	—	—	—	—	—	—	16	16	12	12	8	11	11,5	11,5	8
total depth (mm)	0,609	0,838	0,838	1,168	1,168	1,778	0,939	0,939	1,245	1,245	1,880	1,575	1,753	1,753	2,540
pass 10mm	0,330	0,381	0,508	0,508	0,711	0,558	0,431	0,558	0,558	0,762	0,584	0,736	0,584	0,812	0,889
2	0,279	0,254	0,330	0,381	0,457	0,482	0,304	0,381	0,406	0,482	0,508	0,482	0,508	0,558	0,635
3	—	0,203	—	0,279	—	0,431	0,203	—	0,279	—	0,431	0,355	0,355	0,381	0,558
4	—	—	—	—	—	0,304	—	—	—	—	0,355	—	0,304	—	0,457

Recommendations for Steel Workpieces (<300 BHN)

catalogue number	insert size	TPI profile	total depth — on radius		
			1st pass	2nd pass	3rd pass
NTC-8R/L8EM	8	8 UN	1,21	1,63	2,00
NTC-8R/L8IM	8	8 UN	1,19	1,55	1,88
NTC-8R/L10EM	8	10 UN	0,92	1,27	1,60
NTC-8R/L10IM	8	10 UN	0,90	1,22	1,52
NTC-8R/L12EM	8	12 UN	0,76	1,04	1,32
NTC-8R/L12IM	8	12 UN	0,76	0,93	1,20
NTC-8R/L14EM	8	14 UN	0,68	0,95	1,12
NTC-8R/L14IM	8	14 UN	0,60	0,78	1,04
NTC-8R/L16EM 8	8	16 UN	0,58	0,81	0,96
NTC-8R/L16IM	8	16 UN	0,50	0,68	0,93
NTC-8R/L18EM	8	18 UN	0,48	0,66	0,86
NTC-8R/L18IM	8	18 UN	0,48	0,60	0,83
NDC-68RDR/L-75M	8	8 round	1,47	1,65	1,85
NDC-61RDR/L-75M	8	10 round	1,11	1,29	1,45
NDC-88RDR/L-75M	8	8 round	1,29	1,75	1,85
NDC-88VR/L-75M	8	8 NPT	1,01	1,72	2,45
NDC-8115VR/L-75M	8	11,5 NPT	0,96	1,37	1,70
NDN-814VR/L-75M	8	14 NPT	0,96	1,22	1,36

TopThread™

The following charts list the largest thread pitch that can be applied on internal applications using TopThread threading inserts for 60° V-threading and Acme threading.

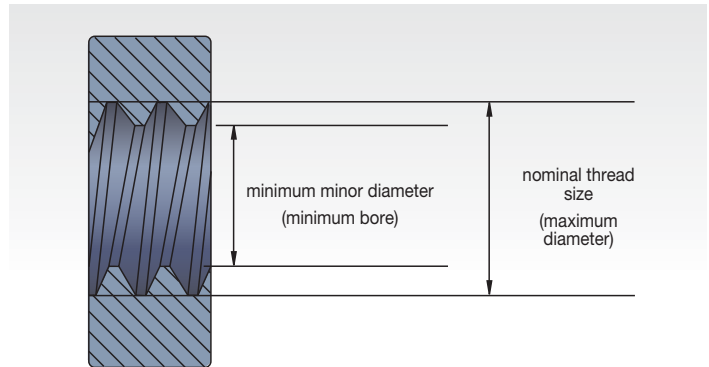

Metric-sized 60° V-Threading Limits

internal threading limitations NT-1, NT-2 60° V-threading inserts

TPI	nominal thread size		minimum thread diameter (inch)	
	NT-1	NT-2	NT-1	NT-2
4,00	M48 x 4.00	–	43,67	–
3,00	M42 x 3.00	–	38,75	–
2,50	M39 x 2.50	M24 x 2,50	36,29	21,29
2,00	M33 x 2.00	M15 x 2,00	30,84	12,84
1,75	M32 x 1.75	M15 x 1,75	30,11	13,11
1,50	M32 x 1.50	M15 x 1,50	30,38	13,38
1,25	M29 x 1.29	M14 x 1,25	27,65	12,65
1,00*	M27 x 1.00	M14 x 1,00	25,92	12,92
0,75	M22 x 0.75	M12 x 0,75	21,19	11,19

*Thread pitch of 1mm and less can be cut with an NT-2 insert provided the core thread diameter is 25mm or larger (11mm or larger with NT-1).

Internal threading limitations NT-3 and NT-4 60° V-threading inserts

TPI	nominal thread size	minimum thread diameter (mm)
6,00**	M76 x 6.00	69,50
5,50**	M73 x 5.50	67,05
5,00	M70 x 5.00	64,59
4,00	M64 x 4.00	59,67
3,00	M52 x 3.00	48,75
2,50	M48 x 2.50	45,29
2,00	M42 x 2.00	39,84
1,75	M40 x 1.75	38,11
1,50*	M38 x 1.50	36,38

*Thread pitch of 1,5mm and less can be cut provided core thread diameter is 35mm or larger.

**NT-4-insert only.

NOTE: Always allow 0,08–0,13mm extra stock for full profile inserts.

Acme Threading Limits

internal threading limitations NA and NAS-2, -3, -4, and -6 Acme threading inserts

TPI	nominal thread size	minimum thread diameter (mm)	
	NT-1	NT-1	NT-2
2**	5	4.500	114.3
2-1/2**	4-1/2	4.100	104.1
3**	4	3.665	93.1
4	3-1/2	3.250	82.6
5	3	2.800	71.1
6	2-1/2	2.333	59.3
8	2-1/4	2.125	54.0
10	2	1.900	48.3
12	1-3/4	1.667	42.4
14	1-5/8	1.554	39.5
16*	1-1/2	1.438	36.5

*Sixteen threads per inch and finer can be cut provided minor diameter is 36,5mm or larger.

**NA-6 insert only.

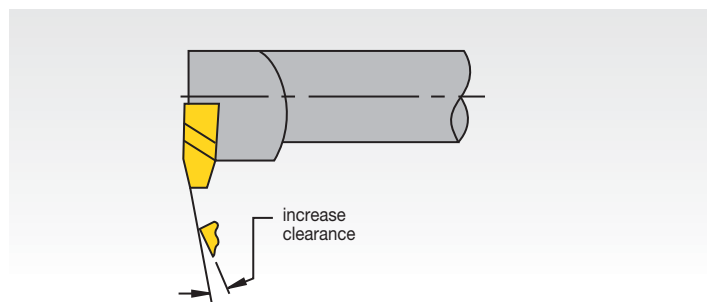

Additional secondary clearance can be ground on leading edge of insert to provide sufficient helical clearance for machining coarser threads and multiple start threads. Modified standard inserts may be furnished for machining threads outside of the limits shown.

TopThread™

60° V-Thread Crest Turning Application Data

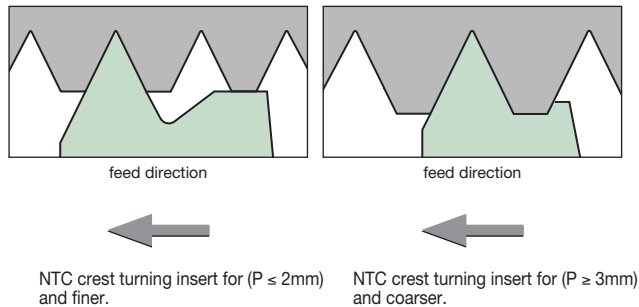

NOTE: NTC inserts automatically control root to crest dimensions. Therefore, in setting up threading operations with NTC inserts, check the O.D. or I.D. at the thread crest for correct dimensions.

60° V-Thread Crest Turning Application Data

insert catalogue number	nose radius on insert (mm)	thread radius per MIL-S-8879A (mm)
NJ-3014R/L12	0,317/0,342	0,317/0,381
NJK-3008R/L20	0,190/0,215	0,190/0,0228

“J” thread note for catalog

The controlled root radius thread form (SAE8879C) is defined for the external thread only. To machine the corresponding internal thread, choose any insert that will cut a unified class 2B thread, then bore the minor diameter to size. Refer to SAE8879C and MIL-S-8879C and SAEAS8879D for the correct “J” thread minor diameter values.

60° V-Thread Application Data

insert description	insert	D (mm)	E (mm)	recommended TPI*		recommended TP*	
				external	internal	external	internal
<p>“E”</p> <p>radius</p> <p>“D”</p> <p>NT-NTP-</p> <p>feed direction</p>	NT-1	1,90	1,11	–	24–12	–	1,00–2,00
	NT-2	28,70	1,90	36–8	20–7	0,70–3,00	1,25–3,50
	NT-2-K	28,70	1,90	36–8	20–7	0,70–3,00	1,25–3,50
	NTF-2	15,75	1,01	44–14	24–12	0,60–1,75	1,00–2,00
	NTK-2	15,75	1,01	44–14	24–12	0,60–1,75	1,00–2,00
	NTP-2	28,70	1,90	36–8	20–7	0,70–3,0	1,25–3,50
	NT-3	37,59	2,46	20–6	12–5	1,25–4,00	2,00–5,00
	NT-3-K	37,59	2,46	20–6	12–5	1,25–4,00	2,00–5,00
	NT-3-C	37,59	2,46	11–6	6 (only)	2,50–4,00	4,00 (only)
	NT-3-CK	37,59	2,46	11–6	6 (only)	2,50–4,00	4,00 (only)
<p>“E”</p> <p>radius</p> <p>“D”</p> <p>NTF-NTK-</p> <p>feed direction</p>	NTF-3	21,08	1,37	44–10	24–9	0,60–2,50	1,00–2,50
	NTK-3	21,08	1,37	44–10	24–9	0,60–2,50	1,00–2,50
	NTP-3	37,59	2,46	20–6	12–5	1,25–4,00	2,00–5,00
	NT-4	49,78	3,22	20–4	12–4	1,25–6,25	2,00–6,25
	NT-4-K	49,78	3,22	20–4	12–4	1,25–6,25	2,00–6,25
	NT-4-C	49,78	3,22	11–4 1/2	6–4 1/2	2,50–5,50	4,00–5,50
	NT-4-CK	49,78	3,22	11–4 1/2	6–4 1/2	2,50–5,50	4,00–5,50
	NTF-4	21,08	1,37	44–10	24–9	0,60–2,50	1,00–2,50
	NTK-4	21,08	1,37	44–10	24–9	0,60–2,50	1,00–2,50
	NTP-4	49,78	3,22	20–4	12–4	1,25–6,25	2,00–6,25

*Based on maximum insert radius size and class 2A and 2B thread specifications.

TopThread™

API Thread Forms • Insert Applications Chart for API Rotary Shouldered Connections

thread form	WIDIA™ insert		tool joint application	minimum box size*
	cresting	non-cresting		
V-.038R 2" TPF 4 TPI	NDC-4038R/L2 4-E/IR4API382	ND-3038R/L	2-3/8 API internal flush 2-7/8 API internal flush 3-1/2 API internal flush 4 API internal flush 4-1/2 API internal flush 5-1/2 API internal flush 6-5/8 API internal flush 4 API full hole API #23, API #26, API #31, API #35, API #38, API #40, API #44, API #46, API #50	API #31 2-7/8 IF
V-.038R 3" TPF 4 TPI	NDC-4038R/L3 4-E/IR4API383	ND-3038R/L	API #56 API #61 API #70 API #77	API #56
V-.050 2" TPF 4 TPI	NDC-4050R/L2 4-E/IRAPI502	ND-4050R/L	5-1/2 API full hole 6-5/8 API regular 6-5/8 API full hole	5-1/2 API full hole
V-.050 3" TPF 4 TPI	NDC-4050R/L3 4-E/IR4API503	ND-4050R/L	5-1/2 API regular 7-5/8 API regular 8-5/8 API regular	5-1/2 API regular
V-.040 3" TPF 5 TPI	NDC-3040R/L3 NDC-4040R/L3 4-E/IR5API403	ND-3040R/L ND-4040R/L	2-3/8 API regular 2-7/8 API regular 3-1/2 API regular 4-1/2 API regular	3-1/2 API regular

*Minimum box size that can be threaded with a standard TopThread insert due to minimum bore equipment.

API Thread Forms

Product Thread Dimensions • Rotary Shouldered Connections (Inch)

threadform	taper inch per ft.	thread height, not truncated H	thread height, truncated $h_n = h_s$	root truncation $S_m = S_{rs}$ $f_m = f_{rs}$	crest truncation $f_{cn} = f_{cs}$	width of flat		root radius $r_m = r_{rs}$	radius at thread corners r	pitch p
						crest $f_{cn} = f_{cs}$	crest $f_m = f_{rs}$			
V-.038R	2	.216005	.121844	.038000	.056161	.065	—	.038	.015	.250
V-.038R	3	.215379	.121381	.038000	.055998	.065	—	.038	.015	.250
V-.040	3	.172303	.117842	.020000	.034461	.040	—	.020	.015	
V-.050	3	.215379	.147303	.025000	.043076	.050	—	.025	.015	.250
V-.050	2	.216005	.147804	.025000	.043201	.050	—	.025	.015	

NOTE: All dimensions in inches.

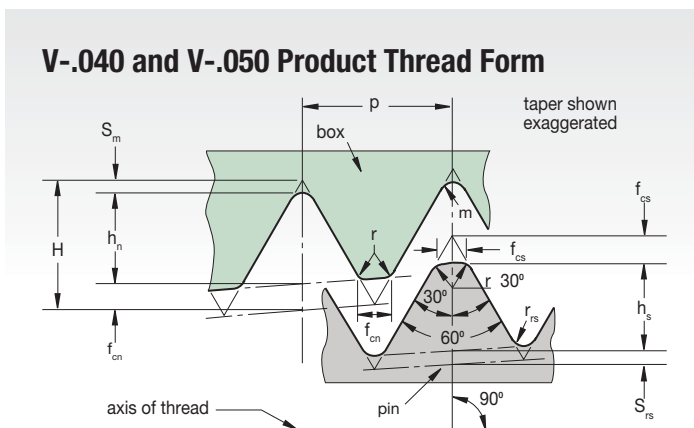

Casing and Tubing Round Thread (Height Dimensions)

thread element	10 TPI p= .1000	8 TPI p= .1250
H	= .866p	.10825
$H_s = h_n$	= .626p - .007	.07125
$S_{rs} = S_m$	= .120p + .002	.01700
$S_{cs} = S_{cn}$	= .120p + .005	.02000

TopThread™

American Buttress (7° Pressure Flank Leading) NTB-A Inserts • Push Type

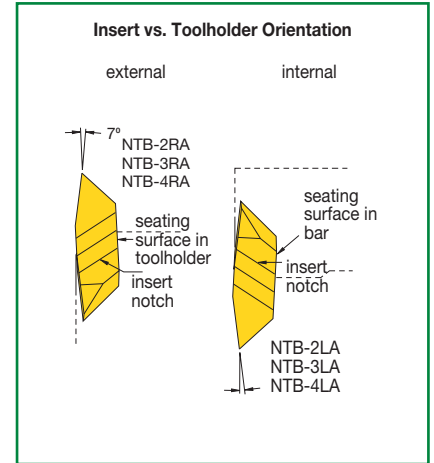
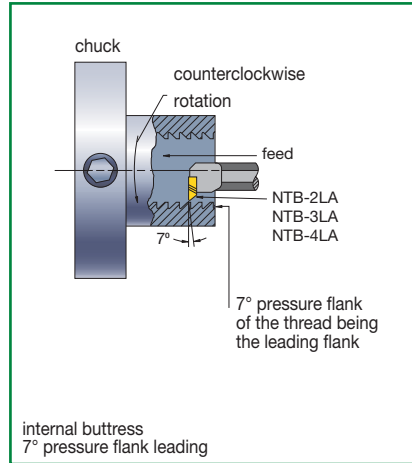
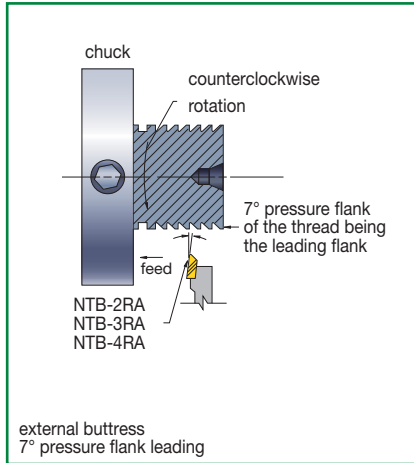

Reference Dimensions

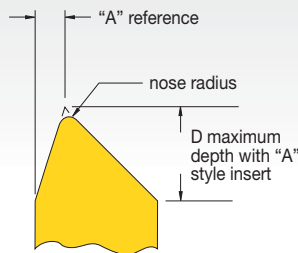

insert	D (inch)	"A" ref. (inch)	nose radius (inch)	pitch based on maximum radius
NTB-2A	.133	.024	.002-.004	16-20 TPI
NTB-3A	.171	.031	.005-.008	8-16 TPI
NTB-4A	.218	.049	.008-.012	4-6 TPI

NOTE: For balanced chip load, 15° infeed angle is suggested.

Infeed Angle vs. Chip Load: 7° Pressure Flank Leading

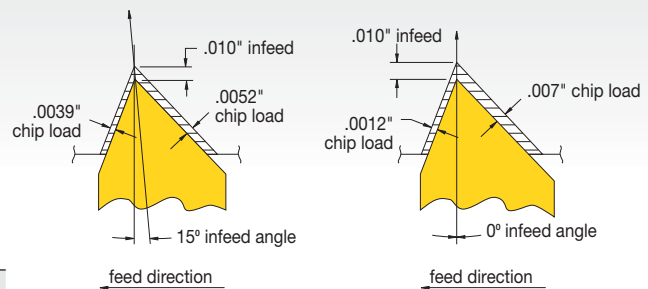

NTB-A insert

Internal Threading Limitations

internal threading limitations NTB-2A Buttress threading inserts

TPI	nominal thread size	minimum minor diameter (inch)
8	1-3/4	1.600
10	1-5/8	1.505
12	1-1/2	1.400
16	1-1/4	1.175
20	1-1/16	1.002

internal threading limitations NTB-3 and NTB-4A Buttress threading inserts

TPI	nominal thread size	minimum minor diameter (inch)
4*	2-1/2	2.200
5	2-1/4	2.010
6	2	1.800
8	1-3/4	1.600
10	1-5/8	1.505
12**	1-1/2	1.400

*NTB-4A insert only.

**Can cut 16 or 20 threads per inch provided minor diameter is 1.375" or larger.

Threads per Inch vs. Maximum Root Radius Chart (Inch)

TPI	20	16	12	10	8	6	5	4	3	2-1/2	2	1-1/2	1-1/4	1
maximum root radius	.0036	.0045	.0059	.0071	.0089	.0119	.0143	.0179	.0238	.0268	.0375	.0476	.0572	.0714

NOTE: Special buttress forms are available upon request.

TopThread™

American Buttress (45° Clearance Flank Leading): NTB-B Inserts • Pull Type

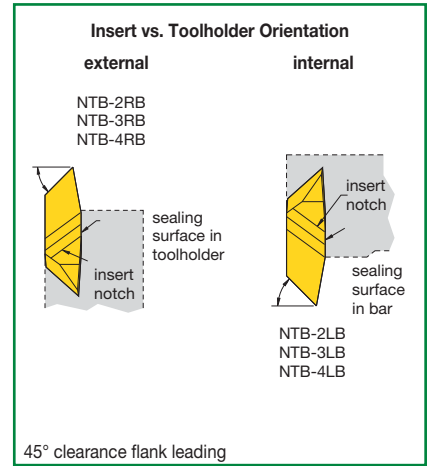
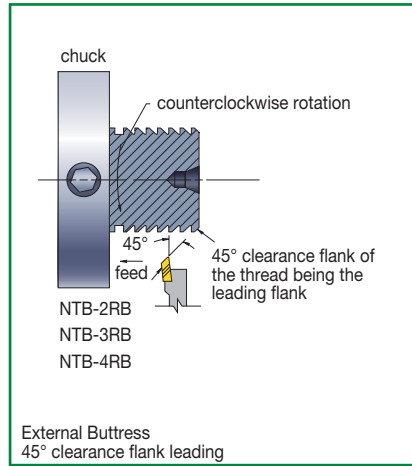
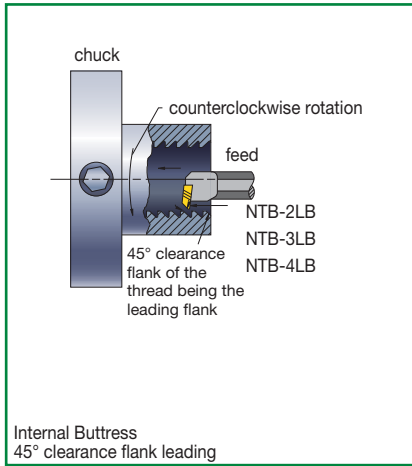

Reference Dimensions

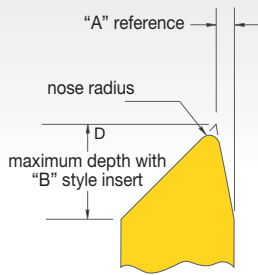

Infeed Angle vs. Chip Load: 45° Clearance Flank Leading

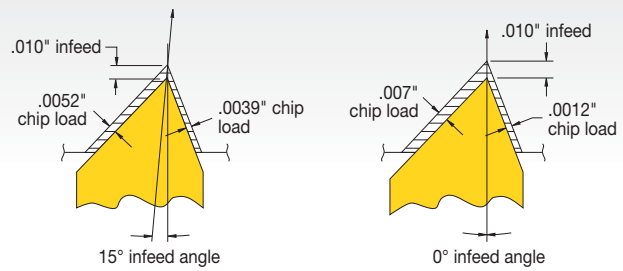

NTB-B insert

insert	D (inch)	"A" reference (inch)	nose radius (inch)	pitch based on maximum radius
NTB-3B	.171	.031	.005-.004	8-16 TPI

NOTE: For balanced chip load, a reverse 15° infeed angle is suggested.

Internal Threading Limitations

TPI	nominal thread size	minimum minor diameter (inch)
8	1-3/4	1.600
10	1-5/8	1.505
12	1-1/2	1.400
16	1-1/4	1.175
20	1-1/16	1.002

TPI	nominal thread size	minimum minor diameter (inch)
4*	2-7/8	2.575
5	2-3/4	2.510
6	2-3/8	2.175
8	2-1/8	1.975
10	1-7/8	1.755
12	1-5/8	1.525
16	1-1/2	1.407
20	1-7/16	1.378

*NTB-4B insert only.

External Laydown Threading

Required Information

From Part Drawing:

material: 316SS, 200 HB
 thread form: 8UN Class 2A
 operation: external threading
 pitch diameter: 50mm x 25mm deep

From Machine Set-Up Data:

tooling: 20mm x 20mm
 spindle rotation: counter-clockwise
 feed: toward chuck

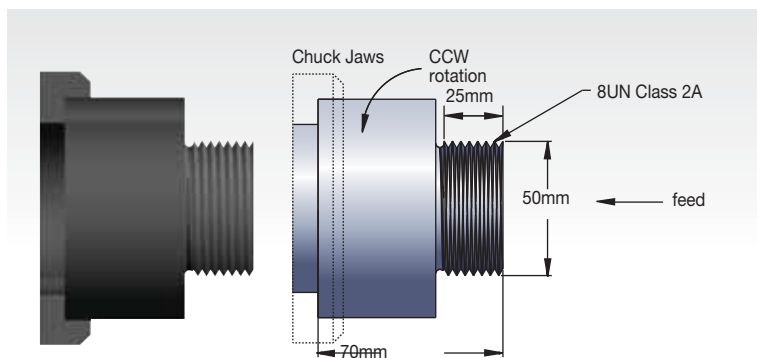

Steps for a Successful Threading Operation

Step 1 • Determine Threading Method

Need to Know:

- Operation (external).
- Spindle rotation (CCW). Counterclockwise rotation.
- Feed direction (toward chuck).
- Right-hand toolholder.
- Right-hand insert (ER).
- Standard helix method.

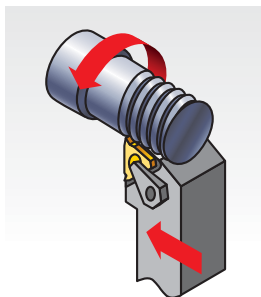

Step 2 • Select Insert



Need to Know:

- Thread form (ISO R262 1mm pitch).
- Hand of insert (right hand – ER).

Choose the High-Performance Solution

catalogue number	insert size	TN6025
3ER10ISO	3	•

High-Performance Selection

NOTE: Use insert with largest insert size available.

insert: 3ER10ISO

grade: TN6025

speed: 150 m/min

Step 3 • Select the Grade and Speed

Need to Know:

- Workpiece material (316SS-200HB).
- Operation (external).

Options: Grade and Speed Selection Guidelines

threading operation	stainless steel
external	general purpose and high performance
	KC6025
	30–360 SFM

Step 4 • Select Toolholder

Need to Know:

- External or internal operation (external).
- Pitch diameter to determine minimum bore diameter (N/A).
- Type of tooling — toolholder, boring bar (toolholder).
- Hand of tool (right hand).
- Insert size (16).

Options:

catalogue number	insert size	shim
AL203R	3	SM-YE3

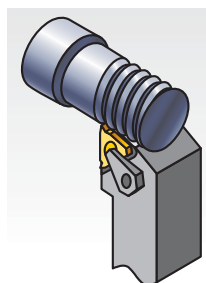

Step 5 • Select Shim

Need to Know:

- Thread form — TPI or pitch (8 TPI).
- Pitch diameter (50mm).
- Helix method (standard). See Laydown Threading (LT) shim selection chart.

Select SM-YE3 shim

NOTE: For this application, the standard shim supplied should be replaced with the recommended shim, SM-YE3.

Internal Laydown Threading

Required Information

From Part Drawing:

- material: 4140 steel
- thread form: ISO R262 2,5mm pitch
- operation: internal threading
- pitch diameter: 40mm x 35mm deep

From Machine Set-Up Data:

- tooling: 20mm boring bar
- spindle rotation: clockwise
- feed: away from chuck

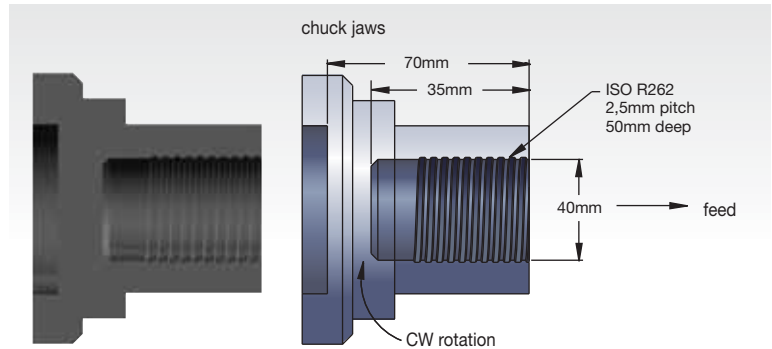

Steps for a Successful Threading Operation

Step 1 • Determine Threading Method

Need to Know:

- Operation (internal).
- Spindle rotation (CW). Clockwise rotation.
- Feed direction (away from chuck).
- Left-hand toolholder.
- Left-hand insert (NL).
- Reverse helix method.

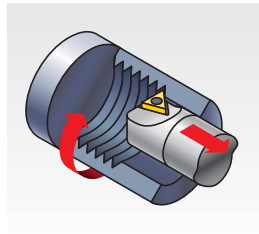

Step 2 • Select Insert



Need to Know:

- Thread form (ISO Metric Class 6G/6H).
- Hand of insert (left hand — NL).

Choose the High-Performance Solution

catalogue number	insert size	TN6025
3IL25ISO	3	•

High-Performance Selection

NOTE: Use insert with largest possible insert size to go into the bore.

insert: 3IL25ISO
grade: TN6025
speed: 130 m/min

Step 3 • Select the Grade and Speed

Need to Know:

- Workpiece material (4010 steel).
- Operation (internal).

Options: Grade and Speed
Selection Guidelines

threading operation	steel
internal	general purpose and high performance
	TN6025
	40-200 m/min

Step 4 • Select Toolholder

Need to Know:

- External or internal operation (internal).
- Pitch diameter to determine minimum bore diameter for internal operations (40mm).
- Type of tooling — toolholder, boring bar (boring bar).
- Hand of tool (left hand).
- Insert size (16).

Options:

catalogue number	insert size	shim
AVR32D3R	3	SM-YE3

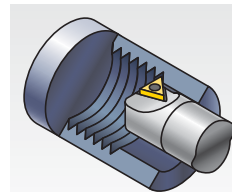

Step 5 • Select Shim

Need to Know:

- Thread form — TPI or pitch (2,5mm pitch).
- Pitch diameter (40mm).
- Helix method (reverse). See Laydown Threading (LT) shim selection chart.

Select SM-YE3-2N

NOTE: For this application, the standard shim supplied should be replaced with the recommended shim, SM-YE3.

Laydown Threading

Laydown Threading Shim Selection Guidelines

It is essential to select the correct shim to ensure thread quality and maximum tool life. These parameters are needed:

- Pitch
- Pitch diameter
- Number of starts
- Feed direction

NOTE: When considering method of thread cutting, the part's shape and stability and the flow of chips are determining factors in your decision.

Laydown Selection Chart

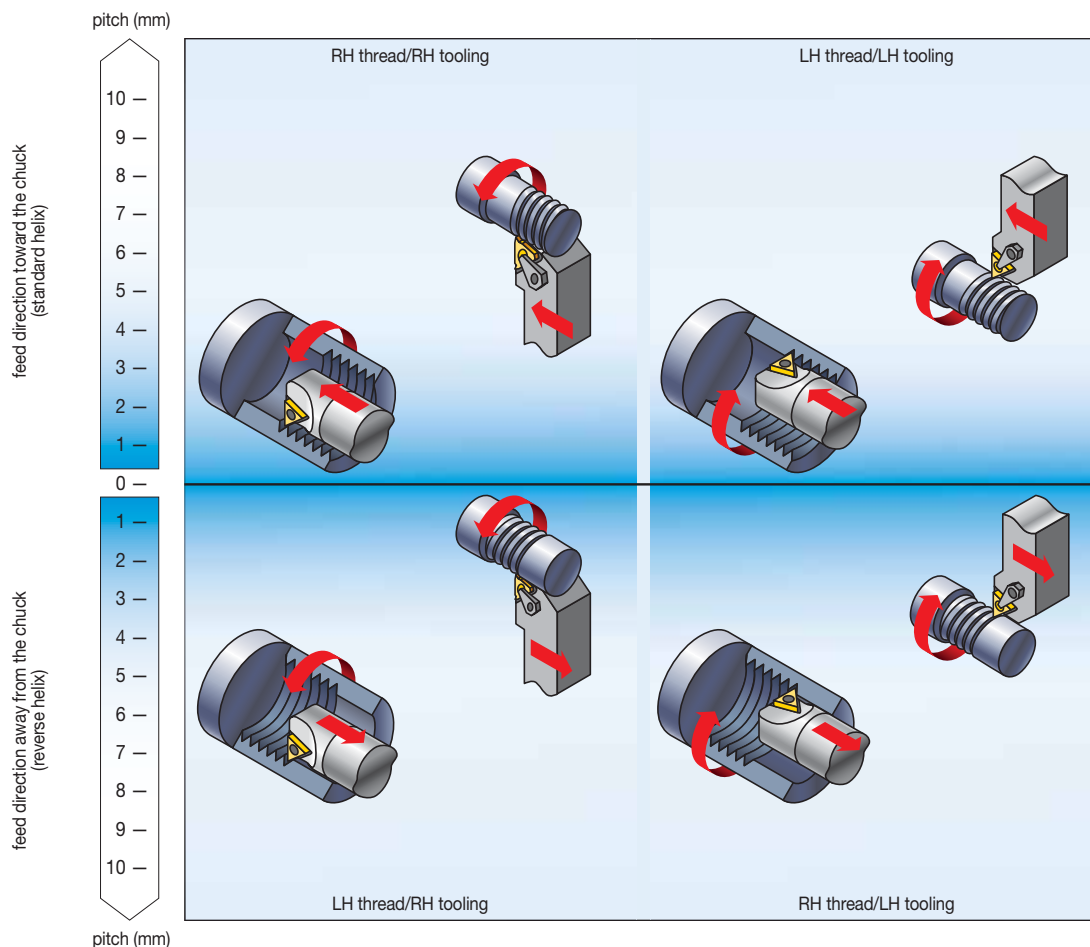

NOTE: For multi-start threads, use the lead value instead of the pitch.

Diagram of Thread Lead Angles

To calculate the lead angle of a given thread, use this formula:

$$\beta = \text{Arctan} \frac{P \cdot S}{\pi D_e}$$

β = thread lead angle
 D_e = effective pitch diameter of thread wear
 $P = 1/\text{TPI}$
 TPI = threads per inch
 S = number of starts
 single-start, lead = pitch
 multiple-start, lead = pitch (x) number of starts

All toolholders are designed with an inclination angle = 1.5°. When turning standard threads with a lead angle of 1–2°, this guarantees adequate clearance at the flanks of the insert's thread tooth. The thread lead angle and the required inclination angle of the insert are given by β .

Cutting edge height is constant at every shim and insert combination. All toolholders are supplied with 1-1/2° lead angle.

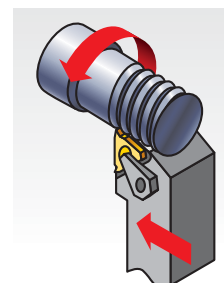

Laydown Threading

Laydown Threading Shim Selection Table • Metric

insert size	toolholder		shim ordering code (mm)							
	external	internal				standard				
3 (9,52)	RH	LH	SM-YE3-3P	SM-YE3-2P	SM-YE3-1P	SM-YE3	SM-YE3-1N	SM-YE3-1.5N	SM-YE3-2N	SM-YE3-3N
3 (9,52)	LH	RH	SM-YI3-3P	SM-YI3-2P	SM-YI3-1P	SM-YI3	SM-YI3-1N	SM-YI3-1.5N	SM-YI3-2N	SM-YI3-3N
4 (12,7)	RH	LH	SM-YE4-3P	SM-YE4-2P	SM-YE4-1P	SM-YE4	SM-YE4-1N	SM-YE4-1.5N	SM-YE4-2N	SM-YE4-3N
4 (12,7)	LH	RH	SM-YI4-3P	SM-YI4-2P	SM-YI4-1P	SM-YI4	SM-YI4-1N	SM-YI4-1.5N	SM-YI4-2N	SM-YI4-3N
TPI	pitch (mm)		pitch diameter (mm)							
72	-	-	-	-	-	3,1-8	8-21,4	>21,4	21,4-8	8-3,1
-	0,35	-	-	-	-	3,0-8	8-21,3	>21,3	21,3-8	3-8
64	-	-	-	-	-	3,4-9	9-24,1	>24,1	24,1-9	9-3,4
-	0,40	-	-	-	-	3,5-9,1	9,1-24,3	>24,3	24,3-9,1	9,1-3,5
56	0,45	-	-	-	-	3,9-10,3	10,3-27,6	>27,6	27,6-10,3	10,3-3,9
-	0,50	-	-	-	2,8-4,3	4,3-11,4	11,4-30,4	>30,4	30,4-11,4	11,4-4,3
48	-	-	-	-	3-4,6	4,6-12,1	12,1-32,2	>32,2	32,2-12,1	12,1-4,6
44	-	-	-	-	3,3-5	5-13,2	13,2-35,1	>35,1	35,1-13,2	13,2-5
-	0,60	-	2,6-3,4	3,4-5,2	5,2-13,7	13,7-36,5	>36,5	36,5-13,7	13,7-5,2	5,2-2,6
40	-	-	2,8-3,6	3,6-5,5	5,5-14,5	14,5-38,6	>38,6	38,6-14,5	14,5-5,5	5,5-2,8
-	0,70	-	3,0-4	4-6,1	6,1-16	16-42,6	>42,6	42,6-16	16-6,1	6,1-3,0
36	-	-	3,1-4	4-6,1	6,1-16,1	16,1-42,9	>42,9	42,9-16,1	16,1-6,1	6,1-3,1
-	0,75	-	2,8-3,2	3,3-4,3	4,3-6,5	6,5-17,1	17,1-45,6	>45,6	45,6-17,1	17,1-6,5
32	-	-	3-3,4	3,4-4,5	4,5-6,9	6,9-18,1	18,1-48,3	>48,3	48,3-18,1	18,1-6,9
-	0,80	-	3-3,5	3,5-4,6	4,6-6,9	6,9-18,2	18,2-48,6	>48,6	48,6-18,2	18,2-6,9
28	-	-	3,4-3,9	3,9-5,2	5,2-7,9	7,9-20,7	20,7-55,1	>55,1	55,1-20,7	20,7-7,9
27	-	-	3,6-4,1	4,1-5,4	5,4-8,2	8,2-21,4	21,4-57,2	>57,2	57,2-21,4	21,4-8,2
-	1,00	-	3,8-4,3	4,3-5,7	5,7-8,7	8,7-22,8	22,8-60,8	>60,8	60,8-22,8	22,8-8,7
24	-	-	4-4,6	4,6-6	6-9,2	9,2-24,1	24,1-64,3	>64,3	64,3-24,1	24,1-9,2
-	1,25	-	4,7-5,4	5,4-7,1	7,1-10,8	10,9-28,5	28,5-76	>76,0	76-28,5	28,5-10,8
20	-	-	4,8-5,5	5,5-7,2	7,2-11	11-28,9	29-77,2	>77,2	77,2-28,9	28,9-11
18	-	-	5,3-6,1	6,1-8	8-12,2	12,2-32,2	32,2-85,8	>85,8	85,8-32,2	32,2-12,2
-	1,50	-	5,7-6,5	6,5-8,5	8,5-13	13-34,2	34,2-91,2	>91,2	91,2-34,2	34,2-13
16	-	-	6-6,9	6,9-9	9-13,8	13,8-36,2	36,2-96,5	>96,5	96,5-36,2	36,2-13,8
-	1,75	-	6,6-7,96	7,6-10	10-15,2	15,2-39,9	39,9-106,4	>106,4	106,4-39,9	39,9-15,2
14	-	-	6,9-10,3	7,9-10,3	10,3-15,7	15,7-41,4	41,4-110,3	>110,3	110,3-41,4	41,4-15,7
13	-	-	7,4-8,5	8,5-11,1	11,1-17	17-44,5	44,5-118,8	>118,8	118,8-44,5	44,5-17
-	2,00	-	7,6-8,7	8,7-11,4	11,4-17,4	17,4-45,6	45,6-121,6	>121,6	121,6-45,6	45,6-17,4
12	-	-	8-9,2	9,2-12	12,1-18,4	18,4-48,2	48,3-128,7	>128,7	128,7-48,2	48,2-18,4
11,5	-	-	8,4-9,6	9,6-12,6	12,6-19,2	19,2-50,3	50,3-134,3	>134,3	134,3-50,3	50,3-19,2
11	-	-	8,8-10	10-13,1	13,1-20	20-52,6	52,6-140,4	>140,4	140,4-52,6	52,6-20
-	2,50	-	9,5-10,8	10,8-14,2	14,2-21,7	21,7-57	57-152	>152,0	152-57	57-21,7
10	-	-	9,6-11	11-14,5	14,5-22	22-57,9	57,9-154,4	>154,4	154,4-57,9	57,9-22
9	-	-	10,7-12,2	12,2-16,1	16,1-24,5	24,5-64,3	64,3-171,6	>171,6	171,6-64,3	64,3-24,5
-	3,00	-	11,4-13	13-17,1	17,1-26	26-68,4	68,4-182,4	>182,4	182,4-68,4	68,4-26
8	-	-	12-13,8	13,8-18,1	18,1-27,6	27,6-72,4	72,4-193	>193,0	193-72,4	72,4-27,6
-	3,50	-	13,3-15,2	15,2-19,9	19,9-30,4	30,4-79,8	79,8-212,8	>212,8	212,8-79,8	79,8-30,4
7	-	-	13,8-15,7	15,7-20,7	20,7-31,5	31,5-82,7	82,7-220,6	>220,6	220,6-82,7	82,7-31,5
-	4,00	-	15,2-17,3	17,3-22,8	22,8-34,7	34,7-91,2	91,2-243,2	>243,2	243,2-91,2	91,2-34,7
6	-	-	16-18,3	18,3-24,1	24,1-36,7	36,7-96,5	96,5-257,4	>257,4	257,4-96,5	96,5-36,7
-	5,00	-	19-21,7	21,7-28,5	28,5-43,4	43,4-114	114-304	>304,0	304-114	114-43,4
5	-	-	19,3-22	22-28,9	28,9-44,1	44,1-115,8	115,8-308,8	>308,8	308,8-115,8	115,8-44,1
4,5	-	-	21,4-24,5	24,5-32,1	32,1-49	49-128,7	128,7-343,1	>343,1	343,1-128,7	128,7-49
-	6,00	-	22,7-26	26-34,2	34,2-52,1	52,1-136,8	136,8-364,8	>364,8	364,8-136,8	136,8-52,1
4	-	-	24,1-27,5	27,5-36,2	36,2-55,1	55,1-144,8	144,8-386	>386	386-144,8	144,8-55,1
inclination angle			4.5	3.5	2.5	1.5	0.5	0.0	-0.5	-1.5
			standard helix (feed toward the chuck)				reverse helix (feed away from the chuck)			

1. Select TPI or pitch from the left-hand columns.
2. Follow row to specified pitch diameter and the correct feed direction.
3. Follow the column to the top for the required shim based on the toolholder and insert size.

standard helix method:

Used when RH thread is cut with RH tool or LH thread with LH tool.

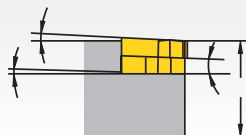

reverse helix method:

Used when RH thread is cut with LH tool or when LH thread is cut with RH tool.

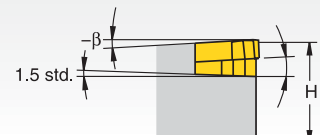

GET FAST AND RELIABLE ANSWERS TO YOUR TOUGHEST METALCUTTING PROBLEMS.

Our Customer Application Support (CAS) Team is the metalworking industry's leading help desk resource for tooling application solutions and problem resolution.

- Easy access to proven metalworking expertise.
- Service level excellence.
- Best-in-class application support tools and technology.

Easy access to proven metalworking expertise!

WIDIA™ Customer Application Engineers assist customers and engineering groups throughout the world with expert tool selection and application recommendations for the entire range of WIDIA tooling.

Service Level Excellence:

- Fast telephone response.
- Quick technical solutions.
- Efficient case management.

Services Provided:

- Tooling selection.
- Operating parameters.
- Troubleshooting.
- Process optimization.
- Hardware support.

Best-in-Class Support Tools and Technology:

























- Tooling performance experts.
- Materials database.
- Application calculators.

ORIGINATING COUNTRY	LANGUAGE	TEL	EMAIL
Australia	English	1800 666 667	ap-kmt.techsupport@kennametal.com
Austria	German	0223 63181361	eu.techsupport@widia.com
Belgium	English/French	0279 06 533	eu.techsupport@widia.com
China	Chinese	400-889-2237	w-cn.techsupport@widia.com
Denmark	English	808 89295	na.techsupport@widia.com
Finland	English	0800 919413	na.techsupport@widia.com
France	French	01 60 12 83 30	eu.techsupport@widia.com
Germany	German	06003 8277140	eu.techsupport@widia.com
India	English	1 800 103 5227	in.techsupport@widia.com
Israel	English	03-5562211	na.techsupport@widia.com
Italy	Italian	028 95 96 214	eu.techsupport@widia.com
Japan	English	81-3-4578-9279	ap-kmt.techsupport@kennametal.com
Korea (South)	English	+82 2 21006100	ap-kmt.techsupport@kennametal.com
Malaysia	English	1800 812 990	ap-kmt.techsupport@kennametal.com
Netherlands	English	076 79 95 222	na.techsupport@widia.com
New Zealand	English	0800536626	ap-kmt.techsupport@kennametal.com
Norway	English	800 10081	na.techsupport@widia.com
Poland	Polish	616 656 584	eu.techsupport@widia.com
Russia	Russian	-	eu.techsupport@widia.com
Singapore	English	0800450941	ap-kmt.techsupport@kennametal.com
South Africa	English	+27 11 748 9300	na.techsupport@widia.com
Sweden	English	020798794	na.techsupport@widia.com
Taiwan	English	0800 666 197	ap-kmt.techsupport@kennametal.com
Thailand	English	1800 4417820	ap-kmt.techsupport@kennametal.com
United Kingdom	English	0138 44 08 096	na.techsupport@widia.com
Ukraine	English	-	eu.techsupport@widia.com
USA	English	888 539 5145	na.techsupport@widia.com

Turning Icons

<p>Shank: KM-TS™ (ISO 26622)</p>	<p>ISO: 26622</p>	<p>Through Coolant: 100 bar</p>	<p>Through Coolant: 1500 psi</p>	<p>Turning</p>
<p>Cut-off</p>	<p>I.D. Turning</p>	<p>I.D. Chamfering</p>	<p>I.D. Grooving</p>	<p>I.D. Face Grooving</p>
<p>I.D. Internal Threading</p>	<p>Profiling</p>	<p>Facing</p>	<p>Face Grooving</p>	<p>Back Boring</p>
<p>Threading</p>	<p>Grooving</p>			

Indexable Milling Icons

 Countersinking	 Face Milling	 Helical Milling	 Plunge Milling	 Ramping Blank
 Slotting: Ball Nose	 Slotting: Side Milling	 Slotting: Side Milling with AE/AP Dimensions	 Slotting: Square End	 Slotting: T
 Side Milling/Shoulder Milling: Ball Nose	 Side Milling/Shoulder Milling: Square End	 Side Milling: Square End with AE/AP Dimensions	 Chamfer Milling	 Side Milling: Roughing
 3D Profiling	 PCD Tool	 Pocketing	 Plain Shank	 Shell Mill Shank
 Weldon® Shank	 Weldon Shank: 2 Flat	 Screw-On Shank	 Shank	 Through Coolant: Radial: Indexable Milling

Solid End Milling Icons

 Plunge Milling	 Ramping Blank	 Slotting: Ball Nose	 Slotting: Ball Nose with AP Dimension	 Slotting: Square End
 Slotting: Square End with AP Dimension	 Trochoidal Milling	 Trochoidal Milling: Ball Nose	 Side Milling/Shoulder Milling: Ball Nose	 Side Milling/Shoulder Milling: Ball Nose with AE/AP Dimension
 Side Milling/Shoulder Milling: Square End	 Side Milling/Shoulder Milling: Square End with AE/AP Dimension	 Chamfer Milling	 Chamfer Milling: Chamfer Milling with AE/AP Dimension	 3D Profiling
 PCD Tool	 HSS-PM Material	 HSS-M42	 Corner Style: Ball Nose	 Corner Style: Corner Chamfer
 Corner Style: Corner Radius	 Corner Style: Square End	 Corner Style: Torus	 Helix Angle: 0°	 Helix Angle: 15°
 Helix Angle: 20°	 Helix Angle: 25°	 Helix Angle: 30°	 Helix Angle: 35°	 Helix Angle: 37°
 Helix Angle: 38°	 Helix Angle: 40°	 Helix Angle: 45°	 Helix Angle: 45°	 Helix Angle: 60°
 Helix Angle: 43°	 DIN 6528	 DIN 844	 DIN 1835/B	 DIN 6527
 Through Coolant: Radial: Drilling	 Through Coolant: Axial: Solid End Mill	 Tool Dimensions: Flute Configuration: X (Variable)	 Tool Dimensions: Flute Configuration: 1	 Tool Dimensions: Flute Configuration: 2
 Tool Dimensions: Flute Configuration: 3	 Tool Dimensions: Flute Configuration: 4	 Tool Dimensions: Flute Configuration: 5	 Tool Dimensions: Flute Configuration: 6	 Tool Dimensions: Flute Configuration: 7
 Manufacturer's Specs: JIS				

Holemaking Icons

 Countersinking/ Stroke Chamfering	 Drilling	 Chain Drilling	 Drilling: Cross Hole	 Drilling: Half Cylinder
 Drilling: Corner Drilling 45°	 Drilling: Inclined Entry	 Drilling: Inclined Exit	 Drilling: Exit Offset	 Drilling: Stacked Plates
 Drilling: Convex	 Drilled Hole	 Reaming: Through Hole	 Reaming: Blind Hole	 Reaming: Through Cross
 Reaming: Blind and Cross Holes	 Drilling Depth: 3x	 Drilling Depth: 5x	 Drilling Depth: 8x	 Drilling Depth: 12x
 Shank: Cylindrical Plain ≤h6	 Shank: Cylindrical Whistle Notch 2°	 Flat Shank	 Shank: Cylindrical with flat	 KM™ Shank
 Helix Angle 0°	 Helix Angle 30°	 DIN 212	 DIN 6535	 DIN 6537
 Through Coolant: Radial: Drilling	 Through Coolant: Radial: Drilling	 Through Coolant: Radial: Indexable Drilling	 Flood Coolant: Reaming	 Through Coolant: MQL (Minimum Quantity Lubricant): Drilling
 Axial: Drilling	 Through Coolant: Axial Reaming	 Tool Dimensions: 2-Flute/2-Margin/ Coolant	 Tool Dimensions: 2-Flute/4-Margin/ Coolant	

Tapping Icons

 Tapping: Blind Hole	 Threading: Through Hole	 Threading: Blind Hole	 HSS-E: High-Speed Steel with Cobalt Alloy for Materials with Higher Hardness	 HSS-E-PM: High-Speed Steel with Cobalt Alloy for Materials with Higher Hardness (PM = Power Metal Steel)
 HM: (Carbide)	 Square Shank	 Chamfer Form C (2-3)	 Chamfer Form D (3.5-5)	 Chamfer Form E (1.5-2)
 Plug Chamfer (3-5)	 Tapping Helix: Angle: 0°	 Tapping Helix: Angle: 10°	 Tapping Helix: Angle: L8°	 Tapping Helix: Angle: 15°
 Tapping Helix: Angle: L15°	 Tapping Helix: Angle: 25°	 Tapping Helix: Angle: 30°	 Tapping Helix: Angle: 42°	 Tapping Helix: Angle: 45°
 DIN 371 DIN Number 371	 DIN 374 DIN Number 374	 DIN 2174 DIN Number 2174	 DIN 376 DIN Number 376	 Tapping: Through Coolant
 Flood Coolant: Tapping	 Through Coolant: Axial: Tapping	 ISO 2 ISO 2	 JIS Manufacturer's Specs: JIS	 2B Class of Fit: 2B
 3B Class of Fit: 3B	 6H Class of Fit: 6H	 6HX Class of Fit: 6HX	 6G Class of Fit: 6G	 ANSI ANSI
 UNJC Unified Course Thread: J Profile	 UNJF Unified Fine Thread: J Profile	 UNF Unified Fine Thread	 UNC Unified Course Thread	 M ISO Metric Coarse Thread
 MF ISO Metric Fine Thread				

DIN – German Institute for Standardization

ALL-STAR

THE ALL-STAR PROGRAM PROVIDES PROVEN SOLUTIONS THAT ARE EASY TO FIND AND ALWAYS AVAILABLE.

All-Star includes products from our most popular platforms, grades, and sizes grouped into one program and guaranteed to be in stock with same-day shipping on orders placed before 4pm CET.

Visit widia.com to see what products are available for same-day shipping through All-Star.

Turning



Tapping



Holemaking



TO SEE ALL PRODUCT LINES, VISIT OUR DIGITAL RESOURCES



WIDIA™ Machining Central
Mobile App

Download for iOS or Android™:

widia.com/en/featured/WidiaMobileApp



www.youtube.com/c/widiatools



www.linkedin.com/company/widiatools/



www.instagram.com/widiatools/



www.facebook.com/widiatools

To learn more, visit widia.com



Proven Solutions



Easy to Find

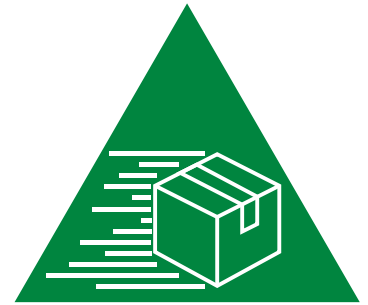

Always Available

Indexable Milling



Solid End Milling



Material Cross Reference • DIN

P	Steel
M	Stainless Steel
K	Cast Iron

N	Non-Ferrous
S	High-Temp Alloys

H	Hardened Materials
C	CFRP Materials

material group	description	content	tensile strength RM (MPa)*	hardness (HB)	hardness (HRC)	material number
P0	Low-Carbon Steels, Long Chipping	C <0,25%	<530	<125	–	–
P1	Low-Carbon Steels, Short Chipping, Free Machining	C <0,25%	<530	<125	–	C15, Ck22, ST37-2, S235JR, 9SMnPb28, GS38
P2	Medium- and High-Carbon Steels	C >0,25%	>530	<220	<25	ST52, S355JR, C35, GS60, Cf53
P3	Alloy Steels and Tool Steels	C >0,25%	600–850	<330	<35	16MnCr5, Ck45, 21CrMoV5-7, 38SMn28
P4	Alloy Steels and Tool Steels	C >0,25%	850–1400	340–450	35–48	100Cr6, 30CrNiMo8, 42CrMo4, C70W2, S6525, X120Mn12
P5	Ferritic, Martensitic, and PH Stainless Steels	–	600–900	<330	<35	100Cr6, 30CrNiMo8, 42CrMo4, C70W2, S6525, X120Mn12
P6	High-Strength Ferritic, Martensitic, and PH Stainless Steels	–	900–1350	350–450	35–48	X102CrMo17, G-X120Cr29
M1	Austenitic Stainless Steel	–	<600	130–200	–	X5CrNi 18 10, X2CrNiMo 17 13 2, G-X25CrNiSi18 9, X15CrNiSi 20 12
M2	High-Strength Austenitic Stainless and Cast Stainless Steels	–	600–800	150–230	<25	X2CrNiMo 13 4, X5NiCr 32 21, X5CrNiNb 18 10, G-X15CrNi 25-20
M3	Duplex Stainless Steel	–	<800	135–275	<30	X8CrNiMo27 5, X2CrNiMoN22 5 3, X20CrNiSi25 4, G-X40CrNiSi27 4
K1	Gray Cast Iron	–	125–500	120–290	<32	GG15, GG25, GG30, GG40, GTW40
K2	Low- and Medium-Strength Ductile Irons (Nodular Irons) and Compacted Graphite Irons (CGI)	–	<600	130–260	<28	GGG40, GTS35
K3	High-Strength Ductile Irons and Austempered Ductile Iron (ADI)	–	>600	180–350	<43	GGG60, GTW55, GTS65
N1	Wrought Aluminum	–	–	–	–	AlMg1, Al99.5, AlCuMg1, AlCuBiPb, AlMgSi1, AlMgSiPb
N2	Low-Silicon Aluminum Alloys and Magnesium Alloys	Si <12,2%	–	–	–	GAISiCu4, GDAISi10Mg
N3	High-Silicon Aluminum Alloys and Magnesium Alloys	Si >12,2%	–	–	–	G-ALSi12, G-AISi17Cu4, G-AISi21CuNiMg
N4	Copper-, Brass-, Zinc-Based on Machinability Index Range of 70–100	–	–	–	–	CuZn40, Ms60, G-CuSn5ZnPb, CuZn37, CuSi3Mn
N5	Nylon, Plastics, Rubbers, Phenolics, Resins, Fiberglass	–	–	–	–	LEXAN®, Hostalen™, Polystyrol®, MAKROLON®
N6	Carbon, Graphite Composites, CFRP	–	–	–	–	CFK, GFK
N7	Metal Matrix Composites (MMC)	–	–	–	–	–
S1	Iron-Based, Heat-Resistant Alloys	–	500–1200	160–260	25–48	X1NiCrMoCu32 28 7, X12NiCrSi36 16, X5NiCrAlTi31 20, X40CoCrNi20 20
S2	Cobalt-Based, Heat-Resistant Alloys	–	1000–1450	250–450	25–48	Haynes® 188, Stellite™ 6,21,31
S3	Nickel-Based, Heat-Resistant Alloys	–	600–1700	160–450	<48	INCONEL® 690, INCONEL 625, Hastelloy®, NIMONIC® 75
S4	Titanium and Titanium Alloys	–	900–1600	300–400	33–48	Ti1, TiAl5Sn2, TiAl6V4, TiAl4Mo4Sn2
H1	Hardened Materials	–	–	–	44–48	GX260NiCr42, GX330NiCr42, GX300CrNiSi952, GX300CrMo153, Hardox® 400
H2	Hardened Materials	–	–	–	48–55	–
H3	Hardened Materials	–	–	–	56–60	–
H4	Hardened Materials	–	–	–	>60	–
C1	CFRP, CFRP/CFRP	–	–	–	–	–
C2	CFRP/Non-Ferrous	–	–	–	–	–
C3	CFRP/High-Temp	–	–	–	–	–
C4	CFRP/Stainless Steel	–	–	–	–	–
C5	CFRP/Non-Ferrous/High-Temp	–	–	–	–	–

Find Your Local WIDIA Authorized Distributor

WIDIA™ brand cutting tools are available exclusively through a specialized network of Authorized Distributor partners whom you can count on to deliver much more than products. Our distributors know us, and more importantly, they know you. They know better than anyone in the industry how to put the global power of WIDIA to work for you — in your industry, in your region, and for your business.

WIDIA distributor partners provide technical expertise that you can count on. They will show you how to:

- Significantly reduce cycle time.
- Improve machine tool utilization.
- Achieve measurable productivity improvements.
- Take advantage of proven supply chain solutions.
- Access local inventory and best-in-class technical support.
- Request on-site demonstrations of the latest tooling technology.

And with thousands of turning, milling, holemaking, tapping, and tooling systems products available from WIDIA, you'll find everything you need from one single source.

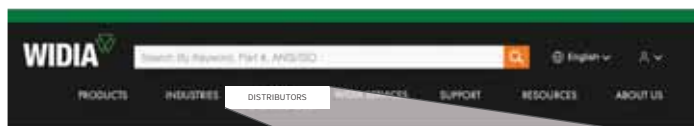

DISTRIBUTORS

Find your Local WIDIA Authorized Distributor by accessing our distributor finder at [widia.com](https://www.widia.com).

IMPORTANT SAFETY INSTRUCTIONS: READ BEFORE USING THE TOOLS IN THIS CATALOG

METALCUTTING SAFETY

Projectile and Fragmentation Hazards

Modern metalcutting operations involve high spindle and cutter speeds and high temperatures and cutting forces. Hot metal chips may fly off the workpiece during metalcutting. Although cutting tools are designed and manufactured to withstand high cutting forces and temperatures, they can sometimes fragment, particularly if they are subjected to over-stress, severe impact, or other abuse.

To avoid injury:

- Always wear appropriate personal protective equipment, including safety goggles, when operating metalcutting machines or working nearby.
- Always make sure all machine guards are in place.

Breathing and Skin Contact Hazards

Grinding carbide or other advanced cutting tool materials produces dust or mist containing metallic particles. Breathing this dust or mist — especially over an extended period — can cause temporary or permanent lung disease or make existing medical conditions worse. Contact with this dust or mist can irritate eyes, skin, and mucous membranes and may make existing skin conditions worse.

To avoid injury:

- Always wear breathing protection and safety goggles when grinding.
- Provide ventilation control and collect and properly dispose of dust, mist, or sludge from grinding.
- Avoid skin contact with dust or mist.

For more information, read the applicable Material Safety Data Sheet provided by WIDIA and consult General Industry Safety and Health Regulations, Part 1910, Title 29 of the Code of Federal Regulations.

These safety instructions are general guidelines. Many variables affect machining operations. It is impossible to cover every specific situation. The technical information included in this catalog and recommendations on machining practices may not apply to your particular operation.

For more information, consult the WIDIA Metalcutting Safety booklet, available free from WIDIA at +1 724 539 5747 or fax +1 724 539 5439. For specific product safety and environmental questions, contact our Corporate Environmental Health and Safety Office at +1 724 539 5066 or fax +1 724 539 5372.

Kennametal, the stylized K, ALUFLASH, CW3020, CW2015, CW5025, eBore, ERICKSON, Hanita, HSR, K10F, K10F-DCFD, KM, M25, M100, M170, M200, M270, M370, NINA, NOVO, Stellite, SuperFeed, TN6010, TN6025, Top Cut 4, TDMX, TOP DRILL, TOP DRILL M1, TOP DRILL S, TOP DRILL S+, TopGroove, TopThread, TRF, TRM, VariDrill, VariMill, VariMill I, VariMill II, VariMill III, VariMill Xtreme, VariTap, Victory, Vision Plus, VSM11, VSM17, VSM22, VSM490, VSM490-10, VSM490-15, VSM890, VSM890-12, VXF, WavCut, WBH10P, WBH20P, WBH30P, WBK40U, WDN00U, WDN25U, WGC, WGC Separator, WIDIA, WK15CM, WK15PD, WM15PD, WMT, WP20PD, WP40PD, WP15PE, WP40PM, WS15PE, WS30PM, WS40PM, WS10PT, WS25PT, WU10HT, WU20PD, WU25PD, WU10PM, WU10PT, and X-Feed are trademarks of Kennametal, Inc. and are used as such herein. The absence of a product, service name, or logo from this list does not constitute a waiver of the Kennametal trademark or other intellectual property rights concerning that name or logo.

Alcoa® is a registered trademark of ALCOA, Inc.

Android™ is a trademark of Google LLC.

App Store® is a registered trademark of Apple Inc., registered in the U.S. and other countries.

Facebook™ is a trademark of Meta.

Hardox® is a registered trademark of SSAB Technology AB Corporation.

Hastelloy® and Haynes® are registered trademarks of Haynes International, Inc. Corporation.

Hostalen™ is a trademark of Hoechst GmbH Corporation.

INCOLOY®, INCONEL®, MONEL®, and NIMONIC® are registered trademarks of Special Metals Corporation.

Instagram™ is a trademark of Meta.

LEXAN® is a registered trademark of Sabic Innovative Plastics IP B.V. Company.

LinkedIn® is a registered trademark of LinkedIn Corporation.

MAKROLON® is a registered trademark of Covestro Deutschland AG.

Polystyrol® is a registered trademark of BASF SE.

Safe-Lock™ is a trademark of Haimer GmbH.

Waspaloy® is a registered trademark of United Technologies Corporation.

Weldon® is a registered trademark of Weldon Tool Company.

YouTube® is a registered trademark of Google LLC.

CUTTING TOOLS

METRIC | 2022

WORLD HEADQUARTERS

WIDIA

Kennametal Inc.
1600 Technology Way
Latrobe, PA 15650 USA
Tel: 1 800 979 4342
w-na.service@widia.com

EUROPEAN HEADQUARTERS

WIDIA

Kennametal Europe GmbH
Rheingoldstrasse 50
CH 8212 Neuhausen am Rheinfall
Switzerland
Tel: +41 52 6750 100
w-ch.service@widia.com

ASIA-PACIFIC HEADQUARTERS

WIDIA

Kennametal (Singapore) Pte. Ltd.
3A International Business Park
Unit #01-02/03/05, ICON@IBP
Singapore 609935
Tel: +65 6265 9222
w-sg.service@widia.com

INDIA HEADQUARTERS

WIDIA

Kennametal India Limited
CIN: L27109KA1964PLC001546
8/9th Mile, Tumkur Road
Bangalore - 560073
Tel: +91 80 2839 4321
w-in.service@widia.com



[widia.com](https://www.widia.com)