

YU-UL18
INCH



**COMPLETE
METALWORKING
SOLUTIONS**

(800) 991-4225
www.ahbinc.com
ISO Certified
customerservice@ahbinc.com



YG INDEXABLE CUTTING TOOLS



YG YG-1 CO., LTD.

INDEX

Turning

Insert ISO Code System		p. 04
Product Overview	Turning Grades	p. 06
	Turning Chipbreakers	p. 08
Turning Inserts		p. 12

Parting & Groove Turn

Parting & Groove Turn	Overview / Inserts	p. 34
----------------------------------	--------------------	-------

Milling

Code Keys	Milling Cutters / Code System	p. 37
Product Overview	Cutters / Inserts Overview / Grades / Chipbreakers	p. 40
Milling Inserts		p. 44
Milling Cutters		
• Shoulder Milling Cutters (90°)	APKT 10, 16 / APMT 11, 16	p. 45 / p. 47
• Face Milling Cutters (43, 45°)	ODMT 06 / SEKT 12	p. 51 / p. 63
• Copy Milling Cutters (Round)	RDKT 08, 10, 12	p. 55

Drilling

Product Overview	Drilling Grades / Inserts / Chipbreakers	p. 68
Drilling Inserts		p. 69

Comparison Chart

Turning Grades		p. 72
Turning Chipbreakers		p. 73



TURNING

Turning - Name Code System Insert ISO Code System













*Inch

page 8

page 6

1	2	3	4	5	6	7	8	9
C	N	M	G	4	3	2	-UG	YG3020
Shape	Clearance	Tolerance	Clamping & Chipbreaker	Insert Size	Insert Thickness	Corner Radius	Chipbreaker Geometry	Grade

1 - Shape



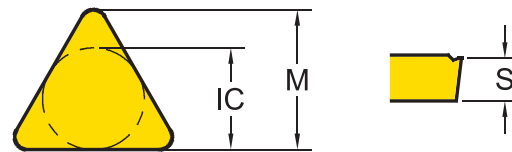





Symbol	Shape	
H	Hexagonal	
O	Octagonal	
P	Pentagonal	
S	Square	
T	Triangular	
C	Rhombic 80°	
D	Rhombic 55°	
V	Rhombic 35°	
W	Trigon	
L	Rectangular	
K	Parallelogram 55°	
R	Round	





3 - Tolerance Class

Symbol	Inner Circle IC (inch)	Nose Height M (inch)	Thickness S (inch)
E	±.001	±.0010	±.001
G	±.001	±.0010	±.005
K	±.002~.006	±.0005	±.005
M	±.002~.006	±.003~.010	±.005
U	±.003~.010	±.005~.015	±.005

4 - Clamping & Chipbreaker

Symbol	Clamping	Chipbreaker	Figure
N	No clamping hole	X	
R		One Face	
A	Cylindrical Clamping hole	X	
M		One Face	
G		Both Faces	
W	Screw Hole	X	
T		One Face	
U		Both Faces	
X		Special	

2 - Relief Angle (AN)

Symbol	Relief Angle (AN)	
N	No Relief Angle	
C	Relief 7°	
P	Relief 11°	
D	Relief 15°	
E	Relief 20°	
F	Relief 25°	
O	Special	

*Metric

page 8

page 6

1	2	3	4	5	6	7	8	9
C	N	M	G	12	04	08	-UG	YG3020
Shape	Clearance	Tolerance	Clamping & Chipbreaker	Insert Size	Insert Thickness	Corner Radius	Chipbreaker Geometry	Grade

5 - Insert Size

Metric							Inner Circle IC (inch)	Inch
S	T	C	D	V	W	R		
06	11	06	07	11			1/4	2
07							5/16	2.5
09	16	09	11	16	06	09 (00)	3/8	3
12	22	12	15	22	08	12 (00)	1/2	4
15		16					5/8	5
		19					3/4	6
						06 (M0)	.236	
						08 (M0)	.315	
						10 (M0)	.394	
						12 (M0)	.472	
						16 (M0)	.630	

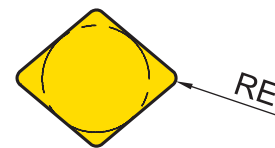
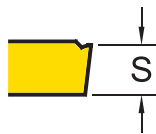

6 - Insert Thickness (S)

Metric	Thickness - S (inch)	Inch
T1	5/64	1.2
02	3/32	1.5
03	1/8	2
T3	5/32	2.5
04	3/16	3
05	7/32	3.5
06	1/4	4
07	5/16	5

7 - Corner Radius (RE)

Metric	Corner Radius - RE (inch)	Inch
01	.004	0
02	.008	0.5
04	1/64	1
08	1/32	2
12	3/64	3
16	1/16	4
20	5/64	5
24	3/32	6

Turning Grades

Turning Grades		P Steel				M Stainless Steel				K Cast Iron				N Non Ferrous			
		P05	P15	P25	P35	M05	M15	M25	M35	K05	K15	K25	K35	N05	N15	N25	N35
CVD	YG1001	1001									1001						
	YG3010		3010								3010						
	YG3020			3020													
	YG3030				3030			3030									
PVD	YG801		801			801											
DLC	YG100															100	
Uncoated	YG10															10	

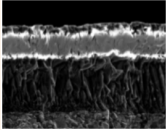
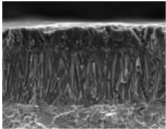
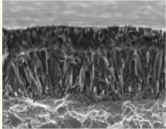
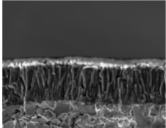
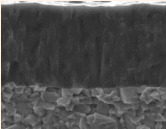
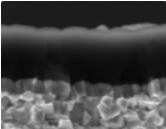
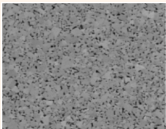
YG1001 K10 - K25	CVD TiCN - Al ₂ O ₃ 	First choice for stable machining of cast iron <ul style="list-style-type: none"> • Substrate especially designed for high wear resistance • Thick Al₂O₃ layer ensures good wear resistance at high cutting speeds including dry machining
YG3010 P05 - P20 K15 - K35	CVD TiCN - Al ₂ O ₃ 	First choice for Finishing Steels, and Ductile Cast iron <ul style="list-style-type: none"> • Finishing and light machining of steel under in stable condition • New Al₂O₃ coating technology and excellent surface smoothness increases wear resistance and chipping resistance
YG3020 P15 - P30	CVD TiCN - Al ₂ O ₃ 	First Choice grade for general Steel application <ul style="list-style-type: none"> • Substrate especially designed for good toughness • Excellent surface smoothness increases wear resistance and reliability
YG3030 P20 - P35 M20 - M35	CVD TiCN - Al ₂ O ₃ 	Interrupted cutting of steel and stainless steel <ul style="list-style-type: none"> • Substrate for heavy roughing in mild steel and low carbon alloy steel • New Al₂O₃ technology and optimized surface treatment achieves a good balance between wear resistance and chipping resistance
YG801 P10 - P30 M05 - M25 S05 - S25 H20 - H40	PVD - TiAlN 	Universal Grade for mid and low cutting conditions <ul style="list-style-type: none"> • Recommended for mild steel, stainless steel, and boring application • Substrate and special PVD coating for excellent wear resistance
YG100 N05 - N35	DLC 	First Choice grade for aluminum with DLC coating <ul style="list-style-type: none"> • Submicron carbide for high wear resistance • DLC coating minimizes Built Up Edge tendency. • Improves tool life in sticky non-ferrous alloy
YG10 N05 - N35	Uncoated 	Uncoated Grade for General Aluminum <ul style="list-style-type: none"> • Substrate consisted of submicron carbide for high wear resistance • Shining surface to prevent built up edge

Turning Grade Map

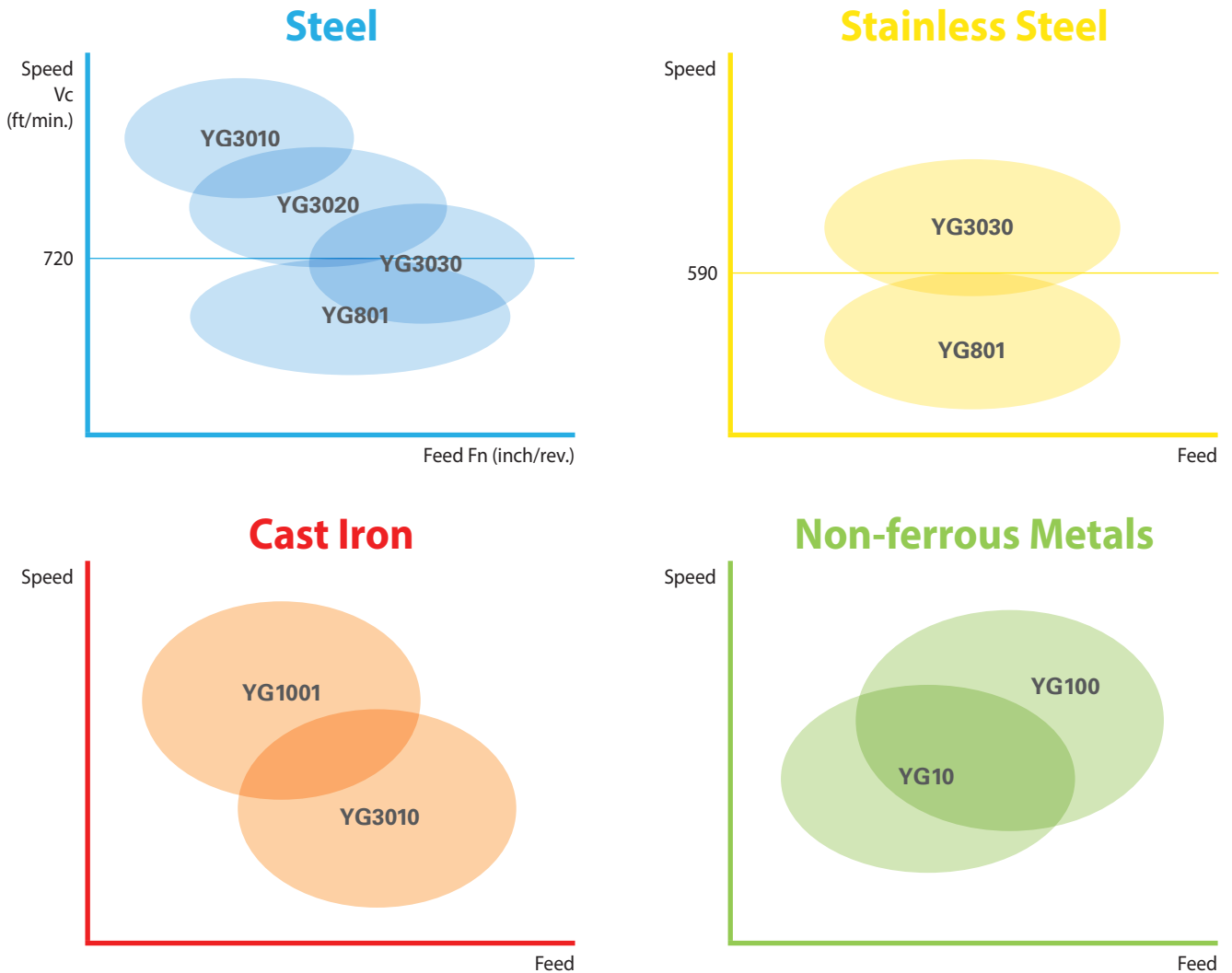

Recommended Cutting Conditions

Cutting Speed			Vc (ft/min.)													
ISO	VDI	Sub Group	YG1001		YG3010		YG3020		YG3030		YG801		YG100		YG10	
			Min.	Max.	Min.	Max.	Min.	Max.	Min.	Max.	Min.	Max.	Min.	Max.	Min.	Max.
P	1~5	Non Alloy Steel	720	1570	560	1480	590	1250	490	1150	390	820	-	-	-	-
	6~9	Low Alloy Steel	720	1380	590	1250	360	1150	300	980	230	750	-	-	-	-
	10~11	High Alloy Steel	-	-	330	1080	200	980	230	820	230	590	-	-	-	-
M	12~13	Ferritic & Martensitic	-	-	-	-	-	-	390	720	200	590	-	-	-	-
	14	Austenitic Stainless Steel	-	-	-	-	-	-	160	590	200	490	-	-	-	-
K	15~16	Grey Cast Iron	560	1380	390	980	-	-	-	-	200	520	-	-	-	-
	17~18	Nodular Cast Iron	390	1340	390	920	-	-	-	-	200	390	-	-	-	-
N	21~30	Aluminum	-	-	-	-	-	-	-	-	-	-	1150	3940	820	2620
S	31~37	Heat Resistant Super Alloy	-	-	-	-	-	-	110	260	110	200	-	-	-	-
H	38~41	Hardened Material	-	-	-	-	-	-	-	-	130	260	-	-	-	-

Turning Chipbreakers - Negative

P	M	K	N			Feed							
						0	.004	.008	.012	.016	.020	.024	
P				UF	Finishing 	Fn .002~.008		Ap .02~.06					
P				UL	Semi Finishing and sticky materials 	Fn .002~.012		Ap .04~.12					
P				UM	For Medium & Unstable conditions 	Fn .006~.014		Ap .04~.12					
P				UG	First Choice for Medium (Stable application) 	Fn .010~.016		Ap .06~.16					
P		K		UC	Medium Roughing and First choice for Cast Iron 	Fn .010~.020		Ap .06~.16					
P		K		UR	Roughing and Heavy interrupted cut 	Fn .012~.024		Ap .08~.24					
	M			MM	Stainless Steel Medium 	Fn .006~.014		Ap .04~.14					
		K		..MA	Cast Iron Heavy roughing 	Fn .008~.024		Ap .04~.28					
						0	.04	.08	.12	.16	.20	.24	
						Depth of Cut						Ap (inch)	

Turning Chipbreakers - Negative

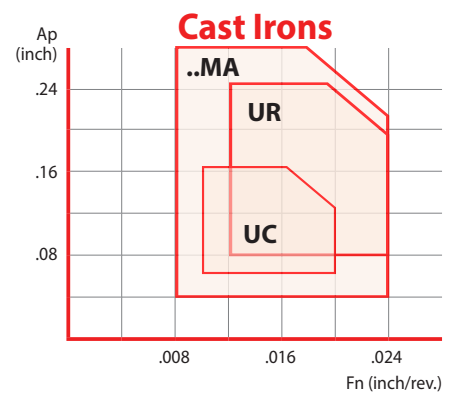
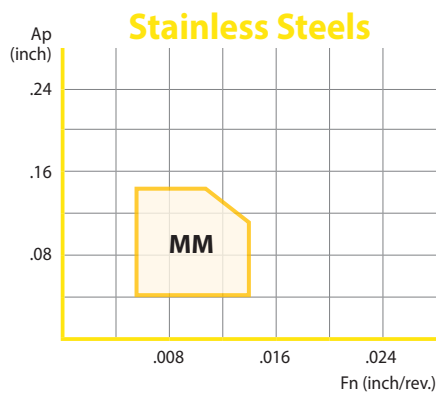
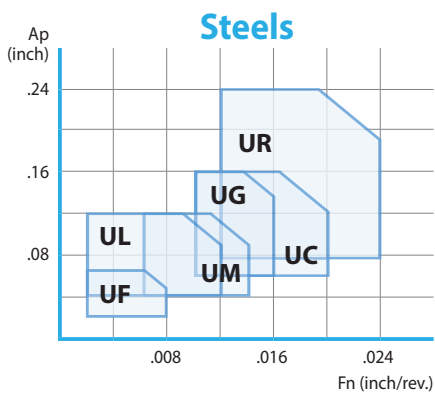
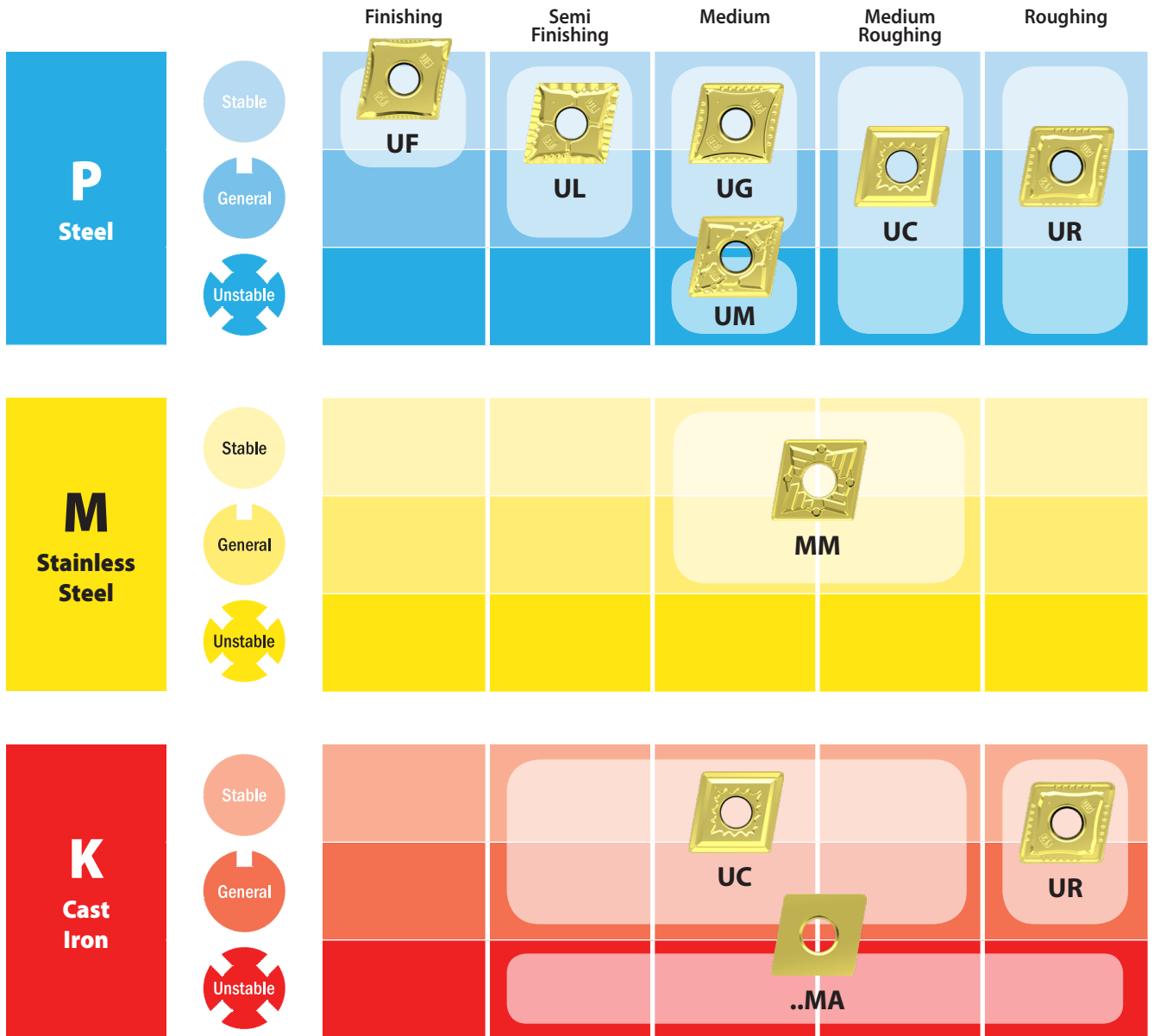

Turning Chipbreakers - Positive

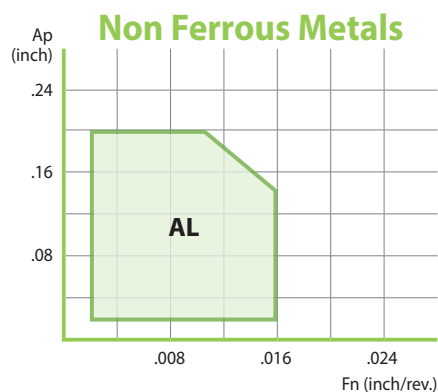
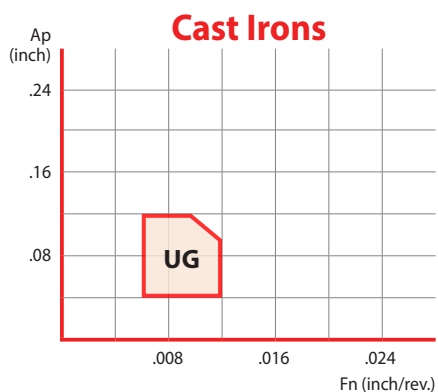
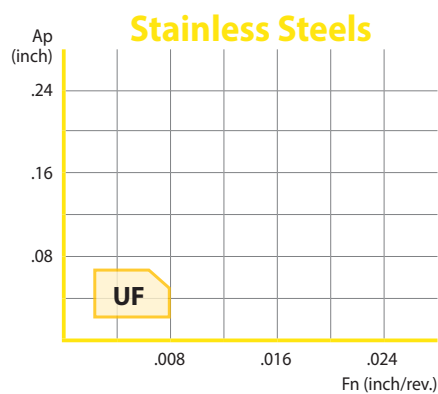
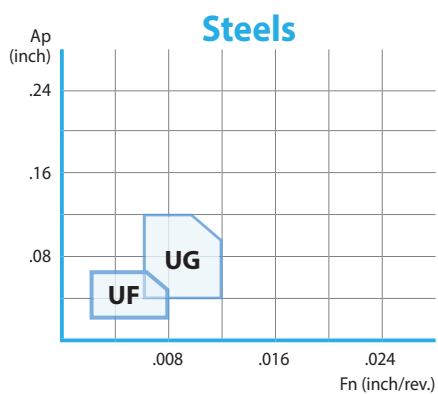
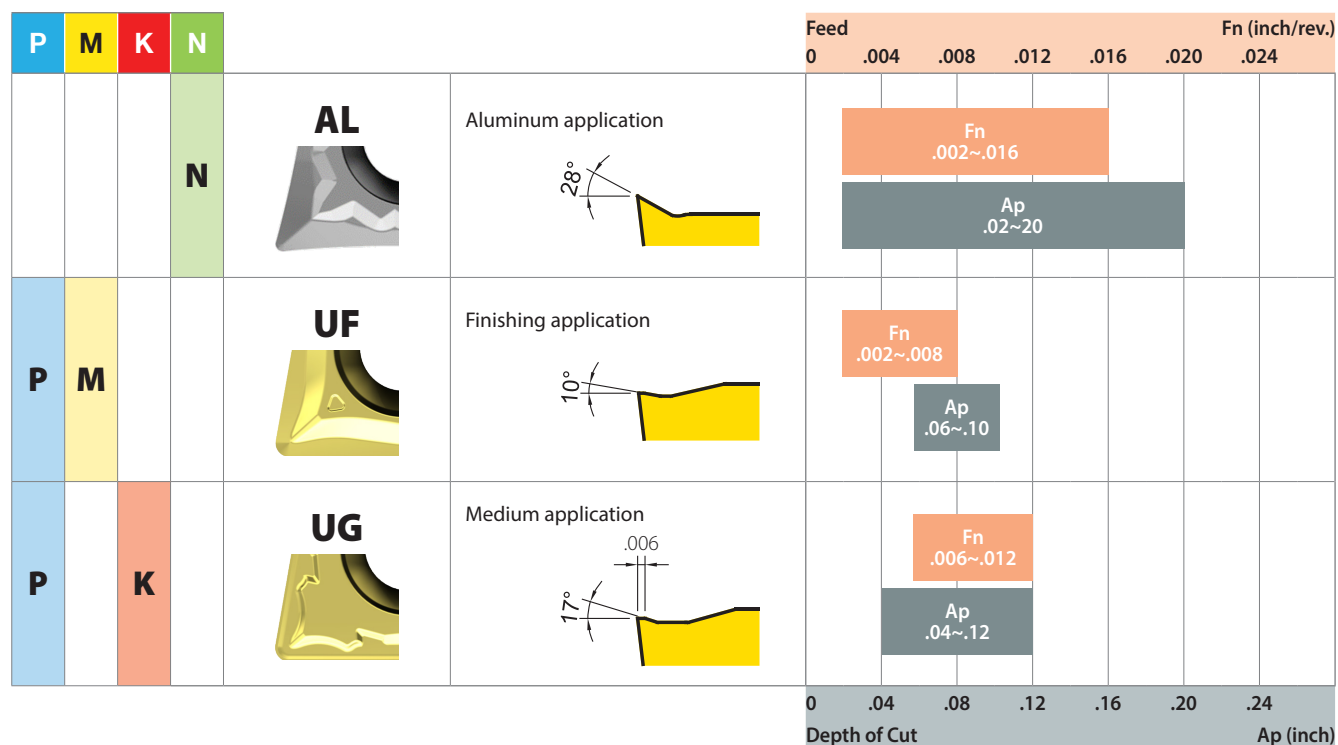



Turning Chipbreakers - Positive







		Finishing	Semi Finishing	Medium	Medium Roughing	Roughing
P Steel	Stable	 UF	 UG			
	General					
	Unstable					
	M Stainless Steel	Stable	 UF			
General						
Unstable						
K Cast Iron		Stable	 UG			
	General					
	Unstable					
	N Non Ferrous Metal	Stable	 AL			
General						
Unstable						

Turning Inserts Overview

Negative Inserts

C		CNMA	4	5	6	p. 13
		CNMG	4		6	
D		DNMA		44		p. 15
		DNMG	43	44		
K		KNUX	16			p. 17
S		SNMA	4			p. 18
		SNMG	4			
T		TNMA	3			p. 20
		TNMG	3	4		
		TNUX	3			p. 22
V		VNMG	3			p. 23
W		WNMA		4		p. 24
		WNMG	3	4		

Positive Inserts

C		CCGT		3		p. 26	
		CCMT	2	3	4		
D		DCGT		11		p. 27	
		DCMT	07	11			
R		RCMT	06	08	10	12	p. 28
S		SCMT	09	12			p. 29
T		TCGT		16		p. 30	
		TCMT	11	16			
V		VBMT	16			p. 31	
		VCGT / VCMT	16			p. 32	

Turning - Inserts - Negative CNMG / CNMA (80° Negative)

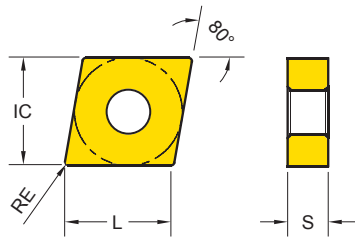

Series	L	IC	S
CNM□ 43	.472	1/2	3/16
CNM□ 54	.630	5/8	1/4
CNM□ 64	.748	3/4	1/4

● : Stock item ○ : Order made item

CNMA CNMG	Designation	RE	Fn (inch/rev.)	Ap (inch)	YG1001	YG3010	YG3020	YG3030	YG801	YG100	YG10
..MA Cast Iron	CNMA 431	1/64	.006~.014	.020~.098	●	○					
	CNMA 432	1/32	.008~.016	.039~.138	●	○					
	CNMA 433	3/64	.008~.020	.059~.197	●	○					
	CNMA 543	3/64	.012~.020	.059~.197	●	○					
	CNMA 544	1/16	.012~.024	.059~.236	●	●					
	CNMA 644	1/16	.012~.024	.059~.315	●	●					
-UF Finishing	CNMG 431 - UF	1/64	.002~.008	.020~.059		●	●	●	●		
	CNMG 432 - UF	1/32	.004~.010	.039~.098		●	●	●			
-UL Light Machining and Sticky Material	CNMG 431 - UL	1/64	.002~.010	.020~.079		●	●				
	CNMG 432 - UL	1/32	.004~.012	.039~.118		●	●	●			
	CNMG 433 - UL	3/64	.004~.012	.059~.138		○	○	○			
-UM Medium Machining Unstable condition	CNMG 431 - UM	1/64	.006~.010	.020~.059		●	●	●			
	CNMG 432 - UM	1/32	.006~.012	.020~.079	●	●	●	●			



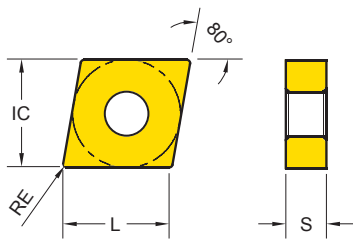

Cutting Speed			Vc (ft/min.)													
ISO	VDI	Sub Group	YG1001		YG3010		YG3020		YG3030		YG801		YG100		YG10	
			Min.	Max.	Min.	Max.	Min.	Max.	Min.	Max.	Min.	Max.	Min.	Max.	Min.	Max.
P	1~5	Non Alloy Steel	720	1570	560	1480	590	1250	490	1150	390	820	-	-	-	-
	6~9	Low Alloy Steel	720	1380	590	1250	360	1150	300	980	230	750	-	-	-	-
	10~11	High Alloy Steel	-	-	330	1080	200	980	230	820	230	590	-	-	-	-
M	12~13	Ferritic & Martensitic	-	-	-	-	-	-	390	720	200	590	-	-	-	-
	14	Austenitic Stainless Steel	-	-	-	-	-	-	160	590	200	490	-	-	-	-
K	15~16	Grey Cast Iron	560	1380	390	980	-	-	-	-	200	520	-	-	-	-
	17~18	Nodular Cast Iron	390	1340	390	920	-	-	-	-	200	390	-	-	-	-
N	21~30	Aluminum	-	-	-	-	-	-	-	-	-	1150	3940	820	2620	
S	31~37	Heat Resistant Super Alloy	-	-	-	-	-	-	110	260	110	200	-	-	-	-
H	38~41	Hardened Material	-	-	-	-	-	-	-	-	130	260	-	-	-	-

Turning - Inserts - Negative CNMG / CNMA (80° Negative)



Series	L	IC	S
CNM□ 43	.472	1/2	3/16
CNM□ 54	.630	5/8	1/4
CNM□ 64	.748	3/4	1/4

● : Stock item ○ : Order made item

CNMA CNMG	Designation	RE	Fn (inch/rev.)	Ap (inch)	YG1001	YG3010	YG3020	YG3030	YG801	YG100	YG10
-UG  Medium Machining at stable condition	CNMG 431 - UG	1/64	.008~.012	.020~.079		●	●	●			
	CNMG 432 - UG	1/32	.008~.016	.039~.118	●	●	●	●	●		
	CNMG 433 - UG	3/64	.008~.018	.059~.157		●	●	●			
-UC  Cast Iron and Medium roughing	CNMG 431 - UC	1/64	.010~.014	.020~.098	●	●	●	●			
	CNMG 432 - UC	1/32	.010~.018	.039~.157	●	●	●	●			
	CNMG 433 - UC	3/64	.012~.022	.059~.177	●	●	●	●			
-UR  Roughing	CNMG 432 - UR	1/32	.010~.022	.039~.157		●	●	●			
	CNMG 433 - UR	3/64	.012~.024	.059~.197		●	●	●	●		
	CNMG 643 - UR	3/64	.012~.024	.059~.236	●	●					
-MM  Stainless Steel Medium	CNMG 432 - MM	1/32	.008~.014	.039~.138			○	●	●		



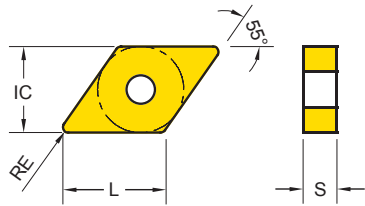

Cutting Speed			Vc (ft/min.)													
ISO	VDI	Sub Group	YG1001		YG3010		YG3020		YG3030		YG801		YG100		YG10	
			Min.	Max.	Min.	Max.	Min.	Max.	Min.	Max.	Min.	Max.	Min.	Max.	Min.	Max.
P	1~5	Non Alloy Steel	720	1570	560	1480	590	1250	490	1150	390	820	-	-	-	-
	6~9	Low Alloy Steel	720	1380	590	1250	360	1150	300	980	230	750	-	-	-	-
	10~11	High Alloy Steel	-	-	330	1080	200	980	230	820	230	590	-	-	-	-
M	12~13	Ferritic & Martensitic	-	-	-	-	-	-	390	720	200	590	-	-	-	-
	14	Austenitic Stainless Steel	-	-	-	-	-	-	160	590	200	490	-	-	-	-
K	15~16	Grey Cast Iron	560	1380	390	980	-	-	-	-	200	520	-	-	-	-
	17~18	Nodular Cast Iron	390	1340	390	920	-	-	-	-	200	390	-	-	-	-
N	21~30	Aluminum	-	-	-	-	-	-	-	-	-	1150	3940	820	2620	
S	31~37	Heat Resistant Super Alloy	-	-	-	-	-	-	110	260	110	200	-	-	-	-
H	38~41	Hardened Material	-	-	-	-	-	-	-	-	130	260	-	-	-	-

Turning - Inserts - Negative DNMG / DNMA (55° Negative)



Series	L	IC	S
DNM□ 43	.551	1/2	3/16
DNM□ 44	.551	1/2	1/4

● : Stock item ○ : Order made item

DNMA DNMG	Designation	RE	Fn (inch/rev.)	Ap (inch)	YG1001	YG3010	YG3020	YG3030	YG801	YG100	YG10
..MA  Cast Iron	DNMA 442	1/32	.006~.014	.039~.118	●						
	DNMA 443	3/64	.010~.018	.059~.157	●						
-UF  Finishing	DNMG 431 - UF	1/64	.002~.006	.020~.059		●	●	●	●		
	DNMG 441 - UF	1/64	.002~.008	.039~.079		●	●	●	●		
	DNMG 442 - UF	1/32	.004~.010	.059~.138		●	●	●			
-UL  Light Machining and Sticky Material	DNMG 441 - UL	1/64	.002~.010	.020~.079		●	●				
	DNMG 442 - UL	1/32	.006~.012	.059~.118		●	●	●			
-UM  Medium Machining Unstable condition	DNMG 442 - UM	1/32	.006~.014	.020~.079		●	●	●			

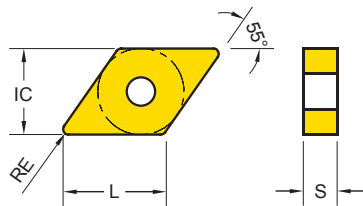

Cutting Speed			Vc (ft/min.)													
ISO	VDI	Sub Group	YG1001		YG3010		YG3020		YG3030		YG801		YG100		YG10	
			Min.	Max.	Min.	Max.	Min.	Max.	Min.	Max.	Min.	Max.	Min.	Max.	Min.	Max.
P	1~5	Non Alloy Steel	720	1570	560	1480	590	1250	490	1150	390	820	-	-	-	-
	6~9	Low Alloy Steel	720	1380	590	1250	360	1150	300	980	230	750	-	-	-	-
	10~11	High Alloy Steel	-	-	330	1080	200	980	230	820	230	590	-	-	-	-
M	12~13	Ferritic & Martensitic	-	-	-	-	-	-	390	720	200	590	-	-	-	-
	14	Austenitic Stainless Steel	-	-	-	-	-	-	160	590	200	490	-	-	-	-
K	15~16	Grey Cast Iron	560	1380	390	980	-	-	-	-	200	520	-	-	-	-
	17~18	Nodular Cast Iron	390	1340	390	920	-	-	-	-	200	390	-	-	-	-
N	21~30	Aluminum	-	-	-	-	-	-	-	-	-	1150	3940	820	2620	
S	31~37	Heat Resistant Super Alloy	-	-	-	-	-	-	110	260	110	200	-	-	-	-
H	38~41	Hardened Material	-	-	-	-	-	-	-	-	130	260	-	-	-	-

Turning - Inserts - Negative DNMG / DNMA (55° Negative)



Series	L	IC	S
DNM□ 43	.551	1/2	3/16
DNM□ 44	.551	1/2	1/4

● : Stock item ○ : Order made item

DNMA DNMG	Designation	RE	Fn (inch/rev.)	Ap (inch)	YG1001	YG3010	YG3020	YG3030	YG801	YG100	YG10
-UG  Medium Machining at stable condition	DNMG 432 - UG	1/32	.008~.014	.039~.098	●	●	●	●	●		
	DNMG 441 - UG	1/64	.008~.012	.020~.079		●	●	●			
	DNMG 442 - UG	1/32	.008~.014	.039~.118	●	●	●	●	●		
	DNMG 443 - UG	3/64	.008~.016	.059~.138	●	●	●	●			
-UC  Cast Iron and Medium roughing	DNMG 442 - UC	1/32	.010~.016	.039~.118	●	●	●	●			
	DNMG 443 - UC	3/64	.010~.018	.059~.138	●	●	●	●			
-UR  Roughing	DNMG 443 - UR	3/64	.012~.020	.059~.157		●	●	●	●		

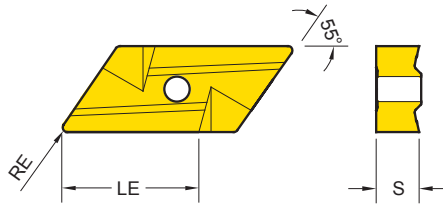

Cutting Speed			Vc (ft/min.)													
ISO	VDI	Sub Group	YG1001		YG3010		YG3020		YG3030		YG801		YG100		YG10	
			Min.	Max.	Min.	Max.	Min.	Max.	Min.	Max.	Min.	Max.	Min.	Max.	Min.	Max.
P	1~5	Non Alloy Steel	720	1570	560	1480	590	1250	490	1150	390	820	-	-	-	-
	6~9	Low Alloy Steel	720	1380	590	1250	360	1150	300	980	230	750	-	-	-	-
	10~11	High Alloy Steel	-	-	330	1080	200	980	230	820	230	590	-	-	-	-
M	12~13	Ferritic & Martensitic	-	-	-	-	-	-	390	720	200	590	-	-	-	-
	14	Austenitic Stainless Steel	-	-	-	-	-	-	160	590	200	490	-	-	-	-
K	15~16	Grey Cast Iron	560	1380	390	980	-	-	-	-	200	520	-	-	-	-
	17~18	Nodular Cast Iron	390	1340	390	920	-	-	-	-	200	390	-	-	-	-
N	21~30	Aluminum	-	-	-	-	-	-	-	-	-	1150	3940	820	2620	
S	31~37	Heat Resistant Super Alloy	-	-	-	-	-	-	110	260	110	200	-	-	-	-
H	38~41	Hardened Material	-	-	-	-	-	-	-	-	130	260	-	-	-	-

Turning - Inserts - Negative KNUX (55° - 2 Corners Single Side)



Series	LE	S
KNUX 1604	.591	3/16

● : Stock item ○ : Order made item

KNUX	Designation	RE	Fn (inch/rev.)	Ap (inch)	YG1001	YG3010	YG3020	YG3030	YG801	YG100	YG10
..UX Left	 KNUX 160405 L	.02	.004~.016	.020~.236		○	●	●	●		
..UX Right	 KNUX 160405 R	.02	.004~.016	.020~.236		○	●	●	●		



Cutting Speed			Vc (ft/min.)													
ISO	VDI	Sub Group	YG1001		YG3010		YG3020		YG3030		YG801		YG100		YG10	
			Min.	Max.	Min.	Max.	Min.	Max.	Min.	Max.	Min.	Max.	Min.	Max.	Min.	Max.
P	1~5	Non Alloy Steel	720	1570	560	1480	590	1250	490	1150	390	820	-	-	-	-
	6~9	Low Alloy Steel	720	1380	590	1250	360	1150	300	980	230	750	-	-	-	-
	10~11	High Alloy Steel	-	-	330	1080	200	980	230	820	230	590	-	-	-	-
M	12~13	Ferritic & Martensitic	-	-	-	-	-	-	390	720	200	590	-	-	-	-
	14	Austenitic Stainless Steel	-	-	-	-	-	-	160	590	200	490	-	-	-	-
K	15~16	Grey Cast Iron	560	1380	390	980	-	-	-	-	200	520	-	-	-	-
	17~18	Nodular Cast Iron	390	1340	390	920	-	-	-	-	200	390	-	-	-	-
N	21~30	Aluminum	-	-	-	-	-	-	-	-	-	1150	3940	820	2620	
S	31~37	Heat Resistant Super Alloy	-	-	-	-	-	-	110	260	110	200	-	-	-	-
H	38~41	Hardened Material	-	-	-	-	-	-	-	-	130	260	-	-	-	-

Turning - Inserts - Negative SNMG / SNMA (90° Negative)

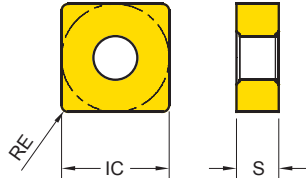
Series	IC	S
SNM□43	1/2	3/16



● : Stock item ○ : Order made item

SNMA SNMG	Designation	RE	Fn (inch/rev.)	Ap (inch)	YG1001	YG3010	YG3020	YG3030	YG801	YG100	YG10
..MA  Cast Iron	SNMA 432	1/32	.008~.016	.039~.138	●						
	SNMA 433	3/64	.008~.020	.059~.197	●						
-UF  Finishing	SNMG 431 - UF	1/64	.002~.008	.020~.059					●		
	SNMG 432 - UL	1/32	.004~.012	.039~.118		●	●	●			
-UL  Light Machining and sticky material											

Cutting Speed			Vc (ft/min.)													
ISO	VDI	Sub Group	YG1001		YG3010		YG3020		YG3030		YG801		YG100		YG10	
			Min.	Max.	Min.	Max.	Min.	Max.	Min.	Max.	Min.	Max.	Min.	Max.	Min.	Max.
P	1~5	Non Alloy Steel	720	1570	560	1480	590	1250	490	1150	390	820	-	-	-	-
	6~9	Low Alloy Steel	720	1380	590	1250	360	1150	300	980	230	750	-	-	-	-
	10~11	High Alloy Steel	-	-	330	1080	200	980	230	820	230	590	-	-	-	-
M	12~13	Ferritic & Martensitic	-	-	-	-	-	-	390	720	200	590	-	-	-	-
	14	Austenitic Stainless Steel	-	-	-	-	-	-	160	590	200	490	-	-	-	-
K	15~16	Grey Cast Iron	560	1380	390	980	-	-	-	-	200	520	-	-	-	-
	17~18	Nodular Cast Iron	390	1340	390	920	-	-	-	-	200	390	-	-	-	-
N	21~30	Aluminum	-	-	-	-	-	-	-	-	-	1150	3940	820	2620	
S	31~37	Heat Resistant Super Alloy	-	-	-	-	-	-	110	260	110	200	-	-	-	-
H	38~41	Hardened Material	-	-	-	-	-	-	-	-	130	260	-	-	-	-

Turning - Inserts - Negative SNMG / SNMA (90° Negative)

Series	IC	S
SNM□43	1/2	3/16

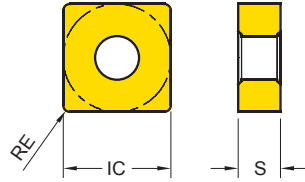

● : Stock item ○ : Order made item

SNMA SNMG	Designation	RE	Fn (inch/rev.)	Ap (inch)	YG1001	YG3010	YG3020	YG3030	YG801	YG100	YG10
-UG Medium Machining at stable condition	SNMG 432 - UG	1/32	.008~.016	.039~.118		●	●	●	●		
	SNMG 433 - UG	3/64	.008~.018	.059~.157		●	●	●			
-UC Cast Iron and Medium roughing	SNMG 432 - UC	1/32	.010~.018	.039~.157	●	●	●	●			
	SNMG 433 - UC	3/64	.012~.022	.059~.177	●						
-UR Roughing	SNMG 432 - UR	1/32	.012~.022	.039~.177		●	●	●			
	SNMG 433 - UR	3/64	.012~.024	.059~.197			○	●	●		



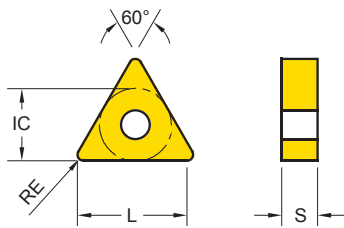

Cutting Speed			Vc (ft/min.)													
ISO	VDI	Sub Group	YG1001		YG3010		YG3020		YG3030		YG801		YG100		YG10	
			Min.	Max.	Min.	Max.	Min.	Max.	Min.	Max.	Min.	Max.	Min.	Max.	Min.	Max.
P	1~5	Non Alloy Steel	720	1570	560	1480	590	1250	490	1150	390	820	-	-	-	-
	6~9	Low Alloy Steel	720	1380	590	1250	360	1150	300	980	230	750	-	-	-	-
	10~11	High Alloy Steel	-	-	330	1080	200	980	230	820	230	590	-	-	-	-
M	12~13	Ferritic & Martensitic	-	-	-	-	-	-	390	720	200	590	-	-	-	-
	14	Austenitic Stainless Steel	-	-	-	-	-	-	160	590	200	490	-	-	-	-
K	15~16	Grey Cast Iron	560	1380	390	980	-	-	-	-	200	520	-	-	-	-
	17~18	Nodular Cast Iron	390	1340	390	920	-	-	-	-	200	390	-	-	-	-
N	21~30	Aluminum	-	-	-	-	-	-	-	-	-	1150	3940	820	2620	
S	31~37	Heat Resistant Super Alloy	-	-	-	-	-	-	110	260	110	200	-	-	-	-
H	38~41	Hardened Material	-	-	-	-	-	-	-	-	130	260	-	-	-	-

Turning - Inserts - Negative TNMG / TNMA (60° Negative)



Series	L	IC	S
TN□□ 33	.618	3/8	3/16
TN□□ 43	.827	1/2	3/16

● : Stock item ○ : Order made item

TNMA TNMG	Designation	RE	Fn (inch/rev.)	Ap (inch)	YG1001	YG3010	YG3020	YG3030	YG801	YG100	YG10
.MA  Cast Iron	TNMA 332	1/32	.006~.014	.039~.118	●						
	TNMA 333	3/64	.010~.018	.059~.157	●						
-UF  Finishing	TNMG 331 - UF	1/64	.002~.008	.039~.079		●	●	●	●		
	TNMG 332 - UF	1/32	.004~.010	.059~.138		●	●	●			
-UL  Light Machining and sticky material	TNMG 431 - UF	1/64	.002~.008	.039~.157		●			●		
	TNMG 332 - UL	1/32	.004~.010	.059~.138		●	●	●			
-UM  Medium Maching Unstable condition	TNMG 332 - UM	1/32	.006~.014	.020~.079		●	●	●			

Cutting Speed			Vc (ft/min.)													
ISO	VDI	Sub Group	YG1001		YG3010		YG3020		YG3030		YG801		YG100		YG10	
			Min.	Max.	Min.	Max.	Min.	Max.	Min.	Max.	Min.	Max.	Min.	Max.	Min.	Max.
P	1~5	Non Alloy Steel	720	1570	560	1480	590	1250	490	1150	390	820	-	-	-	-
	6~9	Low Alloy Steel	720	1380	590	1250	360	1150	300	980	230	750	-	-	-	-
	10~11	High Alloy Steel	-	-	330	1080	200	980	230	820	230	590	-	-	-	-
M	12~13	Ferritic & Martensitic	-	-	-	-	-	-	390	720	200	590	-	-	-	-
	14	Austenitic Stainless Steel	-	-	-	-	-	-	160	590	200	490	-	-	-	-
K	15~16	Grey Cast Iron	560	1380	390	980	-	-	-	-	200	520	-	-	-	-
	17~18	Nodular Cast Iron	390	1340	390	920	-	-	-	-	200	390	-	-	-	-
N	21~30	Aluminum	-	-	-	-	-	-	-	-	-	1150	3940	820	2620	
S	31~37	Heat Resistant Super Alloy	-	-	-	-	-	-	110	260	110	200	-	-	-	-
H	38~41	Hardened Material	-	-	-	-	-	-	-	-	130	260	-	-	-	-

Turning - Inserts - Negative

TNMG / TNMA (60° Negative)

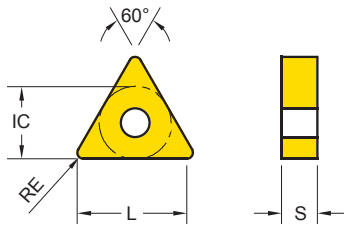

Series	L	IC	S
TN□□ 33	.618	3/8	3/16
TN□□ 43	.827	1/2	3/16

●: Stock item ○: Order made item

TNMA TNMG	Designation	RE	Fn (inch/rev.)	Ap (inch)	YG1001	YG3010	YG3020	YG3030	YG801	YG100	YG10
-UG Medium Machining at Stable condition	TNMG 331 - UG	1/64	.008~.012	.020~.079	●	●	●	●			
	TNMG 332 - UG	1/32	.008~.014	.039~.118	●	●	●	●	●		
	TNMG 432 - UG	1/32	.008~.012	.039~.157		●	●	●	●		
-UC Cast Iron and Medium roughing	TNMG 331 - UC	1/64	.010~.016	.020~.098	○	●	●	●			
	TNMG 332 - UC	1/32	.010~.016	.039~.118	●	●	●	●			
	TNMG 333 - UC	3/64	.010~.018	.059~.138	●						
-UR Roughing	TNMG 333 - UR	3/64	.012~.020	.059~.118		○	○	●	●		
	TNMG 433 - UR	3/64	.012~.020	.059~.157	●	○	○	●	●		
	TNMG 434 - UR	1/16		.059~.236	●	●					

Cutting Speed			Vc (ft/min.)													
ISO	VDI	Sub Group	YG1001		YG3010		YG3020		YG3030		YG801		YG100		YG10	
			Min.	Max.	Min.	Max.	Min.	Max.	Min.	Max.	Min.	Max.	Min.	Max.	Min.	Max.
P	1~5	Non Alloy Steel	720	1570	560	1480	590	1250	490	1150	390	820	-	-	-	-
	6~9	Low Alloy Steel	720	1380	590	1250	360	1150	300	980	230	750	-	-	-	-
	10~11	High Alloy Steel	-	-	330	1080	200	980	230	820	230	590	-	-	-	-
M	12~13	Ferritic & Martensitic	-	-	-	-	-	-	390	720	200	590	-	-	-	-
	14	Austenitic Stainless Steel	-	-	-	-	-	-	160	590	200	490	-	-	-	-
K	15~16	Grey Cast Iron	560	1380	390	980	-	-	-	-	200	520	-	-	-	-
	17~18	Nodular Cast Iron	390	1340	390	920	-	-	-	-	200	390	-	-	-	-
N	21~30	Aluminum	-	-	-	-	-	-	-	-	-	1150	3940	820	2620	
S	31~37	Heat Resistant Super Alloy	-	-	-	-	-	-	110	260	110	200	-	-	-	-
H	38~41	Hardened Material	-	-	-	-	-	-	-	-	130	260	-	-	-	-

Turning - Inserts - Negative TNUX (60° Negative)

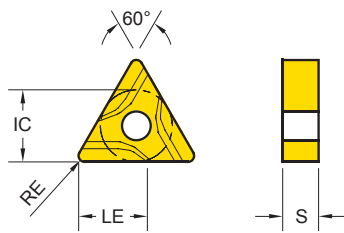

Series	LE	IC	S
TNUX 33	.370	3/8	3/16

● : Stock item ○ : Order made item

TNUX		Designation	RE	Fn (inch/rev.)	Ap (inch)	YG1001	YG3010	YG3020	YG3030	YG801	YG100	YG10
..UX Left		TNUX 331 L	1/64	.004~.012	.020~.157		○	●		●		
		TNUX 332 L	1/32	.004~.016	.020~.236		○	●		●		
..UX Right		TNUX 331 R	1/64	.004~.012	.020~.157		○	●		●		
		TNUX 332 R	1/32	.004~.016	.020~.236		○	●		●		

Cutting Speed			Vc (ft/min.)													
ISO	VDI	Sub Group	YG1001		YG3010		YG3020		YG3030		YG801		YG100		YG10	
			Min.	Max.	Min.	Max.	Min.	Max.	Min.	Max.	Min.	Max.	Min.	Max.	Min.	Max.
P	1~5	Non Alloy Steel	720	1570	560	1480	590	1250	490	1150	390	820	-	-	-	-
	6~9	Low Alloy Steel	720	1380	590	1250	360	1150	300	980	230	750	-	-	-	-
	10~11	High Alloy Steel	-	-	330	1080	200	980	230	820	230	590	-	-	-	-
M	12~13	Ferritic & Martensitic	-	-	-	-	-	-	390	720	200	590	-	-	-	-
	14	Austenitic Stainless Steel	-	-	-	-	-	-	160	590	200	490	-	-	-	-
K	15~16	Grey Cast Iron	560	1380	390	980	-	-	-	-	200	520	-	-	-	-
	17~18	Nodular Cast Iron	390	1340	390	920	-	-	-	-	200	390	-	-	-	-
N	21~30	Aluminum	-	-	-	-	-	-	-	-	-	1150	3940	820	2620	
S	31~37	Heat Resistant Super Alloy	-	-	-	-	-	-	110	260	110	200	-	-	-	-
H	38~41	Hardened Material	-	-	-	-	-	-	-	-	130	260	-	-	-	-

Turning - Inserts - Negative VNMG (35° Negative)

Series	L	IC	S
VNM□33	.622	3/8	3/16

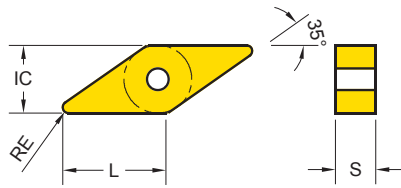

● : Stock item ○ : Order made item

VNMG	Designation	RE	Fn (inch/rev.)	Ap (inch)	YG1001	YG3010	YG3020	YG3030	YG801	YG100	YG10
..MA Cast Iron	VNMA 332	1/32	.006~.014	.039~.118	●						
-UF Finishing	VNMG 331 - UF	1/64	.002~.006	.020~.079		●	●	●	●		
	VNMG 332 - UF	1/32	.002~.010	.039~.098		●	●	●			
-UL Medium Machining and sticky material	VNMG 332 - UL	1/32	.004~.010	.039~.098		○	●				
-UG Medium Machining at stable condition	VNMG 332 - UG	1/32	.008~.012	.039~.118	●	●	●	●	●		
-UC Cast Iron and Medium roughing	VNMG 331 - UC	1/64	.010~.016	.020~.098		●					
	VNMG 332 - UC	1/32	.010~.016	.039~.118	●	●	●	●			
-UR Roughing	VNMG 333 - UR	3/64	.010~.014	.047~.118		○	○	●	●		

Cutting Speed			Vc (ft/min.)													
ISO	VDI	Sub Group	YG1001		YG3010		YG3020		YG3030		YG801		YG100		YG10	
			Min.	Max.	Min.	Max.	Min.	Max.	Min.	Max.	Min.	Max.	Min.	Max.	Min.	Max.
P	1~5	Non Alloy Steel	720	1570	560	1480	590	1250	490	1150	390	820	-	-	-	-
	6~9	Low Alloy Steel	720	1380	590	1250	360	1150	300	980	230	750	-	-	-	-
	10~11	High Alloy Steel	-	-	330	1080	200	980	230	820	230	590	-	-	-	-
M	12~13	Ferritic & Martensitic	-	-	-	-	-	-	390	720	200	590	-	-	-	-
	14	Austenitic Stainless Steel	-	-	-	-	-	-	160	590	200	490	-	-	-	-
K	15~16	Grey Cast Iron	560	1380	390	980	-	-	-	-	200	520	-	-	-	-
	17~18	Nodular Cast Iron	390	1340	390	920	-	-	-	-	200	390	-	-	-	-
N	21~30	Aluminum	-	-	-	-	-	-	-	-	-	1150	3940	820	2620	
S	31~37	Heat Resistant Super Alloy	-	-	-	-	-	-	110	260	110	200	-	-	-	-
H	38~41	Hardened Material	-	-	-	-	-	-	-	-	130	260	-	-	-	-

Turning - Inserts - Negative

WNMG / WNMA (80° Trigonal Negative)

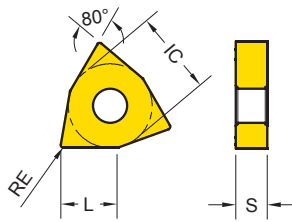

Series	L	IC	S
WNMG□33	.224	3/8	3/16
WNMG□43	.307	1/2	3/16

● : Stock item ○ : Order made item

WNMA WNMG	Designation	RE	Fn (inch/rev.)	Ap (inch)	YG1001	YG3010	YG3020	YG3030	YG801	YG100	YG10
..MA Cast Iron	WNMA 431	1/64	.006~.014	.020~.098	●						
	WNMA 432	1/32	.008~.016	.039~.138	●	○					
	WNMA 433	3/64	.008~.020	.059~.197	●	○					
-UF Finishing	WNMG 331 - UF	1/64	.002~.008	.020~.059		●	●	○	●		
	WNMG 431 - UF	1/64	.002~.008	.020~.079		●	●	●	●		
	WNMG 432 - UF	1/32	.004~.010	.039~.098		●	●	●			
-UL Light Machining and sticky material	WNMG 332 - UL	1/32	.004~.012	.039~.098		●	●	○			
	WNMG 432 - UL	1/32	.004~.012	.039~.118		●	●	●			



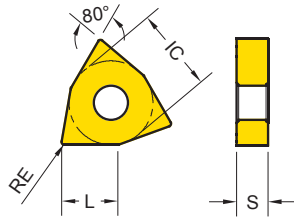

Cutting Speed			Vc (ft/min.)													
ISO	VDI	Sub Group	YG1001		YG3010		YG3020		YG3030		YG801		YG100		YG10	
			Min.	Max.	Min.	Max.	Min.	Max.	Min.	Max.	Min.	Max.	Min.	Max.	Min.	Max.
P	1~5	Non Alloy Steel	720	1570	560	1480	590	1250	490	1150	390	820	-	-	-	-
	6~9	Low Alloy Steel	720	1380	590	1250	360	1150	300	980	230	750	-	-	-	-
	10~11	High Alloy Steel	-	-	330	1080	200	980	230	820	230	590	-	-	-	-
M	12~13	Ferritic & Martensitic	-	-	-	-	-	-	390	720	200	590	-	-	-	-
	14	Austenitic Stainless Steel	-	-	-	-	-	-	160	590	200	490	-	-	-	-
K	15~16	Grey Cast Iron	560	1380	390	980	-	-	-	-	200	520	-	-	-	-
	17~18	Nodular Cast Iron	390	1340	390	920	-	-	-	-	200	390	-	-	-	-
N	21~30	Aluminum	-	-	-	-	-	-	-	-	-	1150	3940	820	2620	
S	31~37	Heat Resistant Super Alloy	-	-	-	-	-	-	110	260	110	200	-	-	-	-
H	38~41	Hardened Material	-	-	-	-	-	-	-	-	130	260	-	-	-	-

Turning - Inserts - Negative WNMG / WNMA (80° Trigonal Negative)



Series	L	IC	S
WNMG 33	.224	3/8	3/16
WNMG 43	.307	1/2	3/16

● : Stock item ○ : Order made item

WNMA WNMG	Designation	RE	Fn (inch/rev.)	Ap (inch)	YG1001	YG3010	YG3020	YG3030	YG801	YG100	YG10
-UM  Medium Machining at unstable condition	WNMG 432 - UM	1/32	.006~.012	.020~.079	●	●	●	●			
	WNMG 332 - UG	1/32	.008~.016	.039~.098			●		●		
-UG  Medium Machining at stable condition	WNMG 431 - UG	1/64	.008~.012	.059~.098		●	●	●			
	WNMG 432 - UG	1/32	.008~.016	.039~.138	●	●	●	●	●		
	WNMG 433 - UG	3/64	.008~.016	.039~.138	●						
-UC  Cast Iron and Medium roughing	WNMG 431 - UC	1/64	.010~.016	.020~.138	●	●	●	●			
	WNMG 432 - UC	1/32	.010~.018	.039~.157	●	●	●	●			
	WNMG 433 - UC	3/64	.012~.022	.059~.177	●	●	●	●			
-UR  Roughing	WNMG 432 - UR	1/32	.012~.024	.039~.177		●	●	●			
	WNMG 433 - UR	3/64	.012~.024	.059~.197	●	○	○	●	●		
	WNMG 434 - UR	1/16	.012~.024	.059~.197	●	●					

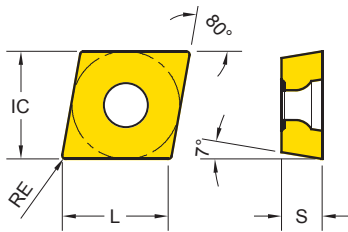

Cutting Speed			Vc (ft/min.)													
ISO	VDI	Sub Group	YG1001		YG3010		YG3020		YG3030		YG801		YG100		YG10	
			Min.	Max.	Min.	Max.	Min.	Max.	Min.	Max.	Min.	Max.	Min.	Max.	Min.	Max.
P	1~5	Non Alloy Steel	720	1570	560	1480	590	1250	490	1150	390	820	-	-	-	-
	6~9	Low Alloy Steel	720	1380	590	1250	360	1150	300	980	230	750	-	-	-	-
	10~11	High Alloy Steel	-	-	330	1080	200	980	230	820	230	590	-	-	-	-
M	12~13	Ferritic & Martensitic	-	-	-	-	-	-	390	720	200	590	-	-	-	-
	14	Austenitic Stainless Steel	-	-	-	-	-	-	160	590	200	490	-	-	-	-
K	15~16	Grey Cast Iron	560	1380	390	980	-	-	-	-	200	520	-	-	-	-
	17~18	Nodular Cast Iron	390	1340	390	920	-	-	-	-	200	390	-	-	-	-
N	21~30	Aluminum	-	-	-	-	-	-	-	-	-	1150	3940	820	2620	
S	31~37	Heat Resistant Super Alloy	-	-	-	-	-	-	110	260	110	200	-	-	-	-
H	38~41	Hardened Material	-	-	-	-	-	-	-	-	130	260	-	-	-	-

Turning - Inserts - Positive CCMT / CCGT (80° Positive)



Series	L	IC	S
CCIT 21.5	.244	1/4	3/32
CCIT 32.5	.362	3/8	5/32
CCIT 43	.488	1/2	3/16

● : Stock item ○ : Order made item

CCGT CCMT	Designation	RE	Fn (inch/rev.)	Ap (inch)	YG1001	YG3010	YG3020	YG3030	YG801	YG100	YG10
-AL  Aluminum	CCGT 320.5 - AL	1/128	.001~.003	.020~.039						●	●
	CCGT 32.51 - AL	1/64	.002~.010	.020~.079						●	●
	CCGT 32.52 - AL	1/32	.004~.014	.039~.118						●	●
-UF  Finishing	CCMT 21.51 - UF	1/64	.002~.006	.020~.059		●	●				
	CCMT 32.51 - UF	1/64	.002~.008	.020~.079		●	●				
-UG  General	CCMT 21.51 - UG	1/64	.006~.010	.020~.079					●		
	CCMT 21.52 - UG	1/32	.006~.010	.031~.079		●			●		
	CCMT 32.51 - UG	1/64	.006~.008	.020~.079		●	●		●		
	CCMT 32.52 - UG	1/32	.006~.012	.031~.098		●	●		●		
	CCMT 431 - UG	1/64	.008~.010	.020~.098		●	●				
	CCMT 432 - UG	1/32	.008~.014	.031~.138		●	●	●	●		
	CCMT 433 - UG	3/64	.008~.014	.047~.138		●					

Cutting Speed			Vc (ft/min.)													
ISO	VDI	Sub Group	YG1001		YG3010		YG3020		YG3030		YG801		YG100		YG10	
			Min.	Max.	Min.	Max.	Min.	Max.	Min.	Max.	Min.	Max.	Min.	Max.	Min.	Max.
P	1~5	Non Alloy Steel	720	1570	560	1480	590	1250	490	1150	390	820	-	-	-	-
	6~9	Low Alloy Steel	720	1380	590	1250	360	1150	300	980	230	750	-	-	-	-
	10~11	High Alloy Steel	-	-	330	1080	200	980	230	820	230	590	-	-	-	-
M	12~13	Ferritic & Martensitic	-	-	-	-	-	-	390	720	200	590	-	-	-	-
	14	Austenitic Stainless Steel	-	-	-	-	-	-	160	590	200	490	-	-	-	-
K	15~16	Grey Cast Iron	560	1380	390	980	-	-	-	-	200	520	-	-	-	-
	17~18	Nodular Cast Iron	390	1340	390	920	-	-	-	-	200	390	-	-	-	-
N	21~30	Aluminum	-	-	-	-	-	-	-	-	-	1150	3940	820	2620	
S	31~37	Heat Resistant Super Alloy	-	-	-	-	-	-	110	260	110	200	-	-	-	-
H	38~41	Hardened Material	-	-	-	-	-	-	-	-	130	260	-	-	-	-

Turning - Inserts - Positive DCMT / DCGT (55° Positive)

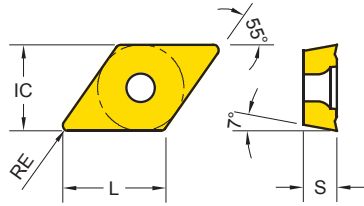

Series	L	IC	S
DCMT 21.5	.295	1/4	3/32
DCMT 32.5	.441	3/8	5/32

● : Stock item ○ : Order made item

DCGT DCMT	Designation	RE	Fn (inch/rev.)	Ap (inch)	YG1001	YG3010	YG3020	YG3030	YG801	YG100	YG10
-AL Aluminum	DCGT 32.50.5 - AL	1/128	.001~.003	.020~.039						●	●
	DCGT 32.51 - AL	1/64	.002~.010	.020~.079						●	●
	DCGT 32.52 - AL	1/32	.004~.012	.039~.098						●	●
-UF Finishing	DCMT 21.51 - UF	1/64	.002~.006	.020~.059		●	●				
	DCMT 32.51 - UF	1/64	.002~.008	.020~.079		●	●				
	DCMT 32.52 - UF	1/32	.002~.010	.039~.098		●	●				
-UG General	DCMT 21.51 - UG	1/64	.006~.010	.020~.059		●	●		○		
	DCMT 21.52 - UG	1/64	.006~.010	.031~.059		●					
	DCMT 32.51 - UG	1/64	.006~.010	.020~.079		●	●		●		
	DCMT 32.52 - UG	1/32	.008~.014	.031~.098		●	●	○	●		

Cutting Speed			Vc (ft/min.)													
ISO	VDI	Sub Group	YG1001		YG3010		YG3020		YG3030		YG801		YG100		YG10	
			Min.	Max.	Min.	Max.	Min.	Max.	Min.	Max.	Min.	Max.	Min.	Max.	Min.	Max.
P	1~5	Non Alloy Steel	720	1570	560	1480	590	1250	490	1150	390	820	-	-	-	-
	6~9	Low Alloy Steel	720	1380	590	1250	360	1150	300	980	230	750	-	-	-	-
	10~11	High Alloy Steel	-	-	330	1080	200	980	230	820	230	590	-	-	-	-
M	12~13	Ferritic & Martensitic	-	-	-	-	-	-	390	720	200	590	-	-	-	-
	14	Austenitic Stainless Steel	-	-	-	-	-	-	160	590	200	490	-	-	-	-
K	15~16	Grey Cast Iron	560	1380	390	980	-	-	-	-	200	520	-	-	-	-
	17~18	Nodular Cast Iron	390	1340	390	920	-	-	-	-	200	390	-	-	-	-
N	21~30	Aluminum	-	-	-	-	-	-	-	-	-	1150	3940	820	2620	
S	31~37	Heat Resistant Super Alloy	-	-	-	-	-	-	110	260	110	200	-	-	-	-
H	38~41	Hardened Material	-	-	-	-	-	-	-	-	130	260	-	-	-	-

Turning - Inserts - Positive RCMT (Round Positive)

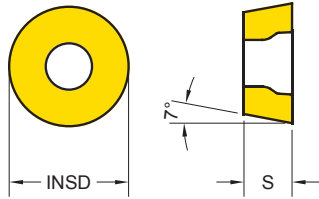

Series	INSD	S
RCMT 0602	.236	3/32
RCMT 0803	.315	1/8
RCMT 10T3	.394	5/32
RCMT 1204	.472	3/16

● : Stock item ○ : Order made item

RCMT	Designation	RE	Fn (inch/rev.)	Ap (inch)	YG1001	YG3010	YG3020	YG3030	YG801	YG100	YG10
	RCMT 0602M0	.118	.002~.010	.008~.047	○	○	●		●		
	RCMT 0803M0	.157	.002~.012	.020~.059	○	○	●		●		
	RCMT 10T3M0	.197	.004~.014	.020~.098	○	○	●		●		
	RCMT 1204M0	.236	.006~.018	.020~.118	○	○	●		●		



General

Cutting Speed			Vc (ft/min.)													
ISO	VDI	Sub Group	YG1001		YG3010		YG3020		YG3030		YG801		YG100		YG10	
			Min.	Max.	Min.	Max.	Min.	Max.	Min.	Max.	Min.	Max.	Min.	Max.	Min.	Max.
P	1~5	Non Alloy Steel	720	1570	560	1480	590	1250	490	1150	390	820	-	-	-	-
	6~9	Low Alloy Steel	720	1380	590	1250	360	1150	300	980	230	750	-	-	-	-
	10~11	High Alloy Steel	-	-	330	1080	200	980	230	820	230	590	-	-	-	-
M	12~13	Ferritic & Martensitic	-	-	-	-	-	-	390	720	200	590	-	-	-	-
	14	Austenitic Stainless Steel	-	-	-	-	-	-	160	590	200	490	-	-	-	-
K	15~16	Grey Cast Iron	560	1380	390	980	-	-	-	-	200	520	-	-	-	-
	17~18	Nodular Cast Iron	390	1340	390	920	-	-	-	-	200	390	-	-	-	-
N	21~30	Aluminum	-	-	-	-	-	-	-	-	-	1150	3940	820	2620	
S	31~37	Heat Resistant Super Alloy	-	-	-	-	-	-	110	260	110	200	-	-	-	-
H	38~41	Hardened Material	-	-	-	-	-	-	-	-	130	260	-	-	-	-

Turning - Inserts - Positive SCMT (Square Positive)

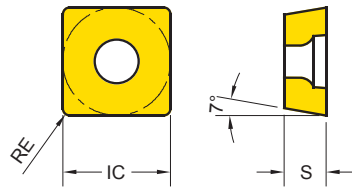

Series	IC	S
SCMT 32.5	3/8	5/32
SCMT 43	1/2	3/16

● : Stock item ○ : Order made item

SCMT	Designation	RE	Fn (inch/rev.)	Ap (inch)	YG1001	YG3010	YG3020	YG3030	YG801	YG100	YG10
-UF Finishing	SCMT 32.51 - UF	1/64	.004~.010	.020~.079		○	●				
-UG General	SCMT 32.51 - UG	1/64	.008~.014	.039~.098	●				●		
	SCMT 32.52 - UG	1/32	.008~.014	.039~.098	●	●	●		●		
	SCMT 432 - UG	1/32	.008~.016	.039~.138		●	●	○			

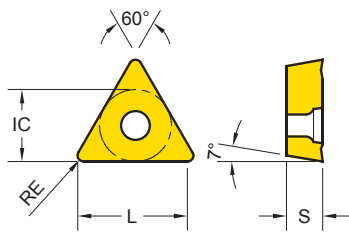

Cutting Speed			Vc (ft/min.)													
ISO	VDI	Sub Group	YG1001		YG3010		YG3020		YG3030		YG801		YG100		YG10	
			Min.	Max.	Min.	Max.	Min.	Max.	Min.	Max.	Min.	Max.	Min.	Max.	Min.	Max.
P	1~5	Non Alloy Steel	720	1570	560	1480	590	1250	490	1150	390	820	-	-	-	-
	6~9	Low Alloy Steel	720	1380	590	1250	360	1150	300	980	230	750	-	-	-	-
	10~11	High Alloy Steel	-	-	330	1080	200	980	230	820	230	590	-	-	-	-
M	12~13	Ferritic & Martensitic	-	-	-	-	-	-	390	720	200	590	-	-	-	-
	14	Austenitic Stainless Steel	-	-	-	-	-	-	160	590	200	490	-	-	-	-
K	15~16	Grey Cast Iron	560	1380	390	980	-	-	-	-	200	520	-	-	-	-
	17~18	Nodular Cast Iron	390	1340	390	920	-	-	-	-	200	390	-	-	-	-
N	21~30	Aluminum	-	-	-	-	-	-	-	-	-	1150	3940	820	2620	
S	31~37	Heat Resistant Super Alloy	-	-	-	-	-	-	110	260	110	200	-	-	-	-
H	38~41	Hardened Material	-	-	-	-	-	-	-	-	130	260	-	-	-	-

Turning - Inserts - Positive TCMT / TCGT (Triangle Positive)



Series	L	IC	S
TCMT 21.5	.406	1/4	3/32
TCMT 32.5	.614	3/8	5/32

● : Stock item ○ : Order made item

TCGT TCMT	Designation	RE	Fn (inch/rev.)	Ap (inch)	YG1001	YG3010	YG3020	YG3030	YG801	YG100	YG10
					-AL	 Aluminum	TCGT 32.50.5 - AL	1/128	.001~.002	.020~.039	
		TCGT 32.51 - AL	1/64	.002~.010	.020~.079					●	●
		TCGT 32.52 - AL	1/32	.004~.014	.039~.118					●	●
-UF	 Finishing	TCMT 21.51 - UF	1/64	.002~.008	.020~.079		●	●			
		TCMT 32.51 - UF	1/64	.002~.010	.020~.118		●	●	●		
-UG	 General	TCMT 21.51 - UG	1/64	.006~.010	.020~.079				●		
		TCMT 21.52 - UG	1/64	.006~.010	.031~.098		●				
		TCMT 32.51 - UG	1/64	.006~.010	.020~.079		●	●			
		TCMT 32.52 - UG	1/32	.008~.014	.031~.118		●	●	○	●	



Cutting Speed			Vc (ft/min.)													
ISO	VDI	Sub Group	YG1001		YG3010		YG3020		YG3030		YG801		YG100		YG10	
			Min.	Max.	Min.	Max.	Min.	Max.	Min.	Max.	Min.	Max.	Min.	Max.	Min.	Max.
P	1~5	Non Alloy Steel	720	1570	560	1480	590	1250	490	1150	390	820	-	-	-	-
	6~9	Low Alloy Steel	720	1380	590	1250	360	1150	300	980	230	750	-	-	-	-
	10~11	High Alloy Steel	-	-	330	1080	200	980	230	820	230	590	-	-	-	-
M	12~13	Ferritic & Martensitic	-	-	-	-	-	-	390	720	200	590	-	-	-	-
	14	Austenitic Stainless Steel	-	-	-	-	-	-	160	590	200	490	-	-	-	-
K	15~16	Grey Cast Iron	560	1380	390	980	-	-	-	-	200	520	-	-	-	-
	17~18	Nodular Cast Iron	390	1340	390	920	-	-	-	-	200	390	-	-	-	-
N	21~30	Aluminum	-	-	-	-	-	-	-	-	-	1150	3940	820	2620	
S	31~37	Heat Resistant Super Alloy	-	-	-	-	-	-	110	260	110	200	-	-	-	-
H	38~41	Hardened Material	-	-	-	-	-	-	-	-	130	260	-	-	-	-

Turning - Inserts - Positive VBMT (35° Positive)

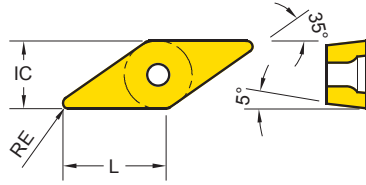
Series	L	IC	S
VBMT 33	.622	3/8	3/16



● : Stock item ○ : Order made item

VBMT	Designation	RE	Fn (inch/rev.)	Ap (inch)	YG1001	YG3010	YG3020	YG3030	YG801	YG100	YG10
-UF  Finishing	VBMT 331 - UF	1/64	.002~.008	.020~.079		●	●				
	VBMT 332 - UF	1/32	.002~.010	.020~.118		●	●				
-UG  General	VBMT 331 - UG	1/64	.006~.010	.020~.098		●	●		●		
	VBMT 332 - UG	1/32	.008~.016	.039~.118		●	●	○	●		

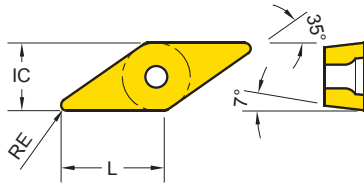

Cutting Speed			Vc (ft/min.)													
ISO	VDI	Sub Group	YG1001		YG3010		YG3020		YG3030		YG801		YG100		YG10	
			Min.	Max.	Min.	Max.	Min.	Max.	Min.	Max.	Min.	Max.	Min.	Max.	Min.	Max.
P	1~5	Non Alloy Steel	720	1570	560	1480	590	1250	490	1150	390	820	-	-	-	-
	6~9	Low Alloy Steel	720	1380	590	1250	360	1150	300	980	230	750	-	-	-	-
	10~11	High Alloy Steel	-	-	330	1080	200	980	230	820	230	590	-	-	-	-
M	12~13	Ferritic & Martensitic	-	-	-	-	-	-	390	720	200	590	-	-	-	-
	14	Austenitic Stainless Steel	-	-	-	-	-	-	160	590	200	490	-	-	-	-
K	15~16	Grey Cast Iron	560	1380	390	980	-	-	-	-	200	520	-	-	-	-
	17~18	Nodular Cast Iron	390	1340	390	920	-	-	-	-	200	390	-	-	-	-
N	21~30	Aluminum	-	-	-	-	-	-	-	-	-	1150	3940	820	2620	
S	31~37	Heat Resistant Super Alloy	-	-	-	-	-	-	110	260	110	200	-	-	-	-
H	38~41	Hardened Material	-	-	-	-	-	-	-	-	130	260	-	-	-	-

Turning - Inserts - Positive VCMT / VCGT (35° Positive)



Series	L	IC	S
VC□T 33	.622	3/8	3/16

● : Stock item ○ : Order made item

VCMT VCGT	Designation	RE	Fn (inch/rev.)	Ap (inch)	YG1001	YG3010	YG3020	YG3030	YG801	YG100	YG10
-AL  Aluminum	VCMT 330.5 - AL	1/128	.001~.002	.020~.039						●	●
	VCMT 331 - AL	1/64	.002~.010	.020~.079						●	●
	VCMT 332 - AL	1/32	.004~.014	.039~.118						●	●
-UF  Finishing	VCMT 331 - UF	1/64	.002~.010	.020~.118			●				
-UG  General	VCMT 331 - UG	1/64	.006~.010	.020~.098					●		
	VCMT 332 - UG	1/32	.008~.016	.039~.118			●		●		

Cutting Speed			Vc (ft/min.)													
ISO	VDI	Sub Group	YG1001		YG3010		YG3020		YG3030		YG801		YG100		YG10	
			Min.	Max.	Min.	Max.	Min.	Max.	Min.	Max.	Min.	Max.	Min.	Max.	Min.	Max.
P	1~5	Non Alloy Steel	720	1570	560	1480	590	1250	490	1150	390	820	-	-	-	-
	6~9	Low Alloy Steel	720	1380	590	1250	360	1150	300	980	230	750	-	-	-	-
	10~11	High Alloy Steel	-	-	330	1080	200	980	230	820	230	590	-	-	-	-
M	12~13	Ferritic & Martensitic	-	-	-	-	-	-	390	720	200	590	-	-	-	-
	14	Austenitic Stainless Steel	-	-	-	-	-	-	160	590	200	490	-	-	-	-
K	15~16	Grey Cast Iron	560	1380	390	980	-	-	-	-	200	520	-	-	-	-
	17~18	Nodular Cast Iron	390	1340	390	920	-	-	-	-	200	390	-	-	-	-
N	21~30	Aluminum	-	-	-	-	-	-	-	-	-	1150	3940	820	2620	
S	31~37	Heat Resistant Super Alloy	-	-	-	-	-	-	110	260	110	200	-	-	-	-
H	38~41	Hardened Material	-	-	-	-	-	-	-	-	130	260	-	-	-	-



**PARTING &
GROOVE TURN**

Parting & Groove Turn Overview

Parting & Groove Turn Grades

Parting and Grooving Grades		P Steel				M Stainless Steel				K Cast Iron				S Super Alloy			
		P05	P15	P25	P35	M05	M15	M25	M35	K05	K15	K25	K35	S05	S15	S25	S35
PVD	YG602			602			602			602					602		

YG602 P20 - P35 M20 - M40 K20 - K40 S15 - S25	PVD - TiAlN 	Universal grade for Parting & Groove Turn <ul style="list-style-type: none"> • Ultra Dense PVD Coating with optimal thermal resistance & strength • Sub-Micron substrate designed for demanding application
--	-----------------	--

Parting & Groove Turn Inserts

	TD. Series	Inserts	2, 3, 4
		TDN TDP TDY	

Parting & Groove Turn Chipbreakers

-P TDP			<ul style="list-style-type: none"> • Parting & Grooving (Positive)
-N TDN			<ul style="list-style-type: none"> • Parting & Grooving (General)
-Y TDY			<ul style="list-style-type: none"> • Groove Turn

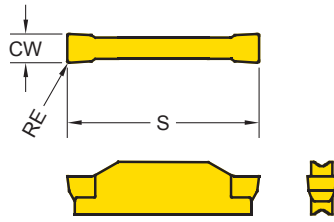

Parting & Groove Turn - Inserts

Parting & Groove Turn Inserts (TD.)



Series	CW
TD□2	.079
TD□3	.118
TD□4	.157

●: Stock item ○: Order made item

TD.	Designation	RE	Parting & Grooving		Groove Turn		YG602
			Fn (inch/rev.)	Tmax (inch)	Fn (inch/rev.)	Ap (inch)	
TDP  Parting & Grooving (Positive)	TDP 2002	.008	.002~.005	.75	-	-	●
	TDP 3002	.008	.002~.006	.75	-	-	●
	TDP 4003	.012	.002~.007	.75	-	-	●
TDN  Parting & Grooving (General)	TDN 2002	.008	.002~.007	.75	-	-	●
	TDN 3002	.008	.003~.009	.75	-	-	●
	TDN 4003	.012	.003~.010	.75	-	-	●
TDY  Groove Turn	TDY 3 E - 0.4	.016	.004~.008	.75	.004~.015	.020~.087	●
	TDY 4 E - 0.4	.016	.006~.010	.75	.004~.016	.020~.110	●

Cutting Speed			Vc (ft/min.)	
ISO	VDI	Sub Group	YG602	
			Min.	Max.
P	1~5	Non Alloy Steel	300	590
	6~9	Low Alloy Steel	260	390
	10~11	High Alloy Steel	260	360
M	12~13	Ferritic & Martensitic	230	520
	14	Austenitic Stainless Steel	180	460
K	15~16	Grey Cast Iron	360	610
	17~18	Nodular Cast Iron	360	460
N	21~30	Aluminum	820	1440
S	31~37	Heat Resistant Super Alloy	80	150
H	38~41	Hardened Material	80	160



MILLING



Code Keys - Milling Cutters

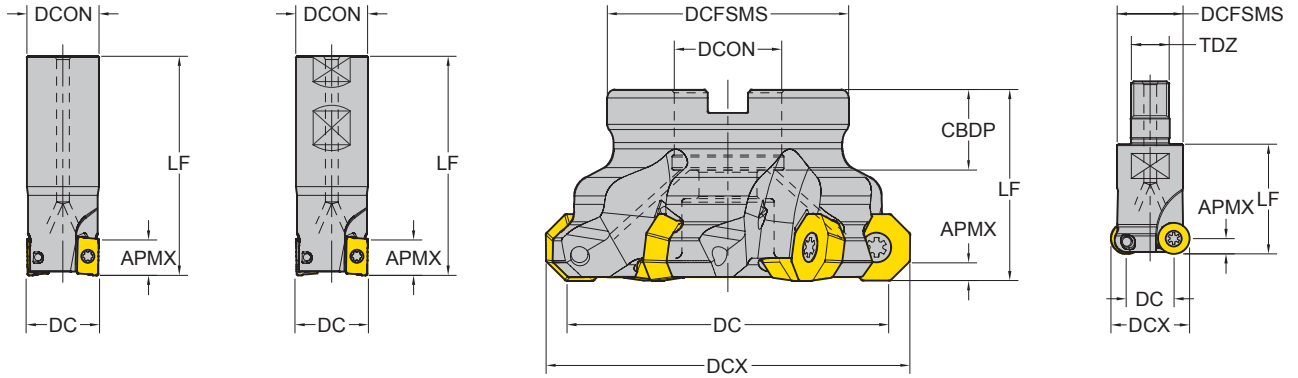

<C> Cylindrical

<W> Weldon

<S> Shell Mill

<M> Modular

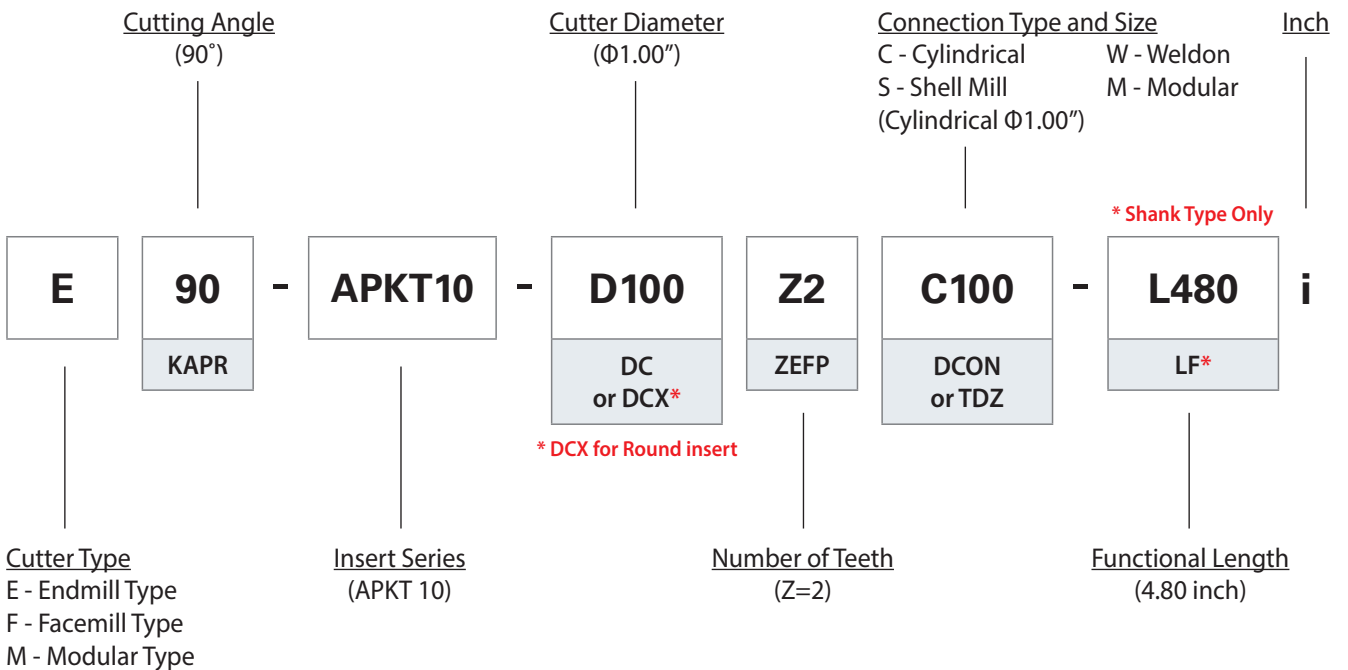

Milling - Code System

Insert Code System

1 A Shape	2 P Relief Angle (AN)	3 K Tolerance	4 T Clamping & Chipbreaker	5 16 Insert Size	6 04 Insert Thickness (S)	7 08 Corner Radius
-------------------------------	---	-----------------------------------	--	--------------------------------------	---	--

1 - Shape

Symbol	Shape	
H	Hexagonal	
O	Octagonal	
P	Pentagonal	
S	Square	
T	Triangular	
V	Rhombic 35°	
W	Trigon	
L	Rectangular	
A	Parallelogram 80°	
R	Round	

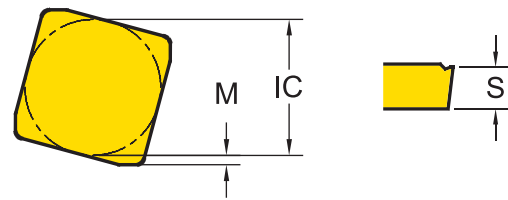

2 - Relief Angle (AN)

Symbol	Relief Angle (AN)	
N	No Relief Angle	
C	Relief 7°	
P	Relief 11°	
D	Relief 15°	
E	Relief 20°	
F	Relief 25°	
O	Special	

3 - Tolerance Class

Symbol	Inner Circle IC (inch)	Nose Height M (inch)	Thickness S (inch)
E	±.001	±.0010	±.001
G	±.001	±.0010	±.005
K	±.002~.006	±.0005	±.005
M	±.002~.006	±.003~.010	±.005
U	±.003~.010	±.005~.015	±.005

4 - Clamping & Chipbreaker

Symbol	Clamping	Chipbreaker	Figure
N	No clamping hole	X	
R		One Face	
W	Screw Hole	X	
T		One Face	
U		Both Faces	
X	Special		

5 - Insert Size

* No Standard for milling insert size

6 - Insert Thickness

* No Standard for milling insert thickness

<p>page 43</p> <div style="border: 1px solid black; padding: 10px; width: 100%;"> <p>8</p> <p>PDTR</p> <p>Corner Geometry</p> </div>	<p>page 43</p> <div style="border: 1px solid black; padding: 10px; width: 100%;"> <p>9</p> <p>-TR</p> <p>Chipbreaker</p> </div>	<p>page 43</p> <div style="border: 1px solid black; padding: 10px; width: 100%;"> <p>10</p> <p>YG602</p> <p>Grade</p> </div>
--	---	--

7 - Corner Radius (RE)

Symbol	Corner Radius - RE (inch)	Symbol	Corner Radius - RE (inch)
04	1/64	16	1/16
08	1/32	20	5/64
12	3/64	24	3/32

8 - Corner Geometry

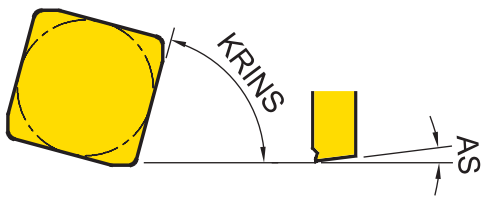

8-1	8-2	8-3	8-4
P	D	T	R
Cutting Edge Angle (KRINS)	Wiper Edge Clearance (AS)	Edge Condition	Feed Direction

*Refer to page. 45 for -AL, -ST, -TR... types

8-1 - Cutting Edge Angle (KRINS)

Symbol	Cutting Edge Angle (KRINS)
P	90°
A	45°
D	60°
E	75°
F	85°
Z	Special

8-3 - Edge Condition

Symbol	Cutting Edge Condition
F	Sharp
E	Rounded
T	Chamfered
S	Chamfered and Rounded





8-2 - Wiper Edge Clearance (AS)

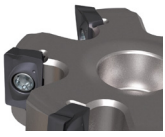

Symbol	Wiper Edge Clearance (AS)
N	0°
P	11°
D	15°
E	20°
F	25°
Z	Special

8-4 - Feed Direction

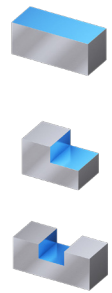
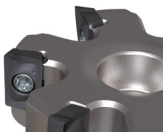

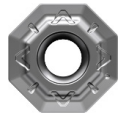
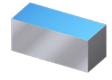

Symbol	Cutting Feed Direction
R	Right-hand Insert
N	Neutral Insert
L	Left-hand Insert

Milling Cutters Overview

Shoulder Mill		Diameter											Application			
		Type	.625	.75	1	1.25	1.5	2	2.5	3	4	5		6		
 <p>APKT 2 Corner 90° Positive (p. 45)</p>	<p>APKT 1604 (APMX .630")</p> 	CYL			●	●										
 <p>APMT 2 Corner 90° Positive (p. 47)</p>	<p>APMT 1135 (APMX .390")</p> 	CYL	●													
			WEL		●	●	●									
			CYL				●									
	<p>APMT 1604 (APMX .630")</p> 															

Face Mill		Diameter											Application		
		Type	.625	.75	1	1.25	1.5	2	2.5	3	4	5		6	
 <p>ODMT 8 Corner 43° Positive (p. 51)</p>	<p>ODMT 0605 ODMW 0605 (APMX .138")</p> 	SHL							●	●	●	●			
 <p>SEKT 4 Corner 45° Positive (p. 63)</p>	<p>SEKT 1204 (APMX .236")</p> 	SHL					●	●	●	●	●	●	●		

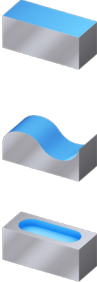
CYL : Cylindrical
WEL : Weldon Shank
SHL : Shell Mill
MOD : Modular

Copy Mill		Diameter											Application				
		Type	.625	.75	1	1.25	1.5	2	2.5	3	4	5		6			
 <p>RDKT Round Positive (p. 55)</p>	RDKT 0802 RDKW 0802 (APMX .157") 	CYL		●	●												
	MOD		●	●													
	RDKT 10T3 RDKW 10T3 (APMX .197") 	CYL			●												
	SHL						●	●									
	MOD				●												
	RDKT 1204 RDKW 1204 (APMX .236") 	CYL			●	●											
	SHL							●	●	●							
	MOD				●	●											

CYL : Cylindrical
WEL : Weldon Shank
SHL : Shell Mill
MOD : Modular

Milling Inserts Overview

A 2 Corner	 Positive	APKT +Cutters	APKT 1003, 1604	p. 44
		APMT +Cutters	APMT 1135, 1604	p. 46
		ADKT	ADKT 1505	p. 48
		AOMT	AOMT 1236	p. 49
O Octagon	 Positive	ODMT +Cutters	ODMT 0605 ODMW 0605	p. 50
		OFER	OFER 0704	p. 52
	OFMT	OFMT 05T3		
 Negative	ONMU	ONMU 0806	p. 53	
R Round	 Positive	RDKT +Cutters	RDKT 0802, 10T3, 1204 RDKW 0802, 10T3, 1204	p. 54
		RDKW	RDKW 0501, 0702	
		RPMT	RPMT 08T2, 10T3, 1204 RPMW 1003, 1204	p. 56
S Square	 High Feed	SDMT / SDMW	SDMT 1204, SDMW 1204	p. 59
	 Positive	SDKN (45°)	SDKN 1203, 1504	p. 58
		SEKN / SEKR (45°)	SEKN / SEKR (45°)	p. 60
		SEKT 12T3	SEKT 12T3	p. 61
	 ISO	SEKT +Cutters	SEKT 1204	p. 62
		SPKN/SPKR (75°)	SPKN 1203, 1504 SPKR 1203	p. 64
	SPUN	SPUN 1203		
 Negative	SNMX	SNMX1206	p. 65	
T Triangle	 ISO	TPKN / TPKR (90°)	TPKN 1603, 2204 TPKR 1603, 2204	p. 66
		TPUN	TPUN 160308	

Milling Grade and Chipbreakers

Milling Grades

Milling Grades		P Steel				M Stainless Steel				K Cast Iron				N Non Ferrous				S Super Alloy			
		P05	P15	P25	P35	M05	M15	M25	M35	K05	K15	K25	K35	N05	N15	N25	N35	S05	S15	S25	S35
PVD	YG602			602				602				602								602	
	YG200													200							

<p>YG602</p> <p>P20 - P35 M20 - M40</p> <p>K20 - K40 S15 - S25</p>	<p>PVD - TiAlN</p>	<p>Universal grade for General Milling Application</p> <ul style="list-style-type: none"> • Ultra Dense PVD Coating with optimal thermal resistance & strength • Sub-Micron substrate designed for demanding application
<p>YG200</p> <p>N05 - N35</p>	<p>PVD - CrN</p>	<p>Optimized grade for Aluminum</p> <ul style="list-style-type: none"> • Sub-Micron substrate designed for Aluminum application • With unique PVD coating

Milling Chipbreakers

P	M	K	N	S	H			
			N			-AL		<ul style="list-style-type: none"> • For Aluminum • Very Sharp Geometry
	M			S		-ST		<ul style="list-style-type: none"> • For Stainless Steel, Super Alloy • Sharp Geometry
P	M	K				General Inserts (No Description)		<ul style="list-style-type: none"> • First Choice for General Application
P		K				-TR		<ul style="list-style-type: none"> • For Hardened Steels • Reinforced Geometry
P		K			H	...W / ...N		<ul style="list-style-type: none"> • For Hardened Material and Cast Irons



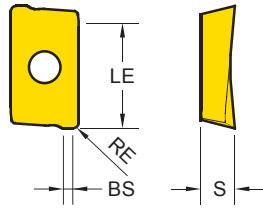

Milling - Inserts

APKT 10, 16 - 2 Corner Positive



Series	LE	IC	S
APKT 1003	.390	.264	.142
APKT 1604	.598	.370	.209

● : Stock item ○ : Order made item

APKT	Designation	RE (inch)	Fz (inch/tooth)	BS (inch)	YG602	YG200
APKT General 	APKT 100305 PDTR	.020	.006~.009	.034	●	
	APKT 100308 PDTR	.031	.006~.009	.035	●	
	APKT 160404 PDTR	.016	.006~.010	.044	●	
	APKT 160408 PDTR	.031	.006~.012	.052	●	
	APKT 160412 PDTR	.047	.006~.013	.044	●	
	APKT 160416 PDTR	.063	.006~.013	.044	●	
	APKT 160416 PDTR	.094	.006~.011	-	●	
-AL Aluminum 	APKT 100305 - AL	.020	.003~.020	.034		●
	APKT 160408 - AL	.031	.003~.020	.052		●
-ST Stainless Steel Super Alloy 	APKT 100305 - ST	.020	.003~.009	.034	●	
	APKT 160408 - ST	.031	.003~.010	.052	●	
-TR Hardened Steel 	APKT 160408 - TR	.031	.010~.016	.052	●	

Cutting Speed			Vc (ft/min.)			
ISO	VDI	Sub Group	YG602		YG200	
			Min.	Max.	Min.	Max.
P	1~5	Non Alloy Steel	460	790	-	-
	6~9	Low Alloy Steel	390	720	-	-
	10~11	High Alloy Steel	230	490	-	-
M	12~13	Ferritic & Martensitic	390	660	-	-
	14	Austenitic Stainless Steel	460	820	-	-
K	15~16	Grey Cast Iron	460	720	-	-
	17~18	Nodular Cast Iron	490	790	-	-
N	21~30	Aluminum	-	-	980	2620
S	31~37	Heat Resistant Super Alloy	80	150	-	-
H	38~41	Hardened Material	130	260	-	-

Milling - Cutter - Shouldermilling

APKT16 Shoulder Mill

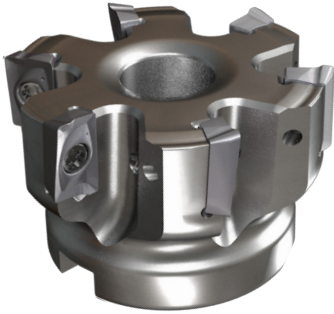

2 Corner Positive Inserts
Cutting Angle : 90°

<C> Cylindrical

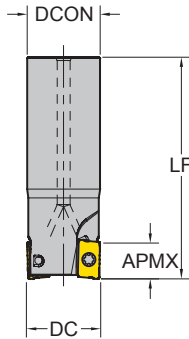

<W> Weldon

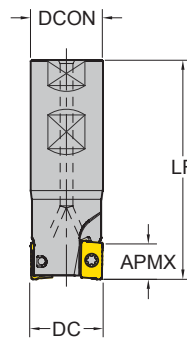

<S> Shell Mill

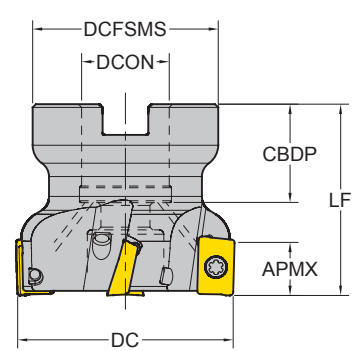

Cutters - APKT 16

(inch)

EDP	Designation	Type	Z	DC	LF	DCON	CBDP	DCFSMS	APMX	
17000089	E90 - APKT16 - D100Z2C0875 - L378i	C	2	1.00	3.78	.875	-	-	.630	
17000090	E90 - APKT16 - D125Z3C100 - L428i	C	3	1.25	4.28	1.00	-	-	.630	

Screw : TP154008

Wrench : TPWFTP15

Milling - Inserts

APMT 11, 16 - 2 Corner Positive

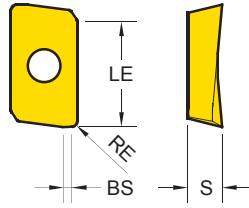

Series	LE	IC	S
APMT 1135	.374	.244	.138
APMT 1604	.575	.362	.187

● : Stock item ○ : Order made item

APMT	Designation	RE (inch)	Fz (inch/tooth)	BS (inch)	YG602	YG200
APMT General 	APMT 113504 PDTR	.016	.006~.009	.050	●	
	APMT 113508 PDTR	.031	.006~.010	.042	●	
	APMT 160408 PDTR	.031	.006~.012	.044	●	

Cutting Speed			Vc (ft/min.)			
ISO	VDI	Sub Group	YG602		YG200	
			Min.	Max.	Min.	Max.
P	1~5	Non Alloy Steel	460	790	-	-
	6~9	Low Alloy Steel	390	720	-	-
	10~11	High Alloy Steel	230	490	-	-
M	12~13	Ferritic & Martensitic	390	660	-	-
	14	Austenitic Stainless Steel	460	820	-	-
K	15~16	Grey Cast Iron	460	720	-	-
	17~18	Nodular Cast Iron	490	790	-	-
N	21~30	Aluminum	-	-	980	2620
S	31~37	Heat Resistant Super Alloy	80	150	-	-
H	38~41	Hardened Material	130	260	-	-

Milling - Cutter - Shouldermilling

APMT 11, 16 Shoulder Mill



2 Corner Positive Inserts
Cutting Angle : 90°

<C> Cylindrical

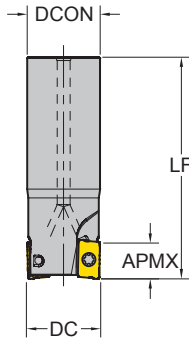

<W> Weldon

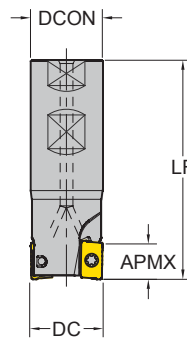

<S> Shell Mill

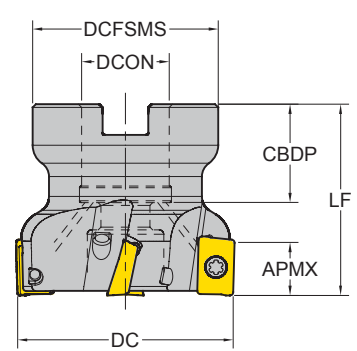

Cutters - APMT 11

EDP	Designation	Type	Z	DC	LF	DCON	CBDP	DCFSMS	APMX	(inch)
17000098	E90 - APMT11 - D0625Z2C0625 - L400i	C	2	0.625	4.00	0.625	-	-	.390	●
17000099	E90 - APMT11 - D075Z2W075 - L354i	W	2	0.75	3.54	0.75	-	-	.390	●
17000100	E90 - APMT11 - D100Z4W100 - L428i	W	4	1.00	4.28	1.00	-	-	.390	●
17000101	E90 - APMT11 - D125Z4W100 - L428i	W	4	1.25	4.28	1.00	-	-	.390	●

Screw : TP072506

Wrench : TPWFTP07

Cutters - APMT 16

EDP	Designation	Type	Z	DC	LF	DCON	CBDP	DCFSMS	APMX	(inch)
17000106	E90 - APMT16 - D125Z3W125 - L390i	W	3	1.25	3.90	1.25	-	-	.630	●

Screw : TP154008

Wrench : TPWFTP15

Milling - Inserts

ADKT - 2 Corner Positive

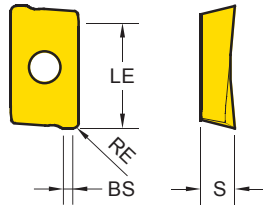

Series	LE	IC	S
ADKT 1505	.539	.382	.228

● : Stock item ○ : Order made item

ADKT	Designation	RE (inch)	Fz (inch/tooth)	BS (inch)	YG602	YG200
ADKT General 	ADKT 1505 PDTR	.031	.006~.012	.074	●	

Cutting Speed			Vc (ft/min.)			
ISO	VDI	Sub Group	YG602		YG200	
			Min.	Max.	Min.	Max.
P	1~5	Non Alloy Steel	460	790	-	-
	6~9	Low Alloy Steel	390	720	-	-
	10~11	High Alloy Steel	230	490	-	-
M	12~13	Ferritic & Martensitic	390	660	-	-
	14	Austenitic Stainless Steel	460	820	-	-
K	15~16	Grey Cast Iron	460	720	-	-
	17~18	Nodular Cast Iron	490	790	-	-
N	21~30	Aluminum	-	-	980	2620
S	31~37	Heat Resistant Super Alloy	80	150	-	-
H	38~41	Hardened Material	130	260	-	-

Milling - Inserts

AOMT - 2 Corner Positive

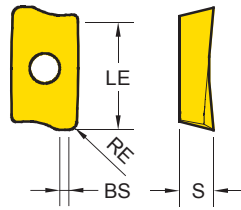

Series	LE	IC	S
AOMT 1236	.413	.260	.142

● : Stock item ○ : Order made item

AOMT	Designation	RE (inch)	Fz (inch/tooth)	BS (inch)	YG602	YG200
AOMT General	AOMT 123604 PDR	.016	.003~.009	.042	●	
	AOMT 123608 PDR	.031	.003~.009	.036	●	



Cutting Speed			Vc (ft/min.)			
ISO	VDI	Sub Group	YG602		YG200	
			Min.	Max.	Min.	Max.
P	1~5	Non Alloy Steel	460	790	-	-
	6~9	Low Alloy Steel	390	720	-	-
	10~11	High Alloy Steel	230	490	-	-
M	12~13	Ferritic & Martensitic	390	660	-	-
	14	Austenitic Stainless Steel	460	820	-	-
K	15~16	Grey Cast Iron	460	720	-	-
	17~18	Nodular Cast Iron	490	790	-	-
N	21~30	Aluminum	-	-	980	2620
S	31~37	Heat Resistant Super Alloy	80	150	-	-
H	38~41	Hardened Material	130	260	-	-

Milling - Inserts

ODMT / ODMW - 8 Corner Positive

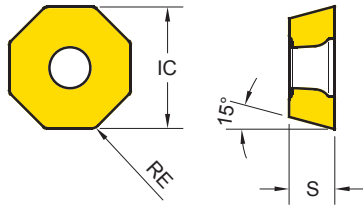

Series	IC	S
ODM□0605	.626	.220

● : Stock item ○ : Order made item

ODMT ODMW		Designation	RE (inch)	Fz (inch/tooth)	BS (inch)	YG602	YG200
ODMT General		ODMT 060508	.031	.008~.014	-	●	
ODMW Hard Materials		ODMW 060508	.031	.010~.016	-	●	

Cutting Speed			Vc (ft/min.)			
ISO	VDI	Sub Group	YG602		YG200	
			Min.	Max.	Min.	Max.
P	1~5	Non Alloy Steel	460	790	-	-
	6~9	Low Alloy Steel	390	720	-	-
	10~11	High Alloy Steel	230	490	-	-
M	12~13	Ferritic & Martensitic	390	660	-	-
	14	Austenitic Stainless Steel	460	820	-	-
K	15~16	Grey Cast Iron	460	720	-	-
	17~18	Nodular Cast Iron	490	790	-	-
N	21~30	Aluminum	-	-	980	2620
S	31~37	Heat Resistant Super Alloy	80	150	-	-
H	38~41	Hardened Material	130	260	-	-

Milling - Cutter - Facemilling

ODMT 06 Facemill

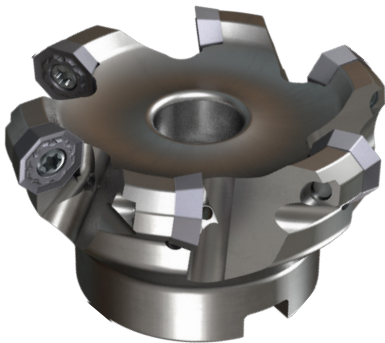

8 Corner Positive Inserts
 APMX .138 inch
 Cutting Angle : 43°

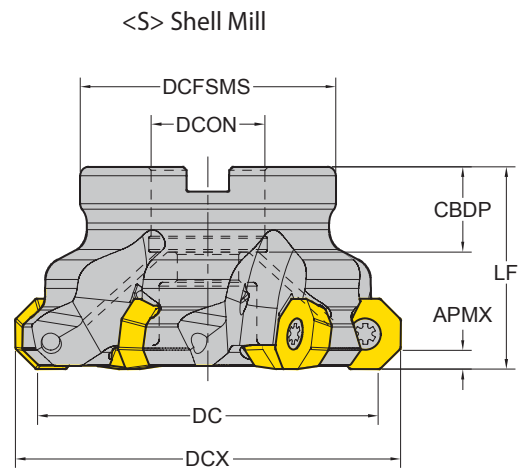

Cutters - ODMT 06

(inch)

EDP	Designation	Type	Z	DC	DCX	LF	DCON	CBDP	DCFSMS	APMX	●
17000040	F43-ODMT06-D250Z5S075i	S	5	2.50	2.88	1.575	.75	.79	2.00	.138	●
17000041	F43-ODMT06-D300Z6S100i	S	6	3.00	3.39	1.75	1.00	.94	2.25	.138	●
17000042	F43-ODMT06-D400Z7S125i	S	7	4.00	4.34	2.00	1.25	.98	3.00	.138	●
17000043	F43-ODMT06-D500Z8S150i	S	8	5.00	5.32	2.38	1.50	1.14	3.65	.138	●

Screw : TP205013

Wrench : TPWFTP20

Milling - Inserts

OFER, OFMT - 8 Corner Positive

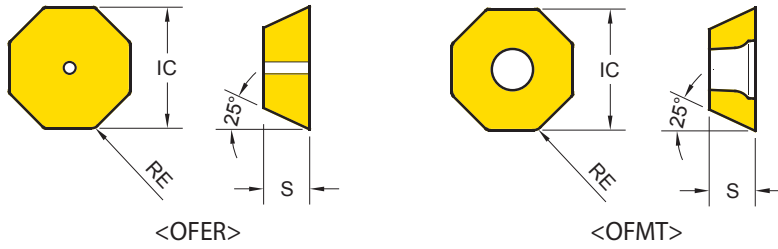

Series	IC	S
OFER 0704	.711	.188
OFMT 05T3	.501	.160

● : Stock item ○ : Order made item

OFER		Designation	RE (inch)	Fz (inch/tooth)	BS (inch)	YG602	YG200
OFER General		OFER 070405	.020	.009~.020	-	●	

OFMT		Designation	RE (inch)	Fz (inch/tooth)	BS (inch)	YG602	YG200
OFMT General		OFMT 05T308	.031	.006~.010	-	●	

Cutting Speed			Vc (ft/min.)			
ISO	VDI	Sub Group	YG602		YG200	
			Min.	Max.	Min.	Max.
P	1~5	Non Alloy Steel	460	790	-	-
	6~9	Low Alloy Steel	390	720	-	-
	10~11	High Alloy Steel	230	490	-	-
M	12~13	Ferritic & Martensitic	390	660	-	-
	14	Austenitic Stainless Steel	460	820	-	-
K	15~16	Grey Cast Iron	460	720	-	-
	17~18	Nodular Cast Iron	490	790	-	-
N	21~30	Aluminum	-	-	980	2620
S	31~37	Heat Resistant Super Alloy	80	150	-	-
H	38~41	Hardened Material	130	260	-	-

Milling - Inserts

ONMU - 16 Corner Negative

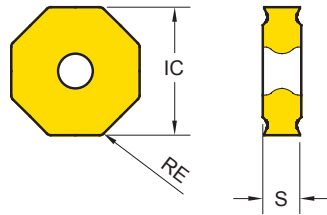

Series	IC	S
ONMU 0806	.795	.228

● : Stock item ○ : Order made item

ONMU		Designation	RE (inch)	Fz (inch/tooth)	BS (inch)	YG602	YG200
ONMU General		ONMU 080608	.031	.009~.020	-	●	

Cutting Speed			Vc (ft/min.)			
ISO	VDI	Sub Group	YG602		YG200	
			Min.	Max.	Min.	Max.
P	1~5	Non Alloy Steel	460	790	-	-
	6~9	Low Alloy Steel	390	720	-	-
	10~11	High Alloy Steel	230	490	-	-
M	12~13	Ferritic & Martensitic	390	660	-	-
	14	Austenitic Stainless Steel	460	820	-	-
K	15~16	Grey Cast Iron	460	720	-	-
	17~18	Nodular Cast Iron	490	790	-	-
N	21~30	Aluminum	-	-	980	2620
S	31~37	Heat Resistant Super Alloy	80	150	-	-
H	38~41	Hardened Material	130	260	-	-

Milling - Inserts

RDKT - Round Inserts

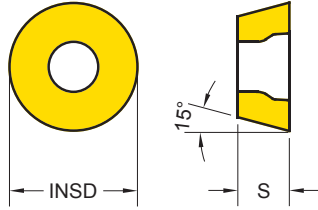

Series	INSD	S
RDK□0501	.197	.055
RDK□0702	.276	.094
RDK□0802	.315	.094
RDK□10T3	.394	.157
RDK□1204	.472	.189

● : Stock item ○ : Order made item

RDKT		Designation	Fz (inch/tooth)	YG602	YG200
RDKT General		RDKT 0802M0	.006~.010	●	
		RDKT 10T3M0	.006~.011	●	
		RDKT 1204M0	.008~.012	●	
-ST Stainless Steel Super Alloy		RDKT 0802M0 - ST	.003~.010	●	
		RDKT 10T3M0 - ST	.003~.011	●	
		RDKT 1204M0 - ST	.004~.012	●	
-TR Hardened Steel		RDKT 0802M0 - TR	.007~.014	●	
		RDKT 10T3M0 - TR	.009~.016	●	
		RDKT 1204M0 - TR	.009~.016	●	
RDKW Hard Materials		RDKW 0501M0	.004~.008	●	
		RDKW 0702M0	.005~.010	●	
		RDKW 0802M0	.005~.010	●	
		RDKW 10T3M0	.006~.012	●	
		RDKW 1204M0	.006~.014	●	

Cutting Speed			Vc (ft/min.)			
ISO	VDI	Sub Group	YG602		YG200	
			Min.	Max.	Min.	Max.
P	1~5	Non Alloy Steel	460	790	-	-
	6~9	Low Alloy Steel	390	720	-	-
	10~11	High Alloy Steel	230	490	-	-
M	12~13	Ferritic & Martensitic	390	660	-	-
	14	Austenitic Stainless Steel	460	820	-	-
K	15~16	Grey Cast Iron	460	720	-	-
	17~18	Nodular Cast Iron	490	790	-	-
N	21~30	Aluminum	-	-	980	2620
S	31~37	Heat Resistant Super Alloy	80	150	-	-
H	38~41	Hardened Material	130	260	-	-

Milling - Cutter - Copymilling

RDKT 08, 10, 12 Copymill



Round Positive Inserts

<C> Cylindrical

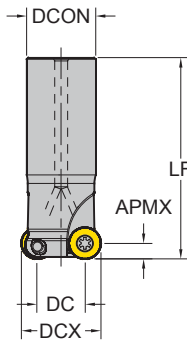

<S> Shell Mill

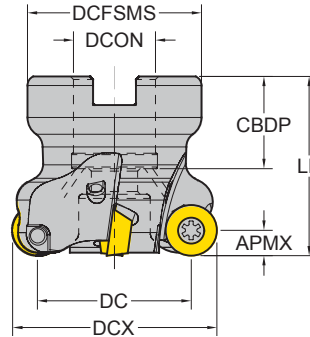

<M> Modular

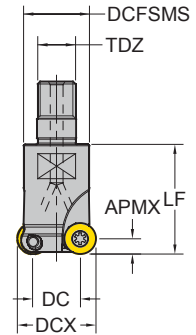

Cutters - RDKT 08

EDP	Designation	Type	Z	DC	DCX	LF	DCON	CBDP	DCFSMS	APMX	(inch)
17000044	E - RDKT08 - D075Z2C075 - L700i	C	2	.435	.75	7.00	.75	-	-	.157	●
17000045	E - RDKT08 - D100Z3C075 - L700i	C	3	.685	1.00	7.00	.75	-	-	.157	●
17000046	M - RDKT08 - D075Z2M10i	M	2	.435	.75	1.25	M10	-	-	.157	●
17000047	M - RDKT08 - D100Z3M12i	M	3	.685	1.00	1.50	M12	-	-	.157	●

Screw : TP082505



Wrench : TPWFTP08

Cutters - RDKT 10

EDP	Designation	Type	Z	DC	DCX	LF	DCON	CBDP	DCFSMS	APMX	(inch)
17000048	E - RDKT10 - D100Z2C100 - L700i	C	2	.606	1.00	7.00	1	-	-	.196	●
17000049	M - RDKT10 - D100Z3M12i	M	3	.606	1.00	1.50	M12	-	0.827	.196	●
17000050	F - RDKT10 - D150Z5S050i	S	5	1.106	1.50	1.575	.50	.71	1.25	.196	●
17000051	F - RDKT10 - D200Z6S075i	S	6	1.606	2.00	1.75	.75	.79	1.575	.196	●

Screw : TP154008RD



Wrench : TPWFTP15

Cutters - RDKT 12

EDP	Designation	Type	Z	DC	DCX	LF	DCON	CBDP	DCFSMS	APMX	(inch)
17000052	E - RDKT12 - D100Z2C100 - L700i	C	2	.527	1.00	7.00	1	-	-	.236	●
17000053	E - RDKT12 - D125Z2C125 - L800i	C	2	.777	1.25	8.00	1.25	-	-	.236	●
17000054	E - RDKT12 - D125Z3C125 - L600i	C	3	.777	1.25	6.00	1.25	-	-	.236	●
17000055	M - RDKT12 - D100Z2M12i	M	2	.527	1.00	1.50	M12	-	0.827	.236	●
17000056	M - RDKT12 - D125Z3M16i	M	3	.777	1.25	1.50	M16	-	1.142	.236	●
17000057	F - RDKT12 - D150Z4S050i	S	4	1.027	1.50	1.575	.50	.71	1.25	.236	●
17000058	F - RDKT12 - D200Z5S075i	S	5	1.527	2.00	1.75	.75	.79	1.575	.236	●
17000059	F - RDKT12 - D250Z6S075i	S	6	2.027	2.50	1.75	.75	.79	1.75	.236	●

Screw : TP154009 Clamp : TP153507



Wrench : TPWFTP15

Milling - Inserts

RPMT - Round Inserts

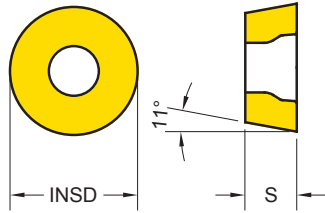

Series	INSD	S
RPMT 08T2	.315	.109
RPMT 10T3	.394	.156
RPMT 1204	.472	.187

● : Stock item ○ : Order made item

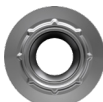
RPMT	Designation	Fz (inch/tooth)	YG602	YG200
RPMT General 	RPMT 08T2M0	.004~.009	●	
	RPMT 10T3M0	.006~.012	●	
	RPMT 1204M0	.008~.014	●	
-ST Stainless Steel Super Alloy 	RPMT 1204M0 - ST	.004~.012	●	

Cutting Speed			Vc (ft/min.)			
ISO	VDI	Sub Group	YG602		YG200	
			Min.	Max.	Min.	Max.
P	1~5	Non Alloy Steel	460	790	-	-
	6~9	Low Alloy Steel	390	720	-	-
	10~11	High Alloy Steel	230	490	-	-
M	12~13	Ferritic & Martensitic	390	660	-	-
	14	Austenitic Stainless Steel	460	820	-	-
K	15~16	Grey Cast Iron	460	720	-	-
	17~18	Nodular Cast Iron	490	790	-	-
N	21~30	Aluminum	-	-	980	2620
S	31~37	Heat Resistant Super Alloy	80	150	-	-
H	38~41	Hardened Material	130	260	-	-

Milling - Inserts

RPMW - Round Inserts

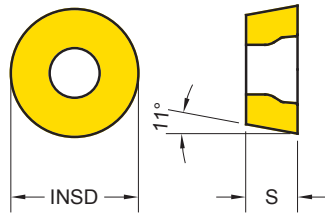

Series	INSD	S
RPMW 1003	.394	.125
RPMW 1204	.472	.187

● : Stock item ○ : Order made item

RPMW	Designation	Fz (inch/tooth)	Material	
			YG602	YG200
RPMW Hard Materials	RPMW 1003M0	.006~.012	●	
	RPMW 1204M0	.006~.014	●	



Cutting Speed			Vc (ft/min.)			
ISO	VDI	Sub Group	YG602		YG200	
			Min.	Max.	Min.	Max.
P	1~5	Non Alloy Steel	460	790	-	-
	6~9	Low Alloy Steel	390	720	-	-
	10~11	High Alloy Steel	230	490	-	-
M	12~13	Ferritic & Martensitic	390	660	-	-
	14	Austenitic Stainless Steel	460	820	-	-
K	15~16	Grey Cast Iron	460	720	-	-
	17~18	Nodular Cast Iron	490	790	-	-
N	21~30	Aluminum	-	-	980	2620
S	31~37	Heat Resistant Super Alloy	80	150	-	-
H	38~41	Hardened Material	130	260	-	-

Milling - Inserts

SDKN - 4 Corner Square ISO

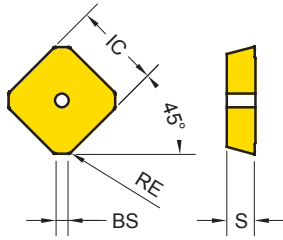

Series	AS	IC	S
SDK□42	15°	.500	.122
SDK□53	15°	.625	.185
SEK□42	20°	.500	.126

● : Stock item ○ : Order made item

SDKN	Designation	RE (inch)	Fz (inch/tooth)	BS (inch)	YG602	YG200
					●	○
SDKN Hard Materials 	SDKN 42 AETN	.020	.009~.014	.073	●	
	SDKN 42 AETN - PW	.016	.009~.014	.078	●	
	SDKN 53 AETN	.018	.009~.016	.079	●	
	SDKN 53 AETN - PW	.016	.009~.016	.077	●	

- PW : for improved surface roughness

Cutting Speed			Vc (ft/min.)			
ISO	VDI	Sub Group	YG602		YG200	
			Min.	Max.	Min.	Max.
P	1~5	Non Alloy Steel	460	790	-	-
	6~9	Low Alloy Steel	390	720	-	-
	10~11	High Alloy Steel	230	490	-	-
M	12~13	Ferritic & Martensitic	390	660	-	-
	14	Austenitic Stainless Steel	460	820	-	-
K	15~16	Grey Cast Iron	460	720	-	-
	17~18	Nodular Cast Iron	490	790	-	-
N	21~30	Aluminum	-	-	980	2620
S	31~37	Heat Resistant Super Alloy	80	150	-	-
H	38~41	Hardened Material	130	260	-	-

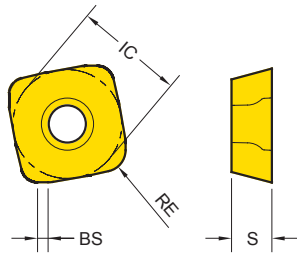

Milling - Inserts

SDMT / W - 4 Corner Square High Feed



Series	IC	S
SDM□1204	.500	.185

● : Stock item ○ : Order made item

SDMT SDMW	Designation	RE (inch)	Fz (inch/tooth)	BS (inch)	YG602	YG200
-ST Stainless Steel Super Alloy 	SDMT 120420 -ST	.075	.024~.047	.057	○	
SDMW Hard Materials 	SDMW 120420	.075	.024~.055	.055	○	

Cutting Speed			Vc (ft/min.)			
ISO	VDI	Sub Group	YG602		YG200	
			Min.	Max.	Min.	Max.
P	1~5	Non Alloy Steel	460	790	-	-
	6~9	Low Alloy Steel	390	720	-	-
	10~11	High Alloy Steel	230	490	-	-
M	12~13	Ferritic & Martensitic	390	660	-	-
	14	Austenitic Stainless Steel	460	820	-	-
K	15~16	Grey Cast Iron	460	720	-	-
	17~18	Nodular Cast Iron	490	790	-	-
N	21~30	Aluminum	-	-	980	2620
S	31~37	Heat Resistant Super Alloy	80	150	-	-
H	38~41	Hardened Material	130	260	-	-

Milling - Inserts

SEKR / N - 4 Corner Square ISO

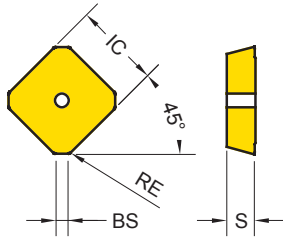

Series	AS	IC	S
SDK□42	15°	.500	.122
SDK□53	15°	.625	.185
SEK□42	20°	.500	.126

● : Stock item ○ : Order made item

SEKR SEKN		Designation	RE (inch)	Fz (inch/tooth)	BS (inch)	YG602	YG200
SEKR General		SEKR 42 AETN	.016	.006~.012	.055	●	
		SEKR 42 AFTN - PW	.016	.006~.012	.055	●	
SEKN Hard Materials		SEKN 42 AETN	.016	.009~.014	.055	●	
		SEKN 42 AETN - PW	.016	.009~.014	.055	●	

- PW : for improved surface roughness

Cutting Speed			Vc (ft/min.)			
ISO	VDI	Sub Group	YG602		YG200	
			Min.	Max.	Min.	Max.
P	1~5	Non Alloy Steel	460	790	-	-
	6~9	Low Alloy Steel	390	720	-	-
	10~11	High Alloy Steel	230	490	-	-
M	12~13	Ferritic & Martensitic	390	660	-	-
	14	Austenitic Stainless Steel	460	820	-	-
K	15~16	Grey Cast Iron	460	720	-	-
	17~18	Nodular Cast Iron	490	790	-	-
N	21~30	Aluminum	-	-	980	2620
S	31~37	Heat Resistant Super Alloy	80	150	-	-
H	38~41	Hardened Material	130	260	-	-

Milling - Inserts

SEKT 12T3 - 4 Corner Positive

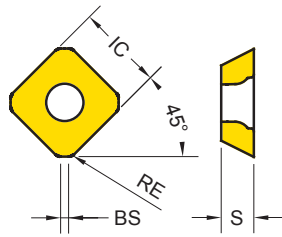

Series	IC	S
SEKT 12T3	.528	.157

● : Stock item ○ : Order made item

SEKT 12T3		Designation	RE (inch)	Fz (inch/tooth)	BS (inch)	YG602	YG200
SEKT 12T3 General		SEKT 12T3 AGTN	.059	.006~.012	.051	●	
-AL Aluminum		SEKT 12T3 -AL	.059	.003~.022	.051		●
-ST Stainless Steel Super Alloy		SEKT 12T3 -ST	.059	.003~.012	.051	●	

Cutting Speed			Vc (ft/min.)			
ISO	VDI	Sub Group	YG602		YG200	
			Min.	Max.	Min.	Max.
P	1~5	Non Alloy Steel	460	790	-	-
	6~9	Low Alloy Steel	390	720	-	-
	10~11	High Alloy Steel	230	490	-	-
M	12~13	Ferritic & Martensitic	390	660	-	-
	14	Austenitic Stainless Steel	460	820	-	-
K	15~16	Grey Cast Iron	460	720	-	-
	17~18	Nodular Cast Iron	490	790	-	-
N	21~30	Aluminum	-	-	980	2620
S	31~37	Heat Resistant Super Alloy	80	150	-	-
H	38~41	Hardened Material	130	260	-	-

Milling - Inserts

SEKT 1204 - 4 Corner Positive

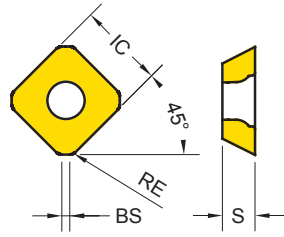

Series	IC	S
SEKT 1204	.500	.193

● : Stock item ○ : Order made item

SEKT 1204		Designation	RE (inch)	Fz (inch/tooth)	BS (inch)	YG602	YG200
SEKT 1204 General		SEKT 1204 AFTN	.043	.008~.014	.046	●	
-AL Aluminum		SEKT 1204 -AL	.043	.003~.022	.046		●
-ST Stainless Steel Super Alloy		SEKT 1204 -ST	.043	.003~.012	.046	●	

Cutting Speed			Vc (ft/min.)			
ISO	VDI	Sub Group	YG602		YG200	
			Min.	Max.	Min.	Max.
P	1~5	Non Alloy Steel	460	790	-	-
	6~9	Low Alloy Steel	390	720	-	-
	10~11	High Alloy Steel	230	490	-	-
M	12~13	Ferritic & Martensitic	390	660	-	-
	14	Austenitic Stainless Steel	460	820	-	-
K	15~16	Grey Cast Iron	460	720	-	-
	17~18	Nodular Cast Iron	490	790	-	-
N	21~30	Aluminum	-	-	980	2620
S	31~37	Heat Resistant Super Alloy	80	150	-	-
H	38~41	Hardened Material	130	260	-	-

Milling - Cutter - Facemilling

SEKT 1204 Facemill



4 Corner Positive Inserts
 APMX .236 inch
 Cutting Angle : 45°

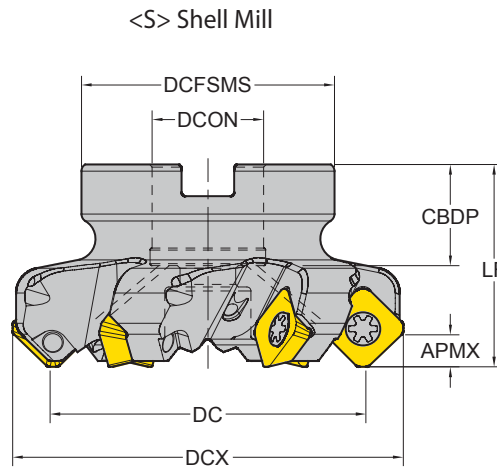

Cutters - SEKT 1204

											(inch)
EDP	Designation	Type	Z	DC	DCX	LF	DCON	CBDP	DCFSMS	APMX	
17000060	F45 - SEKT12 - D150Z4S050i	S	4	1.50	2.11	1.575	.50	.71	1.25	.236	●
17000061	F45 - SEKT12 - D200Z5S075i	S	5	2.00	2.57	1.575	.75	.75	1.75	.236	●
17000062	F45 - SEKT12 - D250Z4S075i	S	4	2.50	3.07	1.575	.75	.75	2.00	.236	●
17000063	F45 - SEKT12 - D250Z6S075i	S	6	2.50	3.07	1.575	.75	.75	2.00	.236	●
17000064	F45 - SEKT12 - D300Z4S100i	S	4	3.00	3.57	1.75	1.00	1.02	2.25	.236	●
17000065	F45 - SEKT12 - D300Z7S100i	S	7	3.00	3.57	1.75	1.00	1.02	2.25	.236	●
17000066	F45 - SEKT12 - D400Z8S125i	S	8	4.00	4.57	2.00	1.25	1.26	3.00	.236	●
17000067	F45 - SEKT12 - D500Z10S150i	S	10	5.00	5.57	2.38	1.50	1.38	3.65	.236	●
17000068	F45 - SEKT12 - D600Z12S200i	S	12	6.00	6.57	2.38	2.00	1.5	4.70	.236	●

Screw : TP204510

Wrench : TPWFTP20

Milling - Inserts

SPKN / R, SPUN - 4 Corner Square ISO

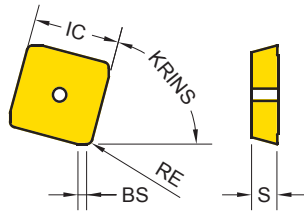

Series	KRINS	AS	IC	S
SPK□42	75°	11°	.500	.126
SPK□53	75°	11°	.625	.189
SPUN 42	-	11°	.500	.126

● : Stock item ○ : Order made item

SPKR SPKN		Designation	RE (inch)	Fz (inch/tooth)	BS (inch)	YG602	YG200
SPKR General		SPKR 42 EDTR	.031	.006~.014	.055	●	
		SPKR 42 EDTR - PW	.031	.006~.014	.055	●	
SPKN Hard Materials		SPKN 42 EDTR	.031	.006~.013	.055	●	
		SPKN 42 EDTR - PW	.031	.008~.014	.055	●	
		SPKN 53 EDTR	-	.006~.013	.051	●	
		SPKN 53 EDTR - PW	-	.010~.016	.051	●	

- PW : for improved surface roughness

SPUN		Designation	RE (inch)	Fz (inch/tooth)	BS (inch)	YG602	YG200
SPUN		SPUN 422	.031	-	-	●	

Cutting Speed			Vc (ft/min.)			
ISO	VDI	Sub Group	YG602		YG200	
			Min.	Max.	Min.	Max.
P	1~5	Non Alloy Steel	460	790	-	-
	6~9	Low Alloy Steel	390	720	-	-
	10~11	High Alloy Steel	230	490	-	-
M	12~13	Ferritic & Martensitic	390	660	-	-
	14	Austenitic Stainless Steel	460	820	-	-
K	15~16	Grey Cast Iron	460	720	-	-
	17~18	Nodular Cast Iron	490	790	-	-
N	21~30	Aluminum	-	-	980	2620
S	31~37	Heat Resistant Super Alloy	80	150	-	-
H	38~41	Hardened Material	130	260	-	-

Milling - Inserts

SNMX - 8 Corner Negative

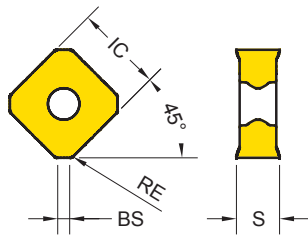

Series	IC	S
SNMX 1206	.500	.246

● : Stock item ○ : Order made item

SNMX	Designation	RE (inch)	Fz (inch/tooth)	BS (inch)	YG602	YG200
	SNMX 1206 ANN	.031	.006~.013	.067	●	

SNMX
General

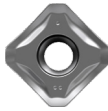

Cutting Speed			Vc (ft/min.)			
ISO	VDI	Sub Group	YG602		YG200	
			Min.	Max.	Min.	Max.
P	1~5	Non Alloy Steel	460	790	-	-
	6~9	Low Alloy Steel	390	720	-	-
	10~11	High Alloy Steel	230	490	-	-
M	12~13	Ferritic & Martensitic	390	660	-	-
	14	Austenitic Stainless Steel	460	820	-	-
K	15~16	Grey Cast Iron	460	720	-	-
	17~18	Nodular Cast Iron	490	790	-	-
N	21~30	Aluminum	-	-	980	2620
S	31~37	Heat Resistant Super Alloy	80	150	-	-
H	38~41	Hardened Material	130	260	-	-

Milling - Inserts

TPKR/N, TPUN - 3 Corner ISO

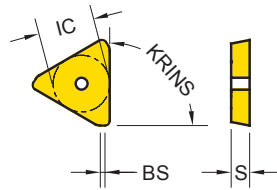

Series	KRINS	IC	S
TPK□32	90°	.375	.125
TPK□43	90°	.500	.187
TPUN 32	-	.375	.125

● : Stock item ○ : Order made item

TPKR TPKN		Designation	RE (inch)	Fz (inch/tooth)	BS (inch)	YG602	YG200
TPKR General		TPKR 32 PDTR	-	.006~.011	.047	●	
		TPKR 32 PDTR - PW	-	.006~.011	.047	●	
		TPKR 43 PDTR	-	.007~.014	.067	●	
		TPKR 43 PDTR - PW	-	.007~.014	.067	●	
TPKN Hard Materials		TPKN 32 PDTR	-	.006~.012	.047	●	
		TPKN 32 PDTR - PW	-	.008~.014	.047	●	
		TPKN 43 PDTR	-	.007~.012	.067	●	
		TPKN 43 PDTR - PW	-	.009~.016	.067	●	

- PW : for improved surface roughness

TPUN		Designation	RE (inch)	Fz (inch/tooth)	BS (inch)	YG602	YG200
TPUN		TPUN 322	.031	-	-	●	

Cutting Speed			Vc (ft/min.)			
ISO	VDI	Sub Group	YG602		YG200	
			Min.	Max.	Min.	Max.
P	1~5	Non Alloy Steel	460	790	-	-
	6~9	Low Alloy Steel	390	720	-	-
	10~11	High Alloy Steel	230	490	-	-
M	12~13	Ferritic & Martensitic	390	660	-	-
	14	Austenitic Stainless Steel	460	820	-	-
K	15~16	Grey Cast Iron	460	720	-	-
	17~18	Nodular Cast Iron	490	790	-	-
N	21~30	Aluminum	-	-	980	2620
S	31~37	Heat Resistant Super Alloy	80	150	-	-
H	38~41	Hardened Material	130	260	-	-



DRILLING

Drilling Overview

Drilling Grades

Drilling Grades		P Steel				M Stainless Steel				K Cast Iron			
		P05	P15	P25	P35	M05	M15	M25	M35	K05	K15	K25	K35
PVD	YG602				602				602				602

YG602 P20 - P35 M20 - M40 K20 - K40 S15 - S25	PVD - TiAlN 	Universal grade for General Drilling Application <ul style="list-style-type: none"> • Ultra Dense PVD Coating with optimal thermal resistance & strength • Sub-Micron substrate designed for demanding application
--	-----------------	---

Universal Drilling Inserts

	4 Corner	SPMX Series	SPMX	05, 06, 07, 09, 11, 14
	ISO 3 Corner	WCMX Series	WCMX	04, 05, 06, 08

Drilling Chipbreakers



P	M	K			
	M			-ST	<ul style="list-style-type: none"> • Sharp Geometry • Sticky Material, Stainless Steel
P	M	K		General Inserts (No Description)	<ul style="list-style-type: none"> • First Choice for General Application

Drilling - Inserts

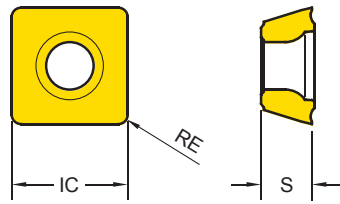
Drilling Inserts (SPMX)



Series	IC	S
SPMX 0502	.197	.094
SPMX 0602	.236	.095
SPMX 07T3	.313	.156
SPMX 0904	.386	.169
SPMX 1104	.453	.193
SPMX 1405	.563	.209

SPMX		Designation	Fn (inch/rev.)	YG602
SPMX General 		SPMX 050204	.003~.006	●
		SPMX 060204	.003~.006	●
		SPMX 07T308	.003~.006	●
		SPMX 090408	.003~.006	●
		SPMX 110408	.004~.007	●
		SPMX 140512	.004~.008	●
-ST Stainless Steel Super Alloy 		SPMX 050204 - ST	.001~.004	●
		SPMX 060204 - ST	.002~.004	●
		SPMX 07T308 - ST	.002~.004	●
		SPMX 090408 - ST	.002~.005	●

Cutting Speed			Vc (ft/min.)	
ISO	VDI	Sub Group	YG602	
			Min.	Max.
P	1~5	Non Alloy Steel	460	790
	6~9	Low Alloy Steel	390	720
	10~11	High Alloy Steel	230	490
M	12~13	Ferritic & Martensitic	390	660
	14	Austenitic Stainless Steel	460	820
K	15~16	Grey Cast Iron	460	720
	17~18	Nodular Cast Iron	490	790

Drilling - Inserts

Drilling Inserts (WCMX)

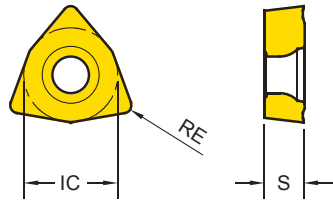

Series	IC	S
WCMX 0402	.250	.094
WCMX 0503	.313	.125
WCMX 06T3	.375	.156
WCMX 0804	.500	.187

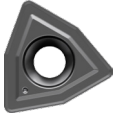
WCMX		Designation	Fn (inch/rev.)	YG602
WCMX General 		WCMX 040208	.002~.004	●
		WCMX 050308	.002~.006	●
		WCMX 06T308	.003~.006	●
		WCMX 080412	.003~.006	●

Compatible Screw for WCMX

Insert	Thread	Length	Head Diameter	Head Angle	Torx Screw
WCMX 06	M3.5	.291	.189	60	Torx Plus 15
WCMX 08	M4	.370	.220	60	Torx Plus 15

Cutting Speed			Vc (ft/min.)	
ISO	VDI	Sub Group	YG602	
			Min.	Max.
P	1~5	Non Alloy Steel	460	790
	6~9	Low Alloy Steel	390	720
	10~11	High Alloy Steel	230	490
M	12~13	Ferritic & Martensitic	390	660
	14	Austenitic Stainless Steel	460	820
K	15~16	Grey Cast Iron	460	720
	17~18	Nodular Cast Iron	490	790



TECHNICAL INFORMATION



Technical Information - Comparison Chart

Comparison Chart - Turning Grades

ISO	YG	Sandvik	Iscar	Kenna metal	Seco	Walter	Mitsu bishi	Kyocera	Tungaloy	Sumi tomo	Taegutec	Korloy	Duracarb
P10	YG3010	GC4305	IC8005	KCP05	TP0501	WPP01	UE6105	CA5505	T9105 T9115	AC8015P	TT8115	NC3010	DC9015
		GC4205	IC428	KC9105	TP0500	WPP05S	MC6015	CA510		AC810P		NC3215	
		GC4315	IC8150	KCP10	TP1501	WPP10S	UE6110	CA515					
		GC4215	IC9015	KC9110	TP1500			CA5515					
P20	YG3020 YG801	GC4325	IC8250	KCP25	TP2501	WPP20S	MC6025	CA525	T9125	AC8025P	TT8125	NC3220	DC9025
		GC4225	IC9015	KC9125	TP2500		UE6020	CA5525		AC820P		NC3225 NC3120	
P30	YG801 YG3030	GC4335	IC8350	KCP30	TP3501	WPP30S	MC6035	CA530	T9135	AC8035P	TT5100 TT8135	NC3030	DC9025
		GC4235	IC8025	KC9140	TP3500		UE6035 VP15TF	CA5535 CR9025		AC830P AC630M		NC5330 PC3545	
M10	YG801	GC2015 GC1105 GC1115	IC807 IC8025 IC907	KCM15 KC5510 KCU10	TS2000	WSM10S	US7020 US905 VP05RT VP10RT	CA6515 PR915 PR1025 PR1215	T6120	AC610M AC6020M AC510U	TT9215 TT5080	NC9020 PC8110	DC610
M20	YG801	GC2025 GC1115	IC808 IC8080 IC908	KCM25 KC5525 KCU25 KC5020	TT2501 TP2000 TM2000 TS2500	WMP20S WSM20S WSM21	US7020 VP20MF UP20M	CA6525 PR915 PR1125 PR1225	T6130	AC6020M AC6030M AC520U	TT9225 TT9080	PC5300 PC8115	
M30	YG3030	GC2035	IC830 IC928	KCM35 KC9240	TP3500 TM4000	WSM30S	UC735 VP15TF VP20MF	PR1125 PR1535	T6130	AC6030M AC6040M AC630M AC530U	TT9235 TT8020	NC9025 PC9030	DC8035
K05	YG1001	GC3205	IC5005	KCK05	TK1001 TK1000	WKK10S	MC5005 UC5105	CA4505 CA4010	T5105	AC405K	TT7005	NC6205	DC820 DC610
K10	YG1001	GC3210	IC5010 IC5100	KCK15	TK1001 TK1000	WKK10S	MC5015 UC5115	CA4515 CA4115	T515	AC415K	TT7310 TT7015	NC6210	
K15	YG3010	GC3215	IC8150	KCK20	TK2001 TK2000	WKK20S WKP30S	UE6110 VP15TF	CA4120	T5125	AC420K	TT6300	NC6215	

Technical Information - Comparison Chart

Comparison Chart - Turning Chipbreakers

Negative Inserts

Material	YG	Sandvik	Iscar	Kenna metal	Seco	Walter	Mitsubishi	Kyocera	Tungaloy	Sumitomo	Taegutec	Korloy	Duracarb
STEEL	UF	PF	F3P NF	FF FN	F1 MF2	FP5	FH LP	GP PP	TF	FL SP	FG FA	VF HU	41
	UL		PP NF			FP5	FY SY	CQ VF	TSF	LU	FC FT	HC	43
	UM		TF	MN	M3	MP3	MP	HS	TM	GU UX	MC PC	VM GM	46
	UG	PM	GN M3P	MN	M3 MR3	MP5	MP,MA	PS	TM	UG	MT PC	GR HR	45
	UC	PR	NR	MP RP	MR4	RP5	Standard	Standard	TH	UZ	MG-	B25	53
	UR	PR	NR R3P	UN RN MG-	MR3 MR6	RP7	RP MH RK	PT PH	THS	ME MU	RT	GR	
STAINLESS STEEL	MM	MM	M3M	MG-MP	MR3	NM4	MM	MS	SM	GU	EM ET	GS	42
CAST IRON	UC	PR	NR	MP RP	MR4	MK5	Standard	Standard	All Round	UZ	MG-	B25	53
	UR	PR	NR R3P	UN RN MG-	MR3 MR6	RK5 RK7	RP MH RK	PT PH	CH	ME MU	RT	GR	
	..MA			RP	MR7	..MA	MG-	C	CH	GZ	..MA		53

Positive Inserts

Material	YG	Sandvik	Iscar	Kenna metal	Seco	Walter	Mitsubishi	Kyocera	Tungaloy	Sumitomo	Taegutec	Korloy	Duracarb
STEEL	UF	PF	PF	LF UF	MF2	PF2 FP4	FM LM LP	GQ PP	01 PSF	FP	FG	HFP	41
	UG	PM		MF	MF3	MP4 FP6	MP Standard MM MV	HQ	PS PM	MU	MT	C25	51
STAINLESS STEEL	UF	PF	PF	LF	MF2	MM4 PS5	FM LM LP	GQ PP	PM	FP	FG	HFP	41
CAST IRON	UG	PM		UF	MF3	MK4 RK4	MP Standard MM MV	HQ	CM	MU	MT	C25	51
ALUMINUM	AL		AS	MF	AL	PF2 PM2	AZ	CF CK	AL	AG	FL	AK	AU

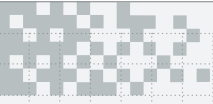

HIGH QUALITY PRODUCTS and ON TIME DELIVERY for WORLD-WIDE CUSTOMERS

Since 1982, YG-1 has been committed to quality, innovation and the unique customer experience. Our performance and experience have granted YG-1 the global impression of one of the leading manufacturers of high quality cutting tool solutions. This global footprint expands over 75 countries, with international logistic centers, pledging to our customers to give the best service available today - and tomorrow.

EUROPE

 BELGIUM	 FINLAND	 ITALY	 PORTUGAL	 SLOVENIA	 THE NETHERLANDS
 CROATIA	 FRANCE	 LITHUANIA	 ROMANIA	 SPAIN	 TURKEY
 CZECH REPUBLIC	 GERMANY	 NORWAY	 RUSSIA	 SWEDEN	 UNITED KINGDOM
 DENMARK	 HUNGARY	 POLAND	 SERBIA	 SWISS	

ASIA PACIFIC

 AUSTRALIA	 INDONESIA	 KINGDOM OF SAUDI ARABIA	 SINGAPORE	 UNITED ARAB EMIRATES
 CHINA	 IRAN	 MALAYSIA	 SOUTH KOREA	 VIETNAM
 HONG KONG	 ISRAEL	 PAKISTAN	 TAIWAN	
 INDIA	 JAPAN	 PHILIPPINES	 THAILAND	

AMERICAS

 BRAZIL	 CANADA	 COLOMBIA	 MEXICO	 UNITED STATES
--	--	--	--	---

AFRICA

 EGYPT	 SOUTH AFRICA
---	--



COMPLETE METALWORKING SOLUTIONS

(800) 991-4225

www.ahbinc.com

ISO Certified

customerservice@ahbinc.com

YG-1 CO., LTD.

YG-1 USA

730 Corporate Woods Parkway, Vernon Hills, IL 60061 U.S.A.

Technical Assistance : 888-868-5988

HEAD OFFICE

211, Sewolcheon-ro, Bupyeong-gu, Incheon, South Korea

Phone : +82-32-526-0909

E-mail : yg1@yg1.kr

www.yg1.kr

The new address above has currently been updated to the new Korean postal standard valid since 2014.



Notice that the physical Head Office location did NOT change.



Search 'YG-1' on social media outlets

YG1YUUL180420001

Tool specifications are subject to change without prior notice.