

YU-IT20
AMERICA
2020/2021



CUTTING TOOLS



COMPLETE METALWORKING SOLUTIONS
(800) 991-4225 www.ahbinc.com
ISO Certified customerservice@ahbinc.com

INDEXABLE INSERTS

YG-1 CO., LTD.

Contents		Page	
Turning	External Turning Holder Code	4	
	Insert ISO Code System	6	
	Grade Naming System	8	
	Turning Grades Map	9	
	Turning Grades	10	
	Turning Chipbreakers	12	
	Application Guide	Steel Guide	15
		Formulas	20
		Surface Roughness Guide	21
		Trouble Shooting	22
	External Holders Overview		25
		Product	External Holders
Inserts Overview		31	
	Product	Negative Inserts	32
		Positive Inserts	50
Parting & Grooving	Overview	58	
	Product	Parting & Grooving Inserts	59
Milling	Milling Cutter Code Keys	61	
	Insert ISO Code System	62	
	Milling Cutter Overview	64	
	Milling Inserts Overview	65	
	Milling Grades and Chipbreakers	66	
	Product	Face Milling Cutters	68
		Face Milling Inserts	70
		Shoulder Milling Cutters	82
		Shoulder Milling Inserts	84
		Profiling Cutters	90
Profiling Inserts		91	
	High Feed Milling Inserts	95	
Drilling	Drilling Overview	97	
	Product	Drilling Inserts	98
Technical Information	ISO 13399 Terms	101	
	Hardness Conversion Table	102	
	Material Groups	103	
	Comparison Chart - Turning	120	
	Comparison Chart - Milling	122	
	ISO ↔ ANSI	123	
	Search	124	

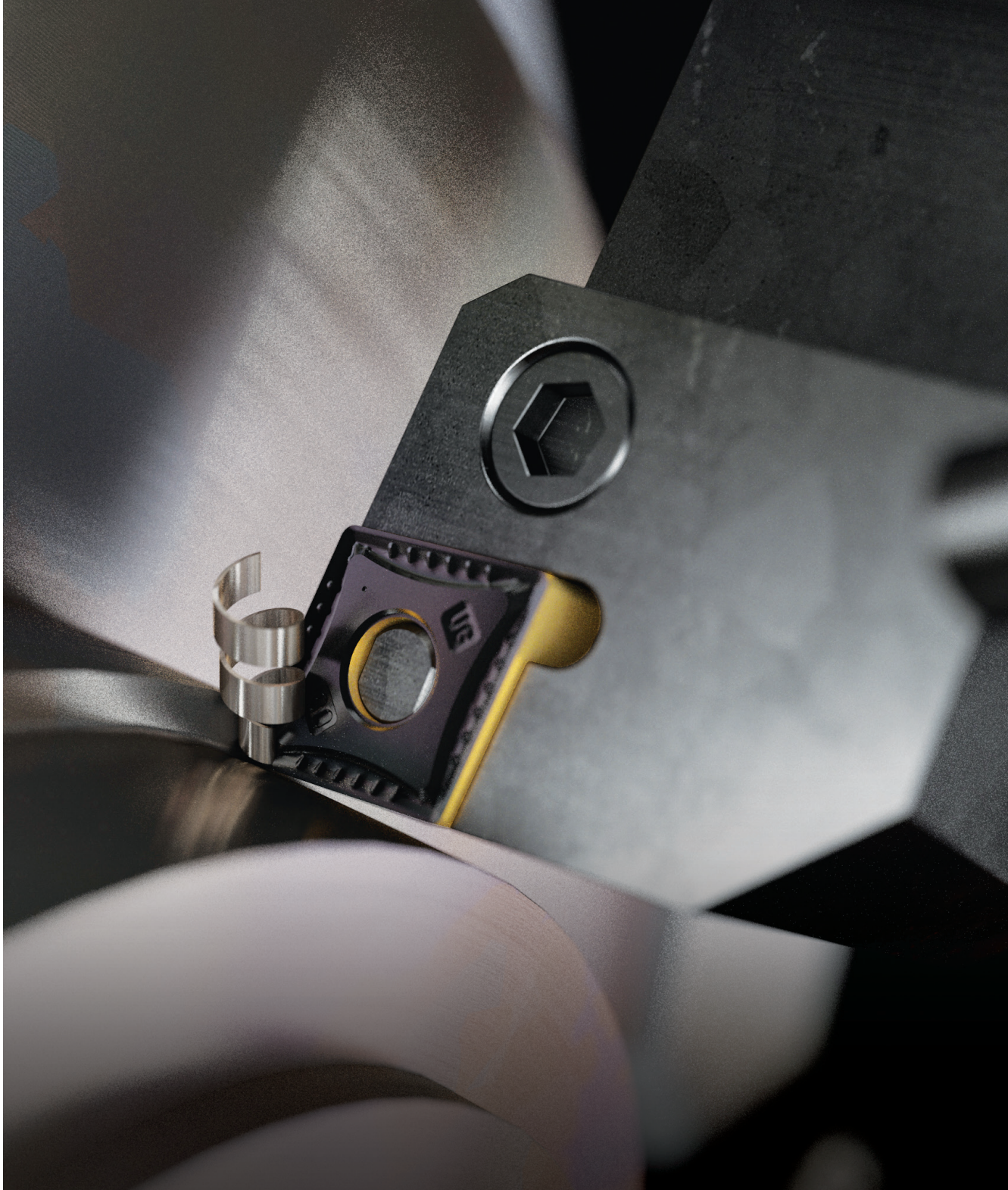

ISO TURNING

Product Overview

Application Guide

Turning Holders Overview

Turning Holders

Turning Inserts Overview

Turning Inserts

Turning - Name Code System

External Turning Holder Code (Inch)

*Inch

1	2	3	4	5	6	7	8
M	C	L	N	R	12	4	B
Clamping System	Insert Shape (1st Letter of Insert)	Tool Style	Insert Clearance (2nd Letter of Insert)	Tool Hand	Shank Width(B) & Height(H)	Insert Size	Length (LF)

1 - Clamping System

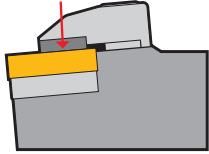
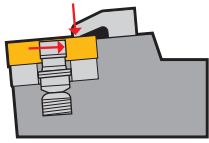
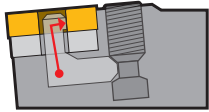
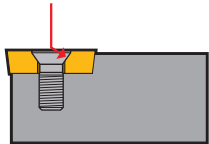
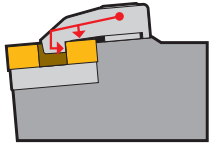



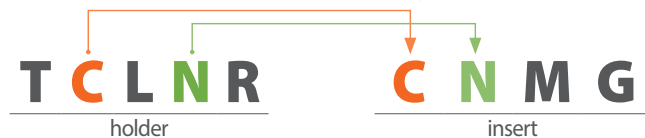

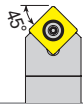

Symbol	System
C	 <p>Top Clamp (No Clamping Hole Insert)</p>
M	 <p>Pin & Top Clamp (Straight Clamping Hole Insert)</p>
P	 <p>Lever Lock (Straight Clamping Hole Insert)</p>
S	 <p>Screw (Screw Clamping Hole Insert)</p>
D (T)	 <p>Hole Clamp (Straight Clamping Hole Insert)</p>

2, 4 — Insert Compatibility *

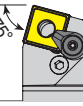
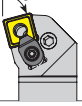

* Related to Insert Designation to check compatibility

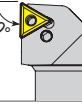
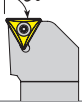
3 - Tool Style

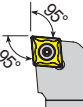
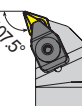
Approach Angle (KAPR)	Side Direction		End Direction
	Straight Shank	Offset Shank	
45°	D 	S 	
60°		T 	
63°	N 		
72.5°	V 		
75°	B 		K 
90°	A 	G 	F 
93°		J 	U
95°		L (Both Direction) 	
107.5°		H 	



Turning - Name Code System

External Turning Holder Code (Inch)

*Inch

1	2	3	4	5	6	7	8
M	W	L	N	R	16	3	D
Clamping System	Insert Shape (1st Letter of Insert)	Tool Style	Insert Clearance (2nd Letter of Insert)	Tool Hand	Shank Width(B) & Height(H)	Insert Size	Length (LF)

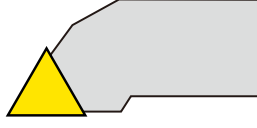
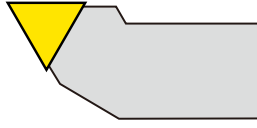
5 - Hand Direction

Symbol	Hand Direction
R	Right Hand 
L	Left Hand 
N	Neutral 

6 - Shank Height (H) Shank Width (B)

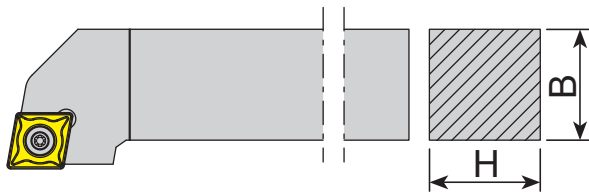

Number	Hight (H)	Width (B)	Number	Hight (H)	Width (B)
10	.625	.625	06	.375	.375
12	.75	.75	05	.3125	.3125
16	1.00	1.00	64	.75	1.00
20	1.25	1.25	66	1.75	1.50
24	1.50	1.50	85	1.00	1.25
32	2.00	2.00	86	1.00	1.50
08	.50	.50	91	1.25	1.50

7 - Insert Size *

Examples	is Compatible with...
MCLNR 12 4B	CNMG432
MTJNR 16 3B	TNMG331

* Related to Insert Designation to check compatibility

8 - Length (LF)

Symbol	Length (Inch)	Symbol	Length (Inch)
A	4.000	M	4.000
B	4.500	N	4.500
C	5.000	P	5.000
D	6.000	R	6.000
E	7.000	S	7.000
F	8.000	T	8.000
G	5.500	U	5.500
H	5.625	V	3.500
J	5.300	W	3.500
K	14.000	Y	3.750
L	6.800	X	Special

Insert ISO Code System

*Metric : According to ISO 1832

page 12

page 10

1	2	3	4	5	6	7	8	9
C	N	M	G	12	04	08	-UG	YG3020
Shape	Clearance	Tolerance	Clamping & Chipbreaker	Insert Size	Insert Thickness	Corner Radius	Chipbreaker Geometry	Grade

1 - Shape

Symbol	Shape	
H	Hexagonal	
O	Octagonal	
P	Pentagonal	
S	Square	
T	Triangular	
C	Rhombic 80°	
D	Rhombic 55°	
V	Rhombic 35°	
W	Trigon	
L	Rectangular	
K	Parallelogram 55°	
R	Round	

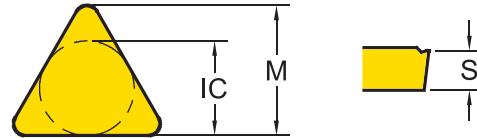

3 - Tolerance Class

Symbol	Inner Circle IC (inch)	Nose Height M (inch)	Thickness S (inch)
C	±.0010	±.0005	±.0010
E	±.001	±.0010	±.001
G	±.001	±.0010	±.005
H	±.0005	±.0005	±.0010
K*	±.002~.006*	±.0005	±.005
M*	±.002~.006*	±.003~.010*	±.005
U*	±.003~.010*	±.005~.015*	±.005

* Tolerance is different by insert IC size. Please see ISO 1832

4 - Clamping & Chipbreaker

Symbol	Clamping	Chipbreaker	Figure
N	No clamping hole	X	
R		One Face	
A	Cylindrical Clamping hole	X	
M		One Face	
G		Both Faces	
W	Screw Hole	X	
T		One Face	
U		Both Faces	
X		Special	

2 - Relief Angle (AN)

Symbol	Relief Angle (AN)	
N	No Relief Angle	
B	Relief 5°	
C	Relief 7°	
P	Relief 11°	
D	Relief 15°	
E	Relief 20°	
F	Relief 25°	
O	Special	

Insert ISO Code System

*Inch

page 12

page 10

1	2	3	4	5	6	7	8	9
C	N	M	G	4	3	2	-UG	YG3020
Shape	Clearance	Tolerance	Clamping & Chipbreaker	Insert Size	Insert Thickness	Corner Radius	Chipbreaker Geometry	Grade

5 - Insert Size

Metric							Inner Circle IC (inch)	Inch
S	T	C	D	V	W	R		
06	11	06	07	11			1/4	2
07							5/16	2.5
09	16	09	11	16	06	09 (00)	3/8	3
12	22	12	15	22	08	12 (00)	1/2	4
15		16					5/8	5
19		19					3/4	6
25		25					1	8
						06 (M0)	.236	
						08 (M0)	.315	
						10 (M0)	.394	
						12 (M0)	.472	
						16 (M0)	.630	

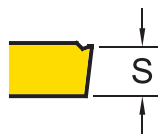

6 - Insert Thickness (S)

Metric	Thickness - S (inch)	Inch
T1	5/64	1.2
02	3/32	1.5
03	1/8	2
T3	5/32	2.5
04	3/16	3
05	7/32	3.5
06	1/4	4
07	5/16	5
09	3/8	6

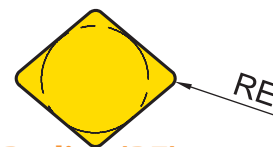

7 - Corner Radius (RE)

Metric	Corner Radius - RE (inch)	Inch
01	.004	0
02	.008	0.5
04	1/64	1
08	1/32	2
12	3/64	3
16	1/16	4
20	5/64	5
24	3/32	6

Grade Naming System

1	2	3	4	5	(6)
YG	3	0	2	0	(G)
YG Brand	Workpiece Material	Grade Version	Application Range (1st Digit)	Application Range (2nd Digit)	Minor Variation
Carbide CVD (4 Digits)	●	●	●	●	YG3020
Carbide PVD (3 Digits)	●	●	●		YG211
Carbide Uncoated (2 Digits)	●	●			YG10

1 - YG Brand

2 - Workpiece Material

Symbol	Workpiece Material	Turning	Milling	Drilling	Parting
1	K Cast Iron or N Non-Ferrous	●			
2	M Stainless Steel	●			
3	P Steel	●			
4	S Superalloys	●			
5	K Cast Iron or N Non-Ferrous		●	●	●
6	M Stainless Steel or Universal		●	●	●
7	P Steel		●	●	●
8	Universal	●			

3 — Grade Version

4 & 5 — Application Range

Symbol	
05	<p>Wear Resistant Grade Stable Application Continuous Cut Finishing</p>
10	
15	
20	<p>Balanced Grade High Versatility General Application</p>
25	
30	
35	<p>Tougher Grade Unstable Application Interrupted Cut Chipping Resistance Roughing</p>
40	
45	

(6) — (Minor Variation)

G — Gold Coated Version

Product Overview

Turning Grades Map

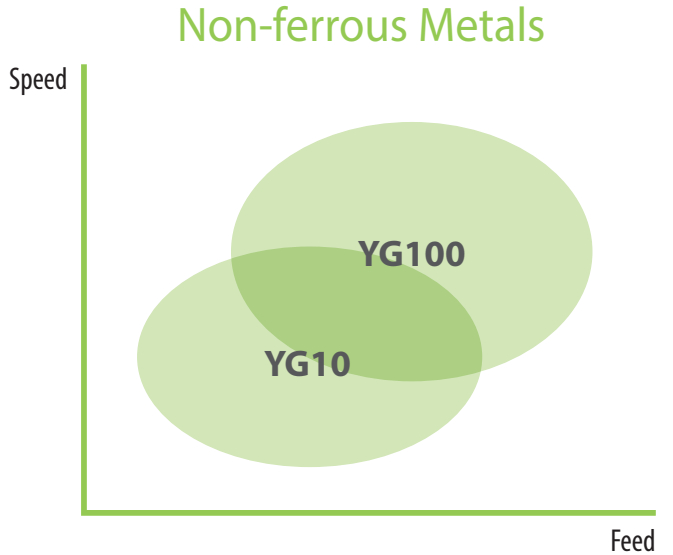
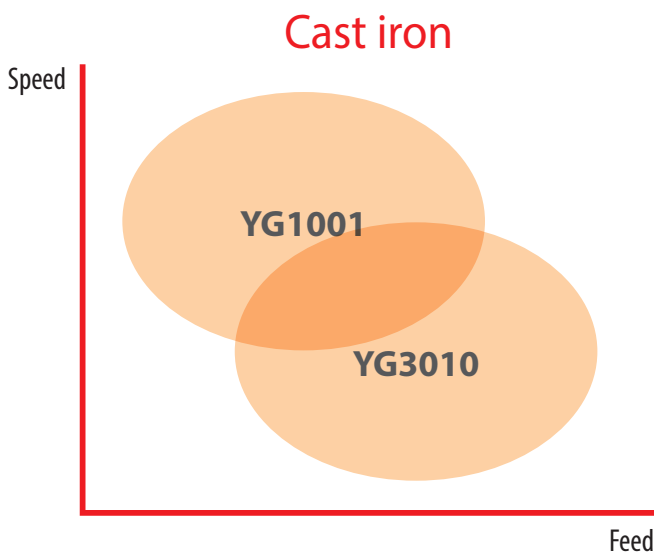
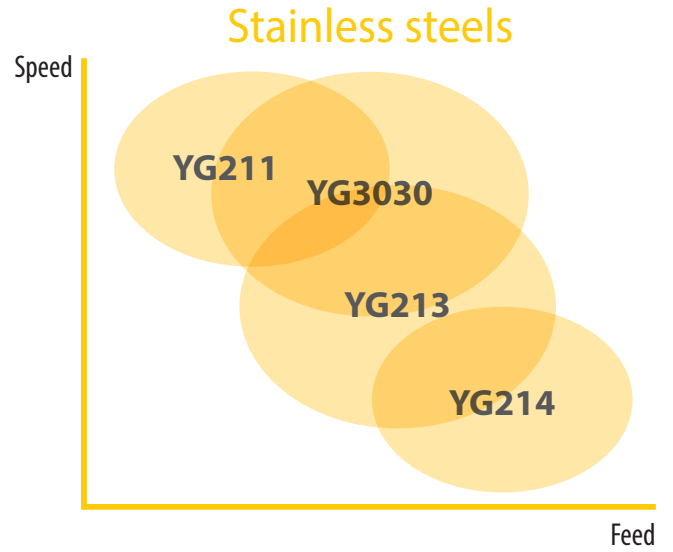
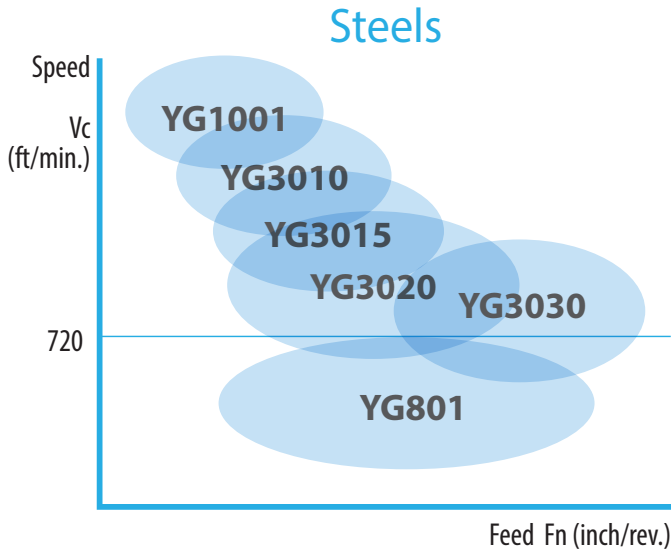

Product Overview

Turning Grades

Turning Grades	P Steel				M Stainless steel			K Cast iron			N Non-ferrous		S Superalloys	
	P10	P20	P30	P40	M10	M20	M30	K10	K20	K30	N10	N20	S10	S20
CVD	YG1001	1001						1001						
	YG3010	3010						3010						
	YG3015	3015												
	YG3020	3020			3030									
	YG3030	3030												
PVD	YG801	801												
	YG211				211								211	
	YG213					213							213	
	YG214						214							214
DLC	YG100										100			
-	YG10										10			

YG1001

P01 - P10

K10 - K25

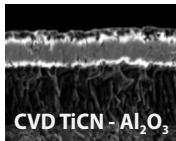

First choice for stable machining of Cast iron

- Substrate especially designed for high wear resistance
- Thick Al₂O₃ layer ensures good wear resistance at high cutting speeds including dry machining

YG3010

P05 - P20

K15 - K35

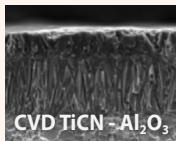

First choice for Finishing Steels, and Ductile Cast iron

- Finishing and light machining of steel under in stable condition
- New Al₂O₃ coating technology and excellent surface smoothness increase wear resistance and chipping resistance

YG3015

P10 - P25

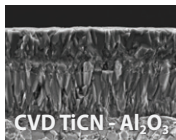

Balanced productivity for Continuous cut

- High wear resistance and improved toughness ensures high productivity with less trouble

YG3020

P15 - P30

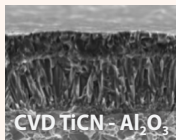

First Choice grade for general Steel application

- Substrate especially designed for good toughness
- Excellent surface smoothness increases wear resistance and reliability

YG3030

P20 - P35

M10 - M30

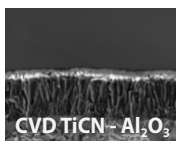

Interrupted cut of Steel and Stainless steel

- Heavy interrupted cut for Steel
- High cutting speed for Stainless steel

Product Overview

Turning Grades

<p>YG801</p> <p>P10 - P30</p>	 <p>PVD - TiAIN</p>	<p>for Carbon Steel with Low cutting speed</p> <ul style="list-style-type: none"> • Recommended for mild steel and boring application • Substrate and special PVD coating for excellent wear resistance
<p>YG211</p> <p>M05 - M25</p> <p>S05 - S20</p>	 <p>PVD - TiAIN</p>	<p>High wear resistance grade for Super alloys and Stainless steel</p> <ul style="list-style-type: none"> • Finishing Stainless steel
<p>YG213</p> <p>M20 - M35</p> <p>S15 - S25</p>	 <p>PVD - TiAIN</p>	<p>First Choice Grade on low cutting speed of Stainless steel</p> <ul style="list-style-type: none"> • First choice on Stainless steel for Low cutting speed • For Medium to low cutting speed
<p>YG214</p> <p>M30 - M40</p> <p>S25 - S30</p>	 <p>PVD - TiAIN</p>	<p>Heavy Interrupted cut for Stainless steel</p> <ul style="list-style-type: none"> • For Heavy Interrupted cut on Stainless steel • Minimize risk of Mechanical fracture or Chipping
<p>YG100</p> <p>N05 - N25</p>	 <p>DLC</p>	<p>First Choice grade for aluminum with DLC coating</p> <ul style="list-style-type: none"> • Submicron carbide for high wear resistance • DLC coating minimizes Built Up Edge tendency. • Improve tool life in sticky non-ferrous alloy
<p>YG10</p> <p>N05 - N25</p>	 <p>Uncoated</p>	<p>Uncoated Grade for General Aluminum</p> <ul style="list-style-type: none"> • Substrate consisted of submicron carbide for high wear resistance • Shining surface to prevent built up edge

Turning Chipbreakers - Negative

	P	M	K	N	S			Feed									
								0	.004	.008	.012	.016	.020	.024			
TURNING PARTING & GROOVING MILLING DRILLING TECHNICAL INFORMATION	P						UF	Finishing		Fn .002~.010	Ap .02~.10						
	P						UL	Semi Finishing and sticky materials		Fn .004~.012	Ap .04~.12						
	P						UM	For Medium & Unstable conditions		Fn .006~.012	Ap .04~.12						
	P						UG	First Choice for Medium(Stable application)		Fn .008~.016	Ap .06~.12						
	P		K				UC	Medium Roughing and First choice for Cast iron		Fn .008~.016	Ap .06~.16						
	P		K				UR	Roughing and Heavy interrupted cut		Fn .012~.020	Ap .08~.20						
			K				..MA	Cast iron Heavy Roughing		Fn .006~.020	Ap .04~.20						
								0	.04	.08	.12	.16	.20	.24			
								Depth of Cut							Ap (inch)		

Product Overview

Turning Chipbreakers - Negative

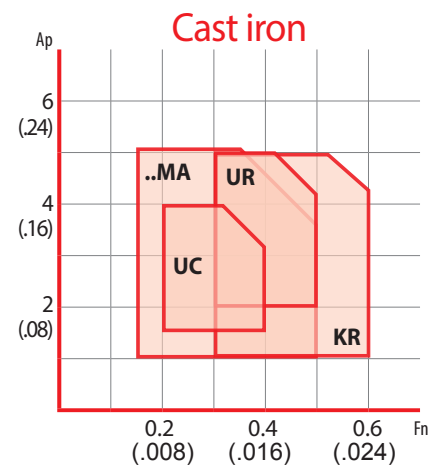
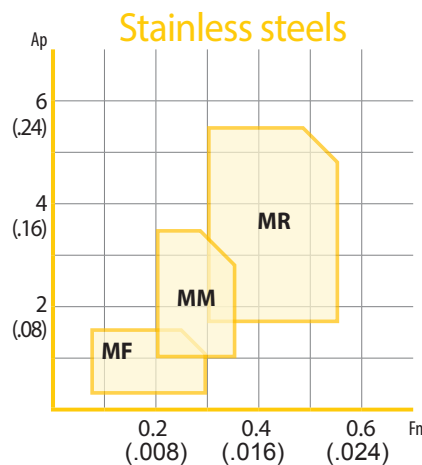
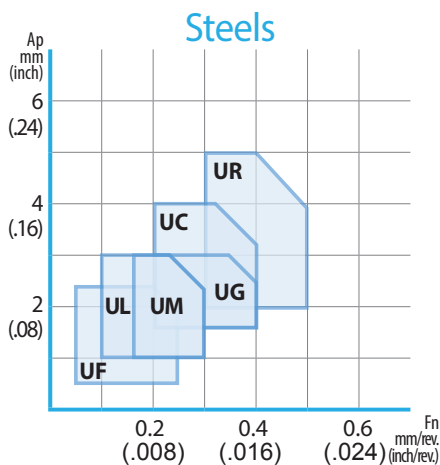
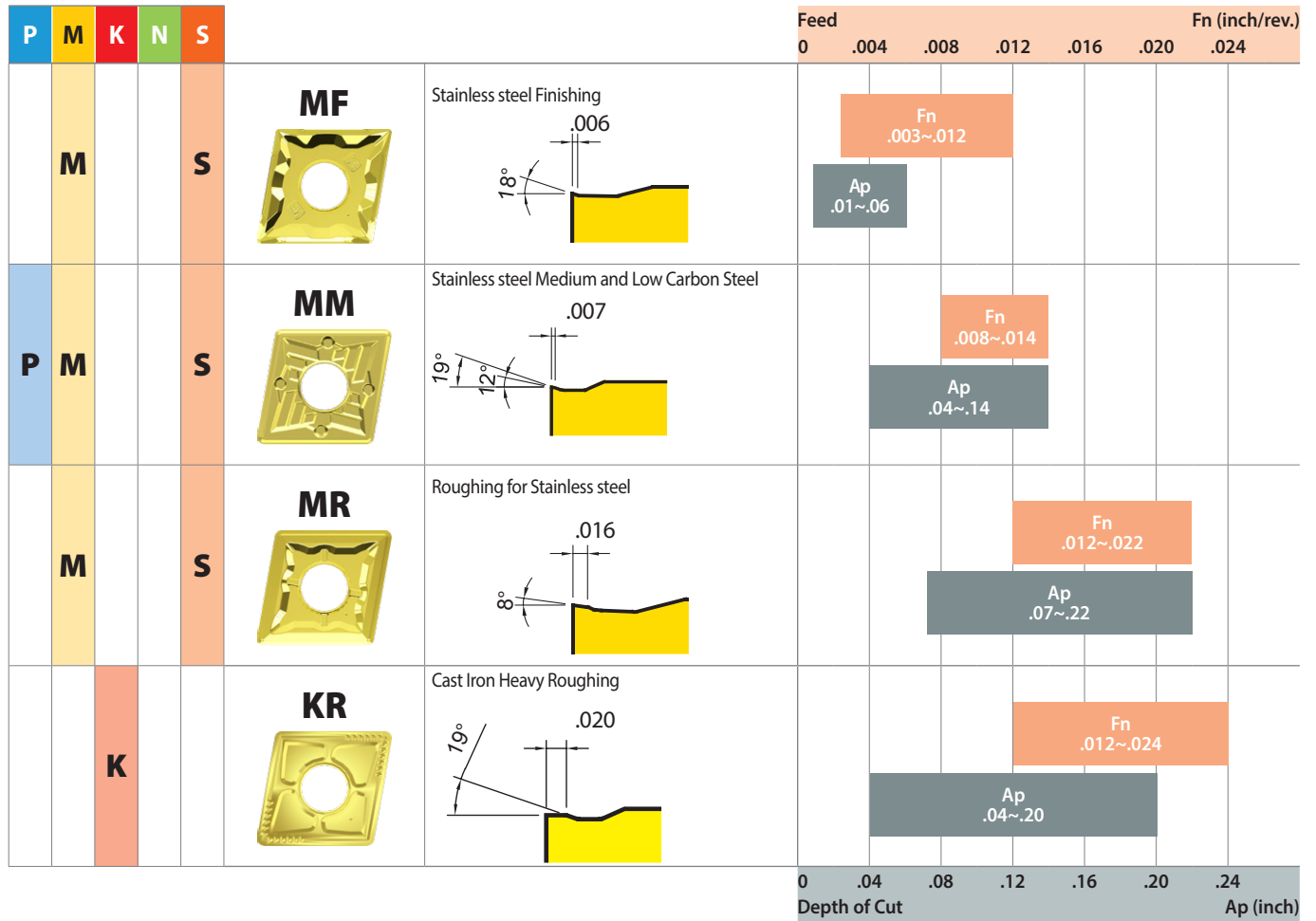

Turning Chipbreakers - Positive

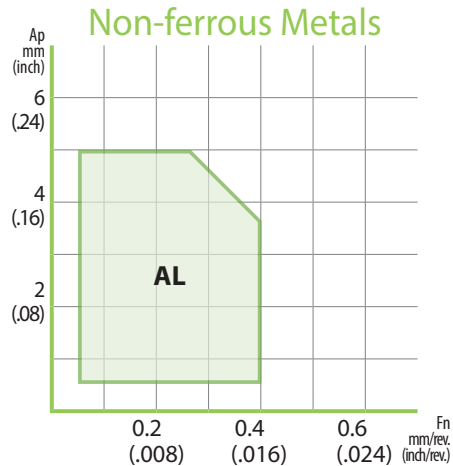
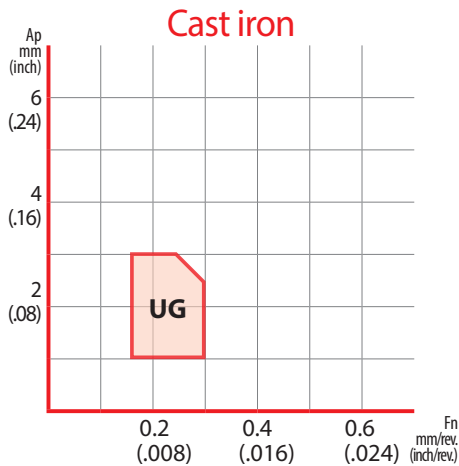
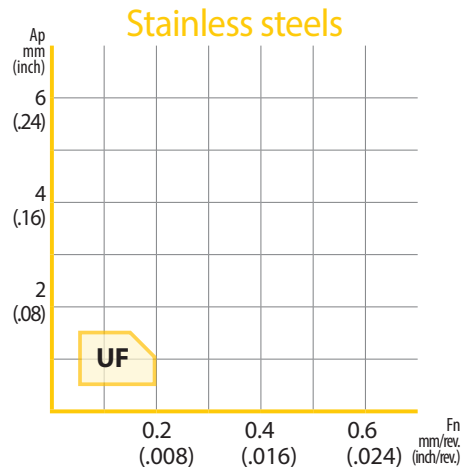
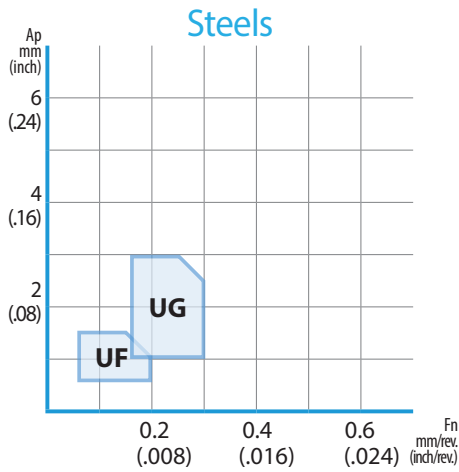
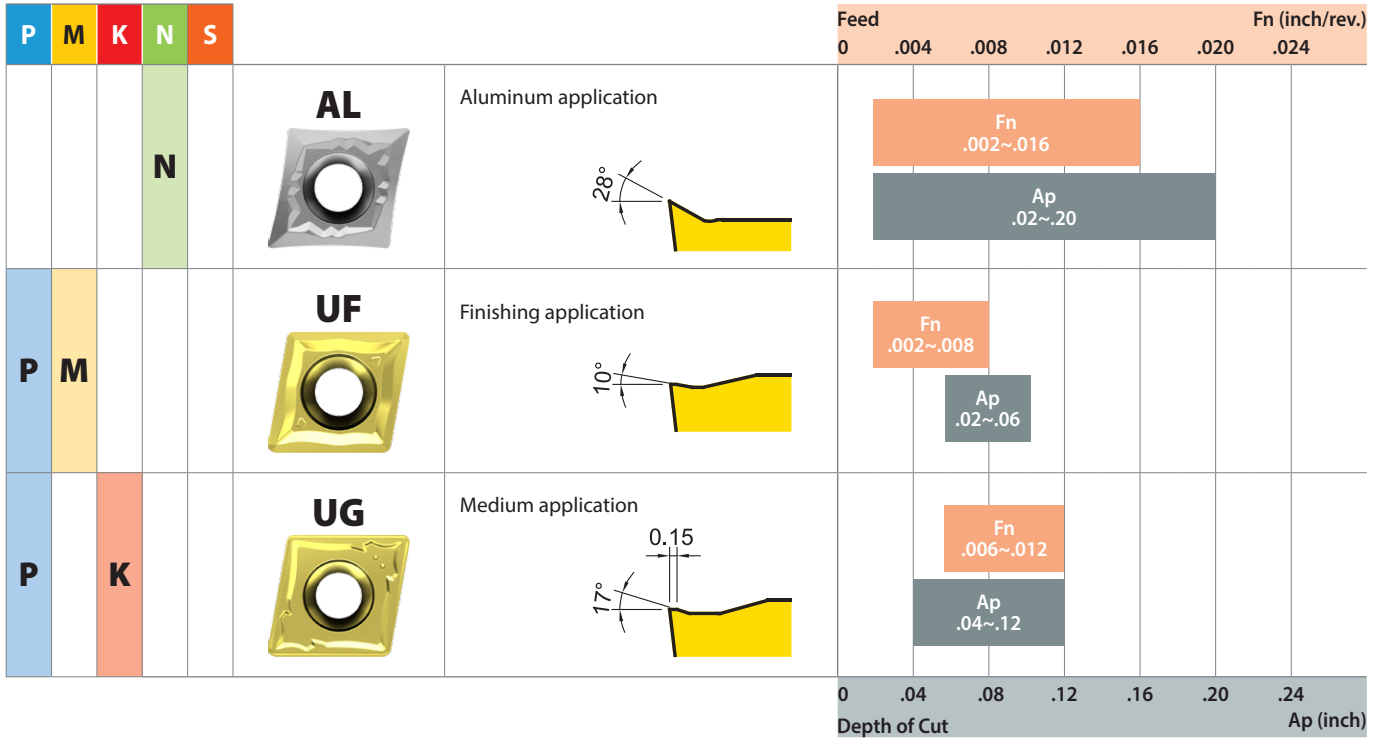

Application Guide

Steel Guide

Grade Recommendation based on Workpiece Material Condition

HARD

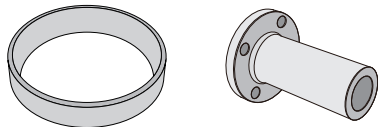

Pre Machined Condition

No Outer Skin
Uniform hardness on material
Has stable machining condition

YG3010

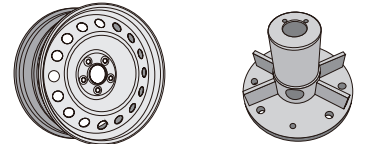

Welded Condition

Soft / No Outer Skin
Weld Bead Could be of Different Hardness than Actual Part
Stock on Part could even except weld Seam during Machining causing shock loads

YG3020

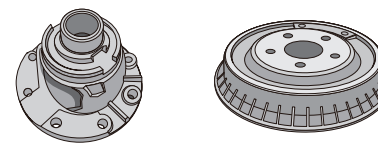

Cast Condition

Hard Outer Skin
Could have Sand Inclusion, - if Green Sand Cast
Component could have uneven Stock during machining

YG3030

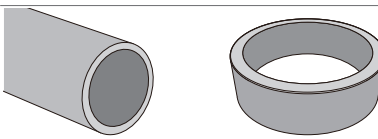

Hot Rolled Condition

Soft / No Outer Skin
Usually heat treated before machine to reduce Hardness
Component could have uneven Stock During Machining

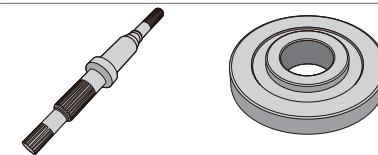

Forged Condition

Soft Outer Skin
Usually heat treated before machine to reduce Hardness
Component could have uneven Stock during machining

TOUGH

Chipbreaker, Feed Rate and Depth of Cut

Sharp Edge General Strong Edge

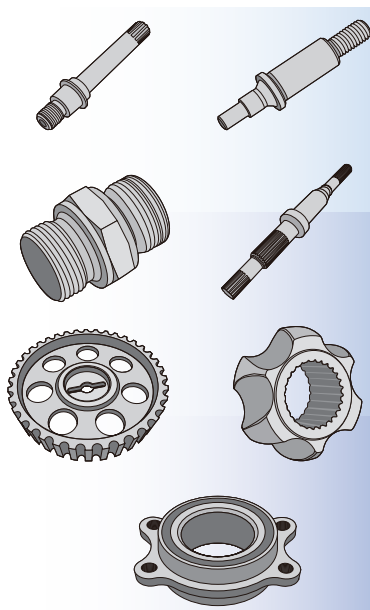

Continuous

General

Heavy Interrupt

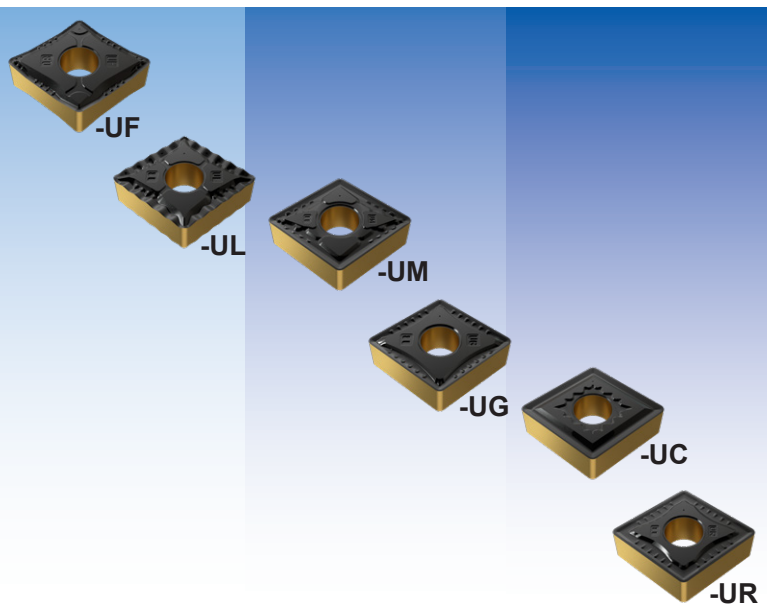

TURNING

PARTING & GROOVING

MILLING

DRILLING

TECHNICAL INFORMATION

Application Guide

Steel Guide

TURNING

PARTING & GROOVING

MILLING

DRILLING

TECHNICAL INFORMATION

Non Alloy Steel, About 0.15% C (Low Carbon Steel)											
P	VDI	JIS	DIN	Mat'l No.	AISI/ASTM	SS	AFNOR	UNI	UNE	BS	GOST
1	S15C	CK15	1.0401	1015	1350	XC18	C15	F.1110	080M15	15	

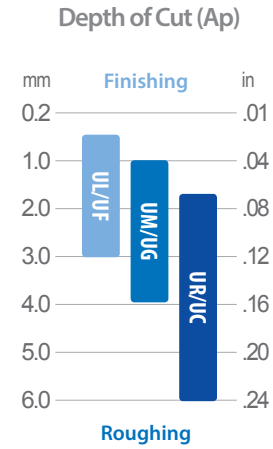
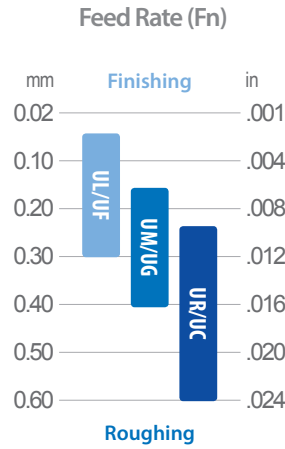
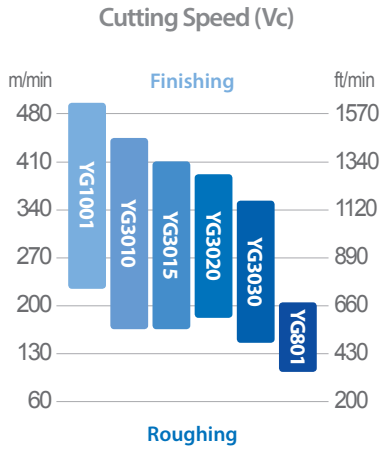

First Choice Grade and Value
 YG3010 - Vc 330m/min (1,080ft/min)
 YG801 - Vc 170m/min (560ft/min)

Non Alloy Steel, About 0.45% C (Medium Carbon Steel)											
P	VDI	JIS	DIN	Mat'l No.	AISI/ASTM	SS	AFNOR	UNI	UNE	BS	GOST
2-3	S45C	C45	1.0503	1045	1672	XC42H1TS	C45	F.1140	060A47	45	

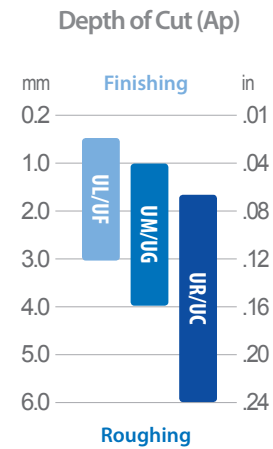
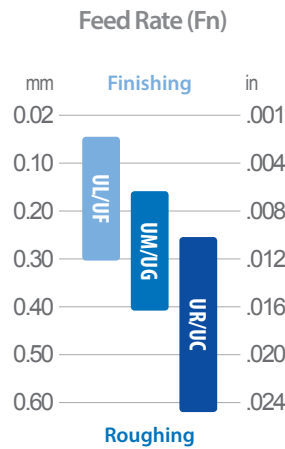
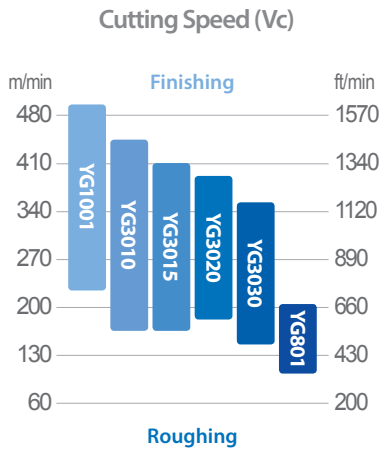

First Choice Grade and Value
 YG3010 - Vc 330m/min (1,080ft/min)
 YG801 - Vc 170m/min (560ft/min)

Application Guide

Steel Guide

Low-alloyed Steel											
P	VDI	JIS	DIN	Mat'l No.	AISI/ASTM	SS	AFNOR	UNI	UNE	BS	GOST
6~9	SCM440	42CrMo4	1.7225	4140	2244	42 CD 4	42CrMo4	F.1252	708M40	38HM	

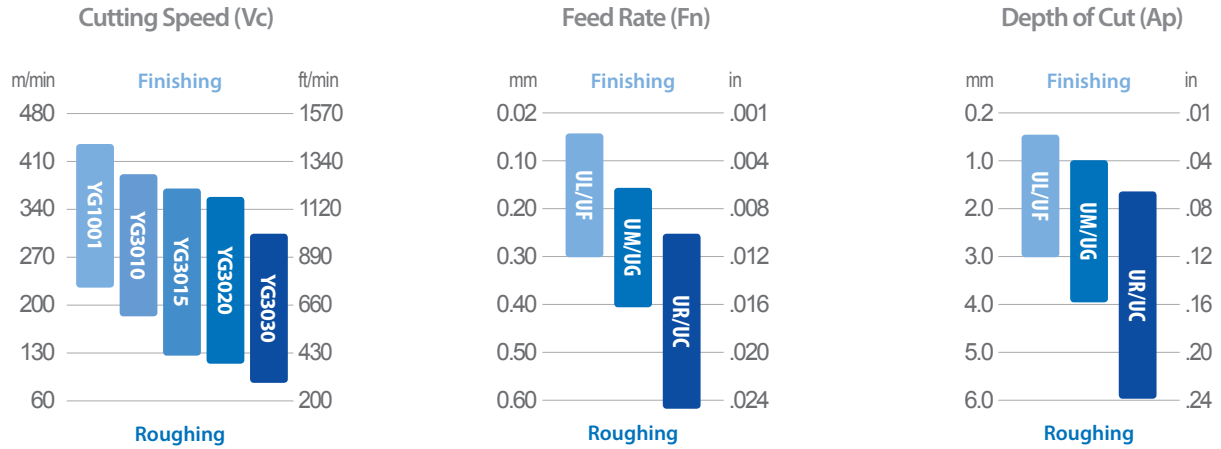

First Choice Grade and Value YG3020 - Vc 240m/min (790ft/min)

High Alloyed Steel, and Tool Steel											
P	VDI	JIS	DIN	Mat'l No.	AISI/ASTM	SS	AFNOR	UNI	UNE	BS	GOST
10~11	SKD11	X155CrVMo121	1.2379	D2	2310	Z160CDV12	X165CrMoW12KU	F.5318	BD2	KH12MF	

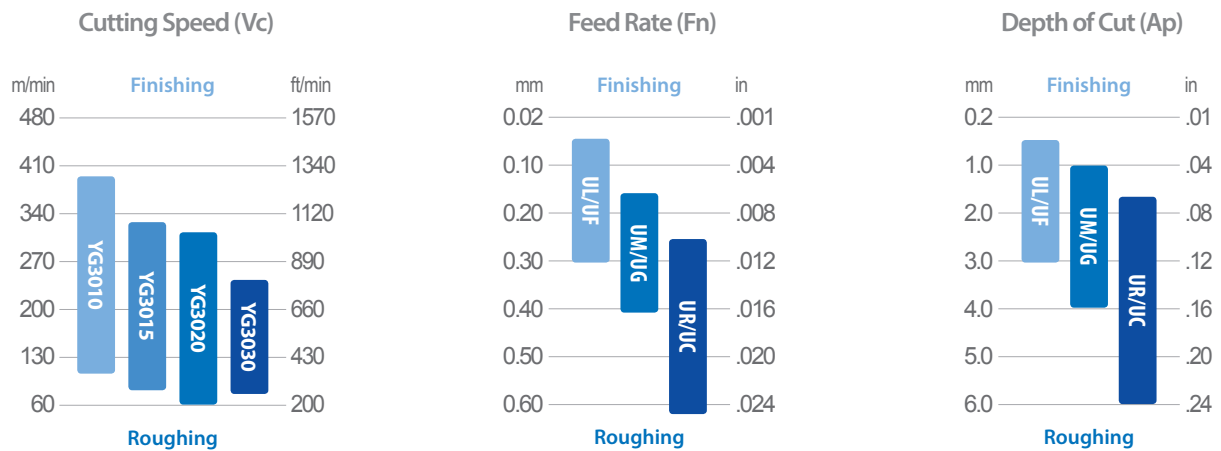

First Choice Grade and Value YG3020 - Vc 230m/min (750ft/min)

Application Guide

Stainless steel Guide

TURNING

PARTING & GROOVING

MILLING

DRILLING

TECHNICAL INFORMATION

M	Ferritic / Martensitic Stainless									
VDI	JIS	DIN	Mat'l No.	AISI/ASTM	SS	AFNOR	UNI	UNE	BS	GOST
12~13	SUS430	X6Cr17	1.4016	430	2320	Z8C17	Z8C17	F.3113	430S15	12C17

Cutting Speed (Vc)

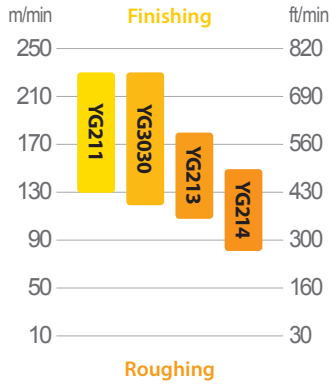

Feed Rate (Fn)



Depth of Cut (Ap)

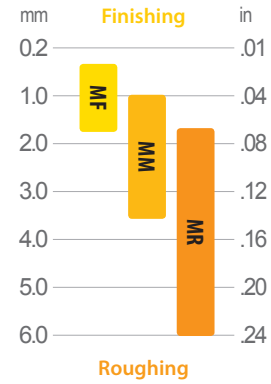

First Choice Grade and Value

Ferritic Stainless steel

YG3030 - Vc 200m/min (660ft/min)
 YG213 - Vc 160m/min (520ft/min)

Martensitic

YG3030 - Vc 160m/min (520ft/min)
 YG213 - Vc 130m/min (430ft/min)

M	Austenitic Stainless steel									
VDI	JIS	DIN	Mat'l No.	AISI/ASTM	SS	AFNOR	UNI	UNE	BS	GOST
14	SUS304	X5CrNi18 9	1.4350	304	2332	Z6CN18 09	X5CrNi18 10	F.3551	304S15	03KH18N11

Cutting Speed (Vc)



Feed Rate (Fn)



Depth of Cut (Ap)

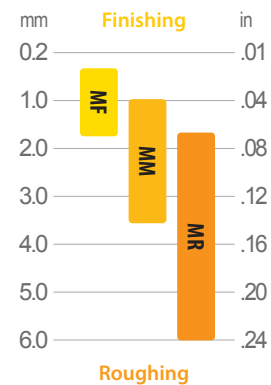

First Choice Grade and Value

YG3030 - Vc 180m/min (590ft/min)
 YG213 - Vc 140m/min (460ft/min)

Application Guide

Cast iron Guide

Grey cast iron											
K	VDI	JIS	DIN	Mat'l No.	AISI/ASTM	SS	AFNOR	UNI	UNE	BS	GOST
	15~16	FC250	GG25	0.6025	A48 40 B	0125	Ft 25 D	G25	FG25	Grade 260	Sc 25

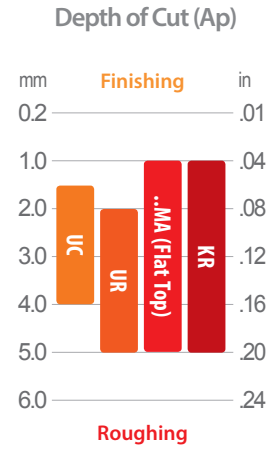
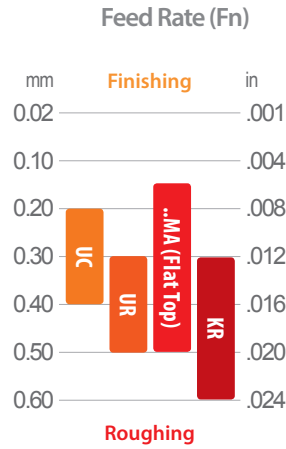
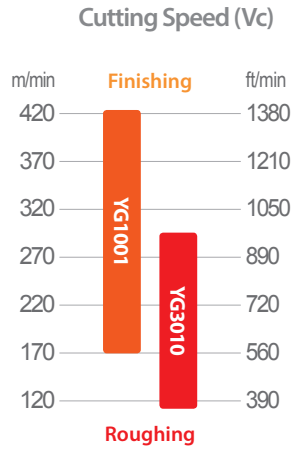

First Choice Grade and Value
 YG1001 - Vc 350m/min (1,150ft/min)

Nodular cast iron											
K	VDI	JIS	DIN	Mat'l No.	AISI/ASTM	SS	AFNOR	UNI	UNE	BS	GOST
	17~18	FCD500	GGG50	0.7050	80-55-06	0.7050	FGS 500-7	GS 500-7	FGE50-7	SNG 500-7	Vc 50-2

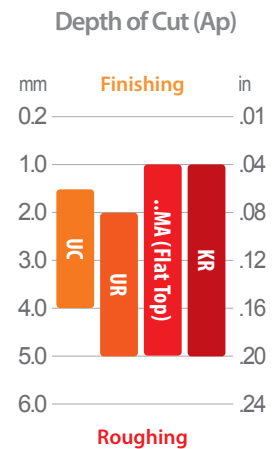
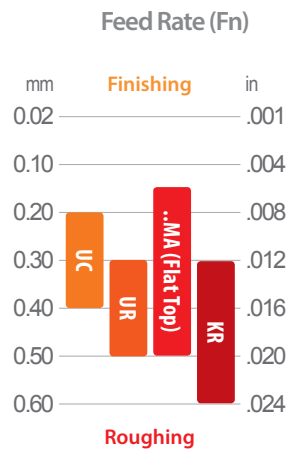
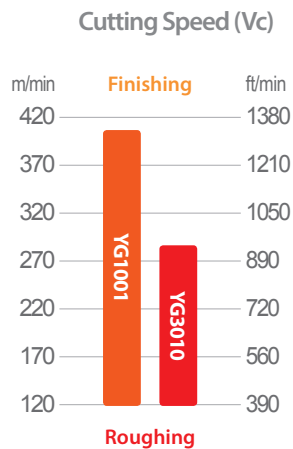

First Choice Grade and Value
 YG3010 - Vc 220m/min (720ft/min)

Application Guide

Turning Formulas

Formulas

Cutting Speed (Vc)

Metric

$$Vc = D \times RPM \times 0.0031 \text{ (m/min.)}$$

Inch

$$Vc = D \times RPM \times .262 \text{ (ft/min.)}$$

Metric Vc to Inch Vc

$$\text{Inch Vc} = \text{Metric Vc} \times 3.28 \text{ (ft/min.)}$$

Inch Vc to Metric Vc

$$\text{Metric Vc} = \text{Inch Vc} \times .305 \text{ (m/min.)}$$

Spindle Speed (RPM)

Metric

$$RPM = Vc \times 318.3 \div D \text{ (rev./min.)}$$

Inch

$$RPM = Vc \times 3.82 \div D \text{ (rev./min.)}$$

Feed Rate (Vf = Table Feed)

$$Vf = Fn \times RPM \text{ (mm/min. or in/min.)}$$

Feed per Revolution (Fn)

$$Fn = Vf \div RPM \text{ (mm/rev. or in/rev.)}$$

Metal Removal Rate (Q)

Metric

$$Q = Vc \times Fn \times Ap \text{ (cm}^3\text{/min.)}$$

Inch

$$Q = Vc \times Fn \times Ap \times 12 \text{ (in}^3\text{/min.)}$$

Cutting Time

$$T = L \div Vf \text{ (min.)}$$

Terms

RPM (n)	Spindle Speed (Revolution per minute)
Vc	Cutting Speed
D	Work Diameter
Vf	Feed Rate (Table Feed)
Fn	Feed per Revolution
Ap	Depth of Cut
Q	Metal Removal Rate
L	Length of cut
T	Cutting Time (min.)

Application Guide

Surface Roughness Guide

Trouble Shooting

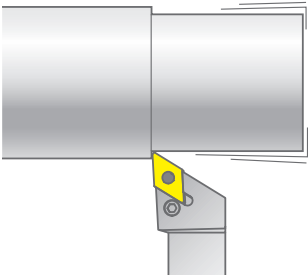
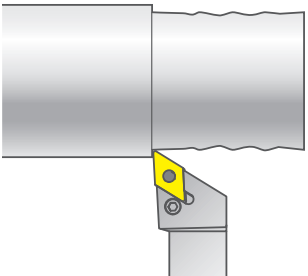
Pattern	Reasons	Solutions
<p>Vibration</p> 	<ul style="list-style-type: none"> - High radial or tangential force - Unstable condition 	<ul style="list-style-type: none"> - Lower depth of cut (ap) - Use sharper chipbreaker - Check stability, and position of tool and workpiece - Reduce the overhang (bigger and shorter tool)
<p>Bad Surface</p> 	<ul style="list-style-type: none"> - Work material is damaged by chips - Feed is too high for corner radius 	<ul style="list-style-type: none"> - Different chipbreaker - Lower depth of cut (ap) - Lower feed - Bigger corner radius

Theoretical Surface Roughness

Ra / Rz μm (μinch)	Insert Corner Radius Code ISO (ANSI)					
	ISO ANSI					
	02 (0)	04 (1)	08 (2)	12 (3)	16 (4)	24 (6)
	Feed Rate mm/rev (inch/rev)					
0.4 / 1.6 (16 / 64)	0.05 (.002)	0.07 (.003)	0.1 (.004)	0.12 (.005)	0.14 (.006)	0.18 (.007)
1.6 / 6.3 (64 / 256)	0.1 (.004)	0.14 (.006)	0.2 (.008)	0.25 (.010)	0.28 (.011)	0.35 (.014)
3.2 / 12.5 (128 / 512)	0.14 (.006)	0.2 (.008)	0.28 (.011)	0.35 (.014)	0.4 (.016)	0.49 (.019)
6.3 / 25 (250 / 1000)	-	0.28 (.011)	0.4 (.016)	0.49 (.019)	0.57 (.022)	0.69 (.027)
8 / 32 (320 / 1280)	-	-	0.45 (.018)	0.55 (.022)	0.64 (.025)	0.78 (.031)

Trouble Shooting Guide map

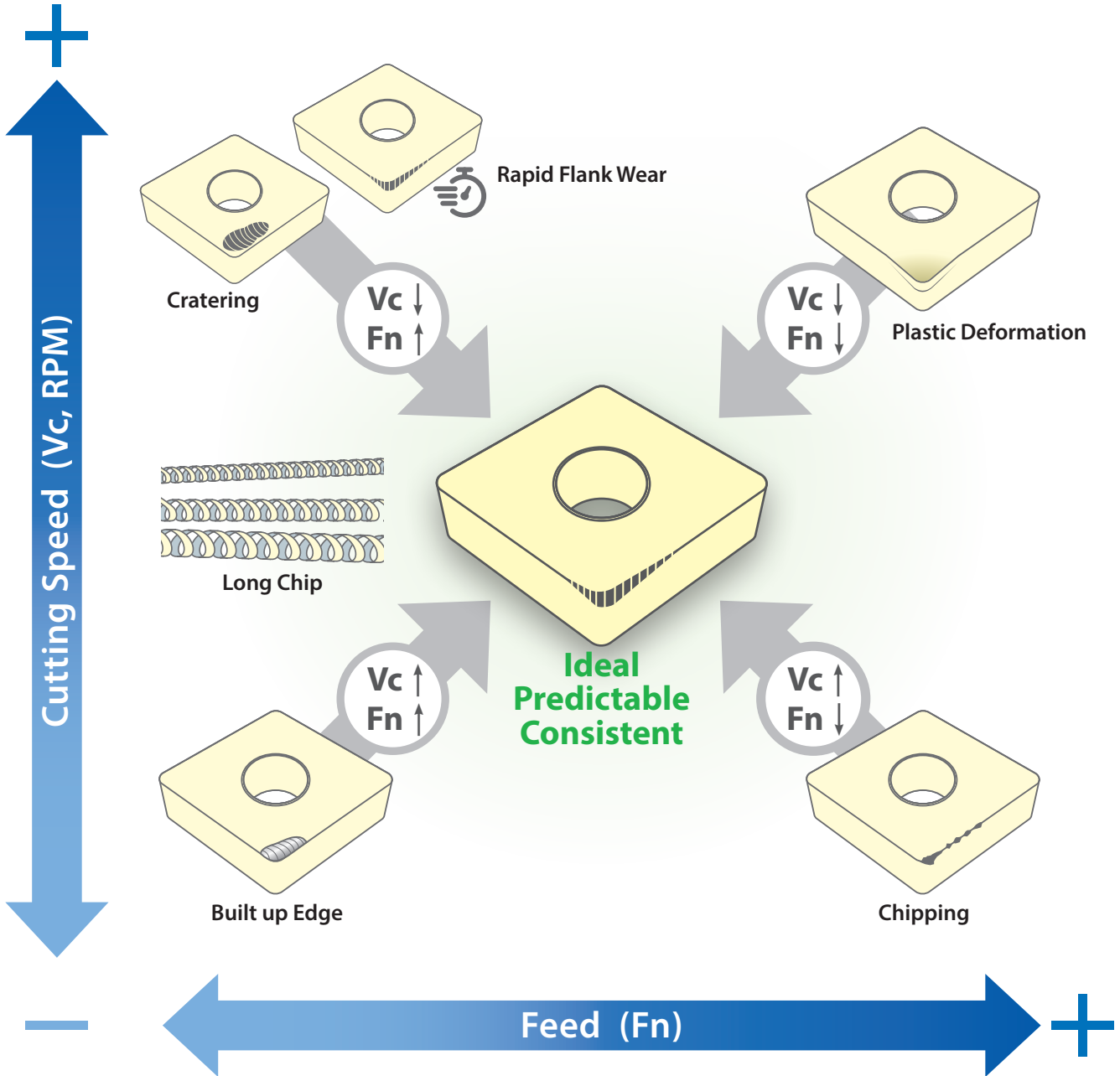

Application Guide

Trouble Shooting

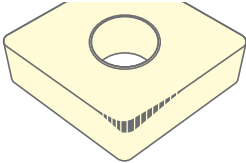
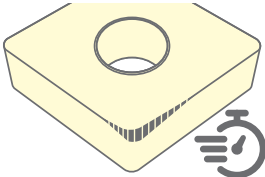
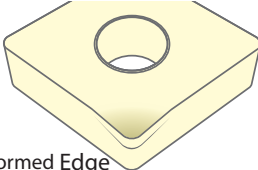
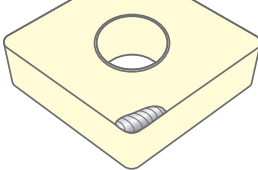
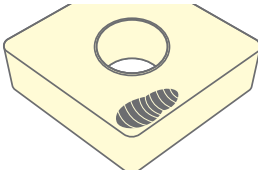
Pattern	Reasons	Solutions
<p>General Flank Wear</p>  <p>Flank face near by corner is abraded</p>	<ul style="list-style-type: none"> - The most ideal wear - Consistent and predictable - General wear behavior when machining condition is normal 	
<p>Rapid Flank Wear</p>  <p>Looks same as general flank wear, but happens quickly</p>	<p>Grade</p> <ul style="list-style-type: none"> - Not enough wear resistance - Too tough grade <p>Heat</p> <ul style="list-style-type: none"> - Cutting speed is too high - Not enough coolant 	<ul style="list-style-type: none"> - More wear resistant grade - Reduce the cutting speed (Vc, SFM, RPM or SFPM) - Optimize coolant - Increase Feed (Fn) if feed is low
<p>Plastic Deformation</p>  <p>Deformed Edge</p>	<ul style="list-style-type: none"> - Excess thermal load - Excess mechanical load 	<ul style="list-style-type: none"> - Reduce cutting temperature - More wear resistant grade - Reduce the cutting speed (Vc, SFM, RPM or SFPM) - Lower feed (Fn) - Lower depth of cut (ap) - Optimize coolant
<p>Built up Edge</p>  <p>Workpiece material is welded on the cutting edge</p>	<ul style="list-style-type: none"> - Sticky materials (low carbon steel, Stainless steel, non-ferrous metal, heat resistant super alloys) - Too low cutting speed 	<ul style="list-style-type: none"> - Increase cutting speed - Lower feed rate - Sharper chipbreaker & geometry - Use high pressure coolant - Use PVD grade - Use Positive Insert
<p>Cratering</p> 	<p>Heat</p> <ul style="list-style-type: none"> - Cutting speed is too high - Too tough grade 	<ul style="list-style-type: none"> - Reduce cutting temperature - Lower cutting speed (Vc, SFM, RPM or SFPM) - Adjust Feed (Fn) - Harder grade

Application Guide

Trouble Shooting

TURNING

PARTING & GROOVING

MILLING





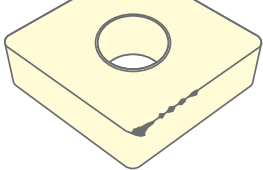
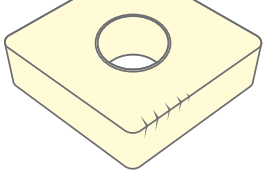
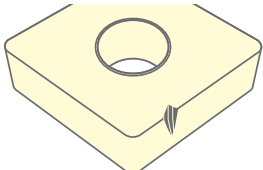
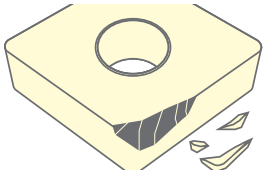
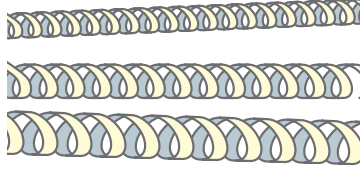



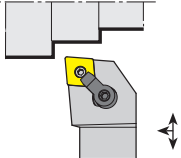

DRILLING

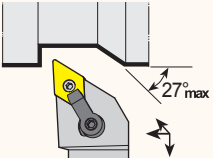
TECHNICAL INFORMATION

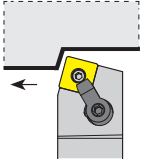
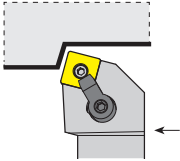
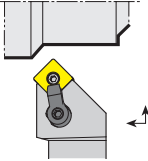
Pattern	Reasons	Solutions
Chipping 	<ul style="list-style-type: none"> - Unstable machining condition (Vibration) - Grade is too hard / brittle - Grade is too sharp 	<ul style="list-style-type: none"> - Focus on stabilizing cutting condition - Reduce overhang (shorter and bigger tool) - Tougher grade - Tougher chipbreaker
Thermal Crack 	<ul style="list-style-type: none"> - Thermal stress due to rapid change of temperature 	<ul style="list-style-type: none"> - Tougher grade - Lower cutting speed (Vc, SFM, RPM or SFPM) - Lower feed (Fn) - Sharper chipbreaker - Change coolant / dry cut
Notching 	<ul style="list-style-type: none"> - Improved edge strength work piece has hardened skin 	<ul style="list-style-type: none"> - More wear resistant grade - Reduce the cutting speed (Vc, SFM, RPM or SFPM) - Adjust Feed (Fn) - Lower depth of cut (ap) - Optimize coolant - Go for tougher chipbreaker
Breakage (Mechanical Fracture) 	<ul style="list-style-type: none"> - Mechanical load is too heavy (feed or depth is too high) - Heavy interrupted cut - Grade is too hard for work material - Unstable machining (vibration) - Cutting speed is too low - Impurities in work material 	<ul style="list-style-type: none"> - Lower feed (Fn) or depth of cut (ap) - Tougher grade - Reduce overhang and check stability of tool and work material - Higher cutting speed (Vc, SFM, RPM or SFPM)
Long Chip 	<ul style="list-style-type: none"> - Feed is too low for chipbreaker - Depth of cut is too shallow for corner radius - Chip area (Fn x Ap) too low 	<ul style="list-style-type: none"> - Higher feed - Sharper chipbreaker - Higher depth of cut - Select a smaller corner radius

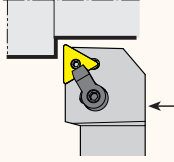
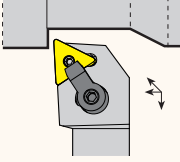
Turning - Holder - External

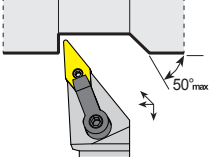
External Holders Overview

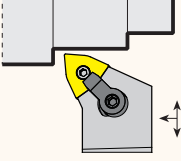
Series	Turning Holder
 <p>CNMA CNMG</p> <p>p. 32</p>	 <p>MCLNR/L Pin + Top Clamp</p> <p>p. 26</p>
 <p>DNMA DNMG</p> <p>p. 35</p>	 <p>MDJNR/L Pin + Top Clamp</p> <p>p. 26</p>
 <p>SNMA SNMG</p> <p>p. 39</p>	 <p>MSBNR/L Pin + Top Clamp</p> <p>p. 27</p>  <p>MSRNR/L Pin + Top Clamp</p> <p>p. 27</p>  <p>MSSNR/L Pin + Top Clamp</p> <p>p. 27</p>
 <p>TNMA TNMG TNUX</p> <p>p. 41</p>	 <p>MTGNR/L Pin + Top Clamp</p> <p>p. 28</p>  <p>MTJNR/L Pin + Top Clamp</p> <p>p. 28</p>
 <p>VNMA VNMG</p> <p>p. 45</p>	 <p>MVJNR/L Pin + Top Clamp</p> <p>p. 29</p>
 <p>WNMA WNMG</p> <p>p. 47</p>	 <p>MWLNR/L Pin + Top Clamp</p> <p>p. 30</p>

TURNING

PARTING & GROOVING

MILLING

DRILLING

TECHNICAL INFORMATION

External Holders for CN** Insert

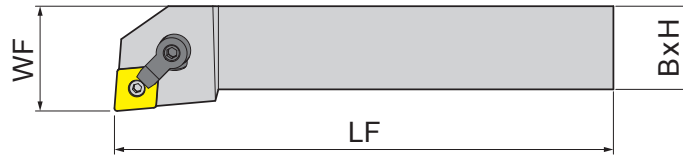

: p. 32 Unit: inch

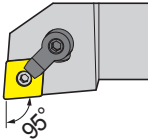
Series	Designation	EDP 2700..		H	B	WF	LF	Insert
		R	L					
 MCLNR/L (Pin + Top Clamp Type 95°)	MCLNR/L 12 4B	0369	0370	.75	.75	1	4.5	CN43
	MCLNR/L 16 4D	0358	0357	1.00	1.00	1.25	6	
	MCLNR/L 20 4D	0371	0372	1.25	1.25	1.5	6	

Series	Size	Clamp Screw	Pin	Shim	Allen Key
MCLNR/L	12 4B	MCS061025	MCP617	MSC43	MWR3
	16~20 4D	MCS061030	MCP617	MSC43	MWR3

External Holders for DN** Insert

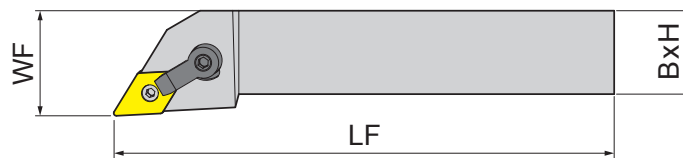

: p. 35 Unit: inch

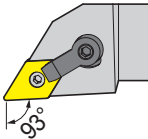
Series	Designation	EDP 2700..		H	B	WF	LF	Insert
		R	L					
 MDJNR/L (Pin + Top Clamp Type 95°)	MDJNR/L 12 4B	0373	0374	.75	.75	1	4.5	DN43
	MDJNR/L 16 4D	0360	0359	1.00	1.00	1.25	6	
	MDJNR/L 20 4D	0375	0376	1.25	1.25	1.5	6	

Series	Size	Clamp Screw	Pin	Shim	Allen Key
MDJNR/L	12 4B	MCS061025	MCP619	MSD43	MWR3
	16~20 4D	MCS061030	MCP619	MSD43	MWR3

Turning - Holder - External

External Holders for SN** Insert

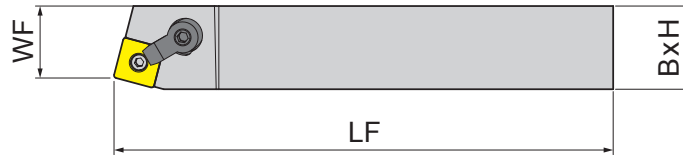

: p. 39 Unit: inch

Series	Designation	EDP 2700..		H	B	WF	LF	Insert
		R	L					
 MSBNR/L (Pin + Top Clamp Type 95°)	MSBNR/L 16 4D	0362	0361	1.00	1.00	0.843	6	SN43
 MSRNR/L (Pin + Top Clamp Type 95°)	MSRNR/L 16 4D	0395	0396	1.00	1.00	1.128	6	SN43
 MSSNR/L (Pin + Top Clamp Type 95°)	MSSNR/L 16 4D	0397	0398	1.00	1.00	0.912	6	SN43

Series	Size	Clamp Screw	Pin	Shim	Allen Key
MSBNR/L	16 4D	MCS061030	MCP617	MSS43	MWR3
MSRNR/L	16 4D	MCS061030	MCP617	MSS43	MWR3
MSSNR/L	16 4D	MCS061030	MCP617	MSS43	MWR3

External Holders for TN** Insert

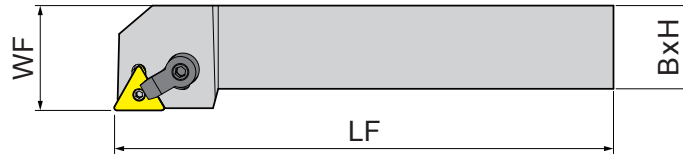

: p. 41 Unit: inch

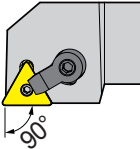
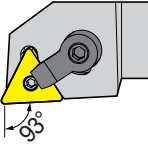
Series	Designation	EDP 2700..		H	B	WF	LF	Insert
		R	L					
 MTGNR/L (Pin + Top Clamp Type 95°)	MTGNR/L 16 4D	0364	0363	1.00	1.00	1.25	6	TN43
 MTJNR/L (Pin + Top Clamp Type 95°)	MTJNR/L 12 3B	0377	0378	.75	.75	1	4.5	TN33
	MTJNR/L 16 4D	0379	0380	1.00	1.00	1.25	6	TN43
	MTJNR/L 20 4D	0381	0382	1.25	1.25	1.5	6	

Series	Size	Clamp Screw	Pin	Shim	Allen Key
MTGNR/L	16 4D	MCS061025	MCP513	MST43	MWR3
MTJNR/L	12 3B	MCS061025	MCP513	MST33	MWR3
	16~20 4D	MCS061030	MCP617	MST43	MWR3

Turning - Holder - External

External Holders for VN** Insert

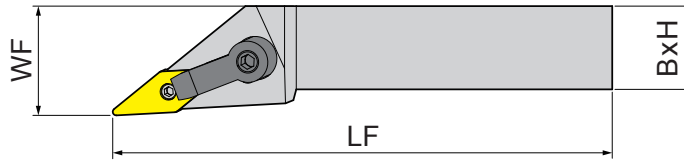

: p. 45 Unit: inch

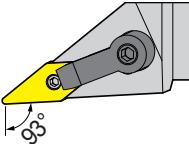
Series	Designation	EDP 2700..		H	B	WF	LF	Insert
		R	L					
 MVJNR/L (Pin + Top Clamp Type 95°)	MVJNR/L 12 3B	0383	0384	.75	.75	1	4.5	VN33
	MVJNR/L 16 3D	0366	0365	1.00	1.00	1.25	6	
	MVJNR/L 20 3D	0385	0386	1.25	1.25	1.5	6	

TURNING

PARTING & GROOVING

MILLING

DRILLING

TECHNICAL INFORMATION

Series	Size	Clamp Screw	Pin	Shim	Allen Key
MVJNR/L	12~163..	MCS061025	MCP513	MSV33	MWR2, MWR3
	20 3D	MCS061030	MCP513	MSV33	MWR2, MWR3

External Holders for WN** Insert

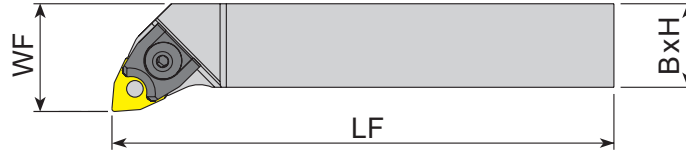

: p. 47 Unit: inch

TURNING

PARTING & GROOVING

MILLING

DRILLING



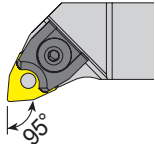



TECHNICAL INFORMATION

Series	Designation	EDP 2700..		H	B	WF	LF	Insert
		R	L					
 MWLNR/L (Pin + Top Clamp Type 95°)	MWLNR/L 12 3B	0387	0388	.75	.75	1	4.5	WN33
	MWLNR/L 16 3D	0389	0390	1.00	1.00	1.25	6	
	MWLNR/L 12 4B	0391	0392	.75	.75	1	4.5	WN43
	MWLNR/L 16 4D	0368	0367	1.00	1.00	1.25	6	
	MWLNR/L 20 4D	0393	0394	1.25	1.25	1.5	6	







Series	Size	Clamp Screw	Pin	Shim	Allen Key
MWLNR/L	12 3B	MCS061025	MCP513	MSW33	MWR3
	16 3D	MCS061030	MCP513	MSW33	MWR3
	12 4B	MCS061025	MCP617	MSW43	MWR3
	16~20 4D	MCS061030	MCP617	MSW43	MWR3

Turning Inserts Overview

Negative Inserts

Shape	Series	Size & Thickness				Page
C 	CNMA		43	54	64	32
	CNMG		43	54	64	
D 	DNMA		43	44		35
	DNMG		43	44		
K 	KNUX	1604 (mm)				38
S 	SNMA		43	54		39
	SNMG		43			
T 	TNMA	33				41
	TNMG	33	43			
	TNMX	33				44
V 	VNMA	33				45
	VNMG	33				
W 	WNMA		43			47
	WNMG	33	43			

Positive Inserts

Shape	Series	Size & Thickness				Page
C 	CCGT		32.5		43	50
	CCMT	21.5	32.5		43	
D 	DCGT		32.5			51
	DCMT	21.5	32.5			
R 	RCMT	0602 (mm)	0803 (mm)	10T3 (mm)	1204 (mm)	52
S 	SCMT		32.5		43	53
T 	TCGT		32.5			54
	TCMT	21.5	32.5			
V 	VBMT			33		55
	VCGT / VCMT			33		56



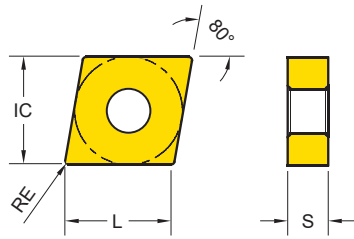

Turning Inserts - Negative CNMG / CNMA (80° Negative)



Series	L	IC	S
CN** 43	.472	1/2	3/16
CN** 54	.630	5/8	1/4
CN** 64	.748	3/4	1/4

EDP 2200..

●: Stock item ○: Order made item

CNMA CNMG	Designation	RE (in)	Fn (in/rev)	Ap (in)	P05	P10	P15	P20	P30	P20	M15	M30	M40	N20	N20
					K10	K20	M20	S10	S20	S30	N20	N20			
..MA  Cast iron	CNMA 431	1/64	.006 ~ .020	.02 ~ .10	●	●									
	CNMA 432	1/32	.006 ~ .020	.04 ~ .14	●	●									
	CNMA 433	3/64	.006 ~ .020	.06 ~ .20	●	●									
	CNMA 434	1/16	.006 ~ .020	.06 ~ .20	●	●									
	CNMA 543	3/64	.006 ~ .020	.06 ~ .20	●	●									
	CNMA 544	1/16	.006 ~ .020	.08 ~ .20	●	●									
	CNMA 643	3/64	.006 ~ .020	.06 ~ .35	●	●									
	CNMA 644	1/16	.006 ~ .039	.12 ~ .39	●	●									
-UF  Finishing	CNMG 431 - UF	1/64	.002 ~ .010	.02 ~ .06		●		●	●	●					
	CNMG 432 - UF	1/32	.002 ~ .010	.04 ~ .10		●	●	●	●	●					
-UL  Light Machining and Sticky Material	CNMG 431 - UL	1/64	.004 ~ .012	.02 ~ .08		●		●	●						
	CNMG 432 - UL	1/32	.004 ~ .012	.04 ~ .12		●		●	●						
	CNMG 433 - UL	3/64	.004 ~ .012	.06 ~ .14		●		●	●						
-UM  Medium Machining Unstable condition	CNMG 431 - UM	1/64	.006 ~ .012	.02 ~ .06		●		●	●						
	CNMG 432 - UM	1/32	.006 ~ .012	.02 ~ .08	●	●	●	●	●						
	CNMG 433 - UM	3/64	.006 ~ .012	.06 ~ .12		●		●	●						

Cutting Speed			Vc (ft/min)																						
ISO	VDI	Sub Group	YG1001		YG3010		YG3015		YG3020		YG3030		YG801		YG211		YG213		YG214		YG100		YG10		
			Min	Max	Min	Max	Min	Max	Min	Max	Min	Max	Min	Max	Min	Max	Min	Max	Min	Max	Min	Max	Min	Max	
P	1~5	Non-Alloyed Steel	720	1570	560	1480	560	1340	590	1250	490	1150	390	660	-	-	-	-	-	-	-	-	-	-	-
	6~9	Low-Alloyed Steel	720	1380	590	1250	430	1180	360	1150	300	980	230	660	-	-	-	-	-	-	-	-	-	-	-
	10~11	High-Alloyed Steel	-	-	330	1080	260	1020	200	980	230	820	-	-	-	-	-	-	-	-	-	-	-	-	-
M	12~13	Ferritic & Martensitic	-	-	-	-	-	-	-	390	750	-	-	430	750	360	590	260	490	-	-	-	-	-	-
	14	Austenitic Stainless Steel	-	-	-	-	-	-	-	260	660	-	-	330	660	130	430	100	390	-	-	-	-	-	-
K	15~16	Grey Cast Iron	560	1380	390	980	-	-	-	-	-	-	-	-	-	-	-	-	-	-	-	-	-	-	
	17~18	Nodular Cast Iron	390	1340	390	920	-	-	-	-	-	-	-	-	-	-	-	-	-	-	-	-	-	-	
N	21~30	Non-Ferrous Metals (Al)	-	-	-	-	-	-	-	-	-	-	-	-	-	-	-	-	-	-	1150	3940	820	2620	
S	31~37	Superalloys & Titanium	-	-	-	-	-	-	-	110	260	-	-	100	300	70	130	70	130	-	-	-	-	-	
H	38~41	Hard Materials	-	-	-	-	-	-	-	-	-	-	-	-	-	-	-	-	-	-	-	-	-	-	

Turning Inserts - Negative CNMG / CNMA (80° Negative)

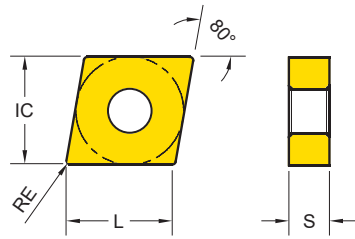

Series	L	IC	S
CN** 43	.472	1/2	3/16
CN** 54	.630	5/8	1/4
CN** 64	.748	3/4	1/4

EDP 2200..

●: Stock item ○: Order made item

CNMA CNMG	Designation	RE	Fn (in/rev.)	Ap (in)	P05	P10	P15	P20	P30	P20	M15	M30	M40	N20	N20
					K10	K20	M20	S10	S20	S30	YG100	YG10			
-UG Medium Machining at stable condition	CNMG 431 - UG	1/64	.008 ~ .016	.02 ~ .08	●	○		●	●						
	CNMG 432 - UG	1/32	.008 ~ .016	.04 ~ .12	●	○	●	●	●	●					
	CNMG 433 - UG	3/64	.008 ~ .016	.06 ~ .16	●	○		●	●	●					
	CNMG 542 - UG	1/32	.008 ~ .016	.06 ~ .20	●	○		●	●	●					
	CNMG 543 - UG	3/64	.008 ~ .016	.06 ~ .20	●	○		●	●	●					
	CNMG 544 - UG	1/16	.008 ~ .016	.07 ~ .20	●	○		●	●	●					
	CNMG 642 - UG	1/32	.008 ~ .020	.12 ~ .28	●	○		●	●	●					
-UC Cast iron and Medium roughing	CNMG 431 - UC	1/64	.008 ~ .016	.02 ~ .10	●	○		●	●						
	CNMG 432 - UC	1/32	.008 ~ .016	.04 ~ .16	●	○		●	●						
	CNMG 433 - UC	3/64	.008 ~ .016	.06 ~ .18	●	○		●	●						
-UR Roughing	CNMG 432 - UR	1/32	.012 ~ .020	.04 ~ .16	●	○		●	●						
	CNMG 433 - UR	3/64	.012 ~ .020	.06 ~ .20	●	○		●	●	●					
	CNMG 434 - UR	1/16	.012 ~ .020	.08 ~ .20	●	○		●	●	●					
	CNMG 542 - UR	1/32	.012 ~ .020	.04 ~ .20	●	○		●	●	●					
	CNMG 543 - UR	3/64	.012 ~ .020	.06 ~ .20	●	○		●	●	●					
	CNMG 544 - UR	1/16	.012 ~ .020	.08 ~ .20	●	○		●	●	●					
	CNMG 642 - UR	1/32	.012 ~ .031	.12 ~ .35	●	○		●	●	●					
	CNMG 643 - UR	3/64	.012 ~ .031	.12 ~ .35	●	○		●	●	●					
	CNMG 644 - UR	1/16	.012 ~ .031	.12 ~ .35	●	○		●	●	●					

Cutting Speed			Vc (ft/min)																						
ISO	VDI	Sub Group	YG1001		YG3010		YG3015		YG3020		YG3030		YG801		YG211		YG213		YG214		YG100		YG10		
			Min	Max	Min	Max	Min	Max	Min	Max	Min	Max	Min	Max	Min	Max	Min	Max	Min	Max	Min	Max	Min	Max	
P	1~5	Non-Alloyed Steel	720	1570	560	1480	560	1340	590	1250	490	1150	390	660	-	-	-	-	-	-	-	-	-	-	-
	6~9	Low-Alloyed Steel	720	1380	590	1250	430	1180	360	1150	300	980	230	660	-	-	-	-	-	-	-	-	-	-	-
	10~11	High-Alloyed Steel	-	-	330	1080	260	1020	200	980	230	820	-	-	-	-	-	-	-	-	-	-	-	-	-
M	12~13	Ferritic & Martensitic	-	-	-	-	-	-	-	390	750	-	-	430	750	360	590	260	490	-	-	-	-	-	-
	14	Austenitic Stainless Steel	-	-	-	-	-	-	-	260	660	-	-	330	660	130	430	100	390	-	-	-	-	-	-
K	15~16	Grey Cast Iron	560	1380	390	980	-	-	-	-	-	-	-	-	-	-	-	-	-	-	-	-	-	-	
	17~18	Nodular Cast Iron	390	1340	390	920	-	-	-	-	-	-	-	-	-	-	-	-	-	-	-	-	-	-	
N	21~30	Non-Ferrous Metals (Al)	-	-	-	-	-	-	-	-	-	-	-	-	-	-	-	-	-	-	1150	3940	820	2620	
S	31~37	Superalloys & Titanium	-	-	-	-	-	-	-	110	260	-	-	100	300	70	130	70	130	-	-	-	-	-	
H	38~41	Hard Materials	-	-	-	-	-	-	-	-	-	-	-	-	-	-	-	-	-	-	-	-	-	-	



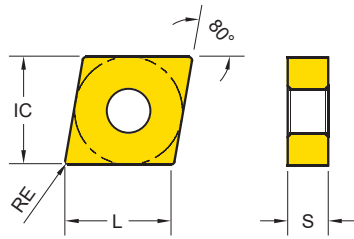

Turning Inserts - Negative CNMG / CNMA (80° Negative)



Series	L	IC	S
CN** 43	.472	1/2	3/16
CN** 54	.630	5/8	1/4
CN** 64	.748	3/4	1/4

EDP 2200..

●: Stock item ○: Order made item

CNMA CNMG	Designation	RE (in)	Fn (in/rev)	Ap (in)	P05	P10	P15	P20	P30	P20	M15	M30	M40	N20	N20
					K10	K20	M20	S10	S20	S30	YG100	YG10			
-MF  Stainless steel Finishing	CNMG 431 - MF	1/64	.003 ~ .012	.01 ~ .06	●	●					●	●			
	CNMG 432 - MF	1/32	.003 ~ .012	.01 ~ .06							●	●	●		
	CNMG 433 - MF	3/64	.003 ~ .012	.01 ~ .06							●			●	
-MM  Stainless steel Medium	CNMG 431 - MM	1/64	.008 ~ .014	.02 ~ .12							●	●			
	CNMG 432 - MM	1/32	.008 ~ .014	.04 ~ .14				●	●	●	●	●	●		
	CNMG 433 - MM	3/64	.008 ~ .014	.06 ~ .14				●	●	●	●	●	●		
-MR  Stainless steel Roughing	CNMG 432 - MR	1/32	.012 ~ .022	.05 ~ .22							●	●	●		
	CNMG 433 - MR	3/64	.012 ~ .022	.06 ~ .22							●	●	●		
-KR  Cast Iron Heavy Roughing	CNMG 432 - KR	1/32	.012 ~ .024	.04 ~ .20	●	●									
	CNMG 433 - KR	3/64	.012 ~ .024	.06 ~ .20	●	●									

Cutting Speed			Vc (ft/min)											
ISO	VDI	Sub Group	YG1001	YG3010	YG3015	YG3020	YG3030	YG801	YG211	YG213	YG214	YG100	YG10	
			Min Max	Min Max	Min Max	Min Max	Min Max	Min Max	Min Max	Min Max	Min Max	Min Max	Min Max	Min Max
P	1~5	Non-Alloyed Steel	720 1570	560 1480	560 1340	590 1250	490 1150	390 660	- -	- -	- -	- -	- -	
	6~9	Low-Alloyed Steel	720 1380	590 1250	430 1180	360 1150	300 980	230 660	- -	- -	- -	- -	- -	
	10~11	High-Alloyed Steel	- -	330 1080	260 1020	200 980	230 820	- -	- -	- -	- -	- -	- -	
M	12~13	Ferritic & Martensitic	- -	- -	- -	- -	390 750	- -	430 750	360 590	260 490	- -	- -	
	14	Austenitic Stainless Steel	- -	- -	- -	- -	260 660	- -	330 660	130 430	100 390	- -	- -	
K	15~16	Grey Cast Iron	560 1380	390 980	- -	- -	- -	- -	- -	- -	- -	- -	- -	
	17~18	Nodular Cast Iron	390 1340	390 920	- -	- -	- -	- -	- -	- -	- -	- -	- -	
N	21~30	Non-Ferrous Metals (Al)	- -	- -	- -	- -	- -	- -	- -	- -	- -	1150 3940	820 2620	
S	31~37	Superalloys & Titanium	- -	- -	- -	- -	110 260	- -	100 300	70 130	70 130	- -	- -	
H	38~41	Hard Materials	- -	- -	- -	- -	- -	- -	- -	- -	- -	- -	- -	

Turning Inserts - Negative DNMG / DNMA (55° Negative)

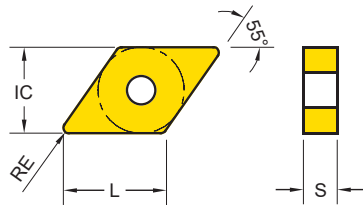

Series	L	IC	S
DN** 43	.551	1/2	3/16
DN** 44	.551	1/2	1/4

EDP 2200..

●: Stock item ○: Order made item

DNMA DNMG	Designation	RE (in)	Fn (in/rev)	Ap (in)	P05	P10	P15	P20	P30	P20	M15	M30	M40	N20	N20
					K10	K20			M20		S10	S20	S30		
..MA Cast iron	DNMA 432	1/32	.006 ~ .020	.04 ~ .12	●	●									
	DNMA 433	3/64	.006 ~ .020	.06 ~ .16	●	●									
	DNMA 442	1/32	.006 ~ .020	.04 ~ .12	●	●									
	DNMA 443	3/64	.006 ~ .020	.06 ~ .16	●	●									
-UF Finishing	DNMG 431 - UF	1/64	.002 ~ .010	.02 ~ .06	●	●			●	●	●				
	DNMG 432 - UF	1/32	.002 ~ .010	.04 ~ .10	●	●			●	●	●				
	DNMG 441 - UF	1/64	.002 ~ .010	.04 ~ .08	●	●			●	●	●				
	DNMG 442 - UF	1/32	.002 ~ .010	.06 ~ .14	●	●			●	●	●				
-UL Light Machining and Sticky Material	DNMG 331 - UL	1/64	.004 ~ .012	.02 ~ .10	●	●			●	●					
	DNMG 332 - UL	1/32	.004 ~ .012	.02 ~ .10	●	●			●	●					
	DNMG 431 - UL	1/64	.004 ~ .012	.02 ~ .12	●	●			●	●					
	DNMG 432 - UL	1/32	.004 ~ .012	.04 ~ .12	●	●			●	●					
	DNMG 433 - UL	3/64	.004 ~ .012	.06 ~ .12	●	●			●	●					
	DNMG 441 - UL	1/64	.004 ~ .012	.02 ~ .08	●	●			●	●					
	DNMG 442 - UL	1/32	.004 ~ .012	.06 ~ .12	●	●			●	●					
	DNMG 443 - UL	3/64	.004 ~ .012	.06 ~ .12	●	●			●	●					

Cutting Speed			Vc (ft/min)											
ISO	VDI	Sub Group	YG1001	YG3010	YG3015	YG3020	YG3030	YG801	YG211	YG213	YG214	YG100	YG10	
			Min Max	Min Max	Min Max	Min Max	Min Max	Min Max	Min Max	Min Max	Min Max	Min Max	Min Max	Min Max
P	1~5	Non-Alloyed Steel	720 1570	560 1480	560 1340	590 1250	490 1150	390 660	- -	- -	- -	- -	- -	
	6~9	Low-Alloyed Steel	720 1380	590 1250	430 1180	360 1150	300 980	230 660	- -	- -	- -	- -	- -	
	10~11	High-Alloyed Steel	- -	330 1080	260 1020	200 980	230 820	- -	- -	- -	- -	- -	- -	
M	12~13	Ferritic & Martensitic	- -	- -	- -	- -	390 750	- -	430 750	360 590	260 490	- -	- -	
	14	Austenitic Stainless Steel	- -	- -	- -	- -	260 660	- -	330 660	130 430	100 390	- -	- -	
K	15~16	Grey Cast Iron	560 1380	390 980	- -	- -	- -	- -	- -	- -	- -	- -	- -	
	17~18	Nodular Cast Iron	390 1340	390 920	- -	- -	- -	- -	- -	- -	- -	- -	- -	
N	21~30	Non-Ferrous Metals (Al)	- -	- -	- -	- -	- -	- -	- -	- -	- -	1150 3940	820 2620	
S	31~37	Superalloys & Titanium	- -	- -	- -	- -	110 260	- -	100 300	70 130	70 130	- -	- -	
H	38~41	Hard Materials	- -	- -	- -	- -	- -	- -	- -	- -	- -	- -	- -	

Turning Inserts - Negative DNMG / DNMA (55° Negative)

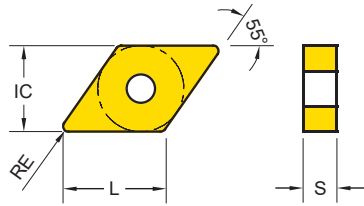

Series	L	IC	S
DN** 43	.551	1/2	3/16
DN** 44	.551	1/2	1/4

TURNING

PARTING & GROOVING

MILLING

DRILLING

TECHNICAL INFORMATION

EDP 2200..

●: Stock item ○: Order made item

DNMA DNMG	Designation	RE (in)	Fn (in/rev)	Ap (in)	P05	P10	P15	P20	P30	P20	M15	M30	M40	N20	N20
					K10	K20	M20	S10	S20	S30	YG100	YG10			
-UM Medium Machining Unstable condition	DNMG 432 - UM	1/32	.006 ~ .012	.04 ~ .12	●	●			●	●					
	DNMG 433 - UM	3/64	.006 ~ .012	.06 ~ .16	●	●			●	●					
	DNMG 442 - UM	1/32	.006 ~ .012	.02 ~ .08		●			●	●					
	DNMG 443 - UM	3/64	.006 ~ .012	.06 ~ .12	●	●			●	●					
-UG Medium Machining at stable condition	DNMG 431 - UG	1/64	.008 ~ .016	.02 ~ .12		●			●	●					
	DNMG 432 - UG	1/32	.008 ~ .016	.04 ~ .10	●	●			●	●	●				
	DNMG 433 - UG	3/64	.008 ~ .016	.06 ~ .12	●	●			●	●					
	DNMG 441 - UG	1/64	.008 ~ .016	.02 ~ .08		●			●	●					
	DNMG 442 - UG	1/32	.008 ~ .016	.04 ~ .12	●	●			●	●	●				
	DNMG 443 - UG	3/64	.008 ~ .016	.06 ~ .14	●	●			●	●					
-UC Cast iron and Medium roughing	DNMG 432 - UC	1/32	.008 ~ .016	.04 ~ .12	●	●	●	●	●	●					
	DNMG 433 - UC	3/64	.008 ~ .016	.06 ~ .14	●	●			●	●					
	DNMG 442 - UC	1/32	.008 ~ .016	.04 ~ .12	●	●	●	●	●	●					
	DNMG 443 - UC	3/64	.008 ~ .016	.06 ~ .14	●	●			●	●					
-UR Roughing	DNMG 432 - UR	1/32	.012 ~ .020	.04 ~ .14		●									
	DNMG 433 - UR	3/64	.012 ~ .020	.06 ~ .16	●	●			●						
	DNMG 442 - UR	1/32	.012 ~ .020	.04 ~ .20	●	●			●	●					
	DNMG 443 - UR	3/64	.012 ~ .020	.06 ~ .16	●	●			●	●	●				

Cutting Speed			Vc (ft/min)																					
ISO	VDI	Sub Group	YG1001		YG3010		YG3015		YG3020		YG3030		YG801		YG211		YG213		YG214		YG100		YG10	
			Min	Max	Min	Max	Min	Max	Min	Max	Min	Max	Min	Max	Min	Max	Min	Max	Min	Max	Min	Max	Min	Max
P	1~5	Non-Alloyed Steel	720	1570	560	1480	560	1340	590	1250	490	1150	390	660	-	-	-	-	-	-	-	-	-	-
	6~9	Low-Alloyed Steel	720	1380	590	1250	430	1180	360	1150	300	980	230	660	-	-	-	-	-	-	-	-	-	-
	10~11	High-Alloyed Steel	-	-	330	1080	260	1020	200	980	230	820	-	-	-	-	-	-	-	-	-	-	-	-
M	12~13	Ferritic & Martensitic	-	-	-	-	-	-	-	390	750	-	-	430	750	360	590	260	490	-	-	-	-	-
	14	Austenitic Stainless Steel	-	-	-	-	-	-	-	260	660	-	-	330	660	130	430	100	390	-	-	-	-	-
K	15~16	Grey Cast Iron	560	1380	390	980	-	-	-	-	-	-	-	-	-	-	-	-	-	-	-	-	-	-
	17~18	Nodular Cast Iron	390	1340	390	920	-	-	-	-	-	-	-	-	-	-	-	-	-	-	-	-	-	-
N	21~30	Non-Ferrous Metals (Al)	-	-	-	-	-	-	-	-	-	-	-	-	-	-	-	-	-	1150	3940	820	2620	-
S	31~37	Superalloys & Titanium	-	-	-	-	-	-	-	110	260	-	-	100	300	70	130	70	130	-	-	-	-	-
H	38~41	Hard Materials	-	-	-	-	-	-	-	-	-	-	-	-	-	-	-	-	-	-	-	-	-	-

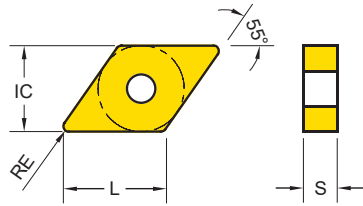

Turning Inserts - Negative DNMG / DNMA (55° Negative)



Series	L	IC	S
DN** 43	.551	1/2	3/16
DN** 44	.551	1/2	1/4

EDP 2200..

●: Stock item ○: Order made item

DNMA DNMG	Designation	RE (in)	Fn (in/rev)	Ap (in)	P05	P10	P15	P20	P30	P20	M15	M30	M40	N20	N20
					K10	K20	M20	S10	S20	S30					
-MF  Stainless steel Finishing	DNMG 431 - MF	1/64	.003 ~ .012	.01 ~ .06	YG1001	YG3010	YG3015	YG3020	YG3030	YG801	YG211	YG213	YG214	YG100	YG10
	DNMG 432 - MF	1/32	.003 ~ .012	.01 ~ .06					●		●	●			
	DNMG 441 - MF	1/64	.003 ~ .012	.01 ~ .06							●	●			
	DNMG 442 - MF	1/32	.003 ~ .012	.01 ~ .06					●		●	●			
-MM  Stainless steel Medium	DNMG 431 - MM	1/64	.008 ~ .014	.02 ~ .12					●		●	●			
	DNMG 432 - MM	1/32	.008 ~ .014	.04 ~ .14					●		●	●			
	DNMG 433 - MM	3/64	.008 ~ .014	.06 ~ .14					●		●	●			
	DNMG 441 - MM	1/64	.008 ~ .014	.02 ~ .12					●		●	●			
	DNMG 442 - MM	1/32	.008 ~ .014	.04 ~ .14					●		●	●	●		
	DNMG 443 - MM	3/64	.008 ~ .014	.06 ~ .14					●		●	●	●		
-MR  Stainless steel Roughing	DNMG 432 - MR	1/32	.012 ~ .022	.08 ~ .22					●		●	●	●		
	DNMG 433 - MR	3/64	.012 ~ .022	.08 ~ .22							●	●	●		
	DNMG 442 - MR	1/32	.012 ~ .022	.08 ~ .22					●		●	●	●		
	DNMG 443 - MR	3/64	.012 ~ .022	.08 ~ .22					●		●	●	●		

Cutting Speed			Vc (ft/min)																					
ISO	VDI	Sub Group	YG1001		YG3010		YG3015		YG3020		YG3030		YG801		YG211		YG213		YG214		YG100		YG10	
			Min	Max	Min	Max	Min	Max	Min	Max	Min	Max	Min	Max	Min	Max	Min	Max	Min	Max	Min	Max	Min	Max
P	1~5	Non-Alloyed Steel	720	1570	560	1480	560	1340	590	1250	490	1150	390	660	-	-	-	-	-	-	-	-	-	-
	6~9	Low-Alloyed Steel	720	1380	590	1250	430	1180	360	1150	300	980	230	660	-	-	-	-	-	-	-	-	-	-
	10~11	High-Alloyed Steel	-	-	330	1080	260	1020	200	980	230	820	-	-	-	-	-	-	-	-	-	-	-	-
M	12~13	Ferritic & Martensitic	-	-	-	-	-	-	-	-	390	750	-	-	430	750	360	590	260	490	-	-	-	-
	14	Austenitic Stainless Steel	-	-	-	-	-	-	-	-	260	660	-	-	330	660	130	430	100	390	-	-	-	-
K	15~16	Grey Cast Iron	560	1380	390	980	-	-	-	-	-	-	-	-	-	-	-	-	-	-	-	-	-	-
	17~18	Nodular Cast Iron	390	1340	390	920	-	-	-	-	-	-	-	-	-	-	-	-	-	-	-	-	-	-
N	21~30	Non-Ferrous Metals (Al)	-	-	-	-	-	-	-	-	-	-	-	-	-	-	-	-	-	1150	3940	820	2620	
S	31~37	Superalloys & Titanium	-	-	-	-	-	-	-	-	110	260	-	-	100	300	70	130	70	130	-	-	-	-
H	38~41	Hard Materials	-	-	-	-	-	-	-	-	-	-	-	-	-	-	-	-	-	-	-	-	-	

Turning Inserts - Negative

KNUX (55° - 2 Corners Single Side)

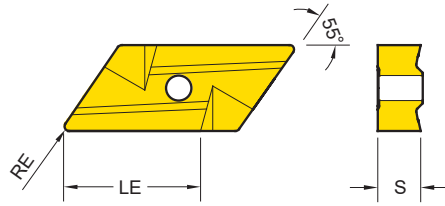

Series	LE	S
KN** 1604	.591	3/16

EDP 2200..

●: Stock item ○: Order made item

KNUX	Designation	RE (in)	Fn (in/rev)	Ap (in)	P05	P10	P15	P20	P30	P20	M15	M30	M40	N20	N20
					K10	K20	M20	S10	S20	S30	YG100	YG10			
	KNUX 160405L	.02	.004~.016	.02~.24	●	○		●	●	●					
..UX Left						0249			0250	0251	0079				
	KNUX 160405R	.02	.004~.016	.02~.24	●			●	●	●					
..UX Right						0252			0253	0254	0080				
	KNUX 160410R	3/64	.004~.016	.02~.24				●	●						
								1155	1156						

Cutting Speed			Vc (ft/min)																						
ISO	VDI	Sub Group	YG1001		YG3010		YG3015		YG3020		YG3030		YG801		YG211		YG213		YG214		YG100		YG10		
			Min	Max	Min	Max	Min	Max	Min	Max	Min	Max	Min	Max	Min	Max	Min	Max	Min	Max	Min	Max	Min	Max	
P	1~5	Non-Alloyed Steel	720	1570	560	1480	560	1340	590	1250	490	1150	390	660	-	-	-	-	-	-	-	-	-	-	-
	6~9	Low-Alloyed Steel	720	1380	590	1250	430	1180	360	1150	300	980	230	660	-	-	-	-	-	-	-	-	-	-	-
	10~11	High-Alloyed Steel	-	-	330	1080	260	1020	200	980	230	820	-	-	-	-	-	-	-	-	-	-	-	-	-
M	12~13	Ferritic & Martensitic	-	-	-	-	-	-	-	390	750	-	-	430	750	360	590	260	490	-	-	-	-	-	-
	14	Austenitic Stainless Steel	-	-	-	-	-	-	-	260	660	-	-	330	660	130	430	100	390	-	-	-	-	-	-
K	15~16	Grey Cast Iron	560	1380	390	980	-	-	-	-	-	-	-	-	-	-	-	-	-	-	-	-	-	-	-
	17~18	Nodular Cast Iron	390	1340	390	920	-	-	-	-	-	-	-	-	-	-	-	-	-	-	-	-	-	-	-
N	21~30	Non-Ferrous Metals (Al)	-	-	-	-	-	-	-	-	-	-	-	-	-	-	-	-	-	-	1150	3940	820	2620	
S	31~37	Superalloys & Titanium	-	-	-	-	-	-	-	110	260	-	-	100	300	70	130	70	130	-	-	-	-	-	
H	38~41	Hard Materials	-	-	-	-	-	-	-	-	-	-	-	-	-	-	-	-	-	-	-	-	-	-	

Turning Inserts - Negative SNMG / SNMA (90° Negative)

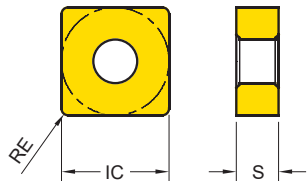

Series	IC	S
SN** 43	1/2	3/16
SN** 54	5/8	1/4

EDP 2200..

●: Stock item ○: Order made item

SNMA SNMG	Designation	RE (in)	Fn (in/rev)	Ap (in)	P05	P10	P15	P20	P30	P20	M15	M30	M40	N20	N20
					K10	K20			M20		S10	S20	S30		
..MA Cast iron	SNMA 432	1/32	.006 ~ .020	.04 ~ .14	● 0027	● 1166									
	SNMA 433	3/64	.006 ~ .020	.06 ~ .20	● 0028	● 1133									
	SNMA 543	3/64	.006 ~ .020	.06 ~ .20	● 729	● 1150									
	SNMA 644	1/16	.006 ~ .020	.12 ~ .39	● 1184	● 1261									
-UF Finishing	SNMG 431 - UF	1/64	.002 ~ .010	.02 ~ .06						● 0029					
-UL Light Machining and Sticky Material	SNMG 431 - UL	1/64	.004 ~ .012	.02 ~ .12		● 1167		● 0747	● 1194						
	SNMG 432 - UL	1/32	.004 ~ .012	.04 ~ .12		● 0389		● 0390	● 0391						
-UM Medium Maching Unstable condition	SNMG 432 - UM	1/32	.006 ~ .012	.04 ~ .12	● 0983	● 0739		● 0784	● 0740						
-UG Medium Maching at stable condition	SNMG 432 - UG	1/32	.008 ~ .016	.04 ~ .12	● 1190	● 0141		● 0142	● 0143	● 0030					
	SNMG 433 - UG	3/64	.008 ~ .016	.06 ~ .16	● 1164	● 0258		● 0259	● 0260						
	SNMG 434 - UG	1/16	.008 ~ .016	.08 ~ .12	● 1165	● 0744	● 0789	● 1169							
-UC Cast iron and Medium roughing	SNMG 432 - UC	1/32	.008 ~ .016	.04 ~ .16	● 0073	● 0125		● 0106	● 0126						
	SNMG 433 - UC	3/64	.008 ~ .016	.06 ~ .18	● 0074	● 0127		● 0107	● 0128						

Cutting Speed			Vc (ft/min)																						
ISO	VDI	Sub Group	YG1001		YG3010		YG3015		YG3020		YG3030		YG801		YG211		YG213		YG214		YG100		YG10		
			Min	Max	Min	Max	Min	Max	Min	Max	Min	Max	Min	Max	Min	Max	Min	Max	Min	Max	Min	Max	Min	Max	
P	1~5	Non-Alloyed Steel	720	1570	560	1480	560	1340	590	1250	490	1150	390	660	-	-	-	-	-	-	-	-	-	-	-
	6~9	Low-Alloyed Steel	720	1380	590	1250	430	1180	360	1150	300	980	230	660	-	-	-	-	-	-	-	-	-	-	-
	10~11	High-Alloyed Steel	-	-	330	1080	260	1020	200	980	230	820	-	-	-	-	-	-	-	-	-	-	-	-	-
M	12~13	Ferritic & Martensitic	-	-	-	-	-	-	-	390	750	-	-	430	750	360	590	260	490	-	-	-	-	-	-
	14	Austenitic Stainless Steel	-	-	-	-	-	-	-	260	660	-	-	330	660	130	430	100	390	-	-	-	-	-	-
K	15~16	Grey Cast Iron	560	1380	390	980	-	-	-	-	-	-	-	-	-	-	-	-	-	-	-	-	-	-	-
	17~18	Nodular Cast Iron	390	1340	390	920	-	-	-	-	-	-	-	-	-	-	-	-	-	-	-	-	-	-	-
N	21~30	Non-Ferrous Metals (Al)	-	-	-	-	-	-	-	-	-	-	-	-	-	-	-	-	-	1150	3940	820	2620	-	-
S	31~37	Superalloys & Titanium	-	-	-	-	-	-	-	110	260	-	-	100	300	70	130	70	130	-	-	-	-	-	-
H	38~41	Hard Materials	-	-	-	-	-	-	-	-	-	-	-	-	-	-	-	-	-	-	-	-	-	-	-



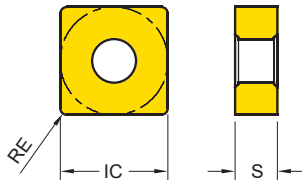

Turning Inserts - Negative SNMG / SNMA (90° Negative)



Series	IC	S
SN** 43	1/2	3/16

EDP 2200..

●: Stock item ○: Order made item

SNMA SNMG	Designation	RE (in)	Fn (in/rev)	Ap (in)	P05	P10	P15	P20	P30	P20	M15	M30	M40	N20	N20
					K10	K20	M20	S10	S20	S30	YG100	YG10			
-UR  Roughing	SNMG 432 - UR	1/32	.012 ~ .020	.04 ~ .18	●	●			●	●					
	SNMG 433 - UR	3/64	.012 ~ .020	.06 ~ .20	●	●			●	●					
	SNMG 434 - UR	1/16	.012 ~ .020	.08 ~ .20	●	●	●	●	●	●					
-MF  Stainless steel Finishing	SNMG 431 - MF	1/64	.003 ~ .012	.01 ~ .06							●	●	●		
	SNMG 432 - MF	1/32	.003 ~ .012	.01 ~ .06					●		●	●	●		
	SNMG 433 - MF	3/64	.003 ~ .012	.01 ~ .06					●		●	●	●		
-MM  Stainless steel Medium	SNMG 432 - MM	1/32	.008 ~ .014	.04 ~ .14							●	●	●		
	SNMG 433 - MM	3/64	.008 ~ .014	.06 ~ .14							●	●	●		
-MR  Stainless steel Roughing	SNMG 432 - MR	1/32	.012 ~ .022	.01 ~ .22					●		●	●	●		
	SNMG 433 - MR	3/64	.012 ~ .022	.01 ~ .22					●		●	●	●		
-KR  Cast Iron Heavy Roughing	SNMG 433 - KR	3/64	.012 ~ .024	.059 ~ .195	●	●									
	SNMG 434 - KR	1/16	.012 ~ .024	.08 ~ .20	●	●	●								

Cutting Speed			Vc (ft/min)											
ISO	VDI	Sub Group	YG1001	YG3010	YG3015	YG3020	YG3030	YG801	YG211	YG213	YG214	YG100	YG10	
			Min Max	Min Max	Min Max	Min Max	Min Max	Min Max	Min Max	Min Max	Min Max	Min Max	Min Max	Min Max
P	1~5	Non-Alloyed Steel	720 1570	560 1480	560 1340	590 1250	490 1150	390 660	- -	- -	- -	- -	- -	
	6~9	Low-Alloyed Steel	720 1380	590 1250	430 1180	360 1150	300 980	230 660	- -	- -	- -	- -	- -	
	10~11	High-Alloyed Steel	- -	330 1080	260 1020	200 980	230 820	- -	- -	- -	- -	- -	- -	
M	12~13	Ferritic & Martensitic	- -	- -	- -	- -	390 750	- -	430 750	360 590	260 490	- -	- -	
	14	Austenitic Stainless Steel	- -	- -	- -	- -	260 660	- -	330 660	130 430	100 390	- -	- -	
K	15~16	Grey Cast Iron	560 1380	390 980	- -	- -	- -	- -	- -	- -	- -	- -	- -	
	17~18	Nodular Cast Iron	390 1340	390 920	- -	- -	- -	- -	- -	- -	- -	- -	- -	
N	21~30	Non-Ferrous Metals (Al)	- -	- -	- -	- -	- -	- -	- -	- -	- -	1150 3940	820 2620	
S	31~37	Superalloys & Titanium	- -	- -	- -	- -	110 260	- -	100 300	70 130	70 130	- -	- -	
H	38~41	Hard Materials	- -	- -	- -	- -	- -	- -	- -	- -	- -	- -	- -	

Turning Inserts - Negative TNMG / TNMA (60° Negative)

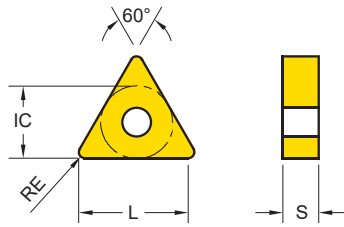

Series	L	IC	S
TN** 33	.618	3/8	3/16
TN** 43	.866	1/2	3/16

EDP 2200..

●: Stock item ○: Order made item

	Designation	RE (in)	Fn (in/rev)	Ap (in)	P05	P10	P15	P20	P30	P20	M15	M30	M40	N20	N20
					K10	K20	M20	S10	S20	S30	N20	N20			
TNMA TNMG					YG1001	YG3010	YG3015	YG3020	YG3030	YG801	YG211	YG213	YG214	YG100	YG10
	..MA				● 0035	● 1191									
	Cast iron	TNMA 332	1/32	.006 ~ .020	.04 ~ .12	○ 0036	○ 1192								
-UF															
	Finishing	TNMG 331 - UF	1/64	.002 ~ .010	.04 ~ .08		● 0270		● 0271	● 0272	● 0039				
		TNMG 332 - UF	1/32	.002 ~ .010	.06 ~ .14		● 0276		● 0277	● 0278					
		TNMG 333 - UF	3/64	.002 ~ .010	.06 ~ .14		● 0721		● 0588	● 1197					
-UL															
	Light Machining and Sticky Material	TNMG 332 - UL	1/32	.004 ~ .012	.04 ~ .12		● 0279	● 0752	● 0280	● 0281					
	TNMG 333 - UL	3/64	.004 ~ .012	.06 ~ .14		● 0884	● 0868	● 0621	● 1198						
-UM															
	Medium Machining Unstable condition	TNMG 331 - UM	1/64	.006 ~ .012	.02 ~ .12	● 0949	● 0948	● 0844	● 0952	● 0954					
		TNMG 332 - UM	1/32	.006 ~ .012	.02 ~ .08	● 1053	● 0282	● 0758	● 0283	● 0284					
	TNMG 333 - UM	3/64	.006 ~ .012	.06 ~ .12	● 0596	● 0597	● 0760	● 0586	● 0710						

Cutting Speed			Vc (ft/min)																					
ISO	VDI	Sub Group	YG1001		YG3010		YG3015		YG3020		YG3030		YG801		YG211		YG213		YG214		YG100		YG10	
			Min	Max	Min	Max	Min	Max	Min	Max	Min	Max	Min	Max	Min	Max	Min	Max	Min	Max	Min	Max	Min	Max
P	1~5	Non-Alloyed Steel	720	1570	560	1480	560	1340	590	1250	490	1150	390	660	-	-	-	-	-	-	-	-	-	-
	6~9	Low-Alloyed Steel	720	1380	590	1250	430	1180	360	1150	300	980	230	660	-	-	-	-	-	-	-	-	-	-
	10~11	High-Alloyed Steel	-	-	330	1080	260	1020	200	980	230	820	-	-	-	-	-	-	-	-	-	-	-	-
M	12~13	Ferritic & Martensitic	-	-	-	-	-	-	-	390	750	-	-	430	750	360	590	260	490	-	-	-	-	-
	14	Austenitic Stainless Steel	-	-	-	-	-	-	-	260	660	-	-	330	660	130	430	100	390	-	-	-	-	-
K	15~16	Grey Cast Iron	560	1380	390	980	-	-	-	-	-	-	-	-	-	-	-	-	-	-	-	-	-	-
	17~18	Nodular Cast Iron	390	1340	390	920	-	-	-	-	-	-	-	-	-	-	-	-	-	-	-	-	-	-
N	21~30	Non-Ferrous Metals (Al)	-	-	-	-	-	-	-	-	-	-	-	-	-	-	-	-	-	1150	3940	820	2620	
S	31~37	Superalloys & Titanium	-	-	-	-	-	-	-	110	260	-	-	100	300	70	130	70	130	-	-	-	-	
H	38~41	Hard Materials	-	-	-	-	-	-	-	-	-	-	-	-	-	-	-	-	-	-	-	-	-	

Turning Inserts - Negative

TNMG / TNMA (60° Negative)

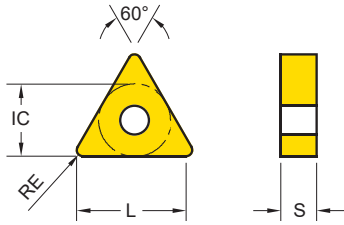

Series	L	IC	S
TN** 33	.618	3/8	3/16
TN** 43	.866	1/2	3/16

EDP 2200..

●: Stock item ○: Order made item

TNMA TNMG	Designation	RE (in)	Fn (in/rev)	Ap (in)	P05	P10	P15	P20	P30	P20	M15	M30	M40	N20	N20
					K10	K20	M20	S10	S20	S30	N20	N20			
-UG Medium Machining at stable condition	TNMG 331 - UG	1/64	.008 ~ .016	.02 ~ .08	●	●		●	●						
	TNMG 332 - UG	1/32	.008 ~ .016	.04 ~ .12	●	●	●	●	●	●					
	TNMG 333 - UG	3/64	.008 ~ .016	.06 ~ .12	●	●	●	●	●						
	TNMG 432 - UG	1/32	.010 ~ .024	.04 ~ .16	●	●	●	●	●	●					
	TNMG 434 - UG	1/16	.010 ~ .024	.08 ~ .24	●	●	●	●	●						
-UC Cast iron and Medium roughing	TNMG 331 - UC	1/64	.008 ~ .016	.02 ~ .10	●	●		●	●						
	TNMG 332 - UC	1/32	.008 ~ .016	.04 ~ .12	●	●		●	●						
	TNMG 333 - UC	3/64	.008 ~ .016	.06 ~ .14	●	●		●	●						
-UR Roughing	TNMG 332 - UR	1/32	.012 ~ .020	.04 ~ .20	●	●		●	●						
	TNMG 333 - UR	3/64	.012 ~ .020	.06 ~ .12	●	●	●	●	●	●					
	TNMG 433 - UR	3/64	.012 ~ .026	.06 ~ .16	●	●		●	●	●					
	TNMG 434 - UR	1/16	.012 ~ .026	.08 ~ .16	●	●		●	●						

Cutting Speed			Vc (ft/min)																						
ISO	VDI	Sub Group	YG1001		YG3010		YG3015		YG3020		YG3030		YG801		YG211		YG213		YG214		YG100		YG10		
			Min	Max	Min	Max	Min	Max	Min	Max	Min	Max	Min	Max	Min	Max	Min	Max	Min	Max	Min	Max	Min	Max	
P	1~5	Non-Alloyed Steel	720	1570	560	1480	560	1340	590	1250	490	1150	390	660	-	-	-	-	-	-	-	-	-	-	-
	6~9	Low-Alloyed Steel	720	1380	590	1250	430	1180	360	1150	300	980	230	660	-	-	-	-	-	-	-	-	-	-	-
	10~11	High-Alloyed Steel	-	-	330	1080	260	1020	200	980	230	820	-	-	-	-	-	-	-	-	-	-	-	-	-
M	12~13	Ferritic & Martensitic	-	-	-	-	-	-	-	390	750	-	-	430	750	360	590	260	490	-	-	-	-	-	-
	14	Austenitic Stainless Steel	-	-	-	-	-	-	-	260	660	-	-	330	660	130	430	100	390	-	-	-	-	-	-
K	15~16	Grey Cast Iron	560	1380	390	980	-	-	-	-	-	-	-	-	-	-	-	-	-	-	-	-	-	-	-
	17~18	Nodular Cast Iron	390	1340	390	920	-	-	-	-	-	-	-	-	-	-	-	-	-	-	-	-	-	-	-
N	21~30	Non-Ferrous Metals (Al)	-	-	-	-	-	-	-	-	-	-	-	-	-	-	-	-	-	-	1150	3940	820	2620	
S	31~37	Superalloys & Titanium	-	-	-	-	-	-	-	110	260	-	-	100	300	70	130	70	130	-	-	-	-	-	
H	38~41	Hard Materials	-	-	-	-	-	-	-	-	-	-	-	-	-	-	-	-	-	-	-	-	-	-	

Turning Inserts - Negative TNMG / TNMA (60° Negative)

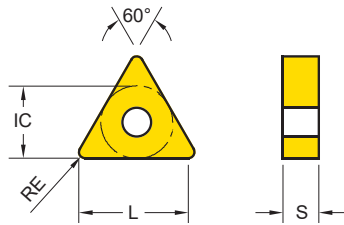

Series	L	IC	S
TN** 33	.618	3/8	3/16
TN** 43	.866	1/2	3/16

EDP 2200..

●: Stock item ○: Order made item

	TNMA TNMG	Designation	RE (in)	Fn (in/rev)	Ap (in)	P05	P10	P15	P20	P30	P20	M15	M30	M40	N20	N20
						K10	K20	M20	S10	S20	S30					
						YG1001	YG3010	YG3015	YG3020	YG3030	YG801	YG211	YG213	YG214	YG100	YG10
-MF		TNMG 331 - MF	1/64	.002 ~ .012	.01 ~ .06							● 0824	● 0775			
		TNMG 332 - MF	1/32	.002 ~ .012	.01 ~ .06							● 0589	● 0776	● 0825		
-MM		TNMG 331 - MM	1/64	.008 ~ .014	.02 ~ .12							● 0567	● 0568			
		TNMG 332 - MM	1/32	.006 ~ .012	.04 ~ .14							● 0569	● 0570	● 0913		
		TNMG 333 - MM	3/64	.006 ~ .012	.06 ~ .14							● 0611	● 0603			
-MR		TNMG 332 - MR	1/32	.012 ~ .022	.08 ~ .22					● 0727	● 0826	● 0985	● 0726			
		TNMG 333 - MR	3/64	.012 ~ .022	.08 ~ .22					● 1062	● 0995	● 0827	● 0828			

Cutting Speed			Vc (ft/min)											
ISO	VDI	Sub Group	YG1001	YG3010	YG3015	YG3020	YG3030	YG801	YG211	YG213	YG214	YG100	YG10	
			Min Max	Min Max	Min Max	Min Max	Min Max	Min Max	Min Max	Min Max	Min Max	Min Max	Min Max	Min Max
P	1~5	Non-Alloyed Steel	720 1570	560 1480	560 1340	590 1250	490 1150	390 660	- -	- -	- -	- -	- -	
	6~9	Low-Alloyed Steel	720 1380	590 1250	430 1180	360 1150	300 980	230 660	- -	- -	- -	- -	- -	
	10~11	High-Alloyed Steel	- -	330 1080	260 1020	200 980	230 820	- -	- -	- -	- -	- -	- -	
M	12~13	Ferritic & Martensitic	- -	- -	- -	- -	390 750	- -	430 750	360 590	260 490	- -	- -	
	14	Austenitic Stainless Steel	- -	- -	- -	- -	260 660	- -	330 660	130 430	100 390	- -	- -	
K	15~16	Grey Cast Iron	560 1380	390 980	- -	- -	- -	- -	- -	- -	- -	- -	- -	
	17~18	Nodular Cast Iron	390 1340	390 920	- -	- -	- -	- -	- -	- -	- -	- -	- -	
N	21~30	Non-Ferrous Metals (Al)	- -	- -	- -	- -	- -	- -	- -	- -	- -	1150 3940	820 2620	
S	31~37	Superalloys & Titanium	- -	- -	- -	- -	110 260	- -	100 300	70 130	70 130	- -	- -	
H	38~41	Hard Materials	- -	- -	- -	- -	- -	- -	- -	- -	- -	- -	- -	

Turning Inserts - Negative TNUX (60° Negative)

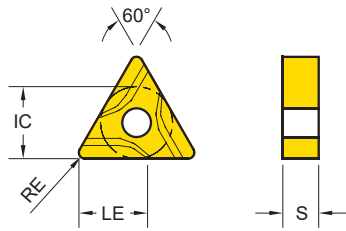

Series	LE	IC	S
TNUX 33	.370	3/8	3/16

EDP 2200..

●: Stock item ○: Order made item

TNUX	Designation	RE (in)	Fn (in/rev)	Ap (in)	P05	P10	P15	P20	P30	P20	M15	M30	M40	N20	N20
					K10	K20	M20	S10	S20	S30					
..UX Left	TNUX 331 L	1/64	.004~.012	.02~.16	●	○		●	●	●					
	TNUX 332 L	1/32	.004~.016	.02~.24	○	○		●	●	●	●				
					○	○		●	●	●	●				
					○	○		●	●	●	●				
..UX Right	TNUX 331 R	1/64	.004~.012	.02~.16	○	○		●	●	●					
	TNUX 332 R	1/32	.004~.016	.02~.24	○	○		●	●	●	●				
					○	○		●	●	●	●				
					○	○		●	●	●	●				

Cutting Speed			Vc (ft/min)																						
ISO	VDI	Sub Group	YG1001		YG3010		YG3015		YG3020		YG3030		YG801		YG211		YG213		YG214		YG100		YG10		
			Min	Max	Min	Max	Min	Max	Min	Max	Min	Max	Min	Max	Min	Max	Min	Max	Min	Max	Min	Max	Min	Max	
P	1~5	Non-Alloyed Steel	720	1570	560	1480	560	1340	590	1250	490	1150	390	660	-	-	-	-	-	-	-	-	-	-	-
	6~9	Low-Alloyed Steel	720	1380	590	1250	430	1180	360	1150	300	980	230	660	-	-	-	-	-	-	-	-	-	-	-
	10~11	High-Alloyed Steel	-	-	330	1080	260	1020	200	980	230	820	-	-	-	-	-	-	-	-	-	-	-	-	-
M	12~13	Ferritic & Martensitic	-	-	-	-	-	-	-	390	750	-	-	430	750	360	590	260	490	-	-	-	-	-	-
	14	Austenitic Stainless Steel	-	-	-	-	-	-	-	260	660	-	-	330	660	130	430	100	390	-	-	-	-	-	-
K	15~16	Grey Cast Iron	560	1380	390	980	-	-	-	-	-	-	-	-	-	-	-	-	-	-	-	-	-	-	-
	17~18	Nodular Cast Iron	390	1340	390	920	-	-	-	-	-	-	-	-	-	-	-	-	-	-	-	-	-	-	-
N	21~30	Non-Ferrous Metals (Al)	-	-	-	-	-	-	-	-	-	-	-	-	-	-	-	-	-	-	1150	3940	820	2620	
S	31~37	Superalloys & Titanium	-	-	-	-	-	-	-	110	260	-	-	100	300	70	130	70	130	-	-	-	-	-	
H	38~41	Hard Materials	-	-	-	-	-	-	-	-	-	-	-	-	-	-	-	-	-	-	-	-	-	-	

Turning Inserts - Negative VNMG / VNMA (35° Negative)

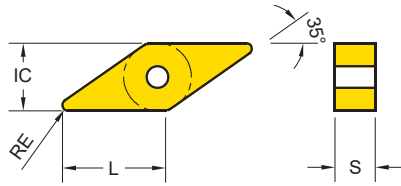

Series	L	IC	S
VN** 33	.622	3/8	3/16

EDP 2200..

●: Stock item ○: Order made item

	Designation	RE (in)	Fn (in/rev)	Ap (in)	P05	P10	P15	P20	P30	P20	M15	M30	M40	N20	N20
					K10	K20	M20	S10	S20	S30					
..MA Cast iron	VNMA 332	1/32	.006~.020	.04~.12	● 0162	● 1275									
	VNMG 331 - UF	1/64	.002~.010	.02~.08		● 0306		● 0307	● 0308	● 0049					
-UF Finishing	VNMG 332 - UF	1/32	.002~.010	.04~.10		● 0309		● 0310	● 0311						
	VNMG 331 - UL	1/64	.004~.012	.02~.12		● 0886		● 0912	● 0723						
-UL Light Machining and Sticky Material	VNMG 332 - UL	1/32	.004~.012	.04~.10		● 0428	● 0790	● 0429							
	VNMG 333 - UM	3/64	.006~.012	.06~.12	● 1230	● 0736	● 0870	● 0737	● 1214						
-UM Medium Machining Unstable condition	VNMG 331 - UG	1/64	.008~.016	.02~.12		● 0993		● 0940	● 0994						
	VNMG 332 - UG	1/32	.008~.016	.04~.12	● 0462	● 0312		● 0313	● 0314	● 0050					
	VNMG 333 - UG	3/64	.008~.016	.06~.12		● 0931		● 0927	● 0917						

Cutting Speed			Vc (ft/min)																						
ISO	VDI	Sub Group	YG1001		YG3010		YG3015		YG3020		YG3030		YG801		YG211		YG213		YG214		YG100		YG10		
			Min	Max	Min	Max	Min	Max	Min	Max	Min	Max	Min	Max	Min	Max	Min	Max	Min	Max	Min	Max	Min	Max	
P	1~5	Non-Alloyed Steel	720	1570	560	1480	560	1340	590	1250	490	1150	390	660	-	-	-	-	-	-	-	-	-	-	-
	6~9	Low-Alloyed Steel	720	1380	590	1250	430	1180	360	1150	300	980	230	660	-	-	-	-	-	-	-	-	-	-	-
	10~11	High-Alloyed Steel	-	-	330	1080	260	1020	200	980	230	820	-	-	-	-	-	-	-	-	-	-	-	-	-
M	12~13	Ferritic & Martensitic	-	-	-	-	-	-	-	390	750	-	-	430	750	360	590	260	490	-	-	-	-	-	-
	14	Austenitic Stainless Steel	-	-	-	-	-	-	-	260	660	-	-	330	660	130	430	100	390	-	-	-	-	-	-
K	15~16	Grey Cast Iron	560	1380	390	980	-	-	-	-	-	-	-	-	-	-	-	-	-	-	-	-	-	-	-
	17~18	Nodular Cast Iron	390	1340	390	920	-	-	-	-	-	-	-	-	-	-	-	-	-	-	-	-	-	-	-
N	21~30	Non-Ferrous Metals (Al)	-	-	-	-	-	-	-	-	-	-	-	-	-	-	-	-	-	-	1150	3940	820	2620	
S	31~37	Superalloys & Titanium	-	-	-	-	-	-	-	110	260	-	-	100	300	70	130	70	130	-	-	-	-	-	
H	38~41	Hard Materials	-	-	-	-	-	-	-	-	-	-	-	-	-	-	-	-	-	-	-	-	-	-	



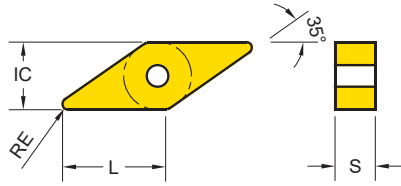

Turning Inserts - Negative VNMG / VNMA (35° Negative)



Series	L	IC	S
VN** 33	.622	3/8	3/16

EDP 2200..

●: Stock item ○: Order made item

VNMG	Designation	RE (in)	Fn (in/rev)	Ap (in)	P05	P10	P15	P20	P30	P20	M15	M30	M40	N20	N20
					K10	K20	M20	S10	S20	S30	YG100	YG10			
-UC  Cast iron and Medium roughing	VNMG 331 - UC	1/64	.008 ~ .016	.02 ~ .10	●	●			●	●					
	VNMG 332 - UC	1/32	.008 ~ .016	.04 ~ .12	●	●			●	●					
-UR  Roughing	VNMG 333 - UR	3/64	.012 ~ .020	.05 ~ .12	●	●	●	●	●	●					
	VNMG 332 - MF	1/32	.002 ~ .012	.01 ~ .06					●	●	●				
-MF  Stainless steel Finishing	VNMG 331 - MM	1/64	.008 ~ .014	.02 ~ .14							●	●			
	VNMG 332 - MM	1/32	.008 ~ .014	.02 ~ .14							●	●			
-MM  Stainless steel Medium	VNMG 332 - MR	1/32	.012 ~ .022	.08 ~ .22					●	●	●				
	VNMG 331 - MR	1/64	.008 ~ .014	.02 ~ .14							●	●			

Cutting Speed			Vc (ft/min)																						
ISO	VDI	Sub Group	YG1001		YG3010		YG3015		YG3020		YG3030		YG801		YG211		YG213		YG214		YG100		YG10		
			Min	Max	Min	Max	Min	Max	Min	Max	Min	Max	Min	Max	Min	Max	Min	Max	Min	Max	Min	Max	Min	Max	
P	1~5	Non-Alloyed Steel	720	1570	560	1480	560	1340	590	1250	490	1150	390	660	-	-	-	-	-	-	-	-	-	-	-
	6~9	Low-Alloyed Steel	720	1380	590	1250	430	1180	360	1150	300	980	230	660	-	-	-	-	-	-	-	-	-	-	-
	10~11	High-Alloyed Steel	-	-	330	1080	260	1020	200	980	230	820	-	-	-	-	-	-	-	-	-	-	-	-	-
M	12~13	Ferritic & Martensitic	-	-	-	-	-	-	-	390	750	-	-	430	750	360	590	260	490	-	-	-	-	-	-
	14	Austenitic Stainless Steel	-	-	-	-	-	-	-	260	660	-	-	330	660	130	430	100	390	-	-	-	-	-	-
K	15~16	Grey Cast Iron	560	1380	390	980	-	-	-	-	-	-	-	-	-	-	-	-	-	-	-	-	-	-	
	17~18	Nodular Cast Iron	390	1340	390	920	-	-	-	-	-	-	-	-	-	-	-	-	-	-	-	-	-	-	
N	21~30	Non-Ferrous Metals (Al)	-	-	-	-	-	-	-	-	-	-	-	-	-	-	-	-	-	1150	3940	820	2620	-	
S	31~37	Superalloys & Titanium	-	-	-	-	-	-	-	110	260	-	-	100	300	70	130	70	130	-	-	-	-	-	
H	38~41	Hard Materials	-	-	-	-	-	-	-	-	-	-	-	-	-	-	-	-	-	-	-	-	-	-	

Turning Inserts - Negative

WNMG / WNMA (80° Trigonal Negative)

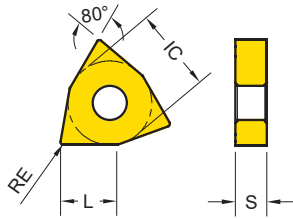

Series	L	IC	S
WN** 33	.224	3/8	3/16
WN** 43	.307	1/2	3/16

EDP 2200..

●: Stock item ○: Order made item

	Designation	RE (in)	Fn (in/rev)	Ap (in)	P05	P10	P15	P20	P30	P20	M15	M30	M40	N20	N20
					K10	K20			M20		S10	S20	S30		
WNMA Cast iron	WNMA 431	1/64	.006 ~ .020	.02 ~ .10	●	●									
	WNMA 432	1/32	.006 ~ .020	.04 ~ .14	●	●									
	WNMA 433	3/64	.006 ~ .020	.06 ~ .20	●	●									
-UF Finishing	WNMG 331 - UF	1/64	.002 ~ .010	.02 ~ .06		●			●	●	●				
	WNMG 431 - UF	1/64	.002 ~ .010	.02 ~ .08		●			●	●	●				
	WNMG 432 - UF	1/32	.002 ~ .010	.04 ~ .10		●			●	●	●				
-UL Light Machining and Sticky Material	WNMG 332 - UL	1/32	.004 ~ .012	.04 ~ .10		●			●	●					
	WNMG 432 - UL	1/32	.004 ~ .012	.04 ~ .12		●			●	●					
-UM Medium Machining Unstable condition	WNMG 331 - UM	1/64	.006 ~ .012	.04 ~ .10	●	●			●	●					
	WNMG 332 - UM	1/32	.006 ~ .012	.04 ~ .08	●	●			●	●					
	WNMG 431 - UM	1/64	.006 ~ .012	.02 ~ .12		●			●	●					
	WNMG 432 - UM	1/32	.006 ~ .012	.04 ~ .12	●	●	●		●	●	●				
	WNMG 433 - UM	3/64	.006 ~ .012	.06 ~ .12	●	●	●		●	●	●				
	WNMG 434 - UM	1/16	.006 ~ .012	.08 ~ .14	●	●	●		●	●					

Cutting Speed			Vc (ft/min)																						
ISO	VDI	Sub Group	YG1001		YG3010		YG3015		YG3020		YG3030		YG801		YG211		YG213		YG214		YG100		YG10		
			Min	Max	Min	Max	Min	Max	Min	Max	Min	Max	Min	Max	Min	Max	Min	Max	Min	Max	Min	Max	Min	Max	
P	1~5	Non-Alloyed Steel	720	1570	560	1480	560	1340	590	1250	490	1150	390	660	-	-	-	-	-	-	-	-	-	-	-
	6~9	Low-Alloyed Steel	720	1380	590	1250	430	1180	360	1150	300	980	230	660	-	-	-	-	-	-	-	-	-	-	-
	10~11	High-Alloyed Steel	-	-	330	1080	260	1020	200	980	230	820	-	-	-	-	-	-	-	-	-	-	-	-	-
M	12~13	Ferritic & Martensitic	-	-	-	-	-	-	-	-	390	750	-	-	430	750	360	590	260	490	-	-	-	-	
	14	Austenitic Stainless Steel	-	-	-	-	-	-	-	-	260	660	-	-	330	660	130	430	100	390	-	-	-	-	
K	15~16	Grey Cast Iron	560	1380	390	980	-	-	-	-	-	-	-	-	-	-	-	-	-	-	-	-	-	-	
	17~18	Nodular Cast Iron	390	1340	390	920	-	-	-	-	-	-	-	-	-	-	-	-	-	-	-	-	-	-	
N	21~30	Non-Ferrous Metals (Al)	-	-	-	-	-	-	-	-	-	-	-	-	-	-	-	-	-	-	1150	3940	820	2620	
S	31~37	Superalloys & Titanium	-	-	-	-	-	-	-	-	110	260	-	-	100	300	70	130	70	130	-	-	-	-	
H	38~41	Hard Materials	-	-	-	-	-	-	-	-	-	-	-	-	-	-	-	-	-	-	-	-	-	-	

Turning Inserts - Negative WNMG / WNMA (80° Trigonal Negative)

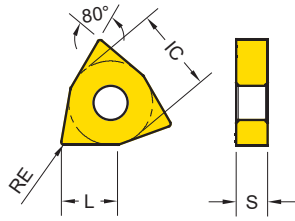

Series	L	IC	S
WN** 33	.224	3/8	3/16
WN** 43	.307	1/2	3/16

TURNING

PARTING & GROOVING



MILLING

DRILLING

TECHNICAL INFORMATION

EDP 2200..

●: Stock item ○: Order made item

WNMA WNMG	Designation	RE (in)	Fn (in/rev)	Ap (in)	P05	P10	P15	P20	P30	P20	M15	M30	M40	N20	N20
					K10	K20	M20	S10	S20	S30	YG100	YG10			
-UG  Medium Machining at stable condition	WNMG 332 - UG	1/32	.008 ~ .016	.04 ~ .10	●	●		●	●	●					
	WNMG 431 - UG	1/64	.008 ~ .016	.06 ~ .10	●	●		●	●	●					
	WNMG 432 - UG	1/32	.008 ~ .016	.04 ~ .14	●	●	●	●	●	●	●				
	WNMG 433 - UG	3/64	.008 ~ .016	.06 ~ .14	●	●	●	●	●	●	●				
	WNMG 434 - UG	1/16	.008 ~ .016	.08 ~ .16	●	●	●	●	●	●	●				
-UC  Cast iron and Medium roughing	WNMG 332 - UC	1/32	.008 ~ .016	.04 ~ .12	●	●		●	●	●					
	WNMG 431 - UC	1/64	.010 ~ .016	.02 ~ .14	●	●		●	●	●					
	WNMG 432 - UC	1/32	.008 ~ .016	.04 ~ .16	●	●	●	●	●	●					
	WNMG 433 - UC	3/64	.008 ~ .016	.06 ~ .18	●	●	●	●	●	●					
	WNMG 434 - UC	1/16	.008 ~ .016	.08 ~ .16	●	●		●	●	●					
-UR  Roughing	WNMG 333 - UR	3/64	.012 ~ .020	.06 ~ .12	●	●		●	●	●					
	WNMG 432 - UR	1/32	.012 ~ .020	.05 ~ .20	●	●		●	●	●					
	WNMG 433 - UR	3/64	.012 ~ .020	.06 ~ .20	●	●	●	●	●	●	●				
	WNMG 434 - UR	1/16	.012 ~ .020	.08 ~ .20	●	●	●	●	●	●	●				

Cutting Speed			Vc (ft/min)																						
ISO	VDI	Sub Group	YG1001		YG3010		YG3015		YG3020		YG3030		YG801		YG211		YG213		YG214		YG100		YG10		
			Min	Max	Min	Max	Min	Max	Min	Max	Min	Max	Min	Max	Min	Max	Min	Max	Min	Max	Min	Max	Min	Max	
P	1~5	Non-Alloyed Steel	720	1570	560	1480	560	1340	590	1250	490	1150	390	660	-	-	-	-	-	-	-	-	-	-	-
	6~9	Low-Alloyed Steel	720	1380	590	1250	430	1180	360	1150	300	980	230	660	-	-	-	-	-	-	-	-	-	-	-
	10~11	High-Alloyed Steel	-	-	330	1080	260	1020	200	980	230	820	-	-	-	-	-	-	-	-	-	-	-	-	-
M	12~13	Ferritic & Martensitic	-	-	-	-	-	-	-	390	750	-	-	430	750	360	590	260	490	-	-	-	-	-	-
	14	Austenitic Stainless Steel	-	-	-	-	-	-	-	260	660	-	-	330	660	130	430	100	390	-	-	-	-	-	-
K	15~16	Grey Cast Iron	560	1380	390	980	-	-	-	-	-	-	-	-	-	-	-	-	-	-	-	-	-	-	-
	17~18	Nodular Cast Iron	390	1340	390	920	-	-	-	-	-	-	-	-	-	-	-	-	-	-	-	-	-	-	-
N	21~30	Non-Ferrous Metals (Al)	-	-	-	-	-	-	-	-	-	-	-	-	-	-	-	-	-	-	1150	3940	820	2620	
S	31~37	Superalloys & Titanium	-	-	-	-	-	-	-	110	260	-	-	100	300	70	130	70	130	-	-	-	-	-	
H	38~41	Hard Materials	-	-	-	-	-	-	-	-	-	-	-	-	-	-	-	-	-	-	-	-	-	-	

Turning Inserts - Negative



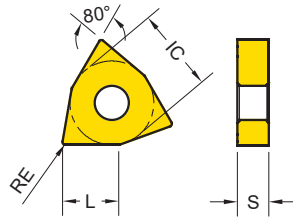

WNMG / WNMA (80° Trigonal Negative)



Series	L	IC	S
WN** 33	.224	3/8	3/16
WN** 43	.307	1/2	3/16

EDP 2200..

●: Stock item ○: Order made item

	Designation	RE (in)	Fn (in/rev)	Ap (in)	P05	P10	P15	P20	P30	P20	M15	M30	M40	N20	N20
					K10	K20	M20	S10	S20	S30					
WNMA WNMG -MF  Stainless steel Finishing	WNMG 331 - MF	1/64	.003 ~ .012	.01 ~ .06		○ 0833					● 0996	● 1215	● 1217		
	WNMG 332 - MF	1/32	.003 ~ .012	.02 ~ .08								● 1216	● 1218		
	WNMG 431 - MF	1/64	.003 ~ .012	.01 ~ .06							● 0834	● 0667	● 0668	● 0970	
	WNMG 432 - MF	1/32	.003 ~ .012	.01 ~ .06								● 0617	● 0618		
-MM  Stainless steel Medium	WNMG 431 - MM	1/64	.008 ~ .014	.02 ~ .14							● 0571	● 0572			
	WNMG 432 - MM	1/32	.008 ~ .014	.04 ~ .14					● 0491		● 0497	● 0498			
	WNMG 433 - MM	3/64	.008 ~ .014	.06 ~ .14							● 0612	● 0615			
-MR  Stainless steel Roughing	WNMG 333 - MR	3/64	.008 ~ .020	.05 ~ .16							● 0616				
	WNMG 432 - MR	1/32	.012 ~ .022	.08 ~ .22							● 0619	● 0620	● 0835		
	WNMG 433 - MR	3/64	.012 ~ .022	.08 ~ .22					● 0837		● 0665	● 0666	● 0836		
-KR  Cast Iron Heavy Roughing	WNMG 432 - KR	1/32	.012 ~ .024	.04 ~ .20	● 0720	● 1038									
	WNMG 433 - KR	3/64	.012 ~ .024	.06 ~ .20	● 0522	● 0542									

Cutting Speed			Vc (ft/min)											
ISO	VDI	Sub Group	YG1001	YG3010	YG3015	YG3020	YG3030	YG801	YG211	YG213	YG214	YG100	YG10	
			Min Max	Min Max	Min Max	Min Max	Min Max	Min Max	Min Max	Min Max	Min Max	Min Max	Min Max	Min Max
P	1~5	Non-Alloyed Steel	720 1570	560 1480	560 1340	590 1250	490 1150	390 660	- -	- -	- -	- -	- -	
	6~9	Low-Alloyed Steel	720 1380	590 1250	430 1180	360 1150	300 980	230 660	- -	- -	- -	- -	- -	
	10~11	High-Alloyed Steel	- -	330 1080	260 1020	200 980	230 820	- -	- -	- -	- -	- -	- -	
M	12~13	Ferritic & Martensitic	- -	- -	- -	- -	390 750	- -	430 750	360 590	260 490	- -	- -	
	14	Austenitic Stainless Steel	- -	- -	- -	- -	260 660	- -	330 660	130 430	100 390	- -	- -	
K	15~16	Grey Cast Iron	560 1380	390 980	- -	- -	- -	- -	- -	- -	- -	- -	- -	
	17~18	Nodular Cast Iron	390 1340	390 920	- -	- -	- -	- -	- -	- -	- -	- -	- -	
N	21~30	Non-Ferrous Metals (Al)	- -	- -	- -	- -	- -	- -	- -	- -	- -	1150 3940	820 2620	
S	31~37	Superalloys & Titanium	- -	- -	- -	- -	110 260	- -	100 300	70 130	70 130	- -	- -	
H	38~41	Hard Materials	- -	- -	- -	- -	- -	- -	- -	- -	- -	- -	- -	

Turning Inserts - Positive

CCMT / CCGT (80° Positive)

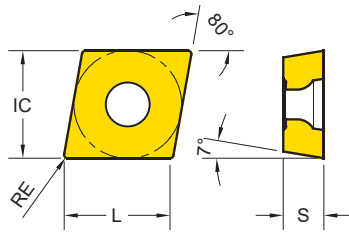

Series	L	IC	S
CC** 21.5	.244	1/4	3/32
CC** 32.5	.362	3/8	5/32
CC** 43	.488	1/2	3/16

EDP 2200..

●: Stock item ○: Order made item

CCGT CCMT	Designation	RE (in)	Fn (in/rev)	Ap (in)	P05	P10	P15	P20	P30	P20	M15	M30	M40	N20	N20
					K10	K20	M20	S10	S20	S30	N20	N20			
-AL Aluminum	CCGT 32.50.5 - AL	1/128	.001 ~ .003	.02 ~ .04										●	●
	CCGT 32.51 - AL	1/64	.002 ~ .010	.02 ~ .08										●	●
	CCGT 32.52 - AL	1/32	.004 ~ .014	.04 ~ .12										●	●
	CCGT 430.5 - AL	1/128	.002 ~ .006	.00 ~ .04										●	●
	CCGT 431 - AL	1/64	.002 ~ .008	.01 ~ .06										●	●
	CCGT 432 - AL	1/32	.002 ~ .008	.02 ~ .10										●	●
-UF Finishing	CCMT 21.51 - UF	1/64	.002 ~ .008	.02 ~ .06		●	●	●	●						
	CCMT 32.51 - UF	1/64	.002 ~ .008	.02 ~ .08		●		●	●						
	CCMT 32.52 - UF	1/32	.002 ~ .010	.04 ~ .08		●		●	●						
-UG General	CCMT 21.51 - UG	1/64	.004 ~ .010	.02 ~ .08		●		●	●	●					
	CCMT 21.52 - UG	1/32	.004 ~ .010	.03 ~ .08		●		●	●	●					
	CCMT 32.51 - UG	1/64	.006 ~ .012	.02 ~ .08		●		●	●	●					
	CCMT 32.52 - UG	1/32	.006 ~ .012	.03 ~ .10		●		●	●	●					
	CCMT 431 - UG	1/64	.006 ~ .014	.02 ~ .10		●		●	●						
	CCMT 432 - UG	1/32	.006 ~ .014	.03 ~ .14		●	●	●	●	●					
	CCMT 433 - UG	3/64	.006 ~ .014	.05 ~ .14		●		●	●	●					

Cutting Speed			Vc (ft/min)											
ISO	VDI	Sub Group	YG1001	YG3010	YG3015	YG3020	YG3030	YG801	YG211	YG213	YG214	YG100	YG10	
			Min Max	Min Max	Min Max	Min Max	Min Max	Min Max	Min Max	Min Max	Min Max	Min Max	Min Max	Min Max
P	1~5	Non-Alloyed Steel	720 1570	560 1480	560 1340	590 1250	490 1150	390 660	- -	- -	- -	- -	- -	
	6~9	Low-Alloyed Steel	720 1380	590 1250	430 1180	360 1150	300 980	230 660	- -	- -	- -	- -	- -	
	10~11	High-Alloyed Steel	- -	330 1080	260 1020	200 980	230 820	- -	- -	- -	- -	- -	- -	
M	12~13	Ferritic & Martensitic	- -	- -	- -	- -	390 750	- -	430 750	360 590	260 490	- -	- -	
	14	Austenitic Stainless Steel	- -	- -	- -	- -	260 660	- -	330 660	130 430	100 390	- -	- -	
K	15~16	Grey Cast Iron	560 1380	390 980	- -	- -	- -	- -	- -	- -	- -	- -	- -	
	17~18	Nodular Cast Iron	390 1340	390 920	- -	- -	- -	- -	- -	- -	- -	- -	- -	
N	21~30	Non-Ferrous Metals (Al)	- -	- -	- -	- -	- -	- -	- -	- -	- -	1150 3940	820 2620	
S	31~37	Superalloys & Titanium	- -	- -	- -	- -	110 260	- -	100 300	70 130	70 130	- -	- -	
H	38~41	Hard Materials	- -	- -	- -	- -	- -	- -	- -	- -	- -	- -	- -	

Turning Inserts - Positive

DCMT / DCGT (55° Positive)

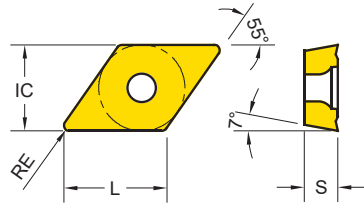

Series	L	IC	S
DC** 21.5	.295	1/4	3/32
DC** 32.5	.441	3/8	5/32

EDP 2200..

●: Stock item ○: Order made item

DCGT DCMT	Designation	RE (in)	Fn (in/rev)	Ap (in)	P05	P10	P15	P20	P30	P20	M15	M30	M40	N20	N20	
					K10	K20	M20	S10	S20	S30	YG100	YG10				
-AL Aluminum	DCGT 32.50.5 - AL	1/128	.001 ~ .003	.02 ~ .04											● 0342	● 0341
	DCGT 32.51 - AL	1/64	.002 ~ .010	.02 ~ .08											● 0332	● 0083
	DCGT 32.52 - AL	1/32	.004 ~ .012	.04 ~ .10											● 0333	● 0084
-UF Finishing	DCMT 21.51 - UF	1/64	.002 ~ .008	.02 ~ .06		● 0207		● 0208	● 0209							
	DCMT 32.51 - UF	1/64	.002 ~ .010	.02 ~ .08		● 0213		● 0214	● 0215							
	DCMT 32.52 - UF	1/32	.002 ~ .010	.04 ~ .10		● 0219		● 0220	● 0221							
-UG General	DCMT 21.51 - UG	1/64	.004 ~ .010	.02 ~ .06		● 0210		● 0211	● 0212	● 0013						
	DCMT 21.52 - UG	1/32	.004 ~ .010	.03 ~ .06		● 0484		● 0717	● 1136							
	DCMT 32.51 - UG	1/64	.006 ~ .012	.02 ~ .08	● 0677	● 0216		● 0217	● 0218	● 0014						
	DCMT 32.52 - UG	1/32	.006 ~ .012	.03 ~ .10	● 0678	● 0222		● 0223	● 0224	● 0015						

Cutting Speed			Vc (ft/min)																						
ISO	VDI	Sub Group	YG1001		YG3010		YG3015		YG3020		YG3030		YG801		YG211		YG213		YG214		YG100		YG10		
			Min	Max	Min	Max	Min	Max	Min	Max	Min	Max	Min	Max	Min	Max	Min	Max	Min	Max	Min	Max	Min	Max	
P	1~5	Non-Alloyed Steel	720	1570	560	1480	560	1340	590	1250	490	1150	390	660	-	-	-	-	-	-	-	-	-	-	-
	6~9	Low-Alloyed Steel	720	1380	590	1250	430	1180	360	1150	300	980	230	660	-	-	-	-	-	-	-	-	-	-	-
	10~11	High-Alloyed Steel	-	-	330	1080	260	1020	200	980	230	820	-	-	-	-	-	-	-	-	-	-	-	-	-
M	12~13	Ferritic & Martensitic	-	-	-	-	-	-	-	-	390	750	-	-	430	750	360	590	260	490	-	-	-	-	-
	14	Austenitic Stainless Steel	-	-	-	-	-	-	-	-	260	660	-	-	330	660	130	430	100	390	-	-	-	-	-
K	15~16	Grey Cast Iron	560	1380	390	980	-	-	-	-	-	-	-	-	-	-	-	-	-	-	-	-	-	-	-
	17~18	Nodular Cast Iron	390	1340	390	920	-	-	-	-	-	-	-	-	-	-	-	-	-	-	-	-	-	-	-
N	21~30	Non-Ferrous Metals (Al)	-	-	-	-	-	-	-	-	-	-	-	-	-	-	-	-	-	-	1150	3940	820	2620	
S	31~37	Superalloys & Titanium	-	-	-	-	-	-	-	-	110	260	-	-	100	300	70	130	70	130	-	-	-	-	
H	38~41	Hard Materials	-	-	-	-	-	-	-	-	-	-	-	-	-	-	-	-	-	-	-	-	-	-	

Turning Inserts - Positive

RCMT (Round Positive)

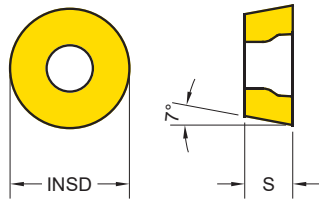

Series	INSD	S
RC** 0602	.236	3/32
RC** 0803	.315	1/8
RC** 10T3	.394	5/32
RC** 1204	.472	3/16

EDP 2200..

●: Stock item ○: Order made item

P05	P10	P15	P20	P30	P20	M15	M30	M40	N20	N20
K10	K20			M20		S10	S20	S30		
YG1001	YG3010	YG3015	YG3020	YG3030	YG801	YG211	YG213	YG214	YG100	YG10
●	●		●	●	●					
○0374	○0375		○0376	○1151	○0023					
●	●		●	●	●					
○0377	○0378		○0379	○1152	○0024					
●	●		●	●	●					
○0380	○0381		○0382	○1153	○0021					
●	●		●	●	●					
○0383	○0384		○0385	○1170	○0022					

RCMT	Designation	RE (in)	Fn (in/rev)	Ap (in)	YG1001	YG3010	YG3015	YG3020	YG3030	YG801	YG211	YG213	YG214	YG100	YG10
<p>General</p>	RCMT 0602M0	.118	.002 ~ .010	.01 ~ .05	●	●		●	●	●					
	RCMT 0803M0	.157	.002 ~ .012	.02 ~ .06	●	●		●	●	●					
	RCMT 10T3M0	.197	.004 ~ .014	.02 ~ .10	●	●		●	●	●					
	RCMT 1204M0	.236	.006 ~ .018	.02 ~ .12	●	●		●	●	●					

Cutting Speed			Vc (ft/min)																					
ISO	VDI	Sub Group	YG1001		YG3010		YG3015		YG3020		YG3030		YG801		YG211		YG213		YG214		YG100		YG10	
			Min	Max	Min	Max	Min	Max	Min	Max	Min	Max	Min	Max	Min	Max	Min	Max	Min	Max	Min	Max	Min	Max
P	1~5	Non-Alloyed Steel	720	1570	560	1480	560	1340	590	1250	490	1150	390	660	-	-	-	-	-	-	-	-	-	-
	6~9	Low-Alloyed Steel	720	1380	590	1250	430	1180	360	1150	300	980	230	660	-	-	-	-	-	-	-	-	-	-
	10~11	High-Alloyed Steel	-	-	330	1080	260	1020	200	980	230	820	-	-	-	-	-	-	-	-	-	-	-	-
M	12~13	Ferritic & Martensitic	-	-	-	-	-	-	-	390	750	-	-	430	750	360	590	260	490	-	-	-	-	-
	14	Austenitic Stainless Steel	-	-	-	-	-	-	-	260	660	-	-	330	660	130	430	100	390	-	-	-	-	-
K	15~16	Grey Cast Iron	560	1380	390	980	-	-	-	-	-	-	-	-	-	-	-	-	-	-	-	-	-	-
	17~18	Nodular Cast Iron	390	1340	390	920	-	-	-	-	-	-	-	-	-	-	-	-	-	-	-	-	-	-
N	21~30	Non-Ferrous Metals (Al)	-	-	-	-	-	-	-	-	-	-	-	-	-	-	-	-	-	1150	3940	820	2620	
S	31~37	Superalloys & Titanium	-	-	-	-	-	-	-	110	260	-	-	100	300	70	130	70	130	-	-	-	-	
H	38~41	Hard Materials	-	-	-	-	-	-	-	-	-	-	-	-	-	-	-	-	-	-	-	-	-	

Turning Inserts - Positive SCMT (Square Positive)

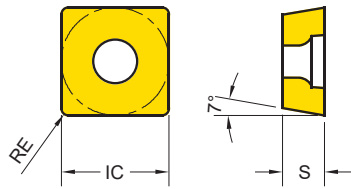

Series	IC	S
SC** 32.5	3/8	5/32
SC** 43	1/2	3/16

EDP 2200..

●: Stock item ○: Order made item

SCMT	Designation	RE (in)	Fn (in/rev)	Ap (in)	P05	P10	P15	P20	P30	P20	M15	M30	M40	N20	N20
					K10	K20	M20	S10	S20	S30					
-UF Finishing	SCMT 32.51 - UF	1/64	.002 ~ .010	.02 ~ .08	●	●		●	●						
	SCMT 32.52 - UF	1/32	.002 ~ .010	.04 ~ .08	●	●		●	●						
	SCMT 432 - UF	1/32	.006 ~ .012	.04 ~ .10	●	●		●	●						
-UG General	SCMT 32.51 - UG	1/64	.006 ~ .012	.04 ~ .10	●	●		●	●	●					
	SCMT 32.52 - UG	1/32	.006 ~ .012	.04 ~ .10	●	●		●	●	●					
	SCMT 432 - UG	1/32	.006 ~ .014	.04 ~ .14	●	●		●	●						

Cutting Speed			Vc (ft/min)																						
ISO	VDI	Sub Group	YG1001		YG3010		YG3015		YG3020		YG3030		YG801		YG211		YG213		YG214		YG100		YG10		
			Min	Max	Min	Max	Min	Max	Min	Max	Min	Max	Min	Max	Min	Max	Min	Max	Min	Max	Min	Max	Min	Max	
P	1~5	Non-Alloyed Steel	720	1570	560	1480	560	1340	590	1250	490	1150	390	660	-	-	-	-	-	-	-	-	-	-	-
	6~9	Low-Alloyed Steel	720	1380	590	1250	430	1180	360	1150	300	980	230	660	-	-	-	-	-	-	-	-	-	-	-
	10~11	High-Alloyed Steel	-	-	330	1080	260	1020	200	980	230	820	-	-	-	-	-	-	-	-	-	-	-	-	-
M	12~13	Ferritic & Martensitic	-	-	-	-	-	-	-	390	750	-	-	430	750	360	590	260	490	-	-	-	-	-	-
	14	Austenitic Stainless Steel	-	-	-	-	-	-	-	260	660	-	-	330	660	130	430	100	390	-	-	-	-	-	-
K	15~16	Grey Cast Iron	560	1380	390	980	-	-	-	-	-	-	-	-	-	-	-	-	-	-	-	-	-	-	-
	17~18	Nodular Cast Iron	390	1340	390	920	-	-	-	-	-	-	-	-	-	-	-	-	-	-	-	-	-	-	-
N	21~30	Non-Ferrous Metals (Al)	-	-	-	-	-	-	-	-	-	-	-	-	-	-	-	-	-	-	1150	3940	820	2620	
S	31~37	Superalloys & Titanium	-	-	-	-	-	-	-	110	260	-	-	100	300	70	130	70	130	-	-	-	-	-	
H	38~41	Hard Materials	-	-	-	-	-	-	-	-	-	-	-	-	-	-	-	-	-	-	-	-	-	-	

Turning Inserts - Positive TCMT / TCGT (Triangle Positive)

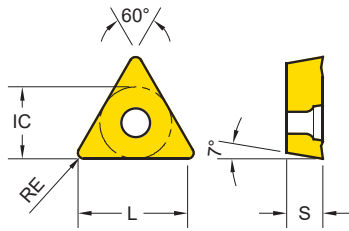

Series	L	IC	S
TC** 21.5	.433	1/4	3/32
TC** 32.5	.618	3/8	5/32

EDP 2200..

●: Stock item ○: Order made item

TCGT TCMT	Designation	RE (in)	Fn (in/rev)	Ap (in)	P05	P10	P15	P20	P30	P20	M15	M30	M40	N20	N20	
					K10	K20	M20	S10	S20	S30						
-AL Aluminum	TCGT 32.50.5 - AL	1/128	.001 ~ .002	.02 ~ .04											● 0344	● 0343
	TCGT 32.51 - AL	1/64	.002 ~ .010	.02 ~ .08											● 0334	● 0085
	TCGT 32.52 - AL	1/32	.004 ~ .014	.04 ~ .12											● 0335	● 0086
-UF Finishing	TCMT 21.51 - UF	1/64	.002 ~ .008	.02 ~ .08		● 0395		● 0396	● 1196							
	TCMT 32.51 - UF	1/64	.002 ~ .010	.02 ~ .12		● 0397		● 0398	● 1046	● 0033						
	TCMT 32.52 - UF	1/32	.002 ~ .010	.03 ~ .12		● 0624		● 0625	● 1045							
-UG General	TCMT 21.51 - UG	1/64	.006 ~ .010	.02 ~ .06	● 0728	● 0264		● 0265	● 0266	● 0032						
	TCMT 21.52 - UG	1/32	.006 ~ .010	.03 ~ .08		● 0485		● 0715	● 1204							
	TCMT 32.51 - UG	1/64	.006 ~ .012	.02 ~ .08	● 0679	● 0267		● 0268								
	TCMT 32.52 - UG	1/32	.006 ~ .012	.03 ~ .12	● 0457	● 0156		● 0157	● 0158	● 0034						

Cutting Speed			Vc (ft/min)																					
ISO	VDI	Sub Group	YG1001		YG3010		YG3015		YG3020		YG3030		YG801		YG211		YG213		YG214		YG100		YG10	
			Min	Max	Min	Max	Min	Max	Min	Max	Min	Max	Min	Max	Min	Max	Min	Max	Min	Max	Min	Max	Min	Max
P	1~5	Non-Alloyed Steel	720	1570	560	1480	560	1340	590	1250	490	1150	390	660	-	-	-	-	-	-	-	-	-	-
	6~9	Low-Alloyed Steel	720	1380	590	1250	430	1180	360	1150	300	980	230	660	-	-	-	-	-	-	-	-	-	-
	10~11	High-Alloyed Steel	-	-	330	1080	260	1020	200	980	230	820	-	-	-	-	-	-	-	-	-	-	-	-
M	12~13	Ferritic & Martensitic	-	-	-	-	-	-	-	390	750	-	-	430	750	360	590	260	490	-	-	-	-	-
	14	Austenitic Stainless Steel	-	-	-	-	-	-	-	260	660	-	-	330	660	130	430	100	390	-	-	-	-	-
K	15~16	Grey Cast Iron	560	1380	390	980	-	-	-	-	-	-	-	-	-	-	-	-	-	-	-	-	-	-
	17~18	Nodular Cast Iron	390	1340	390	920	-	-	-	-	-	-	-	-	-	-	-	-	-	-	-	-	-	-
N	21~30	Non-Ferrous Metals (Al)	-	-	-	-	-	-	-	-	-	-	-	-	-	-	-	-	-	1150	3940	820	2620	-
S	31~37	Superalloys & Titanium	-	-	-	-	-	-	-	110	260	-	-	100	300	70	130	70	130	-	-	-	-	-
H	38~41	Hard Materials	-	-	-	-	-	-	-	-	-	-	-	-	-	-	-	-	-	-	-	-	-	-

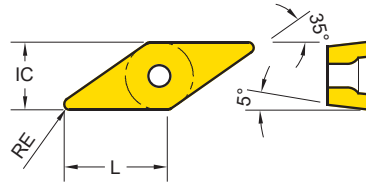

Turning Inserts - Positive VBMT (35° Positive)



Series	L	IC	S
VB** 33	.622	3/8	3/16

EDP 2200..

●: Stock item ○: Order made item

VBMT	Designation	RE (in)	Fn (in/rev)	Ap (in)	P05	P10	P15	P20	P30	P20	M15	M30	M40	N20	N20
					K10	K20	M20	S10	S20	S30					
-UF  Finishing	VBMT 331 - UF	1/64	.002 ~ .010	.02 ~ .08	●	○		●	●	●					
	VBMT 332 - UF	1/32	.002 ~ .010	.02 ~ .12	●	○		●	●	●					
-UG  General	VBMT 331 - UG	1/64	.006 ~ .012	.02 ~ .10	●	●		●	●	●					
	VBMT 332 - UG	1/32	.006 ~ .012	.04 ~ .12	●	●		●	●	●					

Cutting Speed			Vc (ft/min)											
ISO	VDI	Sub Group	YG1001	YG3010	YG3015	YG3020	YG3030	YG801	YG211	YG213	YG214	YG100	YG10	
			Min Max	Min Max	Min Max	Min Max	Min Max	Min Max	Min Max	Min Max	Min Max	Min Max	Min Max	Min Max
P	1~5	Non-Alloyed Steel	720 1570	560 1480	560 1340	590 1250	490 1150	390 660	- -	- -	- -	- -	- -	
	6~9	Low-Alloyed Steel	720 1380	590 1250	430 1180	360 1150	300 980	230 660	- -	- -	- -	- -	- -	
	10~11	High-Alloyed Steel	- -	330 1080	260 1020	200 980	230 820	- -	- -	- -	- -	- -	- -	
M	12~13	Ferritic & Martensitic	- -	- -	- -	- -	390 750	- -	430 750	360 590	260 490	- -	- -	
	14	Austenitic Stainless Steel	- -	- -	- -	- -	260 660	- -	330 660	130 430	100 390	- -	- -	
K	15~16	Grey Cast Iron	560 1380	390 980	- -	- -	- -	- -	- -	- -	- -	- -	- -	
	17~18	Nodular Cast Iron	390 1340	390 920	- -	- -	- -	- -	- -	- -	- -	- -	- -	
N	21~30	Non-Ferrous Metals (Al)	- -	- -	- -	- -	- -	- -	- -	- -	- -	1150 3940	820 2620	
S	31~37	Superalloys & Titanium	- -	- -	- -	- -	110 260	- -	100 300	70 130	70 130	- -	- -	
H	38~41	Hard Materials	- -	- -	- -	- -	- -	- -	- -	- -	- -	- -	- -	

Turning Inserts - Positive

VCMT / VCGT (35° Positive)

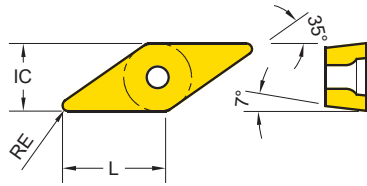

Series	L	IC	S
VC** 33	.622	3/8	3/16

EDP 2200..

●: Stock item ○: Order made item

VCMT	Designation	RE (in)	Fn (in/rev)	Ap (in)	P05	P10	P15	P20	P30	P20	M15	M30	M40	N20	N20	
					K10	K20	M20	S10	S20	S30	YG100	YG10				
-AL Aluminum	VCMT 330.5 - AL	1/128	.001 ~ .002	.02 ~ .04											● 0418	● 0417
	VCMT 331 - AL	1/64	.002 ~ .010	.02 ~ .08											● 0336	● 0087
	VCMT 332 - AL	1/32	.004 ~ .014	.04 ~ .12											● 0420	● 0419
-UF Finishing	VCMT 331 - UF	1/64	.002 ~ .010	.02 ~ .12		● 0716		● 0421	● 0955							
	VCMT 332 - UF	1/32	.002 ~ .010	.02 ~ .12		● 0557		● 0558								
-UG General	VCMT 331 - UG	1/64	.006 ~ .012	.02 ~ .10						● 0060						
	VCMT 332 - UG	1/32	.006 ~ .012	.04 ~ .12		● 0946		● 0422	● 0956	● 0061						

Cutting Speed			Vc (ft/min)											
ISO	VDI	Sub Group	YG1001	YG3010	YG3015	YG3020	YG3030	YG801	YG211	YG213	YG214	YG100	YG10	
			Min Max	Min Max	Min Max	Min Max	Min Max	Min Max	Min Max	Min Max	Min Max	Min Max	Min Max	Min Max
P	1~5	Non-Alloyed Steel	720 1570	560 1480	560 1340	590 1250	490 1150	390 660	- -	- -	- -	- -	- -	
	6~9	Low-Alloyed Steel	720 1380	590 1250	430 1180	360 1150	300 980	230 660	- -	- -	- -	- -	- -	
	10~11	High-Alloyed Steel	- -	330 1080	260 1020	200 980	230 820	- -	- -	- -	- -	- -	- -	
M	12~13	Ferritic & Martensitic	- -	- -	- -	- -	390 750	- -	430 750	360 590	260 490	- -	- -	
	14	Austenitic Stainless Steel	- -	- -	- -	- -	260 660	- -	330 660	130 430	100 390	- -	- -	
K	15~16	Grey Cast Iron	560 1380	390 980	- -	- -	- -	- -	- -	- -	- -	- -	- -	
	17~18	Nodular Cast Iron	390 1340	390 920	- -	- -	- -	- -	- -	- -	- -	- -	- -	
N	21~30	Non-Ferrous Metals (Al)	- -	- -	- -	- -	- -	- -	- -	- -	- -	1150 3940	820 2620	
S	31~37	Superalloys & Titanium	- -	- -	- -	- -	110 260	- -	100 300	70 130	70 130	- -	- -	
H	38~41	Hard Materials	- -	- -	- -	- -	- -	- -	- -	- -	- -	- -	- -	



PARTING & GROOVING

Parting & Grooving Overview

Parting & Grooving Inserts (TD.)

TURNING

Parting & Groove Turn Grades

Parting and Grooving Grades		P Steel				M Stainless steel			K Cast iron			N Non Ferrous		S Super Alloy	
		P10	P20	P30	P40	M10	M20	M30	K10	K20	K30	N10	N20	S10	S20
PVD	YG602G (YG602)			602G			602G			602G					602G

PARTING & GROOVING

<h3>YG602G (YG602)</h3> <p>P20 - P35 M20 - M40 K20 - K40 S15 - S25</p>	<p>PVD - TiAlN</p>	<h3>Universal grade for Parting & Groove Turn</h3> <ul style="list-style-type: none"> • Ultra Dense PVD Coating with optimal thermal resistance & strength • Sub-Micron substrate designed for demanding application • YG602G : First Choice for Low Cutting Speed, Soft and Sticky Material with Low Hardness • YG602 : First Choice for General Application
--	--------------------	---

MILLING

Parting & Grooving Inserts

	<p>TD. Series</p>	<p>Inserts</p> <p>TDN TDP TDY</p>	<p>2, 3, 4</p>
--	-------------------	--	----------------

DRILLING

TECHNICAL INFORMATION

Parting & Grooving Chipbreakers

<p>-P TDP</p>			<p>• Parting & Grooving (Positive)</p>
<p>-N TDN</p>			<p>• Parting & Grooving (General)</p>
<p>-Y TDY</p>			<p>• Turning, Parting & Grooving</p>

Parting & Grooving - Inserts

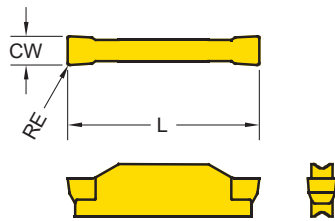

Parting & Grooving Inserts



Series	L	CW
TD* 2	.787	.079
TD* 3	.787	.118
TD* 4	.787	.157

* CDX : Cutting Depth Maximum

●: Stock item ○: Order made item

TD.	Designation	RE (in)	Parting & Grooving		Groove Turn		EDP 5200..	
			Fn (in/rev.)	CDX (in)	Fn (in/rev.)	Ap (in)	YG602	YG602G
-P  Parting & Grooving (Positive)	TDP2002	.008	.002 ~ .005	.75	-	-	● 0012	○ 0036
	TDP3002	.008	.002 ~ .006	.75	-	-	● 0029	○ 0030
	TDP4003	.012	.002 ~ .007	.75	-	-	● 0023	○ 0038
-N  Parting & Grooving (General)	TDN2002	.008	.002 ~ .007	.75	-	-	● 0010	○ 0035
	TDN3002	.008	.003 ~ .009	.75	-	-	● 0024	○ 0025
	TDN4003	.012	.003 ~ .010	.75	-	-	● 0022	○ 0037
-Y  Groove Turn	TDY3E - 0.4	.016	.004 ~ .008	.75	.004 ~ .015	.020 ~ .087		● 0027
	TDY4E - 0.4	.016	.006 ~ .010	.75	.004 ~ .016	.020 ~ .110		● 0020

Cutting Speed			Vc (ft/min.)	
ISO	VDI	Sub Group	YG602G (YG602)	
			Min.	Max.
P	1~5	Non-Alloyed Steel	300	590
	6~9	Low-Alloyed Steel	260	390
	10~11	High-Alloyed Steel	260	360
M	12~13	Ferritic & Martensitic	230	520
	14	Austenitic Stainless Steel	180	460
K	15~16	Grey Cast Iron	360	610
	17~18	Nodular Cast Iron	360	460
N	21~30	Non-Ferrous Metals (Al)	820	1440
S	31~37	Superalloys & Titanium	80	150
H	38~41	Hard Materials	80	160



MILLING

Product Overview

Application Guide

Milling Inserts & Cutter Overview

Milling Inserts & Cutter

Code Keys - Milling Cutters

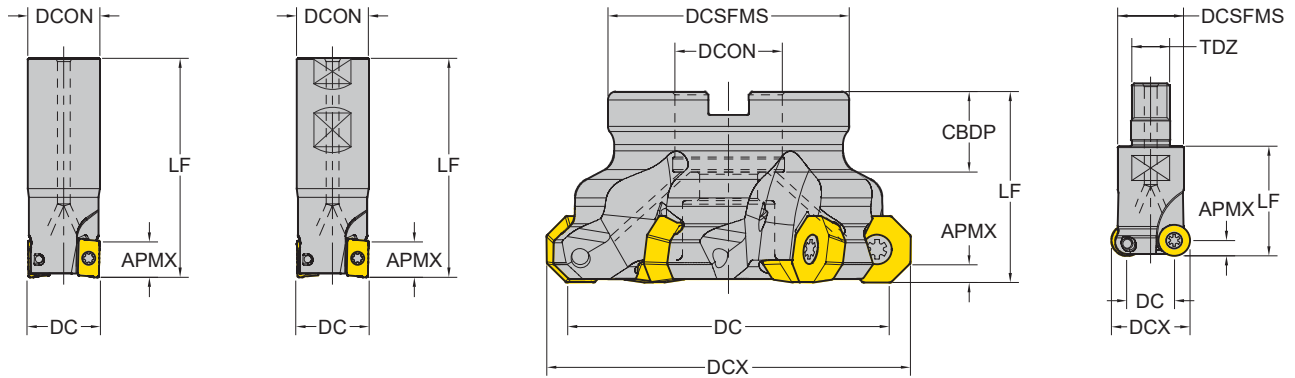

<C> Cylindrical

<W> Weldon

<S> Shell Mill

<M> Modular

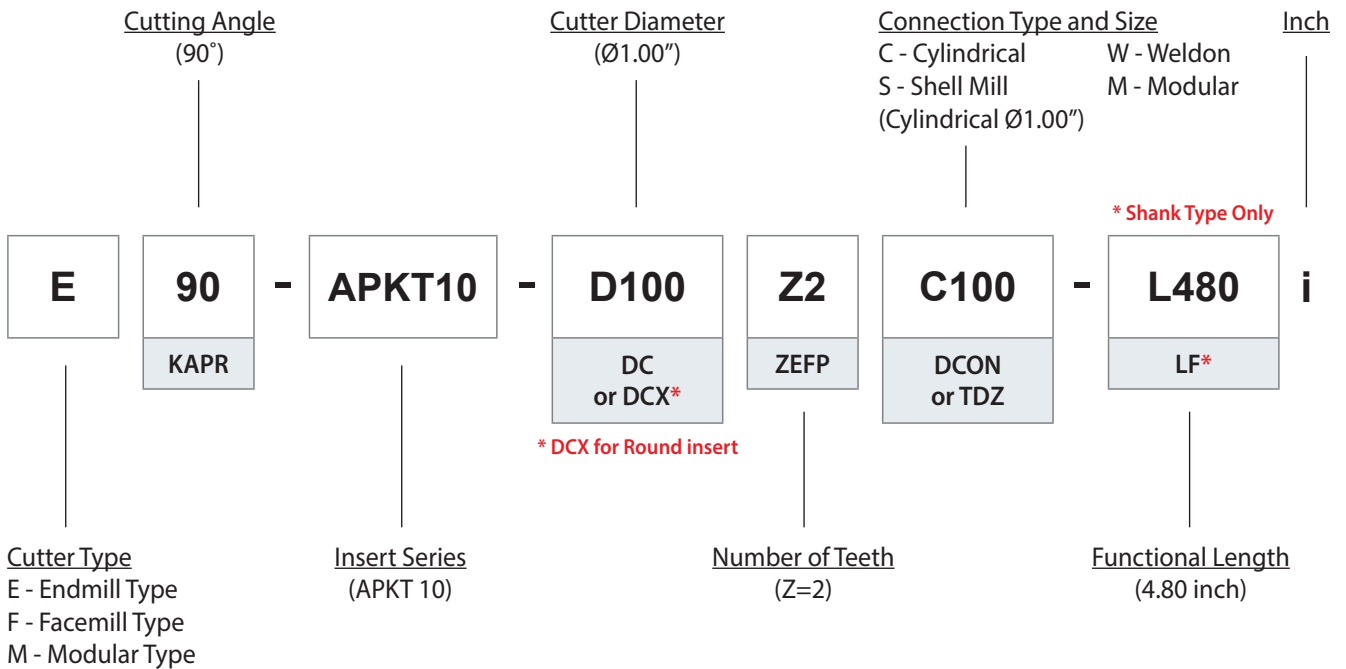

Insert ISO Code System

TURNING

PARTING & GROOVING

MILLING

DRILLING

TECHNICAL INFORMATION

1 A Shape	2 P Relief Angle (AN)	3 K Tolerance	4 T Clamping & Chipbreaker	5 16 Insert Size	6 04 Insert Thickness (S)	7 08 Corner Radius
-------------------------------	---	-----------------------------------	--	--------------------------------------	---	--

1 - Shape

Symbol	Shape	
H	Hexagonal	
O	Octagonal	
P	Pentagonal	
S	Square	
T	Triangular	
V	Rhombic 35°	
W	Trigon	
L	Rectangular	
A	Parallelogram 80°	
R	Round	

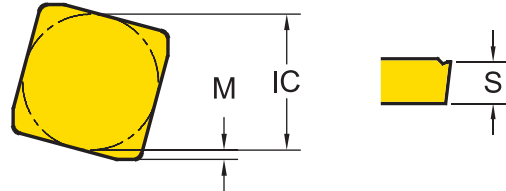

3 - Tolerance Class

Symbol	Inner Circle IC (mm)	Nose Height M (mm)	Thickness S (mm)
C	±.0010	±.0005	±.0010
E	±.001	±.0010	±.001
G	±.001	±.0010	±.005
H	±.0005	±.0005	±.0010
K*	±.002~.006*	±.0005	±.005
M*	±.002~.006*	±.003~.010*	±.005
U*	±.003~.010*	±.005~.015*	±.005

*Tolerance is different by insert IC size. Please see ISO 1832

4 - Clamping & Chipbreaker

Symbol	Clamping	Chipbreaker	Figure
N	No clamping hole	X	
R		One Face	
W	Screw Hole	X	
T		One Face	
U		Both Faces	
X	Special		

2 - Relief Angle (AN)

Symbol	Relief Angle (AN)	
N	No Relief Angle	
B	Relief 5°	
C	Relief 7°	
P	Relief 11°	
D	Relief 15°	
E	Relief 20°	
F	Relief 25°	
O	Special	

5 - Insert Size

* No Standard for milling insert size

6 - Insert Thickness

* No Standard for milling insert thickness

Milling - Code System

Insert ISO Code System

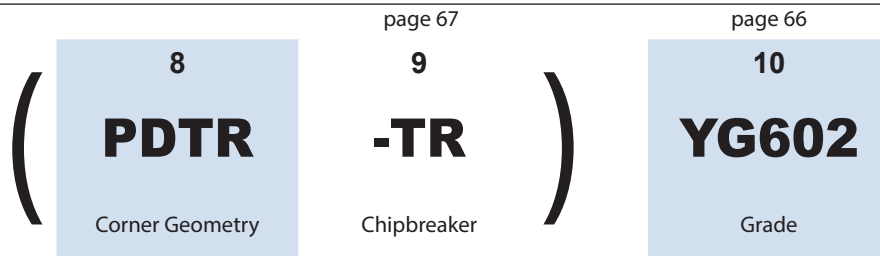

7 - Corner Radius (RE)

Symbol	Thickness - S (in)	Symbol	Thickness - S (in)
04	.016	16	.063
08	.031	20	.079
12	.047	24	.094

8 - Corner Geometry

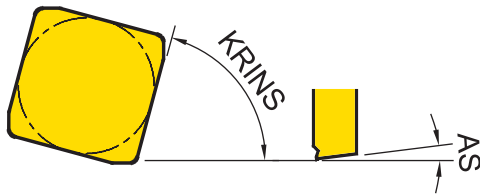

8-1	8-2	8-3	8-4
P	D	T	R
Cutting Edge Angle (KRINS)	Wiper Edge Clearance (AS)	Edge Condition	Feed Direction

*Refer to page. 67 for -AL, -ST, -TR... types

8-1 - Cutting Edge Angle (KRINS)

Symbol	Cutting Edge Angle (KRINS)
P	90°
A	45°
D	60°
E	75°
F	85°
Z	Special

8-3 - Edge Condition

Symbol	Edge Condition
F	Sharp
E	Rounded
T	Chamfered
S	Chamfered and Rounded

8-2 - Wiper Edge Clearance (AS)

Symbol	Wiper Edge Clearance (AS)
N	0°
P	11°
D	15°
E	20°
F	25°
Z	Special

8-4 - Feed Direction

Symbol	Feed Direction
R	Right-hand Insert
N	Neutral Insert
L	Left-hand Insert

Milling Overview

TURNING

PARTING & GROOVING

Face Milling

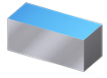

Positive Octagonal						
Cutter						
	ODMT/ODMW 0605		SEKT 1204		SEGT 1204	SEGT 12T3
APMX	.138		.236	.236	.236	
DC	Ø2.5~5.0		Ø1.5~6.0	Ø1.5~6.0	Ø1.5~6.0	
page	p. 68		p. 69	p. 69	p. 69	

MILLING

Shoulder Milling

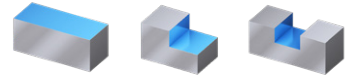

2 Corner Positive						
Cutter						
	APKT 1003		APKT 1604	APMT 1135	APMT 1604	APXT 1604
APMX	.394		.630	.390	.630	.630
DC	Ø.625~2.0		Ø1.0~4.0	Ø.625~1.25	Ø1.25	Ø1.25
page	p.82		p.82	p.83	p.83	p.83

DRILLING





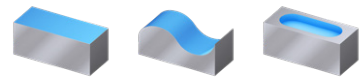

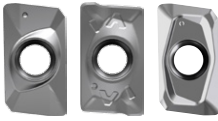

TECHNICAL INFORMATION

Profiling



Round Positive			
Cutter			
	RDKT / RDKW		
APMX	0802	10T3	1204
DCX	.157	.196	.236
page	Ø.75~1.0	Ø1.0~2.0	Ø1.0~2.5
page	p. 90	p. 90	p. 90

Milling Inserts Overview

A 2 Corner	 Positive	ADKT	ADKT 1505	p. 84
		AOMT	AOMT 1236	
		APKT	APKT 1003, 1604	p. 85
		APMT	APMT 1135, 1504, 1604	p. 87
		APXT	APXT 1604	P. 86
O Octagon	 Positive	ODMT / ODMW	ODMT / ODMW 0605	p. 70
		OFER	OFER 0704	p. 71
	OFMT	OFMT 05T3		
R Round	 Positive Round	RDKT / RDKW	RDKT 0802, 10T3, 1204 RDKW 0501, 0702, 0802, 10T3, 1204	p. 91
		RDMT / RDMW	RDMT 0802, 0803, 10T3, 1204 RDMW 0802, 10T3, 1204	p. 92
	 Positive 3 Corner	RPMT / RPMW	RPMT 08T2, 10T3, 1204 RPMW 1003, 1204	p. 93
		RBEX50	RBEX50	P. 94
S Square	 High Feed	SDMT / SDMW	SDMT 1204, SDMW 1204	p. 95
		SEKT	SEKT 12T3, 1204	p. 75
	 Positive	SEGT	SEGT12T3, 1204	p. 76
		SEMT	SEMT1204, 13T3	P. 77
		SPMT	SPMT 1204	p. 80
		SDKN / SDCN (45°)	SDKN / SDCN 42, 53	p. 73
	SEKN / SEKR (45°)	SEKN / SEKR 42	p. 74	
	 ISO	SPKN / SPKR / SPCN(75°)	SPKN 42, 53 SPKR 42 SPCN 42, 53	p. 79
		SPUN	SPUN 42	p. 81
	 Negative	SNMX	SNMX1206	p. 78
T Triangle	 ISO	TPKN / TPKR / TPCN(90°)	TPKN 32, 43 TPKR 32, 43 TPCN 43	p. 88
		TPUN	TPUN 32	p. 89

Milling Grades and Chipbreakers

Milling Grades

Milling Grades		P Steel					M Stainless steel				K Cast iron				N Non-ferrous				S Superalloys			
		P05	P15	P25	P35	P45	M05	M15	M25	M35	K05	K15	K25	K35	N05	N15	N25	N35	S05	S15	S25	S35
PVD	YG602			602					602											602		
	YG622			622									622									
	YG712			712																		
	YG603				603				603													603
	YG501												501									
CVD	YG5020												5020									
Uncoated	YG50															50						

<p>YG602</p> <p>P20 - P35 M20 - M40</p> <p>K20 - K40 S15 - S25</p>	<p>PVD - TiAlN</p>	<p>Universal grade for General Milling Application</p> <ul style="list-style-type: none"> • Ultra Dense PVD Coating with optimal thermal resistance & strength • Sub-Micron substrate designed for demanding application
<p>YG622</p> <p>P20 - P40</p> <p>K20 - K40</p>	<p>PVD - TiAlN</p>	<p>Optimized Grade for High Alloyed or Prehardened Steel</p> <p>Excellent hot hardness and oxidation resistance at high speed</p>
<p>YG712</p> <p>P10 - P30</p>	<p>PVD - AlTiCrN</p>	<p>General Milling Grade for Steel</p>
<p>YG603</p> <p>P30 - P50 M30 - M40</p> <p>S30</p>	<p>PVD - TiAlN</p>	<p>Tough Milling grade for Stainless Steel</p> <ul style="list-style-type: none"> • New coating layer with high toughness and lubrication on ultra fine grain substrate with high toughness. • The toughest substrates provides excellent cutting performance in stainless steel
<p>YG501</p> <p>K05 - K25</p> <p>H05 - H25</p>	<p>PVD - TiAlN</p>	<p>Hard Milling grade for Cast Iron</p> <ul style="list-style-type: none"> • Substrate especially designed for high wear resistance • Excellent wear resistance in cast iron milling application
<p>YG5020</p> <p>K01-K30</p>	<p>CVD TiCN - Al₂O₃</p>	<p>CVD Milling grade for Cast Iron</p> <ul style="list-style-type: none"> • CVD coating for Excellent wear resistance • Improved Toughness for chipping resistance
<p>YG50</p> <p>N05 - N20</p>	<p>Uncoated</p>	<p>Uncoated Milling Grade for Aluminium</p> <ul style="list-style-type: none"> • Submicron carbide substrate for high wear resistance • Preventing built up edge with shining surface

Milling Grades and Chipbreakers

Milling Chipbreakers

-AL		<ul style="list-style-type: none"> • For Aluminum • Very Sharp Geometry
-ST		<ul style="list-style-type: none"> • For Stainless Steel, Super Alloy • Sharp Geometry
General Inserts (No Description)		<ul style="list-style-type: none"> • First Choice for General Application
-TR		<ul style="list-style-type: none"> • For Hardened Steels • Reinforced Geometry
...W / ...N		<ul style="list-style-type: none"> • For Hardened Material and Cast Irons

Milling - Face Milling - Cutter

Cutters for ODMT, ODMW

Cutting Angle : 43°
8 Corner Positive

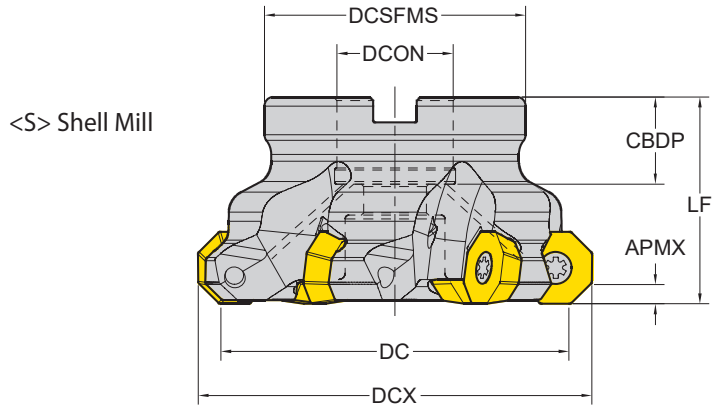

ZAFP : Effective Number of Cutting Edges
CICT : Number of Inserts
CBDP : Connection Bore Depth

□ : p. 70 Unit: inch

Series	APMX	Designation	EDP 1700..	DC	DCX	ZAFP	LF	TYPE	DCON	CBDP	DCSFMS	PCD1	PCD2	☉
ODMT ODMW 0605	.138	F43-ODMT06-D250Z5S075i	0040	2.50	2.89	5	1.575	Shellmill	.75	.79	2.00	-	-	●
		F43-ODMT06-D300Z6S100i	0041	3.00	3.39	6	1.75		1.00	.87	2.50	-	-	●
		F43-ODMT06-D400Z7S125i	0042	4.00	4.39	7	2.00		1.25	.98	3.00	-	-	●
		F43-ODMT06-D500Z8S150i	0043	5.00	5.39	8	2.38		1.50	1.14	3.65	-	-	●

TURNING

PARTING & GROOVING

MILLING

DRILLING

TECHNICAL INFORMATION

Milling - Face Milling - Cutter

Cutters for SEKT, SEGT

Cutting Angle : 45°
4 Corner Positive

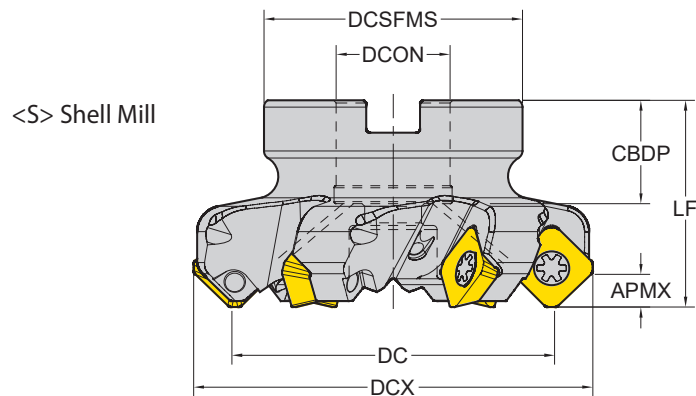

ZAFP : Effective Number of Cutting Edges
CICT : Number of Inserts
CDBP : Connection Bore Depth

□ : p. 75 Unit: inch

Series	APMX	Designation	EDP 1700..	DC	DCX	ZAFP	LF	TYPE	DCON	CDBP	DCSFMS	PCD1	PCD2	☉
SEKT SEGT 1204	.236	F45-SEKT12-D150Z4S050i	0060	1.50	2.06	4	1.575	Shellmill	.50	.71	1.25	-	-	●
		F45-SEKT12-D200Z5S075i	0061	2.00	2.56	5	1.575		.75	.79	1.75	-	-	●
		F45-SEKT12-D250Z4S075i	0062	2.50	3.06	4	1.575		.75	.79	2.00	-	-	●
		F45-SEKT12-D250Z6S075i	0063	2.50	3.06	6	1.575		.75	.79	2.00	-	-	●
		F45-SEKT12-D300Z4S100i	0064	3.00	3.56	4	1.75		1.00	.87	2.25	-	-	●
		F45-SEKT12-D300Z7S100i	0065	3.00	3.56	7	1.75		1.00	.87	2.25	-	-	●
		F45-SEKT12-D400Z8S125i	0066	4.00	4.56	8	2.00		1.25	.98	3.00	-	-	●
		F45-SEKT12-D500Z10S150i	0067	5.00	5.56	10	2.38		1.50	1.14	3.65	-	-	●
F45-SEKT12-D600Z12S200i	0068	6.00	6.56	12	2.38	2.00	1.18	4.70	-	-	X			

Milling - Face Milling - Inserts

ODMT, ODMW - Face Milling Positive (8 Corners)

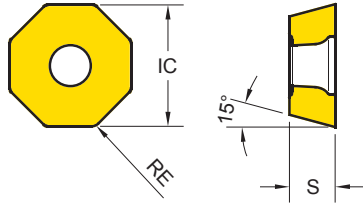

Series	IC	S
ODM* 0605	.626	.220

EDP 1200..

●: Stock item ○: Order made item

P25	P30	P20	P40		
M30			M35		
K30	K30			K15	K15
S20			S30	H15	

		Designation	RE (in)	Fz (in/tooth)	BS (in)	YG602	YG622	YG712	YG603	YG501	YG5020
ODMT General		ODMT 060508	.031	.008 ~ .014		● 0030					
ODMW Hard Materials		ODMW 060508	.031	.01 ~ .015		● 0031					

Cutting Speed			Vc (ft/min.)											
ISO	VDI	Sub Group	YG602		YG622		YG712		YG603		YG501		YG5020	
			Min	Max	Min	Max	Min	Max	Min	Max	Min	Max	Min	Max
P	1~5	Non-Alloyed Steel	460	1250	460	1310	560	980	300	750	-	-	-	-
	6~9	Low-Alloyed Steel	390	980	390	1050	590	820	230	690	-	-	-	-
	10~11	High-Alloyed Steel	230	490	230	560	330	460	200	330	-	-	-	-
M	12~13	Ferritic & Martensitic	390	660	-	-	-	-	260	590	-	-	-	-
	14	Austenitic Stainless Steel	430	820	-	-	-	-	330	660	-	-	-	-
K	15~16	Grey Cast Iron	390	820	390	890	-	-	-	-	590	1150	660	1150
	17~18	Nodular Cast Iron	430	720	430	790	-	-	-	-	390	890	490	980
N	21~30	Non-Ferrous Metals (Al)	-	-	-	-	-	-	-	-	-	-	-	-
S	31~37	Superalloys & Titanium	80	150	-	-	-	-	70	130	-	-	-	-
H	38~41	Hard Materials	130	260	130	330	-	-	-	-	160	300	-	-

Milling - Face Milling - Inserts

OFER, OFMT - Face Milling Positive (8 Corners)

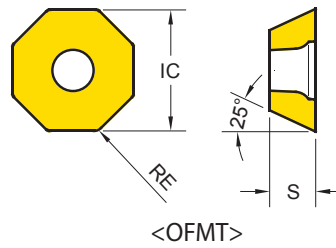
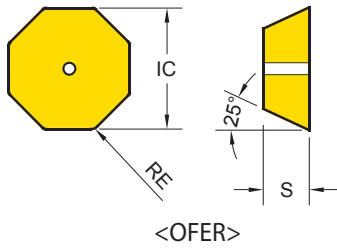

Series	IC	S
OFER 0704	.711	.188
OFMT 05T3	.501	.160

EDP 1200..

●: Stock item ○: Order made item

P25	P30	P20	P40		
M30			M35		
K30	K30		S30	H15	K15
S20					

OFER	Designation	RE (in)	Fz (in/tooth)	BS (in)	YG602	YG622	YG712	YG603	YG501	YG5020
					OFER 070405	.020	.009 ~ .020		● 0209	

OFER
General

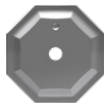

OFMT	Designation	RE (in)	Fz (in/tooth)	BS (in)	YG602	YG622	YG712	YG603	YG501	YG5020
					OFMT 05T308	.031	.006 ~ .010		● 0032	

OFMT
General



Cutting Speed			Vc (ft/min.)											
ISO	VDI	Sub Group	YG602		YG622		YG712		YG603		YG501		YG5020	
			Min	Max	Min	Max	Min	Max	Min	Max	Min	Max	Min	Max
P	1~5	Non-Alloyed Steel	460	1250	460	1310	560	980	300	750	-	-	-	-
	6~9	Low-Alloyed Steel	390	980	390	1050	590	820	230	690	-	-	-	-
	10~11	High-Alloyed Steel	230	490	230	560	330	460	200	330	-	-	-	-
M	12~13	Ferritic & Martensitic	390	660	-	-	-	-	260	590	-	-	-	-
	14	Austenitic Stainless Steel	430	820	-	-	-	-	330	660	-	-	-	-
K	15~16	Grey Cast Iron	390	820	390	890	-	-	-	-	590	1150	660	1150
	17~18	Nodular Cast Iron	430	720	430	790	-	-	-	-	390	890	490	980
N	21~30	Non-Ferrous Metals (Al)	-	-	-	-	-	-	-	-	-	-	-	-
S	31~37	Superalloys & Titanium	80	150	-	-	-	-	70	130	-	-	-	-
H	38~41	Hard Materials	130	260	130	330	-	-	-	-	160	300	-	-

Milling - Face Milling - Inserts

ONMU / ONHU - Face Milling Negative (16 Corners)

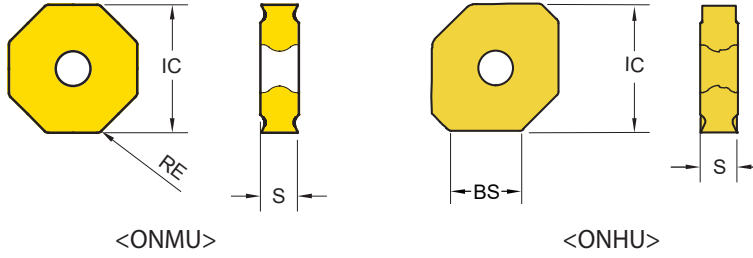

Series	IC	S
ON*U 0806	.795	.228

EDP 1200..

●: Stock item ○: Order made item

P25	P30	P20	P40		
M30			M35		
K30	K30			K15	K15
S20			S30	H15	

ONMU ONHU	Designation	RE (in)	Fz (in/tooth)	BS (in)	YG602	YG622	YG712	YG603	YG501	YG5020
	ONMU 080608	.031	.009~.020		● 0233					● 0414
ONMU General										
	ONHU 080612	.047	.009~.020	.417						● 0482
ONHU Wiper Insert										

Cutting Speed			Vc (ft/min.)											
ISO	VDI	Sub Group	YG602		YG622		YG712		YG603		YG501		YG5020	
			Min	Max	Min	Max	Min	Max	Min	Max	Min	Max	Min	Max
P	1~5	Non-Alloyed Steel	460	1250	460	1310	560	980	300	750	-	-	-	-
	6~9	Low-Alloyed Steel	390	980	390	1050	590	820	230	690	-	-	-	-
	10~11	High-Alloyed Steel	230	490	230	560	330	460	200	330	-	-	-	-
M	12~13	Ferritic & Martensitic	390	660	-	-	-	-	260	590	-	-	-	-
	14	Austenitic Stainless Steel	430	820	-	-	-	-	330	660	-	-	-	-
K	15~16	Grey Cast Iron	390	820	390	890	-	-	-	-	590	1150	660	1150
	17~18	Nodular Cast Iron	430	720	430	790	-	-	-	-	390	890	490	980
N	21~30	Non-Ferrous Metals (Al)	-	-	-	-	-	-	-	-	-	-	-	-
S	31~37	Superalloys & Titanium	80	150	-	-	-	-	70	130	-	-	-	-
H	38~41	Hard Materials	130	260	130	330	-	-	-	-	160	300	-	-

Milling - Face Milling - Inserts

SDKN / CN - Face Milling Positive (4 Corners ISO)

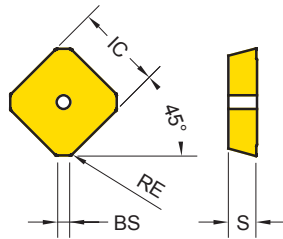

Series	AS	IC	S
SD** 42	15°	.500	.122
SD** 53	15°	.625	.185

EDP 1200..

● : Stock item ○ : Order made item

P25	P30	P20	P40		
M30			M35		
K30	K30		S30	H15	K15
S20					

SDKN SDCN	Designation	RE (in)	Fz (in/tooth)	BS (in)	EDP 1200..					
					YG602	YG622	YG712	YG603	YG501	YG5020
SDKN Hard Materials	SDKN 42 AETN	.020	.009 ~ .014	.073	● 0058					
	SDKN 42 AETN -PW	.016	.009 ~ .014	.078	● 0253					
	SDKN 42 AETN -GW	.051	.009 ~ .014	.073	● 0251					
	SDKN 53 AETN	.018	.009 ~ .014	.079	● 0059					
	SDKN 53 AETN -PW	.016	.009 ~ .016	.077	● 0288					
	SDKN 53 AETN -GW	.051	.009 ~ .016	.081	● 0286					
SDCN Ground insert	SDCN 42 AESN -M		.002 ~ .008	.080			● 0135			
	SDCN 53 AESN -M		.002 ~ .008	.086			● 0150			
	SDCN 53 AESN -MR	.039	.002 ~ .008	.086			● 0201			

- PW : for Improved Surface Roughness
- GW : Ground Wiper
- M : for Mold & Die
- MR : for Mold & Die Roughing

Cutting Speed			Vc (ft/min.)											
ISO	VDI	Sub Group	YG602		YG622		YG712		YG603		YG501		YG5020	
			Min	Max	Min	Max	Min	Max	Min	Max	Min	Max	Min	Max
P	1~5	Non-Alloyed Steel	460	1250	460	1310	560	980	300	750	-	-	-	-
	6~9	Low-Alloyed Steel	390	980	390	1050	590	820	230	690	-	-	-	-
	10~11	High-Alloyed Steel	230	490	230	560	330	460	200	330	-	-	-	-
M	12~13	Ferritic & Martensitic	390	660	-	-	-	-	260	590	-	-	-	-
	14	Austenitic Stainless Steel	430	820	-	-	-	-	330	660	-	-	-	-
K	15~16	Grey Cast Iron	390	820	390	890	-	-	-	-	590	1150	660	1150
	17~18	Nodular Cast Iron	430	720	430	790	-	-	-	-	390	890	490	980
N	21~30	Non-Ferrous Metals (Al)	-	-	-	-	-	-	-	-	-	-	-	-
S	31~37	Superalloys & Titanium	80	150	-	-	-	-	70	130	-	-	-	-
H	38~41	Hard Materials	130	260	130	330	-	-	-	-	160	300	-	-

Milling - Face Milling - Inserts

SEKR / N - Face Milling Positive (4 Corners ISO)

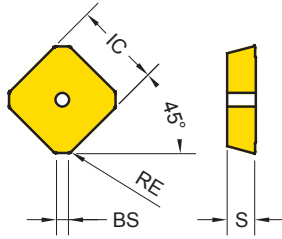

Series	AS	IC	S
SEK* 42	20°	.500	.126

EDP 1200..

● : Stock item ○ : Order made item

P25	P30	P20	P40		
M30			M35		
K30	K30			K15	K15
S20			S30	H15	

SEKR SEKN		Designation	RE (in)	Fz (in/tooth)	BS (in)	YG602	YG622	YG712	YG603	YG501	YG5020
SEKR General		SEKR 42 AFTN	.016	.006 ~ .012	.055	● 0051					
		SEKR 42 AFTN -PW	.016	.006 ~ .012	.078	● 0296					
SEKN Hard Materials		SEKN 42 AFTN	.016	.009 ~ .014	.055	● 0054					
		SEKN 42 AFTN -PW	.016	.009 ~ .014	.078	● 0297					
		SEKN 42 AFTN -GW	.016	.009 ~ .014	.079	● 0304					

- PW : for Improved Surface Roughness

- GW : Ground Wiper

Cutting Speed			Vc (ft/min.)											
ISO	VDI	Sub Group	YG602		YG622		YG712		YG603		YG501		YG5020	
			Min	Max	Min	Max	Min	Max	Min	Max	Min	Max	Min	Max
P	1~5	Non-Alloyed Steel	460	1250	460	1310	560	980	300	750	-	-	-	-
	6~9	Low-Alloyed Steel	390	980	390	1050	590	820	230	690	-	-	-	-
	10~11	High-Alloyed Steel	230	490	230	560	330	460	200	330	-	-	-	-
M	12~13	Ferritic & Martensitic	390	660	-	-	-	-	260	590	-	-	-	-
	14	Austenitic Stainless Steel	430	820	-	-	-	-	330	660	-	-	-	-
K	15~16	Grey Cast Iron	390	820	390	890	-	-	-	-	590	1150	660	1150
	17~18	Nodular Cast Iron	430	720	430	790	-	-	-	-	390	890	490	980
N	21~30	Non-Ferrous Metals (Al)	-	-	-	-	-	-	-	-	-	-	-	-
S	31~37	Superalloys & Titanium	80	150	-	-	-	-	70	130	-	-	-	-
H	38~41	Hard Materials	130	260	130	330	-	-	-	-	160	300	-	-

Milling - Face Milling - Inserts

SEKT - Face Milling Positive (4 Corners)

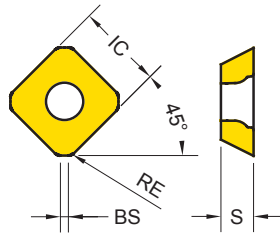

Series	IC	S
SEKT 1204	.500	.193
SEKT 12T3	.528	.157

EDP 1200..

●: Stock item ○: Order made item

P25	P30	P20	P40		
M30			M35		
K30	K30			K15	K15
S20			S30	H15	

SEKT 1204		Designation	RE (in)	Fz (in/tooth)	BS (in)	YG602	YG622	YG712	YG603	YG501	YG5020
SEKT 1204 General		SEKT 1204 AFTN	.043	.008 ~ .014	.046	● 0055					
		SEKT 1204 -ST	.043	.003 ~ .012	.079	● 0257					
-ST Stainless Steel Super Alloy											

SEKT 12T3		Designation	RE (in)	Fz (in/tooth)	BS (in)	YG602	YG622	YG712	YG603	YG501	YG5020
SEKT 12T3 General		SEKT 12T3 AGTN	.059	.006 ~ .012	.051	● 0056					
		SEKT 12T3 -ST	.059	.003 ~ .012	.076	● 0271					
-ST Stainless Steel Super Alloy											

Cutting Speed			Vc (ft/min.)											
ISO	VDI	Sub Group	YG602		YG622		YG712		YG603		YG501		YG5020	
			Min	Max	Min	Max	Min	Max	Min	Max	Min	Max	Min	Max
P	1~5	Non-Alloyed Steel	460	1250	460	1310	560	980	300	750	-	-	-	-
	6~9	Low-Alloyed Steel	390	980	390	1050	590	820	230	690	-	-	-	-
	10~11	High-Alloyed Steel	230	490	230	560	330	460	200	330	-	-	-	-
M	12~13	Ferritic & Martensitic	390	660	-	-	-	-	260	590	-	-	-	-
	14	Austenitic Stainless Steel	430	820	-	-	-	-	330	660	-	-	-	-
K	15~16	Grey Cast Iron	390	820	390	890	-	-	-	-	590	1150	660	1150
	17~18	Nodular Cast Iron	430	720	430	790	-	-	-	-	390	890	490	980
N	21~30	Non-Ferrous Metals (Al)	-	-	-	-	-	-	-	-	-	-	-	-
S	31~37	Superalloys & Titanium	80	150	-	-	-	-	70	130	-	-	-	-
H	38~41	Hard Materials	130	260	130	330	-	-	-	-	160	300	-	-

Milling - Face Milling - Inserts

SEGT - Face Milling Positive (4 Corners)

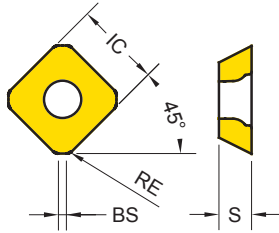

Series	IC	S
SEGT 1204	.500	.193
SEGT 12T3	.528	.157

EDP 1200..

●: Stock item ○: Order made item

P25	P30	P20	P40			
M30			M35			
K30	K30			K15	K15	
S20			S30	H15		N15

SEGT 1204	Designation	RE (in)	Fz (in/tooth)	BS (in)	YG602	YG622	YG712	YG603	YG501	YG5020	YG50
					SEGT 1204-AL	.043	.004 ~ .014	.079			

-AL
Aluminium

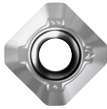

SEGT 12T3	Designation	RE (in)	Fz (in/tooth)	BS (in)	YG602	YG622	YG712	YG603	YG501	YG5020	YG50
					SEGT 12T3-AL	.059	.004 ~ .014	.076			

-AL
Aluminium



Cutting Speed			Vc (ft/min.)													
ISO	VDI	Sub Group	YG602		YG622		YG712		YG603		YG501		YG5020		YG50	
			Min	Max	Min	Max	Min	Max	Min	Max	Min	Max	Min	Max	Min	Max
P	1~5	Non-Alloyed Steel	460	1250	460	1310	560	980	300	750	-	-	-	-	-	-
	6~9	Low-Alloyed Steel	390	980	390	1050	590	820	230	690	-	-	-	-	-	-
	10~11	High-Alloyed Steel	230	490	230	560	330	460	200	330	-	-	-	-	-	-
M	12~13	Ferritic & Martensitic	390	660	-	-	-	-	260	590	-	-	-	-	-	-
	14	Austenitic Stainless Steel	430	820	-	-	-	-	330	660	-	-	-	-	-	-
K	15~16	Grey Cast Iron	390	820	390	890	-	-	-	-	590	1150	660	1150	-	-
	17~18	Nodular Cast Iron	430	720	430	790	-	-	-	-	390	890	490	980	-	-
N	21~30	Non-Ferrous Metals (Al)	-	-	-	-	-	-	-	-	-	-	-	-	980	2620
S	31~37	Superalloys & Titanium	80	150	-	-	-	-	70	130	-	-	-	-	-	-
H	38~41	Hard Materials	130	260	130	330	-	-	-	-	160	300	-	-	-	-

Milling - Face Milling - Inserts

SEMT - Face Milling Positive (4 Corners)

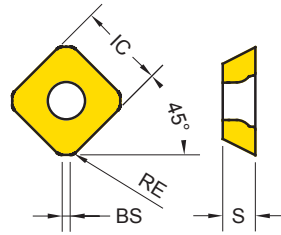

Series	IC	S
SEMT1204	.509	.201
SEMT13T3	.528	.157

EDP 1200..

●: Stock item ○: Order made item

P25	P30	P20	P40		
M30			M35		
K30	K30			K15	K15
S20			S30	H15	

SEMT		Designation	RE (in)	Fz (in/tooth)	BS (in)	YG602	YG622	YG712	YG603	YG501	YG5020
SEMT 1204 General		SEMT 1204 AFTN	.047	.010~.016	.049	● 0052					
SEMT 13T3 General		SEMT 13T3 AGSN	.059	.006~.012	.052	● 0203					

Cutting Speed			Vc (ft/min.)											
ISO	VDI	Sub Group	YG602		YG622		YG712		YG603		YG501		YG5020	
			Min	Max	Min	Max	Min	Max	Min	Max	Min	Max	Min	Max
P	1~5	Non-Alloyed Steel	460	1250	460	1310	560	980	300	750	-	-	-	-
	6~9	Low-Alloyed Steel	390	980	390	1050	590	820	230	690	-	-	-	-
	10~11	High-Alloyed Steel	230	490	230	560	330	460	200	330	-	-	-	-
M	12~13	Ferritic & Martensitic	390	660	-	-	-	-	260	590	-	-	-	-
	14	Austenitic Stainless Steel	430	820	-	-	-	-	330	660	-	-	-	-
K	15~16	Grey Cast Iron	390	820	390	890	-	-	-	-	590	1150	660	1150
	17~18	Nodular Cast Iron	430	720	430	790	-	-	-	-	390	890	490	980
N	21~30	Non-Ferrous Metals (Al)	-	-	-	-	-	-	-	-	-	-	-	-
S	31~37	Superalloys & Titanium	80	150	-	-	-	-	70	130	-	-	-	-
H	38~41	Hard Materials	130	260	130	330	-	-	-	-	160	300	-	-

Milling - Face Milling - Inserts

SNMX - Face Milling Negative (8 Corners)

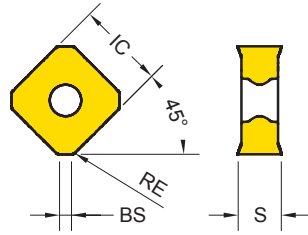

Series	IC	S
SNMX 1206	.500	.246

EDP 1200..

●: Stock item ○: Order made item

P25	P30	P20	P40		
M30			M35		
K30	K30			K15	K15
S20			S30	H15	

SNMX	Designation	RE (in)	Fz (in/tooth)	BS (in)	YG602	YG622	YG712	YG603	YG501	YG5020
	SNMX 1206 ANN	.031	.006 ~ .013	.067	● 0231					

SNMX
General

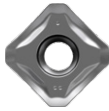

TURNING

PARTING & GROOVING

MILLING

DRILLING

TECHNICAL INFORMATION

Cutting Speed			Vc (ft/min.)											
ISO	VDI	Sub Group	YG602		YG622		YG712		YG603		YG501		YG5020	
			Min	Max	Min	Max	Min	Max	Min	Max	Min	Max	Min	Max
P	1~5	Non-Alloyed Steel	460	1250	460	1310	560	980	300	750	-	-	-	-
	6~9	Low-Alloyed Steel	390	980	390	1050	590	820	230	690	-	-	-	-
	10~11	High-Alloyed Steel	230	490	230	560	330	460	200	330	-	-	-	-
M	12~13	Ferritic & Martensitic	390	660	-	-	-	-	260	590	-	-	-	-
	14	Austenitic Stainless Steel	430	820	-	-	-	-	330	660	-	-	-	-
K	15~16	Grey Cast Iron	390	820	390	890	-	-	-	-	590	1150	660	1150
	17~18	Nodular Cast Iron	430	720	430	790	-	-	-	-	390	890	490	980
N	21~30	Non-Ferrous Metals (Al)	-	-	-	-	-	-	-	-	-	-	-	-
S	31~37	Superalloys & Titanium	80	150	-	-	-	-	70	130	-	-	-	-
H	38~41	Hard Materials	130	260	130	330	-	-	-	-	160	300	-	-

Milling - Face Milling - Inserts

SPKN / R / CN - Face Milling Positive (4 Corners ISO)

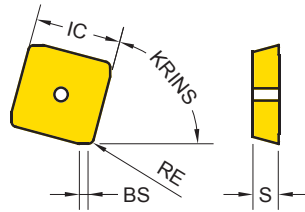

Series	KRINS	AS	IC	S
SP** 42	75°	11°	.500	.126
SP** 53	75°	11°	.625	.189

EDP 1200..

● : Stock item ○ : Order made item

P25	P30	P20	P40		
M30			M35		
K30	K30			K15	K15
S20			S30	H15	

SPKR SPKN SPCN		Designation	RE (in)	Fz (in/tooth)	BS (in)	YG602	YG622	YG712	YG603	YG501	YG5020
SPKR General		SPKR 42 EDTR	.031	.006 ~ .014	.055	● 0050					
		SPKR 42 EDTR -PW	.031	.006 ~ .014	.058	● 0298					
SPKN Hard Materials		SPKN 42 EDTR	.031	.006 ~ .013	.055	● 0048					
		SPKN 42 EDTR -PW	.031	.008 ~ .014	.058	● 0279					
		SPKN 42 EDTR -GW	.024	.006 ~ .011	.059	● 0280					
		SPKN 53 EDTR		.006 ~ .013	.051	● 0049					
		SPKN 53 EDTR -PW		.010 ~ .016	.079	● 0299					
		SPKN 53 EDTR -GW	.031	.010 ~ .016	.087	● 0305					
SPCN Ground insert		SPCN 42 EDSR -M	.031	.004 ~ .008	.072			● 0081			
		SPCN 42 EDSR -MR	.059	.004 ~ .008	.031			● 0198			
		SPCN 53 EDSR -M	.031	.004 ~ .008	.076			● 0098			
		SPCN 53 EDSR -MR	.059	.004 ~ .008	.038			● 0199			

- PW : for Improved Surface Roughness
- GW : Ground Wiper
- M : for Mold & Die
- MR : for Mold & Die Roughing

Cutting Speed			Vc (ft/min.)											
ISO	VDI	Sub Group	YG602		YG622		YG712		YG603		YG501		YG5020	
			Min	Max	Min	Max	Min	Max	Min	Max	Min	Max	Min	Max
P	1~5	Non-Alloyed Steel	460	1250	460	1310	560	980	300	750	-	-	-	-
	6~9	Low-Alloyed Steel	390	980	390	1050	590	820	230	690	-	-	-	-
	10~11	High-Alloyed Steel	230	490	230	560	330	460	200	330	-	-	-	-
M	12~13	Ferritic & Martensitic	390	660	-	-	-	-	260	590	-	-	-	-
	14	Austenitic Stainless Steel	430	820	-	-	-	-	330	660	-	-	-	-
K	15~16	Grey Cast Iron	390	820	390	890	-	-	-	-	590	1150	660	1150
	17~18	Nodular Cast Iron	430	720	430	790	-	-	-	-	390	890	490	980
N	21~30	Non-Ferrous Metals (Al)	-	-	-	-	-	-	-	-	-	-	-	-
S	31~37	Superalloys & Titanium	80	150	-	-	-	-	70	130	-	-	-	-
H	38~41	Hard Materials	130	260	130	330	-	-	-	-	160	300	-	-

Milling - Face Milling - Inserts

SPMT - Universal Positive (4 Corners)

TURNING

PARTING & GROOVING

MILLING

DRILLING

TECHNICAL INFORMATION

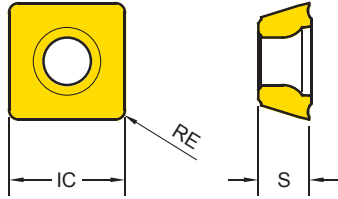

Series	AS	IC	S
SPMT 1204	11°	.500	.189

EDP 1200..

●: Stock item ○: Order made item

P25	P30	P20	P40		
M30			M35		
K30	K30			K15	K15
S20			S30	H15	

SPMT	Designation	RE (in)	Fz (in/tooth)	BS (in)	YG602	YG622	YG712	YG603	YG501	YG5020
	SPMT 120408	.031	.006 ~ .012		● 0223					

SPMT
General



Cutting Speed			Vc (ft/min.)											
ISO	VDI	Sub Group	YG602		YG622		YG712		YG603		YG501		YG5020	
			Min	Max	Min	Max	Min	Max	Min	Max	Min	Max	Min	Max
P	1~5	Non-Alloyed Steel	460	1250	460	1310	560	980	300	750	-	-	-	-
	6~9	Low-Alloyed Steel	390	980	390	1050	590	820	230	690	-	-	-	-
	10~11	High-Alloyed Steel	230	490	230	560	330	460	200	330	-	-	-	-
M	12~13	Ferritic & Martensitic	390	660	-	-	-	-	260	590	-	-	-	-
	14	Austenitic Stainless Steel	430	820	-	-	-	-	330	660	-	-	-	-
K	15~16	Grey Cast Iron	390	820	390	890	-	-	-	-	590	1150	660	1150
	17~18	Nodular Cast Iron	430	720	430	790	-	-	-	-	390	890	490	980
N	21~30	Non-Ferrous Metals (Al)	-	-	-	-	-	-	-	-	-	-	-	-
S	31~37	Superalloys & Titanium	80	150	-	-	-	-	70	130	-	-	-	-
H	38~41	Hard Materials	130	260	130	330	-	-	-	-	160	300	-	-

Milling - Face Milling - Inserts

SPUN - Universal Positive (4 Corners ISO)

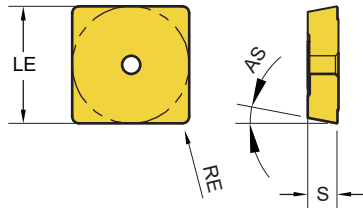

Series	AS	IC	S
SPUN 42	11°	.500	.126

EDP 1200..

●: Stock item ○: Order made item

P25	P30	P20	P40		
M30			M35		
K30	K30		S30	K15	K15
S20				H15	

SPUN	Designation	RE (in)	Fz (in/tooth)	BS (in)	Material						
					YG602	YG622	YG712	YG603	YG501	YG5020	
	SPUN 422	.031			●						
					○						

SPUN
General



Cutting Speed			Vc (ft/min.)											
ISO	VDI	Sub Group	YG602		YG622		YG712		YG603		YG501		YG5020	
			Min	Max	Min	Max	Min	Max	Min	Max	Min	Max	Min	Max
P	1~5	Non-Alloyed Steel	460	1250	460	1310	560	980	300	750	-	-	-	-
	6~9	Low-Alloyed Steel	390	980	390	1050	590	820	230	690	-	-	-	-
	10~11	High-Alloyed Steel	230	490	230	560	330	460	200	330	-	-	-	-
M	12~13	Ferritic & Martensitic	390	660	-	-	-	-	260	590	-	-	-	-
	14	Austenitic Stainless Steel	430	820	-	-	-	-	330	660	-	-	-	-
K	15~16	Grey Cast Iron	390	820	390	890	-	-	-	-	590	1150	660	1150
	17~18	Nodular Cast Iron	430	720	430	790	-	-	-	-	390	890	490	980
N	21~30	Non-Ferrous Metals (Al)	-	-	-	-	-	-	-	-	-	-	-	-
S	31~37	Superalloys & Titanium	80	150	-	-	-	-	70	130	-	-	-	-
H	38~41	Hard Materials	130	260	130	330	-	-	-	-	160	300	-	-

Milling - Shoulder Milling - Cutter

Cutters for APKT, APMT, APXT

Cutting Angle : 90°
2 Corner Positive

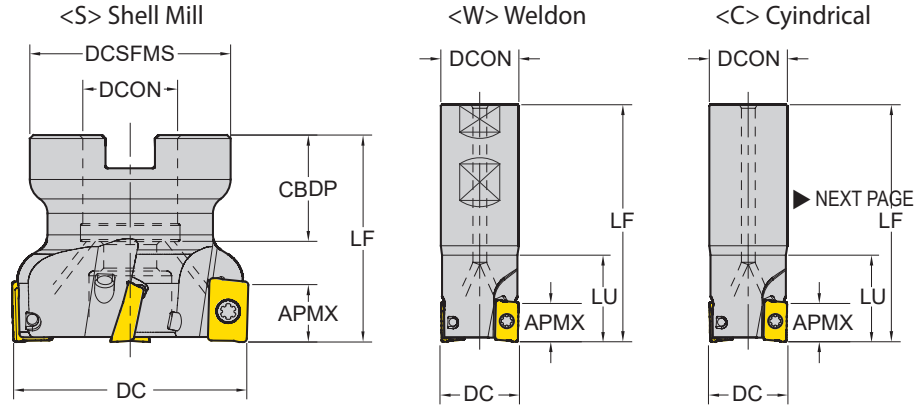

ZAFP : Effective Number of Cutting Edges
CICT : Number of Inserts
CDBP : Connection Bore Depth

□ : p. 85 Unit: inch

Series	APMX	Designation	EDP 1700..	DC	ZAFP	LU	LF	TYPE	DCON	CDBP	DCSFMS	PCD1	PCD2	⦿
APKT 1003	.394	E90-APKT10-D100Z4C075-L600i	0149	1.00	4	-	6.00	Cyindrical	0.75	-	-	-	-	●
		E90-APKT10-D0625Z2W0625-L350i	0144	0.625	2	-	3.50	Weldon	0.625	-	-	-	-	●
		E90-APKT10-D075Z3W075-L320i	0146	0.75	3	-	3.20		0.75	-	-	-	-	●
		E90-APKT10-D100Z4W100-L400i	0148	1.00	4	-	4.00		1	-	-	-	-	●
		F90-APKT10-D150Z4S075i	0150	1.50	4	-	1.575		Shell Mill	0.75	-	-	-	-
		F90-APKT10-D200Z7S075i	0151	2.00	7	-	1.75	0.75		-	-	-	-	●
APKT 1604	.630	E90-APKT16-D100Z2C0875-L378i	0089	1.00	2	-	3.78	Cyindrical	.875	-	-	-	-	●
		E90-APKT16-D125Z3C100-L428i	0090	1.25	3	-	4.28		1.00	-	-	-	-	●
		E90-APKT16-D100Z2W100-L400i	0158	1.00	2	-	4.00	Weldon	1	-	-	-	-	●
		E90-APKT16-D100Z2W100-L1000i	0208	1.00	2	-	10.00		1	-	-	-	-	●
		E90-APKT16-D125Z3W100-L400i	0159	1.25	3	-	4.00		1	-	-	-	-	●
		E90-APKT16-D125Z3W125-L1000i	0205	1.25	3	-	10.00		1.25	-	-	-	-	●
		E90-APKT16-D125Z4W125-L1000i	0206	1.25	4	-	10.00		1.25	-	-	-	-	●
		F90-APKT16-D200Z5S075i	0160	2.00	5	-	1.75		Shell Mill	0.75	-	-	-	-
		F90-APKT16-D250Z6S075i	0161	2.50	6	-	1.75	0.75		-	-	-	-	X
		F90-APKT16-D300Z7S100i	0162	3.00	7	-	2.00	1		-	-	-	-	●
		F90-APKT16-D400Z8S150i	0207	4.00	8	-	2.00	1.5		-	-	-	-	●

▶ NEXT PAGE

Milling - Shoulder Milling - Cutter

Cutters for APKT, APMT, APXT

Cutting Angle : 90°
2 Corner Positive

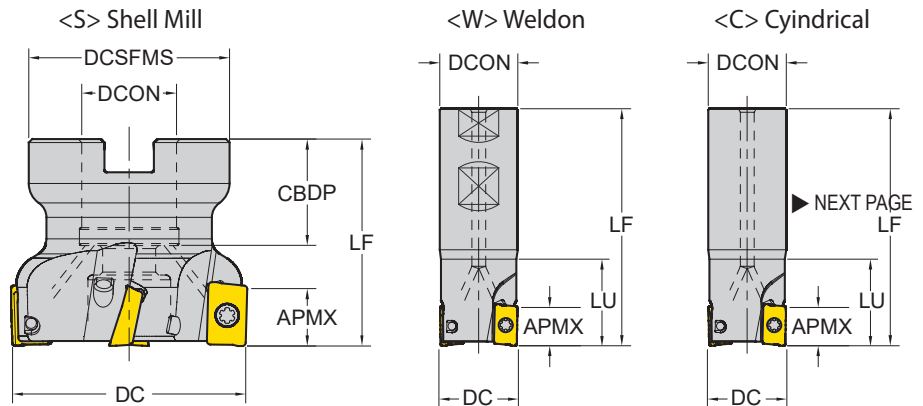

ZAFP : Effective Number of Cutting Edges
CICT : Number of Inserts
CBDP : Connection Bore Depth

□ : p.86 / 87 Unit:inch

Series	APMX	Designation	EDP 1700..	DC	ZAFP	LU	LF	TYPE	DCON	CBDP	DCSFMS	PCD1	PCD2	☉
APMT 1135	.390	E90-APMT11-D0625Z2C0625-L400i	0098	0.625	2	-	4.00	Cylindrical	0.625	-	-	-	-	●
		E90-APMT11-D075Z2W075-L354i	0099	0.75	2	-	3.54	Weldon	0.75	-	-	-	-	●
		E90-APMT11-D100Z4W100-L428i	0100	1.00	4	-	4.28		1.00	-	-	-	-	●
		E90-APMT11-D125Z4W100-L428i	0101	1.25	4	-	4.28		1.00	-	-	-	-	●
APMT, APXT 1604	.630	E90-APMT16-D125Z3W125-L390i	0106	1.25	3	-	3.90	Weldon	1.25	-	-	-	-	●

Milling - Shoulder Milling - Inserts

ADKT / AOMT - Shoulder Milling Positive (2 Corner)

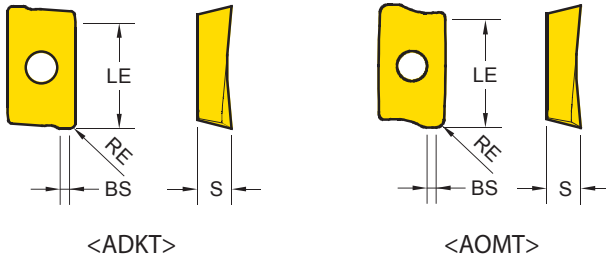

Series	LE	IC	S
ADKT 1505	.539	.382	.228
AOMT 1236	.413	.260	.142

EDP 1200..

●: Stock item ○: Order made item

P25	P30	P20	P40		
M30			M35		
K30	K30			K15	K15
S20			S30	H15	

ADKT	Designation	RE (in)	Fz (in/tooth)	BS (in)	YG602	YG622	YG712	YG603	YG501	YG5020
	ADKT 150508 PDTR	.031	.006 ~ .012	.074	● 0220					

ADKT
General



AOMT	Designation	RE (in)	Fz (in/tooth)	BS (in)	YG602	YG622	YG712	YG603	YG501	YG5020
	AOMT 123604 PDTR	.016	.003 ~ .009	.042	● 0217					
	AOMT 123608 PDTR	.031	.003 ~ .009	.036	● 0218					

AOMT
General



Cutting Speed			Vc (ft/min.)											
ISO	VDI	Sub Group	YG602		YG622		YG712		YG603		YG501		YG5020	
			Min	Max	Min	Max	Min	Max	Min	Max	Min	Max	Min	Max
P	1~5	Non-Alloyed Steel	460	1250	460	1310	560	980	300	750	-	-	-	-
	6~9	Low-Alloyed Steel	390	980	390	1050	590	820	230	690	-	-	-	-
	10~11	High-Alloyed Steel	230	490	230	560	330	460	200	330	-	-	-	-
M	12~13	Ferritic & Martensitic	390	660	-	-	-	-	260	590	-	-	-	-
	14	Austenitic Stainless Steel	430	820	-	-	-	-	330	660	-	-	-	-
K	15~16	Grey Cast Iron	390	820	390	890	-	-	-	-	590	1150	660	1150
	17~18	Nodular Cast Iron	430	720	430	790	-	-	-	-	390	890	490	980
N	21~30	Non-Ferrous Metals (Al)	-	-	-	-	-	-	-	-	-	-	-	-
S	31~37	Superalloys & Titanium	80	150	-	-	-	-	70	130	-	-	-	-
H	38~41	Hard Materials	130	260	130	330	-	-	-	-	160	300	-	-

Milling - Shoulder Milling - Inserts

APKT - Shoulder Milling Positive (2 Corner)

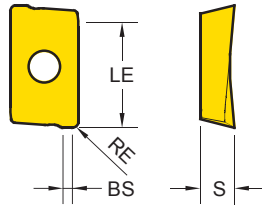

Series	LE	IC	S
APKT 1003	.390	.264	.142
APKT 1604	.598	.370	.209

EDP 1200..

●: Stock item ○: Order made item

P25	P30	P20	P40		
M30			M35		
K30	K30			K15	K15
S20			S30	H15	

APKT	Designation	RE (in)	Fz (in/tooth)	BS (in)	Material / Grade					
					YG602	YG622	YG712	YG603	YG501	YG5020
APKT General	APKT 100305 PDTR	.020	.006 ~ .009	.034	●					
	APKT 100308 PDTR	.031	.006 ~ .009	.035	●					
	APKT 160404 PDTR	.016	.006 ~ .010	.044	●					
	APKT 160408 PDTR	.031	.006 ~ .012	.052	●					
	APKT 160412 PDTR	.047	.006 ~ .013	.094	●					
	APKT 160416 PDTR	.063	.006 ~ .013	.094	●					
	APKT 160424 PDTR	.094	.006 ~ .015	.059	●					
-ST Stainless Steel Super Alloy	APKT 100305 -ST	.020	.003 ~ .009	.034	●					
	APKT 160408 -ST	.031	.003 ~ .010	.052	●					
-TR Hardened Steel	APKT 160404 -TR	.016	.010 ~ .016	.068	●	●				
	APKT 160408 -TR	.031	.010 ~ .016	.052	●	●				
	APKT 160412 -TR	.047	.010 ~ .016	.094	●	●				
	APKT 160416 -TR	.063	.010 ~ .016	.094	●	●				
	APKT 160424 -TR	.094	.010 ~ .016	.059	●	●				

Cutting Speed			Vc (ft./min.)											
ISO	VDI	Sub Group	YG602		YG622		YG712		YG603		YG501		YG5020	
			Min	Max	Min	Max	Min	Max	Min	Max	Min	Max	Min	Max
P	1~5	Non-Alloyed Steel	460	1250	460	1310	560	980	300	750	-	-	-	-
	6~9	Low-Alloyed Steel	390	980	390	1050	590	820	230	690	-	-	-	-
	10~11	High-Alloyed Steel	230	490	230	560	330	460	200	330	-	-	-	-
M	12~13	Ferritic & Martensitic	390	660	-	-	-	-	260	590	-	-	-	-
	14	Austenitic Stainless Steel	430	820	-	-	-	-	330	660	-	-	-	-
K	15~16	Grey Cast Iron	390	820	390	890	-	-	-	-	590	1150	660	1150
	17~18	Nodular Cast Iron	430	720	430	790	-	-	-	-	390	890	490	980
N	21~30	Non-Ferrous Metals (Al)	-	-	-	-	-	-	-	-	-	-	-	-
S	31~37	Superalloys & Titanium	80	150	-	-	-	-	70	130	-	-	-	-
H	38~41	Hard Materials	130	260	130	330	-	-	-	-	160	300	-	-

Milling - Shoulder Milling - Inserts

APXT - Shoulder Milling Positive (2 Corner)

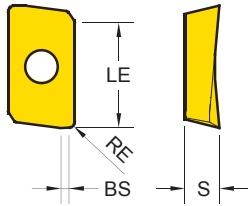

Series	LE	IC	S
APXT 1604	.575	.362	.189

EDP 1200..

●: Stock item ○: Order made item

P25	P30	P20	P40			
M30			M35			
K30	K30			K15	K15	
S20			S30	H15		N15
YG602	YG622	YG712	YG603	YG501	YG5020	YG50
						○ 0528

APXT	Designation	RE (in)	Fz (in/tooth)	BS (in)	YG602	YG622	YG712	YG603	YG501	YG5020	YG50
	APXT 160408-AL	.031	.004 ~ .012	.069							○ 0528

-AL
Aluminium



TURNING

PARTING & GROOVING

MILLING

DRILLING

TECHNICAL INFORMATION

Cutting Speed			Vc (ft/min.)													
ISO	VDI	Sub Group	YG602		YG622		YG712		YG603		YG501		YG5020		YG50	
			Min	Max	Min	Max	Min	Max	Min	Max	Min	Max	Min	Max	Min	Max
P	1~5	Non-Alloyed Steel	460	1250	460	1310	560	980	300	750	-	-	-	-	-	-
	6~9	Low-Alloyed Steel	390	980	390	1050	590	820	230	690	-	-	-	-	-	-
	10~11	High-Alloyed Steel	230	490	230	560	330	460	200	330	-	-	-	-	-	-
M	12~13	Ferritic & Martensitic	390	660	-	-	-	-	260	590	-	-	-	-	-	-
	14	Austenitic Stainless Steel	430	820	-	-	-	-	330	660	-	-	-	-	-	-
K	15~16	Grey Cast Iron	390	820	390	890	-	-	-	-	590	1150	660	1150	-	-
	17~18	Nodular Cast Iron	430	720	430	790	-	-	-	-	390	890	490	980	-	-
N	21~30	Non-Ferrous Metals (Al)	-	-	-	-	-	-	-	-	-	-	-	-	980	2620
S	31~37	Superalloys & Titanium	80	150	-	-	-	-	70	130	-	-	-	-	-	-
H	38~41	Hard Materials	130	260	130	330	-	-	-	-	160	300	-	-	-	-

Milling - Shoulder Milling - Inserts

APMT - Shoulder Milling Positive (2 Corner)

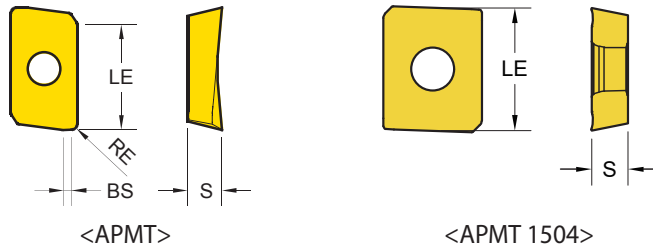

Series	LE	IC	S
APMT 1135	.374	.244	.138
APMT 1604	.575	.362	.187
APMT 1504	.551	.500	.187

EDP 1200..

●: Stock item ○: Order made item

P25	P30	P20	P40		
M30			M35		
K30	K30			K15	K15
S20			S30	H15	

APMT		Designation	RE (in)	Fz (in/tooth)	BS (in)	YG602	YG622	YG712	YG603	YG501	YG5020
APMT General		APMT 113504 PDTR	.016	.006 ~ .009	.050	● 0009					
		APMT 113508 PDTR	.031	.006 ~ .010	.042	● 0010					
		APMT 160408 PDTR	.031	.006 ~ .012	.044	● 0008		● 0423	● 0465	● 0464	
APMT 1504 General		APMT 1504		.006 ~ .011		● 0276	● 0445				

Cutting Speed			Vc (ft/min.)											
ISO	VDI	Sub Group	YG602		YG622		YG712		YG603		YG501		YG5020	
			Min	Max	Min	Max	Min	Max	Min	Max	Min	Max	Min	Max
P	1~5	Non-Alloyed Steel	460	1250	460	1310	560	980	300	750	-	-	-	-
	6~9	Low-Alloyed Steel	390	980	390	1050	590	820	230	690	-	-	-	-
	10~11	High-Alloyed Steel	230	490	230	560	330	460	200	330	-	-	-	-
M	12~13	Ferritic & Martensitic	390	660	-	-	-	-	260	590	-	-	-	-
	14	Austenitic Stainless Steel	430	820	-	-	-	-	330	660	-	-	-	-
K	15~16	Grey Cast Iron	390	820	390	890	-	-	-	-	590	1150	660	1150
	17~18	Nodular Cast Iron	430	720	430	790	-	-	-	-	390	890	490	980
N	21~30	Non-Ferrous Metals (Al)	-	-	-	-	-	-	-	-	-	-	-	-
S	31~37	Superalloys & Titanium	80	150	-	-	-	-	70	130	-	-	-	-
H	38~41	Hard Materials	130	260	130	330	-	-	-	-	160	300	-	-

Milling - Shoulder Milling - Inserts

TPKN / KR / CN - Shoulder Milling Positive (3 Corner ISO)

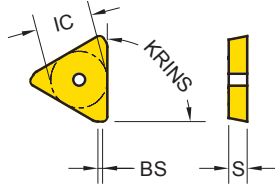



Series	KRINS	IC	S
TP** 32	90°	.375	.125
TP** 43	90°	.500	.187

EDP 1200..

● : Stock item ○ : Order made item

P25	P30	P20	P40		
M30			M35		
K30	K30			K15	K15
S20			S30	H15	

TPKR	TPKN	TPCN	Designation	RE (in)	Fz (in/tooth)	BS (in)	YG602	YG622	YG712	YG603	YG501	YG5020
TPKR General 			TPKR 32 PDTR		.006 ~ .011	.047	● 0060					
			TPKR 32 PDTR-PW		.004 ~ .008	.072	● 0300					
			TPKR 43 PDTR		.007 ~ .014	.067	● 0061					
			TPKR 43 PDTR-PW		.007 ~ .014	.080	● 0301					
TPKN Hard Materials 			TPKN 32 PDTR		.006 ~ .012	.047	● 0062					
			TPKN 32 PDTR-PW		.006 ~ .011	.072	● 0302					
			TPKN 32 PDTR-GW		.006 ~ .012	.064	● 0306					
			TPKN 43 PDTR		.007 ~ .012	.067	● 0063					
			TPKN 43 PDTR-PW		.009 ~ .016	.080	● 0303					
			TPKN 43 PDTR-GW		.009 ~ .016	.098	● 0307					
TPCN Ground insert 			TPCN 43 PDSR-M		.002 ~ .008	.069			● 0180			
			TPCN 43 PDSR-MR		.002 ~ .008	.069			● 0202			

- PW : for Improved Surface Roughness
- GW : Ground Wiper
- M : for Mold & Die
- MR : for Mold & Die Roughing

Cutting Speed			Vc (ft/min.)											
ISO	VDI	Sub Group	YG602		YG622		YG712		YG603		YG501		YG5020	
			Min	Max	Min	Max	Min	Max	Min	Max	Min	Max	Min	Max
P	1~5	Non-Alloyed Steel	460	1250	460	1310	560	980	300	750	-	-	-	-
	6~9	Low-Alloyed Steel	390	980	390	1050	590	820	230	690	-	-	-	-
	10~11	High-Alloyed Steel	230	490	230	560	330	460	200	330	-	-	-	-
M	12~13	Ferritic & Martensitic	390	660	-	-	-	-	260	590	-	-	-	-
	14	Austenitic Stainless Steel	430	820	-	-	-	-	330	660	-	-	-	-
K	15~16	Grey Cast Iron	390	820	390	890	-	-	-	-	590	1150	660	1150
	17~18	Nodular Cast Iron	430	720	430	790	-	-	-	-	390	890	490	980
N	21~30	Non-Ferrous Metals (Al)	-	-	-	-	-	-	-	-	-	-	-	-
S	31~37	Superalloys & Titanium	80	150	-	-	-	-	70	130	-	-	-	-
H	38~41	Hard Materials	130	260	130	330	-	-	-	-	160	300	-	-

Milling - Shoulder Milling - Inserts

TPUN - Universal Positive (3 Corners ISO)

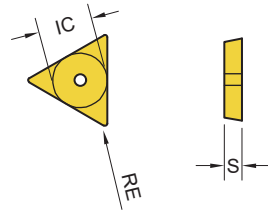

Series	IC	S
TPUN 32	.375	.125

EDP 1200..

●: Stock item ○: Order made item

P25	P30	P20	P40		
M30			M35		
K30	K30			K15	K15
S20			S30	H15	

TPUN	Designation	RE (in)	Fz (in/tooth)	BS (in)	YG602	YG622	YG712	YG603	YG501	YG5020
					●	○	○	○	○	○
	TPUN 322	.031			● 0064					

TPUN



TURNING

PARTING & GROOVING

MILLING

DRILLING

TECHNICAL INFORMATION

Cutting Speed			Vc (ft/min.)											
ISO	VDI	Sub Group	YG602		YG622		YG712		YG603		YG501		YG5020	
			Min	Max	Min	Max	Min	Max	Min	Max	Min	Max	Min	Max
P	1~5	Non-Alloyed Steel	460	1250	460	1310	560	980	300	750	-	-	-	-
	6~9	Low-Alloyed Steel	390	980	390	1050	590	820	230	690	-	-	-	-
	10~11	High-Alloyed Steel	230	490	230	560	330	460	200	330	-	-	-	-
M	12~13	Ferritic & Martensitic	390	660	-	-	-	-	260	590	-	-	-	-
	14	Austenitic Stainless Steel	430	820	-	-	-	-	330	660	-	-	-	-
K	15~16	Grey Cast Iron	390	820	390	890	-	-	-	-	590	1150	660	1150
	17~18	Nodular Cast Iron	430	720	430	790	-	-	-	-	390	890	490	980
N	21~30	Non-Ferrous Metals (Al)	-	-	-	-	-	-	-	-	-	-	-	-
S	31~37	Superalloys & Titanium	80	150	-	-	-	-	70	130	-	-	-	-
H	38~41	Hard Materials	130	260	130	330	-	-	-	-	160	300	-	-

Milling - Profiling - Cutter

Cutters for RDKT, RDKW

Round Positive

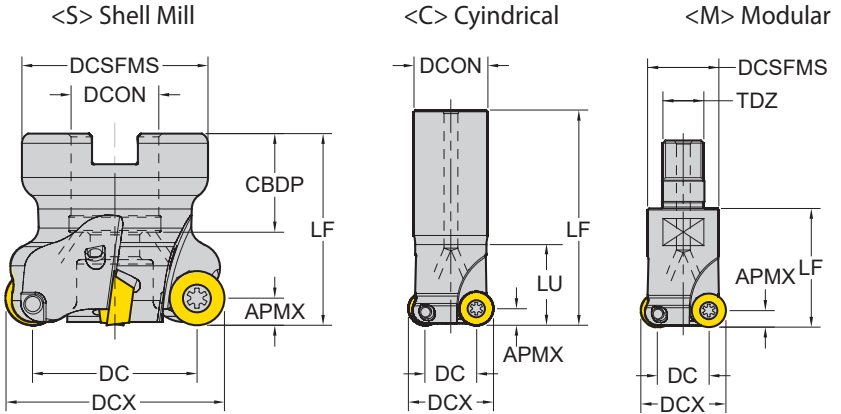

ZEPF : Effective Number of Cutting Edges
 CDBP : Connection Bore Depth

□ : p. 91 Unit : inch

Series	APMX	Designation	EDP 1700..	DC	DCX	ZEPF	LU	LF	TYPE	DCON /TDZ	CDBP	DCSFMS	🔴
RDKT, RDKW 0802	.157	E-RDKT08-D075Z2C075-L700i	0044	.435	.75	2	-	7.00	Cylindrical	.75	-	-	●
		E-RDKT08-D100Z3C075-L700i	0045	.685	1.00	3	-	7.00		.75	-	-	●
		M-RDKT08-D075Z2M10i	0046	.435	.75	2	-	1.25	Modular	M10	-	-	●
		M-RDKT08-D100Z3M12i	0047	.685	1.00	3	-	1.50		M12	-	-	●
RDKT, RDKW 10T3	.196	E-RDKT10-D100Z2C100-L700i	0048	.606	1.00	2	-	7.00	Cylindrical	1	-	-	●
		M-RDKT10-D100Z3M12i	0049	.606	1.00	3	-	1.50	Modular	M12	-	0.827	●
		F-RDKT10-D150Z5S050i	0050	1.106	1.50	5	-	1.575	Shell Mill	.50	.71	1.25	●
		F-RDKT10-D200Z6S075i	0051	1.606	2.00	6	-	1.75		.75	.79	1.575	●
RDKT, RDKW 1204	.236	E-RDKT12-D100Z2C100-L700i	0052	.527	1.00	2	-	7.00	Cylindrical	1	-	-	●
		E-RDKT12-D125Z2C125-L800i	0053	.777	1.25	2	-	8.00		1.25	-	-	●
		E-RDKT12-D125Z3C125-L600i	0054	.777	1.25	3	-	6.00		1.25	-	-	●
		M-RDKT12-D100Z2M12i	0055	.527	1.00	2	-	1.50	Modular	M12	-	.827	●
		M-RDKT12-D125Z3M16i	0056	.777	1.25	3	-	1.50		M16	-	1.142	●
		F-RDKT12-D150Z4S050i	0057	1.027	1.50	4	-	1.575	Shell Mill	.50	.71	1.25	●
		F-RDKT12-D200Z5S075i	0058	1.527	2.00	5	-	1.75		.75	.79	1.575	
		F-RDKT12-D250Z6S075i	0059	2.027	2.50	6	-	1.75		.75	.79	1.75	

Milling - Profiling - Inserts

RDKT / W- Profiling Positive (Round)

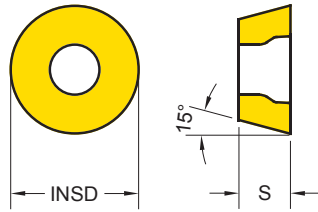

Series	INSD	S	Series	INSD	S
RDK* 0501	.197	.055	RDK* 10T3	.394	.157
RDK* 0702	.276	.094	RDK* 1204	.472	.189
RDK* 0802	.315	.094			

EDP 1200..

●: Stock item ○: Order made item

P25	P30	P20	P40		
M30			M35		
K30	K30			K15	K15
S20			S30	H15	

RDKT RDKW		Designation	Fz (in/tooth)	YG602	YG622	YG712	YG603	YG501	YG5020
RDKT General		RDKT 0802M0	.006 ~ .010	● 0035					
		RDKT 10T3M0	.006 ~ .011	● 0041					
		RDKT 1204M0	.008 ~ .012	● 0034					
-ST Stainless Steel Super Alloy		RDKT 0802M0-ST	.003 ~ .010	● 0292					
		RDKT 10T3M0-ST	.003 ~ .011	● 0293					
		RDKT 1204M0-ST	.004 ~ .012	● 0294					
-TR Hardened Steel		RDKT 0802M0-TR	.007 ~ .014	● 0284	● 0339				
		RDKT 10T3M0-TR	.009 ~ .016	● 0285	● 0338				
		RDKT 1204M0-TR	.009 ~ .016	● 0272	● 0340				
RDKW Hard Materials		RDKW 0501M0	.004 ~ .008	● 0207					
		RDKW 0702M0	.005 ~ .010	● 0208					
		RDKW 0802M0	.005 ~ .010	● 0043					
		RDKW 10T3M0	.006 ~ .012	● 0040					
		RDKW 1204M0	.006 ~ .014	● 0042					

Cutting Speed			Vc (ft/min.)											
ISO	VDI	Sub Group	YG602		YG622		YG712		YG603		YG501		YG5020	
			Min	Max	Min	Max	Min	Max	Min	Max	Min	Max	Min	Max
P	1~5	Non-Alloyed Steel	460	1250	460	1310	560	980	300	750	-	-	-	-
	6~9	Low-Alloyed Steel	390	980	390	1050	590	820	230	690	-	-	-	-
	10~11	High-Alloyed Steel	230	490	230	560	330	460	200	330	-	-	-	-
M	12~13	Ferritic & Martensitic	390	660	-	-	-	-	260	590	-	-	-	-
	14	Austenitic Stainless Steel	430	820	-	-	-	-	330	660	-	-	-	-
K	15~16	Grey Cast Iron	390	820	390	890	-	-	-	-	590	1150	660	1150
	17~18	Nodular Cast Iron	430	720	430	790	-	-	-	-	390	890	490	980
N	21~30	Non-Ferrous Metals (Al)	-	-	-	-	-	-	-	-	-	-	-	-
S	31~37	Superalloys & Titanium	80	150	-	-	-	-	70	130	-	-	-	-
H	38~41	Hard Materials	130	260	130	330	-	-	-	-	160	300	-	-

Milling - Profiling - Inserts

RDMT / W- Profiling Positive (Round)

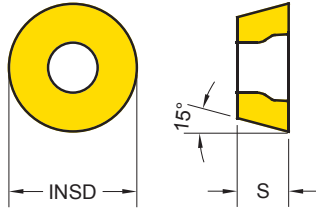

Series	INSD	S	Series	INSD	S
RDM* 0802	.315	.094	RDM* 10T3	.394	.156
RDM* 0803	.315	.125	RDM* 1204	.472	.187

EDP 1200..

●: Stock item ○: Order made item

P25	P30	P20	P40		
M30			M35		
K30	K30		S30	H15	K15

RDMT RDMW		Designation	Fz (in/tooth)	YG602	YG622	YG712	YG603	YG501	YG5020
RDMT General		RDMT 0802M0	.006 ~ .010	● 0245					
		RDMT 0803M0	.006 ~ .010	● 0225					
		RDMT 10T3M0	.007 ~ .011	● 0246					
		RDMT 1204M0	.008 ~ .012	● 0226					
RDMW Hard Materials		RDMW 0802M0	.002 ~ .006	● 0227					
		RDMW 10T3M0	.004 ~ .010	● 0228					
		RDMW 1204M0	.006 ~ .012	● 0229					

Cutting Speed			Vc (ft/min.)											
ISO	VDI	Sub Group	YG602		YG622		YG712		YG603		YG501		YG5020	
			Min	Max	Min	Max	Min	Max	Min	Max	Min	Max	Min	Max
P	1~5	Non-Alloyed Steel	460	1250	460	1310	560	980	300	750	-	-	-	-
	6~9	Low-Alloyed Steel	390	980	390	1050	590	820	230	690	-	-	-	-
	10~11	High-Alloyed Steel	230	490	230	560	330	460	200	330	-	-	-	-
M	12~13	Ferritic & Martensitic	390	660	-	-	-	-	260	590	-	-	-	-
	14	Austenitic Stainless Steel	430	820	-	-	-	-	330	660	-	-	-	-
K	15~16	Grey Cast Iron	390	820	390	890	-	-	-	-	590	1150	660	1150
	17~18	Nodular Cast Iron	430	720	430	790	-	-	-	-	390	890	490	980
N	21~30	Non-Ferrous Metals (Al)	-	-	-	-	-	-	-	-	-	-	-	-
S	31~37	Superalloys & Titanium	80	150	-	-	-	-	70	130	-	-	-	-
H	38~41	Hard Materials	130	260	130	330	-	-	-	-	160	300	-	-

Milling - Profiling - Inserts

RPMT / W - Profiling Positive (Round)

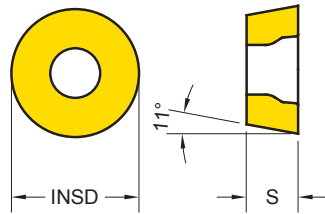

Series	INSD	S
RPM* 08T2	.315	.109
RPM* 10T3	.394	.156
RPM* 1204	.472	.187

EDP 1200..

●: Stock item ○: Order made item

P25	P30	P20	P40		
M30			M35		
K30	K30			K15	K15
S20			S30	H15	

RPMT RPMW		Designation	Fz (in/tooth)	YG602	YG622	YG712	YG603	YG501	YG5020
RPMT General		RPMT 08T2M0	.004 ~ .009	● 0038					
		RPMT 10T3M0	.006 ~ .012	● 0036					
		RPMT 1204M0	.008 ~ .014	● 0037		● 0415	● 0463	● 0462	
-ST Stainless Steel Super Alloy		RPMT 1204M0 -ST	.004 ~ .012	● 0230					
RPMW Hard Materials		RPMW 1003M0	.006 ~ .012	● 0204					
		RPMW 1204M0	.006 ~ .014	● 0039					

Cutting Speed			Vc (ft/min.)											
ISO	VDI	Sub Group	YG602		YG622		YG712		YG603		YG501		YG5020	
			Min	Max	Min	Max	Min	Max	Min	Max	Min	Max	Min	Max
P	1~5	Non-Alloyed Steel	460	1250	460	1310	560	980	300	750	-	-	-	-
	6~9	Low-Alloyed Steel	390	980	390	1050	590	820	230	690	-	-	-	-
	10~11	High-Alloyed Steel	230	490	230	560	330	460	200	330	-	-	-	-
M	12~13	Ferritic & Martensitic	390	660	-	-	-	-	260	590	-	-	-	-
	14	Austenitic Stainless Steel	430	820	-	-	-	-	330	660	-	-	-	-
K	15~16	Grey Cast Iron	390	820	390	890	-	-	-	-	590	1150	660	1150
	17~18	Nodular Cast Iron	430	720	430	790	-	-	-	-	390	890	490	980
N	21~30	Non-Ferrous Metals (Al)	-	-	-	-	-	-	-	-	-	-	-	-
S	31~37	Superalloys & Titanium	80	150	-	-	-	-	70	130	-	-	-	-
H	38~41	Hard Materials	130	260	130	330	-	-	-	-	160	300	-	-

Milling - Profiling - Inserts

RBEX50 - Profiling / Highfeed (3 Corner)

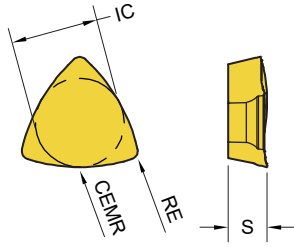

Series	CEMR	IC	S
RBEX50	.984	.500	.219

EDP 1200..

●: Stock item ○: Order made item

P25	P30	P20	P40		
M30			M35		
K30	K30			K15	K15
S20			S30	H15	

RBEX50	Designation	RE (in)	Fz (in/tooth)	YG602	YG622	YG712	YG603	YG501	YG5020
	RBEX 50	.047	.008 ~ .016	● 0277	● 0443				

RBEX50
General

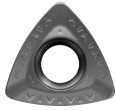

TURNING

PARTING & GROOVING

MILLING

DRILLING

TECHNICAL INFORMATION

Cutting Speed			Vc (ft/min.)											
ISO	VDI	Sub Group	YG602		YG622		YG712		YG603		YG501		YG5020	
			Min	Max	Min	Max	Min	Max	Min	Max	Min	Max	Min	Max
P	1~5	Non-Alloyed Steel	460	1250	460	1310	560	980	300	750	-	-	-	-
	6~9	Low-Alloyed Steel	390	980	390	1050	590	820	230	690	-	-	-	-
	10~11	High-Alloyed Steel	230	490	230	560	330	460	200	330	-	-	-	-
M	12~13	Ferritic & Martensitic	390	660	-	-	-	-	260	590	-	-	-	-
	14	Austenitic Stainless Steel	430	820	-	-	-	-	330	660	-	-	-	-
K	15~16	Grey Cast Iron	390	820	390	890	-	-	-	-	590	1150	660	1150
	17~18	Nodular Cast Iron	430	720	430	790	-	-	-	-	390	890	490	980
N	21~30	Non-Ferrous Metals (Al)	-	-	-	-	-	-	-	-	-	-	-	-
S	31~37	Superalloys & Titanium	80	150	-	-	-	-	70	130	-	-	-	-
H	38~41	Hard Materials	130	260	130	330	-	-	-	-	160	300	-	-

Milling - High Feed Milling - Inserts

SDMT / W - High Feed Positive (4 Corners)

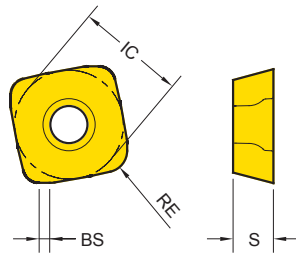

Series	IC	S
SDM* 1204	.500	.185

EDP 1200..

●: Stock item ○: Order made item

P25	P30	P20	P40		
M30			M35		
K30	K30			K15	K15
S20			S30	H15	

SDMT SDMW	Designation	RE (in)	Fz (in/tooth)	BS (in)	Material / Grade					
					YG602	YG622	YG712	YG603	YG501	YG5020
-ST Stainless Steel Super Alloy	SDMT 120420 -ST	.075	.024 ~ .047	.057	● 0274					
SDMW Hard Materials	SDMW 120420	.075	.024 ~ .055	.055	● 0273	● 0341				

Cutting Speed			Vc (ft/min.)											
ISO	VDI	Sub Group	YG602		YG622		YG712		YG603		YG501		YG5020	
			Min	Max	Min	Max	Min	Max	Min	Max	Min	Max	Min	Max
P	1~5	Non-Alloyed Steel	460	1250	460	1310	560	980	300	750	-	-	-	-
	6~9	Low-Alloyed Steel	390	980	390	1050	590	820	230	690	-	-	-	-
	10~11	High-Alloyed Steel	230	490	230	560	330	460	200	330	-	-	-	-
M	12~13	Ferritic & Martensitic	390	660	-	-	-	-	260	590	-	-	-	-
	14	Austenitic Stainless Steel	430	820	-	-	-	-	330	660	-	-	-	-
K	15~16	Grey Cast Iron	390	820	390	890	-	-	-	-	590	1150	660	1150
	17~18	Nodular Cast Iron	430	720	430	790	-	-	-	-	390	890	490	980
N	21~30	Non-Ferrous Metals (Al)	-	-	-	-	-	-	-	-	-	-	-	-
S	31~37	Superalloys & Titanium	80	150	-	-	-	-	70	130	-	-	-	-
H	38~41	Hard Materials	130	260	130	330	-	-	-	-	160	300	-	-

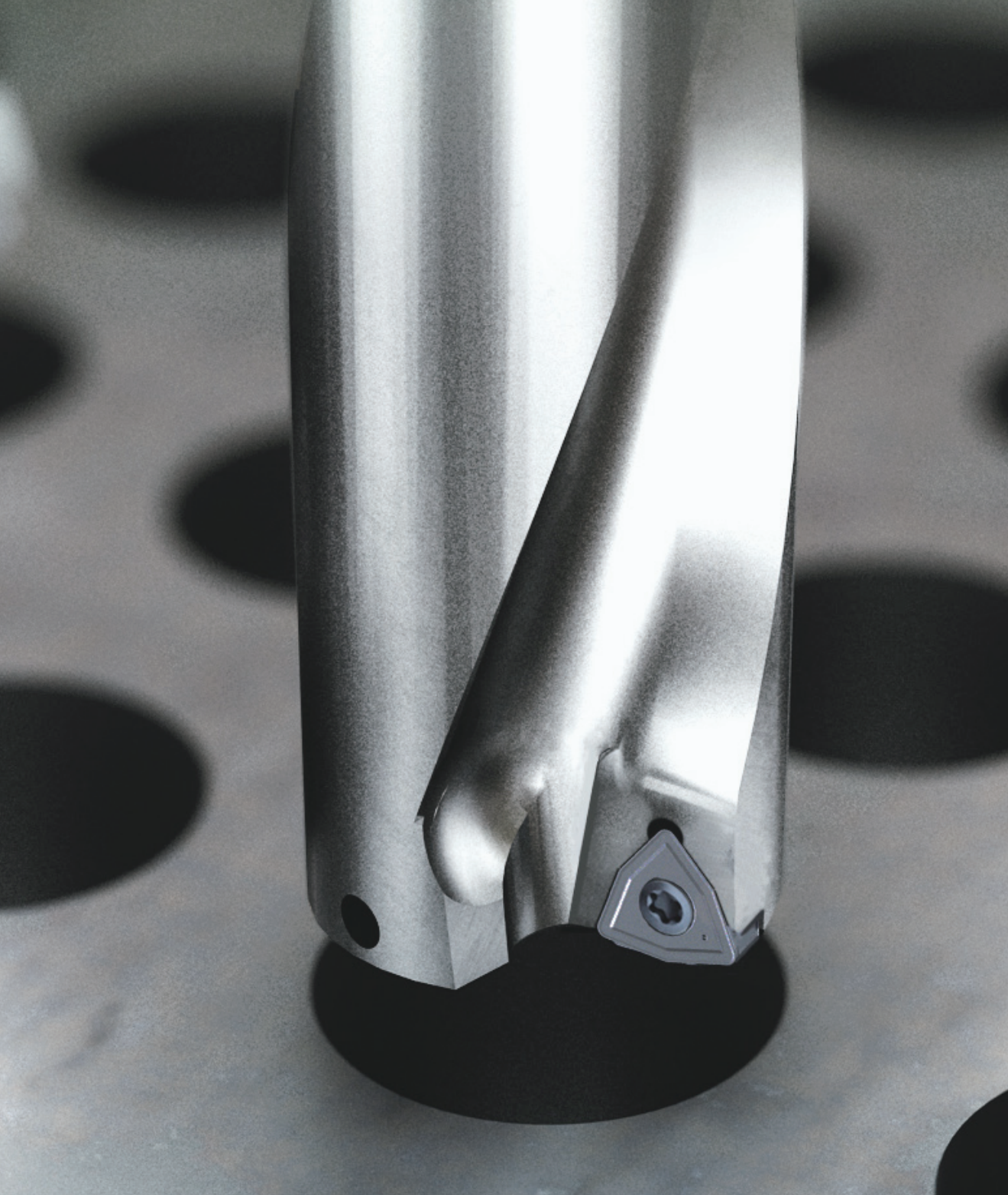

DRILLING

Drilling Overview

Drill Holder

Drilling Inserts (SPMX)

Drilling Inserts (WCMX)

Drilling Overview

Drilling Grades

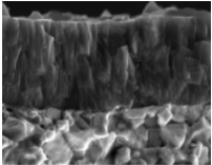

Drilling Grades		P Steel				M Stainless steel				K Cast iron			
		P05	P15	P25	P35	M05	M15	M25	M35	K05	K15	K25	K35
PVD	YG602				602				602				602

YG602 P20 - P35 M20 - M40 K20 - K40 S15 - S25	PVD - TiAlN 	Universal grade for General Drilling Application <ul style="list-style-type: none"> • Ultra Dense PVD Coating with optimal thermal resistance & strength • Sub-Micron substrate designed for demanding application
--	--	---

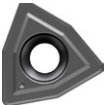
Universal Drilling Inserts

	4 Corner	SPMX Series	SPMX	05, 06, 07, 09, 11, 14
	ISO 3 Corner	WCMX Series	WCMX	03, 04, 05, 06, 08

Drilling Chipbreakers

P	M	K		
	M		-ST	 <ul style="list-style-type: none"> • Sharp Geometry • Sticky Material, Stainless Steel
P	M	K	General Inserts (No Description)	 <ul style="list-style-type: none"> • First Choice for General Application

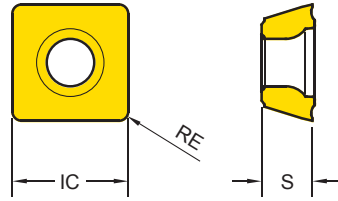

Drilling - Inserts

Drilling Inserts (SPMX)



Series	inch	
	IC	S
SPMX 0502	.197	.094
SPMX 0602	.236	.095
SPMX 07T3	.313	.156
SPMX 0904	.386	.169
SPMX 1104	.453	.193
SPMX 1405	.563	.209

EDP 3200..

SPMX		Designation	Fn (in/rev.)	YG602
SPMX General		SPMX 050204	.003 ~ .006	● 0005
		SPMX 060204	.003 ~ .006	● 0006
		SPMX 07T308	.003 ~ .006	● 0007
		SPMX 090408	.003 ~ .006	● 0008
		SPMX 110408	.004 ~ .007	● 0009
		SPMX 140512	.004 ~ .008	● 0010
-ST Stainless Steel		SPMX 050204 - ST	.001 ~ .004	● 0011
		SPMX 060204 - ST	.002 ~ .004	● 0012
		SPMX 07T308 - ST	.002 ~ .004	● 0013
		SPMX 090408 - ST	.002 ~ .005	● 0014

Cutting Speed			Vc (ft/min.)	
ISO	VDI	Sub Group	YG602	
			Min	Max
P	1~5	Non-Alloyed Steel	460	1250
	6~9	Low-Alloyed Steel	390	980
	10~11	High-Alloyed Steel	230	490
M	12~13	Ferritic & Martensitic	390	660
	14	Austenitic Stainless Steel	430	820
K	15~16	Grey Cast Iron	390	820
	17~18	Nodular Cast Iron	430	720

Drilling - Inserts

Drilling Inserts (WCMX)

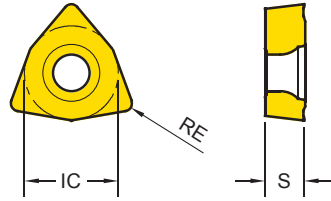

Series	inch	
	IC	S
WCMX 0302	.219	.094
WCMX 0402	.250	.094
WCMX 0503	.313	.125
WCMX 06T3	.375	.156
WCMX 0804	.500	.187

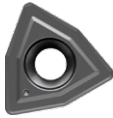
WCMX	Designation	Fn (in/rev.)	EDP 3200..
			YG602
WCMX General 	WCMX 030208	.002~.005	● 0031
	WCMX 040208	.002~.005	● 0003
	WCMX 050308	.002 ~ .006	● 0001
	WCMX 06T308	.003 ~ .006	● 0002
	WCMX 080412	.003 ~ .006	● 0004

ISO	Cutting Speed		Vc (ft/min.)	
	VDI	Sub Group	YG602	
			Min	Max
P	1~5	Non-Alloyed Steel	460	1250
	6~9	Low-Alloyed Steel	390	980
	10~11	High-Alloyed Steel	230	490
M	12~13	Ferritic & Martensitic	390	660
	14	Austenitic Stainless Steel	430	820
K	15~16	Grey Cast Iron	390	820
	17~18	Nodular Cast Iron	430	720

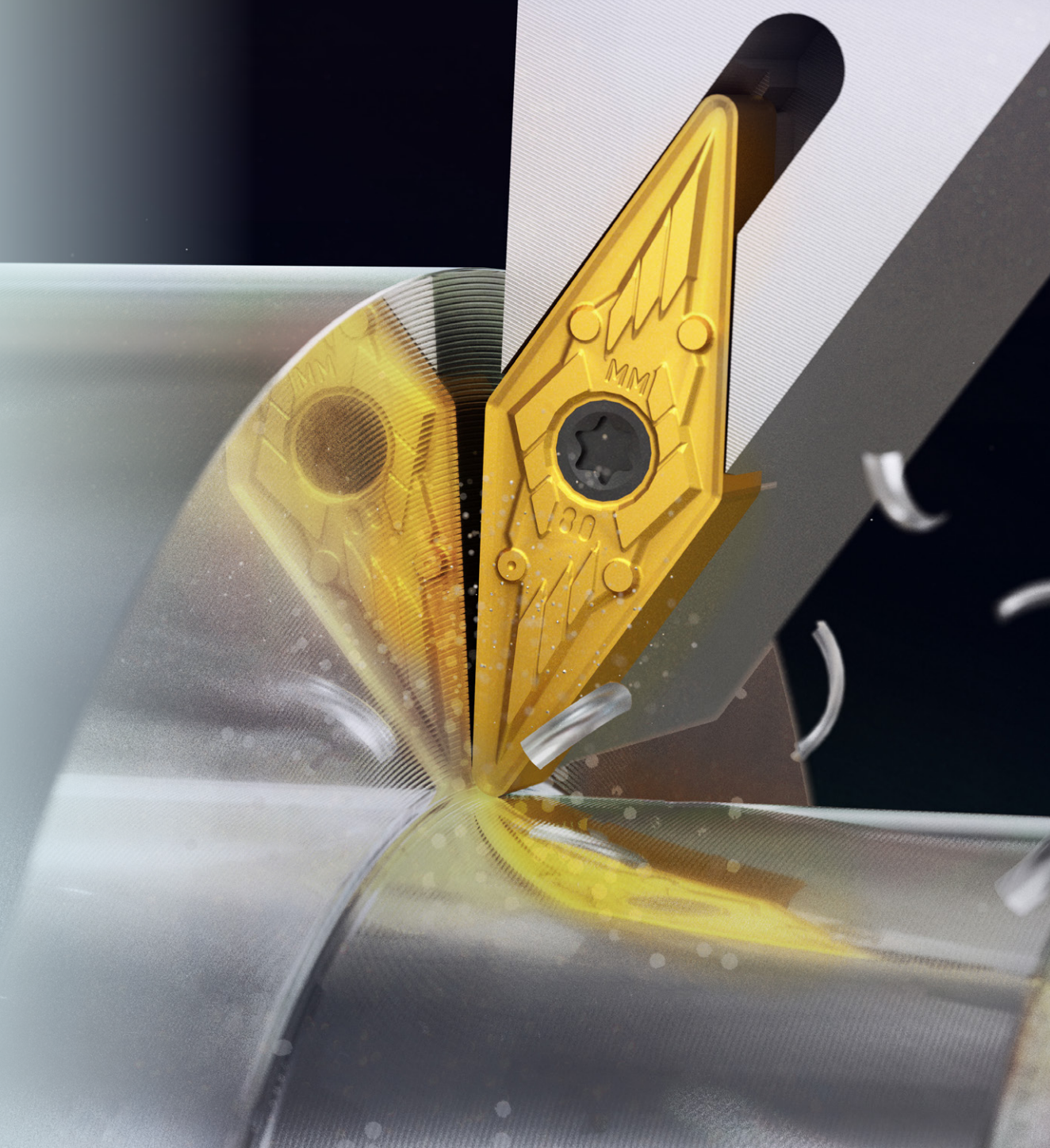

TECHNICAL INFORMATION

**ISO 13399 Terms
Hardness Conversion Table
Material Groups
Comparison Chart
Search**

Technical Information

ISO 13399 Terms

AN	Clearance angle major	INSD	Insert diameter
APMX	Depth of cut maximum	KAPR	Tool cutting edge angle
AS	Clearance angle wiper edge	KRINS	Cutting edge angle major
B	Shank width	KWW	Keyway width
BS	Wiper edge length	L	Cutting edge length
CBDP	Connection bore depth	LE	Cutting edge effective length
CDX	cutting depth maximum	LF	Functional length
CICT	Number of Inserts	LH	Head length
CW	Cutting width	LS	Shank length
CZC	Connection size code	LU	Usable length
DC	Cutting diameter	LUX	Usable length maximum
DCON	Connection diameter	M	Nose (or Wiper) Height
DCSFMS	Contact surface diameter machine side	OAL	Overall length
DCX	Cutting diameter maximum	RE	Corner radius
DMIN	Minimum bore diameter	RMPX	Maximum ramping angle
DMM	Shank diameter	RPMX	Rotational speed maximum
EPSR	Insert included angle	S	Insert thickness
H	Shank height	TDZ	Thread diameter size
HAND	Hand	WF	Functional width
IC	Inscribed circle diameter	ZEFP	Peripheral effective cutting edge count

Technical Information

Hardness Conversion Table

	HB	HRC	HRB	HV	N/mm ²
TURNING	199	15	93	199	667
	203	16	94	201	680
	208	17	95	210	696
	212	18	95	218	706
	216	19	96	222	716
	223	20	97	227	755
	229	21	98	235	775
	233	22	99	241	794
	240	23	100	247	824
	245	24	100	252	838
PARTING & GROOVING	250	25	101	255	853
	255	26	102	258	870
	262	27	103	262	880
	264	28	103	271	892
	271	29	104	277	941
	277	30	105	285	971
	290	31	106	292	990
	300	32	107	303	1020
	308	33	107	311	1035
	314	34	108	320	1049
MILLING	322	35	108	332	1089
	331	36	109	342	1118
	341	37	109	351	1157
	348	38	110	361	1187
	360	39	111	376	1236
	373	40	111	388	1265
	375	41	112	393	1314
	388	42	113	406	1363
	402	43	114	424	1390
	415	44	114	438	1422
DRILLING	419	45	114	448	1447
	430	46	115	458	1471
	445	47	115	474	1520
	456	48	116	490	1569
	468	49	117	497	
	469	50	117	505	
	486	51	118	531	
	504	52	118	549	
	513	53	119	567	
	534	54	120	589	
TECHNICAL INFORMATION	552	55		649	
	572	56		694	
	592	57		727	
	601	58		746	
	613	59			
	627	60			
	642	61			
	658	62			
	681	63			
	695	64			
	HB	HRC	HRB	HV	N/mm ²

Technical Information

Material Groups

Please visit
globalyg1.com/mat
 for material search



ISO	VDI 3323	Material Description	Composition / Structure / Heat Treatment		HB	HRc	Examples	Page	
P	1	Non-alloyed steel	About 0.15% C	Annealed	125		S15C, C15, 1015	104	
	2		About 0.45% C	Annealed	190	13	S45C, C45, 1045		
	3		About 0.45% C	Quenched & tempered	250	25			
	4		About 0.75% C	Annealed	270	28	SK5, Ck75, 1080		
	5		About 0.75% C	Quenched & Tempered	300	32			
	6	Low-alloyed Steel		Annealed	180	10	SCM440, 42CrMo4, 410		
	7			Quenched & Tempered	275	29			
	8			Quenched & Tempered	300	32			
	9			Quenched & Tempered	350	38			
	10	High-alloyed steel, and tool steel		Annealed	200	15	SKD, D2		
	11			Quenched & Tempered	325	35	SKH, SUH, M42		
M	12	Stainless Steel	Ferritic / Martensitic	Annealed	200	15	SUS 420, X40Cr13, 420	111	
	13		Martensitic	Quenched & Tempered	240	23			
	14		Austenitic		180	10	SUS 316, 316, X5CrNiMo 17 12 2		
K	15	Grey cast iron	Pearlitic / Ferritic		180	10	FC, GG, EN-GJL-250	113	
	16		Pearlitic (Martensitic)		260	26			
	17	Nodular cast iron	Ferritic		160	3	FCD, GGG, EN-GJS-500-7		
	18		Pearlitic		250	25			
	19	Malleable cast iron	Ferritic		130		FCMW, FCMP, GTS, GJMB350-10		
	20		Pearlitic		230	21			
N	21	Aluminum-wrought alloy	Not Curable		60		SAE 1000, AlMg 1, 3.3315	115	
	22		Curable	Hardened	100				SAE 7050, AlCuMg 1, 3.1325
	23	Aluminum-cast, alloyed	≤ 12% Si, Not Curable		75		ADC12, G-AlSi12, 3.2581		
	24		≤ 12% Si, Curable	Hardened	90				
	25		> 12% Si, Not Curable		130				
	26		Cutting Alloys, PB>1%		110				CuZn36Pb 3, 2.0375
	27	Copper and copper alloys (Bronze / Brass)	CuZn, CuSnZn (Brass)		90		CuZn 15, 2.0240		
	28		CuSn, lead-free copper and electrolytic copper		100		G-CuZn40Fe, 2.0590		
	29	Non-metallic materials	Duroplastic, Fiber Reinforced Plastic						CFRP
	30		Rubber, Wood, etc.						
S	31	Heat resistant super alloys	Fe Based	Annealed	200	15	X12 NiCrSi 36-16, 1.4864	117	
	32			Aged	280	30			
	33			Annealed	250	25			Inconel 718, NiCr20TiAl, 2.4631
	34		Ni or Co Based	Aged	350	38			NiCu30Al, 2.4375
	35			Cast	320	34			G-X120Mn12, 1.3401
	36	Titanium alloys	Pure Titanium		400 Rm		TiAl6V4, 3.7165		
	37		Alpha + Beta Alloys	Hardened	1050Rm				
H	38	Hardened steel			550	55	SK3	119	
	39				630	60			
	40	Chilled cast iron	Cast		400	42			
	41	Hardened cast iron	Hardened		550	55			

Technical Information

Material Groups

Please visit
globalyg1.com/mat
 for material search

P

VDI 3323
1

Material Description
Non-alloyed steel

Composition / Structure / Heat Treatment
About 0.15% C, Annealed

HB
125

HRC

Mat'l No.	JIS	DIN	AISI/ASTM/SAE	BS	EN	AFNOR	SS	UNI	UNE / IHA	UNS	GOST	Brands
1.0037	STKM 12 C	St 37-2	-	4360 40 B	S235JR	E24-2	1311	Fe 360 B			16D	
1.0038	STKM 12 A	St 37-3	A570.36	4360 40 C	S275J2G3	E28-3	1312	Fe 360 D FF			ST14KP	
1.0045	SM 490 YA	S 355 JR	-	-	S 1207	E36-2	-	Fe 510 BFN				
1.0050	SS 50	St 50-2	A570 Gr. 50	4360 50 B	E 295	A50-2	2172	Fe 490			ST5PS	
1.0060	SM 58	St 60-2	A572 Gr. 65	4360 55 E	-	A60-2	1650	Fe 60-2			ST6PS	
1.0114		S 235 J0	-	En 40C	S 235 J0	E24-3		Fe 360 CFN				
1.0143		S 275 J0	-	-	S 275 J0	E28-3	1414	Fe 430 C				
1.0144	SM41C, SM400	St 44-3 N	A573 Gr. 81	4360 43C	S 275 J2 G3	E28-3	1412	Fe 430 D FF			ST14KP	
1.0149		Ro St 44-2	-	43C	S 275 J0 H	-	1412	Fe430C				
1.0301	S10C	C10	1010	045M10	C10	34C10, XC10		C10	F.1511	G10100	10	
1.0330	SPCC	St 12	-	DC 01	Fe P01	DC 01/Fe P01	1142	Fe P01			15KP	
1.0335	SPHE	DD 13 (StW 24)	A622(1008)	H S 3	DD 13	3C		FeP13			08KP	
1.0338	SPCE	St 4	A620(1008)	14491CR	Fe P04	Fe 14	1147	DC04/FeP04			08JU	
1.0345	SPV 50	P235 GH	A516 Gr. 65	P 235 GH	P 235 GH	A 37 CP	1330	Fe E 235		K02503		
1.0401	S15C	C15	1015	080M15	-	C18RR, XC18	1350	C15, C16	F.1110	G10170	15	
1.0402	S20C	C22	1020	050 A 20	1 C 22	C20	1450	C 20	F.1120	G10200	20	
1.0425	SPV315	P265GH/HII				A42CP	1430	Fe4101KW		K02801	16K	
1.0443	SC 450	GS 45	A2765-35	A1		E23-45M	1305					
1.0539		S355NH				TSE355-4	2134	Fe510B				
1.0545		S355N		4360-50E		E355R	2334	FeE355KG				
1.0546		S355NL		4360-50EE		E355FP	2135	FeE355KT				
1.0547		S355JOH		4360-50C		TSE355-3	2172	Fe510C				
1.0549		S355NLH					2135	Fe510D				
1.0553	SM 520 M	St52-3U	A14880-40	4360-50C		320-560M	1606	Fe510C				
1.0562	SM490A	St E 355	A633 Gr. C	P 355 N		FeE355KGN	2132	Fe E 355 KG		K12000	15GF	
1.0565		W St E 355		P 355 NH		P 355 NH	2106	Fe E 355 KW		K01600		
1.0566	SLA 37	T St E 355		P 355 NL1		P 355 NL1	2107	Fe E 355 KT				
1.0570	SM 50 YA	St 52-3	1	4360-50 C	S355JR	E36-3	2172	Fe 510 B			17G15	
1.0715	SUM22	95Mn28	1213	230M07		S250	1912	CFSMn28	F.2111	G12130		
1.0718	SUM22L	95MnPb28	12L13			S250Pb	1914	CF95MnPb28	F.2112	G12134		
1.0721		10S20	1108	10S20		10S20		CF10S20	F.2121	G11080		
1.0722		10SPb20	11L08			10PbF2		CF10SPb20		G11084		
1.0736	SUM25	95Mn36	1215			S300		CF9Mn36	F.2113	G12150		
1.0737		95MnPb36	12L14			S300Pb	1926	CF95MnPb36	F.2114	G12144		
1.0972		S315MC		1501-40F30		E315D						
1.0976		S355MC		1501-43F35		E355D	2642	FeE355TM				
1.0982		S460MC		1501-50F45								
1.0984		S500MC				E490D	2662	FeE490TM				
1.0986		S500MC		1501-60F55		E560D		FeE560TM				
1.1121	S10C	Ck10	1010	040A10		XC10	1265	C10	F.1510	G10100	10	
1.1141	S15	Ck15	1015	040A15	32C	XC15	1370	C15	F.1110	G10150	15	
1.1151	S20C	C22E	1020	055M15		2C22	1450	C20	F.1120	G10230	20	
1.8900	S25C	StE380	A572-60	436055E			2145	FeE390KG				
		St44-2	A36	436043A		NFA35-501E28	1411					
		StE320-3Z		1501160			1421					

Technical Information

Material Groups

Please visit
globalyg1.com/mat
 for material search



P

VDI 3323
2

Material Description
Non-alloyed steel

Composition / Structure / Heat Treatment
About 0.45% C, Annealed

HB
190

HRC
13

Mat'l No.	JIS	DIN	AISI/ASTM/SAE	BS	EN	AFNOR	SS	UNI	UNE / IHA	UNS	GOST	Brands
1.0501	S35C	C35	1035	080A32		1C35	1572	C35	F.113	G10350	35	
1.0503	S45C	C45	1045	060A47		XC42H1TS	1672	C45	F.114	G10450	45	
1.0511	S40C	C40	1040	080M40		1C40		C40	F.114A	G10400	40	
1.0540	S 50 C	C50					1674	C50		G10500		
1.0551		GS-52	A2770-36	A2		280-480M	1505					
1.0553	SM 520 M	St52-3U	A14880-40	4360-50C		320-560M	1606	Fe510C				
1.0577		S 355 J 2 G 4	A738	Fe 510 D 2 FF		A52FP	2107					
1.0726		35520	1140	212M36	8M	35MF6	1957			G11400	40	
1.0727		45520	1146			45MF4	1973			G11460		
1.1157		40Mn4	1039	150M36	15	40M5				G10390	40G	
1.1158	S25C	C25E	1025	070M25		XC25		C25	F.1120	G10250	25	
1.1166	SMn433H	34Mn5	1536						TO.B	G15360		
1.1167	SMn438(H)	36Mn5	1335	150M36		40M5	2120	36Mn6	F.1203	G13350	35G2	
1.1170	SCMn1	28Mn6	1330	150M28	14A	20M5		C28Mn	28Mn6	G13300	30G	
1.1178	S 30 C	C30E		080M30		XC32		C30	2C30	G10300		
1.1180		C35R	1035	080A35		3C35	1572		F.1135	G10350		
1.1181	S35C	C35E	1035	080A35		XC38	1572	C36	F.1130	G10340	35	
1.1191	S45C	CK45	1045	080A46		XC45	1672	C45	F.1140		45	
1.1206	S 50 C	C50E	1050	080M50		2C50	1674	C50		G10500	50	
1.1213	S50C	CF53	1050	070M55		XC48HTS	1674	C53		G10500	50	

P

VDI 3323
3

Material Description
Non-alloyed steel

Composition / Structure / Heat Treatment
About 0.45% C, Annealed

HB
250

HRC
25

Mat'l No.	JIS	DIN	AISI/ASTM/SAE	BS	EN	AFNOR	SS	UNI	UNE / IHA	UNS	GOST	Brands
1.0481	SG365	17 Mn 4/P 295 GH	A516 Gr.70	224-460B	P 295 GH	A 48 CP	2102	Fe E 295	A47RCI	K03501	14G2	
1.0501	S35C	C35	1035	080A32		1C35	1572	C35	F.1130	G10350	35	
1.0503	S45C	C45	1045	060A47		XC42H1TS	1672	C45	F.1140	G10450	45	
1.0614		C76D	1074			XC75				G10750		
1.0616		C86D	1086			XC80		C85		G10860		
1.0618		C92D	1095			XC90				G10950		
1.0726		35520	1140	212M36	8M	35MF6	1957			G11400	40	
1.1157		40Mn4	1039	150M36	15	40M5				G10390	40G	
1.1165	SMn433H	30Mn5	1036	120M36		35M5		30Mn5	F.8211	K13300	30G2	
1.1167	SMn438(H)	36Mn5	1335	150M36		40M5	2120	36Mn6	F.1203	G13350	35G2	
1.1186	S40C	C40E	1040	060A40		2C40		C40		G10400		
1.1191	S45C	CK45	1045	080M46		2C45	1672	C45	F.1140		45	
1.1201	S50C	C45R	1049	080M46		3C45	1660	C45	F.1145		38HM	
1.1213	S50C	CF53	1050	070M55		XC48HTS	1674	C53		G10500	50	
1.7242	SCM 418 H	18CrMo4										
1.7337		16CrMo4-4	A387 Gr.12					A18CrMo45KW		K11564	15CM	
1.7362	SCMV 6	12CrMo195		3606-625		Z10CD5-05		16CrMo205		K41545		
		17MnV6	A572-60	436055E		NFA35-501E36	2142					

Technical Information

Material Groups

Please visit
globalyg1.com/mat
 for material search



Mat'l No.	JIS	DIN	AISI/ASTM/SAE	Material Description			Composition / Structure / Heat Treatment					HB	HRC
				BS	EN	Non-alloyed steel			About 0.75% C, Annealed				
Mat'l No.	JIS	DIN	AISI/ASTM/SAE	BS	EN	AFNOR	SS	UNI	UNE / IHA	UNS	GOST	Brands	
1.0603	S 70 C -CSP	C67	107	080A67		XC65		C67		G10700			
1.0605		C75	1075	144980HS				C75		G10740	75		
1.1203	S55C	CK55	1055	060A57		2C55	1655	C55	F.1150	G10550	55		
1.1209		C55R	1055	070M55		3C55		C55	F.1155	G10550			
1.1221	S58C	CK60	1060	060A62	43D	2C60	1678	C60	F.1150	G10640	60		
1.1231	S 70 C -CSP	C67E	1070	060A67		XC68	1770	C70	F5103	G10700	65GA		
1.1248	C 75	C75E	1074	060A78		XC75	1774	C75	F5107	G10800	75(A)		
1.1269	SK5 -CSP	C85E	1086			XC90		C90		G10900	85(A)		
1.1274	SUP4	CK101	1095	060 A 96	C 100S	XC100	1870	C100	F5117	G10950			
1.1545	SK3	C 105 W1	W1	BW 2	C 105U	Y1 105	1880	C 100 KU	F5118		U10A		
1.1663	SK2	C125W	W112			Y2120					U13		

Mat'l No.	JIS	DIN	AISI/ASTM/SAE	Material Description			Composition / Structure / Heat Treatment					HB	HRC
				BS	EN	Non-alloyed steel			About 0.75% C, Quenched & Tempered				
Mat'l No.	JIS	DIN	AISI/ASTM/SAE	BS	EN	AFNOR	SS	UNI	UNE / IHA	UNS	GOST	Brands	
1.0070		St 70-2	1055	Fe690-2FN	-	A70-2	1655	Fe 690	F.1150		55		
1.0535	S55C	C55	1055	070M55		1C55	1655	C55		J05000	55		
1.0601	S58C	C60	1060	060A62	43D	1C60		C60		G10600	60(G)		
1.1203	S55C	CK55	1055	060A57		2C55	1655	C55	F.1150	G10550	55		
1.1221	S58C	CK60	1060	060A62	43D	2C60	1678	C60	F.1150	G10640	60		
1.1274	SUP4	CK101	1095	060 A 96	C 100S	XC100	1870	C100	F5117	G10950			
1.1545	SK3	C 105 W1	W1	BW 2	C 105U	Y1 105	1880	C 100 KU	F5118		U10A		
1.1663	SK2	C125W	W112			Y2120					U13		
1.5120		38MnSi4											
1.5710	SNC236	36NiCr6	3135	640A35	111A	35NC6							
1.7701		51CrMoV4						51CrMoV4					

Technical Information

Material Groups

Please visit
globalyg1.com/mat
 for material search



Mat'l No.	JIS	DIN	Material Description			Composition / Structure / Heat Treatment					HB	HRC
			AISI/ASTM/SAE	BS	EN	Annealed					180	10
						AFNOR	SS	UNI	UNE / IHA	UNS	GOST	Brands
1.0116		St 37-3	A570 Gr.36	4360-40C	S 235 J2 G3	E24-3	1312	Fe 360 D1(2)	AE235D		ST3KP	
1.0904	SKH 1, SKT 4	55Si7	9255	250A53	45	55S7	2085	55Si8	56Si7	G92550	55S2	
1.0961	SUP 7	60SiCr7	9262			60SC6		60SiCr8	60SiCr8	G92620		
1.2067		100Cr6	L3	BL3		Y100C6			100Cr6			
1.2108		90CrSi5	L1				2092	105WCr5				
1.2210		115CrV3	L2			100C3		107CrV3KU	F520L		11KHF	
1.2241		51CrV4										
1.2330	SCM435TK	35CrMo4	4135	708A37		34CD4	2234	35CrMo4			35KHM	
1.2419	SKS31	105WCr6		105WC13		105WC13	2140	10WCr6			CWG	
1.2510	SKS3	100MnCrW4	O1	BO1		90MWCV 5	2140	95 MnWCr 5 KU	F5220		9KHVG	
1.2542		45WCrV7	S1	BS1			2710	45WCrV8KU			5CW25F	
1.2550		60WCrV7	S1			55WC20	2710	58WCr9KU			5KHV25F	
1.2713	SKT4	55NiCrMoV6	L6			55NCV7			F520S		5C NM	
1.2721		50NiCr13	L6			55NCV6	2550		F528			
1.2842		90MnCrV8	O2	BO2		90MV8				T31502	9G2F	
1.3501		100Cr2	E50100									
1.3505	SUJ2	100Cr6	52100	2S135	31	100C6	2258	100Cr6	F1310		SC C 15	
1.5024		46Si7				45S7		46Si7	F1451			
1.5025		51Si7	9259H		50Si7	51S7	2090	50Si7	F1450			
1.5026		55Si7			56Si7	55S7	2085	55Si7	F1440	G92550	55S2	
1.5027		60Si7	9260	2S1A60	60Si7	60S7		60Si7	F1441	G92600	60S2	
1.5028	SUP7	65Si7	9260H									
1.5415	STFA 12	15Mo3	A204GrA	1503-243B		15D3	2912	16Mo3(KG)	F2601	K11820		
1.5419	SCPH11	20Mo4	4419	1503-243-430			2512	G20Mo5		G44190		
1.5423	SB450M	16Mo5	4520	1503-245-420				16Mo5(KG)	F2602	K11522		
1.5622		14Ni6	A350-LF5			16N6		14Ni6(KG)	F2641			
1.5732	SNC415(H)	14NiCr10	3415			14NC11		16NiCr11				
1.5752	SNC815(H)	14NiCr14	3310	655M13	36A	12NC15					20X2H4A	
1.6511	SUP10	36CrNiMo4	9840	816M40	110	40NCD3		36NiCrMo4(KB)			40C N2MA	
1.6523	SNCM220(H)	21NiCrMo2	8620	805M20	362	20NCD2	2506	20NiCrMo2			20C GNM	
1.6546	SNCM240	40NiCrMo2-2	8740	311-Tyre7				40NiCrMo2(KB)			38C GNM	
1.6566		17NiCrMo6-4										
1.6587		17CrNiMo6		820A16		18NCD6		14NiCrMo13				
1.6657		10NiCrMo13-4						14NiCrMo131				
1.7015	SCR415(H)	10Cr3	5015	523M15		12C3				G50150	15C	
1.7033	SCR430(H)	34Cr4	5132	530A32	18B	32C4		34Cr4(KB)		G51300	35C	
1.7035	SCR440(H)	41Cr4	5140	530M40	18	42C4	2245	41Cr4		G51400	40H	
1.7131	SCR 415	16MnCr5	5115	527M17		16MCS	2511	16MnCr5		G51150	12KHN2	
1.7139		16MnCr5S					2127				18HG	
1.7176	SUP9(A)	55Cr3	5155	527A60	48	55C3	2253	55Cr3			50C GA	
1.7218	SCM420	25CrMo4	4130	CDS110		25CD4	2225	25CrMo4(KB)			20C M	
1.7220	SCM432	34CrMo4	4135	708 A 37		35CD4	2234	34CrMo4			35C M	
1.7223	SNB22-1	41CrMo4	4142					41CrMo4			40C FA	
1.7225	SCM 440 (H)	42CrMo4	4140	708 M 40	42 CrMo 4	42 CD 4	2244	42 CrMo 4	F1252		38HM	
1.7228		55NiCrMoV6G		823M30	33		2512	653M31				
1.7262	SCM415(H)	15CrMo5				12CD4	2216	12CrMo4				
1.7321		20mOcr4					2625					
1.7335	SCM415(H)	13CrMo4-4	A182-F11	1501-620		15CD4-5	2216	14CrMo45			12C M	
1.7361		32CrMo12		722M24	40B	30CD12	2240	30CrMo12	F124A			
1.7380		10CrMo9-10	A182F22	1501-622		12CD9-10	2218	12CrMo9			12KH8	

Technical Information

Material Groups

Please visit globaly1.com/mat for material search

Mat'l No.	JIS	DIN	Material Description			Composition / Structure / Heat Treatment					HB	HRC	
			AISI/ASTM/SAE	BS	EN	Annealed					180	10	
1.7715		14MoV6-3		1503-660-440									
1.8159	SUP 10	50CrV4	6150	735A50	47	50CrV4	2230	50CrV4			G61500	50C GFA	
1.8161		58CrV4											
1.8509	SACM 645	41CrAlMo7	A355A	905M39	41B	40CAD6-12	2940	41CrAlMo7					
1.8523		39CrMoV13-9		897M39	40C								

Mat'l No.	JIS	DIN	Material Description			Composition / Structure / Heat Treatment					HB	HRC
			AISI/ASTM/SAE	BS	EN	Quenched & Tempered					275	29
1.5415	STFA 12	15Mo3	A204GrA	1503-243B		15D3	2912	16Mo3(KG)	F.2601	K11820		
1.5423	SB450M	16Mo5	4520	1503-245-420				16Mo5(KG)	F.2602	K11522		
1.5622		14Ni6	A350-LF5			16N6		14Ni6(KG)	F.2641			
1.5732	SNC415(H)	14NiCr10	3415			14NC11		16NiCr11				
1.5752	SNC815(H)	14NiCr14	3310	655M13	36A	12NC15					20X2H4A	
1.5755	SNC236	31NiCr14		653M31		18NC13	2534		F.1270			
1.6565	SNCM447	40NiCrMo6	4340	817M40	24	35NCD6	2541	35NiCrMo6(KB)			38C 2N2MA	
1.6587		17CrNiMo6		820A16		18NCD6		14NiCrMo13				
1.6657		10NiCrMo13-4						14NiCrMo131				
1.6957		26NiCrMoV14-5										
1.7015	SCr415(H)	10Cr3	5015	523M15		12C3				G50150	15C	
1.7262	SCM415(H)	15CrMo5				12CD4	2216	12CrMo4				
1.7335	SCM415(H)	13CrMo4-4	A182-F11	1501-620		15CD4-5	2216	14CrMo45			12C M	
1.7380		10CrMo9-10	A182F22	1501-622		12CD9-10	2218	12CrMo9			12KH8	
1.7715		14MoV6-3		1503-660-440							13MoCrV6	
1.7733		24CrMoV55				20CDV6		21CrMoV511				
1.7755		GS-45CrMoV10-4										
1.8070		21CrMoV511						35NiCr9				

Mat'l No.	JIS	DIN	Material Description			Composition / Structure / Heat Treatment					HB	HRC
			AISI/ASTM/SAE	BS	EN	Quenched & tempered					300	32
1.1730		C45W3	C45W			XC48						
1.2332	SCM(440)	47CrMo4	4142	708M40	19A	42CD4	2244	42CrMo4				
1.5736	SNC 631 (H)	36NiCr10	3435			30NC11						
1.6523	SNCM220(H)	21NiCrMo2	8620	805M20	362	20NCD2	2506	20NiCrMo2			20C GNM	
1.7033	SCr430(H)	34Cr4	5132	530A32	18B	32C4		34Cr4(KB)		G51300	35C	
1.7218	SCM420	25CrMo4	4130	CDS110		25CD4	2225	25CrMo4(KB)			20C M	
1.8515		32CrMo12		722M24	40B	30CD12	2240	32CrMo12	F.124A			

Technical Information

Material Groups

Please visit
globalyg1.com/mat
 for material search



P

VDI 3323
9

Material Description
Low-alloyed Steel

Composition / Structure / Heat Treatment
Quenched & Tempered

HB
350

HRC
38

Mat'l No.	JIS	DIN	AISI/ASTM/SAE	BS	EN	AFNOR	SS	UNI	UNE / IHA	UNS	GOST	Brands
1.0904	SKH 1, SKT 4	55Si7	9255	250A53	45	55S7	2085	55Si8		G92550	55S2	
1.0961	SUP 7	60SiCr7	9262			60SC6		60SiCr8		G92620		
1.2067		100Cr6	L3	BL3		Y100C6		100Cr6				
1.2419	SKS31	105WCr6		105WC13		105WC13	2140	10WCr6			CWG	
1.2542		45WCrV7	S1	B51			2710	45WCrV8KU			5CW25F	
1.2713	SKT4	55NiCrMoV6	L6			55NCDV7			F5205		5C NM	
1.4882		X50CrMnNiNbN219				Z50CMNNb21-09						
1.5120		38MnSi4										
1.5710	SNC236	36NiCr6	3135	640A35	111A	35NC6						
1.5755	SNC236	31NiCr14		830m31		18NC13	2534		F.1270			
1.6511	SUP10	36CrNiMo4	9840	816M40	110	40NCD3		36NiCrMo4(KB)			40C N2MA	
1.6546	SNCM240	40NiCrMo2-2	8740	311-Tyre7				40NiCrMo2(KB)			38C GNM	
1.7035	SCR440(H)	41Cr4	5140	530M40	18	42C4	2245	41Cr4		G51400	40H	
1.7176	SUP9(A)	55Cr3	5155	527A60	48	55C3	2253	55Cr3			50C GA	
1.7220	SCM432	34CrMo4	4135	708Aa37		35CD4	2234	34CrMo4			35C M	
1.7223	SNB22-1	41CrMo4	4142					41CrMo4			40C FA	
1.7225	SCM 440 (H)	42CrMo4	4140	708 M 40	42 CrMo 4	42 CD 4	2244	42 CrMo 4	F.1252		38HM	
1.7361		32CrMo12		722M24	40B	30CD12	2240	30CrMo12	F.124A			
1.8159	SUP 10	50CrV4	6150	735A50	47	50CrV4	2230	50CrV4	51CrV4	G61500	50C GFA	
1.8161		58CrV4										
1.8509	SACM 645	41CrAlMo7	A355A	905M39	41B	40CAD6-12	2940	41CrAlMo7				
1.8523		39CrMoV13-9		897M39	40C			36CrMoV12				

P

VDI 3323
10

Material Description
High-alloyed steel,
and tool steel

Composition / Structure / Heat Treatment
Annealed

HB
200

HRC
15

Mat'l No.	JIS	DIN	AISI/ASTM/SAE	BS	EN	AFNOR	SS	UNI	UNE / IHA	UNS	GOST	Brands
1.0347	SPCD	RR St 3	A619	CR 3	Fe P03	F 13		DC03/FeP03			08JU	
1.0723	SUM32	15S22		210A15			1922		F210F			
1.2080	SKD1	X210Cr12	D3	BD3	X210Cr12	Z200C12		X205Cr12KU		T30403	KH12	
1.2162	SCR 420 H	21MnCr5				20MCS						
1.2311		40CrMnMo7				40CMD8		35CrMn08KU				
1.2312		40CrMnMoS8.6	P20+S			40CMD8S						
1.2316		X36CrMo17			X38CrMo16							
1.2343	SKD 6	X38CrMoV5-1	H11	BH11		Z38CDV5		X37CrMoV51KU		T20811	4C5MF5	
1.2344	SKD61	X40CrMoV5-1	H13	BH13		Z40CDV5	2242	X40CrMoV511KU	F5318	T20813	4C5MF15	
1.2363	SKD12	X100CrMoV5-1	A2	BA2		Z100CDV5	2260	X100CrMoV51KU	F5227		9KH5VF	
1.2379	SKD11	X155CrVMo121	D2	BD2		Z160CDV12	2310	X165CrMoW12KU		T30402	KH12MF	KRUPP2379
1.2436	SKD 2	X210CrW12	D4(D6)	BD6		Z200CD12	2312	X215CrW121KU	F5213		KH12	

▶ NEXT PAGE

Technical Information

Material Groups

Please visit globalyg1.com/mat for material search

Mat'l No.	JIS	DIN	AISI/ASTM/SAE	BS	EN	Composition / Structure / Heat Treatment					HB	HRC
						Annealed					200	15
1.2510	SKS3	100MnCrW4	O1	B01		90MWCV5	2140	95MnWCr5KU	F5220		9KHVG	
1.2581	SKD5	X30WCrV9-3	H21	BH21		Z30WCV9		X30WCrV93KU	F526	T20821	3C2W8F	
1.2601		X165CrMoV12					2310	X160CrMoV12			KH12MF	
1.2606	SKD62	X37CrMoW51	H12	BH12		Z35CWDV5		X35CrMoW05SKU	F537	T20812	5C NM	
1.2764		X19NiCrMo4										
1.2767		X45NiCrMo4				45NCD16		40NiCrMoV8KU				
1.2842		90MnCrV8	O2	B02		90MV8		90MnVCr8KU		T31502	9G2F	
1.3243	SKH55	S6-5-2-5	T15			KCV06-05-05-04-02	2723	H56-5-2-5			R6M5K5	
1.3249	SKH3	S18-1-2-5	T4	BT4		Z80WKCV18-05-04					R18K5F2	
1.3343	SKH51, SKH9	S6-5-2	M2	BM2		Z85WDCV	2722	H5652	F5604		R6M5	
1.3348	SKH58	S2-9-2	M7			Z100DCW09-04-02	2782	H5292	F5607			
1.3355	SKH2	S18-0-1	T1	BT1		Z80WCV18-4-01					R18	
1.4718	SUH1	X45CrSi9-3	HNV3	401S45	52	Z45CS9		X45CrSi8	F322		40C952	
1.5662	SL9N60(53)	X8Ni9	ASMA353	502-650		9Ni		X10Ni9	F2645			
1.5680		12Ni19	2515	12Ni19		Z18N5						

Mat'l No.	JIS	DIN	AISI/ASTM/SAE	BS	EN	Composition / Structure / Heat Treatment					HB	HRC
						Quenched & Tempered					325	35
1.2080	SKD1	X210Cr12	D3	BD3	X210Cr12	Z200C12		X205Cr12KU		T30403	KH12	
1.2344	SKD61	X40CrMoV5-1	H13	BH13		Z40CDV5	2242	X40CrMoV511KU	F5318	T20813	4C5MF15	
1.2363	SKD12	X100CrMoV5-1	A2	BA2		Z100CDV5	2260	X100CrMoV51KU	F5227		9KH5VF	
1.2436	SKD2	X210CrW12	D4(D6)	BD6		Z200CD12	2312	X215CrW121KU	F5213		KH12	
1.2581	SKD5	X30WCrV9-3	H21	BH21		Z30WCV9		X30WCrV93KU	F526	T20821	3C2W8F	
1.2601		X165CrMoV12					2310	X160CrMoV12			KH12MF	
1.2714	SKT4	55NiCrMoV7	6F3/L6			55NiCrMoV7			F5205		5KHNV	
1.3202		S12-1-4-5		BT15				HS12-1-5-5				
1.3207		S10-4-3-10		BT42		Z130WKCDV						
1.3243	SKH55	S6-5-2-5	T15			KCV06-05-05-04-02	2723	H56-5-2-5			R6M5K5	
1.3246		S7-4-2-5	M35			Z110WKCDV07-05-04		H57-4-2-5				
1.3247	SKH51	S2-10-1-8	M42	BM42		Z110DKCW09-08-04		H52-9-1-8			R2AM9K5	
1.3255	SKH3	S18-1-2-5	T4	BT4		Z80WKCV18-05-04					R18K5F2	
1.3343	SKH51, SKH9	S6-5-2	M2	BM2		Z85WDCV	2722	H5652	F5604		R6M5	
1.3348	SKH58	S2-9-2	M7			Z100DCW09-04-02	2782	H5292	F5607			
1.3355	SKH2	S18-0-1	T1	BT1		Z80WCV18-4-01					R18	
1.4718	SUH1	X45CrSi9-3	HNV3	401S45	52	Z45CS9		X45CrSi8	F322		40C952	
1.4935	SUH616	X20CrMoW121	422							S42200		
1.5680		12Ni19	2515	12Ni19		Z18N5						

Technical Information

Material Groups

Please visit
globalyg1.com/mat
 for material search



M		VDI 3323 12		Material Description			Composition / Structure / Heat Treatment					HB	HRC
				Stainless steel			Ferritic / Martensitic, Annealed					200	15
Mat'l No.	JIS	DIN	AISI/ASTM/SAE	BS	EN	AFNOR	SS	UNI	UNE / IHA	UNS	GOST	Brands	
1.4000	SUS403	X6Cr13	403	403S17		Z6C13	2301	X6Cr13	F3110	S40300	08C 13	ATI 410S	
1.4001		X7Cr14	410 S	403S7		Z8C13	2301		F8401		08C 13		
1.4002	SUS 405	X6CrAl13	405	405S17		Z6CA13	2302	X6CrAl13		S40500			
1.4005	SUS416	X12CrS13	416	416S21		Z11CF13	2380	X12CrS13	F3411	S41600		ATI 416	
1.4006	SUS410	X12Cr13	410	410S21	56A	Z10C13	2302	X12Cr13	F3401	S41000	12C 13	ATI 410	
1.4016	SUS430	X6Cr17	430	430S15	X8Cr17	Z8C17	2320	X8Cr17	F3113	S43000	12C 17	ATI 430	
1.4027	SCS 2	GX20Cr14		420C29		Z20C13M					20C 13L		
1.4028	SUS420J2	X30Cr13	420	420S45		Z30C13	2304			S42020	20C 13		
1.4034	SUS420J2	X46Cr13		420S45		Z40C14		X40Cr14	F3405				
1.4057	SUS431	X19CrNi17-2	431	431S29	57	Z15CN16-02	2321	X16CrNi16	F3427	S43100	20C 17N2	431 (HT)	
1.4086		GX120Cr29		452C11									
1.4104	SUS430F	X12CrMoS17	430F	420S37		Z10CF17	2383	X10CrS17	F3117	S43020			
1.4112	SUS 440 B	X90CrMoV18	440B							S44003	95KH18		
1.4113	SUS434	X6CrMo17	434	434S17		Z8CD17-01	2325	X8CrMo17		S43400		AL 434	
1.4313	SCS5	X3CrNi13-4	CA6-NM	425C11		Z4CND13-04M	2385	(G)X6CrNi304		J91540			
1.4340		GX40CrNi274								J92615			
1.4417		X2CrNiMoSi195	S31500							S39215			
1.4418		X4CrNiMo165				Z6CND16-04-01	2387					APX4	
1.4510	SUS430LX	X6CrTi17	XM8			Z4CT17		X6CrTi17	F3115	S43035	08C 17T	430Ti	
1.4511	SUS430LK	X6CrNb17				Z4CNb17		X6CrNb17	F3122			AXCS25	
1.4512	SUH409	X6CrTi12	409	LW19		Z3CT12		X6CrTi12		S40900			
1.4720		X20CrMo13											
1.4724	SUS 405	X10CrAl13	405	403S17		Z10C13		X10CrAl12	F311		10C 13SJU		
1.4742	SUS430	X10CrAl18	430	439S15	60	Z10CAS18		X8Cr17	F3113	S43000	15C 13SJU		
1.4747	SUH4	X80CrNiSi20	HNv6	443S65	59	Z80CSN20-02		X80CrSiNi20	F320B	S65006			
1.4749		X18CrN28	446								15KH28		
1.4762	SUH446	X10CrAl24	446			Z10CAS24	2322	X16Cr26		S44600			
1.4871	SUH35,SUH36	X53CrMnNiN21-9	EV8	349S54		Z52CMN21-09		X53CrMnNiN219		S63008	55C 20G9AN4		
		X10CrNi15	429										
		X12CrNi18-9	302	302S31		Z10CN18-09	2330						

M		VDI 3323 13		Material Description			Composition / Structure / Heat Treatment					HB	HRC
				Stainless steel			Martensitic, Quenched & Tempered					240	23
Mat'l No.	JIS	DIN	AISI/ASTM/SAE	BS	EN	AFNOR	SS	UNI	UNE / IHA	UNS	GOST	Brands	
1.4000	SUS403	X6Cr13	403	403S17		Z6C13	2301	X6Cr13	F3110	S40300	08C 13	ATI 410S	
1.4001		X7Cr14	410 S	403S7		Z8C13	2301		F8401		08C 13		
1.4006	SUS410	X12Cr13	410	410S21	56A	Z10C13	2302	X12Cr13	F3401	S41000	12C 13	ATI 410	
1.4016	SUS430	X6Cr17	430	430S15	X8Cr17	Z8C17	2320	X8Cr17	F3113	S43000	12C 17	ATI 430	
1.4021	SUS 420J1	X20Cr13	420	420S37		Z20C13	2303	14210	F5261	S42000	20C 13	ATI 420	
1.4027	SCS 2	GX20Cr14		420C29		Z20C13M					20C 13L		
1.4031	SUS 420 J2	X40Cr13	420			Z40C14	-2304		F3404	S42080	40C 13		
1.4034	SUS420J2	X46Cr13		420S45		Z40C14		X40Cr14	F3405				
1.4057	SUS431	X19CrNi17-2	431	431S29	57	Z15CN16-02	2321	X16CrNi16	F3427	S43100	20C 17N2	431 (HT)	
1.4104	SUS430F	X12CrMoS17	430F	420S37		Z10CF17	2383	X10CrS17	F3117	S43020			
1.4113	SUS434	X6CrMo17	434	434S17		Z8CD17-01	2325	X8CrMo17		S43400		AL 434	
1.4313	SCS5	X3CrNi13-4	CA6-NM	425C11		Z4CND13-04M	2385	(G)X6CrNi304		J91540			
1.4544		A 700	321	S524		Z 10 CNT 18 11		X6CrNiTi1811		J92630	08C 18N12T		
1.4546		X5CrNiNb18-10	348	347S31				X6CrNiNb1811		J92640		ATI 348	
1.4871	SUH35,SUH36	X53CrMnNiN21-9	EV8	349S54		Z52CMN21-09		X53CrMnNiN219		S63008	55C 20G9AN4		
1.4922		X20CrMnV12-1					2317	x20CrMnOn1201					
1.4923		X22CrMoV121										Jethete X20	

Technical Information

Material Groups

Please visit globalyg1.com/mat for material search

M		VDI 3323		Material Description			Composition / Structure / Heat Treatment					HB	HRC
		14		Stainless steel			Austenitic					180	10
Mat'l No.	JIS	DIN	AISI/ASTM/SAE	BS	EN	AFNOR	SS	UNI	UNE / IHA	UNS	GOST	Brands	
1.4301	SUS 304	X5CrNi18-10	304	304S15		Z5CN18-09	2332		F3551	S30409	08C 18N10		
1.4305	SUS303	X10CrNiS18-10	303	303S21	58M	Z8CNF18-09	2346	X10CrNiS18.09	F3508	S30300	30C 18N11	ATI 303	
1.4306	SCS19	X2CrNi1911	304L	304C12	X3CrNi1810KD	Z2CN18-09	2352	GX2CrNi1910	F3503	S30403	03KH18N11	ATI 304L	
1.4308	SUS304L	GX6CrNi18-9	CF-8	304C15		Z6CN18-10M	2333					CF-8	
1.4310	SUS 301	X10CrNi18-8	301	301S21		Z12CN17-07	2331	X2CrNi1807	F3517	S30100	07KH16N6	ATI 301	
1.4311	SUS304LN	X2CrNiN18 10	304LN	304S62		Z2CN18-10	2371	X2CrNiN1810	F3541	S30453	03KH18N11		
1.4312	SCS12	GX10CrNi188	305	302C25		Z10CN18-9M					10C 18N9L	ATI 305	
1.4350	SUS304	X5CrNi18-9	304	304S15	58E	Z6CN18-09	2332	X5CrNi1810	F3551	S30400		ATI 304	
1.4362		X2CrNiN234	S32304			Z2CN23-0AAZ	2327			S32304		ATI 2304TM	
1.4371		X3CrMnNiN18887	202	284S16		Z8CMN18-08-05							
1.4401	SUS316	X5CrNiMo17-12-2	316	316S13		Z3CND17-11-01	2347	X5CrNiMo17 12 2	F3534	S31600	08KH17H13M2T	ATI 316	
1.4404	SUS316L	X2CrNiMo17-13-2	316L	316S11		Z2CND17-12	2348	X2CrNiMo1712	F3533	S31603		ATI 316L	
1.4406	SUS316LN	X2CrNiMoN17122	316LN	316S61		Z2CND17-12AZ		X2CrNiMoN1712	F3542	S31653	07C 18N	ATI 316LN	
1.4408	SCS14	GX6CrNiMo18-10	CF-8M	316C16			2343	X7CrNiMo2010	F8414	J92900	10G252MSL		
1.4410	SCS 14 A	GX10CrNiMo18-9				Z5CND20-12M	2328			S32750			
1.4429	SUS316LN	X2CrNiMoN17-13-3	316Ln	316S62		Z2CND17-13AZ	2375	X2CrNiMoN17133	F3543		03KH16N15M3		
1.4435	SUS316L	X2CrNiMo18143	316L	316S11		Z3CND17-12-03	2375	X2CrNiMo17 13 2	F3533	S31603	O3C 17N14M3		
1.4436	SUS316	X3CrNiMo17-13-3	316	316S19		Z6CND18-12-03	2343	X5CrNiMo17 12 2	F3543	S31600			
1.4438	SUS317L	X2CrNiMo18164	317L	317S12		Z2CND19-15-04	2367	X2CrNiMo18 16 4	F3539	S31703		ATI 317L	
1.4439		X2CrNiMoN17135	(s31726)			Z3CND18-14-06AZ							
1.4440		X2CrNiMo18-16											
1.4449	SUS317	X5CrNiMo17133	317	317S16				X5CrNiMo1815		S31700		ATI 317	
1.4460	SUS 329 J1	X8CrNiMo275	329				2324			S32900		10RE51	
1.4462	SUS329J3L	X2CrNiMoN2253		318S13		Z3CND22-05Az	2377			S31803		ATI 2205TM	
1.4500		X7NiCrMoCuNb2520				Z3NCDU25-20M				J95150			
1.4521	SUS444	X2CrMoTi18-2	443444				2326	X2CrMoTiNb18 2	F3123				
1.4539		X1NiCrMoCuN25205				Z2NCDU25-20	2562			N08904		ATI 904L	
1.4541	SUS321	X14CrNiTi18-10	321	321S31		Z6CNT18-10	2337	X6CrNiTi18 11	F3523	S32100	06C 18N10T	ATI 321	
1.4542	SUS630	X5CrNiCuNb174	630			Z7CNU15-05						UGIMA 4542	
1.4545		Z7CNU15.05	15-5PH							S15500		ATI 15-5	
1.4547		X1CrNiMoN20187	S31254				2378			S31254		Uranus B256Mo	
1.4550	SUS347	X6CrNiNb18-10	347	347S17	58F	Z6CNNb18-10	2338	X6CrNiNb18 11	F3552	S34700	08C 18N12B	ATI 347	
1.4552	SCS 21	GX7CrNiNb18-9				Z4CNNb19-10M				J92710			
1.4568	SUS 631	X 7 CrNiAl 17 7		316S111		Z 9 CAN 17-7	2388	Z8CNA17-07		S17700	09C 17NUJ1	17-7PH	
1.4571	SUS 316Ti	X6CrNiMoTi17-12-2	316Ti	320S31	58J	Z6NDT17-12	2350	X6CrNiMoTi17 12	F3535		10C 17N13M2T	ATI 316Ti	
1.4581	SCS 22	GX5CrNiMoNb18		318C17		Z4CNDNb18-12M							
1.4583		X6CrNiMoNb18-12	318	303S21		Z15CNS20-12		X15CrNiSi2 12					
1.4585		GX7CrNiMoCuNb1818						X6CrNiMoTi17 12		J94651			
1.4821		X20CrNiSi254				Z20CNS25-04				S44635			
1.4823		GX40CrNiSi274								J92605			
1.4828	SCS17	X15CrNiSi20-12	309	309S24	58C	Z15CNS20-12			F8414	S30900	20C 20N1452	ATI 309	
1.4833	SUS 309 S	X6CrNi2213	309S	309S13		Z15CN24-13				J93400			
1.4845	SUH310	X12CrNi25-21	310S	310S24		Z12CN25-20	2361	X6CrNi2520	F331	S31008	20C 23N18	ATI 310S	
1.4878	SUS321	X12CrNiTi18-9	321	321S20	58B	Z6CNT18-12(B)	2337	X6CrNiTi1811	F3553	S32100		ACX315	
1.4891		X5CrNiNb18-10	S630415				2372						
1.4893		X8CrNiNb11	S30815				2368						
1.4948		X6CrNi1811	304H	304S51		Z5CN18-09	2333			S30480			
1.4980		X5NiCrTi2515	660				2570			S66286		Incoloy A 286	
		X5NiCrN3525											
		X2CrNiMoN18134	S31753										
		X2CrNiMoN25227											

Technical Information

Material Groups

Please visit
globalyg1.com/mat
 for material search



K		VDI 3323 15		Material Description Grey cast iron			Composition / Structure / Heat Treatment Pearlitic / Ferritic					HB 180	HRC 10
Mat'l No.	JIS	DIN	AISI/ASTM/SAE	BS	EN	AFNOR	SS	UNI	UNE / IHA	UNS	GOST	Brands	
0.6010	FC100	GG10	A48 20 B	Grade 100	GJL-100	Ft 10 D	0100	G10	FG10		Sc 10		
0.6015	FC150	GG15	A48 25 B	Grade 150	GJL-150	Ft 15 D	0115	G15	FG15		Sc 15		
0.6020	FC200	GG20	A48 30 B	Grade 220	GJL-200	Ft 20 D	0120	G20	FG20	W06020	Sc 20		
0.6025	FC250	GG25	A48 40 B	Grade 260	GJL-250	Ft 25 D	0125	G25	FG25		Sc 25		
0.6660		GGL-NiCr 202	1050/700/7	Grade F2	GJLA-XNiCr 20-2	L-NC 202	0523	-		F41002		Ni-Resist 2	
1.4449	SUS317	XSCrNiMo17133	317	317S16				XSCrNiMo1815		S31700		ATI 317	

K		VDI 3323 16		Material Description Grey cast iron			Composition / Structure / Heat Treatment Pearlitic (Martensitic)					HB 260	HRC 26
Mat'l No.	JIS	DIN	AISI/ASTM/SAE	BS	EN	AFNOR	SS	UNI	UNE / IHA	UNS	GOST	Brands	
0.6025	FC250	GG25	A48 40 B	Grade 260	GJL-250	Ft 25 D	0125	G25	FG25		Sc 25		
0.6030	FC300	GG30	A48 45 B	Grade 300	GJL-300	Ft 30 D	0130	G30	FG30		Sc 30		
0.6035	FC350	GG35	A48 50 B	Grade 350	GJL-350	Ft 35 D	0135	G35	FG35		Sc 35		
0.6040	FC400	GG40	A48 60 B	Grade 400	GJL-400	Ft 40 D	0140	G40	FC40		Sc 40		

K		VDI 3323 17		Material Description Nodular cast iron			Composition / Structure / Heat Treatment Ferritic					HB 160	HRC 3
Mat'l No.	JIS	DIN	AISI/ASTM/SAE	BS	EN	AFNOR	SS	UNI	UNE / IHA	UNS	GOST	Brands	
0.7033	FCD350-22L	GGG35.3	-	350/22L40	GJS-350-22-LT	FGS 370-17	0717-15	-					
0.7040	FCD400	GGG40	60-40-18	SNG 420-12	GJS-400-15	FCS 400-12	0717-02	GS 400-12	FG E38-17	F32800	Vc 42-12		
0.7043	FCD 370	GGG40.3	60-40-18	SNG 370-17	GJS-400-18-LT	FGS 370-17	0717-12	GSO 42-17			Vc 42-12		
0.6040	FC400	GG40	A48 60 B	Grade 400	GJL-400	Ft 40 D	0140	G40	FC40		Sc 40		

K		VDI 3323 18		Material Description Nodular cast iron			Composition / Structure / Heat Treatment Pearlitic					HB 250	HRC 25
Mat'l No.	JIS	DIN	AISI/ASTM/SAE	BS	EN	AFNOR	SS	UNI	UNE / IHA	UNS	GOST	Brands	
0.7050	FCD500	GGG50	80-55-06	SNG 500-7	GJS-500-7	FGS 500-7	0727-02	GS 500-7	FG E50-7	F33100	Vc 50-2		
0.7060	FCD600	GGG60	80-55-06	SNG 600-3	GJS-600-3	FGS 600-3	0732-03	GS 600-3	FG E60-2		Vc 60-2		
0.7070	FCD700	GGG70	100-70-03	SNG 700-2	GJS-700-2	FGS 700-2	0737-01	GS 700-2	FG S70-2	F34800	Vc 70-2		
0.7652	FCDA-NiMn 137	GGG NiMn 13-7	-	Grade S6	GJSA-XNiMn 13-7	FGS Ni13 Mn7	0772	-				Nodumag	
0.7660		GGG NiCr 20-2	A436 D2	Grade S2	GJSA-XNiCr 20-2	FGS Ni20 Cr2	0776	-				Ni-Resist D-2	

Technical Information

Material Groups

Please visit
globalyg1.com/mat
for material search



Mat'l No.	JIS	DIN	AISI/ASTM/SAE	BS	EN	AFNOR	SS	UNI	UNE / IHA	UNS	GOST	Brands	K					
													VDI 3323	Material Description	Composition / Structure / Heat Treatment	HB	HRc	
0.8135	FCMW330	GTS-35	32510	B 340-12	GJMB350-10	MN 35-10	0815	GMN 35	GTS35		Kc 35-10			19	Malleable cast iron	Ferritic	130	

Mat'l No.	JIS	DIN	AISI/ASTM/SAE	BS	EN	AFNOR	SS	UNI	UNE / IHA	UNS	GOST	Brands	K					
													VDI 3323	Material Description	Composition / Structure / Heat Treatment	HB	HRc	
0.8145	FCMW370	GTS-45	A220-40010	P 440-7	GJMB450-6	MN 450	0852	GMN 45						20	Malleable cast iron	Pearlitic	230	21
0.8155	FCMP490	GTS-55	50005	P 510-4	GJMB-550-4	MP 50-5	0854	GMN 55			Kc 60-3							
0.8165	FCMP590	GTS-65	70003	P 570-3	GJMB-650-2	MN 650-3	0856	GMN 65										
0.8170	FCMP690	GTS-70	90001	P 690-2	GJMB-700-2	MN 700-2	0862	GMN 70			Kc 70-2							

Technical Information

Material Groups

Please visit
globalyg1.com/mat
 for material search



Mat'l No.	JIS	DIN	Material Description			Composition / Structure / Heat Treatment					HB	HRc
			AISI/ASTM/SAE	BS	EN	Not Curable					60	
3.0205		Al99	Al99									
3.0255	(A1050)	Al99.5	1000	L31		A59050C						D1
3.3315		AlMg1										

Mat'l No.	JIS	DIN	Material Description			Composition / Structure / Heat Treatment					HB	HRc
			AISI/ASTM/SAE	BS	EN	Curable, Hardened					100	
3.1325		AlCuMg1										AD35
3.1655	A2011	AlCuSiPb										
3.2315		AlMgSi1										AK9
3.4345		AlZnMgCuO.5	7050	L86		AZ4GU/9051		811-04				
3.4365	7075	AlZnMgCu1.5	7075	7075		7075		AlZn5.8MgCuCr				B95

Mat'l No.	JIS	DIN	Material Description			Composition / Structure / Heat Treatment					HB	HRc
			AISI/ASTM/SAE	BS	EN	≤ 12% Si, Not Curable					75	
3.2163		G-AlSi9Cu3										VAL8
3.2382		GD-AlSi10Mg										
3.2383		G-AlSi0Mg(Cu)	A360.2	LM9			4253					
3.2581		G-AlSi12										
3.3561		G-AlMg5										
3.5101		G-MgZn4sE1Zr1	ZE41	MAG5								
3.5103		MgSE3Zn27r1	EZ33	MAG6		G-TR3Z2						
3.5812		G-MgAl8Zn1	AZ81	NMAG1								
3.5912		G-MgAl9Zn1	AZ91	MAG7								
			A356-72	2789		NFA32-201						
A5052			356.1	LM25			4244					AK7
		G-AlSi12	A413.2	LM6			4261					
ADC12		G-AlSi12(Cu)	A413.1	LM20			4260					AK12
A6061		GD-AlSi12	A413.0				4247					
A7075		GD-AlSi8Cu3	A380.1	LM24			4250					

Technical Information

Material Groups

Please visit globaly1.com/mat for material search



N		VDI 3323 24	Material Description Aluminum-cast, alloyed			Composition / Structure / Heat Treatment ≤ 12% Si, Curable, Hardened					HB 90	HRc
Mat'l No.	JIS	DIN	AISI/ASTM/SAE	BS	EN	AFNOR	SS	UNI	UNE / IHA	UNS	GOST	Brands
2.1871		G-AlCu4TiMg										
3.1754		G-AlCu5Ni1,5										
3.2371		G-AlSi7Mg	4218B								AK8	
3.2373	C4BS	G-AlSi9MgWA	SC64D			A-S7G	4251				AK9	
3.2381		G-AlSi10Mg									AK12	
3.5106		G-MgAg3SE2Zr1	QE22	mag12								
		G-ALMG5	GD-AISI12	LMS		A-SU12	4252					

N		VDI 3323 26	Material Description Copper and Copper Alloys (Bronze / Brass)			Composition / Structure / Heat Treatment Cutting alloys, PB>1%					HB 110	HRc
Mat'l No.	JIS	DIN	AISI/ASTM/SAE	BS	EN	AFNOR	SS	UNI	UNE / IHA	UNS	GOST	Brands
2.0375		CuZn36Pb3									LS60-2	
2.1090		G-CuSn75pb	C93200			U-E7Z5pb4						
2.1096		G-CuSn5ZnPb	c83600	LG2								
2.1098		G-CuSn2Znpb	C83600									
2.1182		G-CuPb15Sn	C23000	LB1		U-pb15E8						

N		VDI 3323 27	Material Description Copper and copper alloys (Bronze / Brass)			Composition / Structure / Heat Treatment CuZn, CuSnZn (Brass)					HB 90	HRc
Mat'l No.	JIS	DIN	AISI/ASTM/SAE	BS	EN	AFNOR	SS	UNI	UNE / IHA	UNS	GOST	Brands
2.0240	C2300	CuZn15									L90	
2.0321		CuZn37	C27200	c2108		CuZn36,CuZn37		C2700			L63	
2.0590		G-CuZn40Fe										
2.0592		G-CuZn35Al1	C86500	U-Z36N3		HTB1						
2.0596		G-CuZn34Al2	C86200	HTB1		U-Z36N3					LTs23AD	
2.1293		CuCrZr	C18200	CC102		U-Cr0-8Zr						

N		VDI 3323 28	Material Description Copper and copper alloys (Bronze / Brass)			Composition / Structure / Heat Treatment CuSn, lead-free copper and electrolytic copper					HB 100	HRc
Mat'l No.	JIS	DIN	AISI/ASTM/SAE	BS	EN	AFNOR	SS	UNI	UNE / IHA	UNS	GOST	Brands
2.0060		E-Cu57										
2.0966		CuAl10Ni5Fe4	C63000	Ca104		U-A10N					BrAD	
2.0975		G-CuAl10Ni	B-148-52									
2.1050		G-CuSn10	c90700	CT1								
2.1052		G-CuSn12	C90800	pb2		UE12P						
2.1292		G-CuCrF35	C81500	CC1-FF								

Technical Information

Material Groups

Please visit
globalyg1.com/mat
 for material search



Mat'l No.	JIS	DIN	Material Description			Composition / Structure / Heat Treatment					HB	HRc
			AISI/ASTM/SAE	BS	EN	Fe Based, Annealed					200	15
1.4558	NCF 800TB	X2NiCrAlTi3220	N08800	NA15								
1.4562		X1NiCrMoCu32287	N08031									
1.4563		X1NiCrMoCuN31274	N08028			Z1NCDU31-27-03	2584				EK77	
1.4864	SUH330	X12NiCrSi36-16	330	NA17		Z12NCS37-18					N08330	
1.4865	SCH15	GX40NiCrSi38-18		330C40				XG50NiCr3919			J94605	
1.4958		X5NiCrAlTi3120										

Mat'l No.	JIS	DIN	Material Description			Composition / Structure / Heat Treatment					HB	HRc
			AISI/ASTM/SAE	BS	EN	Fe Based, Aged					280	30
1.4977		X40CoCrNi2020				Z42CNKDWNb						

Mat'l No.	JIS	DIN	Material Description			Composition / Structure / Heat Treatment					HB	HRc
			AISI/ASTM/SAE	BS	EN	Ni or Co Based, Annealed					250	25
2.4360		NiCu30Fe		NA13		NU30				N04400		Monel400
2.4603		NiCr30FeMo	5390A			NC22FeD						Hastelloy G-30
2.4610		NiMo16Cr16Ti								N26455		HastelloyC-4
2.4630		NiCr20Ti		HR5,203-4		NC20T				N06075		Nimonic75
2.4631	NCF 80A	NiCr20TiAl		Hr40		NC20TA				N07080	KHN77TYuR	Nimonic 80A
2.4642	NCF 690	NiCr29Fe				Nnc30Fe				N06690		Inconel 690
2.4856		NiCr22Mo9Nb		NA21		NC22FeDNb				N06625		Inconel 625
2.4858		NiCr21Mo		NA16		NC21FeDU				N08825	KHN38VT	Incoloy 825

Mat'l No.	JIS	DIN	Material Description			Composition / Structure / Heat Treatment					HB	HRc
			AISI/ASTM/SAE	BS	EN	Ni or Co Based, Aged					350	38
2.4375		NiCu30Al	4676	NA18		NU30AT				N05500		Monelk500
2.4662		NiFe35Cr14MoTi	5660			ZSNCDT42				N09901		Incoloy 901
2.4668		NiCr19Fe19NbMo	5383	HR8		NC19eNB				N07718		Inconel 718
2.4670		S-NiCr13Al16MoNb	5391	Mar-46		NC12AD						Nimocast 713
2.4694		NiCr16Fe7TiAl								N07751		Inconel 751
2.4955		NiFe25Cr20NbTi										
2.4964		CoCr20W15Ni	5772			KC20WN						Haynes 25
		CoCr22W14Ni	AMS 5772			KC22WN						

Technical Information

Material Groups

Please visit globalyg1.com/mat for material search



S		VDI 3323 35		Material Description Heat resistant super alloys			Composition / Structure / Heat Treatment Ni or Co Based, Cast					HB 320	HRC 34
Mat'l No.	JIS	DIN	AISI/ASTM/SAE	BS	EN	AFNOR	SS	UNI	UNE / IHA	UNS	GOST	Brands	
2.4669		NiCr15Fe7TiAl				NC15TNbA				N07750		Inconel X750	
2.4685		G-NiMo28								N10665		Hastelloy B	
2.4810		G-NiMo30										Hastelloy C	
2.4973		NiCr19Co11MoTi	AMS 5399			NC19KDT					VT5-1		
3.7115		TiAl5Sn2								R54520	VT1-00	ATI Grade 6	

S		VDI 3323 36		Material Description Titanium alloys			Composition / Structure / Heat Treatment Pure Titanium					HB 400 Rm	HRC
Mat'l No.	JIS	DIN	AISI/ASTM/SAE	BS	EN	AFNOR	SS	UNI	UNE / IHA	UNS	GOST	Brands	
2.4674		NiCo15Cr10MoAlTi	AMS 5397							N13100		IN 100	
3.7025		Ti1	R50250	2TA1						R50250		ATI 30 CP Gr. 1	
3.7225		Ti1pd	R52250	TP1						R52250			

S		VDI 3323 37		Material Description Titanium alloys			Composition / Structure / Heat Treatment Alpha + Beta Alloys, Hardened					HB 1050 Rm	HRC
Mat'l No.	JIS	DIN	AISI/ASTM/SAE	BS	EN	AFNOR	SS	UNI	UNE / IHA	UNS	GOST	Brands	
3.7124		TiCu2		2TA21-24									
3.7145		TiAl6Sn2Zr4Mo2Si	R54620							R54620			
3.7165		TiAl6V4	AMS R56400	TA10-13		T-A6V					VT6		
3.7185		TiAl4Mo4Sn2		TA45-51									
3.7195		TiAl3V2.5								R56320		ATI 3-2.5	
		TiAl4Mo4Sn4Si0.5											
		TiAl5Sn2.5	AMS R54520	TA14/17		T-A5E							
		Ti6Al4VELI	AMS R56401	TA11									

Technical Information

Material Groups

Please visit
globalyg1.com/mat
 for material search



Mat'l No.	JIS	DIN	Material Description			Composition / Structure / Heat Treatment					HB	HRc
			AISI/ASTM/SAE	BS	EN	Hardened steel					550	55
Mat'l No.	JIS	DIN	AISI/ASTM/SAE	BS	EN	AFNOR	SS	UNI	UNE / IHA	UNS	GOST	Brands
1.1231	S 70 C-CSP	Ck 67	1070	060 A 67	C 67S	XC 68	1770	C 70	F 5103		70	
1.1248	C 75	Ck 75	1078, 1080	060 A 78	C 75S	XC 75	1774	C 75	F 5107		75	
1.1274	SUP 4	Ck 101	1095	060 A 96	C 100S	XC100	1870	C100	F 5117			
1.1545	SK 3	C 105W1	W1	BW 2	C 105U	Y1 105	1880	C 100 KU	F 5118		U10A	
1.2762		75CrMoNiW67	-	-	-	-	-	-	-			
1.3401	SCMnH1	GX120Mn12	A128(A)			Z120M12	2183	GX120Mn12	F 8251		110G13L	
1.4021	SUS 420 J1	X 20 Cr 13	420	420 S 37	X 20 Cr 13	Z 20 C 13	2303	X 20 Cr 13	F 5261		20KH13	ATI 420
1.4109	SUS 440 A	X 65 CrMo 14	440 A	-	X 70 CrMo 15	Z 70 D 14	-	-	-			ATI 440A
1.4112	SUS 440 B	X 90 CrMoV 18	440 B	409 S 19	X 90 CrMoV 18	Z 2 CND 18 05	2327	X CrTi 12				
1.4125	SUS 440 C	X 105 CrMo 17	440 C	-	X 105 CrMo 17	Z 100 CD 17	-	X 105 CrMo 17			95KH18	ATI 440C
1.6746		32NiCrMo14-5	-	832M31	32nicRmO145	35NCD14	-	-				
1.7176	SUP9(A)	55Cr3	5155	527A60	48	55C3	2253	55Cr3				
1.7225	SCM 440 (H)	42CrMo4	4140	708 M 40	42 CrMo 4	42 CD 4	2244	42 CrMo 4	F 1252		38HM	

Mat'l No.	JIS	DIN	Material Description			Composition / Structure / Heat Treatment					HB	HRc
			AISI/ASTM/SAE	BS	EN	Chilled cast iron					400	42
Mat'l No.	JIS	DIN	AISI/ASTM/SAE	BS	EN	AFNOR	SS	UNI	UNE / IHA	UNS	GOST	Brands
0.9620		GX260NiCr42	A532 IB	Grade 2 A	GJN-HV520	FB Ni4 Cr2 BC	0512	-		F45001		Ni-Hard2
0.9625		GX330NiCr42	A532 IA	Grade 2 B	GJN-HV550	FB Ni4 Cr2 HC	0513	-		F45000		Ni-Hard1
0.9630		GX300 CrNiSi 9 5 2	A532 ID	Grade 2 C	GJN-HV600	FB Cr9 Ni5	0457	-		F45003		Ni-Hard 4
0.9640		GX300CrMoNi1521	-	-	-	-	-	-		F45005		
0.9650		GX260Cr27	-	Grade 3 D			0466	-				
0.9655		GX300CrNiMo271	-	Grade 3 E			-	-			20C 25N20S2	
1.4841	SUH 310	X15G NiSi25-20	310	314S31	X 15 CrNiSi 25 20	Z15CNS25-20	-	-		S31400		Cronifer 2520

Mat'l No.	JIS	DIN	Material Description			Composition / Structure / Heat Treatment					HB	HRc
			AISI/ASTM/SAE	BS	EN	Hardened cast iron					550	55
Mat'l No.	JIS	DIN	AISI/ASTM/SAE	BS	EN	AFNOR	SS	UNI	UNE / IHA	UNS	GOST	Brands
0.9635		GX300CrMo 15 3	-	-	-	-	-	-				
0.9645		GX260 CrMoNi 20 21	-	-	-	-	-	-		F45007		

Technical Information

Comparison Chart - Turning Chipbreakers

Negative Inserts

Material	YG	Sandvik	Iscar	Kenna metal	Seco	Walter	Mitsu bishi	Kyocera	Tungaloy	Sumi tomo	Taegutec	Korloy	Duracarb
STEEL	UF	PF	F3P NF	FF FN	F1 MF2	FP5	FH LP	GP PP	TF	FL SP	FG FA	VF HU	41
	UL		PP NF			FP5	FY SY	CQ VF	TSF	LU	FC FT	HC	43
	UM		TF	MN	M3	MP3	MP	HS	TM	GU UX	MC PC	VM GM	46
	UG	PM	GN M3P	MN	M3 MR3	MP5	MP MA	PS	TM	UG	MT PC	GR HR	45
	UC	PR	NR	MP RP	MR4	RP5	Standard	Standard	TH	UZ	MG-	B25	53
	UR	PR	NR R3P	UN RN MG-	MR3 MR6	RP7	RP MH RK	PT PH	THS	ME MU	RT	GR	
STAINLESS STEEL	MF	MF	SF	FF	MF1	NF4	LM	MQ	SF HRF	SU	EA ML	HA	
	MM	MM	M3M	MP	MF3 MF4	NM4	MM	MS	SM	GU	EM	GS	42
	MR	MR	F3M	RF	M5	NR4	RM	MS MU	SH	EM	ET RT	RM	
CAST IRON	UC	PR	NR	MP RP	MR4	MK5	Standard	Standard	All Round	UZ	MG-	B25	53
	UR	PR	NR R3P	UN RN MG-	MR3 MR6	RK5 RK7	RP MH RK	PT PH	CH	ME MU	RT	GR	
	..MA			RP	MR7	..MA	MG-	C	CH	GZ	..MA		53

Positive Inserts

Material	YG	Sandvik	Iscar	Kenna metal	Seco	Walter	Mitsu bishi	Kyocera	Tungaloy	Sumi tomo	Taegutec	Korloy	Duracarb
STEEL	UF	PF	PF	LF UF	MF2	PF2 FP4	FM LM LP	GQ PP	01 PSF	FP	FG	HFP	41
	UG	PM		MF	MF3	MP4 FP6	MP Standard MM MV	HQ	PS PM	MU	MT	C25	51
STAINLESS STEEL	UF	PF	PF	LF	MF2	MM4 PS5	FM LM LP	GQ PP	PM	FP	FG	HFP	41
CAST IRON	UG	PM		UF	MF3	MK4 RK4	MP Standard MM MV	HQ	CM	MU	MT	C25	51
ALUMINUM	AL		AS	MF	AL	PF2 PM2	AZ	CF CK	AL	AG	FL	AK	AU

Technical Information

Comparison Chart - Turning Grades

ISO	YG	Sandvik	Iscar	Kenna metal	Seco	Walter	Mitsubishi	Kyocera	Tungaloy	Sumitomo	Taegutec	Korloy	Duracarb
P05	YG1001	GC4205 GC4305		KCPK05	TP0500 TP0501	WPP05S	UE6105						
P10	YG3010		IC8005 IC428	KCP05 KC9105 KCP05B KCP10 KCP10B KC9110		WPP01 WPP10S	UE6110	CA5505 CA510	T9105 T9205	AC810P	TT8115	NC3010	DC9015
P15	YG3015	GC4315 GC4215	IC8150 IC9015	KCP10	TP1501 TP1500		MC6015	CA5515 CA515	T9115 T9215	AC8015P	TT8115	NC3215	DC9015
P20	YG3020 (YG801)	GC4325 GC4225	IC8250 IC9015	KCP25 KC9125 KCP25B	TP2501 TP2500	WPP20S	MC6025 UE6020	CA5525 CA525	T9125 T9225	AC8025P AC820P	TT8125	NC3220 NC3225 NC3120	DC9025
P30	YG3030	GC4335 GC4235	IC8350 IC8025	KCP30 KCP30B KCP40B KC9140	TP3501 TP3500	WPP30S	MC6035 UE6035 VP15TF	CA5535 CA530 CR9025	T9135 T9235	AC8035P AC830P AC630M	TT5100 TT8135	NC3030 NC5330 PC3545	DC9025 DC8035
M10	YG211	GC2015 GC1115	IC807 IC6015 IC8150	KCU10 KCM15 KCM15B KC5010	CP200 TS2000	WSM10S	MC7015 VP10RT US7020	CA6515 PR930	T6120 AH110 AH8005 AH8015	AC610M	TT9215 TT5080	PC8105 PC8110	
M20	YG3030	GC2025 GC1125	IC3028 IC8250	KCM25 KCM25B	TM2000 TS2500	WMP20S	MC7205 VP15TF VP20MF UP20M	CA6525	T6130 AH120 AH725 SH725 GH330	AC6030M AC610M AC520U	TT9225	PC8115 NC9115 PC5300	
M30	YG213	GC2220	IC808 IC6025 IC8350	KCU25 KC5025	CP500	WSM20S WSM21	US735 MP7035 VP15RT VP20RT	PR1025 PR1125 PR1425 PR1535	AH630 SH730 GH730	AC6030M AC630M AC830P	TT9235 TT9020 TT9080	NC9125 NC5330 PC9030	DC8035
M40	YG214	GC2035		KCM35 KCM35B	CP600 TM4000 TP40	WSM30S	US735 MP7035		AH645	AC6040M AC530U	TT9235 TT8020 TT8080	NC9135 PC5400	
K05	YG1001	GC3205	IC5005	KCK05	TK1001 TK1000	WKK10S	MC5005 UC5105	CA4505 CA4010	T5105	AC405K	TT7005	NC6205	DC820 DC610
K10	YG1001	GC3210	IC5010 IC5100	KCK15	TK1001 TK1000	WKK10S	MC5015 UC5115	CA4515 CA4115	T515	AC415K	TT7310 TT7015	NC6210	
K15	YG3010	GC3215	IC8150	KCK20	TK2001 TK2000	WKK20S WKP30S	UE6110 VP15TF	CA4120	T5125	AC420K	TT6300	NC6215	
S10	YG211	GC1105 S05F H13A	IC807 IC808	K313 K68 KCS10 KCU10 KC5010	TS2000 TS2050 TS2500 CP200	WSM10S WS10	VP05RT MP9005 VP10RT MP9015	CA6515 PR1305 PR1310	AH110 AH120 AH8005 AH8015 AH905 SH730	AC510U	TT9215 TT5080	PC8105 PC8110 PC8115	DC820 DC610
S20	YG213	GC1115	IC806	KCU25 KC5025	890 883	WSM20S WSM21	VP15TF VP20RT	CA6525 PR1125 PR1325 PR1535	AH725	AC520U	TT9225 TT9080	NC9125 NC9135 PC5300	
S30	YG214	GC1125			CP500 CP600	WSM30S		PR1125 PR1535			TT9235 TT8020 TT8080	PC5400	

Technical Information

Comparison Chart - Milling Grades

ISO	YG-1	Sandvik	Iscar	Kennametal	Seco	Walter	Mitsubishi	Kyocera	Tungaloy	Sumitomo	Taegutec	Korloy
P20	YG712	GC4220 GC4230	IC950	KCPM20 KC522M	MP2500 MP3000 T250M	WKP25 WKP25S	MP6120 VP15TF	PR720 PR1025 PR1225	T3130 AH330 GH330	ACP200	TT7080 TT7030	NC5330 PC3500 PC3600
P30	YG603 YG622 YG602	GC1025 GC1030	IC808 IC907 IC908	KC522M KC635M KC927M	F25M F30M	WAM30 WKP35	MP6120 VP15TF MP6130 F7030	PR630 PR830 PR1230	AH725 AH730 AH120 GH130	ACP300 ACZ350	TT9080 TT9030	NC5340 NCM325 PC5300
M20	YG603 YG602	GC1125 GC1025 GC1030	IC808 IC907 IC908	KC522M KC635M	MP2500 F25M F30M	WQM35 WSM35S	VP15TF MP7130 VP20RT	PR730 PR1025 PR1225	T3030 AH725 AH120 AH4035	ACP200 ACM100 ACM200	TT9030 TT9080	NC5330 PC5300 PC9530 NC5340 NCM325
K10	YG5020 YG501	GC3330	IC5100	KC915M	MK1500 MP1500	WAK15	MP8010 MC5020			ACK100	TT7515	PC8110 PC6510
K20	YG622	GC3040	IC810 IC910	KCK15 KC520M	MK2050	WKK25	VP15TF	PR1210 PR1510	T1115 AH110	ACK200 ACK300	TT6080	NC5330 PC5300 NC5340
S20	YG602	S30T GC1025 S40T	IC328 IC907	KC510M KC635M	MS2050 MS2500	WSM35S WSP45S	MP9120 VP15TF	PR905 PR1025	AH725	AC520U	TT9030 TT8020	PC5300 PC5400

ISO ↔ ANSI

ISO	ANSI
AP.. 1504	AP.. 53
CC.. 060204	CC.. 21.51
CC.. 060208	CC.. 21.52
CC.. 09T302	CC.. 32.50.5
CC.. 09T304	CC.. 32.51
CC.. 09T308	CC.. 32.52
CC.. 120402	CC.. 430.5
CC.. 120404	CC.. 431
CC.. 120408	CC.. 432
CC.. 120412	CC.. 433
CN.. 120404	CN.. 431
CN.. 120408	CN.. 432
CN.. 120412	CN.. 433
CN.. 120416	CN.. 434
CN.. 160608	CN.. 542
CN.. 160612	CN.. 543
CN.. 160616	CN.. 544
CN.. 190608	CN.. 642
CN.. 190612	CN.. 643
CN.. 190616	CN.. 644
DC.. 070204	DC.. 21.51
DC.. 070208	DC.. 21.52
DC.. 11T302	DC.. 32.50.5
DC.. 11T304	DC.. 32.51
DC.. 11T308	DC.. 32.52
DN.. 150404	DN.. 431
DN.. 150408	DN.. 432
DN.. 150412	DN.. 433
DN.. 150412	CN.. 433
DN.. 150604	DN.. 441
DN.. 150608	DN.. 442
DN.. 150612	DN.. 443
SC.. 09T304	SC.. 32.51
SC.. 09T308	SC.. 32.52
SC.. 120408	SC.. 432
SD.. 1203	SD.. 42
SD.. 120420	SD.. 435
SD.. 1504	SD.. 53
SE.. 1203	SE.. 42
SN.. 120404	SN.. 431

ISO	ANSI
SN.. 120408	SN.. 432
SN.. 120412	SN.. 433
SN.. 120416	SN.. 434
SN.. 150612	SN.. 543
SP.. 1203	SP.. 42
SP.. 1504	SP.. 53
SPUN 120308	SPUN 422
TC.. 110204	TC.. 21.51
TC.. 110208	TC.. 21.52
TC.. 16T302	TC.. 32.50.5
TC.. 16T304	TC.. 32.51
TC.. 16T308	TC.. 32.52
TN.. 160404	TN.. 331
TN.. 160408	TN.. 332
TN.. 160412	TN.. 333
TN.. 220404	TN.. 431
TN.. 220408	TN.. 432
TN.. 220412	TN.. 433
TN.. 220416	TN.. 434
TNUX 160404	TNUX 331
TNUX 160408	TNUX 332
TP.. 1603	TP.. 32
TP.. 2204	TP.. 43
TPUN 160308	TPUN 322
VB.. 160404	VB.. 331
VB.. 160408	VB.. 332
VC.. 160402	VC.. 330.5
VC.. 160404	VC.. 331
VC.. 160408	VC.. 332
VN.. 160404	VN.. 331
VN.. 160408	VN.. 332
VN.. 160412	VN.. 333
WN.. 060404	WN.. 331
WN.. 060408	WN.. 332
WN.. 060412	WN.. 333
WN.. 080404	WN.. 431
WN.. 080408	WN.. 432
WN.. 080412	WN.. 433
WN.. 080416	WN.. 434

Search

INSERT

Description	Page
ADKT	84
AOMT	84
APKT	85
APMT	87
APXT	86
CCGT	50
CCMT	50
CNMA	32
CNMG	32
DCGT	51
DCMT	51
DNMA	35
DNMG	35
KNUX	38
ODMT	70
ODMW	70
OFER	71
OFMT	71
ONHU	72
ONMU	72
RBEX	93
RCMT	52
RDKT	91
RDKW	91
RDMT	92
RDMW	92
RPMT	93
RPMW	93
SCMT	53
SDCN	73
SDKN	73
SDMT	95
SDMW	95
SEKN	74

Description	Page
SEKR	74
SEKT	75
SEGT	76
SEMT	77
SNMA	39
SNMG	39
SNMX	78
SPCN	79
SPKN	79
SPKR	79
SPMT	80
SPMX	98
SPUN	81
TCGT	54
TCMT	54
TDN	59
TDP	59
TDY	59
TNMA	41
TNMG	41
TNUX	44
TPCN	88
TPKN	88
TPKR	88
TPUN	89
VBMT	55
VCGT	56
VCMT	56
VNMA	45
VNMG	45
WCMX	99
WNMA	47
WNMG	47

MILLING CUTTER

Description	Page
...-APKT10-...	82
...-APKT16-...	82
...-APMT11-...	83
...-ODMT06-...	68
...-RDKT08-...	90
...-RDKT10-...	90
...-RDKT12-...	90
...-SEKT12-...	69

TURNING HOLDER

Description	Page
MCLNR/L	26
MDJNR/L	26
MSBNR/L	27
MSRNR/L	27
MSSNR/L	27
MTGNR/L	28
MTJNR/L	28
MVJNR/L	29
MWLNR/L	30

MEMO



A large grid of dotted lines for writing, occupying the majority of the page.



A large grid area for writing, consisting of a fine grid of small squares.

HIGH QUALITY PRODUCTS and ON TIME DELIVERY for WORLD-WIDE CUSTOMERS

Since 1982, YG-1 has been committed to quality, innovation and the unique customer experience.

Our performance and experience have granted YG-1 the global impression of one of the leading manufacturers of high quality cutting tool solutions. This global footprint expands over 75 countries, with international logistic centers, pledging to our customers to give the best service available today - and tomorrow.

EUROPE



ASIA PACIFIC



AMERICAS



AFRICA



 **YG-1 CO., LTD.**

* For the more information on sales network, please contact the head office as below;

YG-1 HEAD OFFICE

211, Sewolcheon-ro, Bupyeong-gu, Incheon, South Korea

Phone : +82-32-526-0909

E-mail : yg1@yg1.kr

www.yg1.kr

AHB

TOOLING & MACHINERY

COMPLETE METALWORKING SOLUTIONS

(800) 991-4225
ISO Certified

www.ahbinc.com
customerservice@ahbinc.com

YG-1 CO., LTD.

YG-1 USA

730 Corporate Woods Parkway,
Vernon Hills, IL 60061 U.S.A.

YG-1 CANADA INC.

3375 North Service Road, Unit A8
Burlington, Ontario, CANADA L7N 3G2

GLOBAL HEADQUARTERS

211, Sewolcheon-ro, Bupyeong-gu,
Incheon, South Korea
Phone: +82-32-526-0909
yg1@yg1.kr
yg1.kr

Note The information is provided for reference only. Tool specifications are subject to change without prior notice. Although we endeavor to supply accurate and timely information, there can be no guarantee to cover every particular application. YG-1 or publishers are not liable for any damage for use of the information.



Search 'YG-1' on social media outlets