

Kennedy

Since 1911

TOOL BOXES
CHESTS/CABINETS
WORK STATIONS
MODULAR CABINETS

America's Premier Industrial Tool Storage



Kennedy

"Built to Work—Built to Last"™



www.kennedymfg.com

Maintenance Pro™

Kennedy MP Series

*Designed from the wheels up specifically
for the maintenance professional*



- Full-width, full-depth chests hold more tools
- Roller cabinets roll smoothly on 6 x 2" ball-bearing casters
- Maintenance carts include non-slip, open weave drawer liners to keep tools in place
- Maintenance carts also come with durable, coated MDF work surface
- All Maintenance Pro™ products come with tubular high-security locks with two keys
- Available in two new colors—gloss blue finish and gloss yellow finish

Pro-Line™ Kennedy

New Products



*Maintenance Carts
Built to Work—Built to Last*



- High-gloss Black Powder Finish
- Heavy-welded Steel Construction
- High-security Tubular Key Locks
- Ball-bearing Drawer Slides
- Heavy-Duty Tubular Side Handles
- Full-width Aluminum Drawer Pulls
- Heavy-duty Roller-bearing Casters
- MDF Work Surface

New! Canopy for 53" MP Maintenance Cart

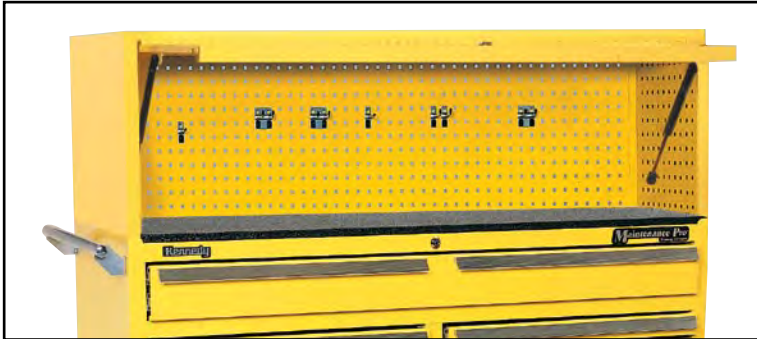

Canopy is designed to add storage space to 5300MP/5301MP maintenance carts. All steel construction with secure locking system. Twin gas struts keep door open for full access to interior. Inner wall (back and sides) has square hole perforations for versatile hanging storage. 30-piece toolholder set is included (see page 30 for description of set no. 99852). Canopy size is 53"W x 18" D and 20"H. See page 11 for more information.

Benchmark Series®

New! 60" Benchmark® Series Canopy:

- Full-access open storage, ideal for storing parts and tools
- Secure double point locking system
- Twin gas struts open door
- Bolts to cabinet for security
- Includes 30-piece assorted hook set

New! 60" Benchmark® Series Cabinet:

- Ball-bearing drawer slides on all drawers
- Full-width drawer pulls
- Heavy-duty non-slip drawer liner in every drawer plus top mat to protect work surface
- 6 x 2" roller bearing casters

See page 8 for more details!



NEW! KENNEDY HMS™ SERIES "HYBRID MODULAR STORAGE"

Combines the economy of roller cabinet construction with modular cabinet features!

- Kennedy Quality
- Flexible Drawer Divider System
- Stationary & Mobile Models
- Drawer Safety Interlock
- 130-220 lbs. Drawer Weight Capacity

Compact, high-density storage that saves space while it organizes parts, tools and supplies in the best traditions of "Lean Manufacturing" and 5S Programs. Cabinets are stackable, can be fork-lifted and used as work stations. See page 45.



Table of Contents



Benchmark Series,
Professional Series
Chests/Cabinets
.....8-9



Maintenance Pro™
Series Maintenance
Carts/Chests
.....10-11



Pro-Line™ Series
Maintenance Carts
.....12



Industrial Series
Maintenance
Carts/Chests
.....13



Industrial Series
Roller Cabinets,
Hang-on Cabinets,
Versa-Carts®,
Mechanics' Chests
.....14-17



Machinists Chests
.....18



Mechanics' Chests
.....19-20



Steel Tool Boxes
.....21



KenCraft
Medium Duty
Chests/Cabinets
.....22



KenCraft
Gun Cabinets
.....22



Service Cases
.....23



Tool Storage
Accessories
.....24-25



Versa-Benches
.....26-27



Work Stations
.....28-29



Tool Board
Systems
.....30-32



Stainless Steel
Storage Products
.....33



Modular Cabinets
.....36-40



Mobile Modular
Cabinets41



Stationery/Mobile
Work Stations
.....42-43



Compact Modular
Cabinets.....43-44



HMST™ Series
Hybrid Modular Storage
.....45



Modular Storage
Drawer/Cabinet
Accessories
.....46-48



Plastic Sockets
& Tool Trays
.....50

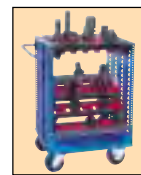

Pre-engineered
Tool Trolleys
.....51



Pre-Engineered
Tool Storage Racks
.....52

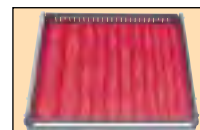

Drawers & Drawer
Divider Accessories
.....53

Numeric Index
by Item Number54-55

Lean Manufacturing . . . 5S . . . Tool Control

Lean Manufacturing is the process of reducing all activities on the shop floor that do not add value!

5S is the process of creating a clutter-free workplace with visual controls through 5 steps—the 5 steps in English are:

Housekeeping—Workplace Organization—Clean Up—Standardized Procedures—Sustained Improvements

How can Kennedy help?

Kennedy has unique products and systems to visually store and control parts, bins and tools in both stationary and mobile applications.



Tool Control promotes the logical organization and easy access of NECESSARY Tools.

Tool Control means:

- *Fewer Tools to Purchase*
- *Easier Maintenance of Tools*
- *Higher Productivity*
- *Better Oversight of Tools—
fewer tools disappear or are misplaced*



Machinists' Chests Facts and Features



Drop-front panels are double-wall construction for added rigidity and tool security. Your valuable tools can't walk away with the drop-front panel in place and the chest locked. Front panel conceals and secures drawers. Stores in base when not in use.

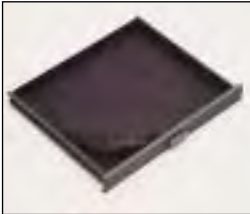

Thick, wool felt drawer liners help keep precision tools clean and protect against corrosion.



Chest lid hinges are equipped with rust-resistant, stainless-steel pins which are staked to prevent punch-out and lid removal.



Take a look at the double-wall side panel. Both an inner and outer steel wall in a critical chest area. Look at the full-depth slides and slide carrier channels too. This integral, side panel/slide construction evenly distributes and transfers drawer loads to the chest bottom panel. An important aid in eliminating stress on the chest spot welds.

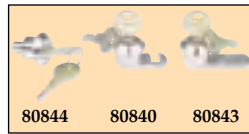

80844 80840 80843

Kennedy uses 350 cylinder lock and key changes to help protect your chest's contents. All Kennedy chests and cabinets come with two keys.



Take the two-piece drawer slides on Kennedy machinists' chests. They are stronger than one-piece slides which have weak shoulder areas and may split under heavy drawer loads. Slide limit stops keep the drawers from extending beyond the chest frame. Spring clips on the slides allow drawer removal for cleaning.

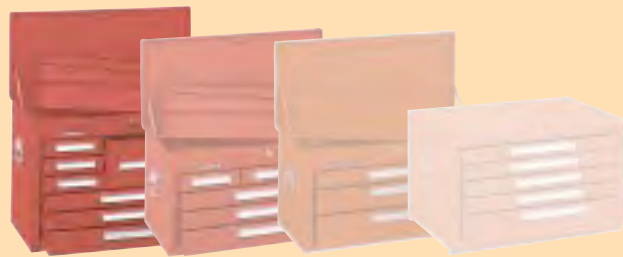

Mechanics' Chests Facts & Features



The tamper-proof, internal drawer locking system cannot be reached by bolt cutters or hacksaw, or damaged when one drawer is closed with the chest locked.

Smooth operating, full-length chest hinges are staked and securely welded to prevent lid removal.



Rugged, cap-end construction on chest lids uses one of the strongest, self-reinforcing structural designs known to keep lids square and weathertight.



Two-piece, I-beam drawer slides permit smooth, easy full drawer extension. And, they're stronger than one-piece slides which have weak shoulder areas and may split under heavy drawer loads.

Slide limit stops keep drawers from extending beyond the chest frame. Spring clips on the slides allow drawer removal for cleaning.



All chest exposed edges are rolled and flattened for added strength and safety.



One-piece, heavy-gauge steel back, bottom and top till panels are securely welded to the double-wall side panels, giving the chests a tight, solid fit. This integral, chest construction evenly distributes and transfers drawer loads to the chest bottom panel. An important aid in eliminating stress on the chest spot welds.



New, full-depth chests with full-width drawers offer ball bearing slides.



Roller Cabinets Facts and Features

Universal Drawer Slide System offers unlimited flexibility of drawer configuration and drawer slide selection. Slide carrier channels are slotted at 2" increments to allow the maximum drawer configuration. **Full-depth slide carrier channels provide support for the snap-in friction and ball bearing drawer slides. Both types are interchangeable for maximum storage capabilities.**



Ongoing vibration, load impact and other destructive testing in engineering facilities makes sure the products are built right. Every unit is inspected after final assembly to further improve quality control and protect your investment.

Heavy-gauge steel top, bottom and back panels are securely welded to the double-wall side panels; giving the cabinet a tight, solid, fit. This integral cabinet construction evenly distributes and transfers all drawer loads to the cabinet bottom panel and casters.

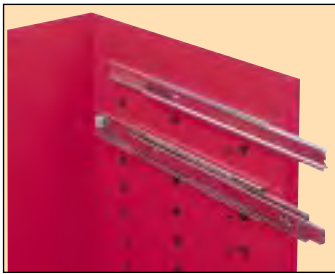

Now all Kennedy roller cabinets are available with ball-bearing drawer slides (except model 2005). Three member, full ball-bearing slides with four levels of ball bearings permit effortless, feather-light movement even though drawers are fully loaded. Self-cleaning bridged retainers prevent dirt from building up and keep drawers operating smoothly for years under the heaviest loads.



Cabinet top panels are reinforced for added strength and rigidity.

Solid aluminum and plated steel hardware set off the durable powder finish that is resistant to corrosion, abrasions and chipping.



The heavy-gauge steel, one-piece cabinet bottom panels are reinforced to provide added strength and greater load capacity without sagging.

The tamper-proof, internal drawer locking system on Kennedy cabinets cannot be reached by bolt cutters or hacksaw. Or damaged when one drawer is closed with the cabinet locked.

Easy-roll, low-drag five-inch soft rubber casters can be used in most wet or corrosive environments. Two rigid and two swivel casters with toe locks are standard on all cabinets. Models 273, 273X, 275, 275X, 277, and 277X come with standard 5 x 1 1/4" casters. Models 295, 295X, 297, 297X, 376X, 378X, and 348X come with 5 x 2 inch riveted sintered bearing casters. Models 2907X, 3407X, 310X and 315X come with 5 x 2" roller bearing casters with grease fittings bolted to full length heavy gauge, formed bottom reinforcements. Four 3-inch swivel casters are standard on 2005.

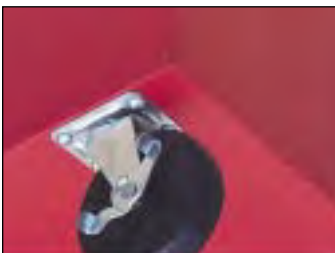

Rugged, 6 x 2" roller bearing casters made of black polypropylene tread molded to a polypropylene core provide smooth mobility under the heaviest loads. Swivel casters have lock brake that locks both wheel and swivel for added safety. Four 6 x 2" casters, two rigid, two swivel, come standard on all Benchmark[®], Maintenance Pro[™] and larger Pro-Line[™] maintenance cart models.

The one-piece bottom panels are welded outside the cabinet body for a hand-in-glove fit. Gives the cabinets a solid foundation to help absorb bumps and eliminate stress on the cabinet spot welds.

Important: A word about this catalog. We have tried to make this catalog as comprehensive and factual as possible. However, since the time of printing, some of the information may have been updated. Check with your Kennedy supplier for complete information. The right is reserved to make changes at any time, without notice, in prices, materials, specifications and models.

Chest and cabinet dimensions are given without hardware. Cabinet dimensions with casters. Width is left to right; depth is front to back; height is top to bottom.

Features & Benefits

Benchmark Series®

benchmark—(bēnch•märk) n. a standard by which others are measured.



Benchmark® Series

46" 8-Drawer Chest 46" 11-Drawer Cabinet
60" Canopy 60" 11-Drawer Cabinet

Kennedy's finest in a tool storage combo has all the extras a mechanic would want . . .

- Ball-bearing drawer slides that move easily under heavy drawer loads
- 46" chest and cabinet drawer capacity is 130 lbs.
- 60" cabinet small drawer capacity is 130 lbs., 60" cabinet large drawer capacity is 220 lbs., with extra-long drawer capacity of 440 lbs.
- Extra large, full-width drawer pulls
- Heavy, duty non-slip drawer liner in every drawer
- Large 6 x 2" roller bearing heavy duty casters . . . and more!



Benchmark® Series 60" Canopy Features:

- Full-access open storage, ideal for storing parts and tools
- Secure double point locking system
- Twin gas struts open door
- Bolts to cabinet for security
- Includes 30-piece assorted hook set no. 99852. See page 30 for list of set contents

Powder-coated finishes available



Full-width corner trim for appearance and protection



Tubular high security locks on all units



Tubular steel side handles



Extra-large full width, extruded aluminum drawer pulls

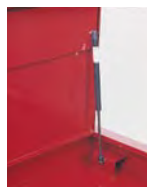

Gas-shock chest lid stays



Ball-bearing slides on all drawers allow smooth drawer operation



Heavy-duty, non-slip drawer liner in every drawer, plus top mats for roller cabinets



Huge 6 x 2" casters

	Red	Black	Burgundy	Dimensions (Inches)			Net	Ship	
	UPC No.	UPC No.	UPC No.	Drs.	Width	Depth	Wt. Lbs.	Wt. Lbs.	
46" Chest	46000	46002	46001	8	46	24	19	210	230
	Drawers:			Top Till			45%	23%	4%
				2	12%	22½	2		
				2	12%	22½	4		
				2	26%	22½	2		
46" Cabinet	46003	46005	46004	11	46	24	42½	425	450
	Drawers:			1	40	22½	5		
				2	12%	22½	2		
				1	12%	22½	4		
				1	12%	22½	6		
				1	12%	22½	8		
				2	25	22½	2		
				1	25	22½	4		
60" Canopy & Cabinet	60102	60101	60103	—	60	24	22½	140	158
	60122	60121	60123	11	60	24	44½	600	650
	Drawers:			1	54%	22½	5		
				2	12%	22½	2		
				3	12%	22½	4		
				1	12%	22½	6		
				3	35%	22½	4		
			1	35%	22½	10			

Mechanic's Chests

12-DRAWER

2912X

3412X



Match up 2912X with 2907X and 3412X with 3407X to make the perfect combos for the mechanic who wants maximum storage for all his tools.

Made of heavyweight 18 gauge steel construction with ball-bearing drawer slides on all drawers. Come with full-length aluminum drawer pulls and tubular high security locks.

Choice of brown wrinkle or smooth red powder finish.

No.	Brn.	Red	Drs.	Dimensions (Inches)			Net	Ship
	UPC No.	UPC No.		Width	Depth	Height	Wt. Lbs.	Wt. Lbs.
2912X	00856	00857	12	29	20	20½	166	181
Drawers:			Top Till	28¾	19¼	2½		
			9	7¼	18	2		
			2	25	18	2		
			1	25	18	4		
3412X	00858	00859	12	34	20	20½	181	196
Drawers:			Top Till	33¾	19¼	2½		
			9	9¼	18	2		
			2	30	18	2		
			1	30	18	4		



2912X or 3412X

Roller Cabinets

7-DRAWER

2907X

3407X



Cabinet body of 18 and 16 gauge steel construction. Triple reinforced front corners and full-height slide carriers. End wall reinforced to give triple wall construction. Comes with 5 x 2" roller bearing casters bolted to full-length, heavy gauge bottom reinforcements and tubular high security locks. Drawers of 18 gauge steel construction and ball-bearing drawer slides on all drawers.

Choice of brown wrinkle finish or smooth red powder finish.

No.	Brn.	Red	Drs.	Dimensions (Inches)			Net	Ship
	UPC No.	UPC No.		Width	Depth	Height	Wt. Lbs.	Wt. Lbs.
2907X	10159	10157	7	29	20	40	198	215
Drawers:			3	25	18½	2		
			3	25	18½	4		
			1	25	18½	10		
3407X	10162	10160	7	34	20	40	209	231
Drawers:			3	30	18½	2		
			3	30	18½	4		
			1	30	18½	10		



2907X or 3407X

Heavy-Duty Extended Mobile Combo

5-DRAWER

4405 Chest

10-DRAWER

4410 Roller Cabinet

Model 4405 chest comes with full-length aluminum drawer pulls. Compartment has removable partial shelf and locking door. Five drawers with ball-bearing slides and locking door are keyed alike.

Model 4410 roller cabinet includes tubular end handle, four 6 x 2" roller bearing casters with phenolic wheels bolted to full-length, heavy gauge bottom reinforcements; two 10" ball bearing wheels with solid rubber tires on center axle provide maximum maneuverability; and two locks keyed alike. Full-width drawer holds object up to 39" long. All drawers have ball-bearing slides. Available in brown wrinkle or smooth red powder finish.

No.	Brn.	Red	Drs.	Dimensions (Inches)			Net	Ship
	UPC No.	UPC No.		Width	Depth	Height	Wt. Lbs.	Wt. Lbs.
4405	10283	10281	5	43¾	20	16½	123	137
Drawers:			4	25	18½	2		
			1	25	18½	4		
			Compartment	15½	19¾	15¾		
4410	10284	10282	10	43¾	20	37½	301	316
Drawers:			1	39½	18½	6		
			2	25	18½	2		
			3	25	18½	4		
			3	12	18½	2		
			1	12	18½	10		



4405



4410

Professional Series

Specially designed for the maintenance professional, Maintenance Pro™ products feature a full-line of chests, roller cabinets, maintenance carts and mobile benches.



2700MP



3401MP



2702MP



3403MP



380MP



3401MP/3403MP/301MP

5-Drawer Maintenance Chest

Facts and Features:

Ball-bearing drawer slides on all drawers plus large full-width pulls make opening drawers smoother and easier. Come with tubular high security lock and two keys.

Available in gloss blue and gloss yellow powder finish.

No.	Yellow	Blue	Drs.	Dimensions (Inches)			Net	Ship
	UPC	UPC		Width	Depth	Height	Wt.	Wt.
No.	No.	No.					Lbs.	Lbs.
2700MP	00868		5	27	18	18½	90	98
Drawers:			4	23	16½	2		
			1	23	16½	4		
2701MP		00869	Same dimensions as 2700MP				90	98
3400MP	00870		5	34	20	18½	146	156
Drawers:			4	30	18½	2		
			1	30	18½	4		
3401MP		00871	Same dimensions as 3400MP				146	156

6-Drawer Roller Cabinet Facts and Features:

Ball-bearing drawer slides on all drawers plus large full-width pulls make opening drawers smoother and easier.

Come with tubular high security lock and two keys and tubular side handle. Heavy-duty top mat protects work surface.

Rugged, over-sized 6 x 2" roller bearing casters provide smooth mobility.

Available in gloss blue and gloss yellow powder finish.

No.	Yellow	Blue	Drs.	Dimensions (Inches)			Net	Ship
	UPC	UPC		Width	Depth	Height	Wt.	Wt.
No.	No.	No.					Lbs.	Lbs.
2702MP	00872		6	27	18	39	140	150
Drawers:			1	23	16½	2		
			4	23	16½	4		
			1	23	16½	10		
2703MP		00873	Same dimensions as 2702MP				140	150
3402MP	00874		6	34	20	40	221	243
Drawers:			1	30	18½	2		
			4	30	18½	4		
			1	30	18½	10		
3403MP		00875	Same dimensions as 3402MP				221	243

Hang-on Cabinets Facts and Features:

Two models available add extra storage to Maintenance Pro™ roller cabinets.

Both models include two adjustable shelves with ball-bearing slides and locking door. Heavy-duty top mat protects work surface. Can be attached to either side of roller cabinet.

Available in gloss blue and gloss yellow powder finish.

No.	Yellow	Blue	Dimensions (Inches)			Net	Ship	
	UPC	UPC	Width	Depth	Height	Wt.	Wt.	
No.	No.	No.				Lbs.	Lbs.	
380MP	00876		13¾	18	33¾	53	58	
Shelves (2):			9¾	16½	2			
381MP		00877	Same dimensions as 380MP				53	58
300MP	00878		13¾	20	33¾	56	61	
Shelves (2):			9¾	18½	2			
301MP		00879	Same dimensions as 300MP				56	61

Maintenance Cart Facts and Features:

- Ball-bearing drawer slides on all drawers plus large full-width pulls make opening drawers smoother and easier
- Includes non-slip, open weave drawer liners
- Durable, coated MDF work surface protects cabinet top
- Come with tubular high security lock and two keys
- Available in gloss blue and gloss yellow powder finish

No.	Yellow	Blue	Drs.	Dimensions (Inches)			Net	Ship
	UPC No.	UPC No.		Width	Depth	Height	Wt. Lbs.	Wt. Lbs.
3900MP	00880		8	39½	20	39	225	250
Drawers:			3	35	18½	2		
			4	35	18½	4		
			1	35	18½	6		
3901MP		00881	Same dimensions as 3900MP				225	250

6 x 2" roller bearing casters and 10" wheels mounted on a center axle create maximum stability and maneuverability. Ten-drawer model has top drawer that holds tools up to 39" long.

No.	Yellow	Blue	Drs.	Dimensions (Inches)			Net	Ship
	UPC No.	UPC No.		Width	Depth	Height	Wt. Lbs.	Wt. Lbs.
4400MP	00882		10	43¾	20	37½	316	331
Drawers:			1	39½	18½	6		
			2	25	18½	2		
			3	25	18½	4		
			3	12	18½	2		
			1	12	18½	10		
4401MP		00883	Same dimensions as 4400MP				316	331

Rugged 6 x 2" roller bearing casters and 10" wheels mounted on a center axle create maximum stability and maneuverability. Twelve drawer models have full-width top drawer.

No.	Yellow	Blue	Drs.	Dimensions (Inches)			Net	Ship
	UPC No.	UPC No.		Width	Depth	Height	Wt. Lbs.	Wt. Lbs.
5300MP	00884		12	53	18	40½	283	323
Drawers:			1	49	16½	4		
			4	23	16½	2		
			5	23	16½	4		
			1	23	16½	6		
			1	23	16½	10		
5301MP		00885	Same dimensions as 5300MP				283	323
5804MP	00904		12	58	20	42½	478	503
Drawers:			1	52¾	18¾	6		
			4	25	18¾	2		
			5	25	18¾	4		
			1	25	18¾	6		
			1	25	18¾	10		
5805MP		00905	Same dimensions as 5804MP				478	503

Maintenance cart canopy adds storage space to 5300MP/5301MP maintenance carts. Twin gas struts keep door open for full access to interior. Inner wall has square hole perforations for versatile hanging storage.

No.	Yellow	Blue	Drs.	Dimensions (Inches)			Net	Ship
	UPC No.	UPC No.		Width	Depth	Height	Wt. Lbs.	Wt. Lbs.
5350MP	00900		53	18	20	75	85	
5351MP		00901	Same dimensions as 5350MP				75	85

10-Drawer Heavy-duty Mobile Versa-Bench®

Rugged 8 x 2" roller bearing phenolic wheels hold up to 3600 lbs. Two doors cover drawers and can be padlocked for security.

No.	Yellow	Blue	Drs.	Dimensions (Inches)			Net	Ship
	UPC No.	UPC No.		Width	Depth	Height	Wt. Lbs.	Wt. Lbs.
4800MP	00888		10	48	26	35¾	500	530
Drawers:			1	44	23½	5		
			2	30	23½	2		
			3	30	23½	4		
			3	12	23½	2		
			1	12	23½	10		
4801MP		00889	Same dimensions as 4800MP				500	530



3900MP

8-Drawer models 3900MP and 3901MP have rugged 6 x 2" roller bearing casters to move tools to the job easily.



4401MP



5300MP/5804MP

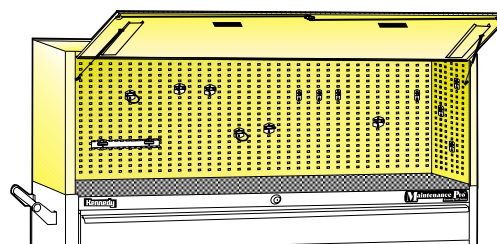

5350MP

30-piece toolholder set no. 99852 is included (see page 30 for set contents).



4800MP

Pro-Line™ Maintenance Carts

"Built to Work" — "Built to Last"

- High-gloss Black Powder Finish
- Heavy-welded Steel Construction
- High-security Tubular Key Locks
- Ball-bearing Drawer Slides
- Heavy-duty Tubular Side Handles
- Full-width Aluminum Drawer Pulls
- Heavy-duty Roller-bearing Casters
- MDF Work Surface



10493 or 10495



10492 or 10494



10491

Maintenance Carts

12-Drawer

39" x 18" 41" x 20"

10493 **10495**

Model 10493 comes with 35" extra wide top drawer to hold large, bulky tools. Also includes 5 x 2" roller bearing casters.

Model 10495 comes with 37" extra wide top drawer. Includes 6 x 2" roller bearing casters.

Black gloss finish.

UPC No.	Drs.	Dimensions (Inches)			Net Wt. Lbs.	Ship Wt. Lbs.
		Width	Depth	Height		
10493	12	39½	18	39	225	255
Drawers:	1	35½	16½	6		
	2	23	16½	2		
	3	23	16½	4		
	1	23	16½	6		
	2	9¾	16½	2		
	2	9¾	16½	4		
	1	9¾	16½	10		
10495	12	41½	20	42	250	280
Drawers:	1	37½	18½	6		
	2	25	18½	2		
	3	25	18½	4		
	1	25	18½	6		
	2	9¾	18½	2		
	2	9¾	18½	4		
	1	9¾	18½	10		

Maintenance Carts

13-Drawer

39" x 18" 41" x 20"

10492 **10494**

Model 10492 comes with 5 x 2" roller bearing casters.

Model 10494 comes with 6 x 2" roller bearing casters.

Black gloss finish.

UPC No.	Drs.	Dimensions (Inches)			Net Wt. Lbs.	Ship Wt. Lbs.
		Width	Depth	Height		
10492	13	39½	18	39	220	250
Drawers:	1	23	16½	2		
	5	23	16½	4		
	1	23	16½	6		
	1	9¾	16½	2		
	4	9¾	16½	4		
	1	9¾	16½	10		
10494	13	41½	20	42	245	275
Drawers:	1	25	18½	2		
	5	25	18½	4		
	1	25	18½	6		
	1	9¾	18½	2		
	4	9¾	18½	4		
	1	9¾	18½	10		

Maintenance Cart

7-Drawer

39" x 18"

10491

Model 10491 includes adjustable MDF shelf inside compartment secured by locking door. Includes 5 x 2" roller bearing casters. Black gloss finish.

UPC No.	Drs.	Dimensions (Inches)			Net Wt. Lbs.	Ship Wt. Lbs.
		Width	Depth	Height		
10491	7	39½	18	35	175	205
Drawers:	3	23	16½	2		
	3	23	16½	4		
	1	23	16½	6		
Compartment:	10%	18	18	28		



310X



315X



Model 315X with Maple Top

Protect your maintenance cart with a 1½" thick butcher block maple top or a heavy-duty non-slip top mat. See our Tool Storage Accessory Catalog for details.



Model 310X with Top Mat

Maintenance Carts

10-DRAWER 15-DRAWER

BALL-BEARING SLIDES

310X

315X

Maintenance carts move more tools to the job than ever before!

Both models have huge 39" x 18" work surface, full-width drawer pulls and tubular side handle for ease of handling. Two keyed-alike, high security tubular locks keep tools safe. Four 5 x 2" roller bearing casters move tools smoothly. Body made of 18 gauge steel, drawers of 20 gauge steel.

Ball-bearing drawer slides on all drawers permit smooth drawer operation under heavy loads.

Choice of brown wrinkle or smooth red powder finish.

No.	Brn.	Red	Drs.	Dimensions (Inches)			Net	Ship
	UPC No.	UPC No.		Width	Depth	Height	Wt. Lbs.	Wt. Lbs.
310X	64310	64311	10	39½	18	35	180	210
Drawers:			3	23	16½	4		
			2	23	16½	6		
			3	9½	16½	4		
			2	9½	16½	6		
315X	64314	64315	15	39½	18	39	230	260
Drawers:			5	23	16½	2		
			3	23	16½	4		
			1	23	16½	6		
			2	9½	16½	2		
			3	9½	16½	4		
			1	9½	16½	12		

305X



Maintenance Chest

5-DRAWER

BALL-BEARING SLIDES

305X

Maintenance chest tops off maintenance cart models 310X and 315X with the maximum in storage for the maintenance mechanic.

Chest fits flush on Pro-Line™ 39" maintenance carts and will also fit on 41" Pro-Line™ models. See page 12.

Model 305X has snap-in ball-bearing drawer slides, full-length drawer pulls and high security tubular lock. Compartment has removable partial shelf and locking door.

Choice of brown wrinkle, smooth red or black gloss powder finish.

No.	Brn.	Red	Black	Drs.	Dimensions (Inches)			Net	Ship
	UPC No.	UPC No.	UPC No.		Width	Depth	Height	Wt. Lbs.	Wt. Lbs.
305X	00658	00659	00902	5	39½	18	16½	93	102
Drawers:			4	23	16½	2			
			1	23	16½	4			
Compartment:				13½	17¼	13¼			



273 or 273X



275 or 275X
295 or 295X



277 or 277X
297 or 297X

Roller Cabinets

All 27" wide models accommodate any 27" wide or smaller chests, chest bases or riser. 29" wide models will also accommodate 29" wide or smaller chests and chest bases.

5 x 1¼" casters standard on 27" cabinet;
5 x 2" sintered bearing casters standard on 29" cabinets.



Drawers have automatic, internal locking system.

Choice of brown wrinkle or smooth red powder finish.

3-DRAWER FRICITION SLIDES 273

3-DRAWER BALL-BEARING SLIDES 273X

Model 273 has snap-in standard friction drawer slides. Model 273X has snap-in ball-bearing drawer slides.

Swing-down panel conceals and secures spacious storage compartment.

No.	Brn.	Red	Drs.	Dimensions (Inches)			Net	Ship
	UPC No.	UPC No.		Width	Depth	Height	Wt. Lbs.	Wt. Lbs.
273	00058	10298	3	27	18	35	99	110
Drawers:			2	23	16½	4		
			1	23	16½	6		
Compartment				24½	17¼	11¼		
273X	00604	00605	Same dimensions as 273				102	113

5-DRAWER FRICITION SLIDES 275

5-DRAWER BALL-BEARING SLIDES 275X

295

295X

Models 275 and 295 have snap-in standard friction drawer slides.

Models 275X and 295X have snap-in ball-bearing drawer slides.

Swing-down panel conceals and secures spacious storage compartment.

No.	Brn.	Red	Drs.	Dimensions (Inches)			Net	Ship
	UPC No.	UPC No.		Width	Depth	Height	Wt. Lbs.	Wt. Lbs.
275	00060	10299	5	27	18	35	110	121
Drawers:			3	23	16½	2		
			2	23	16½	4		
Compartment				24½	17¼	11¼		
275X	00606	00607	Same dimensions as 275				115	126
295	00067	10147	5	29	20	35	128	140
Drawers:			3	25	18½	2		
			2	25	18½	4		
Compartment				26½	19¼	11¼		
295X	00612	00613	Same dimensions as 295				133	145

7-DRAWER FRICITION SLIDES 277

7-DRAWER BALL-BEARING SLIDES 277X

297

297X

Models 277 and 297 have snap-in standard friction drawer slides.

Models 277X and 297X have snap-in ball-bearing drawer slides.

No.	Brn.	Red	Drs.	Dimensions (Inches)			Net	Ship
	UPC No.	UPC No.		Width	Depth	Height	Wt. Lbs.	Wt. Lbs.
277	00063	10146	7	27	18	35	127	138
Drawers:			3	23	16½	2		
			3	23	16½	4		
			1	23	16½	6		
277X	00608	00609	Same dimensions as 277				134	145
297	00071	10425	7	29	20	35	146	158
Drawers:			3	25	18½	2		
			3	25	18½	4		
			1	25	18½	6		
297X	00614	00615	Same dimensions as 297				153	165

Roller Cabinets

27" wide models accommodate any 27" wide or smaller chests, chest bases or riser. 34" wide model will also accommodate 29" or 34" wide chests and chest bases. 5 x 2" sintered bearing casters standard on 27" and 34" cabinets. Drawers have an automatic, internal locking system. Choice of brown wrinkle or smooth red powder finish.



6-DRAWER BALL-BEARING SLIDES 376X

Four inches taller than our 27 and 29 inch wide cabinets shown on page 14.

Model 376X has snap-in ball-bearing drawer slides.

Side handle and 5 x 2 inch casters standard.

No.	Brn.	Red	Drs.	Dimensions (Inches)			Net	Ship
	UPC No.	UPC No.		Width	Depth	Height	Wt. Lbs.	Wt. Lbs.
376X	00616	00617	6	27	18	39	137	148
Drawers:			3	23	16½	2		
			3	23	16½	4		
			Compartment	24½	17¼	11¼		



376X

8-DRAWER BALL-BEARING SLIDES 378X

Just the cabinet to fill the needs of those who want workbench height and loads of tool storage space.

Four inches taller than our 27 and 29 inch wide cabinets shown on page 14.

Snap-in ball-bearing drawer slides. Side handle and 5 x 2 inch casters standard.

No.	Brn.	Red	Drs.	Dimensions (Inches)			Net	Ship
	UPC No.	UPC No.		Width	Depth	Height	Wt. Lbs.	Wt. Lbs.
378X	00618	00619	8	27	18	39	154	165
Drawers:			3	23	16½	2		
			4	23	16½	4		
			1	23	16½	6		



378X

8-DRAWER BALL-BEARING SLIDES 348X

This big size cabinet has that top-of-the-line look—inside and out. Use with 2805, 2806 and 2812 chests.

Cabinet body made of 18 gauge steel; drawers of 20 gauge steel; bottom panel of 16 gauge steel. The bottom panel is also reinforced on the caster side with "hat section" channels.

Snap-in ball-bearing drawer slides side handle and 5 x 2 inch sintered bearing casters standard.

No.	Brn.	Red	Drs.	Dimensions (Inches)			Net	Ship
	UPC No.	UPC No.		Width	Depth	Height	Wt. Lbs.	Wt. Lbs.
348X	10165	10164	8	34	20	40	206	228
Drawers:			3	30	18½	2		
			4	30	18½	4		
			1	30	18½	6		



348X



185 or 185X
205 or 205X

Hang-On Cabinets

5-DRAWER

FRICITION SLIDES

185

5-DRAWER

BALL-BEARING SLIDES

185X

205X

Both cabinets have internal drawer locking system and bolt to either side of your roller cabinet.

Models 185 and 185X fit Kennedy models 273, 273X, 275, 275X, 277, 277X.

Models 205 and 205X fit Kennedy models 295, 295X, 297, 297X.



All available in brown wrinkle or smooth red powder finish.

No.	Brn.	Red	Drs.	Dimensions (Inches)			Net	Ship
	UPC No.	UPC No.		Width	Depth	Height	Wt. Lbs.	Wt. Lbs.
185	10406	10407	5	13 $\frac{3}{4}$	18	29	67	71
Drawers:			1	9 $\frac{3}{4}$	16 $\frac{1}{2}$	2		
			3	9 $\frac{3}{4}$	16 $\frac{1}{2}$	4		
			1	9 $\frac{3}{4}$	16 $\frac{1}{2}$	10		
185X	00622	00623	Same dimensions as 185				72	76
205	10408	10409	5	13 $\frac{3}{4}$	20	29	72	77
Drawers:			1	9 $\frac{3}{4}$	18 $\frac{1}{2}$	2		
			3	9 $\frac{3}{4}$	18 $\frac{1}{2}$	4		
			1	9 $\frac{3}{4}$	18 $\frac{1}{2}$	10		
205X	00624	00625	Same dimensions as 205				77	82

Hang-On Cabinets

6-DRAWER

BALL-BEARING SLIDES

306X

386X



Both cabinets have internal drawer locking system and bolt to either side of your roller cabinet.

Model 386X fits Kennedy models 376X and 378X.

Model 306X fits Kennedy models 348X, 2907X and 3407X.

Both models available in brown wrinkle or smooth red powder finish.



306X
386X

No.	Brn.	Red	Drs.	Dimensions (Inches)			Net	Ship
	UPC No.	UPC No.		Width	Depth	Height	Wt. Lbs.	Wt. Lbs.
386X	00664	00665	6	13 $\frac{3}{4}$	18	33 $\frac{3}{4}$	89	94
Drawers:			1	9 $\frac{3}{4}$	16 $\frac{1}{2}$	2		
			4	9 $\frac{3}{4}$	16 $\frac{1}{2}$	4		
			1	9 $\frac{3}{4}$	16 $\frac{1}{2}$	10		
306X	00666	00667	6	13 $\frac{3}{4}$	20	33 $\frac{3}{4}$	94	100
Drawers:			1	9 $\frac{3}{4}$	18 $\frac{1}{2}$	2		
			4	9 $\frac{3}{4}$	18 $\frac{1}{2}$	4		
			1	9 $\frac{3}{4}$	18 $\frac{1}{2}$	10		

Hang-On Cabinets

2-SHELF

182

202

382

302

Universal hang-on cabinets have two adjustable pull-out shelves that operate on ball-bearing slides provide easy access to tools. All cabinets have locking door and bolt to either side of your roller cabinet.

Model 182 fits Kennedy models 273, 273X, 275, 275X, 277 and 277X. Model 202 fits Kennedy models 295, 295X, 297 and 297X.

Model 382 fits Kennedy models 376X and 378X.

Model 302 fits Kennedy models 348X, 2907X and 3407X.

All available in brown wrinkle or smooth red powder finish.



182, 202
382, 302

No.	Brn.	Red	Dimensions (Inches)			Net	Ship
	UPC No.	UPC No.	Width	Depth	Height	Wt. Lbs.	Wt. Lbs.
182	00847	00848	13 $\frac{3}{4}$	18	29	45	49
Shelves:			9 $\frac{3}{4}$	16 $\frac{1}{2}$	2		
202	00849	00850	13 $\frac{3}{4}$	20	29	47	52
Shelves:			9 $\frac{3}{4}$	18 $\frac{1}{2}$	2		
382	00851	00852	13 $\frac{3}{4}$	18	33 $\frac{3}{4}$	53	58
Shelves:			9 $\frac{3}{4}$	16 $\frac{1}{2}$	2		
302	00845	00846	13 $\frac{3}{4}$	20	33 $\frac{3}{4}$	56	61
Shelves:			9 $\frac{3}{4}$	18 $\frac{1}{2}$	2		



Drawer Interlock Roller Cabinets

BALL-BEARING SLIDES

297LX 378LX



"Only one-drawer-open-at-a-time" drawer interlock safety feature helps prevent cabinets from tipping under heavy drawer loads due to several drawers being open at the same time.

Models 297LX and 378LX have snap-in ball-bearing drawer slides and 5 x 2" casters.

All models available in brown wrinkle or smooth red powder finish.

No.	Brn.	Red	Drs.	Dimensions (Inches)			Net	Ship
	UPC No.	UPC No.		Width	Depth	Height	Wt. Lbs.	Wt. Lbs.
297LX	00676	00677	7	29	20	35	157	169
Drawers:			3	25	18½	2		
			3	25	18½	4		
			1	25	18½	6		
378LX	00678	00679	8	27	18	39	158	170
Drawers:			3	23	16½	2		
			4	23	16½	4		
			1	23	16½	6		



Drawer Interlock safety feature prevents opening more than one drawer at a time.

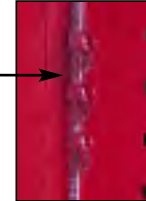

Roller Cabinet Add-Ons

Foldaway Shelf DS1

DS1 shelf provides 2.4 square feet of added work surface. Raised sides keep tools from rolling off. Folds flat when not in use.

Attaches to any 27, 29 or 34 inch wide cabinet. Bolts furnished.

Choice of brown wrinkle or smooth red powder finish.

No.	Brn.	Red	Dimensions (Inches)			Net	Ship
	UPC No.	UPC No.	Width	Depth	Height	Wt. Lbs.	Wt. Lbs.
DS1	00066	10155	20¾	17¾	1	10.5	11

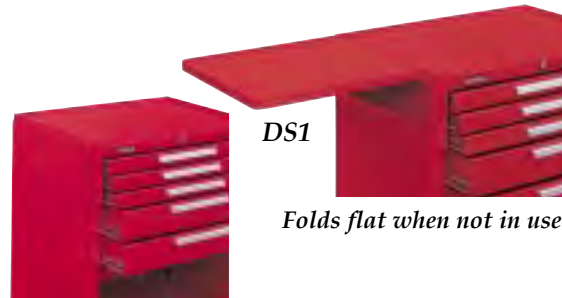

Versa-Carts®

5-DRAWER FRICTION SLIDES 415 435

5-DRAWER BALL-BEARING SLIDES 415X 435X

All include deck of 16 gauge steel with 1½ inch high sides. Reinforced on wheel and caster side with "hat section" channels. Come with two ten-inch, ball bearing wheels with solid rubber tires and two 5 x 2 inch swivel casters with toe locks. Strong tubular steel handle and attachment hardware included. 1,000 pound capacity.

Models 415 and 435 have snap-in friction drawer slides.

Models 415X and 435X have snap-in ball-bearing drawer slides.

Models 415 and 415X include 410 platform and five-drawer cabinet. Use with any 27" wide cabinet shown on page 14. Available in brown wrinkle or smooth red powder finish.

Models 435 and 435X include 430 platform and five-drawer cabinet. Use with any 29" wide cabinet shown on page 14. Available in brown wrinkle or smooth red powder finish.

No.	Brn.	Red	Drs.	Dimensions (Inches)			Net	Ship
	UPC No.	UPC No.		Width	Depth	Height	Wt. Lbs.	Wt. Lbs.
415	10412	10413	5	41¾	18¾	36¾	102	112
Drawers:			1	9¾	16½	2		
			3	9¾	16½	4		
			1	9¾	16½	10		
415X	00626	00627		Same dimensions as 415			107	117
435	10414	10415	5	43¾	20¾	36¾	118	131
Drawers:			1	9¾	18½	2		
			3	9¾	18½	4		
			1	9¾	18½	10		
435X	00628	00629		Same dimensions as 435			123	136

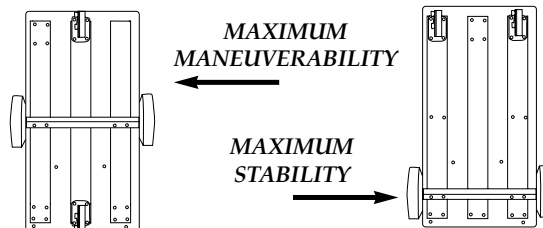

Pick your wheel and caster arrangement.

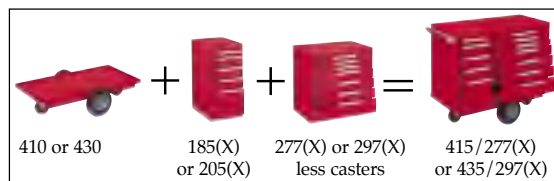

Machinists' Chests & Chest Bases

3-DRAWER Apprentice 620

Drawers and top till wool felt-lined. Vinyl cushioned, steel core top handle.
Model 620 comes with four adjustable, zinc coated steel drawer dividers.
 Spring clips hold in place. Available in brown wrinkle powder finish.
Model 520 comes with six adjustable, zinc coated steel drawer dividers.
 Spring clips hold in place. Available in brown wrinkle powder finish.

No.	Brn. UPC No.	Drs.	Dimensions (Inches)			Net	Ship
			Width	Depth	Height	Wt. Lbs.	Wt. Lbs.
620	00003	3	20 $\frac{3}{8}$	8 $\frac{1}{2}$	13 $\frac{3}{8}$	25	32
		Top Till	20	8 $\frac{3}{8}$	3 $\frac{1}{4}$		
Drawers:		1	18 $\frac{1}{4}$	7 $\frac{1}{2}$	1 $\frac{1}{2}$		
		1	18 $\frac{1}{4}$	7 $\frac{1}{2}$	2 $\frac{1}{4}$		
		1	18 $\frac{1}{4}$	7 $\frac{1}{2}$	3 $\frac{1}{8}$		
520	00001	7	20 $\frac{3}{8}$	8 $\frac{1}{2}$	13 $\frac{3}{8}$	28	35
		Top Till	20	8 $\frac{3}{8}$	3 $\frac{1}{4}$		
Drawers:		4	8 $\frac{3}{8}$	7 $\frac{1}{2}$	1		
		1	8 $\frac{3}{8}$	7 $\frac{1}{2}$	2		
		1	18 $\frac{1}{4}$	7 $\frac{1}{2}$	1 $\frac{1}{2}$		
		1	18 $\frac{1}{4}$	7 $\frac{1}{2}$	2 $\frac{1}{4}$		

8-DRAWER Journeyman 526

11-DRAWER Professional 52611

11-DRAWER Professional 3611

Drawers and top till wool felt-lined.
Model 526 comes with steel side handles and six adjustable, zinc coated steel drawer dividers standard. Spring clips hold in place.
Model 52611 comes with steel side handles and eight adjustable, zinc coated steel drawer dividers standard. Spring clips hold in place.
Model 3611 has felt covered bottom glides to protect drop front panel from scratches. Comes with steel side handles and six adjustable, zinc coated steel drawer dividers standard. Spring clips hold in place.
 All models available in brown wrinkle powder finish.

No.	Brn. UPC No.	Drs.	Dimensions (Inches)			Net	Ship
			Width	Depth	Height	Wt. Lbs.	Wt. Lbs.
526	00002	8	26 $\frac{1}{2}$	8 $\frac{1}{2}$	13 $\frac{3}{8}$	36	44
		Top Till	26 $\frac{1}{2}$	8 $\frac{3}{8}$	3 $\frac{1}{4}$		
Drawers:		Handbook	5 $\frac{1}{2}$	7 $\frac{1}{2}$	3 $\frac{1}{4}$		
		4	8 $\frac{3}{8}$	7 $\frac{1}{2}$	1		
		1	8 $\frac{3}{8}$	7 $\frac{1}{2}$	2		
		1	24 $\frac{1}{4}$	7 $\frac{1}{2}$	1 $\frac{1}{2}$		
		1	24 $\frac{1}{4}$	7 $\frac{1}{2}$	2 $\frac{1}{4}$		
52611	00094	11	26 $\frac{1}{2}$	8 $\frac{1}{2}$	18	47	56
		Top Till	26 $\frac{1}{2}$	8 $\frac{3}{8}$	3 $\frac{1}{4}$		
Drawers:		Handbook	5 $\frac{1}{2}$	7 $\frac{1}{2}$	4 $\frac{3}{8}$		
		6	8 $\frac{3}{8}$	7 $\frac{1}{2}$	1		
		1	8 $\frac{3}{8}$	7 $\frac{1}{2}$	2		
		1	24 $\frac{1}{4}$	7 $\frac{1}{2}$	1 $\frac{1}{2}$		
		1	24 $\frac{1}{4}$	7 $\frac{1}{2}$	2 $\frac{1}{4}$		
		1	24 $\frac{1}{4}$	7 $\frac{1}{2}$	3 $\frac{1}{8}$		
3611	10430	11	26 $\frac{1}{8}$	12	18 $\frac{3}{8}$	69	75
		Top Till	26	11 $\frac{1}{2}$	2 $\frac{1}{2}$		
Drawers:		Handbook	5 $\frac{1}{2}$	10 $\frac{1}{4}$	5 $\frac{1}{2}$		
		6	7 $\frac{3}{8}$	10 $\frac{1}{4}$	1 $\frac{1}{4}$		
		1	7 $\frac{3}{8}$	10 $\frac{1}{4}$	2 $\frac{1}{2}$		
		2	23	10 $\frac{1}{4}$	2		
		1	23	10 $\frac{1}{4}$	3		

Add-On Bases

MC22 MC28 5150

All models have wool felt-lined top drawer.
Model MC22 fits under models 620 and 520; **models 5150 and MC28** fit 526, 52611 and 3611. Available in brown wrinkle powder finish.

No.	Brn. UPC No.	Drs.	Dimensions (Inches)			Net	Ship
			Width	Depth	Height	Wt. Lbs.	Wt. Lbs.
MC22	00004	2	21 $\frac{3}{8}$	9 $\frac{3}{8}$	7 $\frac{3}{8}$	17	19
Drawers:		1	18	9 $\frac{3}{8}$	1 $\frac{1}{2}$		
		1	18	9 $\frac{3}{8}$	3 $\frac{1}{2}$		
MC28	00005	2	28 $\frac{3}{8}$	9 $\frac{3}{8}$	7 $\frac{3}{8}$	21	23
Drawers:		1	24 $\frac{1}{2}$	9 $\frac{3}{8}$	1 $\frac{1}{2}$		
		1	24 $\frac{1}{2}$	9 $\frac{3}{8}$	3 $\frac{1}{2}$		
5150	05150	2	26 $\frac{3}{4}$	12 $\frac{1}{2}$	9 $\frac{1}{2}$	28	37
Drawers:		1	25	10 $\frac{1}{4}$	2		
		1	25	10 $\frac{1}{4}$	4 $\frac{3}{8}$		



For over 90 years, American journeymen and apprentices have made Kennedy the machinist's tool box of choice. Handed down from father to son, four generations of American craftsmen know Kennedy quality and durability.



Mechanics' Chests

5-DRAWER BALL-BEARING SLIDES

2705X 2905X

New full-depth chests store a variety of tools.

Model 2705X fits on 27" wide cabinets;

model 2905X fits on 29" wide cabinets.

Both models have snap-in ball-bearing slides.

Choice of brown wrinkle or smooth red powder finish.



2705X or 2905X

No.	Brn.	Red	Dimensions (Inches)				Net	Ship
	UPC No.	UPC No.	Drs.	Width	Depth	Height	Wt. Lbs.	Wt. Lbs.
2705X	00650	00651	5	27	18	18 $\frac{3}{4}$	88	96
Drawers:			Top Till	26 $\frac{1}{2}$	17 $\frac{1}{2}$	2 $\frac{1}{2}$		
			4	23	16 $\frac{1}{2}$	2		
			1	23	16 $\frac{1}{2}$	4		
2905X	00654	00655	5	29	20	18 $\frac{3}{4}$	100	109
Drawers:			Top Till	28 $\frac{1}{2}$	19 $\frac{1}{2}$	2 $\frac{1}{2}$		
			4	25	18 $\frac{1}{2}$	2		
			1	25	18 $\frac{1}{2}$	4		



360

26-INCH 360

28-INCH 2812

Right at home in a plant or auto maintenance bay.

Top till holds lift-out tray equipped with socket set divider.

Model 360 fits on 27" or 29" wide roller cabinets; model 2812 fits on 29" or 34" wide cabinets. Both available with friction slides only.

Choice of brown wrinkle or smooth red powder finish.

No.	Brn.	Red	Dimensions (Inches)				Net	Ship		
	UPC No.	UPC No.	Drs.	Width	Depth	Height	Wt. Lbs.	Wt. Lbs.		
360	00078	10289	10	26 $\frac{1}{2}$	12 $\frac{1}{2}$	18 $\frac{3}{4}$	68	75		
Drawers:			Top Till	26	11 $\frac{1}{2}$	2 $\frac{1}{2}$				
			Tote Tray	19 $\frac{1}{2}$	7 $\frac{3}{4}$	3 $\frac{1}{2}$				
			1	6 $\frac{1}{2}$	10 $\frac{3}{4}$	6 $\frac{1}{4}$				
			6	6 $\frac{1}{2}$	10 $\frac{3}{4}$	2				
			2	22 $\frac{1}{2}$	10 $\frac{3}{4}$	2				
2812	28122	28121	1	22 $\frac{1}{2}$	10 $\frac{3}{4}$	3				
			12	28 $\frac{1}{2}$	12	18 $\frac{3}{4}$	71	78		
					Top Till	26	11 $\frac{1}{2}$			
					Tote Tray	19 $\frac{1}{2}$	7 $\frac{3}{4}$	3 $\frac{1}{2}$		
					9	8 $\frac{1}{2}$	10 $\frac{3}{4}$	2		
		2	26 $\frac{1}{2}$	10 $\frac{3}{4}$	2					
		1	26 $\frac{1}{2}$	10 $\frac{3}{4}$	3					



2812

26-INCH 266

28-INCH 2806

The mechanic's favorite chest for storage space and value.

Top till with lift-out tray equipped with socket set divider.

Model 266 fits on 27" or 29" wide roller cabinets; model 2806 fits on 29" or 34" wide cabinets. Both available with friction slides only.

Choice brown wrinkle or smooth red powder finish.

No.	Brn.	Red	Dimensions (Inches)				Net	Ship		
	UPC No.	UPC No.	Drs.	Width	Depth	Height	Wt. Lbs.	Wt. Lbs.		
266	00048	10141	6	26 $\frac{1}{2}$	12	14 $\frac{3}{4}$	52	58		
Drawers:			Top Till	26	11 $\frac{1}{2}$	2 $\frac{1}{2}$				
			Tote Tray	19 $\frac{1}{2}$	7 $\frac{3}{4}$	3 $\frac{1}{2}$				
			3	6 $\frac{1}{2}$	10 $\frac{3}{4}$	2				
			2	22 $\frac{1}{2}$	10 $\frac{3}{4}$	2				
			1	22 $\frac{1}{2}$	10 $\frac{3}{4}$	3				
2806	28062	28061	6	28 $\frac{1}{2}$	12	14 $\frac{3}{4}$	54	60		
					Top Till	26	11 $\frac{1}{2}$	2 $\frac{1}{2}$		
					Tote Tray	19 $\frac{1}{2}$	7 $\frac{3}{4}$	3 $\frac{1}{2}$		
					3	8 $\frac{1}{2}$	10 $\frac{3}{4}$	2		
					2	26 $\frac{1}{2}$	10 $\frac{3}{4}$	2		
		1	26 $\frac{1}{2}$	10 $\frac{3}{4}$	3					



266 or 2806



285 or 285X
2805 or 2805X



263



2902 or 2602



2603



2604



2600

5-DRAWER FRICTION SLIDES 285 2805

5-DRAWER BALL-BEARING SLIDES 285X 2805X

Full-width drawers store and organize extra-long tools.

Model 285 fits on 27" wide roller cabinets and has snap-in friction slides; **model 2805** fits on 29" wide cabinets and has snap-in friction slides. **Model 285X** fits on 27" wide roller cabinets and has snap-in ball-bearing slides; **model 2805X** fits on 29" wide cabinets and has snap-in ball-bearing slides.

Choice of brown wrinkle or smooth red powder finish.

No.	Brn. UPC No.	Red UPC No.	Drs.	Dimensions (Inches)			Net Wt. Lbs.	Ship Wt. Lbs.
				Width	Depth	Height		
285	00050	10329	5	27	18	16 $\frac{1}{2}$	75	84
Drawers:				4	23	16 $\frac{1}{2}$	2	
			1	23	16 $\frac{1}{2}$	4		
285X	00600	00601		Same dimensions as 285			80	89
2805	28052	28051	5	29	20	16 $\frac{1}{2}$	87	96
Drawers:				4	25	18 $\frac{1}{2}$	2	
			1	25	18 $\frac{1}{2}$	4		
2805X	00602	00603		Same dimensions as 2805X			92	101

3-DRAWER—263

Drawers lock automatically when the lid is closed. Double lid stays safely hold lid open. Top till holds lift-out tray equipped with socket set divider. Available in snap-in friction slides only.

Choice of brown wrinkle or smooth red powder finish.

No.	Brn. UPC No.	Red UPC No.	Drs.	Dimensions (Inches)			Net Wt. Lbs.	Ship Wt. Lbs.
				Width	Depth	Height		
263	00044	10422	3	26 $\frac{1}{2}$	12	14 $\frac{1}{4}$	44	50
				Top Till	26	11 $\frac{1}{4}$	2 $\frac{1}{2}$	
				Tote Tray	19 $\frac{1}{2}$	7 $\frac{1}{4}$	3 $\frac{1}{2}$	
Drawers:				1	23	10 $\frac{1}{2}$	2	
				1	23	10 $\frac{1}{2}$	3	
				1	23	10 $\frac{1}{2}$	4	

Add-On Bases

26-INCH

2602 2603 2604

29-INCH

2902

Use 2602, 2603 and 2604 with 263, 266 and 360 chests, and 27", 29" or 34" roller cabinets.

Model 2902 accommodates models 2812 and 2806 chests, and 29" or 34" roller cabinets.

All available in snap-in friction slides only.

Choice of brown wrinkle or smooth red powder finish.

No.	Brn. UPC No.	Red UPC No.	Drs.	Dimensions (Inches)			Net Wt. Lbs.	Ship Wt. Lbs.
				Width	Depth	Height		
2602	26022	26021	2	26 $\frac{1}{2}$	12 $\frac{1}{2}$	11 $\frac{1}{4}$	30	40
Drawers:				2	22 $\frac{1}{2}$	10 $\frac{1}{4}$	4 $\frac{1}{2}$	
2603	26032	26031	3	26 $\frac{1}{2}$	12 $\frac{1}{2}$	11 $\frac{1}{4}$	33	43
Drawers:				2	22 $\frac{1}{2}$	10 $\frac{1}{4}$	2	
			1	22 $\frac{1}{2}$	10 $\frac{1}{4}$	4 $\frac{1}{2}$		
2604	26042	26041	4	26 $\frac{1}{2}$	12 $\frac{1}{2}$	11 $\frac{1}{4}$	35	45
Drawers:				4	22 $\frac{1}{2}$	10 $\frac{1}{4}$	2	
2902	29022	29021	2	28 $\frac{3}{4}$	12 $\frac{1}{2}$	11 $\frac{1}{4}$	36	46
Drawers:				2	24 $\frac{1}{2}$	10 $\frac{1}{4}$	4 $\frac{1}{2}$	

Chest Riser—2600

Add storage and work surface to your roller cabinet. Use with 263, 266 and 360 chests, or 2602, 2603 and 2604 chest bases.

Choice of brown wrinkle or smooth red powder finish.

No.	Brn. UPC No.	Red UPC No.	Dimensions (Inches)			Net Wt. Lbs.	Ship Wt. Lbs.
			Width	Depth	Height		
2600	26002	26001	26 $\frac{1}{2}$	12 $\frac{1}{2}$	11 $\frac{1}{4}$	9	19

Cantilever Tool Boxes

18 INCH 22 INCH

1018 1022

You'll like the way each opens to see all your tools at a glance.

Movable/removable partitions and divider sets permit you to create six compartments in each of two trays.

Quality plated locking hardware and steel core, vinyl cushioned handles make these boxes a pleasure to own and use.

Model 1022 has divider for storing socket sets.

Brown wrinkle powder finish.

No.	Brn.	Trays	Dimensions (Inches)			Net	Ship
	UPC No.		Width	Depth	Height	Wt. Lbs.	Wt. Lbs.
1018	00026	4	18½	10	12½	18.25	19.5
1022	00027	4	22½	10	12½	21	22.5



1018



1022

Professional Tool Boxes

20 INCH 24 INCH 32 INCH

K20 K24 K32X

Include lift-out tray, vinyl coated, steel top handle.

K20 and K24 trays have socket set divider.

Model K32X also has plated side carry handles.

Brown wrinkle powder finish.

No.	Brn.	Trays	Dimensions (Inches)			Net	Ship
	UPC No.		Width	Depth	Height	Wt. Lbs.	Wt. Lbs.
K20	00031		20½	8½	9¼	13	14
		Tray	19½	7¼	3¼		
K24	00032		24½	8½	9¼	14.5	16
		Tray	23½	7¼	3¼		
K32X	00033		32½	8½	9¼	18	20
		Tray	31½	4¼	1¼		

Has two compartments



K20 or K24



K32X

Tool Toters

20 INCH

5220

Great for storing the tools you need for the car, boat, pickup or your household.

Brown wrinkle powder finish with lift-out tray.

No.	Brn.	Trays	Dimensions (Inches)			Net	Ship
	UPC No.		Width	Depth	Height	Wt. Lbs.	Wt. Lbs.
5220	05220		20	7¼	7¼	9	10
		Tray	19¾	6¾	4		



5220

For the Do-It-Yourselfer

2-DRAWER 5-DRAWER

220 Chest 2005 Roller Cabinet

Model 220 can be paired with model 2005 cabinet for handy home combo. Or, think of it as a tool chest you can take on the job or on a trip.

Model 2005 can also be used with 620 or 520 machinists' chests. Has tamper-proof, internal drawer locking system. Comes with four three-inch swivel casters.

Choice of brown wrinkle or smooth red powder finish.

No.	Brn.	Red	Drs.	Dimensions (Inches)			Net	Ship
	UPC No.	UPC No.		Width	Depth	Height	Wt. Lbs.	Wt. Lbs.
220	00083	10427	2	20½	8½	9¼	17	19
		Top Till		20	8½	2¼		
Drawers:			2	18½	7½	2¼		
2005	10410	10411	5	20½	13½	32½	70	78
Drawers:			1	17½	12¼	2		
			3	17½	12¼	4		
			1	17½	12¼	10		



220



220 closed



2005



Hand Carry Tool Boxes



Medium Duty Chests and Cabinets

Lighter weight but sturdy enough to hold your most used tools. Come with snap-in friction slides, standard lock and side handles.

Black textured finish.

No.	Black UPC No.	Drs.	Dimensions (Inches)			Net Wt.	Ship Wt.
			Width	Depth	Height	Lbs.	Lbs.
283KC	00827	3	27	18	16½	69	78
Drawers:		3	23	16½	4		
284KC	00828	4	27	18	16½	71	80
Drawers:		2	23	16½	2		
		2	23	16½	4		
285KC	00829	5	27	18	16½	75	84
Drawers:		4	23	16½	2		
		1	23	16½	4		

No.	Black UPC No.	Drs.	Dimensions (Inches)			Net Wt.	Ship Wt.
			Width	Depth	Height	Lbs.	Lbs.
273KC	00833	3	27	18	35	99	110
Drawers:		2	23	16½	4		
		1	23	16½	6		
275KC	00834	5	27	18	35	110	121
Drawers:		3	23	16½	2		
		2	23	16½	4		
		Compartment	24¾	17¼	11¼		
276KC	00835	6	27	18	35	112	123
Drawers:		1	23	16½	2		
		4	23	16½	4		
		1	23	16½	6		

KenCraft Home Security Cabinets and Reloading Bench



1501 10-Gun Cabinet

- Holds 10 shotguns or rifles up to 53" long.
- 21½ x 13¾ x 55"H.



1510 5-Gun Cabinet

- Holds 5 shotguns or rifles up to 51" long.
- 13¾ x 9 x 52"H.



1500 10-Gun Cabinet

- Holds 10 shotguns or rifles up to 54" long.
- 20¾ x 13¾ x 55"H.



1520 14-Gun Cabinet

- Holds 14 shotguns or rifles up to 54" long.
- 20¾ x 18 x 55"H.



Model 520
See page 19

1550 Deluxe Reloading Bench

- Comes with 1½" thick butcher block maple work surface 54" x 20".
- Compartment has two shelves.
- Five 4" drawers store reloading supplies.
- Adjustable leg levelers.
- Assembly required.
- Black textured finish.

Reloading supplies not included.



1530 Add-On Cabinet

- Fastens to 1500 or 1520 gun cabinets.
- Includes one adjustable shelf and mounting hardware.
- 20¾ x 13¾ x 18"H.



1547 Pistol Box

- Foam liner protects handguns from scratches.
- Individual units will stack and fasten together. Hardware included.
- 8¾ x 7¾ x 13¾"H.

For your free KenCraft brochure call 1-800-413-8665 or e-mail us at kmcinfo@kennedymfg.com

Portable Parts Storage

Steel briefcase-style storage case has variety of compartments to hold small parts. Choose from plastic box inserts or vacuum-formed one-piece insert.

Foam-lined lid prevents parts from spilling when lid is closed. Double latches keep lid closed securely. Comfortable, vinyl-cushioned steel core handle.

Brown wrinkle powder finish.

No.	Brn. UPC No.	Comp.	Dimensions (Inches)			Net Wt. Lbs.	Ship Wt. Lbs.
			Width	Depth	Height		
12008	12008	8	17 $\frac{7}{8}$	14	2 $\frac{3}{4}$	8.1	9.1
	Box Size:	8	4 $\frac{1}{4}$	6 $\frac{3}{8}$	2 $\frac{3}{8}$		
12012	12012	12	17 $\frac{7}{8}$	14	2 $\frac{3}{4}$	8.3	9.3
	Box Size:	12	4 $\frac{1}{4}$	4 $\frac{1}{4}$	2 $\frac{3}{8}$		
12023	12023	23	17 $\frac{7}{8}$	14	2 $\frac{3}{4}$	8.3	9.3
	Box Size:	12	2 $\frac{1}{2}$	2 $\frac{1}{2}$	2 $\frac{3}{8}$		
		6	2 $\frac{1}{2}$	4 $\frac{1}{4}$	2 $\frac{3}{8}$		
		3	4 $\frac{1}{4}$	4 $\frac{1}{4}$	2 $\frac{3}{8}$		
		2	4 $\frac{1}{4}$	6 $\frac{3}{8}$	2 $\frac{3}{8}$		
12024	12024	24	17 $\frac{7}{8}$	14	2 $\frac{3}{4}$	8.3	9.3
	Box Size:	24	2 $\frac{1}{2}$	4 $\frac{1}{4}$	2 $\frac{3}{8}$		
12036	12036	36	17 $\frac{7}{8}$	14	2 $\frac{3}{4}$	8.4	9.4
	Box Size:	24	2 $\frac{1}{2}$	2 $\frac{1}{2}$	2 $\frac{3}{8}$		
		12	2 $\frac{1}{2}$	4 $\frac{1}{4}$	2 $\frac{3}{8}$		
12108	12108	8	17 $\frac{7}{8}$	14	2 $\frac{3}{4}$	7.6	8.6
	Insert Comp. Size:	6	4	3 $\frac{3}{4}$	2 $\frac{1}{2}$		
		1	7 $\frac{7}{8}$	4	2 $\frac{1}{2}$		
		1	16 $\frac{1}{4}$	3 $\frac{3}{4}$	2 $\frac{1}{2}$		
12112	12112	12	17 $\frac{7}{8}$	14	2 $\frac{3}{4}$	7.6	8.6
	Insert Comp. Size:	12	3 $\frac{3}{4}$	4	2 $\frac{1}{2}$		

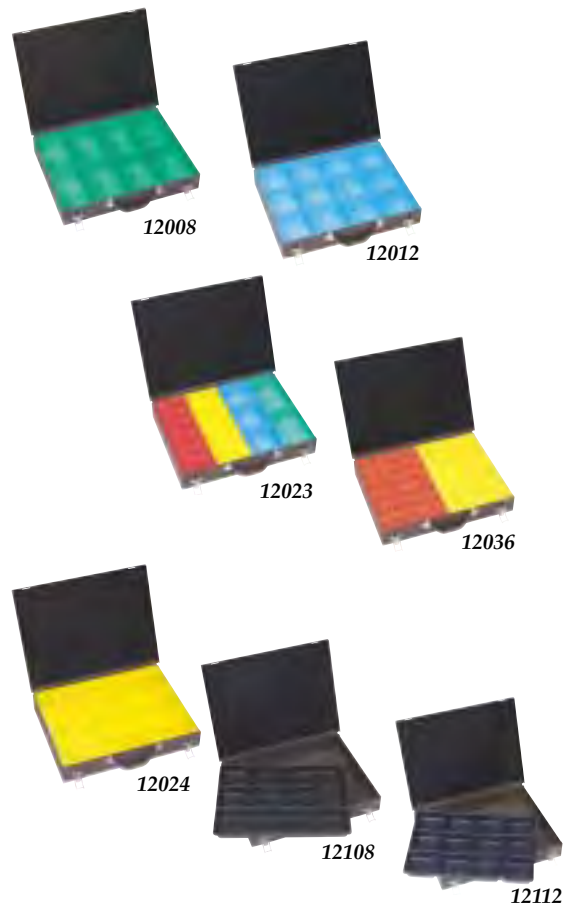

Portable Parts Storage & Toolholder System

Tool Storage Accessories

Replacement and add-on items for your Kennedy tool boxes, chests, roller cabinets and work stations. Some of our most popular tool storage accessories are shown below. For your free copy of our Tool Storage Accessory Catalog, call us today at 1-800-413-8665 or e-mail us at kmcinfo@kennedymfg.com. Visit our website at www.kennedymfg.com.



Standard Cylinder Lock/Key Sets

- Key your chest and cabinet alike. Kennedy uses 350 lock and milled key changes for added tool protection.
- All locks can be keyed alike.



Tubular Key High Security Lock Sets

- The type of lock found in many coin boxes, vending machines, pay phones, etc.
- Seven pin tumbler cylinder construction.
- All locks can be keyed alike.



(Padlock not included)

Multi-Lock Security Lock Bar

- Folds over cabinet drawers and locks with padlock.
- Easily attaches to tool boxes.
- Comes with sheet metal screws and instructions.



Chest/Cabinet Non-Slip Drawer Liner

- Non-slip, open weave drawer liner keeps tools in place.
- Polyester fabric coated with PVC.
- Washable, anti-fungus and mildew-proof.



Chest/Cabinet Foam Drawer Liner

- Helps protect tools from moisture and keeps them in place.
- Polyethylene foam $\frac{1}{8}$ inches thick.



Chest/Cabinet Foam Tool Organizer

- Notice missing tools at a glance.
- $\frac{3}{8}$ " thick foam can be cut with a hot pencil-tip soldering iron.



Ball-bearing Drawer Slides

- Three-member, full extension ball-bearing slides permit effortless, feather-light movement.
- Package includes one left and one right hand slide.



Cabinet Top Mat

- Protects against scuffs and abrasions.
- Reduces chest movement.
- Black vinyl pre-cut mat .075 in. thick.



Maple Work Surface

- 1½" thick butcher block maple top.
- Full-length laminations specially selected for grain and color match.
- Kitchen counter quality for years of fine use.
- Comes with care instructions.

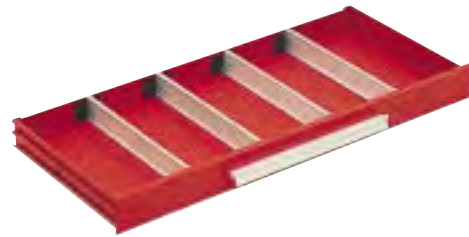

Drawer Dividers

- Keeps tools separated and organized.
- Fully adjustable. Spring clips hold in place. Made of zinc coated steel.

ABS Drawer Divider Inserts for 27", 29" and 34" Roller Cabinets

Organize, separate and arrange tools and small parts. Maximizes the use of drawer space, giving you quick access to contents. No more cluttered, messy drawers.

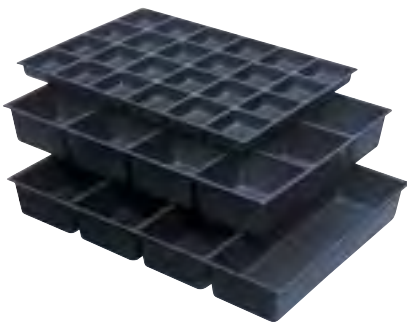

- Tough ABS Black Plastic.
- All compartments have rounded corners for quick, easy retrieval of small parts and easy cleaning.
- One-piece design for 27" and 29" cabinets—easy to use, drop-in, lift-out!



Sized to fit Kennedy 2" and 4" high drawers in both 27" and 29" wide roller cabinets, maintenance cart models 310X and 315X and chest models 2705X and 2905X.



Roller Cabinet Caster Sets

- Soft rubber tread, hard rubber core bonded to metal center.
- For cabinets 20, 27, 29 or 34 in. wide.



6 x 2" Roller Cabinet Caster Set

- 6 x 2" roller bearing casters made of black polypropylene tread molded to polypropylene core.
- Swivel casters have lock brake that locks both wheel and swivel.



Touch-up Paint

- For touching up nicks and scratches.
- Durable textured wrinkle or smooth finish.
- Twelve ounce aerosol can or 0.6 ounce liquid bottle.

48" Industrial Mobile Versa-Bench® with Ball-Bearing Drawer Slides



4804



4804,4806
Back View



4806



4810



Tow your Versa-Bench to the job. Power towing casters and bottom pan reinforcements bolt easily to base of bench. Steel wheels have molded-on soft rubber, shock absorbent tread; tapered roller bearings. Comes with two rigid, two swivel casters with poly cam brakes and a 27" towing tongue. Inside diameter of the towing ring is 2 1/2 inches; outside diameter is 4 1/8 inches.

VBT48—UPC No. 10133—For 48" Models
VBT60—UPC No. 10134—For 60" Models

Specifications

- All models have a 1/8" steel work surface.
- Frame and body constructed of 11 gauge steel.
- Four 8 x 2" roller bearing phenolic wheels.
- Comes standard with floor lock and tubular end handle.
- All models have pad-lockable doors. Model 4806 also includes lock and two keys in drawer unit.
- Load capacity of 3600 lbs. Add two casters and increase weight capacity to 5400 lbs.



4-DRAWER 4804

Comes with four drawers and doors that can be padlocked for extra security. Two open shelves on back allow fast and easy tool access.

Brown finish only.

No.	Brn. UPC		Red UPC		Drs.	Dimensions (Inches)			Net Wt. Lbs.	Ship Wt. Lbs.
	No.	No.	No.	No.		Width	Depth	Height		
4804	10127	—	—	—	4	48	26	35 1/2	345	375
Drawers:					2	23	16 1/2	2		
					2	23	16 1/2	4		
Top Front Compartment:						20 1/4	19	12 1/2		
Bottom Front Compartment:						48	19	11		
Back Open Shelves:						48	5 1/2	13		

6-DRAWER 4806

Six drawer unit comes with lock and two keys. Doors can be padlocked for extra security. Also has two open shelves on back.

Choice of brown or smooth red finish.

No.	Brn. UPC		Red UPC		Drs.	Dimensions (Inches)			Net Wt. Lbs.	Ship Wt. Lbs.
	No.	No.	No.	No.		Width	Depth	Height		
4806	10128	4806R	10152	—	6	48	26	35 1/2	395	425
Drawers:						3	23	16 1/2	2	
						2	23	16 1/2	4	
						1	23	16 1/2	5	
Top Front Compartment:						17 1/2	19	12 1/2		
Bottom Front Compartment:						17 1/2	19	11		
Back Open Shelves:						48	5 1/2	13		

10-DRAWER 4810

Comes with ten drawers and doors that can be padlocked for security.

Choice of brown or smooth red finish.

No.	Brn. UPC		Red UPC		Drs.	Dimensions (Inches)			Net Wt. Lbs.	Ship Wt. Lbs.
	No.	No.	No.	No.		Width	Depth	Height		
4810	10240	4810R	10241	—	10	48	26	35 1/2	500	530
Drawers:						2	30	23 1/2	1 1/4	
						3	30	23 1/2	4	
						3	12	23 1/2	1 1/4	
						1	12	23 1/2	10	
						1	43 1/4	23 1/2	5 1/2	



For the maintenance mechanic whose work comes to him. Replace bench casters with stationary, steel formed legs. Mount in corners using same holes as casters. Height 9 1/4 inches.

VBLEGS—Brn. UPC No. 00077
Red Smooth UPC No. 00084

Specifications

- All models have a 1/8" steel work surface.
- Frame and body constructed of 11 gauge steel.
- Four 8 x 2" roller bearing phenolic wheels.
- Comes standard with floor lock and tubular end handle.
- All models have pad-lockable doors. Six and twelve drawer models also include lock and two keys in drawer units.
- Load capacity of 3600 lbs. Add two casters and increase weight capacity to 5400 lbs.



60" Industrial Mobile Versa-Bench[®] with Ball-Bearing Drawer Slides

6-DRAWER 6006

Comes with six-drawer cabinet equipped with lock and two keys. Open compartment behind cabinet. Rear doors cover two-shelf storage space and can be padlocked for extra security.

Choice of brown or smooth red finish.

No.	Brn.		Red		Drs.	Dimensions (Inches)			Net Wt. Lbs.	Ship Wt. Lbs.
	UPC No.	No.	UPC No.	No.		Width	Depth	Height		
6006	10129	6006R	10296	6006R	6	60 3/8	32	35 3/8	450	475
Drawers:					3	23	16 1/2	2		
					2	23	16 1/2	4		
					1	23	16 1/2	5		
Top Front Compartment:						27 1/4	28 3/4	12 3/4		
Bottom Front Compartment:						27 1/4	28 3/4	11		
Back Open Compartment:						28 1/2	9 1/4	26		



6006



6006 and
6012S
Back View

12-DRAWER 6012S

Two six-drawer units come with keyed alike lock and two keys. Rear doors cover two-shelf storage space and can be padlocked for extra security. Also has rear compartment for storing extra-large tools.

Choice of brown or smooth red finish.

No.	Brn.		Red		Drs.	Dimensions (Inches)			Net Wt. Lbs.	Ship Wt. Lbs.
	UPC No.	No.	UPC No.	No.		Width	Depth	Height		
6012S	10130	60SR	10153	60SR	12	60 3/8	32	35 3/8	500	525
Drawers:					6	23	16 1/2	2		
					4	23	16 1/2	4		
					2	23	16 1/2	5		
Top Back Compartment:						27	10 3/8	10		
Bottom Back Compartment:						27	10 3/8	13 1/2		
Back Open Compartment:						29	9 3/8	26		



6012S

12-DRAWER 6012E

Comes with two six-drawer units with keyed alike lock and key sets. Side openings have shelves and doors that can be padlocked for extra security.

Choice of brown or smooth red finish.

No.	Brn.		Red		Drs.	Dimensions (Inches)			Net Wt. Lbs.	Ship Wt. Lbs.
	UPC No.	No.	UPC No.	No.		Width	Depth	Height		
6012E	10131	6012ER	10138	6012ER	12	60 3/8	32	35 3/8	510	535
Drawers:					6	23	16 1/2	2		
					4	23	16 1/2	4		
					2	23	16 1/2	5		
Top Compartment:						20	28 3/4	9 3/4		
Bottom Compartment:						20	28 3/4	13 1/2		



6012E



Protect your Versa-Bench work surface. Durable, 1 1/2"

thick maple top has full-length laminations specially selected for grain and color match. Comes with wood screws, template and easy-to-read installation instructions.

WT48—UPC No. 00140—47% W x 25% D x 1 1/2" H.

WT60—UPC No. 00141—60% W x 32 D x 1 1/2" H.



Standard Floor Lock. Fits all Versa-Bench models.



All models come with 8 x 2" roller bearing phenolic wheels. Weight capacity, 900 lbs. ea.

Versa-Benches[®]



WS5405
S5405X

All five-drawer units have two deep shelves to neatly organize your tools. Legs adjust to make your work stations level on the roughest floor. Assembly required. Gray wrinkle powder finish.

Quality butcher block maple work surface is 1/2" thick. Steel top made of heavy gauge steel. Gray wrinkle powder finish.

Top	5-Drawer		10-Drawer	
	Wood	Steel	Wood	Steel
Friction Slides	WW5405	WS5405	WW5410	WS5410
Ball-bearing Slides	W5405X	S5405X	W5410X	S5410X



WW5410
W5410X

Specifications

No.	UPC No.	Drs.	Dimensions (Inches)			Net Wt. Lbs.	Ship Wt. Lbs.
			Width	Depth	Height		
WW5405	10271	5	54	20	34½	132	152
W5405X	00630	Same dimensions as WW5405				137	157
WS5405	10273	5	54	20	34½	139	156
S5405X	00631	Same dimensions as WS5405				144	161
WW5410	10272	10	54	20	34½	177	212
W5410X	00632	Same dimensions as WW5410				187	222
WS5410	10274	10	54	20	34½	186	209
S5410X	00633	Same dimensions as WS5410				196	219

Ten drawer units have same specifications as five drawer units except: No shelves.

Drawer Dimensions

Model No.	Drawers	Length	Width	Height
WW5405/WS5405	5	17½	16½	4
W5405X/S5405X		17%	17½	
Shelves (2)				
WW5410/WS5410	10	17½	16½	4
W5410X/S5410X				



Work Station Security Door

26-INCH

DO26

Package includes security door, mounting hardware and locking clip. Can be mounted for left or right opening and locked with a padlock (not included).

Fits all 54" work stations and tool stand models TS261X and TS265X.

No.	UPC No.	Dimensions (Inches)			Net Wt. Lbs.	Ship Wt. Lbs.
		Width	Depth	Height		
DO26	10285	19%	%	20%	10	12

Square 1 Economy Toolholder System eliminates clutter and utilizes space above your work station!

See page 23 for details!

Work Station Components

Model No.	Base Unit	Net Wt.	Ship Wt.	Maple Top WT54	Net Wt.	Ship Wt.	Steel Top ST54	Net Wt.	Ship Wt.	Drawer Packages DR265	Net Wt.	Ship Wt.	Total No.Cartons
WW5405	W54	35	41	1	40	47				1	47	54	3
WS5405	W54	35	41				1	47	51	1	47	54	3
WW5410	W54	35	41	1	40	47				2	94	108	4
WS5410	W54	35	41				1	47	51	2	94	108	4
W5405X	W54	35	41	1	40	47				1	47	54	3
S5405X	W54	35	41				1	47	51	1	47	54	3
W5410X	W54	35	41	1	40	47				2	94	108	4
S5410X	W54	35	41				1	47	51	2	94	108	4

Chip Tray Work Station

1558

Made of heavy duty 11 gauge steel, this work station top is designed for use with drill presses, lathes and milling machines. 1/4" raised edges contain metal cuttings. Surface drain hole allows the use of grinding fluids. Holds machines up to 650 lbs. Smooth gray finish.

Five-drawer work station base comes with two shelves to organize bulky tools. Legs adjust to make your work station level on the roughest floor. Assembly required. Gray wrinkle powder finish.

No.	UPC	Dimensions (Inches)			Net Wt.	Ship Wt.
	No.	Width	Depth	Height	Lbs.	Lbs.
1558	01558	54	20	35 1/4	199	221
	Drawers:	17 1/2	16 1/2	4		



1558



Heavy Duty Tool Stands

1-DRAWER 5-DRAWER

BALL-BEARING SLIDES

TS261X TS265X

Legs adjust to make your work station level on uneven floors. One-inch thick press board work surface. Designed to accommodate additional drawers. Assembly required.

Gray wrinkle powder finish.

No.	UPC	Drs.	Dimensions (Inches)			Net Wt.	Ship Wt.
	No.		Width	Depth	Height	Lbs.	Lbs.
TS261X	00642	1	26	20	33 1/2	62	71
Drawers:			17 1/2	16 1/2	4		
	Shelf		17 1/2	17 1/2			
TS265X	00643	5	26	20	33 1/2	95	108
Drawers:		5	17 1/2	16 1/2	4		



TS261X



TS265X

Add-on Drawer Package

FRICITION

BALL-BEARING

SLIDES

SLIDES

DR265 DR264X DR265X

Easy-to-install 5-drawer package includes side panels, drawer slides and mounting hardware. Four drawer package comes with drawer slides.

Fit all 54" work stations and Tool Stands. Gray wrinkle powder finish.

No.	UPC	Drs.	Dimensions (Inches)			Net Wt.	Ship Wt.
	No.		Width	Depth	Height	Lbs.	Lbs.
DR264X	00646		Same dimensions as DR264			33	36.5
DR265	10263	5	17 1/2	17 1/2	20 1/2	47	54
DR265X	00640		Same dimensions as DR265			52	59



DR265
DR265X

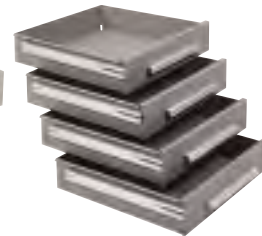

DR264X

Wall Storage Cabinet

WC28

Wall cabinet has two adjustable shelves and two doors with perforated inside panels that accommodate standard pegboard hooks. Doors are held closed by magnets and have outside staples for securing with a padlock (not included). Mounting holes are 16 inches apart for easy fastening to wall studs (hardware included).

Available in gray wrinkle powder finish.

No.	Gray UPC	Dimensions (Inches)			Net Wt.	Ship Wt.
	No.	Width	Depth	Height	Lbs.	Lbs.
WC28	10287	28 1/2	9 1/2	30	40	46
Shelves (2)		28	6 1/4			



WC28

Heavy Duty Work Stations

Professional Tool Storage

Versatile • Convenient • Secure

- Reinforced steel panels with square hole perforations
- Heavy steel lock-on hooks, clips, accessories
- Locate tools at the worksite—either open access or in locked cabinets

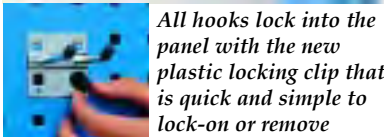

All hooks lock into the panel with the new plastic locking clip that is quick and simple to lock-on or remove

Toolboard Wall Panels

Flanged panels are reinforced for strength to hold the heaviest loads. Panels can be attached to a variety of surfaces, racks, etc. (Fasteners not included). Each panel is 18" wide x 36" high. Order hooks and toolholders in sets or individually. Toolboard panels come in tan, gray, green and blue, durable chip-resistant, baked on finish.



(Tools not included).

Four-Panel Kit with 60-piece Toolholder Set

The standard set consists of four 18 x 36" panels (covers 18 sq. ft. of wall space). 60-piece toolholder set included.

- UPC No. 50004Tan Finish
- UPC No. 50014Blue Finish
- UPC No. 50024Gray Finish
- UPC No. 50034Green Finish

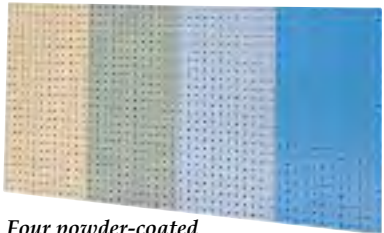

Four powder-coated finishes available

Standard Two-Panel Set

The standard set consists of two 18 x 36" panels (covers 9 sq. ft. of wall space). Toolholders are not included and must be ordered separately.

- UPC No. 50002Tan Finish
- UPC No. 50012Blue Finish
- UPC No. 50022Gray Finish
- UPC No. 50032Green Finish

Toolholder Sets

Hooks, clips, and toolholder accessories are industrial grade, zinc-plated heavy steel and lock on to panels to prevent the accidental removal of tools.



Each 30-piece toolholder set consists of:

- 17 assorted single hooks;
- 4 assorted double hooks;
- 2 assorted plier hooks;
- 4 assorted spring clips;
- 1 each ring hook, screwdriver unit and wrench rack.

Model 99852

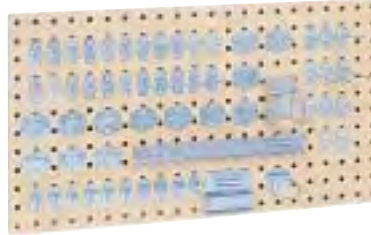

Each 60-piece toolholder set consists of:

- 33 assorted single hooks;
- 9 assorted double hooks;
- 4 assorted plier hooks;
- 10 assorted spring clips;
- 1 each ring hook, screwdriver unit, wrench rack and allen key unit.

Model 99853

Louvered Panel Sets

The standard set consists of two metal 18" H x 36" L louvered panels. The finish is durable baked powder coat. 160 lbs. weight capacity per panel. Accepts plastic bins.

Panels can be attached to a wall, to the back of a work bench or attached to a model 50100 Open Tool Trolley Base for mobile organized bin storage.

- Model 50061: two panel set, tan
- Model 50062: two panel set, blue
- Model 50063: two panel set, gray
- Model 50064: two panel set, green

Net weight 17.5 lbs.
Ship weight 20 lbs.



50100 base with 50061 panel set and plastic bins (not included).



Work station with 50002 panel set, two 50050 braces and hooks (sold separately). Tools not included.

Panel Brace Supports

Braces attach to work station and louvered or toolboard panels. Two brace supports are required per two panel set.

Model 50050 includes one brace and mounting hardware.



Two 50050 brace supports with panel set 50061.

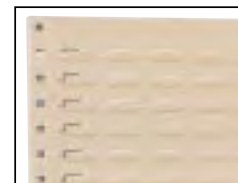

Close-up view of louvered panel.



50050

Bright, zinc-plated heavy steel toolholders won't come off when tools are removed. Positive-lock system secures toolholders in place anywhere on panels.



Single Hook—Vertical End

UPC No.	Pkg. Qty.	Length	Dia.	Wt. Cap.
99820	10	1	¼	40 lbs.
99821	10	2	¼	40 lbs.
99822	10	3	¼	40 lbs.



Single Hook—Angled End

UPC No.	Pkg. Qty.	Length	Dia.	Wt. Cap.
99823	10	2½	¼	40 lbs.
99824	10	4	¼	40 lbs.
99825	10	6	¼	20 lbs.



Double Hook—Vertical End

UPC No.	Pkg. Qty.	Length	Width	Wt. Cap.
99827	10	1	1½	40 lbs.
99828	10	2	1½	40 lbs.



Double Hook—Angled End

UPC No.	Pkg. Qty.	Length	Width	Wt. Cap.
99829	10	2	1	40 lbs.
99830	10	4	1	40 lbs.

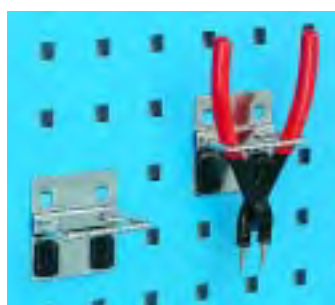

Plier Hook

UPC No.	Pkg. Qty.	Length	Width	Wt. Cap.
99831	10	1½	¾	40 lbs.
99832	10	2½	¾	40 lbs.



Ring Hook

UPC No.	Pkg. Qty.	Dia.	Wt. Cap.
99839	2	2½	40 lbs.



Single Spring Clips

UPC No.	Pkg. Qty.	Dia.	Wt. Cap.
99833	10	½	3 lbs.
99835	10	¾	3 lbs.
99836	10	1	3 lbs.

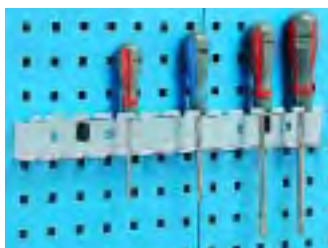

Screwdriver Unit

Stores up to 12 screwdrivers, chisels, files, etc. Gray finish.

UPC No.	Pkg. Qty.	Wt. Cap.
99840	1	40 lbs.



Wrench Rack

Stores up to 8 wrenches. Gray finish.

UPC No.	Pkg. Qty.	Wt. Cap.
99841	1	40 lbs.



Allen Key Unit

Stores up to 9-piece metric or imperial key set. Gray finish.

UPC No.	Pkg. Qty.	Wt. Cap.
99842	1	3 lbs.



Parts Shelf
Gray finish.

UPC No.	Pkg. Qty.	Length	Depth	Wt. Cap.
99846	1	17¾	6¾	40 lbs.



Plastic Bin Storage Strip
Gray finish.

UPC No.	Pkg. Qty.	Length	Wt. Cap.
99847	1	4	40 lbs.
99848	1	17¾	40 lbs.



Cable Loop Hook Set

UPC No.	Pkg. Qty.	Length	Wt. Cap.
99876	5	6	20 lbs.

Toolboard Lock-on Steel Tool Holders



50260

Any of the toolholders on page 31 may be used with these cabinets.



50301

Tools not included.
No. 50308 light optional.

Drawer Divider Kits for Mini Workshop Cabinet
Model No. 69050—9 compartment metal divider kit.
Model No. 69051—20 compartment metal divider kit.



10350



50102

50100

Wall Mounted Cabinets

Rugged steel cabinets with three-point locking doors combine easy access and convenient tool storage with security. Square hole perforated cabinet back and inner door panels give large tool hanging capacity. Tan finish. Two keys included. Overall size: 44 $\frac{1}{2}$ " W x 11 $\frac{1}{2}$ " D x 39 $\frac{1}{2}$ " H.

Model 50260 (shown)

Comes with 24" x 18" swing-out inner panels for additional storage of flat tools. Sixty-piece toolholder set no. 99853 is included. Net wt. 100 lbs. Ship weight 120 lbs.

Model 50230

Comes without the swing-out inner panels. Thirty-piece tool holder set no. 99852 is included. Net wt. 83 lbs. Ship weight 96 lbs.

Mini Workshop Cabinet

- Heavy gauge welded steel.
- Three-point locking doors with two keys.
- Full-length toolboard panels on inner doors.
- Two 18 x 36" toolboard panels install on cabinet back.
- One adjustable full-width shelf: 35 $\frac{1}{2}$ x 19 $\frac{1}{2}$ " with 220 lb. capacity.
- Three full-width drawers: 34 $\frac{1}{2}$ x 17 $\frac{1}{2}$ x 4" high with 165 lb. capacity glide easily on ball-bearing slides. (Optional Divider Kits available.)
- Safety latch on drawers.
- Easy pull drawer handles with label holders.
- 1 $\frac{1}{2}$ " thick butcher block maple work surface: 36 x 20".
- Baked-on tan finish.
- Sixty-piece toolholder set no. 99853 is included. Any of the tool holders shown on page 31 may also be used.
- Overall size: 39 $\frac{1}{4}$ W x 23 $\frac{3}{4}$ D x 76" H.
- Net weight 463 lbs. Ship weight 478 lbs.

Model 50301

All Welded Storage Cabinet

- Made of heavy 16 gauge steel.
- Three-point locking system ensures maximum security.
- Three shelves 36" x 21" x 1 $\frac{3}{4}$ " hold up to 400 lbs. each.
- Steel toolboard panels inside doors include 20-piece hook set.
- Overall dimensions: 39 $\frac{1}{4}$ W x 23 $\frac{3}{4}$ D x 76" H.
- Tan finish.
- Net Wt. 405 lbs. Ship Wt. 430 lbs.

Model 10350

The products shown on this page are available in standard toolboard colors—tan, gray, green and blue. Delivery time is approximately six weeks.

Open Tool Trolley

All-steel trolley is double sided with inclined panels to ensure tools are safely stored when the trolley is moving. The base has raised edges for easy storage of tool boxes and larger items. Mounted end handle and four 5 x 1 $\frac{1}{4}$ " casters. Includes four 18" x 36" toolboard panels and 60-piece toolholder set no. 99853 shown on page 30. All toolholders shown on page 31 are also compatible. Overall size: 36 $\frac{1}{4}$ W x 23 $\frac{3}{4}$ D x 51 $\frac{1}{8}$ " H (includes casters). Assembly required. Tan finish.

Model 50102. Net weight 86 lbs. Ship weight 90 lbs.

Model 50104 includes base and four toolboard panels. Toolboard hooks and hook sets shown on pages 30 and 31 can be added to customized your tool storage requirements. Net weight 78 lbs. Ship weight 88 lbs.

Model 50100 base only. Buy the base and add louvered panel sets (two sets) or one set of louvered panels and one set of toolboard panels (see page 30) for a combination trolley. Toolboard hooks and hook sets shown on pages 30 and 31 can also be added. Net weight 43 lbs. Ship weight 48 lbs.

Stainless Steel Roller Cabinets

- 304 Stainless body and drawers, #4 Brushed finish
- Ball bearing drawer slides, 125 lbs. drawer capacity
- 5 x 1½" non-marking polyurethane casters
- Stainless steel drawer pulls, handle and hardware
- Tubular key high security lock and key set

Standard Stainless Steel Cabinets Class 100—Cleanroom Certified

UPC No.	Drs.	Dimensions (Inches)			Net Wt. Lbs.	Ship Wt. Lbs.
		Width	Depth	Height		
28085	5	29	20	35	125.5	141
Drawers:	1	25	18½	2		
	3	25	18½	4		
	1	25	18½	10		
28087	7	29	20	35	144.5	156
Drawers:	3	25	18½	2		
	3	25	18½	4		
	1	25	18½	6		



Model 28085

Pre-configured stainless steel cabinets shown.

Or, custom design your own. Ask us for details.

Stainless Steel Cabinets with Pushbutton Combination Lock Class 10—Cleanroom Certified

UPC No.	Drs.	Dimensions (Inches)			Net Wt. Lbs.	Ship Wt. Lbs.
		Width	Depth	Height		
28197	7	29	20	35	144.5	156
Drawers:	3	25	18½	2		
	3	25	18½	4		
	1	25	18½	6		



Model 28197

NOTE: Width is left to right, depth is front to back, height is top to bottom. Dimensions given do not include handles, but do include casters.

Packaging—

All units are shipped in a non-static generating bag to prevent contamination.

Cabinet Plastic Work Surface

- Seamless, ABS white plastic cover fits snugly over roller cabinet top.
- ¾" raised lip helps prevent roll offs.
- For 29" cabinetsModel No. 29000
- For 34" cabinetsModel No. 24000

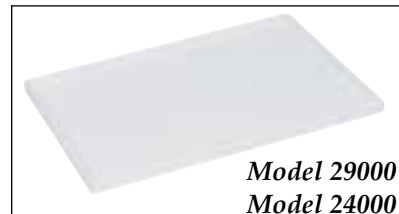

Model 29000
Model 24000

Standard Stainless Steel Chest Features

- 304 Stainless body and drawers, #4 Brushed finish
- Tubular key high security lock and key set
- Model 28264 has stainless steel drawer pulls, handle and hardware. Ball-bearing drawer slides. Fits on top of cleanroom roller cabinet models 28085, 28087, 28195 and 28197.
- Model 28220 comes with aluminum drawer pulls, and vinyl-coated, steel core top handle. Stainless steel friction drawer slides.

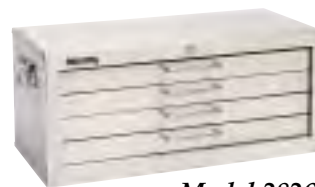

Model 28264



Model 28220

UPC No.	Drs.	Dimensions (Inches)			Net Wt. Lbs.	Ship Wt. Lbs.
		Width	Depth	Height		
28264	4	26¾	12½	11½	40	45
Drawers:	4	23	10¾	2		
28220	2	20¾	8¾	9¾	16	19
Drawers:	2	18¾	7¾	2		



Your Quality, Cost-Efficient Alternative in Modular Storage Compare the Kennedy Features & Benefits—

Volume Capacity

Kennedy modular cabinets offer more volume capacity than our competition. For example, our 30" x 30" x 39.5" cabinet with 18 each 2" drawers gives you 84.5 sq.ft. of drawer space in only 6.25 sq.ft. of floor space. The side-mounted rails increase the storage volume by providing up to 15% more usable drawer height than conventional carriage type slide systems. Plus, the larger size, 26" x 26", of our most popular drawers gives up to 17% more storage area than comparable drawers of the competition. The combination of rail design and drawer size can give over 30% more total storage volume than competing brands, depending on the drawer arrangement used.

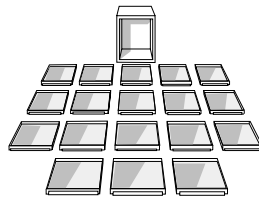

Weight Capacity

Kennedy offers weight capacity of up to 550 lbs. per drawer, highest in the industry. A 220 lbs. per drawer system is also available. These systems, (FX) and (NX), are interchangeable, offering economy and the ability to mix and match different systems within the same cabinet depending on your needs. Ball bearing rail construction ensures smooth, effortless operation, even when a drawer is fully loaded.



Drawer Construction

The drawer pans of all cabinets are formed from heavy gauge steel and have reinforced edges for strength, rigidity and safety. The bottom of the pan has perforations for partitioning flexibility. Divider slots on all four side walls are .79" (20mm) apart.



FX—Full Extension Drawers

Kennedy FX drawers have a load capacity of 550 lbs. (250 kgs.) with 100% extension capability. Telescopic, side-mounted rails have a total of eight precision ball bearings per drawer (4 each side) to handle this enormous load capacity.

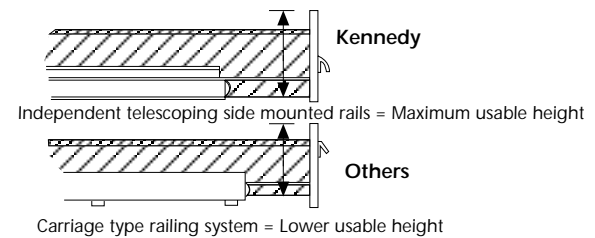

NX—Normal Extension Drawers

Kennedy NX drawers have a load capacity of 220 lbs. (100 kgs.) with 87% extension capability. Side-mounted rails have four precision ball bearings per drawer (2 each side). NX drawers can be replaced with FX drawers whenever load capacity requirements change.

Changeable Drawer Fronts

The Kennedy drawer front bolts solidly to the drawer pan. This permits the simple and inexpensive changing of drawer sizes at a later date if your needs change. For example, two 4" drawers can become a single 8" drawer by just purchasing an 8" drawer front and bolting it on. FLEXIBILITY is the key word with the Kennedy system.



Drawer Interlock Safety System

All Kennedy cabinets have an "only one-drawer-open-at-a-time" safety system that prevents tipping of the cabinet. There are also four bottom corner holes for anchoring the cabinet to the floor. **Bolting cabinets to the floor is highly recommended to prevent personal injury.**

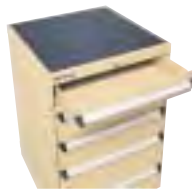

Corner Strengthening Bracket

All of our cabinets have a super-tough corner strengthening bracket solidly welded into place to ensure the maximum rigidity and strength that you would expect from a Kennedy cabinet.



Security Locking System

All Kennedy cabinets have a high security locking system. Keyed alike and master key combinations are available upon request.

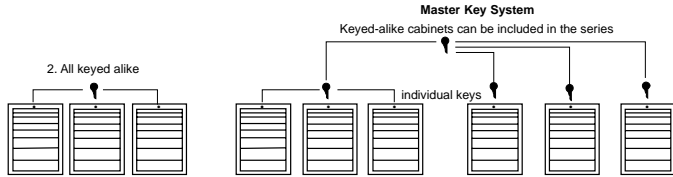

Drawer Dividers and Accessories

Choose from a large selection of standard divider sets or custom design your drawer arrangement from components. A wide variety of boxes, trays and tool holders are available for most efficient storage of tools and parts.



Custom Designed Cabinets

Although we offer many standard pre-engineered drawer arrangements and drawer dividers sets, the Kennedy system allows you the total flexibility to design units to your exact specifications. If you need assistance, just call your Kennedy representative. He can help with a wide range of storage solutions.

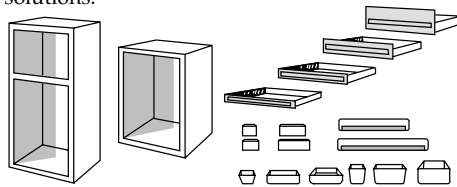

Cabinet Top Mats

Every Kennedy cabinet top is covered with a ribbed black vinyl mat that protects against scuffs and abrasions, and provides a durable work or storage surface.



Full-length Label Holders

Drawer handles come with paper and clear plastic label strips for fast, easy identification of drawer contents. This means faster retrieval and quick inventory control.



Color Selection

There are four standard colors—tan, green, gray and blue. Call Kennedy or your distributor to see actual color chips. Drawer fronts and housings may be the same or different colors. Special colors are available upon request.



NC/CNC TOOL STORAGE SYSTEMS

Increase Spindle Time

Increase Productivity

Operators tell us they spend up to 25% of their day retrieving and assembling tooling.

Reduce tooling retrieval and assembly time. Losses of \$300 per hour or more are common. Reducing a shop's total down time by just one hour per day can result in an average \$75,000 per year in increased productivity.



Increase Tool Life

Susta/Kennedy components keep tooling and accessories secure and protected from damage and loss so often resulting from loose and random storage.

Control Inventory

Custom arrangement of trays, drawers and pull out frames allows logical, organized storage of compatible tooling and supplies.



Tooling and supply components are separated and visible. It is easy to quickly see what is in stock.

Eliminate unnecessary rush orders for tooling that actually is in house, somewhere, out of sight.

Save Floor Space

Increase the amount of expensive floor space available for production machinery by reducing storage space with high density Susta/Kennedy storage racks and work stations.



One Susta/Kennedy Ministore® saves space by combining high density storage and work station in as little as 17 square feet.

Susta/Kennedy products begin on page 50

STANDARD WIDTH 30" x 30" MODULAR CABINETS



The standard width cabinets on these pages are 30" wide x 30" deep and are our most popular size.

You may order cabinet housings filled with your own custom-designed drawer arrangements or choose from the pre-engineered combinations shown that have proven to be the most widely used over the years.

All models are shipped assembled and come with lock and two keys. Drawer divider sets are shown on page 37. Additional accessories are on pages 46, 47 and 48.

Standard Width Housings

Cabinet housings can be filled with full extension (FX), 550 lbs., or normal extension (NX), 220 lbs., drawers. They can be mixed within these cabinets for cost efficient combinations.

Select any combination of drawer front heights that equal the usable height of the cabinet. NX drawers can be converted to FX drawers at a later date if storage requirements change. All 2" drawers are NX type drawers.

Drawers for all 30" x 30" cabinets are listed on page 37. Fork lift bases and pallet truck bases are available. See page 48 for information.

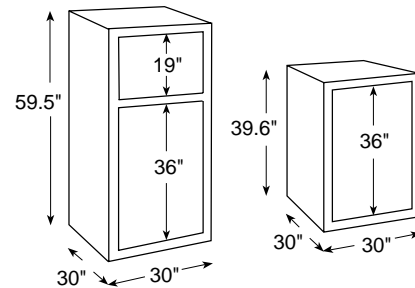

Housing No. 63600
Usable Height 55"

Housing No. 63400
Usable Height 36"

Standard Width Pre-engineered Combinations



63405 NX
63406 FX
4-3", 1-4", 2-6",
1-8" Drs.
Total Sq. Ft. 37.75
Total Cu. Ft. 12.26

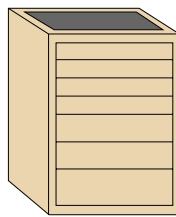

63407 NX
63408 FX
4-4", 2-6", 1-8" Drs.
Total Sq. Ft. 32.86
Total Cu. Ft. 12.46

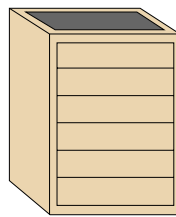

63409 NX
63410 FX
6-6" Drawers
Total Sq. Ft. 28.16
Total Cu. Ft. 12.66

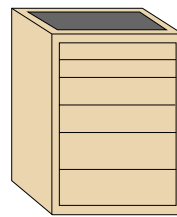

63411 NX
63412 FX
2-4", 2-6", 2-8" Drs.
Total Sq. Ft. 28.16
Total Cu. Ft. 12.66

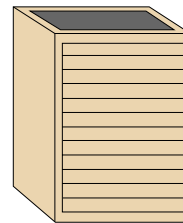

63416 NX
63417 FX
12-3" Drawers
Total Sq. Ft. 56.33
Total Cu. Ft. 11.46

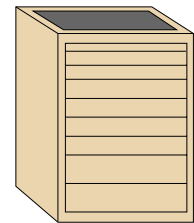

63418 NX
63419 FX
1-2", 2-3", 4-4", 2-6" Drs.
Total Sq. Ft. 42.25
Total Cu. Ft. 12.06

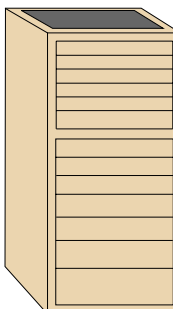

63605 NX
63606 FX
5-3", 4-4", 2-5",
1-6", 1-8" Drs.
Total Sq. Ft. 61.02
Total Cu. Ft. 18.50

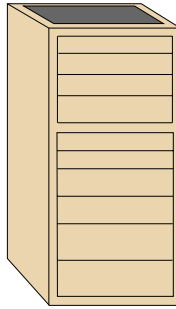

63609 NX
63610 FX
2-4", 1-5", 1-6", 2-4",
2-6", 2-8" Drawers
Total Sq. Ft. 46.94
Total Cu. Ft. 19.18

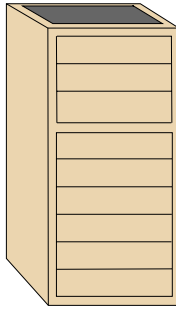

63611 NX
63612 FX
2-6", 1-7", 6-6" Drs.
Total Sq. Ft. 42.25
Total Cu. Ft. 12.38

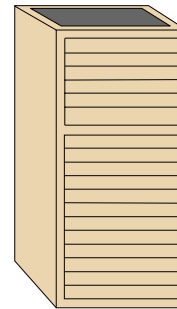

63616 NX
63617 FX
5-3", 1-4", 12-3" Drs.
Total Sq. Ft. 84.49
Total Cu. Ft. 17.58

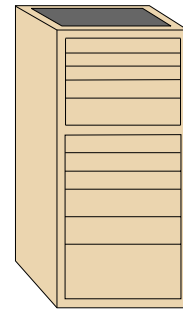

63618 NX
63619 FX
3-3", 1-4", 1-6",
3-4", 2-6", 1-12" Drs.
Total Sq. Ft. 51.63
Total Cu. Ft. 18.98

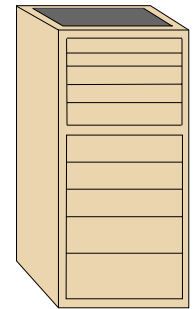

63620 NX
63621 FX
2-3", 2-4", 1-5",
3-6", 1-8", 1-10" Drs.
Total Sq. Ft. 46.94
Total Cu. Ft. 19.18

Custom Designed Cabinets

To order custom designed 30" x 30" cabinets, use the housings shown above (#63400, 39.6"H; #63600, 59.5"H) and combine with the drawers for 30" x 30" cabinets listed on page 37. Remember, the combination of drawer front heights must add up to the usable height of the housing.

30" x 30" MACHINE CABINETS AND WORK STATIONS



30" x 30" Machine Cabinet

This Kennedy storage cabinet holds normal extension (NX) or full extension (FX) drawers and can be used right at the machine site or as a base cabinet for work stations.

Model 63303 overall dimensions are 30" x 30" x 31.7"H. Usable height is 28". For other drawer arrangements, order housing no. 63300 and select from drawers listed below. Inside drawer dimensions are 26" x 26". Standard drawer arrangement is (1) 4" FX drawer, (2) 6" FX drawers and (1) 12" FX drawer.

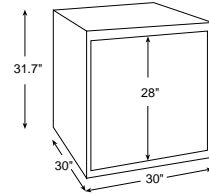

Housing No. 63300
Usable Height 28"



76209 Socket Partition

Each drawer in housing no. 62000 holds three partitions; 63000 holds four partitions; 64000 holds six partitions.



Each partition will hold:
(6) Susta 70053 50 Taper Sockets;
(8) Susta 70051 40 Taper Sockets;
(8) Susta 70059 30 Taper Sockets.



NC/CNC
Work Station

Standard Width Drawers for all 30" x 30" Cabinets

Drawer pans have perforations for easy installation of dividers and accessories. Drawer fronts bolt on to allow changing drawer heights easily as storage needs change. Inside dimensions of drawers are 26" x 26" giving 4.69 sq. ft. of storage area.



NX drawers have 87% rail extension; 220 lbs. capacity.

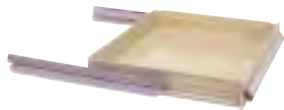

FX drawers have 100% rail extension; 550 lbs. capacity.

Model #	Front Height	Usable Height		Sidewall Height		Load Capacity				
		Inch	MM	Inch	MM	Cubic Ft.	Lbs.	Kgs.	Extension	
63002	2"	1.46	37	1.38	35	.57	220	100	87%	
63003	3"	2.44	62	2.17	55	.95	220	100	87%	
63004	4"	3.43	87	3.35	85	1.34	220	100	87%	
63005	5"	4.41	112	3.35	85	1.72	220	100	87%	
63006	6"	5.39	137	3.35	85	2.11	220	100	87%	
63008	8"	7.36	187	3.35	85	2.88	220	100	87%	
FX Model #										
63103	3"	2.44	62	2.17	55	.95	550	250	100%	
63104	4"	3.43	87	3.35	85	1.34	550	250	100%	
63105	5"	4.41	112	3.35	85	1.72	550	250	100%	
63106	6"	5.39	137	3.35	85	2.11	550	250	100%	
63107	7"	6.38	162	3.35	85	2.49	550	250	100%	
63108	8"	7.36	187	3.35	85	2.88	550	250	100%	
63109	9"	8.35	212	3.35	85	3.26	550	250	100%	
63110	10"	9.33	237	3.35	85	3.65	550	250	100%	
63112	12"	11.30	287	3.35	85	4.42	550	250	100%	
63114	14"	13.27	337	3.35	85	5.18	550	250	100%	
63116	16"	15.24	387	3.35	85	5.96	550	250	100%	

Drawer Divider Sets for 30" x 30" Cabinets

Choose any divider or box set below that meets your needs. To order, use the four digit number and add the number 2, 3 or 4 as a suffix. To order a divider set 9310 for a 2" drawer, order 93102, 93103 for a 3" drawer and 93104 for 4"-16" drawers. Taller subdividers and partitions are available on request. See pages 46 and 47 for drawer divider components and accessories.

9310 2 Comp. 13" x 26"	9312 6 Comp. 13" x 8.5"	9313 8 Comp. 13" x 6.25"	9321 6 Comp. 8.5" x 13"	9322 9 Comp. 8.5" x 8.5"	9323 12 Comp. 8.5" x 6.25"	9324 15 Comp. 8.5" x 4.75"	9325 18 Comp. 8.5" x 3/75"
9333 16 Comp. 6" x 6.25"	9334 20 Comp. 6" x 4.75"	9335 24 Comp. 6" x 3.75"	9337 32 Comp. 6" x 3"	9342 15 Comp. 4.5" x 8.5"	9355 36 Comp. 3.75" x 3.75"	9364 35 Comp. 3" x 4.75"	9377 64 Comp. 3" x 3"

30 x 30" Modular Cabinets

44" x 30" EXTRA WIDE MODULAR CABINETS



Extra wide cabinets are the most cost and space efficient modular cabinets for centralized large tool and parts storage.

Choose from the pre-engineered combinations shown below that have proven to be the most widely used over the years. Or, you may order cabinet housings filled with your own custom designed drawer arrangements.

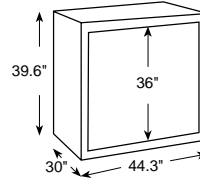

Housing No. 64400
Usable Height 36"

Drawers and drawer divider sets are listed below. All models are shipped assembled and come with lock and two keys. Additional accessories are on pages 46, 47 and 48. Fork lift base and pallet truck base also available on page 48.

Extra Wide Housings

Extra wide housings require full extension (FX), 550 lbs. drawers. Select any combination of drawer front heights that equal the usable height of the cabinet.

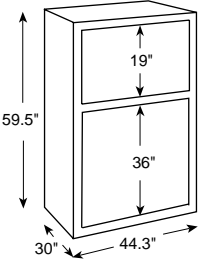

Housing No. 64600
Usable Height 55"

Extra Wide Pre-engineered Combinations

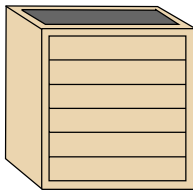

64404
6-6" Drawers
Total Sq. Ft. 43.50
Total Cu. Ft. 19.17

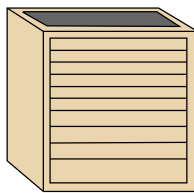

64408
6-3", 3-4", 1-6" Dr.
Total Sq. Ft. 72.50
Total Cu. Ft. 17.59

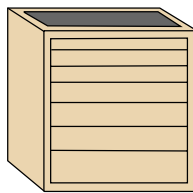

64410
1-3", 2-4", 1-5", 2-6",
1-8" Drawer
Total Sq. Ft. 50.75
Total Cu. Ft. 18.73

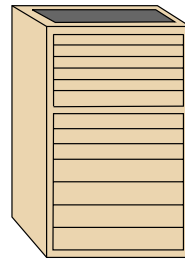

64606
5-3", 4-4", 4-6" Drs.
Total Sq. Ft. 94.25
Total Cu. Ft. 27.75

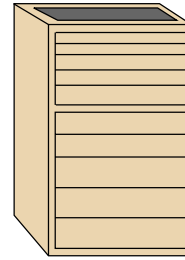

64608
2-3", 2-4", 1-5", 2-6"
3-8" Drs.
Total Sq. Ft. 72.50
Total Cu. Ft. 28.88

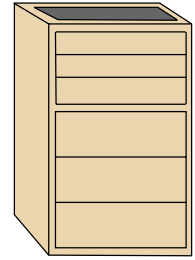

64610
2-6", 1-7", 3-12" Drs.
Total Sq. Ft. 43.50
Total Cu. Ft. 43.50

Extra Wide Drawers for all 44" x 30" Cabinets

Heavy-gauge, welded steel FX drawers are mounted on eight ball bearings for smooth operation under heavy loads.

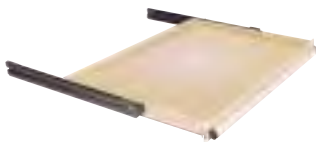

Inside dimensions are 40.16" W x 26" D giving 7.25 sq. ft. of storage space.

FX Model #	Front Height	Usable Height		Sidewall Height		Load Capacity			
		Inch	MM	Inch	MM	Cubic Ft.	Lbs.	Kgs.	Extension
64103	3"	2.32	59	2.00	50	1.40	550	250	100%
64104	4"	3.31	84	3.35	85	1.99	550	250	100%
64105	5"	4.29	109	3.35	85	2.59	550	250	100%
64106	6"	5.28	134	3.35	85	3.18	550	250	100%
64107	7"	6.38	162	3.35	85	3.85	550	250	100%
64108	8"	7.24	184	3.35	85	4.37	550	250	100%
64109	9"	8.35	212	3.35	85	5.04	550	250	100%
64110	10"	9.21	234	3.35	85	5.56	550	250	100%
64112	12"	11.18	284	3.35	85	6.75	550	250	100%
64114	14"	13.15	334	3.35	85	7.95	550	250	100%
64116	16"	15.12	384	3.35	85	9.12	550	250	100%

Custom Designed Cabinets

To order custom designed 44" x 30" cabinets, use the housings shown above (#64400, 39.6"H; #64600, 59.5"H) and combine with the drawers listed above. Remember, the combination of drawer front heights must add up to the usable height of the housing (19" & 36"). (The smallest drawer front height available for extra wide cabinets is 3").

Drawer Divider Sets for Extra Wide Cabinets

Choose any divider set below that meets your needs. To order, use the four digit number and add the 3 or 4 as a suffix. To order a divider set 9532 for a 3" drawer, order 95323 and 95324 for 4"-16" drawer. Taller subdividers and partitions are available on request. See pages 46 and 47 for drawer divider components and accessories.

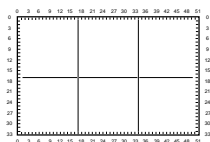

9521
6 Compartments
13" x 13"

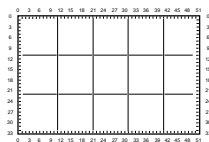

9542
15 Compartments
7.75" x 8.5"

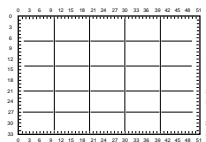

9544
25 Compartments
7.75" x 4.75"

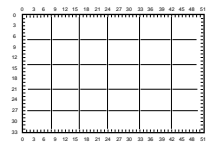

9554
30 Compartments
6.25" x 4.75"

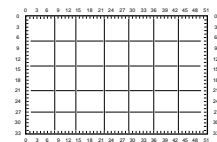

9564
35 Compartments
5.5" x 4.75"

30" x 24" MODULAR CABINETS

Standard width, shallow depth cabinets are 30" wide x 24" deep. They offer you high density storage when replacing shelving or where aisles are narrow. You may order cabinet housings filled with your own custom designed drawer arrangement or choose from the popular pre-engineered combinations shown below. All models are shipped assembled and come with lock and two keys. Drawer divider sets are shown below. Additional accessories are shown on pages 46, 47 and 48.

30" x 24" Pre-engineered Combinations

All drawers in these units are full extension (FX), 550 lb. capacity.



62407
2-3", 2-4", 1-6" & 2-8" Dr.
Total Sq. Ft. 25.90
Total Cu. Ft. 9.78



62509
2-3", 3-4", 2-6" & 2-8" Dr.
Total Sq. Ft. 33.31
Total Cu. Ft. 12.49



62610
1-3", 4-4", 2-6" & 3-8" Dr.
Total Sq. Ft. 37.01
Total Cu. Ft. 15.05

30" x 24" Housings

Cabinet housings can be filled with full extension (FX) or normal extension (NX) drawers. Both types of drawers can be mixed within these cabinets for cost efficient combinations. Select any combination of drawer front heights that equal the usable height of the cabinet. NX drawers can be converted to FX drawers at a later date if storage requirements change. All 2" drawers are NX type. Drawers for all 30" x 24" cabinets are listed below.

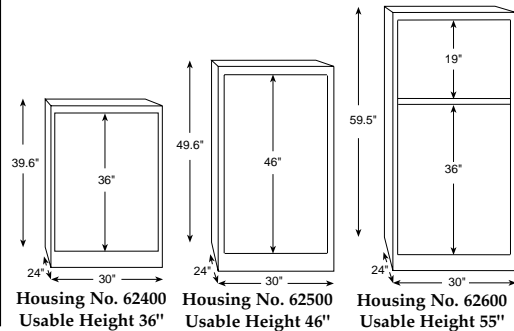

Standard Width/Shallow Depth Drawers for all 30" x 24" Cabinets

Drawer pans have perforations for easy installation of dividers and accessories. Drawer fronts bolt on to allow changing drawer heights easily as storage needs change. Inside dimensions of drawers are 26" x 20.5" giving 3.7 sq. ft. of storage area.



NX drawers have 87% rail extension; 220 lbs. capacity.



FX drawers have 100% rail extension; 550 lbs. capacity.

	NX Model #	Front Height	Usable Height	Sidewall Height		Cubic Ft.	Load Capacity		Extension	
		Inch	Inch	Inch	MM		Lbs.	Kgs.		
	52002	2"	1.46	37	1.38	35	.44	220	100	87%
	52003	3"	2.44	62	2.17	55	.75	220	100	87%
	52004	4"	3.43	87	3.35	85	1.05	220	100	87%
	52005	5"	4.41	112	3.35	85	1.35	220	100	87%
	52006	6"	5.39	137	3.35	85	1.66	220	100	87%
	52007	7"	6.38	162	3.35	85	1.96	220	100	87%
	52008	8"	7.36	187	3.35	85	2.26	220	100	87%
	52009	9"	8.35	212	3.35	85	2.57	220	100	87%
	52010	10"	9.33	237	3.35	85	2.87	220	100	87%
	52012	12"	11.30	287	3.35	85	3.47	220	100	87%
	FX Model #	Front Height	Usable Height	Sidewall Height		Cubic Ft.	Load Capacity		Extension	
		Inch	Inch	Inch	MM		Lbs.	Kgs.		
	52103	3"	2.44	62	2.17	55	.75	550	250	100%
	52104	4"	3.43	87	3.35	85	1.05	550	250	100%
	52105	5"	4.41	112	3.35	85	1.35	550	250	100%
	52106	6"	5.39	137	3.35	85	1.66	550	250	100%
	52107	7"	6.38	162	3.35	85	1.96	550	250	100%
	52108	8"	7.36	187	3.35	85	2.26	550	250	100%
	52109	9"	8.35	212	3.35	85	2.57	550	250	100%
	52110	10"	9.33	237	3.35	85	2.87	550	250	100%
	52112	12"	11.30	287	3.35	85	3.47	550	250	100%
	52114	14"	13.27	337	3.35	85	4.08	550	250	100%
	52116	16"	15.24	387	3.35	85	4.69	550	250	100%

Drawer Divider Sets for 30" x 24" Cabinets

Choose any divider set below that meets your needs. To order, use the four digit number and add the number 2, 3 or 4 as a suffix. To order a divider set 9211 for a 2" drawer, order number 92112, 92113 for 3" drawer and 92114 for 4"-16" drawer. Taller subdividers and partitions are available on request.

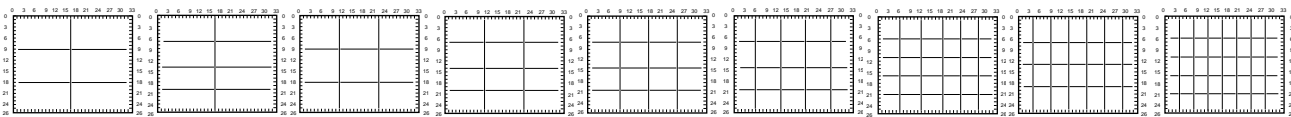

9212 6 Comp. 13" x 6.25"	9213 8 Comp. 13" x 4.75"	9222 9 Comp. 8.5" x 6.25"	9223 12 Comp. 8.5" x 4.75"	9233 16 Comp. 6" x 4/75"	9243 20 comp. 4.75" x 4.75"	9254 30 Comp. 3.75" x 3.75"	9263 28 Comp. 3" x 4.75"	9274 40 Comp. 3" x 3.75"
---------------------------------------	---------------------------------------	----------------------------------------	-----------------------------------------	---------------------------------------	------------------------------------------	------------------------------------------	---------------------------------------	---------------------------------------

30" x 24" Modular Cabinets

MODULAR CABINETS

The cabinets on this page are 24" wide x 24" deep. They offer you high density storage where weight load requirements are less and space is at a premium. You may order cabinet housings filled with your own custom designed drawer arrangements or choose from the popular pre-engineered combinations shown below. All models are shipped assembled and come with lock and two keys. Drawer divider sets are shown below. Additional accessories are on pages 46, 47 and 48.

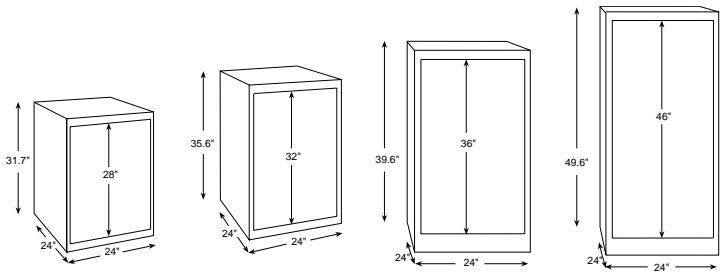

Housing No. 61300 Usable Height 28"
Housing No. 61700 Usable Height 32"
Housing No. 61400 Usable Height 36"
Housing No. 61500 Usable Height 46"

24" x 24" Housings

Cabinet housings can be filled only with normal suspension (NS) drawers. NS drawers have a load capacity of 220 lbs. (100 kgs.) with 90% extension capability. Side-mounted rails have a total of four precision ball bearings per drawer (2 each side). Select any combination of drawer front heights that equal the usable height of the cabinet. Drawers for all 24" x 24" cabinets are listed below.

24" x 24" Pre-engineered Combinations

Regular Height Cabinets



61407
 Overall dimensions are 24"W x 24"D x 39.6"H.
 2-3", 2-4", 1-6", 2-8" Drs.
 Total Sq. Ft. 20.47
 Total Cu. Ft. 7.70

61509
 Overall dimensions are 24"W x 24"D x 49.6"H.
 2-3", 3-4", 2-6", 2-8" Drs.
 Total Sq. Ft. 26.28
 Total Cu. Ft. 9.83

24" x 24" Machine or Base Cabinets

These cabinets are designed to store machine tools at the job site while using a small amount of floor space. They can also be used as work station base cabinets as shown on page 42. Available as pre-engineered units or custom design your own drawer arrangement by combining the housings with drawers listed below.

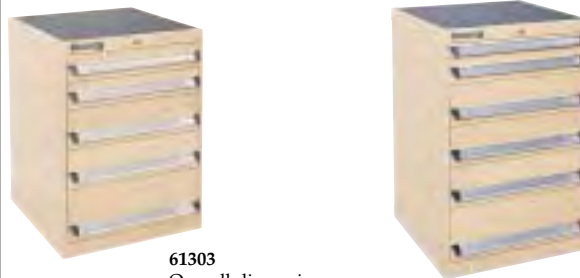

61303
 Overall dimensions are 24"W x 24"D x 31.7"H.
 2-4", 2-6", 1-8" Drawers
 Total Sq. Ft. 14.60
 Total Cu. Ft. 6.04

61703
 Overall dimensions are 24"W x 24"D x 35.6"H.
 1-2", 1-4", 3-6", 1-8" Drs.
 Total Sq. Ft. 17.52
 Total Cu. Ft. 6.86

Standard Width Drawers

Drawer pans have perforations for easy installation of dividers and accessories. Drawer fronts bolt on to allow changing drawer heights easily as storage needs change. Inside dimensions of drawers are 20.5" x 20.5" giving 2.92 sq. ft. of storage area.



NS drawers have 90% rail extension; 220 lbs. capacity.

NX Model #	Front Height	Usable Height		Sidewall Height		Load Capacity			
		Inch	MM	Inch	MM	Cubic Ft.	Lbs.	Kgs.	Extension
51002	2"	1.46	37	1.38	35	.35	220	100	90%
51003	3"	2.44	62	2.17	55	.59	220	100	90%
51004	4"	3.43	87	3.35	85	.83	220	100	90%
51005	5"	4.41	112	3.35	85	1.06	220	100	90%
51006	6"	5.39	137	3.35	85	1.30	220	100	90%
51007	7"	6.38	162	3.35	85	1.55	220	100	90%
51008	8"	7.36	187	3.35	85	1.78	220	100	90%
51009	9"	8.35	212	3.35	85	2.03	220	100	90%
51010	10"	9.33	237	3.35	85	2.26	220	100	90%
51012	12"	11.30	287	3.35	85	2.74	220	100	90%
51014	14"	13.27	337	3.35	85	3.22	220	100	90%
51016	16"	15.24	387	3.35	85	3.70	220	100	90%

Drawer Divider Sets for 24" x 24" Cabinets

To order, use the four digit number and add the number 2, 3 or 4 as a suffix. To order a divider set 9110 for a 2" drawer, order number 91102, 91103 for 3" drawer and 91104 for 4"-16" drawer. Taller subdividers and partitions are available on request.

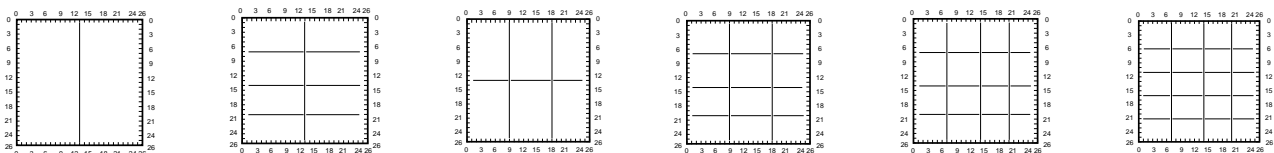

9110 2 Comp. 10" x 20.5"
9113 8 Comp. 10" x 4.75"
9121 6 Comp. 6.25" x 10"
9123 12 Comp. 6.25" x 4.75"
9133 16 Comp. 4.75" x 4.75"
9134 20 Comp. 4.75" x 3.75"

MOBILE MODULAR CABINETS

Mobile modular cabinets make taking your tools to the job site easy and convenient. And, you get high density storage, too. Cabinets include black vinyl top mat, two black vinyl handles and two fixed, two swivel 5 x 1½" casters. Load capacity of each caster is 440 lbs. Individual drawer latches prevent drawers from opening when cabinet is being moved. Order our pre-engineered models or custom design your own from the housings and drawers listed below. All models are shipped assembled and come with lock and two keys. Drawer divider sets and accessories are available.

30" x 30" Pre-Engineered Mobile Modular Cabinet



63350
Cabinet Size: 30" x 30" x 31"H.
Inside Drawer Dim.: 26" x 26"
Overall Dim.: 30" x 30" x 38.5"H
Standard Drs.: 2-3", 2-4", 1-6", 1-8"
Ship Weight: 296 lbs.

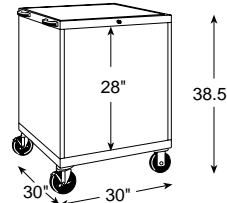

**Mobile Housing
No. 63359
Usable Height 28"**

30" x 30" Housing
Cabinet housing can be filled only with normal extension (NX) drawers. Select any combination of drawer front heights that equal the usable height of the cabinet.

NX latching drawers are listed below.

24" x 24" Pre-engineered Mobile Modular Cabinets



61203
Cabinet Size: 24" x 24" x 25.6"H.
Inside Drawer Dimensions:
20.5" x 20.5"
Overall Dim.: 24" x 24" x 25.6"H.
Standard Drawers:
2-2", 1-4", 1-6", 1-8"
Ship Weight: 157 lbs.



61750
Cabinet Size: 24" x 24" x 35"H.
Inside Drawer Dimensions:
20.5" x 20.5"
Overall Dim.: 24" x 24" x 42.4"H.
Standard Drawers:
2-3", 4-4", 2-5"
Ship Weight: 236 lbs.

24" x 24" Housings

Cabinet housings can be filled only with normal suspension (NS) drawers. NS drawers have a load capacity of 220 lbs. (100 kgs.) with 90% extension capability. Side-mounted rails have a total of four precision ball bearings per drawer (2 each side). Select any combination of drawer front heights that equal the usable height of the cabinet. Latching drawers are listed below.

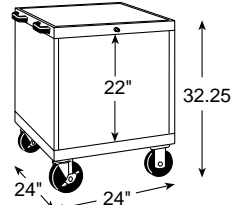

**Mobile Housing
No. 61209
Usable Height 22"**

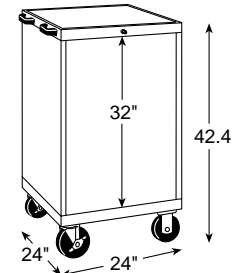

**Mobile Housing
No. 61759
Usable Height 32"**

Standard Width Drawers

Drawer pans have perforations for easy installation of dividers and accessories. Drawer fronts bolt on to allow changing drawer heights easily as storage needs change.

Latching Drawers for 30" x 30" Mobile Cabinets

NX Model #	Front Height	Usable Height		Sidewall Height		Cubic Ft.	Load Capacity		
		Inch	MM	Inch	MM		Lbs.	Kgs.	Extension
63902	2"	1.46	37	1.38	35	.57	220	100	87%
63903	3"	2.44	62	2.17	55	.95	220	100	87%
63904	4"	3.43	87	3.35	85	1.35	220	100	87%
63905	5"	4.41	112	3.35	85	1.72	220	100	87%
63906	6"	5.39	137	3.35	85	2.11	220	100	87%
63907	7"	6.38	162	3.35	85	2.49	220	100	87%
63908	8"	7.36	187	3.35	85	2.88	220	100	87%



NX drawers have 87% rail extension; 220 lbs. capacity.

Latching Drawers for 24" x 24" Mobile Cabinets

NS Model #	Front Height	Usable Height		Sidewall Height		Cubic Ft.	Load Capacity		
		Inch	MM	Inch	MM		Lbs.	Kgs.	Extension
51902	2"	1.46	37	1.38	35	.35	220	100	90%
51903	3"	2.44	62	2.17	55	.59	220	100	90%
51904	4"	3.43	87	3.35	85	.83	220	100	90%
51905	5"	4.41	112	3.35	85	1.06	220	100	90%
51906	6"	5.39	137	3.35	85	1.30	220	100	90%
51907	7"	6.38	162	3.35	85	1.55	220	100	90%
51908	8"	7.36	187	3.35	85	1.78	220	100	90%



NS drawers have 90% rail extension; 220 lbs. capacity.

STATIONARY WORK STATION COMBINATIONS

The Kennedy line of work stations includes stationary and mobile work stations, components and work surfaces. Whether you need an individual bench or a complete work station complex, Kennedy offers an extensive selection. Order our standard combinations or custom design the units you need from individual components. See page 40 for cabinet housing and drawer information. Drawer dividers and accessories are on pages 46, 47 and 48. All components, except work tops are available in the four standard colors: tan (stocking color), gray, green, blue. Special colors are available upon request.

Stationary Work Station Combinations

Featured are eight of our most popular work station combinations. To order, choose the work station that suits your needs and a 60" or 72" top shown below. You may, of course, order custom-designed units, including special work top sizes, from the components shown below and on page 43.

Work Surface Height 33½/33¾"

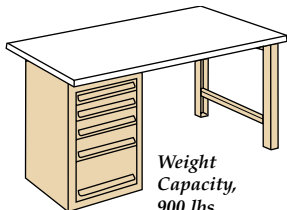

Weight Capacity, 900 lbs.

Model 69140

Above model includes: One standard leg; one 61303 24" x 24" cabinet. Order 60" or 72" top separately. See below.

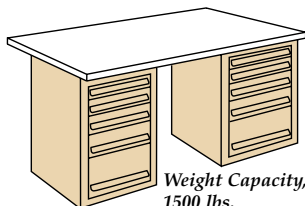

Weight Capacity, 1500 lbs.

Model 69148

Above model includes: Two 61303 24" x 24" cabinets. Order 72" top separately. See below.

Work Surface Height 37⅞/37⅞"

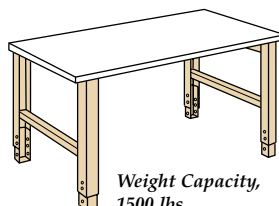

Weight Capacity, 1500 lbs.

Model 69104

Above model includes: Two adjustable legs. Order top separately. See below.

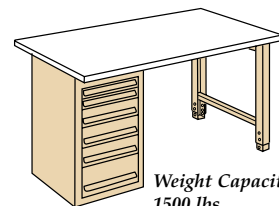

Weight Capacity, 1500 lbs.

Model 69146

Above model includes: One adjustable leg; one 61703 24" x 24" cabinet. Order 60" or 72" top separately. See below.

WORK STATION COMPONENTS



Standard Leg
Strong, welded construction. Overall height is 31.7". For use with 31.7" high base cabinets. Model 56100



Adjustable Leg
Adjusts in 1" increments from 27.5" to 40.125". Use where other than 31.7" fixed height is needed. Model 66200

WORK STATION TOPS

Laminated Maple Top

This traditional hardwood work surface is suitable for most any application. Each top is welded butcher block construction with a smooth, maintenance free acrylic finish. WT6030 60"W x 30"D x 1¾"H
WT7230 72"W x 30"D x 1¾"H



Special Order Work Tops

Maple work tops are available in other sizes than standard...both in length and width. Delivery times on special sizes are longer than on standard. Tops are available in single pieces up to 120", but should be supported at intervals not exceeding 72" by a bench leg or base cabinet.

WORK STATION BASE CABINETS



Model 61303 work station base cabinet. Overall dimensions are 24"W x 24"D x 31.7"H. Usable height is 28".

Standard drawer arrangement:
(2) 4" NS drawers
(2) 6" NS drawers
(1) 8" NS drawers



Model 61703 work station base cabinet. Overall dimensions are 24"W x 24"D x 35.6"H. Usable height is 32".

Standard drawer arrangement:
(1) 2" NS drawers
(1) 4" NS drawers
(3) 6" NS drawers
(1) 8" NS drawers

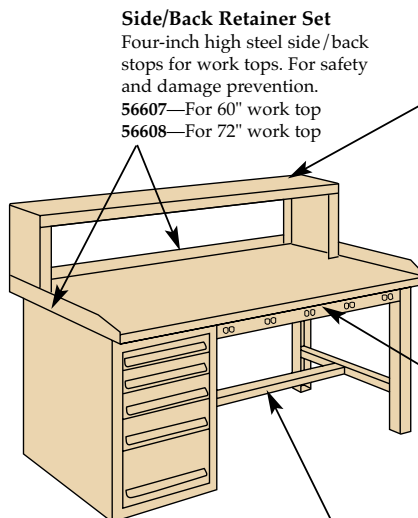

Side/Back Retainer Set

Four-inch high steel side/back stops for work tops. For safety and damage prevention.
56607—For 60" work top
56608—For 72" work top

Fixed Riser Shelf

Stationary riser of heavy gauge steel to hold heavy loads. Shelf is 14" high by 9" deep. Has electrical knockouts.
56601—Riser for 60" work top
56721—Riser for 72" work top

Electrical Panels

Knockout panels for use where electrical power is needed.
56602—8¾"L. Use with 60" top, two 24" wide cabinets
56722—20¾"L. Use with 72" top, two 24" wide cabinets
56605—28¾"L. Use with 60" top, one 24" wide cabinet
56725—40¾"L. Use with 72" top, one 24" wide cabinet

Foot Rests

Attach between work bench legs or between leg and base cabinet.
66606—Adjusts from 22" to 38¾"
66726—Adjusts from 38¾" to 66"

MOBILE WORK STATION COMBINATIONS

Mobile Work Station Combinations

You may order the work stations shown below or custom-designed units, including special work top sizes, from the components shown below. Drawer dividers and accessories are on pages 46, 47, and 48. All components, except work tops, are available in the four standard colors: tan, gray, green, blue. Special colors are available upon request.

Work Surface Height 36"—Weight Capacity, 1000 lbs.

All models include standard mobile base unit no. 68910, consisting of two legs, two top stringers, two bottom stringers, one rear stringer, one caster set (two fixed, two swivel) and four caster brackets. Order tops separately. See page 42.

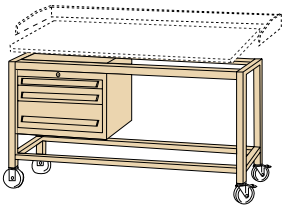

Model 68911
Above model includes:
Standard mobile base unit,
one 61104 cabinet.
Order top separately.
See page 42.

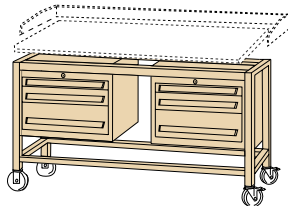

Model 68913
Above model includes:
Standard mobile base unit,
two 61104 cabinets.
Order top separately.
See page 42.

UNDERCOUNTER STORAGE— FOR STATIONARY & MOBILE WORK STATIONS



Model 61294 stationary work station cabinet.
Overall dimensions: 24"W x 24"D x 25.6"H.
Standard drawer arrangement:
(2) 4" NS drawers, (1) 6" NS drawer and
(1) 8" NS drawer

Housing No. 61290
Usable Height 22"
Drawers on page 41.



Model 61295 mobile work station cabinet.
Overall dimensions: 24"W x 24"D x 25.6"H.
Drawers have individual safety latches.
Standard drawer arrangement:
(2) 4" NS drawers, (1) 6" NS drawer and
(1) 8" NS drawer

Housing No. 61100
Usable Height 12"
Drawers on page 41.



Model 99850
work station drawer.
Overall dimensions are
19"W x 23"D x 8"H.



Bottom Shelf
Full-length bottom shelf. Use
with mobile work stations only.
Model 68013—48"L x 24"D.

COMPACT MODULAR CABINETS



Ten standard models available to service and organize machine work stations, tool and supply cribs, mobile maintenance, and assembly and inspection stations. Space saving design gives maximum storage in congested work areas. Compact modular cabinets have 164 lb. drawer capacity, central locking system, plus individual safety latch on each drawer.

All cabinets are available in tan, green, gray and blue. Drawers, dividers and accessories listed on page 44.

Standard Compact Modular Cabinets

All cabinets are 19.7" W x 19.7" D.
Inside drawer dimensions are 17.3" W x 17.3" D.



60708
Standard Drawers:
5-3", 1-5", 2-6"



60706
Standard Drawers:
1-3", 3-4", 1-5", 1-12"

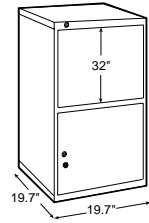

Housing No. 60700



60307
Standard Drawers:
4-3", 1-5", 2-6"



60306
Standard Drawers:
3-4", 1-5", 2-6"

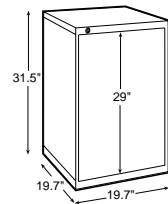

Housing No. 60300



60309
Cabinet Height:
31.5"H.
Standard Drawers:
2-3", 1-6"
One Door: 17"H
One Adjustable
Shelf: 1"H



60709
Cabinet Height:
34.5"H.
Standard Drawers:
1-3", 2-6"
One Door: 17"H
One Adjustable
Shelf: 1"H



Tool Hooks Sold on page 31.

Door Assembly is 17"H.

Door Opening is 18.5"W x 15.75"H

COMPACT MODULAR CABINETS

Standard Mobile Compact Cabinets

All cabinets are 19.7" W x 19.7" D. Inside drawer dimensions are 17.3" W x 17.3" D.



60205
Housing No. 60200
(4) 3 x 1/4" swivel casters
Cabinet Height:
29.35"H.
Standard Drawers:
2-3", 1-5", 2-6"



60203
Housing No. 60200
(4) 3 x 1/4" swivel casters
Cabinet Height:
29.35"H.
Standard Drawers:
1-5", 1-6", 1-12"

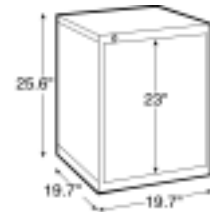

Housing No. 60200

To order a custom designed mobile cabinet, order 3 x 1/4" swivel caster set 80830, plus housing 60200 and drawers shown below.

Standard Mobile Maintenance Benches

All models are 40" W x 20" D x 35"H. Each unit is equipped with caster set no. 80837, (includes (2) fixed and (2) swivel 5 x 2" casters). All drawers are 17.3" W x 17.3" W.

60218

Comes standard with maple top no. WT4020
Uses two Housing Nos. 60200 and one Base Kit No. 60221
Standard Drawers (on left): 2-3", 1-5", 2-6"
Standard Drawers (on right): 1-5", 1-6", 1-12"



Tools not included.

60215

Comes standard with maple top no. WT4020
Uses one Housing No. 60200, one Housing No. 60201, one Base Kit No. 60221 and one Hook Set No. 99851
Standard Drawers (on left): 1-5", 1-6", 1-12"
Standard Drawers (on right): 2-3"

COMPACT MODULAR COMPONENTS & ACCESSORIES

Mobile Base Kit No. 60221

To order maintenance bench with custom drawer arrangement, order Kit No. 60221, at right. Then add housings, drawers and work surface top.



Drawers for Compact Modular Cabinets

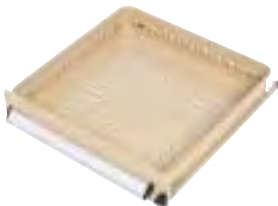

60003, 3" Drawer
60004, 4" Drawer
60005, 5" Drawer
60006, 6" Drawer
60012, 12" Drawer



Drawer Divider Kits

69063, 6 Compartment Kit for 3" Drawers
69093, 9 Compartment Kit for 3" Drawers
69023, 12 Compartment Kit for 3" Drawers
69064, 6 Compartment Kit for 4" Drawers
69094, 9 Compartment Kit for 4" Drawers
69024, 12 Compartment Kit for 4" Drawers

Drawer Dimensions are 17.3" W x 17.3" D



Laminated Maple Work Surface Tops
WT4020, Mobile Maintenance Bench Top
40" W x 20" D x 1.75" H.
WT6024, 60" Work Bench Top
60" W x 24" D x 1.50" H
WT7224, 72" Work Bench Top
72" W x 24" D x 1.50" H



60009
Door Assembly 17"H

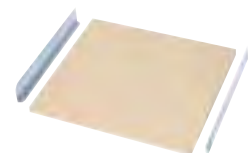

60040
Adjustable Shelf 1"H

NEW! KENNEDY HMS™ SERIES "HYBRID MODULAR STORAGE"

Combines the economy of roller cabinet construction with modular cabinet features!

- Kennedy Quality
- Flexible Drawer Divider System
- Stationary & Mobile Models
- Drawer Safety Interlock
- 130-220 lbs. Drawer Weight Capacity

Compact, high-density storage that saves space while it organizes parts, tools and supplies in the best traditions of "Lean Manufacturing" and 5S Programs. Cabinets are stackable, can be fork-lifted and used as work stations. Housings are 29" wide x 20" deep with usable drawer height of 28". Four-inch drawers have 130 lb. weight capacity; all larger drawers have double slides for 220 lb. weight capacity. Only one drawer open-at-a-time safety system. Ball-bearing slides are standard. MDF work surface. Cabinets can also be used as work station base cabinets, using two cabinets to support work surface or one cabinet with adjustable work station leg, 66200 on page 42. Full-width drawer pulls with label strips. Lock, two keys.



Pre-Configured Combinations

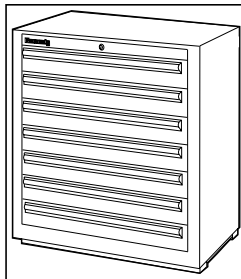

Standard drawers: 7-4"
40097—Tan finish
40197—Blue finish

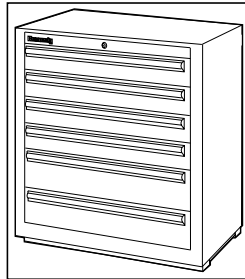

Standard drawers: 4-4", 2-6"
40096—Tan finish
40196—Blue finish

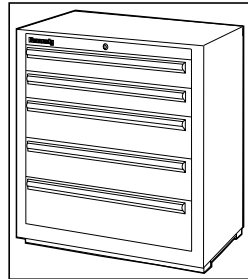

Standard drawers: 2-4", 2-6", 1-8"
40095—Tan finish
40195—Blue finish

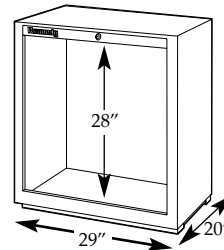

Housing No.
40001—Tan finish
40101—Blue finish
Usable Height, 28"

Cabinet Plastic Work Surface
Seamless, ABS black plastic cover fits over cabinet top.
Model 82171

See your Kennedy Tool Storage Accessories Brochure for more information.

Drawers

Drawers are welded heavy gauge steel that have bottom perforations and side wall divider slots for easy installation of divider sets. (2" drawer is a standard roller cabinet drawer and cannot be divided). When ordering custom-designed cabinets, the drawer front heights must add up to the usable height of the housing (28").



Drawers		
All drawers are 25" x 18½"		
No.	Color	Front Height
40002	Tan	2"
40004	Tan	4"
40006	Tan	6"
40008	Tan	8"
40102	Blue	2"
40104	Blue	4"
40106	Blue	6"
40108	Blue	8"

Mobile Package

Consists of tubular side handle and 6 x 2" locking caster set—two swivel, two rigid.
Model 42010

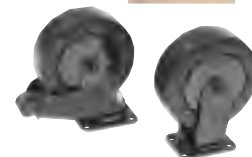

Drawer Divider Sets

Consists of partitions that fasten to drawer bottom and divide drawer into sections, plus subdividers that can be inserted into slots to form compartments. Partitions and subdividers are 3.5" high. If taller partitions/subdividers are needed, see Kennedy's website.

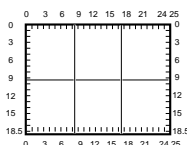

42001
6 Compartments
8.3" x 9.25"

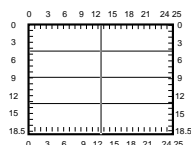

42002
8 Compartments
12.5" x 4.6"

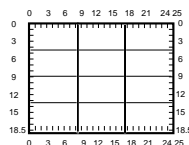

42003
12 Compartments
8.3" x 4.6"

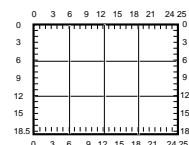

42004
12 Compartments
6.2" x 6.1"

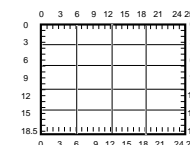

42005
20 Compartments
6.2" x 3.6"

Visit our website at www.kennedymfg.com for more information on individual dividers and partitions to customize drawer interiors.

HMS™ Mobile Modular Storage

MODULAR STORAGE DRAWER ACCESSORIES

Partitions & Subdividers

Use partitions to divide drawers into sections. Insert subdividers to make compartments. Partitions fasten to drawer bottom with screw and can be fitted from front to back or side to side. Subdividers slide into slots in partitions and sidewalls. Slots are .79" (20 mm) apart.



PARTITIONS

Partition Length	No. of Spaces	EDP Order No.		
		2" Dr. Front	3" Dr. Front	4"-16" Dr. Front
9.33" (237 mm)	12	99012	99013	99014
14.84" (377 mm)	19	99022	99023	99024
17.00" (432 mm)	21	—	99017	99018
20.35" (517 mm)	26	99032	99033	99034
25.87" (657 mm)	33	99042	99043	99044
40.15" (1020 mm)	51	—	99053	99054

Note: Taller partitions and subdividers for use with higher side walls (drawer height extensions) are available. Check your Kennedy Price List or contact your Kennedy representative or distributor for information.

SUBDIVIDERS

Length	Spaces	2" Dr. Front	3" Dr. Front	4"-16" Dr. Front
		EDP Order No.	EDP Order No.	EDP Order No.
1.42" (36 mm)	2	99505	99103	99104
2.02" (56 mm)	3	99122	99123	99124
2.99" (76 mm)	4	99503	99143	99144
3.78" (96 mm)	5	99162	99163	99164
4.57" (116 mm)	6	99182	99183	99184
5.35" (136 mm)	7	99202	99203	99204
6.14" (156 mm)	8	99222	99223	99224
6.93" (176 mm)	9	99242	99243	99244
7.72" (196 mm)	10	99262	99263	99264
8.50" (216 mm)	11	99282	99283	99284
9.29" (236 mm)	12	99289	99290	99291
10.08" (256 mm)	13	99302	99303	99304
12.44" (316 mm)	16	99322	99323	99324
13.23" (336 mm)	17	99342	99343	99344

Tool Holders/Angular Rests

Used to store files, tap and die holders, and wrenches. To form an adjustable base to fit the tool or part to be stored, fasten two angular rests to drawer bottom. Retaining blocks are designed to secure irregular shaped tools.

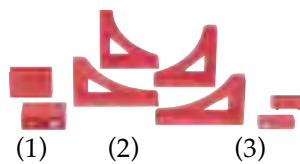

Description	EDP Order No.
(1) Tool Holders 1.56" L x .8125" W x 1.56"H	99531
(2) Angular Rests, pairs 3.125" L x .8125" W x 2.312"H	99532
(3) Retaining blocks 1.3" L x .56" W x .56"H	99533

Prism Racks

For side-sensitive tools such as taps, reamers and gauges. The serrated blocks are in two pitches—.5" and .79" centers. Spacers available to increase height of prism racks.

Prism racks and spacers are 6.25"L x .625"W x .8125"H.



Description	Size	EDP Order No.
Prism racks with grooves .5" apart	.79"H Pitch 12	99511
Prism racks with grooves .79" apart	.79"H Pitch 20	99512
Spacer	.79"H	99513

MODULAR STORAGE DRAWER ACCESSORIES

Milling Tool Holders

Designed to secure milling tools, saws, disks and clamping devices. Eight sizes, one-inch high. Can be connected for larger tools.



Size/Dia.	EDP Order No.
.39" (10 mm)	99521
.51" (13 mm)	99522
.63" (16 mm)	99523
.87" (22 mm)	99524
1.00" (25 mm)	99525
1.26" (32 mm)	99526
1.57" (40 mm)	99527
1.97" (50 mm)	99528

Plastic Groove Trays

A simple way to store reamers, taps and drill bits. Trays clip together. Made of red polystyrol. Not for use in compact modular cabinets.



Plastic Groove Trays are 6.3"L x 6.3"W x 1.375"H.

PLASTIC GROOVE TRAYS

No. of Grooves Groove Size	EDP Order No.
2 grooves / 3"	99500
3 grooves / 1.9"	99501
4 grooves / 1.4"	99502

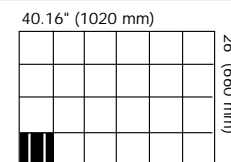
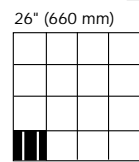
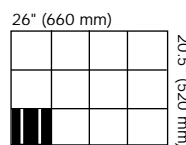
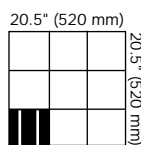

TRAY DIVIDERS

Divider Size	EDP Order No.
2 grooves	99503
3 grooves	99504
4 grooves	99505

Plastic Boxes

Hold small parts and electronic components. Available in three sizes and three heights. Can be clipped together in any combination.



Made of red polystyrol.

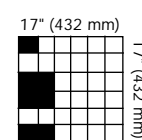
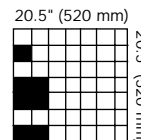
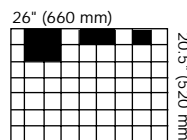
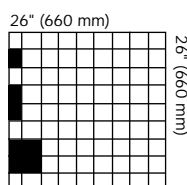
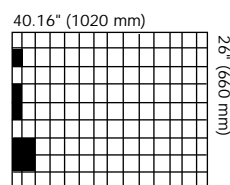
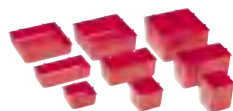

Box Size	Dr. Front Height	EDP Order No.
2.8"W x 2.8"D x 1.375"H	2"	99572
2.8"W x 2.8"D x 2.1875"H	3"	99573
2.8"W x 2.8"D x 3.125"H	4"	99574
2.8"W x 5.6"D x 1.375"H	2"	99582
2.8"W x 5.6"D x 2.1875"H	3"	99583
2.8"W x 5.6"D x 3.125"H	4"	99584
5.6"W x 5.6"D x 1.375"H	2"	99592
5.6"W x 5.6"D x 2.1875"H	3"	99593
5.6"W x 5.6"D x 3.125"H	4"	99594

Plastic Box Sets for 30" x 30" Modular Cabinets

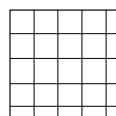

9625

1 Box 2.83" x 2.83"
8 Boxes 5.66" x 2.83"
16 Boxes 5.66" x 5.66"

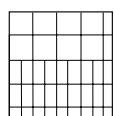

9637

9 Boxes 2.83" x 2.83"
20 Boxes 5.66" x 2.83"
8 Boxes 5.66" x 5.66"

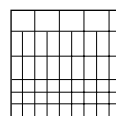

9650

27 Boxes 2.83" x 2.83"
19 Boxes 5.66" x 2.83"
4 Boxes 5.66" x 5.66"

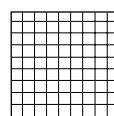

9681

81 Boxes 2.83" x 2.83"

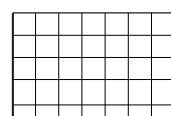

9635

7 Boxes 5.66" x 2.83"
28 Boxes 5.66" x 5.66"

Plastic Box Set for 44" x 30" Cabinets

Plastic Box Sets for 24" x 24" Modular Cabinets

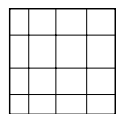

9616

1 Box 2.83" x 2.83"
6 Boxes 5.66" x 2.83"
9 Boxes 5.66" x 5.66"

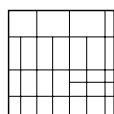

9628

13 Boxes 2.83" x 2.83"
12 Boxes 5.66" x 2.83"
3 Boxes 5.66" x 5.66"

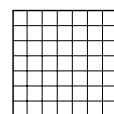

9649

49 Boxes 2.83" x 2.83"



Felt Drawer Liner

Helps protect tools from scratches and abrasions. Easily installed into drawer with household glue.

80991—20½" x 82" roll

80992—26" x 82" roll

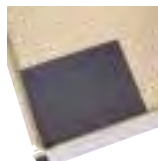

Griptex Liner

Non-slip, open weave drawer liner keeps tools in place. Polyester fabric coated with PVC.

Washable, anti-fungal and mildew-proof.

80813—20½" x 82" roll

80815—26" x 82" roll

MODULAR STORAGE DRAWER AND CABINET ACCESSORIES



Adjustable Shelf
Adjustable support brackets allow shelf location to be easily changed.

Pull Out Shelf with Drawer Handle
Safety feature, lock-out pin prevents shelf from moving back inside the cabinet until the pin is released.

Bottom Shelf
Turns cavity in bottom of cabinet into easy access storage area.

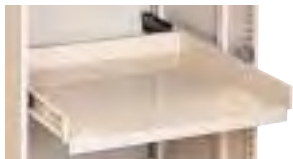

Pull Out Shelf with Gussets
For use in cabinets with doors. Features safety lock-out pin mechanism.

Pull Out Shelves and Shelves with Gussets have 550 lbs. weight capacity; except, shelves for 24" x 24" cabinets, 220 lbs. weight capacity.

Model No.	Description
63202	Adjustable Shelf for 30" x 30" Cabinet
63302	Pull Out Shelf for 30" x 30" Cabinet
63305	Pull Out Shelf with Gussets for 30" x 30" Cabinet
99001	Bottom Shelf for 30" x 30" Cabinet
64202	Adjustable Shelf for 44" x 30" Cabinet
64302	Pull Out Shelf for 44" x 30" Cabinet
64305	Pull Out Shelf with Gussets for 44" x 30" Cabinet
99004	Bottom Shelf for 44" x 30" Cabinet
62202	Adjustable Shelf for 30" x 24" Cabinet
62302	Pull Out Shelf for 30" x 24" Cabinet
62305	Pull Out Shelf with Gussets for 30" x 24" Cabinet
99003	Bottom Shelf for 30" x 24" Cabinet
61202	Adjustable Shelf for 24" x 24" Cabinet
61302	Pull Out Shelf for 24" x 24" Cabinet
61305	Pull Out Shelf with Gussets for 24" x 24" Cabinet
99002	Bottom Shelf for 24" x 24" Cabinet

Note: Above numbers are for tan finish shelves only. Shelves are also available in blue, green and gray stocking colors. Special colors available upon request.



Bottom Support Brackets
Each set of two secures up to five NC/CNC tool trays into drawer. (Tool trays shown on page 50). Bolt to drawer bottom. Hardware included.

For 30" x 30" cabinets, especially 63303 shown on page 37.
99541 Set 25.6"L x 3.5"H
99543 Set 25.6"L x 5"

For 30" x 24" Cabinets.
99540 Set 20"L x 3.5"H
99542 Set 20"L x 5"H

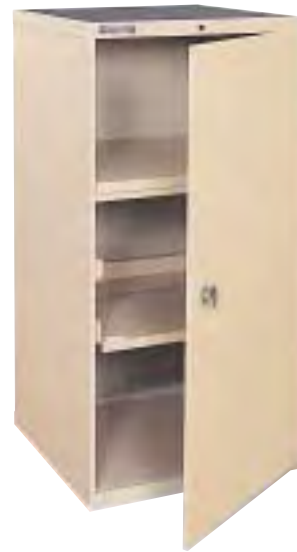

Modular Cabinet Doors
Secure expensive tools and supplies behind locking door. Comes with attachment hardware and lock/key set. Pullout Shelf with Gussets must be used instead of standard drawer with drawer pull in order for door to close.

Fits Housing No./Size	EDP Order No.
63600, 30" x 30" x 59.5"	63680
63400, 30" x 30" x 39.6"	63480
63300, 30" x 30" x 31.7"	63380
62500, 30" x 24" x 49.6"	62580
62700, 30" x 24" x 35.6"	62780
64600, 44" x 30" x 59.5"	64680
64400, 44" x 30" x 39.6"	64480
61280, 24" x 24" x 25.6"	61280
61300, 24" x 24" x 31.7"	61380
61400, 24" x 24" x 39.6"	61480
61500, 24" x 24" x 49.6"	61580
61700, 24" x 24" x 35.6"	61780

Panel Brace Supports
Braces attach to work station and louvered or toolboard panels (shown on page 26). Two brace supports are required per two panel set.

Model 50050 includes one brace and mounting hardware.

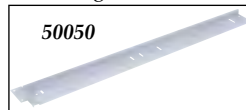

Model 50054 includes one left hand and one right hand angle bracket plus mounting hardware.

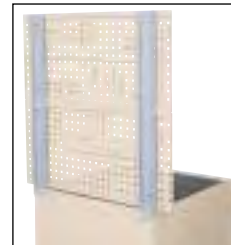

Two 50050 Braces with panel set 50002 (shown on page 30)

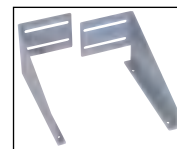

50054



Two 50050 Braces with panel set 50061 (shown on page 30)



Fork Lift Bases
Bolt easily onto cabinet. Come with front covers. Available in same colors as cabinets. 2.4"H
99606 for 20" x 20" cabinets
99616 for 24" x 24" cabinets
99626 for 30" x 24" cabinets
99636 for 30" x 30" cabinets
99646 for 44" x 30" cabinets

Pallet Truck Base. 4"H.
99706 for 20" x 20" cabinets
99716 for 24" x 24" cabinets
99726 for 30" x 24" cabinets
99736 for 30" x 30" cabinets
99746 for 44" x 30" cabinets



Drawer Height Extensions
Removable drawer insert raises

sidewall height to match drawer front. Slotted sides allow use of taller partitions and subdividers.

Housing Size	For Drawer Front Height:	EDP Order No.
24" x 24"	6"	91066
24" x 24"	8"	91067
24" x 24"	10"	91068
24" x 24"	12"	91069
30" x 30"	6"	91070
30" x 30"	8"	91071
30" x 30"	10"	91072
30" x 30"	12"	91073
30" x 24"	6"	91074
30" x 24"	8"	91075
30" x 24"	10"	91076
30" x 24"	12"	91077
44" x 30"	6"	91078
44" x 30"	8"	91079
44" x 30"	10"	91080

INSIDE HEIGHT OF DRAWERS	2"	3"	4"	5"	6"	7"	8"
DRAWER FRONT HEIGHT	50 mm	75 mm	100 mm	125 mm	150 mm	175 mm	200 mm

How to order Kennedy custom built cabinets, drawers and accessories

1. Separate, by height, items to be stored and calculate the required square area of all items in each height group, taking into consideration the average inventory quantity.

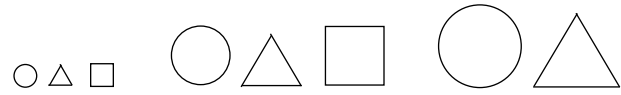

2. Select any of the 12 standard height drawers. Drawers are available in 1" increments from 2" to 10", and 2" increments from 10" to 16". Use the Handy Guide Ruler at the top of this page. The lines indicated the usable height of the drawer and the numbers (2", 3", etc.) indicate the drawer front height to be calculated.

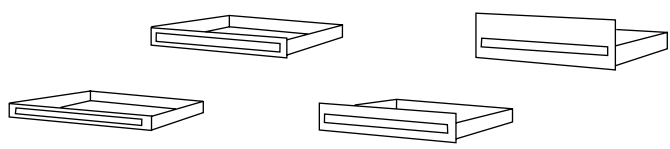

3. Choose the type of suspension needed. Normal Suspension (NS) drawers have 90% extension and 220 lbs. load capacity. **NOTE:** NS drawers available for 24" x 24" cabinets only.

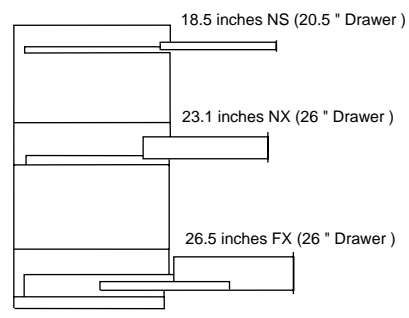

Normal Extension (NX) drawers have 87% extension and 200 lbs. load capacity.

Full Extension (FX) drawers have over 100% extension and 550 lbs. capacity. **NOTE:** The smallest drawer available with Full Extension telescoping rails is 3" front height.

4. Select the cabinet housing that best fits your needs. NS drawers fit only 24" x 24" cabinet housings. FX and NX drawers fit 30" x 24" and 30" x 30" cabinet housings and can be mixed within the same housing. XW (extra wide), 44" x 30" cabinet housings use only 550 lb. FX drawers. Add the drawer front heights together to fill the usable height of the selected cabinets.

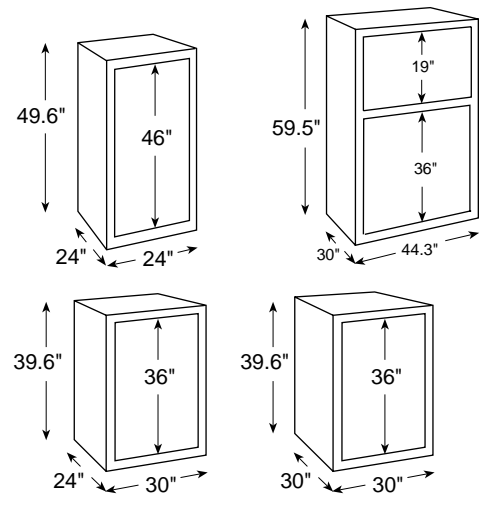

5. Select any of the dividers sets shown in the catalog to suit your requirements, or make up your own sets for the accessories listed on pages 46 through 48.

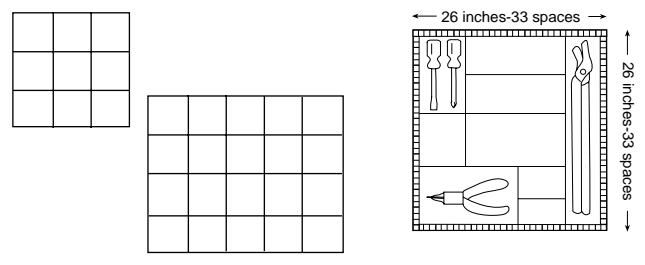

Drawers are divided into spaces. Each space is .79" (20 mm) wide. Use the scale on the bottom of this page to determine the length of the subdividers. Example: A ball bearing measuring 2" requires a 3-space subdivider.

NUMBER OF SPACES

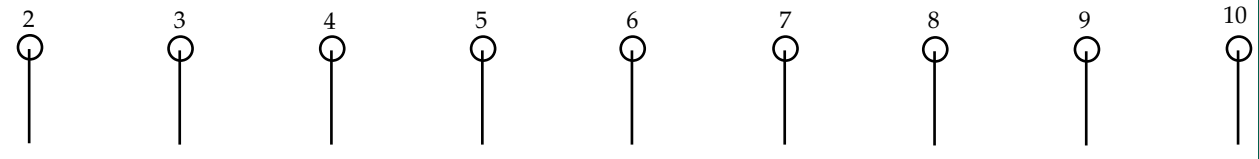

Susta/Kennedy plastic sockets are of high quality, break resistant plastic. Shockproof ABS plastic sockets firmly support and protect tool holder shanks. Sockets are available for standard tapers, Morse tapers and straight shank tool holders. All plastic sockets are available in red only.



70059 socket for #30 taper tool holders. Also Cat V#3, Morse 3. Up to seven sockets will fit 70060 tool tray.



70100 socket for straight shank tools up to 1.2" dia. (30 mm). Up to ten sockets will fit 70060 tool tray.

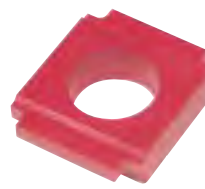

Kennametal KM[®] Plastic Sockets
70030 KM32
1.75" W x 4" D x 1"H
Up to 8 will fit a tray



HSK-A System Sockets
70020 HSKA 25
1.75" W x 4" D x 1"H
Up to 8 will fit a tray

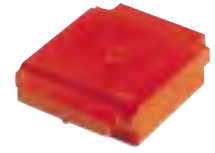

70090 socket without holes, for special sized tools. Holes up to 1.2" can be drilled. Up to eight sockets will fit 70060 tool tray.

70067 socket for #35 taper tool holders. Also, Cat V#3, Morse 4. Up to seven sockets will fit 70060 tool tray.

70064 socket for straight shank tools up to 1.4" dia. (36 mm) TR36. Up to seven sockets will fit 70060 tool tray.

70031 KM40
1.75" W x 4" D x 1"H
Up to 8 will fit a tray

70021 HSKA 32
1.75" W x 4" D x 1"H
Up to 8 will fit a tray

70051 socket for #40 taper tools. Also, Cat V#4. Up to seven sockets will fit 70060 tool tray.

70063 socket for straight shank tools up to 1.5" dia. (40 mm). Up to seven sockets will fit 70060 tool tray.

70032 KM50
3.25" W x 4" D x 1"H
Up to 6 will fit a tray

70022 HSKA 40
1.75" W x 4" D x 1"H
Up to 8 will fit a tray

70092 socket without holes, for special sized tools. Holes up to 2.25" can be drilled. Up to six sockets will fit 70060 tool tray.

70052 socket for #45 taper tools. Also, Morse 5. Up to six sockets will fit 70060 tool tray.

70056 socket for straight shank tools up to 1.75" dia. (44.4 mm). Up to six sockets will fit 70060 tool tray.

70033 KM63
3.25" W x 4" D x 1"H
Up to 6 will fit a tray

70023 HSKA 50
3.25" W x 4" D x 1"H
Up to 6 will fit a tray

70094 socket without holes, for special sized tools. Holes up to 3.5" can be drilled. Up to five sockets will fit 70070 tool tray.

70053 socket for #50 taper tool holders. Also, Cat V#5. Up to five sockets will fit 70060 tool tray.

70065 socket for straight shank tools up to 1.97" dia. (50 mm). Up to six sockets will fit 70060 tool tray.

Sandvik Capto[™] System Plastic Sockets
71103 C3
1.75" W x 4" D x 1"H
Up to 8 will fit a tray

70024 HSKA 63
3.25" W x 4" D x 1"H
Up to 6 will fit a tray

70096 socket without holes, for special sized tools. Holes up to 3.7" can be drilled. Up to four sockets will fit 70070 tool tray.

70057 socket for straight shank tools up to 2" dia. (50.8 mm). Up to six sockets will fit 70060 tool tray.

70057 socket for straight shank tools up to 2" dia. (50.8 mm). Up to six sockets will fit 70060 tool tray.

71104 C4
1.75" W x 4" D x 1"H
Up to 8 will fit a tray

70025 HSKA 80
3.25" W x 4" D x 1"H
Up to 6 will fit a tray

Plastic sockets designed to secure and protect Modular Quick Change Units

70066 socket for straight shank tools up to 2.4" dia. (60 mm). Up to six sockets will fit 70060 tool tray.

70066 socket for straight shank tools up to 2.4" dia. (60 mm). Up to six sockets will fit 70060 tool tray.

71105 C5
3.25" W x 4" D x 1"H
Up to 6 will fit a tray

70026 HSKA 100
Fits Tray 70070 only
4" W x 4" D x 1"H
Up to 5 will fit a tray

71106 C6
3.25" W x 4" D x 1"H
Up to 6 will fit a tray

70027 HSKA 125
Fits Tray 70070 only
5.3" W x 4" D x 1"H
Up to 4 will fit a tray

71108 C8
3.25" W x 4" D x 1"H
Up to 6 will fit a tray

Tool Trays for NC/CNC Tools



70060 metal tool tray holds plastic sockets for all types of tools. Two sturdy, collapsible handles and foot construction make it easy to take tools to work table. 23.3" W x 4.5" D x 5"H.

70070 metal tool tray holds sockets 70094, 70096, 70026 and 70027. 23.3"W x 5.9"D x 5"H.

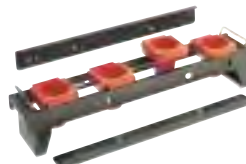

Angle brackets hold plastic sockets firmly in place. Easily removed for changing inserts.

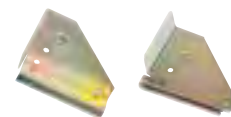

70005 universal brackets are required to place tool trays in tool trolleys, toolkarts, storage racks or bench stands. Can be positioned three ways—horizontal, 15 degrees and 30 degrees. Packed in sets of one left and one right.

74021 three-tier stand supports three trays. 26.3" W x 12.6" D x 23.66"H. Weight Capacity, 300 lbs. Ship Wt. 13 lbs.



Trays and sockets not included.

74023 two-tier stand supports two trays. 26.3" W x 12.6" D x 16"H. Weight Capacity, 200 lbs. Ship Wt. 10 lbs.



Trays and sockets not included.

Susta/Kennedy trolleys are an efficient means of transporting tools between machining centers and tool rooms. Tooling is contained within the side walls, protecting both the tooling and the operation. Basic trolley can be easily expanded as your needs grow.

Basic NC/CNC Tool Trolley



72007—Smooth Blue Finish
Four-panel trolley holds up to 10 tool trays. Comes with four 6" casters and one end handle. Maximum tool holder capacity:
(80) 30,35 taper
(70) 40 taper
(60) 45 taper
(50) 50 taper
31"L x 24" W x 38.75"H.
Weight Capacity, 2,200 lbs.



Shelves for trolleys have ribbed rubber mats. $\frac{3}{4}$ " high shelf edge. Brackets attach to inside trolley walls. Weight Capacity, 200 lbs. Available in Dark Gray Finish Only
72008—23.75" W x 22.6" D x 1.75"H
72010—23.75" W x 10.25" D x 1.75"H

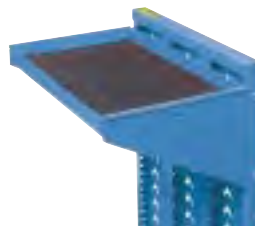

Steel Shelf provides additional work space. Comes with rubber mat. 18" W x 12" D x 1.5"H.
72006—Smooth Blue Finish
Shelf No. 72045 fits trolley 72007 and ToolKart™.
24" W x 12" D x 1.5"H.
72045—Smooth Blue Finish

Pre-Engineered NC/CNC Tool Trolley

Pre-configured trolleys come with eight tool trays, brackets and plastic sockets. Additional tool trays, plastic sockets and trolley accessories must be added separately.



Pre-configured trolley holds up to 40 #50 taper tools.
Weight Capacity, 2,200 lbs.
73154—Smooth Blue Finish

Tools not included

The CutterKart™

Pre-configured CutterKarts come with four metal and ABS plastic tool holder plates.



Pre-configured trolley holds up to 56 #40 taper tools.
Weight Capacity, 1,200 lbs.
73240—Smooth Blue Finish

Pre-configured trolley holds up to 40 #50 taper tools.
Weight Capacity, 1,200 lbs.
73250—Smooth Blue Finish

Extra #40 taper tool holder plate, holds 14 tool holders.
Model 70084

Extra #50 taper tool holder plate, holds 10 tool holders.
Model 70085

The TOOLKART™

Pre-configured ToolKarts come with six frames and plastic sockets. Additional tool frames, plastic sockets and trolley accessories must be added separately.

Pre-configured ToolKart holds up to 42 #30 taper tools.
Weight Capacity, 1,200 lbs.
73030—Smooth Blue Finish

ToolKart only.
28.25"W x 23.5"D x 38"H.
Weight Capacity, 1,200 lbs.
72001—Smooth Blue Finish



Pre-configured ToolKart holds up to 36 #50 taper tools.
Weight Capacity, 1,200 lbs.
73050—Smooth Blue Finish

Pre-configured ToolKart holds up to 42 #40 taper tools.
Weight Capacity, 1,200 lbs.
73040—Smooth Blue Finish

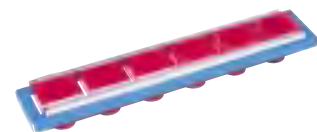

Sturdy socket frame bolts to end wall of ToolKart. Holds up to 11 #30 taper tools.
70062—Smooth Blue Finish



PRE-ENGINEERED TOOL STORAGE RACKS



STORAGE STATION

Description	Size	Blue EDP Order No.
Racks	26"W x 24"D x 77"H	74066
Side Panel, 8/set	76.5"H	74168
Document Shelf	53"W x 12"D x 15.5"H	74413
Document Shelf	79"W x 12"D x 15.5"H	74414
Table Support	53"L	74419
Table Support	79"L	74422
Wood Top	53"W x 24"D x 1.5"H	74415 (Maple finish)
Wood Top	79"W x 24"D x 1.5"H	74416 (Maple finish)
32" Side Panels, 8/set	32"H	74408
32" Rack with back	32"H	75413
32" Rack Door	28"H	74433
77" Rack Door	72"H	74076
73" Back Panel	73"H	74075

Pre-configured Ministore® contains:

- (5) Tool trays
 - (1) Pull-out shelf
 - (13) Drawers
 - (5) Pull-out frames
 - (1) Locking tall door
 - (1) Book shelf
 - (1) 53"L Maple work top
- Holds up to (150) #50 taper tools, or (210) #40 taper tools.

Overall dimensions:
105"W x 24"D x 77"H.

75601—Smooth Blue Finish

Bench stand and tools not included.



32"H four panel rack with back organizes supplies and tools under a work bench, or at machine side. 26" W x 24" D x 32"H. Interior load capacity, 2,200 lbs. 75413—Smooth Blue Finish



Five lift-out tool trays, five drawers and a pull-out shelf provide organized storage for up to (35) #40 taper or (25) #50 taper tools and NC/CNC machining supplies. Drawer and pull-out shelf weight capacity, 275 lbs. each. 26" W x 24" D x 77"H. Interior load capacity, 2,200 lbs. 75112—Smooth Blue Finish



Five pull-out frames will store up to (125) #50 taper tools or (175) #40 taper tools. Pull-out frame weight capacity, 275 lbs. each. 26" W x 24" D x 77"H. Interior load capacity, 2,200 lbs. 75122—Smooth Blue Finish



Three pull-out frames and five drawers provide organized storage for up to (105) #40 taper tools or (75) #50 taper tools and NC/CNC machining supplies. Pull-out frame and drawer weight capacity, 275 lbs. each. 26" W x 24" D x 77"H. Interior load capacity, 2,200 lbs. 75117—Smooth Blue Finish



Four panel rack provides the most versatile and efficient storage available. Assembly required. 26" W x 24" D x 77"H. Interior load capacity, 2,200 lbs. 74066—Smooth Blue Finish

Drawers and pull-out frames have full extension tracks mounted in the slotted rack walls. Tracks can easily be adjusted up or down. No bolts or tools needed. Weight capacity per drawer and frame is 275 lbs. (125 kgs.).

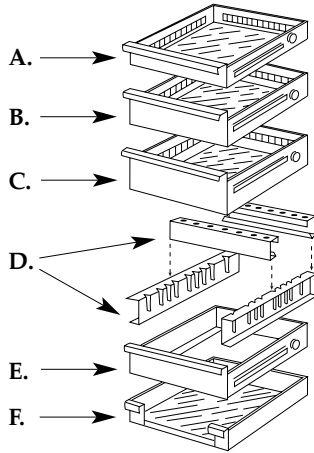

Drawers for Tool Storage Racks 75413, 75416, 74066 and 74067

- A. Model 76270—22"W x 22"D x 3"H. (75 mm)
- B. Model 76271—22"W x 22"D x 4 $\frac{3}{8}$ "H. (112.5 mm)
- C. Model 76272—22"W x 22"D x 6"H. (150 mm)
- C. Model 76273—22"W x 22"D x 8 $\frac{1}{8}$ "H. (225 mm)
- D. Model 76208—Adjustable tool holder kit.
Holds up to five rows of sockets.
- D. Model 76531—Adjustable tool holder kit.
Holds up to four rows of socket nos.
70094, 70096, 70026 and 70027.
- E. Model 76314—Pull-out Frame
D and E Combined = 4 $\frac{3}{8}$ "H (112.5 mm)
- F. Model 76305—Pull-out Shelf
22"W x 22"D x 3"H. (75 mm)

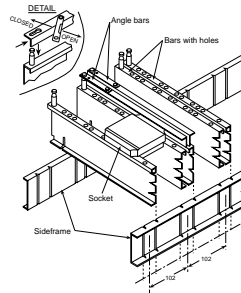

Combine an Adjustable Tool Holder Kit (D) and Pull Out Frame (E) to achieve maximum tool storage and efficiency.

In the Pull-out Frame with a kit, it is possible to have up to four and five rows of sockets in with up to eight sockets per row.

Socket Size	No. Sockets Per Row	No. Sockets Per Frame
30 Taper	8	40
40 Taper	7	35
50 Taper	5	25

To fill racks with a desired drawer combination, the combination of drawer front heights (mm) can not exceed the usable height of the rack (mm).

Rack Model	Overall Height	Usable Height
75413/75416	32" high	675 mm
74066/74067	77" high	1803 mm

**Safety Note: Drawers should never be used for storing tools in trolleys. Trolley could tip over causing personal injury.*

Plastic Groove Kit

A simple way to store reamers, taps and drill bits. Trays clip together. Made of polystyrol in red. 5 $\frac{5}{8}$ " W x 5 $\frac{5}{8}$ " D x 1 $\frac{1}{4}$ "H.

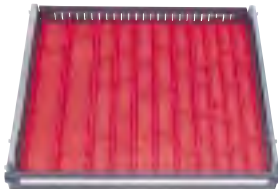

Plastic Groove Kit Model 76311

Includes:
4 rows, 1.4"W, 20 Dividers
5 rows, 1.9"W, 25 Dividers
2 rows, 3"W, 15 Dividers

Plastic Boxes

Hold small parts and electronic components. Made of polystyrol in red. Each kit fills one 22" W x 22" D drawer. Boxes are 2.4"H.



Description	Components	EDP Order No.
49 Box Kit	(36) 3" x 3", (12) 3" x 4", (1) 4" x 4"	77263
42 Box Kit	(26) 3" x 4", (12) 3" x 3", (4) 4" x 4"	77266
28 Box Kit	(18) 3" x 6", (3) 4" x 6", (6) 3" x 4", (1) 4" x 4"	77264
16 Box Kit	(9) 6" x 6", (6) 4" x 6", (1) 4" x 4"	77265

Divider Sets For Tool Storage Racks

Adjustable, metal divider sets are available for 22 x 22" drawers.



Drawer Height	No. of Compartments	EDP Order No.
3"	25	77277
4"	25	77278
6"	25	77279
3"	16	77281
4"	16	77282
6"	16	77283
3"	9	77288
4"	9	77289
6"	9	77290
3"	4	77296
4"	4	77297
6"	4	77298

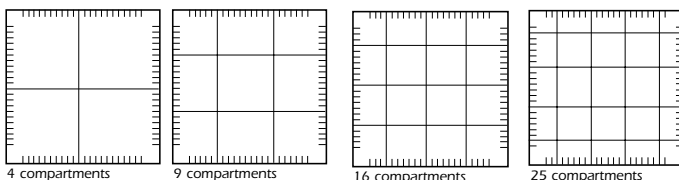

Collet Holders

A 22"W x 22"D Susta/Kennedy drawer will hold four plates.

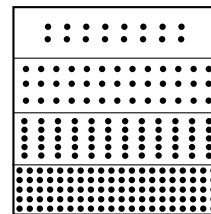

Each collet plate measures 21.5"L x 5.5"W.

EDP Order No.	Height	No. of Holes	Hole Diameter	Model No.
76088	1.00"	42	.886"	DA0018, ER20
76089	.50"	144	.314"	DA0030
76090	.75"	105	.472"	DA0020, ER11
76091	.75"	60	.688"	DA0010, ER16
76092	1.50"	16	1.890"	TG150, ER40, 16C
76096	1.00"	39	.985"	CP P3, ER25, TG75, R8
76098	1.25"	36	1.340"	TG100, 5C, ER32
Bilz Holders				
76078	1.25"	52	.768"	Bilz #1
76079	1.50"	16	1.240"	Bilz #2

Model	Description	Page
1018	18" Cantilever Tool Box	21
1022	22" Cantilever Tool Box	21
10350	All Welded Storage Cabinet	32
10491	Pro-Line™ Maintenance Cart	12
10492	Pro-Line™ Maintenance Cart	12
10493	Pro-Line™ Maintenance Cart	12
10494	Pro-Line™ Maintenance Cart	12
10495	Pro-Line™ Maintenance Cart	12
12008	Portable Parts Storage	23
12012	Portable Parts Storage	23
12023	Portable Parts Storage	23
12024	Portable Parts Storage	23
12036	Portable Parts Storage	23
12108	Portable Parts Storage	23
12112	Portable Parts Storage	23
1500	10-Gun KenCraft Gun Cabinet	22
1501	10-Gun KenCraft Gun Cabinet	22
1510	5-Gun KenCraft Gun Cabinet	22
1520	14-Gun KenCraft Gun Cabinet	22
1530	KenCraft Add-on Cabinet	22
1547	KenCraft Pistol Box	22
1550	KenCraft Deluxe Reloading Bench	22
1558	Chip Tray Work Station	29
182	2-Shelf Roller Cabinet Hang-on	16
185	5-Drawer Roller Cabinet Hang-on	16
185X	5-Drawer Roller Cabinet Hang-on	16
2005	5-Drawer Roller Cabinet	21
202	2-Shelf Roller Cabinet Hang-on	16
205	5-Drawer Roller Cabinet Hang-on	16
205X	5-Drawer Roller Cabinet Hang-on	16
220	2-Drawer Portable Tool Chest	21
2600	26" Chest Riser	20
2602	2-Drawer Mechanic's Chest Base	20
2603	3-Drawer Mechanic's Chest Base	20
2604	4-Drawer Mechanic's Chest Base	20
263	3-Drawer Mechanic's Chest	20
266	6-Drawer Mechanic's Chest	19
2700MP	5-Drawer Maintenance Pro™ Chest	10
2701MP	5-Drawer Maintenance Pro™ Chest	10
2702MP	6-Drawer Maintenance Pro™ Cabinet	10
2703MP	6-Drawer Maintenance Pro™ Cabinet	10
2705X	5-Drawer Mechanic's Chest	19
273	3-Drawer Roller Cabinet	14
273KC	3-Drawer KenCraft Roller Cabinet	22
273X	3-Drawer Roller Cabinet	14
275	5-Drawer Roller Cabinet	14
275KC	5-Drawer KenCraft Roller Cabinet	22
275X	5-Drawer Roller Cabinet	14
276KC	6-Drawer Roller Cabinet	22
277	7-Drawer Roller Cabinet	14
277X	7-Drawer Roller Cabinet	14
2805	5-Drawer Mechanic's Chest	20
2805X	5-Drawer Mechanic's Chest	20
2806	6-Drawer Mechanic's Chest	19
28077	7-Drawer Painted Cleanroom Cabinet	33
28085	5-Dr. Stainless Steel Cleanroom Cabinet	33
28087	7-Dr. Stainless Steel Cleanroom Cabinet	33
2812	12-Drawer Mechanic's Chest	19
28197	7-Dr. Stainless Steel Cleanroom Cabinet	33
28220	2-Dr. Stainless Steel Cleanroom Chest	33
28264	4-Dr. Stainless Steel Cleanroom Chest	33
283KC	3-Dr. KenCraft Medium Duty Chest	22
284KC	4-Dr. KenCraft Medium Duty Chest	22
285	5-Drawer Mechanic's Chest	20
285KC	5-Dr. KenCraft Medium Duty Chest	22
285X	5-Dr. Mechanic's Chest/Ball-bearing Slides	20
2902	2-Drawer Mechanic's Chest Base	20
2905X	5-Dr. Mechanic's Chest/Ball-bearing Slides	19
29077	7-Dr. Painted Cleanroom Roller Cabinet	33
2907X	7-Drawer Roller Cabinet/Ball-bearing Slides	9
2912X	12-Dr. Mechanic's Chest/Ball-bearing Slides	9
295	5-Drawer Roller Cabinet	14
295X	5-Dr. Roller Cabinet/Ball-bearing Slides	14
297	7-Drawer Roller Cabinet	14
297LX	7-Dr. Roller Cabinet w/Dr. Interlock	17
297X	7-Dr. Roller Cabinet/Ball-bearing Slides	14
300MP	2-Shelf MP Hang-on Cabinet	10
301MP	2-Shelf MP Hang-on Cabinet	10
302	2-Shelf Roller Cabinet Hang-on Cabinet	16
305X	5-Drawer Maintenance Chest	13
306X	6-Dr. Hang-on Cabinet/Ball-bearing Slides	16
310X	10-Dr. Maintenance Cart/Ball-bearing Slides	13
315X	15-Dr. Maintenance Cart/Ball-bearing Slides	13
3400MP	5-Dr. Maintenance Pro™ Chest	10
3401MP	5-Dr. Maintenance Pro™ Chest	10
3402MP	6-Dr. Maintenance Pro™ Roller Cabinet	10
3403MP	6-Dr. Maintenance Pro™ Roller Cabinet	10
3407X	7-Drawer Roller Cabinet/Ball-bearing Slides	9
3412X	12-Dr. Mechanic's Chest/Ball-bearing Slides	9
348X	8-Dr. Roller Cabinet/Ball-bearing Slides	15
360	10-Drawer Mechanic's Chest	19
3611	11-Drawer Machinist's Chest	18
376X	6-Dr. Roller Cabinet/Ball-bearing Slides	15
378LX	8-Dr. Roller Cabinet w/Dr. Interlock	17
378X	8-Dr. Roller Cabinet/Ball-bearing Slides	15
380MP	2-Shelf MP Hang-on Cabinet	10
381MP	2-Shelf MP Hang-on Cabinet	10
382	2-Shelf Roller Cabinet Hang-on Cabinet	16
386X	6-Dr. Roller Cabinet Hang-on Cabinet	16
3900MP	8-Dr. Maintenance Pro™ Maintenance Cart	11
3901MP	8-Dr. Maintenance Pro™ Maintenance Cart	11
40001	HMS™ Series Housing, Tan	45
40002	HMS™ Series 2" Drawer, Tan	45
40004	HMS™ Series 4" Drawer, Tan	45
40006	HMS™ Series 6" Drawer, Tan	45
40008	HMS™ Series 8" Drawer, Tan	45
40011	HMS™ Series Housing, Blue	45

Model	Description	Page
40095	HMS™ Series 5-Dr. Cabinet, Tan	45
40096	HMS™ Series 6-Dr. Cabinet, Tan	45
40097	HMS™ Series 7-Dr. Cabinet, Tan	45
40102	HMS™ Series 2" Drawer, Blue	45
40104	HMS™ Series 4" Drawer, Blue	45
40106	HMS™ Series 6" Drawer, Blue	45
40108	HMS™ Series 8" Drawer, Blue	45
40195	HMS™ Series 5-Dr. Cabinet, Blue	45
40196	HMS™ Series 6-Dr. Cabinet, Blue	45
40197	HMS™ Series 7-Dr. Cabinet, Blue	45
415	5-Drawer Versa-Cart® Tool Cart	17
415X	5-Dr. Versa-Cart®/Ball-Bearing Slides	17
42001-05	HMS™ Series 5-Dr. Cabinet, Tan	45
42010	HMS™ Series Mobility Kit	45
435	5-Drawer Versa-Cart® Tool Cart	17
435X	5-Dr. Versa-Cart®/Ball-Bearing Slides	17
4400MP	10-Dr. Maintenance Pro™ Maintenance Cart	11
4401MP	10-Dr. Maintenance Pro™ Maintenance Cart	11
4405	5-Dr. Extended Chest/Ball-Bearing Slides	9
4410	10-Dr. Extended Cabinet/Ball-Bearing Slides	9
46000	8-Drawer 46" Benchmark® Chest	8
46001	8-Drawer 46" Benchmark® Chest	8
46002	8-Drawer 46" Benchmark® Chest	8
46003	8-Drawer 46" Benchmark® Cabinet	8
46004	8-Drawer 46" Benchmark® Cabinet	8
46005	8-Drawer 46" Benchmark® Cabinet	8
4800MP	10-Dr. MP Versa-Bench®	11
4801MP	10-Dr. MP Versa-Bench®	11
4804	4-Drawer Versa-Bench®	26
4806	6-Drawer Versa-Bench®	26
4806R	6-Drawer Versa-Bench®	26
4810R	10-Drawer Versa-Bench®	26
50002	2-Panel Toolboard Set, Tan	30
50004	4-Panel Toolboard Set, 30-pc. Hook Set, Tan	30
50012	2-Panel Toolboard Set, Blue	30
50014	4-Panel Toolboard Set, 30-pc. Hook Set, Blue	30
50022	2-Panel Toolboard Set, Gray	30
50024	4-Panel Toolboard Set, 30-pc. Hook Set, Gray	30
50032	2-Panel Toolboard Set, Green	30
50034	4-Panel Toolboard Set, 30-pc. Hook Set, Green	30
50050	Panel Brace Supports	30, 48
50054	Panel Angle Brackets	48
50061-64	Louvered Panel Sets	30
50100	Open Tool Trolley Base	32
50102	Open Tool Trolley, Panels, Hook Set	32
50104	Open Tool Trolley, Panels	32
50230	Toolboard Wall Mounted Cabinet	32
50260	Toolboard Wall Mounted Cabinet	32
50301	Toolboard Mini Workshop Cabinet	32
51002-16	Drawers for 24" x 24" Modular Cabinets	40
5150	Machinist's Chest Add-on Base	18
51902-8	Drawers for 24" x 24" Mobile Cabinets	41
520	7-Drawer Machinist's Chest	18
52002-12	NX Drawers for 30" x 24" Modular Cabinets	39
52103-16	FX Drawers for 30" x 24" Modular Cabinets	39
5220	20-Inch Hand Carry Box	21
526	8-Drawer Machinist's Chest	18
52611	11-Drawer Machinist's Chest	18
5300MP	12-Dr. Maintenance Pro™ Maintenance Cart	11
5301MP	12-Dr. Maintenance Pro™ Maintenance Cart	11
5350MP	Maintenance Pro™ Canopy for 5300MP	11
5351MP	Maintenance Pro™ Canopy for 5301MP	11
56100	Modular Cabinet Workstation Fixed Leg	42
56601-08	Modular Cabinet Workstation Components	42
56721-25	Modular Cabinet Workstation Components	42
5804MP	12-Dr. Maintenance Pro™ Maintenance Cart	11
5805MP	12-Dr. Maintenance Pro™ Maintenance Cart	11
60003-12	Compact Modular Cabinet Drawers	44
60009	Compact Modular Cabinets, Door Assembly	44
60040	Adjustable Shelf, Compact Modular Cab.	44
6006	6-Drawer Versa-Bench®	27
6006R	6-Drawer Versa-Bench®	27
60101	60" Benchmark® Canopy	8
60102	60" Benchmark® Canopy	8
60103	60" Benchmark® Canopy	8
60121	10-Dr. Benchmark® Cabinet	8
60122	10-Dr. Benchmark® Cabinet	8
60123	10-Dr. Benchmark® Cabinet	8
6012E	12-Drawer Versa-Bench®	27
6012ER	12-Drawer Versa-Bench®	27
60125	12-Drawer Versa-Bench®	27
60200	Compact Modular Cabinet Housing	44
60203	Compact Mobile Modular Cabinet	44
60205	Compact Mobile Modular Cabinet	44
60215	Compact Mobile Maintenance Bench	44
60218	Compact Mobile Maintenance Bench	44
60221	Compact Mobile Base Kit	44
60300	Compact Modular Cabinet, Housing	43
60306	Compact Modular Cabinet	43
60307	Compact Modular Cabinet	43
60309	Compact Modular Cabinet	43
60700	Compact Modular Cabinet, Housing	43
60706	Compact Modular Cabinet	43
60708	Compact Modular Cabinet	43
60709	Compact Modular Cabinet	43
60SR	12-Drawer Versa-Bench®	27
61100	Undercounter Storage, Housing	43
61103	Undercounter Storage Cabinet	43
61104	Undercounter Storage Cabinet	43
61202	Adjustable Shelf for 24" x 24" Cabinet	48
61203	Mobile Modular Cabinet, 24" x 24"	41
61209	Mobile Mod. Cab. Housing, 24" x 24"	41
61280	Modular Cabinet Door for 24" x 24" Cabinet	48
61290	Undercounter Storage, Housing	43
61294	Undercounter Storage Cabinet	43
61295	Undercounter Storage Cabinet	43

Model	Description	Page
61300	Modular Cabinet Housing, 24" x 24"	40
61302	Pull-out Shelf for 24" x 24" Cabinet	48
61303	Workstation Base Cabinet, 24" x 24"	40, 42
61305	Pull-out Shelf / Gussets for 24" x 24" Cab.	48
61380	Modular Cabinet Door for 24" x 24" Cabinet	48
61400	Modular Cabinet Housing, 24" x 24"	40
61407	Modular Cabinet, 24" x 24"	40
61480	Modular Cabinet Door for 24" x 24" Cabinet	48
61500	Modular Cabinet Housing, 24" x 24"	40
61509	Modular Cabinet, 24" x 24"	40
61580	Modular Cabinet Door for 24" x 24" Cabinet	48
61700	Modular Cabinet Housing, 24" x 24"	40
61703	Modular Cabinet, 24" x 24"	40, 42
61750	Mobile Modular Cabinet, 24" x 24"	41
61759	Mobile Mod. Cab. Housing, 24" x 24"	41
61780	Modular Cabinet Door for 24" x 24" Cabinet	48
620	3-Drawer Machinist's Chest	18
62202	Adjustable Shelf for 30" x 24" Cabinets	48
62302	Pull-out Shelf for 30" x 24" Cabinets	48
62305	Pull-out Shelf w/ Gussets for 30" x 24" Cab.	48
62400	Modular Cabinet Housing, 30" x 24"	39
62407	Modular Cabinet, 30" x 24"	39
62500	Modular Cabinet Housing, 30" x 24"	39
62509	Modular Cabinet, 30" x 24"	39
62580	Modular Cabinet Door for 30" x 24" Cabinet	48
62600	Modular Cabinet Housing, 30" x 24"	39
62610	Modular Cabinet, 30" x 24"	39
62780	Modular Cabinet Door for 30" x 24" Cabinet	48
63002-8	NX Drawers for 30" x 30" Modular Cabinets	37
63103-16	FX Drawers for 30" x 30" Modular Cabinets	37
63202	Adjustable Shelf for 30" x 30" Cabinets	48
63300	Machine / Work Station Housing, 30" x 30"	37
63302	Pull-out Shelf for 30" x 30" Cabinets	48
63303	Machine / Work Station Cabinet, 30" x 30"	37
63305	Pull-out Shelf w/ Gussets for 30" x 30" Cab	48
63350	Mobile Modular Cabinet, 30" x 30"	41
63359	Mobile Mod. Cab. Housing, 30" x 30"	41
63380	Modular Cabinet Door for 30" x 30" Cabinet	48
63400	Modular Cabinet Housing, 30" x 30"	36
63405-12	Modular Cabinet Combinations, 30" x 30"	36
63416-19	Modular Cabinet Combinations, 30" x 30"	36
63480	Modular Cabinet Door, 30" x 30"	48
63600	Modular Cabinet Housing, 30" x 30"	36
63605-6	Modular Cabinet Combinations, 30" x 30"	36
63609-12	Modular Cabinet Combinations, 30" x 30"	36
63616-21	Modular Cabinet Combinations, 30" x 30"	36
63680	Modular Cabinet Door, 30" x 30"	48
63902-08	Drawers for 30" x 30" Mobile Modular Cabinets	41
64103-16	FX Drawer for 44" x 30" Modular Cabinets	38
64202	Adjustable Shelf for 44" x 30" Cabinets	48
64302	Pull-out Shelf for 44" x 30" Cabinets	48
64305	Pull-out Shelf w/ Gussets for 44" x 30" Cab	48
64400	Modular Cabinet Housing, 44" x 30"	38
64406-10	Modular Cabinet Combinations, 44" x 30"	38
64480	Modular Cabinet Door, 44" x 30" Cabinets	48
64600	Modular Cabinet Housing, 44" x 30"	38
64606-10	Modular Cabinet Combinations, 44" x 30"	38
64680	Modular Cabinet Door, 44" x 30" Cabinets	48
66200	Modular Cab. Workstation Adjustable Leg	42
66606	Modular Cab. Workstation Foot Rest	42
66726	Modular Cab. Workstation Foot Rest	42
68013	Mobile Workstation Bottom Shelf	43
68911	Mobile Work Station Combination	43
68913	Mobile Work Station Combination	43
69023-24	Divider Kit for Compact Mod. Drawers	44
69063-64	Divider Kit for Compact Mod. Drawers	44
69069-94	Divider Kit for Compact Mod. Drawers	44
69104	Stationary Workstation Combination	42
69140	Stationary Workstation Combination	42
69146	Stationary Workstation Combination	42
69148	Stationary Workstation Combination	42
70005	Universal Tool Tray Brackets	50
70020-27	HSK-A System Sockets	50
70030-33	Kennametal KM [®] Plastic Sockets	50
70051-53	Plastic Sockets	50
70056-59	Plastic Sockets	50
70060	Tool Tray	50
70062	Socket Frame for ToolKart [™]	51
70063-67	Plastic Sockets	50
70070	Tool Tray	50
70084-85	CutterKart [™] Tool Holder Plate	51
70090-96	Plastic Socket	50
70100	Plastic Socket	50
71103-08	Sandvik Capto [™] System Plastic Sockets	50
72001	ToolKart [™]	51
72006	Tool Trolley Add-on Steel Shelf	51
72007	NC / CNC Tool Trolley	51
72008	Tool Trolley Steel Shelf	51
72010	Tool Trolley Steel Shelf	51
72045	Tool Trolley Add-on Steel Shelf	51
73030	Pre-configured ToolKart [™]	51
73040	Pre-configured ToolKart [™]	51
73050	Pre-configured ToolKart [™]	51
73154	Pre-configured NC / CNC Tool Trolley	51
73240	Pre-configured ToolKart [™]	51
73250	Pre-configured ToolKart [™]	51
74021	Three-tiered Bench Stand	50
74023	Two-tiered Bench Stand	50
74066	Four-panel 77" High Tool Storage Rack	52
74075	Back Panel for 77" High Tool Storage Rack	52
74076	Door for 77" High Tool Storage Rack	52
74168	Side Panel Set for 77" High Tool Storage Rack	52
74408	Side Panel Set for 32" High Tool Storage Rack	52
74413	53" Wide Document Shelf	52
74414	79" Wide Document Shelf	52
74415	53" Wide Wood Top	52
74416	79" Wide Wood Top	52

Model	Description	Page
74419	53" Long Table Support	52
74422	79" Long Table Support	52
74433	Door for 32" High Rack	52
75112	Pre-configured Tool Storage Rack	52
75117	Pre-configured Tool Storage Rack	52
75122	Pre-configured Tool Storage Rack	52
75413	32" High Tool Storage Rack	52
75601	Pre-configured Ministore [®]	52
76078-79	Bilz Holders	53
76088-98	Collet Holders	53
76208	Adjustable Tool Holder Kit	53
76209	Socket Partition for Modular Cabinet Drawers	37
76270-73	Drawers for Tool Storage Racks	53
76305	Pull-out Shelf for Tool Storage Racks	53
76311	Plastic Groove Kit	53
76314	Pull-out Frame for Tool Storage Racks	53
76531	Adjustable Tool Holder Kit	53
77263-66	Plastic Box Kits	53
77277-98	Divider Sets For Tool Storage Racks	53
80813-15	Drawer Liner for Modular Cabinets	47
80991-92	Felt Drawer Liner Kit for Modular Cabinets	47
85532	Square 1 [™] Toolholder System	23
85570	Square 1 [™] Toolholder System	23
91066-80	Drawer Height Extensions for Modular Cabinet	48
91102-91344	Drawer Divider Sets for 24" x 24" Mod. Cabinets	40
92122-92744	Drawer Divider Sets for 30" x 24" Mod. Cabinets	39
93102-93774	Drawer Divider Sets for 30" x 30" Mod. Cabinets	37
95213-95644	Drawer Divider Sets for 44" x 30" Mod. Cabinets	38
96162-64	Plastic Box Sets for 24" x 24" Modular Cabinets	47
96252-54	Plastic Box Sets for 30" x 30" Modular Cabinets	47
96282-84	Plastic Box Sets for 24" x 24" Modular Cabinets	47
96353-54	Plastic Box Sets for 44" x 30" Modular Cabinets	47
96372-74	Plastic Box Sets for 30" x 30" Modular Cabinets	47
96492-64	Plastic Box Sets for 24" x 30" Modular Cabinets	47
96502-04	Plastic Box Sets for 30" x 30" Modular Cabinets	47
96812-14	Plastic Box Sets for 30" x 30" Modular Cabinets	47
99001-04	Modular Cabinet Bottom Shelves	48
99012-54	Modular Cabinet Drawer Partitions	46
99103-99344	Modular Cabinet Drawer Subdividers	46
99500-05	Plastic Groove Trays and Dividers	47
99511-13	Prism Racks	46
99521-28	Milling Tool Holders	47
99531-33	Tool Holders / Angular Rests	46
99540-43	Bottom Support Brackets for NC / CNC Tool Trays	48
99572-94	Plastic Boxes	47
99606-99746	Fork Lift Bases for Modular Cabinets	48
99820-48	Toolboard Steel Tool Holders	31
99850	Mobile Workstation Drawer	43
99852-53	Toolboard Tool Holder Sets	30
99876	Toolboard Cable Loop Hook Sets	30
DO26	Workstation Security Door	28
DR264X	Workstation Drawer Package	29
DR265	Workstation Drawer Package	29
DR265X	Workstation Drawer Package	29
DS1	Roller Cabinet Foldaway Shelf	17
K20	Professional Tool Boxes	21
K24	Professional Tool Box	21
K32X	Professional Tool Box	21
MC22	Machinist's Chest Base	18
MC28	Machinist's Chest Base	18
S5405X	5-Drawer Workstation w / Ball-bearing Slides	28
S5410X	10-Drawer Workstation w / Ball-bearing Slides	28
TS261X	1-Drawer Tool Stand w / Ball-bearing Slides	29
TS265X	5-Drawer Tool Stand w / Ball-bearing Slides	29
VBLEGS	Versa-Bench [®] Stationary Legs	26
VBT48	Versa-Bench [®] Towing Package, 48" Benches	26
VBT60	Versa-Bench [®] Towing Package, 60" Benches	26
W5405X	5-Drawer Workstation w / Ball-bearing Slides	28
W5410X	10-Drawer Workstation w / Ball-bearing Slides	28
WC28	Wall Storage Cabinet	29
WS5405	5-Drawer Workstation w / Steel Top	28
WS5410	10-Drawer Workstation w / Steel Top	28
WT48	Versa-Bench [®] 48" Maple Top	27
WT60	Versa-Bench [®] 60" Maple Top	27
WT6024	60" x 24" Work Bench Maple Top	44
WT6030	60" x 30" Work Bench Maple Top	42
WT7224	72" x 24" Work Bench Maple Top	44
WT7230	72" x 30" Work Bench Maple Top	42
WW5405	5-Drawer Workstation w / Friction Slides	28
WW5410	10-Drawer Workstation w / Friction Slides	28



Kennedy



Benchmark



Pro-line



Maintenance Pro

Steel Toolboard Systems



Stainless Steel Cabinets



Modular Storage Systems

