



COMPLETE  
METALWORKING  
SOLUTIONS

(800) 991-4225

www.ahbinc.com

ISO Certified

customerservice@ahbinc.com

**FISSLER**  
**ELEKTRONIK**

# AKAS<sup>®</sup>

Press brake  
safety system

Laser actuated AOPD  
in compliance with  
EN 12622

OEM and Retrofit

Installed safety  
intelligence

Compatible with  
all control units

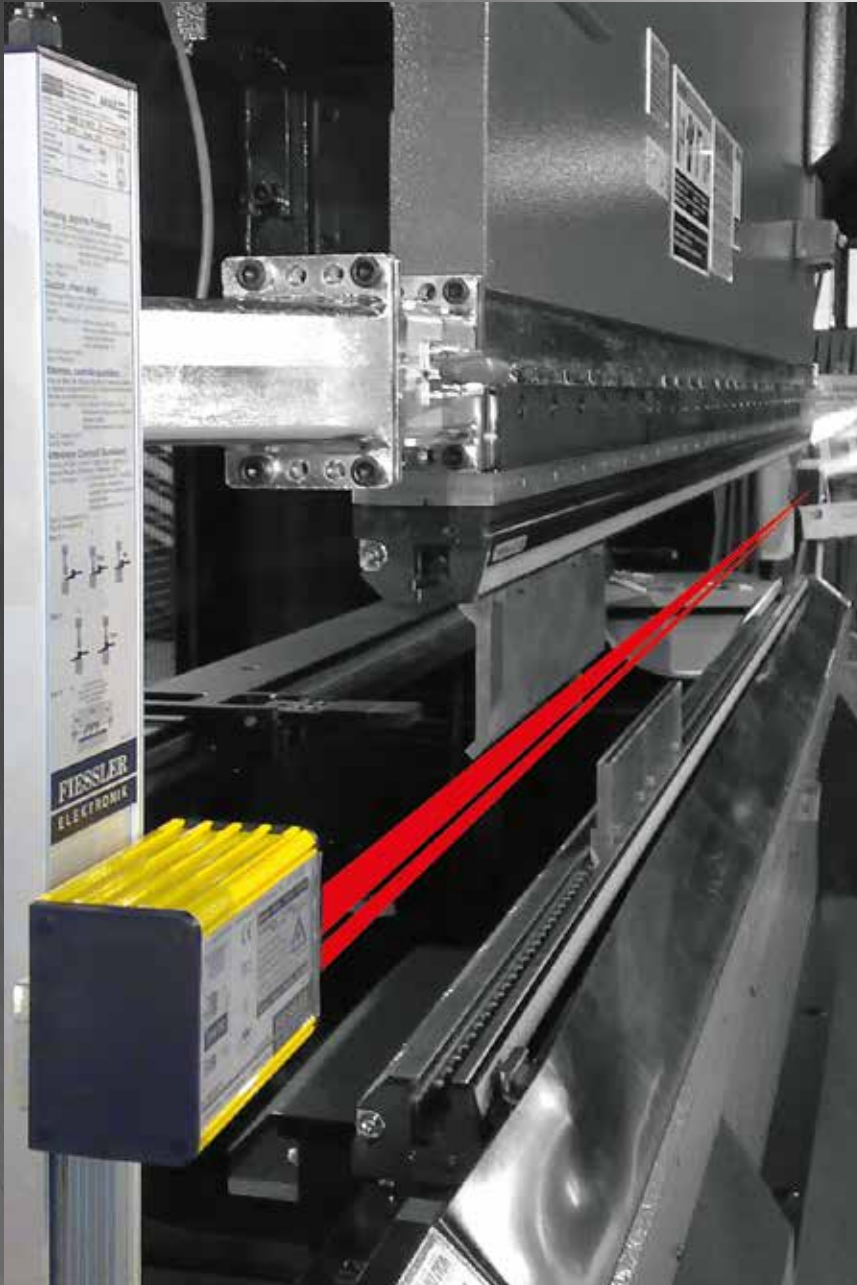

WEBSITE

# AKAS<sup>®</sup>



## Our vision:

We protect people from accidents and offer convincing high quality innovative, user-friendly safety solutions for the customers and are always willing to provide the customer with help and advice.

## Our passion:

Fiessler Elektronik has been producing optoelectronic components for the industry since 1956. The resulting development and production of the first fully electronic safety light curtain and safety light grid on the basis of the transmitter-receiver principle began in 1965.

Nearly 30 years later in 1996, Fiessler Elektronik was the first manufacturer worldwide to introduce the groundbreaking innovation of a specially following safety solution for pressbrakes (AKAS®).

completed its solution for pressbrakes with its programmable FPSC safety PLC.

Permanent product care and new developments in dialogue with our customers is what guarantees perfect solutions and high quality products. Certifications, quality monitoring and prototype tests in accordance with worldwide standards are a matter of course for Fiessler Elektronik.

In 2005, Fiessler Elektronik



Company  
description

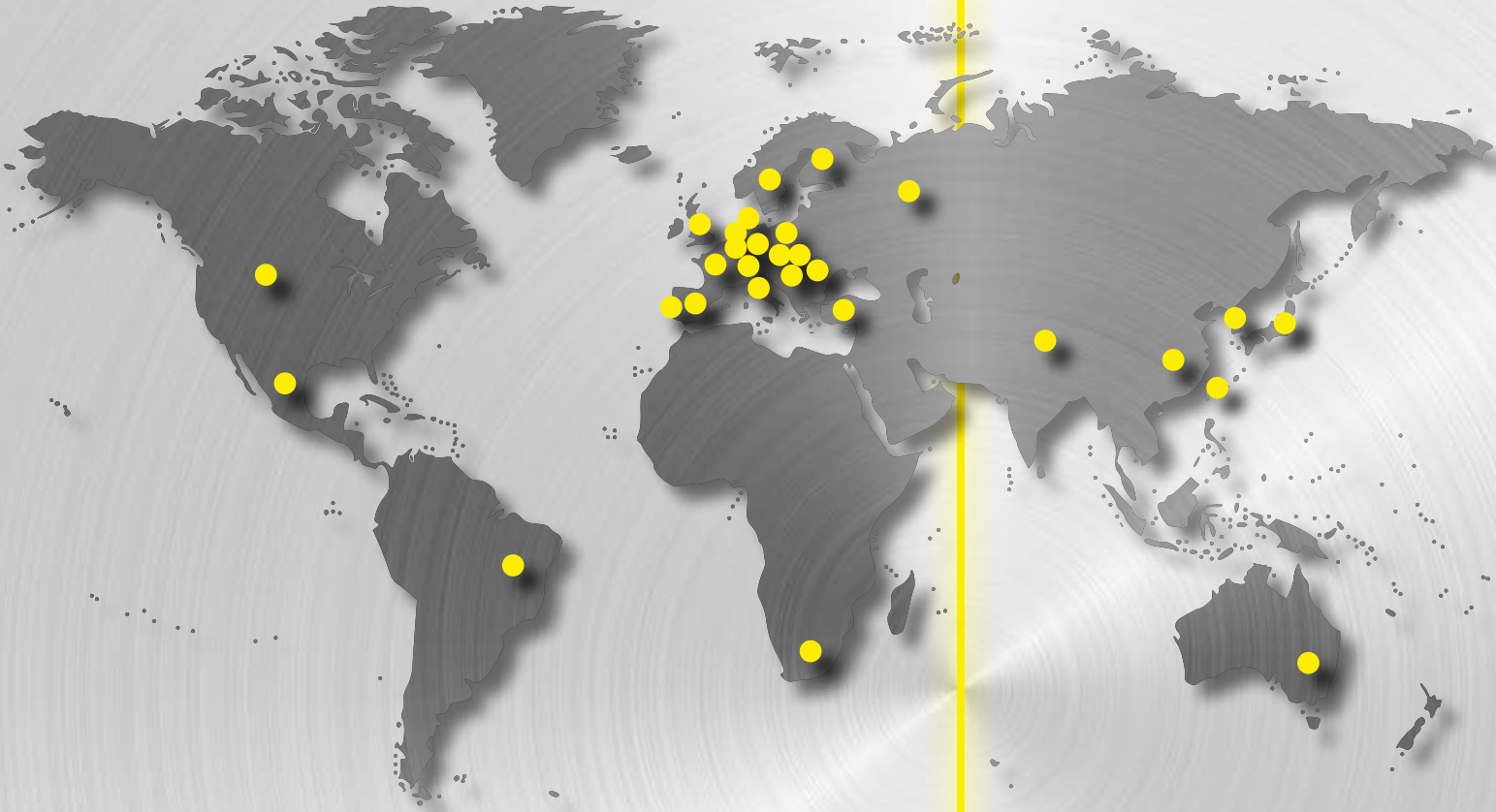

## Service – worldwide

Fiessler Elektronik serves customers in all industrial regions of the world. The service network of Fiessler Elektronik is available in more than 30 countries.

These support points provide effective support to machine manufacturers as well as end users.



Branches

DIN EN 12622,  
CE  
B11.3  
.....

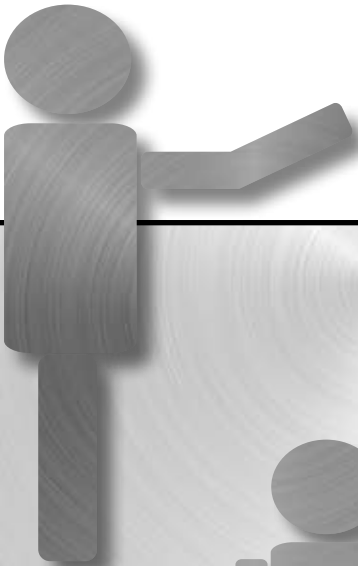

## use our experience:

The AKAS® safety systems of Fessler Elektronik are in daily industrial use in more than 25,000 pressbrakes.

The Fessler Elektronik competence centre for the protection of pressbrakes, swivel bending machines, shears and other sheet metal processing machines supports our customers in implementing this machine-specific safety solution.

A highly-efficient engineering team offers full integration service and safety advice on new and used machines. All services are offered, from circuit diagram integration to installation and commissioning (among other things by an international network of authorized integration partners). These services are supported by a database consisting of more than 800 processed hydraulic and electric circuit diagrams of pressbrakes of various manufacturers.

Members of the competence centre also contribute significantly to the further development of international norms and standards, such as DIN EN 12622, B11.3, NR12...



Training

# Type selection

**FISSLER**  
**ELEKTRONIK**

## finding the optimal device:

Fiessler Elektronik safety solutions for pressbrakes consist of an optical safety device and a safety control. The components are CE type tested, (c)UL listed and comply with many more national and international standards.

### Operating principle of optical protective device:

A three-dimensional laser protective field between the AKAS® transmitter and AKAS® receiver monitors the hazardous area underneath the clamped upper tool.

The special type of beam configuration guarantees protection directly up to hazardous area.

Depending on the machine performance („stopping distance of the blanking press“), the press can be operated at high speed. Shortly before the upper tool touches the sheet metal to be bent.

The result: maximum safety at maximum productivity.

The AKAS® press brake safety system is offered in various versions and can therefore be optimally adapted to the respective situation.

Safe area: Protected zone (any intervention into this area shuts down the closing movement of the press).



### AKAS® 3PM

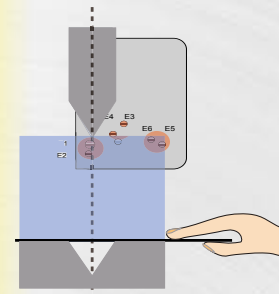

Fast speed up to clamping point

### AKAS® 3PF

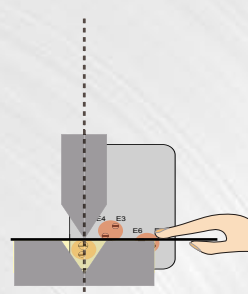

### AKAS® 3M

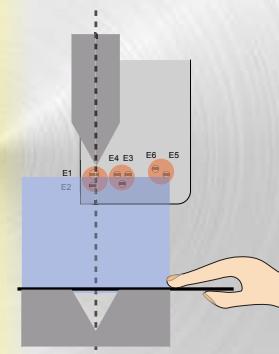

Fast speed up to 5 mm

### AKAS® 3F

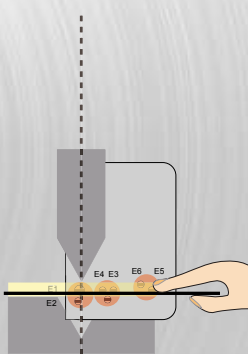

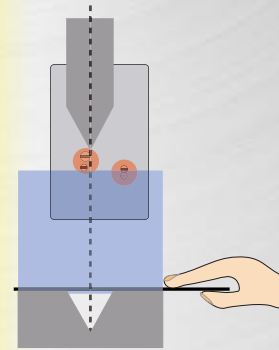

### AKAS® IIM

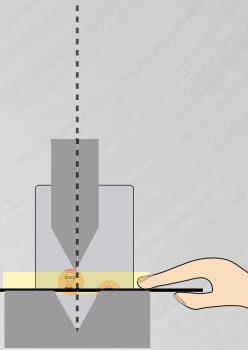

Fast speed up to 10 mm

### AKAS® IIF



 Press in fast speed  
 Press in slow speed



Description of AKAS

## Exactly right for every bending type

The AKAS® safety system provides the user with three easy to select operating modes:

### Flat bending mode

The basic mode of the AKAS® safety system is the flat bending mode. During the flat bending mode, the protective field in front of the operator as well as the vertical protective field directly below the tool tip is active. This means the entire 3-dimensional protective field below the tool tip protects the operator during the complete closing movement of the press.

### Box bending mode

The operator selects the box bending mode when box-shaped parts are to be bent. For this operating type, the in front of the operator part of the laser protective field is muted/blanked for the duration of the box bending stroke. The press can be closed without hindrance even when the front part of the protective field is interrupted by the turned up edges of a box. Operator protection is guaranteed by the vertical protective field on the bending line and by the slightly higher switching point from fast speed to bending speed (only applies to AKAS® 3 and AKAS® 3P).

The AKAS® safety system thus offers full protection from rapid intervention shortly before the press closes completely even in this operating mode.

### Bending of wavy material

This operating mode enables the bending of wavy material or even edge bending within a closed box.

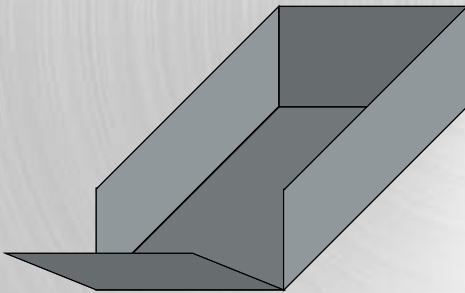
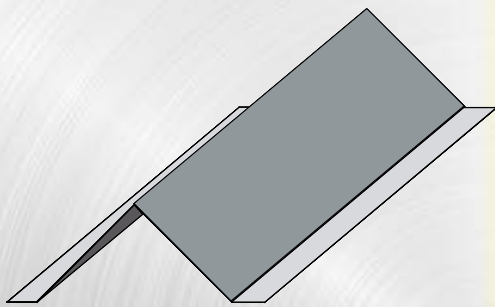

AKAS  
Film

## AKAS® fully automatic adjustment

Different tools can be used at pressbrakes, depending on the application. To enable the necessary adjustment after changing tools with differently sized tools without losing time, the AKAS® system has a fully automatic electromotive support for the transmitter and receiver.

Version	M (Safety-PLC required)	F (integrated safety control in the AKAS® receiver)	150 <sup>1)</sup>	190 <sup>1)</sup>	290 <sup>1)</sup>	390 <sup>1)</sup>	490 <sup>1)</sup>	/8 (increased range)
AKAS® II	M	F	150	190	290	390	490	/8
AKAS® 3								
AKAS® 3P	M	F	150	190	290	390	490	

1) (Traversed distance of electromotive supports) for an over tool difference between the highest and lowest top tool of xxx mm

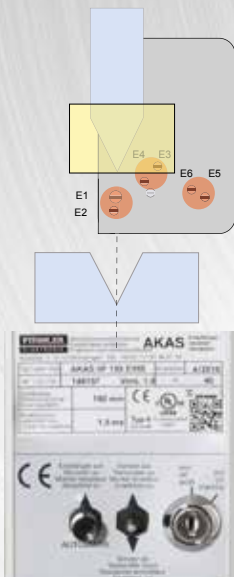

### AKAS® with fully automatic motor adjustment:

To optically broaden the tip of the top tool, a magnetic lamina is fastened to the upper tool.

When the automatic switch is pressed, the transmitter moves to the optimal monitoring position.

The receiver follows this movement.



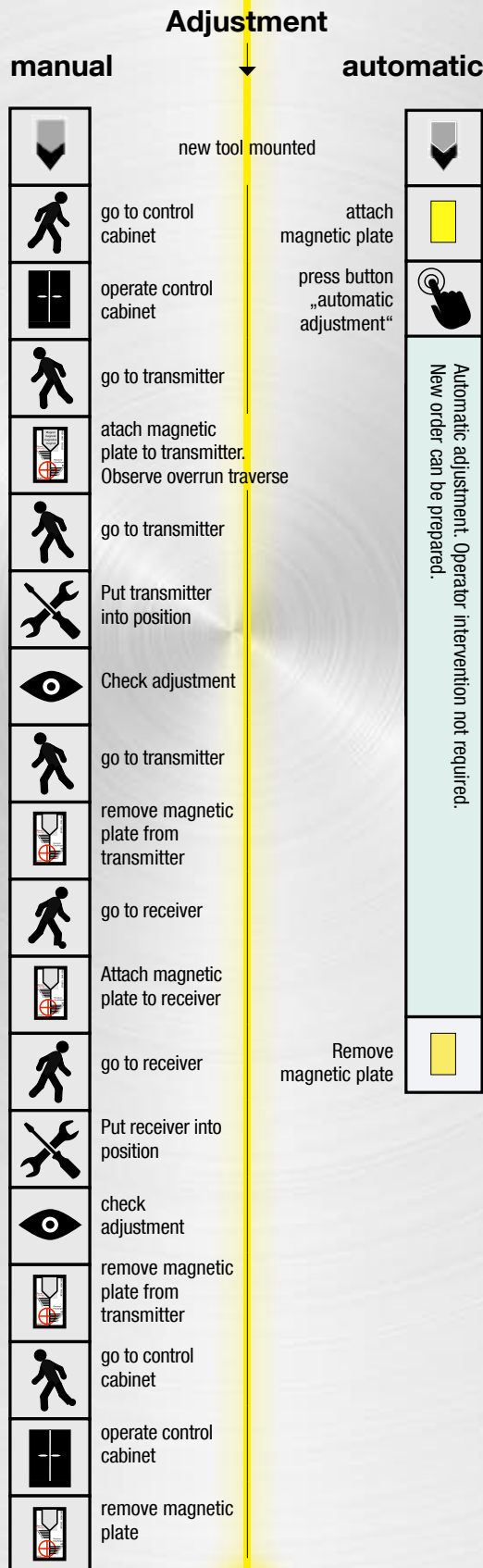

## High savings potential thanks to automatic adjustment

As the only provider of following safety systems for pressbrakes, Fiessler Elektronik offers fully automatic adjustment after a tool change. The otherwise required adjustment time can be used for other activities, e.g. such as providing the material or programming the machine parameters. This means time savings and productivity gain.

The AKAS® transmitter and AKAS® receiver for this version are equipped with a fully automatic electromotive support.

The adjustment process for a new upper tool is activated by pressing the key-operated switch and is started by pressing the „Automatic“ button. During this process, the AKAS® transmitter and AKAS® receiver fully automatically adjust to the clamped upper tool.

The otherwise required adjustment time can be used for other activities, e.g. such as providing the material or programming the machine parameters. According to the machine performance („overrun traverse of the pressbrake“), the distance of the AKAS® transmitter and receiver to the clamped top tool in the AKAS® receiver support is programmed to achieve maximum productivity of the blanking press with optimum safety.

This fully automatic adjustment process also definitively prevents the operator from making an incorrect adjustment.

Various holder systems are available for the mechanical mounting of the AKAS® transmitter support and the AKAS® receiver support.



# The holders

**FISSLER**  
**ELEKTRONIK**

## The right holder for every machine

### From practical experience for practical application

No two press brakes are exactly the same.  
The mounting holders are subject to high requirements:

- variable mounting option
- adapters for optimal adjustment
- great stability and torsional strength
- versatile adjustment possibility
- precise repeating accuracy for swivelling and shifting versions.

- mounting holder for all AKAS® with support.
- comprehensive fastening and adjustment options.
- swivelling adapter. Permits the AKAS® to be swung out of the way e.g. during tool change.

- sliding adaptor permits the sliding of the AKAS® during tool change

- mounting holder for positioning the AKAS® LC without support.
- manual height movement for different tool sizes.
- marking stops for simple reproduction of already used tools.
- clamping protection while driving up through friction brake.



AKAS  
holders

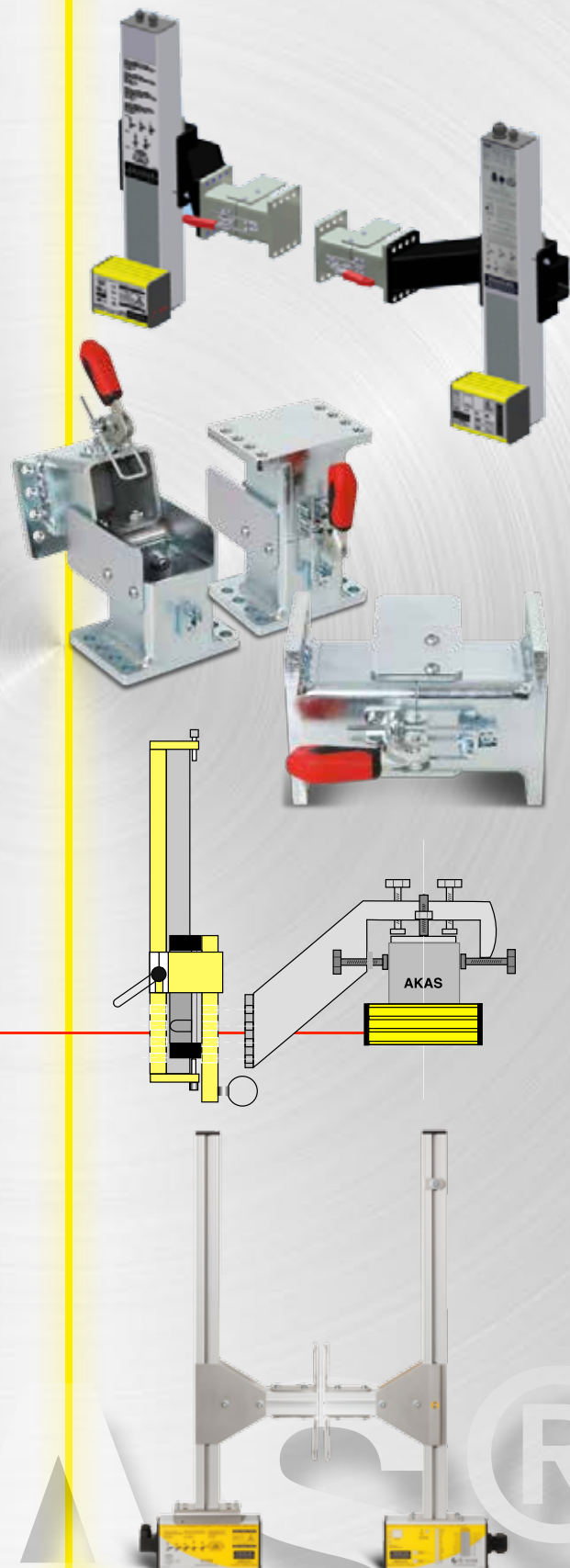

Overview:

AKAS® for manual mounting



**AKAS®  
with manual  
adjustment**



LC holder

Version	M (Safety PLC required)	F (integrated safety control in the AKAS® receiver)	/8 (increased range)
AKAS® LC II	M	F	/8
AKAS® LC II V <sup>1)</sup>	M	F	vertical (p. 18)

1) AKAS® LC V - Protection of compact pressbrakes - see p. 18.

manual adjustment for infrequent tool change:

## AKAS® holder for manual adjustment

The AKAS® pressbrakes protection system in a version without fully automatic electromotive support is available for applications which always work with the same or equal-height upper tools. The manual adjustment also enables adjustment to the respectively clamped upper tool.

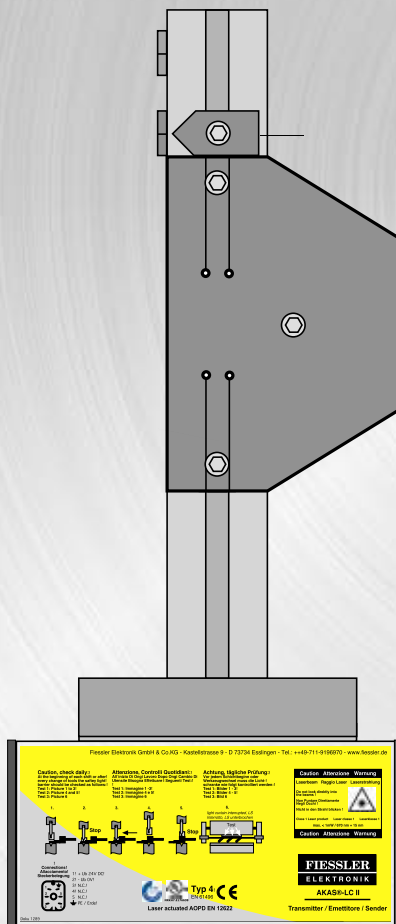

AKAS® transmitter and AKAS® receiver with this version are mounted to a manually adjustable AKAS LC holder.

Manually shifting the AKAS® transmitter and AKAS® receiver adjusts the system to the respective top tool.

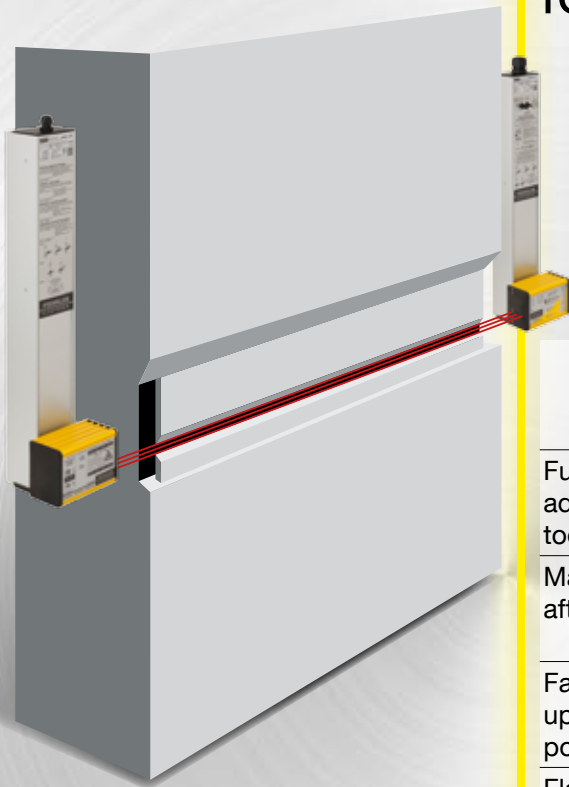

## Optical safety systems for pressbrakes

	AKAS® II	AKAS® 3	AKAS® 3P	Safety light curtains	
				BLVT	BLVT
Fully automatic adjustment after tool change	✓	✓	✓	4	4
Manual adjustment after tool change	LC <sup>1</sup>			4	4
Fast speed up to clamping point possible			✓	✓	✓
Flat bending mode	✓	✓	✓	✓	✓
Box bending mode	✓	✓	✓		
PSDI <sup>3</sup> cycle mode				✓	✓
Tandem solution	LC <sup>1</sup>			✓	✓
Integrated safety functions	F <sup>1</sup>	F <sup>1</sup>	F <sup>1</sup>	EDM	EDM
Max. length of upper tool 6 m	✓	✓	✓	✓	✓
Max. length of upper tool > 6 m	✓ <sup>2</sup>	✓ <sup>2</sup>		✓	✓
Max. range up to 30 m				✓	✓

1 version design

2 in version /8

3 PSDI presence sensing device initiation

4 not necessary as related to product

## FPSC safety PLC

### Type selection

FPSC (Fiessler Programmable Safety Centre):

The FPSC safety PLC enables an optimal OEM integrated solution for integrating the AKAS® safety system. „High Speed“ I/O short response time enables maximum productivity of the pressbrake.

The FPSC safety PLC assumes all safety-related machine tasks. Thanks to the free programming, the respective parameters can be optimally adapted to the machine situation.

The integrated interface displays the status messages on the terminal screen of the machine control or over an additional HMI („Human Machine Interface“).



### FPSC properties:

- 2 counter inputs for Y1/Y2 linear scales for permanent speed monitoring. The counter inputs also help realize overrun traverse monitoring.
- 36 safe inputs, expandable
- 16 safe outputs, expandable
- Applications („software blocks“) for all safety applications at a pressbrake.
- Connectivity of optical safety systems such as AKAS®, safety light curtains, two-hand controls, ...
- Interface for communication with all current CNC control units
- Connectivity for HMI („Human Machine Interface“)
- PSDI Mode
- Solutions for tandem press protection
- I/O expansions through additional modules



FPSC

## Overview

	FPSC-B-C-S	FPSC-AD-C-S	AMS3/G + AKAS® F		
Safe inputs	36	36	14		
Safe outputs	16	16	9		
Expandable I/O over decentralized		X			
I/O modules	2	2	2		
Counter inputs	✓	✓	✓		
Interface to CNC control unit	0,5 ms	0,5 ms	1,5 ms		
Reaction time					
Safety function	✓ in combination with optical safety systems (AKAS®, safety LC)	✓ in combination with optical safety systems (AKAS®, safety LC)	✓		
Finger protection	✓	✓	✓		
EDM	✓	✓	✓		
Safety foot pedal	✓	✓	✓		
E-stop, emergency stop	✓	✓	✓		
Speed monitoring	✓	✓	✓		
Overrun traverse monitoring	✓	✓	✓		
Safety door monitoring	✓	✓	✓		
Two-hand control	✓	✓			
PSDI cycle mode	✓				
In combination with safety light curtain	✓				
<b>In combination with safety curtain</b>					
Tandem operation	✓	✓			
Combination mode finger protection (AKAS®) and PSDI	✓				
In combination with AKAS® and safety light curtain	✓				
<b>In combination with AKAS® and safety light curtain</b>					
Selector switch operation	✓	✓			
Optical safety device				Fully automatic adjustment after tool change	Manual adjustment
<b>Optical safety device</b>					
AKAS® II	M <sup>1</sup>	M <sup>1</sup>	F <sup>1</sup>	✓	LC <sup>1</sup>
AKAS® 3	M <sup>1</sup>	M <sup>1</sup>	F <sup>1</sup>	✓	
AKAS® 3P	M <sup>1</sup>	M <sup>1</sup>	F <sup>1</sup>	✓	
ULVT/BLVT safety light curtain	✓	✓			

1) version

# The right control unit

**FISSLER**  
**ELEKTRONIK**

## FPSC and AMS

### Safety SPS FPSC

If the AKAS® safety system is integrated via the safety PLC FPSC, the status messages are displayed through the integrated interface on the screen of the machine control or over an additional HMI („Human Machine Interface“).

**Worldwide technical online support is also possible.**

Each CPU and every single I/O has display LEDs which enable a simple initial diagnosis directly at the safety PLC FPSC.

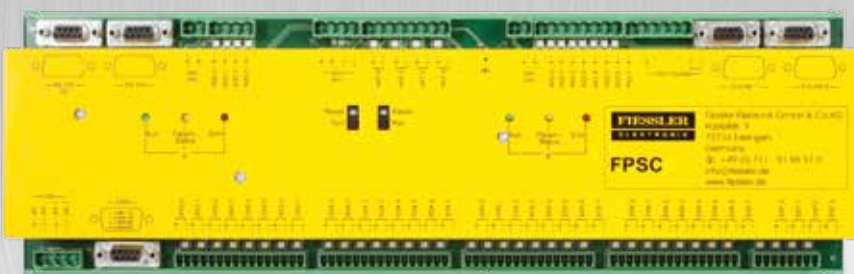

AMS

### Interface AMS

For pressbrakes equipped with the AKAS®\_F system (integrated safety control in the AKAS® receiver), the Interface AMS offers secure permanent speed monitoring. The AMS3/G system has 2 counter inputs for Y1/Y2 linear scales.

As interface for retrofitting, this AMS3 interface is also available with two magnetic tapes and matching sensors. This enables an easy retrofit installation. The speed of the closing movement is permanently recorded by these sensors and evaluated by means of the AMS interface.

## Simple diagnosis

### Simple status indicator

The AKAS® receiver is equipped with status indicators. A simple on-site diagnosis is possible with these LED indicators.

The AKAS® receiver also has an interface for displaying the status directly on the screen of the control unit or via HMI in text format.



### HMI text displays

broad product range of displays in text and touch screen versions for direct connection to FPSC and AKAS® systems.



HMI text displays



# Individual solutions

**FISSLER**  
**ELEKTRONIK**

## Optimized application for tandem presses

### Protection of tandem presses

Fiessler Elektronik developed a special solution for the protection of tandem systems. With this solution it is possible to safely bend the edges of small parts in single operation as well as large or long parts in tandem operation.

In stand-alone operation, both pressbrakes are protected with the AKAS®-LC safety system. Since there is very little room between the two presses, Fiessler Elektronik developed a special holder that will mount both the AKAS® transmitter as well as the AKAS® receiver between the two presses.

In tandem use, both presses together are operated as connected machine. The safety of the machine operator(s) is provided through a safety light curtain BLVT with blanking function across the entire front side of the tandem system.

An especially narrow holder allows the AKAS® to be mounted between both machines. The tandem presses can consequently be used like individual presses.

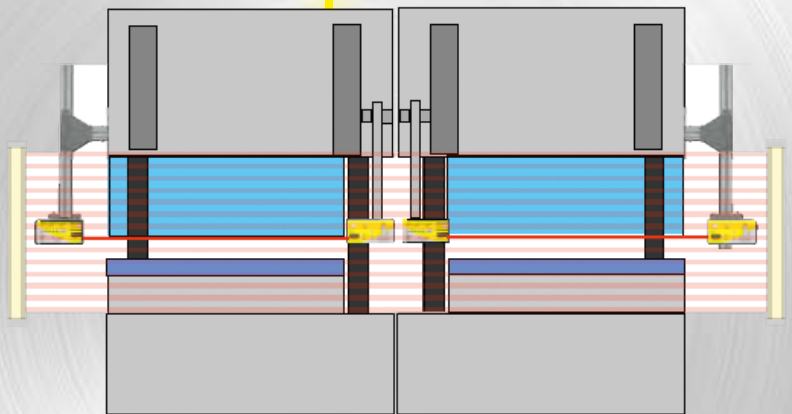

If the entire width of the machine is required, the bending tools will be extended at the ram. The AKAS® is deactivated. The operator is now protected by the light curtain.

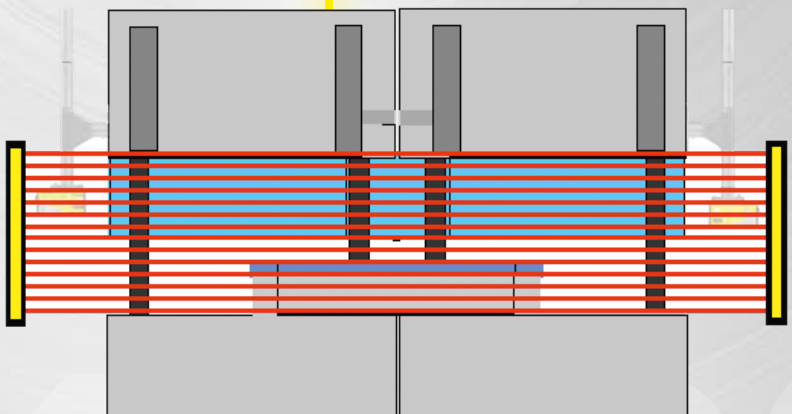

News

## Optimized applications for compact presses

### Protection of compact blanking presses

Compact blanking presses with a maximum working length of 1,300 mm are used for small dimension workpieces with slim wall thickness. The minor required space is one of the advantages of these systems. In addition, these machines also feature an ergonomic seated workplace and very close work at the bending line. But the operating personnel are constantly exposed to the hazardous area as a consequence. A safety device which permits safe work in this area is therefore absolutely mandatory. The AKAS® laser safety system allows the safe bending of edges of small parts as well as workpieces with different geometries.

The press brake protection system LCII \_V features a compact design. The safety device consists of a transmitter and a receiver. Thanks to special optics, the receiver and the transmitter add only very minor bulk to the right and left of the top tool. This in turn means no significant space requirement. The compactness of the system is thus retained. Blanking presses with a bar length of up to 1,300 mm can be monitored with this 3-dimensional laser protection field underneath the upper tool.

The **AKAS®-LC-II-F-V** system, specifically developed for the protection of small blanking presses.

An angular optical system diverts the laser beam by 90 degrees. This permits the housing to be mounted upright in a space-saving position. Safety and high productivity now also for small compact presses.



## High productivity, fast closing speed

### The innovative generation

- AKAS® press brake protection – permanent product care

### Very short response time

- minimal run-on distance.
- significantly higher fast speeds of presses possible.
- high productivity of the press as a result.

### Maximum safety

- due to specially arranged beams during flat bending as well as box bending.
- optimal bending frequencies.

### Integrated safety functions (F)

- option to directly connect and monitor the foot pedal, emergency stop button, safety switch for left and right safety door, back area protection, monitor of safety valves

### Increased productivity

- compared to previous solutions, absolute minimal work speed distance during bending of flat material through special configuration of laser beams.

### User friendly

- fully automatic adjustment to other tool sizes, resulting in low safety responsibility for the machine operator during tool change.
- box function without intermediate stop and unnecessary foot pedal sequences.

### Time savings

- compared to manually adjustable systems during tool change

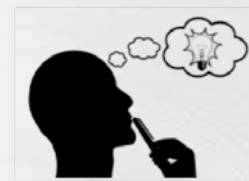

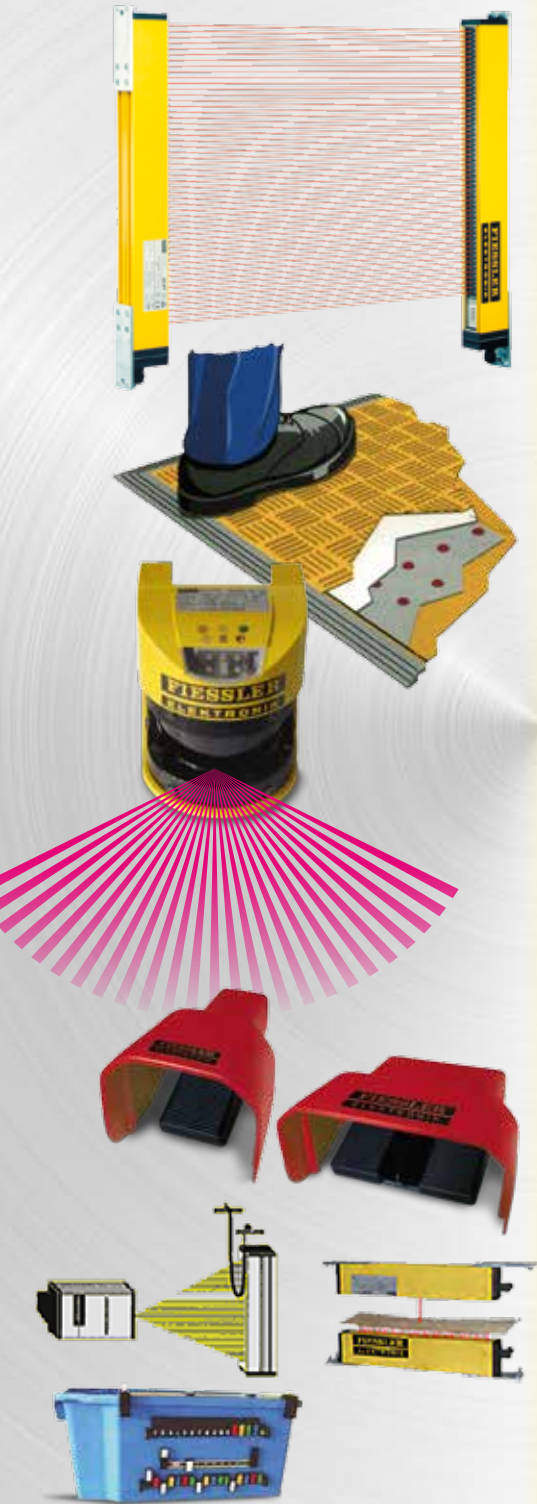

## innovative solutions

### Safety light curtains

Cat 4, SIL 3, PL e  
Protective field height up to 2,500 mm  
High range up to 60 m  
Finger or hand protection  
Very short response time as of 2 ms  
Switching device integrated  
Blanking and cascading

### Safety foot mats

Type 3, SIL 2, PL d  
individual sizes and shapes  
Series connection of up to ten mats  
Surface in plastic, aluminium or stainless steel  
Capacity of up to 2,000 N  
High safety through closed-circuit protection

### Safety laser scanner

Cat 3, SIL 2, PL d  
Simple assembly  
Protective field 4 m, range 7 m  
Warning field 15 m  
Measuring field 50 m range  
Several areas programmable

### Safety foot-switch

single or double pedal

### Control, measure, regulate

Measuring light curtains  
Hole detection devices  
Directional counting light barriers  
Loop sensors  
Encoding strips