



**COMPLETE
METALWORKING
SOLUTIONS**

(800) 991-4225

www.ahbinc.com

ISO Certified

customerservice@ahbinc.com

Clausing Colchester Lathes

*A Line of Precision, High Performance
Variable Speed and Geared Head Lathes*

*Celebrating Over 106 Years
in the Machine Tool Business*



**13", 15", 18", 21", 26" & 32" Swing
Variable Speed Lathes
13" & 15" Swing Geared Head Lathes**

TURNING

Clausing/Colchester 13" (320mm) 15" (400mm) Swing, Variable Speed Lathe



Standard Features...

- State-of-the-art AC Spindle Drive features surface mount technology to give compact size and high reliability
- Interlocked end guard door for easy access for maintenance and changing end train gears
- Faster thread cutting - Reversal of the leadscrew with the spindle running at low speed
- An easy-to-read index plate, makes it simple to select the proper feed or threads
- Three headstock gear ranges produce a wide spread of constant power - 33 to 1 - better than most CNC lathes
- Infinitely variable spindle speeds displayed on headstock
- Dynamic spindle brake via the inverter
- Spindle bearings, gears and shafts are lubricated by a forced lubrication system
- Precision Gamet tapered roller spindle bearings
- Chuck guard with limit switch
- Carriage ways coated with "Moglice" PTFE for minimal bedwear and longer machine life
- Saddle mounted chip guard and full rear splash guard
- Extra wide heavy-duty cast iron bed with triangular webs for torsional stiffness and excellent chip clearance
- Heavy-duty tailstock with extra heavy-duty quill
- Single piece leadscrew cover protects leadscrew from chips
- Large capacity rollout chip bin for easy chip disposal
- All bedways are induction hardened and precision ground
- Heavyweight cast iron bases provide the maximum support for the bed combined with sloping top surfaces to prevent the accumulation of coolant

13" & 15" Variable Spindle Drive Power Charts

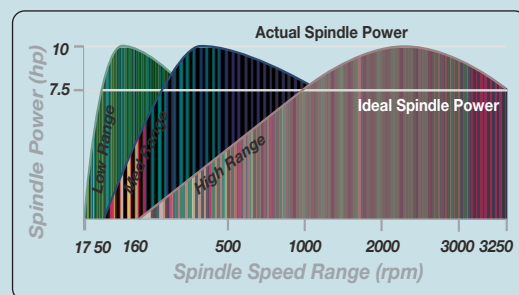

13 inch VS Lathe

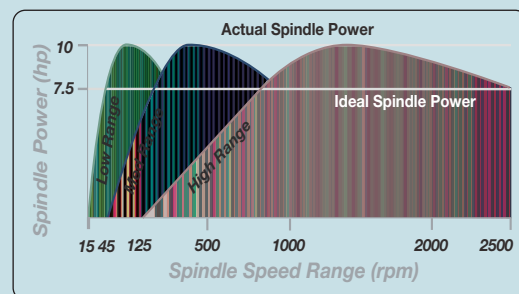

15 inch VS Lathe

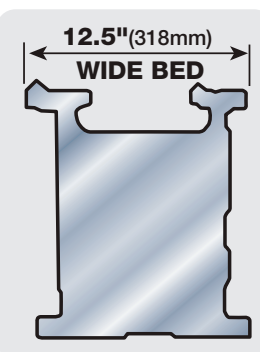

Extra heavy-duty wide bed gives our machines the capability of withstanding heavy use and excellent durability with minimum maintenance over many years.

Clausing/Colchester 18" (460mm) 21" (554mm) Swing, Variable Speed Lathe



Standard Features...

- State-of-the-art AC Spindle Drive features surface mount technology to give compact size and high reliability
- Interlocked end guard door for easy access for maintenance and changing end train gears
- Faster thread cutting - reversal of the leadscrew with the spindle running at low speed
- An easy-to-read index plate makes it simple to select the proper feed or threads
- Three headstock gear ranges produce a wide spread of constant power - 33 to 1 - better than most CNC lathes
- Infinitely variable spindle speeds displayed on headstock
- Dynamic spindle brake via the inverter
- Spindle bearings, gears and shafts are lubricated by a forced lubrication system
- Precision Gamet tapered roller spindle bearings
- Chuck guard with limit switch
- Carriage ways coated with "Moglice" PTFE for minimal bedwear and longer machine life
- Saddle mounted chip guard and full rear splash guard
- Extra wide heavy-duty cast iron bed with triangular webs for torsional stiffness and excellent chip clearance
- 2 axis power rapid traverse available from one lever mounted on saddle
- Heavy-duty tailstock with extra heavy-duty quill
- Single piece leadscrew cover protects leadscrew from chips
- Large capacity rollout chip bin for easy chip disposal
- All bedways are induction hardened and precision ground
- Heavyweight cast iron bases provide the maximum support for the bed combined with sloping top surfaces to prevent the accumulation of coolant

18" & 21" Variable Spindle Drive Power Charts

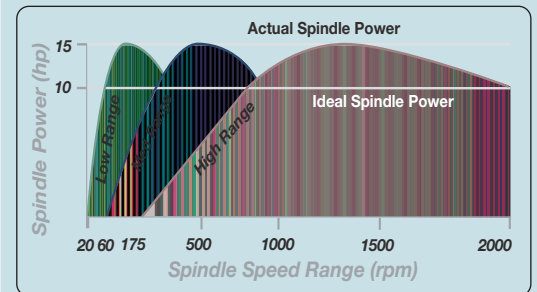

18 inch VS Lathe

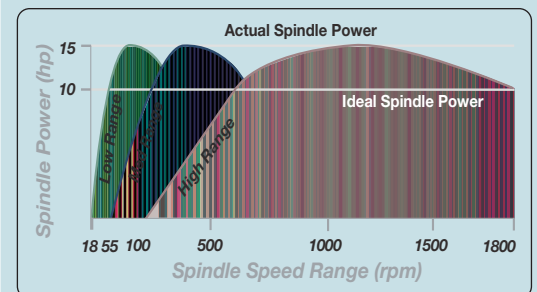

21 inch VS Lathe

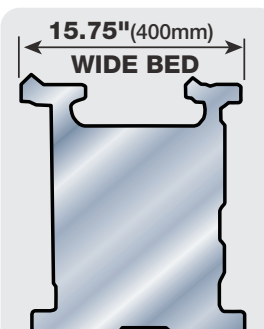

Extra heavy-duty 15.7" (400mm) wide bed gives our machines the capability of withstanding heavy use and excellent durability with minimum maintenance over many years.

Clausing/Colchester 13" (320mm) & 15" (400mm) Swing, Geared Head Lathe



Clausing/Colchester Geared Head Lathes are the industry standard... because the quality built into every machine translates into real long-term performance in your application. Rugged construction, consistent quality in design and production and the "human engineering" which makes the operator more efficient, all make this lathe a cost-effective investment. You will get unbelievable machine performance with the Clausing/Colchester Geared Head Lathes. Take a look at these features:

Standard Features...

- Fully-geared headstock with 12 spindle speeds from 40 - 2500 rpm 13", 16 spindle speeds from 25 - 2000 rpm 15"
- All headstock gears are hardened and ground
- Headstock shafts are splined and turn on anti-friction bearings
- Spindle bearings, gears and shafts are lubricated by a forced lubrication system
- A broad range of feed and thread selections are available by using three selector levers and an 8-position rotary dial
- Precision Gamet spindle bearings
- Cross slide runs along a dovetail guide
- Bed wipers and an apron mounted one-shot lubrication pump
- The cast iron apron is totally enclosed and splash bath lubricated
- Electromagnetic spindle brake
- 25/40" center distances 13", 50" center distances 15"
- Equipped with chuck guard, full splash guard and leadscrew cover
- Clutch drive, reverse leadscrew with spindle turning for faster thread cutting
- Extra wide bed provides accuracy and minimal wear
- A one year warranty and backed by the Clausing Service Center dedicated to support our customers with parts and service

Models* (Model # See Below)	13" VS	15" VS	18" VS	21" VS	13" GH	15" GH
Capacity						
Height of Center	6.7" (170mm)	7.67" (195mm)	9" (229mm)	11.02" (280mm)	6.5" (167mm)	7.68" (195mm)
Swing Over Bed	13.75" (350mm)	15.75" (400mm)	18.1" (460mm)	21.81" (554mm)	13" (330mm)	15.75" (400mm)
Swing in Gap	21" (533mm)	23" (584mm)	28.74" (730mm)	32.68" (830mm)	18.8" (480mm)	23" (585mm)
Width in Front of Faceplate	6.5" (165mm)	6.5" (165mm)	8.5" (216mm)	8.5" (216mm)	4.5" (115mm)	6.5" (165mm)
Swing over Cross Slide	7.75" (197mm)	9.7" (246mm)	10.62" (216mm)	14.57" (370mm)	8.26" (210mm)	9.7" (246mm)
Bedway Width	12.5" (318mm)	12.5" (318mm)	15.75" (400mm)	15.75" (400mm)	8" (203mm)	12.5" (318mm)
Headstock						
Spindle Bore	1.65" (42mm)	2.12" (54mm)	3" (76mm)	4.09" (104mm)	1.5" (38mm)	2.12" (54mm)
Spindle Nose (camlock)	D1-4	D1-6	D1-8	D1-11	D1-4	D1-6
Spindle Nose Taper	3MT	4MT	5MT	5MT	3MT	4MT
Number of Spindle Speeds	3 Infinitely Variable	3 Infinitely Variable	3 Infinitely Variable	3 Infinitely Variable	12	16
Spindle Speed Range (rpm)	15-3250	15-2500	20-2000	18-1800	40-2500	25-2000
Low Range (rpm)	15-340	15-300	20-225	18-200	-	-
Mid Range (rpm)	45-1010	35-830	60-675	55-605	-	-
High Range (rpm)	150-3250	110-2500	175-2000	160-1800	-	-
Cross/Top Slide						
Travel of Cross Slide	9.8" (249mm)	9.8" (249mm)	11.81" (299mm)	11.81" (299mm)	7.5" (190mm)	9.8" (250mm)
Width of Cross Slide	7.09" (180mm)	7.09" (180mm)	8" (203mm)	8" (203mm)	5.5" (140mm)	7.09" (180mm)
Travel of Top Slide	5.5" (140mm)	5.1" (130mm)	7.5" (190mm)	7.5" (190mm)	3.63" (92mm)	5.1" (130mm)
Width of Top Side	3.54" (90mm)	3.93" (100mm)	4" (102mm)	4" (102mm)	3.25" (82mm)	3.93" (100mm)
Tailstock						
Quill Travel	5.5" (140mm)	5.5" (140mm)	5.7" (145mm)	5.7" (145mm)	4.38" (110mm)	5.5" (140mm)
Quill Diameter	2.48" (63mm)	2.87" (73mm)	3.74" (95mm)	3.74" (95mm)	1.63" (42mm)	2.8" (73mm)
Quill Taper	4MT	4MT	6MT	6MT	3MT	5MT
Feeds and Threading						
Longitudinal Feed Range (in) (mm)	0.014-0.048 in/rev 0.35-1.22 mm/rev	0.0014-.048 in/rev 0.35-1.22 mm/rev	0.0016-0.11in/rev .041-2.79mm/rev	0.0016-0.11in/rev .041-2.79mm/rev	0.001-0.039in/rev .03-1mm/rev	0.014-0.096 in/rev .035-2.45mm/rev
Cross Feed Range (in) (mm)	0.0007-0.024in/rev 0.018-0.61mm/rev	0.00035-0.024in/rev .0089-0.61mm/rev	0.0008-0.055in/rev .02-1.4mm/rev	0.0008-0.055in/rev .02-1.4mm/rev	- -	0.0007-0.048in/rev .018-1.22mm/rev
Number of Inch Pitches	56	56	73	73	35	56
Range of Inch Pitches	2-56 TPI	2-56 TPI	2-84 TPI	2-84 TPI	2-56 TPI	2-56 TPI
Number of Metric Pitches	20	51	51	27	39	51
Range of Metric Pitches	0.2-14mm	0.2-14mm	0.2-14mm	0.2-14mm	0.2-14mm	0.2-14mm
Number of Diametral Pitches	20	20	27	27	18	20
Range of Diametral Pitches	8-56 DP	8-56 DP	8-72 DP	8-72 DP	8-56 DP	8-56 DP
Number of Module Pitches	51	20	27	51	18	20
Range of Module Pitches	0.2-3.5 MOD	0.2-3.5 MOD	0.2-3.5 MOD	0.2-3.5 MOD	0.3-3.5 MOD	0.2-3.5 MOD
Motor						
Spindle Motor	10 hp (7.5kw)	10 hp (7.5kw)	15 hp (10kw)	15 hp (10kw)	3 hp (2.2kw)	7.5 hp (5kw)

Standard Features:

- Spindle center bushing
- Two Morse Taper dead centers
- Rear splash guard
- Tool post chip guard
- Interlock chuck guard
- Leadscrew cover
- Inch threading dial
- Electric coolant pump, tank and fitting, coolant system
- End guard limit switch
- Tee slotted top slide
- Set of wrenches and keys
- Instruction and parts manual
- Accuracy chart
- Emergency stop button
- Lockable isolator switch
- One shot saddle and cross slide lubrication
- Rapid power traverse to cross slide and carriage (18" & 21" V.S. models)
- Saddle mounted controls and power meter (18" & 21" V.S. models)
- Forward/Reverse/Stop switch
- 230/460 v 3ph standard on VS models **All other voltage require an optional transformer**
- 230/460 v. 3 ph standard on Geared Head models
- Models 8026J/8027J Geared Head lathes are available with 220 v. 1 ph

Due to ongoing design improvements, specifications and design are subject to change without notice.

Dimensions and Weight

Model #	Center	A	B	C	Weight
8016VSJ	25" (635mm)	75" (1900mm)	51" (1300mm)	44" (1120mm)	2,790 lbs (1266kg)
8044VSJ	50" (12720mm)	99" (2515mm)	51" (1300mm)	44" (1120mm)	3,300 lbs (1497kg)
8053VSJ	40" (1016mm)	100" (2540mm)	51" (1300mm)	57" (1450mm)	4586 lbs (2080kg)
8054VSJ	60" (1500mm)	120" (3000mm)	51" (1300mm)	57" (1450mm)	5,765 lbs (2615kg)
8055VSJ	80" (2000mm)	140" (3556mm)	51" (1300mm)	57" (1450mm)	6,170 lbs (2799kg)
8114VSJ	40" (1016mm)	100" (2540mm)	51" (1300mm)	57" (1450mm)	5789 lbs (2489kg)
8115VSJ	60" (1500mm)	120" (3000mm)	51" (1300mm)	57" (1450mm)	5,886 lbs (2670kg)
8116VSJ	80" (2000mm)	140" (3556mm)	51" (1300mm)	57" (1450mm)	6,283 lbs (2850kg)
8119VSJ	120" (3000mm)	180" (4572mm)	51" (1300mm)	57" (1450mm)	7,960 lbs (3611kg)
8026J	25" (635mm)	59" (1500mm)	51" (1300mm)	35" (890mm)	1,680 lbs (762kg)
8027J	40" (1000mm)	75" (1900mm)	51" (1300mm)	35" (890mm)	1,960 lbs (889kg)
8043	50" (1270mm)	99" (2500mm)	51" (1300mm)	44" (1100mm)	3,300 lbs (1500kg)

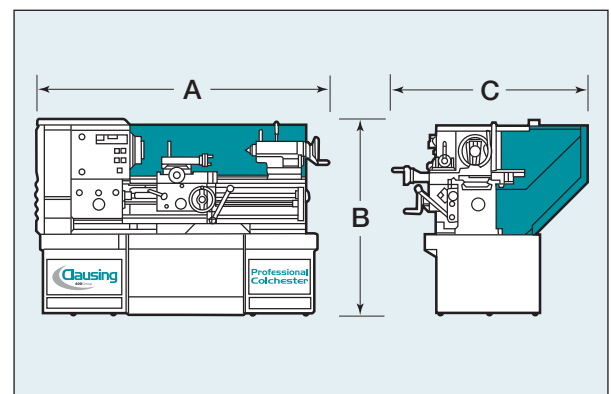

Clausing/Colchester 'MAGNUM' 26" (660mm) 32" (813mm) Swing, Variable Speed Lathe



Standard Features...

- AC Inverter Variable Speed Spindle Drive state of the art AC Spindle Drive featuring surface mount technology to give compact size and high reliability...
- Interlocked End Guard Door with easy access for maintenance and changing end train gears
- Leadscrew Reversing Box for faster thread cutting – reversal of the leadscrew with the spindle running at low speed
- Easy to read Index Plate makes it simple to select the proper feed rate or threads
- Three Headstock Gear Ranges for produce a wide spread of constant power – 33 to 1 – better than most CNC lathes
- Infinitely Variable Spindle Speeds you can get the right spindle speed very quickly with a response like a CNC lathe, displayed on headstock
- Dynamic spindle brake via the inverter
- Forced lubrication system the spindle bearings, gears and shafts are lubricated by a forced lubrication system
- Precision Gamet Tapered Roller Spindle Bearings
- Chuck Guard with limit switch
- Anti-Friction Carriage Ways. Low-friction “Moglice” PTFE material between the saddle and bed for minimal bedwear and longer machine life
- Saddle Mounted Chip Guard and Full Rear Splash Guard
- 2 axis power rapid traverse available from one lever mounted on the saddle
- Extra Wide Heavy-duty Cast Iron Bed with triangular webs for exceptional torsional stiffness and excellent chip clearance
- Heavy Duty Tailstock for excellent rigidity – with extra heavy-duty quill
- Covered Leadscrew protects leadscrew from chips
- Wheeled Chip Bin has a large capacity for easy chip disposal
- Hardened and Ground Bedways - all bedways are induction hardened and precision ground
- Cast Iron Base provides the maximum support for the bed combined with sloping top surfaces to prevent the accumulation of coolant

Model	Magnum 26"	Magnum 32"
Capacity		
Height of Center	46.65" (1185mm)	49.68" (1262mm)
Swing Over Bed	26.3" (670mm)	32.3" (820mm)
Swing in Gap	35.8" (910mm)	41.7" (1060mm)
Width in Front of Gap	9.44" (240mm)	9.44" (240mm)
Swing Over Cross Slide	16.9" (430mm)	22.8" (580mm)
Bedway Width	18.9" (480mm)	18.9" (480mm)
Cross/Top Slide		
Travel of Cross Slide	16" (406mm)	16" (406mm)
Width of Cross Slide	11" (280mm)	11" (280mm)
Travel of Top Slide	6.5" (165mm)	6.5" (165mm)
Width of Top Slide	7" (180mm)	7" (180mm)
Tailstock		
Quill Travel	12" (300mm)	12" (300mm)
Quill Diameter	4.125" (105mm)	4.125" (105mm)
Quill Taper	6MT	6MT
Feeds and Threading		
Longitudinal Feed Range (in) (mm)	0.002-0.16 in/rev .05-3.2mm/rev	0.002-0.16 in/rev .05-3.2mm/rev
Cross Feed Range (in) (mm)	0.001-0.08in/rev .025-1.6mm/rev	0.001-0.08in/rev .025-1.6mm/rev
Number of Inch Pitches	51	51
Range of Inch Pitches	2-84 tpi	2-84 tpi
Number of Metric Pitches	59	59
Range of Metric Pitches	0.2-14mm	0.2-14mm
Number of Diametral Pitches	27	27
Range of Diametral Pitches	8-72	8-72
Number of Module Pitches	20	20
Range of Module Pitches	0.2-3.5	0.2-3.5
Motor		
Spindle Motor	30 hp (20kw)	30 hp (20kw)

Standard Features:

- Spindle Center Bushing
- Two MT Centers
- Rear Splash Guard
- Interlock Chuck Guard
- Leadscrew cover
- Coolant System
- Inch Threading Dial
- Rapid Power Traverse to Cross Slide and Carriage
- Saddle Mounted Controls and Power Meter
- Tee Slotted Top Slide
- Tool Post Chip Guard
- Set of Wrenches and Keys
- Instruction and Parts Manual
- Accuracy Chart
- Emergency Stop Button
- Lockable Isolator Switch
- One Shot Saddle and Cross Slide Lubrication
- Forward/Reverse/Stop Switch
- Standard 230/3/60 or 460/3/60 Volts **(208/3/60 volts Require a Transformer)**

Due to ongoing design improvements, specifications and design are subject to change without notice.

Models and Dimensions:

Model	Swing and Center Distance	A	B	C	Weight Approx
8215VSJ	26" x 60" (660mm) x (1500mm)	151.5" (3850mm)	70.8" (1800mm)	74.8" (1900mm)	8,820 lbs. (4000kg)
8216VSJ	26" x 80" (660mm) x (2032mm)	171.2" (4350mm)	70.8" (1800mm)	74.8" (1900mm)	9,480 lbs. (4300kg)
8219VSJ	26" x 120" (660mm) x (3048mm)	210" (5350mm)	70.8" (1800mm)	74.8" (1900mm)	11,245 lbs. (5100kg)
8220VSJ	26" x 160" (660mm) x (4064mm)	250" (6350mm)	70.8" (1800mm)	74.8" (1900mm)	12,786 lbs. (5800kg)
8315VSJ	32" x 60" (813mm) x (1500mm)	151.5" (3850mm)	70.8" (1800mm)	74.8" (1900mm)	10,362 lbs. (4700kg)
8316VSJ	26" x 80" (813mm) x (2032mm)	171.2" (4350mm)	70.8" (1800mm)	74.8" (1900mm)	11,464 lbs. (5200kg)
8319VSJ	26" x 120" (813mm) x (3048mm)	210" (5350mm)	70.8" (1800mm)	74.8" (1900mm)	14,109 lbs. (6400kg)
8320VSJ	26" x 160" (813mm) x (4064mm)	250" (6350mm)	70.8" (1800mm)	74.8" (1900mm)	16,535 lbs. (7500kg)

Headstock	26" Standard	26" Option #1	32" Standard	32" Option #1	32" Option #2
Spindle Bore	4.09" (104mm)	6" (155mm)	4.09" (104mm)	6" (155mm)	9" (230mm)
Spindle Nose (Camlock)	D1-11	A2-11	D1-11	A2-11	A2-15
Spindle Nose Taper	8MT	7MT	8MT	7MT	-
Number of Spindle Speeds	3	3	3	3	3
Spindle Speed Range (rpm)	18-1800	15-1800	18-1800	15-1800	8-600
Low Range (rpm)	18-200	15-102	18-200	15-102	8-63
Mid Range (rpm)	55-605	45-306	55-605	45-306	21-229
High Range (rpm)	160-1800	118-800	160-1800	118-800	56-600

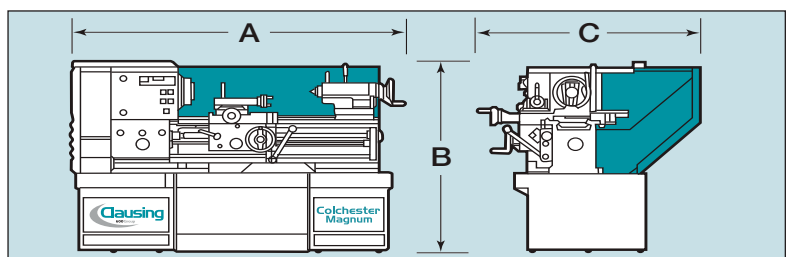

Add Productivity with Clausing/Colchester Accessories

Live Center

Revolving Center is concentric within .0002" T.I.R. 60° point rotates on roller bearings.

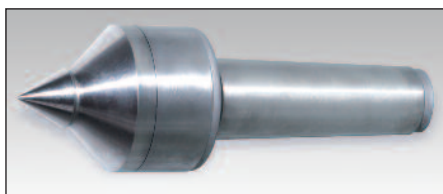

Part No.	Fits Lathe Models	Weight
12-510	13" Swing Geared Head Lathes	2 lbs.
15-710	13" Swing Variable Speed Lathes	3 lbs.
17-910	15" Swing Geared Head & Variable Speed Lathes	9 lbs.
18-910	18" thru 32" Swing Variable Speed Lathe	9 lbs.



Steady Rest

The Steady Rest provides support for long or slender work and allows heavy cuts without chatter. Capacities are sized for lathe models.

Part No.	Fits Lathe Models	Capacity Min-Max	Fingers	Weight
3-513	13" Swing Geared Head Lathes	3/8"-5-1/2"	Bronze	37 lbs.
13-472VS	13" Swing Variable Speed Lathes	3/8"-5-1/2"	Bronze Tip & Roller	37 lbs.
15-755N	15" Swing Geared Head & Variable Speed Lathes	3/8"-6-3/8"	Bronze Tip & Roller	45 lbs.
18-812	18" Swing Variable Speed Lathes	3/8"-9-3/8"	Bronze Tip & Roller	58 lbs.
21-860	21" Swing Variable Speed Lathes	6-1/8"-15"	Bronze Tip & Roller	115 lbs.
21-412VS	21" Swing Variable Speed Lathes	3/8"-9"	Bronze Tip & Roller	115 lbs.
26-412VS	26" Swing Variable Speed Lathes	1.9" - 8.26	Roller Tip	115 lbs.
26-860	26" Swing Variable Speed Lathes	7.8" - 14.9"	Roller Tip	125 lbs.
32-412VS	32" Swing Variable Speed Lathes	1.9" - 8.26	Roller Tip	115 lbs.
32-860	32" Swing Variable Speed Lathes	7.8" - 14.9"	Roller Tip	125 lbs.
32-861	32" Swing Variable Speed Lathes	1.78" - 19.69"	Roller Tip	145 lbs.



Follower Rest

The Follower Rest mounts on the carriage and moves with it, providing workpiece support close to the cutting tool... making it ideal for long slender parts which must be machined between centers.

Part No.	Fits Lathe Models	Capacity Min-Max	Fingers	Weight
3-514	13" Swing Geared Head Lathes	3/8"-3"	Bronze	16 lbs.
13-471VS	13" Swing Variable Speed Lathes	3/8"-3"	Bronze Tip & Roller	16 lbs.
15-754N	15" Swing Geared Head & Variable Speed Lathes	3/8"-6-3/8"	Bronze Tip & Roller	28 lbs.
18-811	18" Swing Variable Speed Lathes	3/8"-9-3/8"	Bronze Tip & Roller	37 lbs.
21-411VS	21" Swing Variable Speed Lathes	3/8"-4-1/4"	Bronze Tip & Roller	37 lbs.
26-411VS	26" Swing Variable Speed Lathe	.79" - 6.3"	Roller Tip	40 lbs.
32-411VS	32" Swing Variable Speed Lathe	.79" - 6.3"	Roller Tip	45 lbs.

Taper Attachment

The Taper Attachment is fitted to the rear of the carriage and permits taper turning without disengaging the cross feed screw. It is easy to set-up and does not interfere with normal operation. The slide is graduated in degrees of taper with a range of 10° on either side of center. Maximum taper is 4" per foot.

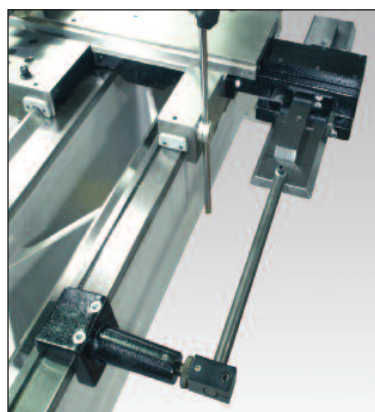

Part No.	Fits Lathe Models	Capacity Per Setting	Weight
3-521	13" Swing Geared Head Lathes	10"	39 lbs.
13-410VS	13" & 15" Swing Geared Head & Variable Speed Lathes	12"	39 lbs.
18-810	18" & 21" Variable Speed Lathes	15"	94 lbs.
26-810	26" Variable Speed Lathes	15"	105 lbs.
32-810	32" Variable Speed Lathes	15"	105 lbs.

LED Work Light



FV-9070L

Aloris Quick Change Tool Post

Precision engineered to assure accuracy. Advanced design provides built-in quick tool changing versatility with positive rigidity to meet the most exacting working tolerance.

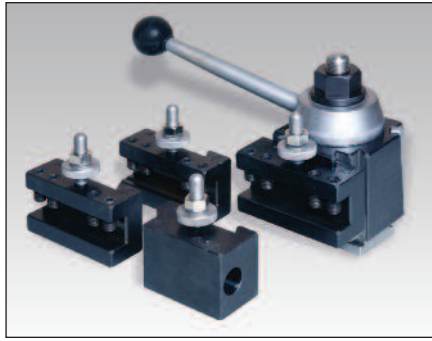

Quickly and easily installed on any engine lathe, bench or CNC lathe, for a wide range of operations... from fine precision work to heavy-duty cutting.

The Aloris Quick Change Tool Post is shipped with four (4) Tool Holders: 2 Turning and Facing Holders; 1 Boring, Turning and Facing Holders; 1 Morse Taper Holder.

Part No.	Fits Lathe Models	Weight
3-503A	13" Swing Geared Head Lathes	29 lbs.
13-775A	13" Swing Variable Speed Lathes	32 lbs.
15-775A	15" Swing Geared Head & Variable Speed Lathes	35 lbs.
17-875A	18" Swing Variable Speed Lathes	69 lbs.
21-475A	21" Swing Variable Speed Lathes	69 lbs.
26-475A	26" Swing Variable Speed Lathes	69 lbs.
32-475A	32" Swing Variable Speed Lathes	69 lbs.

Five Position Carriage Stop

This stop is useful for turning multiple diameter work, and is mounted on the apron. Each of the five screw stops can be indexed to contact the stop pin mounted on the bed vee. Accurate indexing is provided by a steel ball under spring tension.

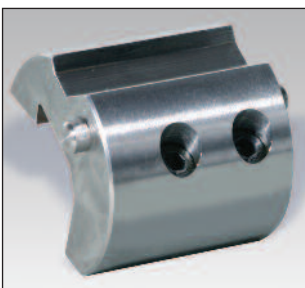
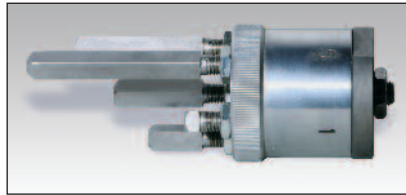

One Position Carriage Stop

This hardened stop clamps on the front bed way at any position determined by the operator, allowing repetitive cuts to the same position.

Part No.	Fits Lathe Models	Weight
3-516	13" Swing Geared Head Lathes	2 lbs.
13-435VS	13" & 15" Swing Geared Head & Variable Speed Lathes	3 lbs.
17-832	18" & 21" Swing Variable Speed Lathes	5 lbs.

Aloris Tool Post Extra Tool Holders

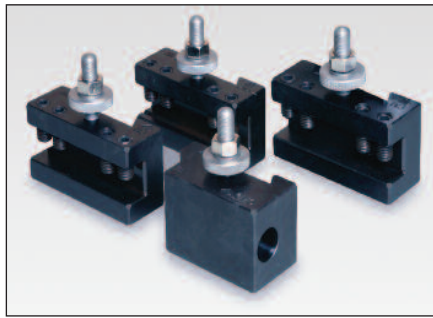

These holders are for the 15-775A tool post. Other models numbers listed in price sheets.

Part No.	Tool Holder Type
15-775A-1	Aloris Extra Straight Holder 1"
15-775A-2	Aloris Extra V-Holder 1", 13/16" Bore Bar
15-775A-4D	Aloris 1-1/4" Boring Bar Holder
15-775A-41D	Aloris 1-1/2" Boring Bar Holder
15-775A-5	Aloris Extra 3MT Holder
15-775A-71	Aloris Extra Cutoff Holder 2" height
15-77A-BSL-187	Aloris Cutoff Blade Self-Locking Throw Awway 3/16"

Part No.	Fits Lathe Models	Weight
3-518	13" Swing Geared Head Lathes	4 lbs.
13-438VS	13" & 15" Swing Geared Head & Variable Speed Lathes	4 lbs.
18-831	18" & 21" Swing Variable Speed Lathes	6 lbs.
26-831	26" Swing Variable Speed Lathes	6 lbs.
32-831	32" Swing Variable Speed Lathes	6 lbs.

(Use with Carriage Stop or Micro Carriage Stop, sold separately)



Micro Position Carriage Stop

This hardened stop clamps on the front bed way at any position determined by the operator, allowing repetitive cuts to the same position.

Part No.	Fits Lathe Models	Weight
3-517	13" Swing Geared Head Lathes	2 lbs.
13-436VS	13" & 15" Swing Geared Head & Variable Speed Lathes	3 lbs.
17-833	18" & 21" Swing Variable Speed Lathes	5 lbs.
26-833	26" Swing Variable Speed Lathes	5 lbs.
32-833	32" Swing Variable Speed Lathes	5 lbs.

The Last Word in Toolroom Lathe Productivity...Pick from One of These Three World Leading Digital Readout Systems Available with Constant Surface Speed.

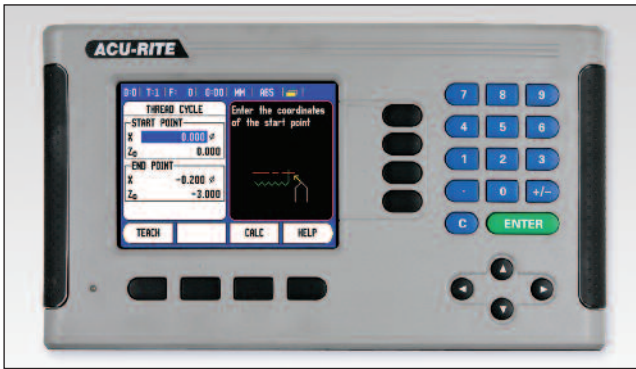

ACU-RITE® 300S LCD Digital Readout Available with Constant Surface Speed (CSS)... 200S LCD for Standard 2 Axis Systems

The 300S Color digital readout is the ultimate in efficiency. This Intuitive, user-friendly readout comes equipped with machine specific software and easy to read, full color, flat screen 5.7" LCD display.

The ultimate in efficiency and turning productivity, utilizing state-of-the-art features...

- Simplify cutting metric threads on lathes with inch leadscrews with the NEW Thread Assist function (optional 1000 line encoder required)
- 16 Tool Offsets for easy compensation of different tool sizes
- Lock Axis feature, used in conjunction with tool offsetting, lets the operator establish tool offsets with the tool under load, resulting in reduced deflection
- Instant radius/diameter conversion reduces math errors and allows operator to machine to print
- Posit-Trac™; a unique feature that lets you easily, quickly and accurately re-establish workpiece zero after power loss
- 2, 3 or 4-axes 5.7" flat-screen LCD display
- Preset and zero reset
- Near-zero warning
- Instant inch/mm conversion
- Linear and non-linear error compensation
- Taper calculator
- Die-cast metal construction
- RS-232-C/V.24 serial port data interface

- Multiple program names with numerous steps
- Multiple display views - DR01 & DR02
- Job clock
- Feed rate display
- Advanced skew compensation
- Multiple language supports
- Absolute/incremental
- Help function
- 4 function calculator

Precision Glass Scales

ACU-RITE precision glass scales withstand the elements found in the harshest machine shop environments. As a result, our precision glass scales resist changes in size, shape or density due to temperature and humidity variation.

- Exceptional accuracy $\pm .00006"$ (1.5 μ m)
- Available in lengths from 1"–773" (25.4–19634mm)
- Resolution from .00002"–.0005" (.05–10 μ m)

NEWALL

DP700 DRO Outstanding Features with Leading Edge Technology



The DP700 is a powerful and intuitive DRO that is housed in a rugged, ergonomically designed casting. The DRO features all of the essential functions for turning.

- Solid cast construction
- Long life membrane keypad
- Clean, crisp LEDs
- Intuitive message window
- Wide viewing angle
- Safe, low voltage external power supply
- Five year warranty
- Customized canned cycles
- ABS/Inch
- Digifind
- Metric/Inch
- Zero approach
- Tool offsets
- Taper
- Summing
- Bolt hole circle
- Arc contouring
- Polar co-ordinates
- Line hole
- Programmable memory
- Feed-rate display
- Linear and segmented error Compensation
- RS232 output
- Undo function



FAGOR **Innova 40i DRO, with color TFT screen**

The Innova 40i for lathe applications offers the operator graphic assistance that no other DRO can offer such as taper calculation, the combination of the Z1 and Z2 axes or the 16 datum points for as many tool offsets that you can store.

The FAGOR DRO offers the user features that make the operators job easier

- TFT color LCD display
- High clarity view from any angle
- NEW Threading software (TPI and metric threads)
- Solid graphics & 3D Simulation
- Conversational graphic help screen
- Friendly and intuitive operations
- Easy set-up and diagnosis
- “Distance to Go” bar for easy positioning
- Up to 16 tool offsets with hold feature
- Built-in calculator with auto recall
- Feedback alarms
- Taper calculation
- Combining the Z1 and Z2 axes
- Software travel limits for safety
- Re-Set, Pre-Set, direct mm/inch conversion
- FAGOR Warranty: 3 years and lifetime on the glass



Pratt Burnerd Self-Centering Universal 3-Jaw SETRITE™ Chucks

Pratt Burnerd Universal Setrite 3-Jaw Chucks are precision manufactured with a .0005 TIR repeatability on duplicate parts. The steel body allows high metal removal rates. 3-Jaw Setrite Chucks are supplied with two-piece

American standard tongue and groove reversible jaws. Chucks have nitride hardened scroll and hardened pinion. All chucks have a two year warranty.

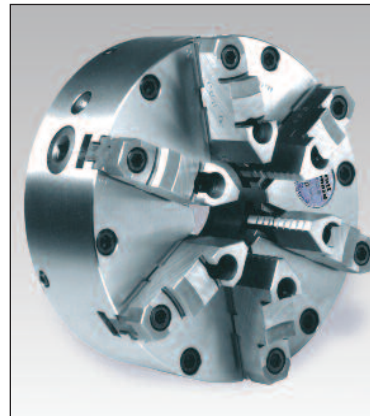

Pratt Burnerd Self-Centering Universal 6-Jaw SETRITE™ Chucks

Pratt Burnerd Universal Setrite 6-Jaw Chucks are precision manufactured with a .0005 TIR repeatability on duplicate parts. The steel body allows high metal removal rates. 6-Jaw Setrite Chucks are supplied with two-piece American standard

tongue and groove reversible jaws. Chucks have nitride hardened scroll and hardened pinion. All chucks have a two year warranty.

Part No.	Dia.	Lathe Type & Size	Spindle Size	Max. rpm	Weight
0625321	6"	13" Swing Geared Head & Variable Speed Lathes	D1-4	4900	26 lbs.
0825321	8"	13" Swing Geared Head & Variable Speed Lathes	D1-4	4200	46 lbs.
0825323	8"	15" Swing Geared Head & Variable Speed Lathes	D1-6	4200	46 lbs.
1025323	10"	15" Swing Geared Head & Variable Speed Lathes	D1-6	3300	71 lbs.
1025324	10"	18" Swing Variable Speed Lathes	D1-8	3300	71 lbs.
1225324	12"	18" Swing Variable Speed Lathes	D1-8	2300	112 lbs.
1225325	12"	21" Swing Variable Speed Lathes	D1-11	2300	112 lbs.
1525325	15"	21" Swing Variable Speed Lathes	D1-11	2000	146 lbs.
1825325	18"	26" Swing Variable Speed Lathes	D1-11	1300	270 lbs.
2425325	24"	32" Swing Variable Speed Lathes	D1-11	850	550 lbs.

Part No.	Dia.	Lathe Type & Size	Spindle Size	Max. rpm	Weight
0626321	6"	13" Swing Geared Head & Variable Speed Lathes	D1-4	3500	27 lbs.
0826321	8"	13" Swing Geared Head & Variable Speed Lathes	D1-4	3000	49 lbs.
0826323	8"	15" Swing Geared Head & Variable Speed Lathes	D1-6	3000	49 lbs.
1026323	10"	15" Swing Geared Head & Variable Speed Lathes	D1-6	2400	76 lbs.
1026324	10"	18" Swing Variable Speed Lathes	D1-8	2400	76 lbs.
1226324	12"	18" Swing Variable Speed Lathes	D1-8	2000	116 lbs.
1226325	12"	21" Swing Variable Speed Lathes	D1-11	2000	116 lbs.
1526325	15"	21" Swing Variable Speed Lathes	D1-11	1500	205 lbs.
1826325	18"	26" Swing Variable Speed Lathes	D1-11	880	290 lbs.
2426325	24"	32" Swing Variable Speed Lathes	D1-11	740	570 lbs.



Pratt Burnerd 4-Jaw Medium Duty Independent Chucks

Pratt Burnerd Independent Chucks are precision manufactured and supplied with Ductile iron bodies, hardened operating screws and solid reversible hard jaws. Special jaw and jaw way design adds extra bearing surfaces, increasing chuck

life and rigidity. Pratt Burnerd Independent Chucks come with a two year warranty.

Part No.	Dia.	Lathe Type & Size	Spindle Size	Weight
0814421	8"	13" Swing Geared Head & Variable Speed Lathes	D1-4	31 lbs.
1014421	10"	13" Swing Geared Head & Variable Speed Lathes	D1-4	43 lbs.
1014423	10"	15" Swing Geared Head & Variable Speed Lathes	D1-6	43 lbs.
1214423	12"	15" Swing Geared Head & Variable Speed Lathes	D1-6	72 lbs.
1214424	12"	18" Swing Variable Speed Lathes	D1-8	72 lbs.
Heavy Duty Chucks				
1414524	14"	18" Swing Variable Speed Lathes	D1-8	126 lbs.
1614525	16"	21" Swing Variable Speed Lathes	D1-11	180 lbs.
1843-2AD11	18"	26" Swing Variable Speed Lathes	D11/A11	320 lbs.
2043-2AD11	20"	26" Swing Variable Speed Lathes	D11/A11	415 lbs.
2443-2AD11	24"	32" Swing Variable Speed Lathes	D11/A11	720 lbs.
2843-2AD11	28"	32" Swing Variable Speed Lathes	D11/A11	1050 lbs.

Air Powered Front Mounted 5C Dead Length Collet

Easily convert any lathe into a production machine. No hydraulic system required. No draw tube or air feed tubes restricting spindle bore. No rear cylinders and cylinder adapters. Repeats on duplicate parts $\pm .00015$.



Part No.	Lathe Type & Size	Spindle	Weight
ATL206-5CD4	13" Swing Variable Speed Lathes	D1-4	22 lbs.
ATL206-5CD6	15" Swing Geared Head & Variable Speed Lathes	D1-6	22 lbs.
ATL206-5CD8	18" Swing Variable Speed Lathes	D1-8	22 lbs.

Air Powered Front Mounted B42 Dead Length Collet

Repeats on duplicate parts $\pm .00015$. No hydraulic system required. No draw tube or air feed tubes restricting spindle bore. No rear cylinders and cylinder adapters. Easily convert any lathe into a production machine.



Part No.	Lathe Type & Size	Spindle	Weight
ATL207-B42D4	13" Swing Variable Speed Lathes	D1-4	35 lbs.
ATL206-B42D6	15" Swing Geared Head & Variable Speed Lathes	D1-6	35 lbs.
ATL206-B42D8	18" Swing Variable Speed Lathes	D1-8	35 lbs.

Slotted Face Plate

Part No.	Dia.	Lathe Type & Size	Spindle	Weight
13-403	12"	13" Swing Variable Speed Lathes	D1-4	45 lbs.
13-500	12"	13" Swing Geared Head Lathes	D1-4	45 lbs.
13-404	18"	13" Swing Variable Speed Lathes	D1-4	60 lbs.
13-502	18"	13" Swing Geared Head Lathes	D1-4	60 lbs.
15-703	14"	15" Swing Geared Head & Variable Speed Lathes	D1-6	50 lbs.
15-704	21"	15" Swing Geared Head & Variable Speed Lathes	D1-6	108 lbs.
17-803	17"	18" Swing Variable Speed Lathes	D1-8	120 lbs.
17-804	28"	18" Swing Variable Speed Lathes	D1-8	229 lbs.
21-403	20"	21" Swing Variable Speed Lathes	D1-11	130 lbs.
21-404	27"	21" Swing Variable Speed Lathes	D1-11	205 lbs.

5C Front Mounted Hand Wheel Speed Collet Chuck

Fast and easy, front hand wheel operation reduces operator fatigue with accurate maximum cone TIR .0005". Easy installation, no drawtubes or linkages required. One year warranty.



Part No.	Lathe Type & Size	Spindle	Weight
PB23-D4	13" Swing Variable Speed Lathes	D1-4	15 lbs.
PB23-D6	15" Swing Geared Head & Variable Speed Lathes	D1-6	17 lbs.
PB23-D8	18" Swing Variable Speed Lathes	D1-8	23 lbs.
PB33-D11	21" Swing Variable Speed Lathes	D1-11	27 lbs.

Air Powered Front Mounted 16C Dead Length Collet

No hydraulic system required. No draw tube or air feed tubes restricting spindle bore. No rear cylinders and cylinder adapters. Easily convert any lathe into a production machine. Repeats on duplicate parts $\pm .00015$.



Part No.	Lathe Type & Size	Spindle	Weight
ATL207-16CD4	13" Swing Variable Speed Lathes	D1-4	30 lbs.
ATL207-16CD6	15" Swing Geared Head & Variable Speed Lathes	D1-6	30 lbs.
ATL207-16CD8	18" Swing Variable Speed Lathes	D1-8	30 lbs.

Air Powered Front Mounted B60 Dead Length Collet

No hydraulic system required. Repeats on duplicate parts $\pm .00015$. No draw tube or air feed tubes restricting spindle bore. No rear cylinders and cylinder adapters. Easily convert any lathe into a production machine.



Part No.	Lathe Type & Size	Spindle	Weight
ATL207-B60D4	13" Swing Variable Speed Lathes	D1-4	46.6 lbs.
ATL206-B60D6	15" Swing Geared Head & Variable Speed Lathes	D1-6	46.6 lbs.
ATL206-B60D8	18" Swing Variable Speed Lathes	D1-8	46.6 lbs.

Pratt Burnerd Key-Operated Collet Chucks

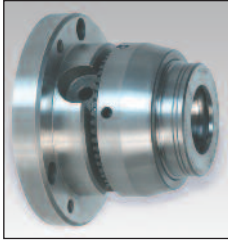

This extremely accurate, .001" repeatability, economical chuck is completely sensitive for any gripping pressure. Its compact, efficient design is equipped with ball bearings and hardened

and ground components for lasting precision. Capacities from 1/6" through 2-1/2"

Part No.	Description	Lathe Type & Size	Bar Stock Capacity	Collet Capacity	Collet Type	Weight
6012-31300	KC15 D4	13" Swing Geared Head Lathes	1/16"-1-1/2"	1-1/2"	EC	18 lbs.
6012-52100	KC25 D6	15" Swing Geared Head Lathes	1/2"-2-1/2"	2-1/2"	EE	60 lbs.
6012-52100	KC25 D6	15" Swing Variable Speed Lathes	1/2"-2-1/2"	2-1/2"	EE	60 lbs.
6012-62100	KC25 D8	18" Swing Variable Speed Lathes	1/2"-2-1/2"	2-1/2"	EE	65 lbs.
6012-72100	KC25 D11	21" Swing Variable Speed Lathes	1/2"-2-1/2"	2-1/2"	EE	65 lbs.

Pratt Burnerd Multi-Size Collets

for Key-Operated Chuck

The Pratt Burnerd multi-size collets provide an accurate, efficient and economical means of holding work, while eliminating the need for decimal, metric or special size collets. Each multi-size collet has a stepless gripping range of .125" with an extended range of $\pm .010$ " of size... accommodating both undersize and oversize work.

Most multi-size collets handle hex as well as round stock. Pratt Burnerd multi-size collets are very accurate, with no distortion. Gripping pressure is adjustable and the full-grip blades permit machining up to collet face. Accuracy is .0005" maximum eccentricity at the nose.



EC Collets		EE Collets	
1/16-3/16	3150-30200	1/2-5/8	3150-50600
1/8-1/4	3150-30300	5/8-3/4	3150-50700
1/4-3/8	3150-30400	3/4-7/8	3150-50800
3/8-1/2	3150-30500	7/8-1	3150-50900
1/2-5/8	3150-30600	1-1 1/8	3150-51000
5/8-3/4	3150-30700	1 1/8-1 1/4	3150-51100
3/4-7/8	3150-30800	1 1/4-1 3/8	3150-51200
7/8-1	3150-30900	1 3/8-1 1/2	3150-51300
1-1 1/8	3150-31000	1 1/2-1 5/8	3150-51400
1 1/8-1 1/4	3150-31100*	1 5/8-1 3/4	3150-51500
1 1/4-1 3/8	3150-31200	1 3/4-1 7/8	3150-51600
1 3/8-1 1/2	3150-31300	1 7/8-2	3150-51700
SET	3160-31300	2-2 1/8	3150-51800
		2 1/8-2 1/4	3150-51900
		2 1/4-2 3/8	3150-52000*
		2 3/8-2 1/2	3150-52100*
		SET	3160-52100

*For round stock only

Crawford 5C Round Collets

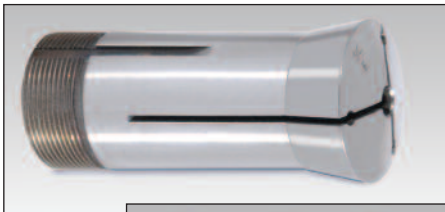

Part No.	Sizes
0123-R (<i>R=Size</i>)	1/8" thru 1-1/8 by 64ths
5C Round Collet Sets	
0123-SET-4	1/16" thru 1-1/16" by 64ths
0123-SET-5	1/16" thru 1-1/16" by 32nds
0123-SET-6	1/16" thru 1-1/16" by 16ths
0123-SET-7	1/8" thru 1" by 8ths
7659	Collet Rack for 13" and 15" lathes

Crawford 16C Round Collets

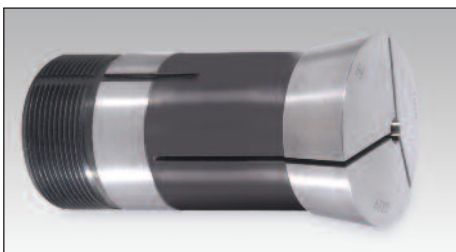

Part No.	Sizes
G119-R (<i>R=Size</i>)	1/16" thru 1-5/8 by 16ths

Crawford B-42 Round Collets

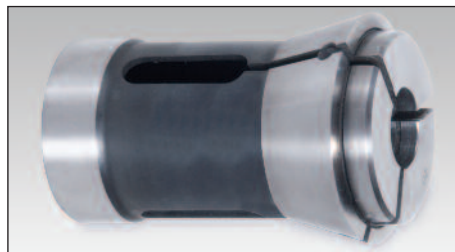

Part No.	Sizes
4728-R (<i>R=Size</i>)	1/16" thru 1-5/8 by 16ths

Crawford B-60 Round Collets



Part No.	Sizes
4291-R (<i>R=Size</i>)	1/16" thru 2-5/16 by 16ths



Your Single Source for Machine Tools

Clausing Precision Drills

- Clausing Belt-drive Drills
- Clausing Geared-head Drills
- Clausing Radial Drills

Clausing Precision Mills

- Clausing Bed Mills
- Clausing CNC Bed Mills
- Clausing Knee Mills
- Clausing EVS Knee Mills
- Clausing Universal Mills

Clausing Precision Lathes

- Clausing/Colchester Geared Head Lathes
- Clausing/Colchester Professional V.S. Lathes
- Clausing/Colchester MAGNUM V.S. Lathes
- Clausing MA/MAV Series Lathes
- Clausing Large Swing Standard vLathes
- Clausing Large Swing CNC Lathes
- Clausing Precision Toolroom Lathes

Clausing Precision Grinders

- Clausing Manual Grinders
- Clausing 2 Axes Hydraulic Grinders
- Clausing 3 Axes Hydraulic Grinders
- Clausing ASDIII Automatic Grinders

Clausing Precision Cutting Machines

- Clausing/Kalamazoo Horizontal Bandsaws
- Clausing/Kalamazoo Vertical Bandsaws
- Clausing/Kalamazoo Tilt Frame Miter Bandsaws
- Clausing/Kalamazoo Cold Saws

Your Authorized Clausing Precision Machine Tools Distributor



**COMPLETE
METALWORKING
SOLUTIONS**

(800) 991-4225

www.ahbinc.com

ISO Certified

customerservice@ahbinc.com



Celebrating Over A Century in the Machine Tool Business