

SERIE **MD**

HIGH PRODUCTIVITY INDUSTRIAL MACHINERY for
Deburring-Polishing



AHB
TOOLING & MACHINERY

COMPLETE METALWORKING SOLUTIONS
(800) 991-4225 www.ahbinc.com
ISO Certified customerservice@ahbinc.com



metal

MD
WD

EN

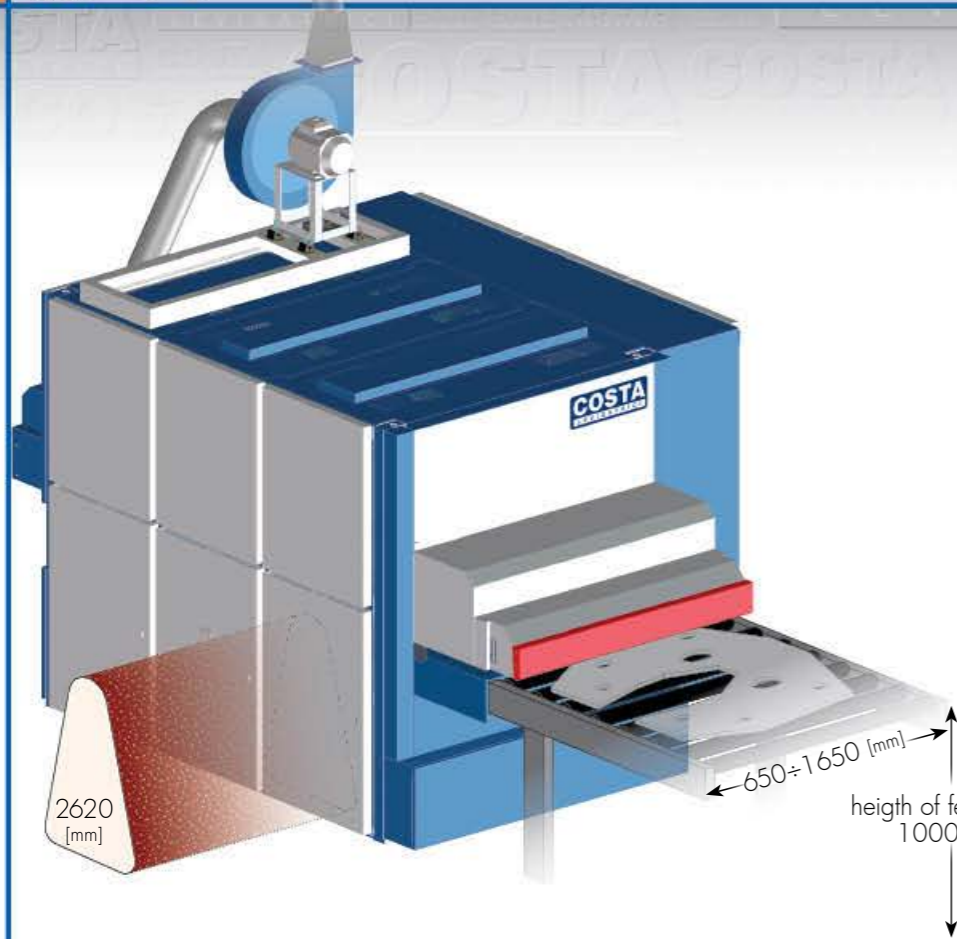

Universal deburring-finishing systems for processing ferrous and non-ferrous materials. This series of working centers is available with constant height table for in-line operations.

These machines are available in working widths from 650mm to 1650mm.

The longer sanding belts, of 2620mm length, guarantee consistent surface finish and improved belt life, therefore lowering machine operating costs.

Thanks to their modular concept, these working centers can be customized according to the individual customer need, through a specific selection of the working units for each type of work to be performed.

The frame is engineered to hold from 1 through 4 internal working units, and one external unit.

The high structural rigidity of the frame as well as the feed table combined with high-tech mechanics and electronics, make this series the perfect working center for your operation.

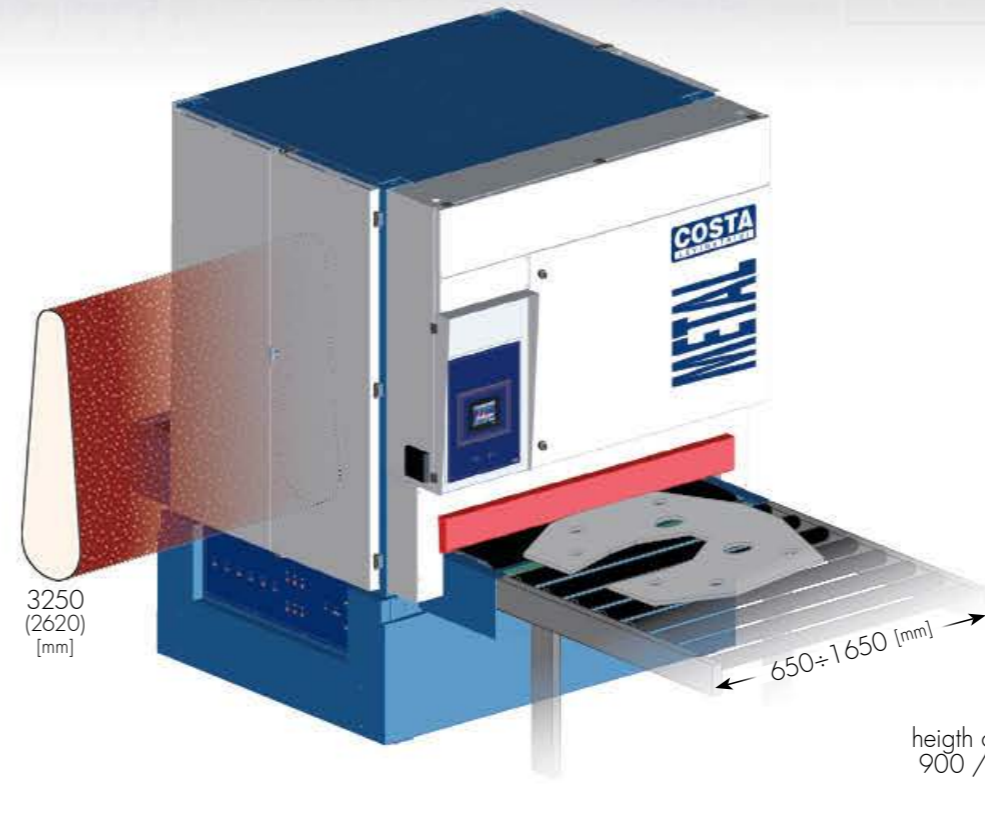

This series combines the heavy-duty technology of industrial grinding machines with working units dedicated for deburring applications.

Available in working widths from 650 mm to 1650 mm, these machines can be equipped with 1 and up-to 5 internal working units, and up to 2 external units. Different levels of finish can be achieved in one pass by combining more working units in one frame.

The 2620 - 3250 mm length abrasive belts guarantee a professional finish and consistent surface roughness, also on the most difficult materials.

The longer abrasive belts become even more important in deburring operations to extend abrasive lifetime while maintaining a constant level of abrasion. The SB250 brush units, with quick extraction system, can add a Scotch-Brite™ finish to stainless steel, aluminium, etc.

Now, it is possible to deburr, polish, and brush finish at industrial level with one machine only.

bottom machine available from 1 to 4 working units



top machine available from 2 to 5 working units

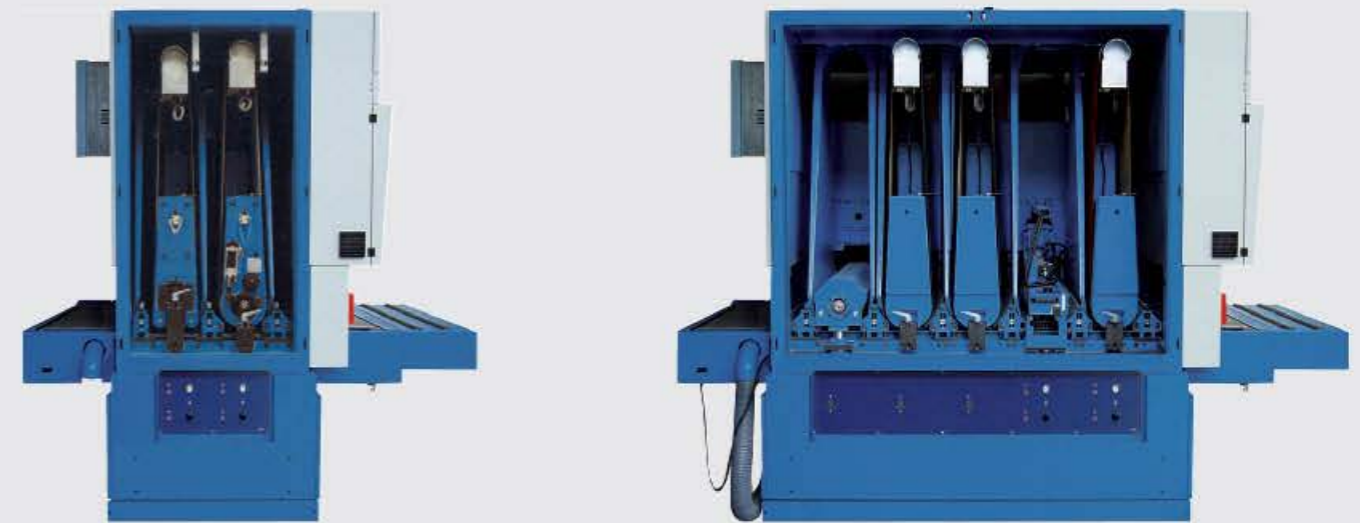

working units suitable for installation in any position inside the frame

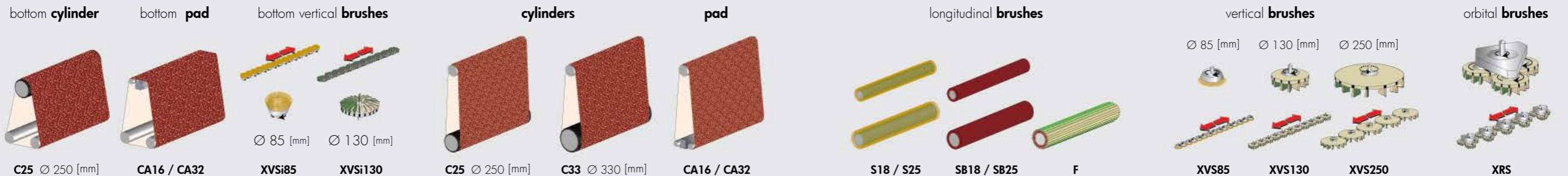

Wet processing includes all applications with sanding belts, brushes, and other surface processing media, where the process requires coolant.

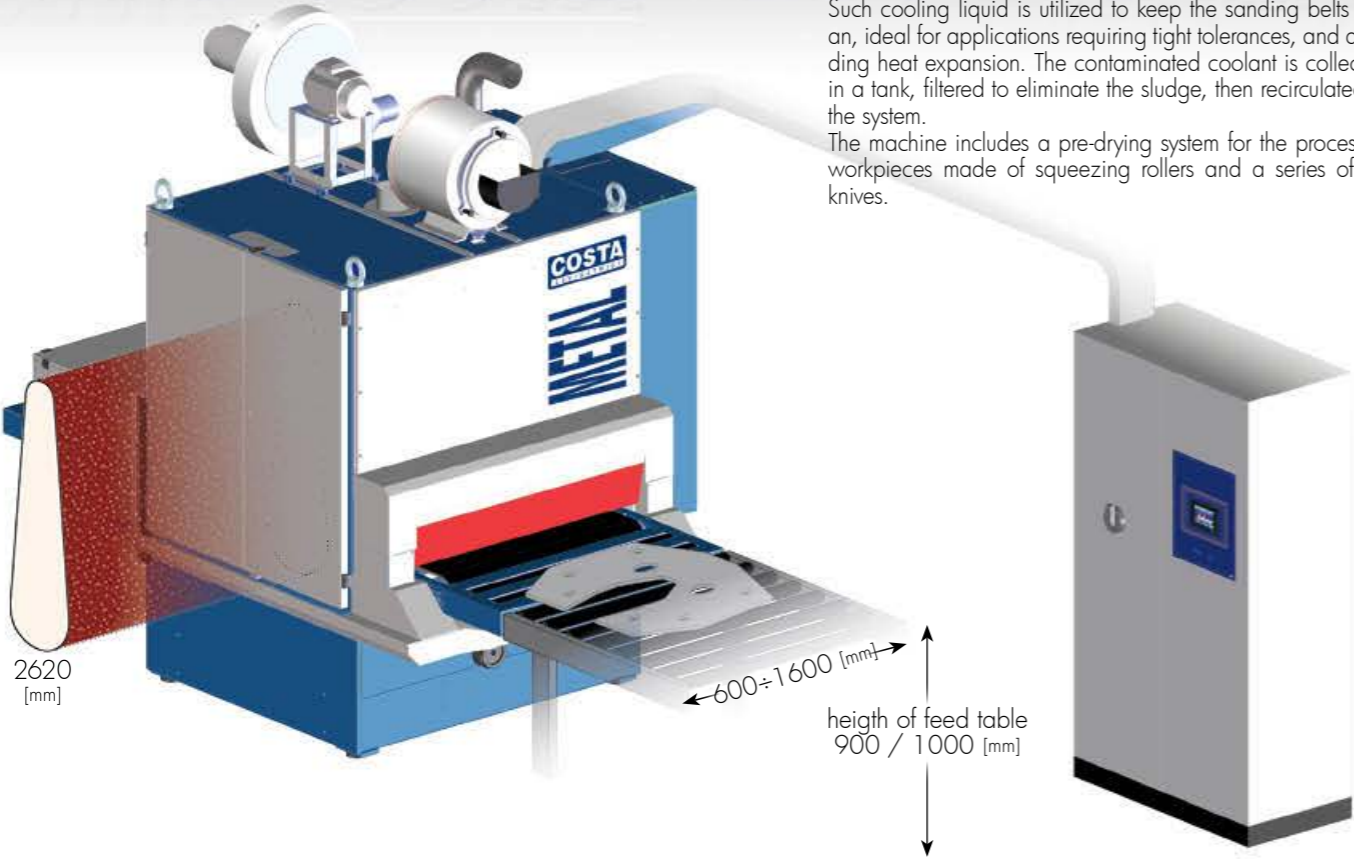

Such cooling liquid is utilized to keep the sanding belts clean, ideal for applications requiring tight tolerances, and avoiding heat expansion. The contaminated coolant is collected in a tank, filtered to eliminate the sludge, then recirculated in the system. The machine includes a pre-drying system for the processed workpieces made of squeezing rollers and a series of air knives.

Grinding & polishing lines with multiple machines

High productivity automatic line for thickness tolerance grinding of parts for the automotive industry, composed by n. 3 wet machines WD, and 3 units for washing the work-pieces after each machine.

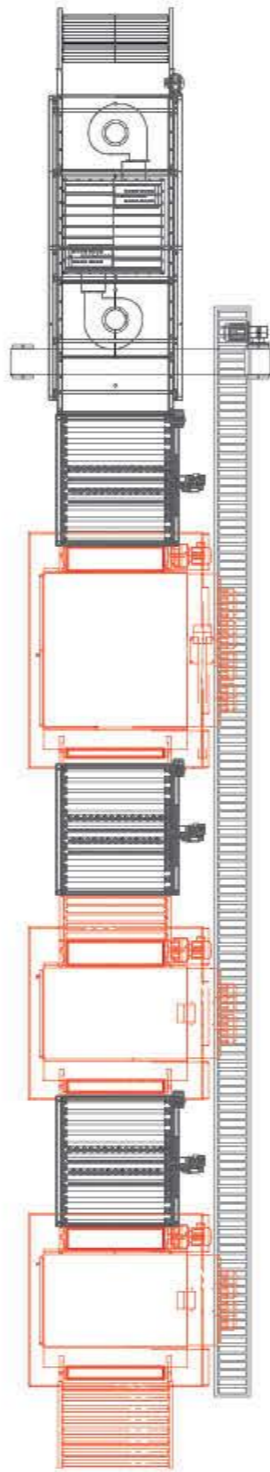
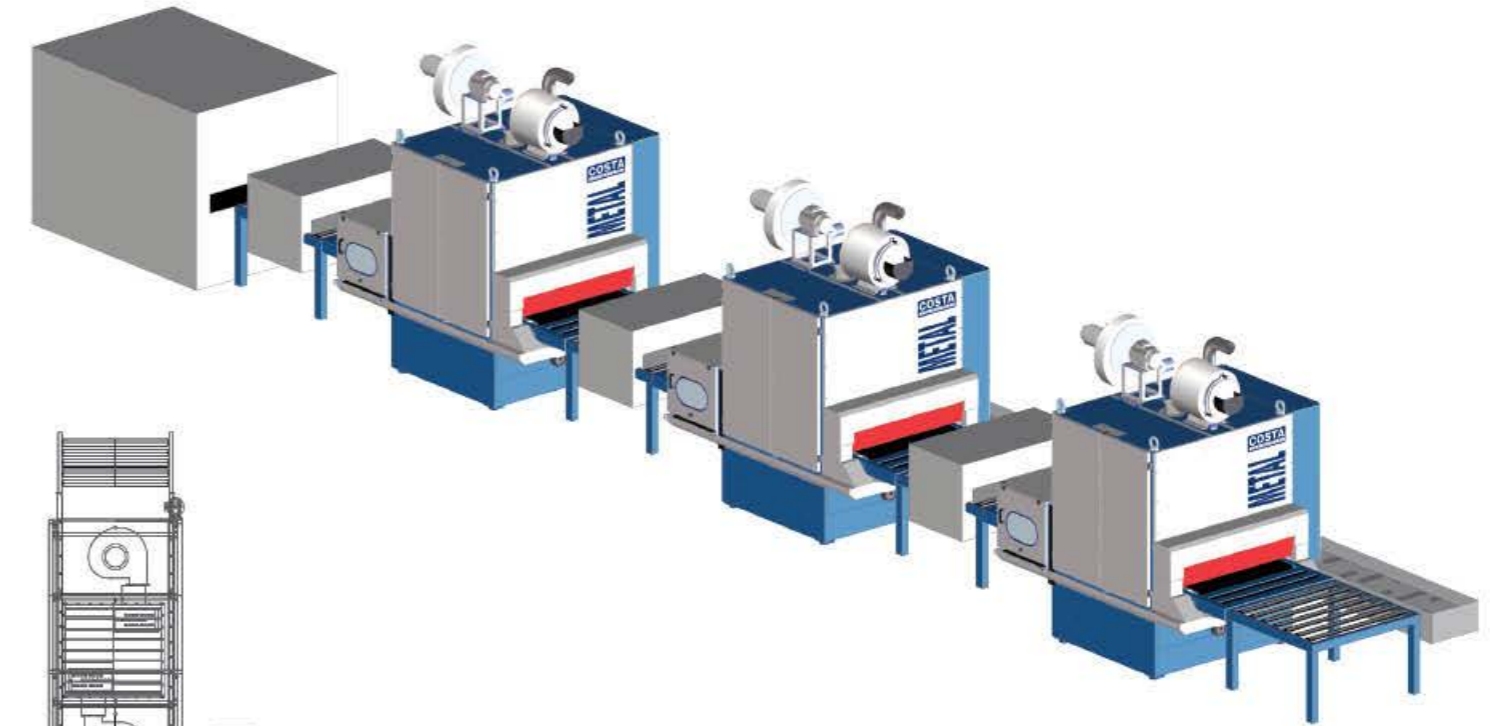

The disposal of the sludge is made in an inclined lateral channel that conveys the sludge into a dredge. The extraction of the waste is automatic, just before the drying station, while the coolant is conveyed to a centralized filtering system. The work-pieces are conveyed in an hot air oven for drying.

top machine available from 1 to 5 working units



working units suitable for installation in any position inside the frame

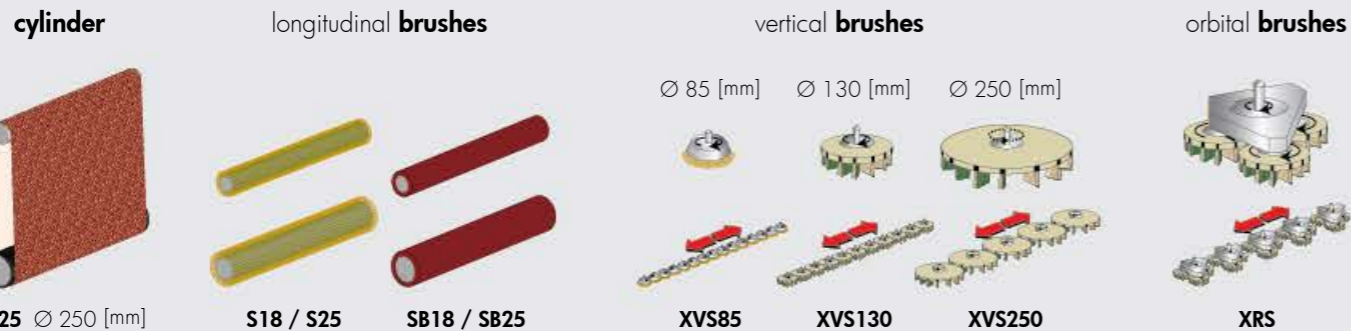

Internal partition made of stainless steel sheets, installed inbetween each working units, designed to be easily extracted for maintenance operations.

Fan for the pre-drying unit

Mist filtering unit installed on the top of the machine, to absorb the mist generated in the working process. The condensed coolant is recovered into cooling system.

The main motors of the working units are installed in the top part of the machine frame for improved safety.

The Pre-drying system is installed on the outfeed and it's made of a set of squeezing rollers and a series of air knives to eliminate the liquid from workpiece surface.



Cleaning+cooling system, with a set of jets of coolant liquid spryed onto the working units. The system is built with stainless steel pipes and special jet nozzles; the pipes are built to be easily disassembled for maintenance. Emergency stop in case of low level or absence of coolant.



Pre-drying of processed work-pieces

Textile filtering system

A stainless steel pan is positioned all around the machine frame and feed table, to recover the coolant.



Textile filtering system

It is positioned in the rear side of machine, and it is complete with automatic unwinder and feed of the filtering cloth. The sludge and the used cloth filter is automatically collected in a separate container.

Automatic Magnetic Separation of magnetic residues (opt.)

It is installed prior to the textile filtering system, recommended for heavy operations that generate a lot of sludge. It optimizes the efficiency of the cloth filter by separating the sludge magnetically prior to cloth filtration.



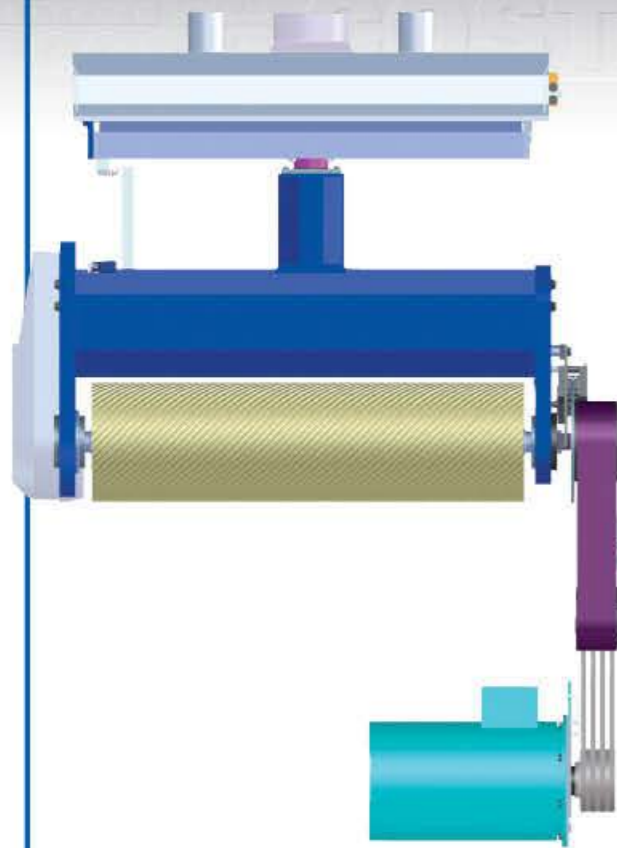

Heavy-duty rigid supporting beam to sustain the working units and the sanding belt tensioning system. The working units are adjustable from right to left to maintain the parallelism with the feed table.

Disk brakes with pneumatic clamps. They are equipped with non ferrous brake pads to avoid sparks.

Transmission with Poly V belt system with double pneumatic tensioning system for high power motors.

Transmission with V Belts with mechanical / pneumatic tensioning system.

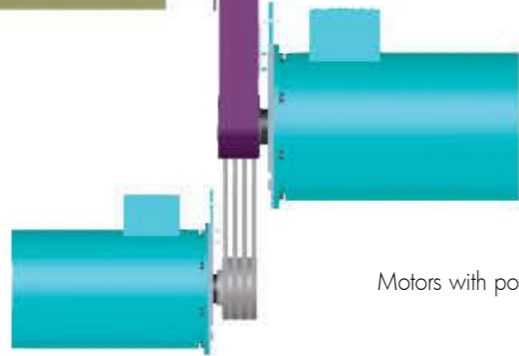

Motors with power exceeding 30 kW are positioned outside machine frame.

Motors with power up to 30 kW are positioned inside machine frame.

The feed belt is made of rubber, with different properties depending upon the application required. The feed belts may have different rigidity, shape and profiles, and they can be punctured when installed in conjunction with a vacuum feed bed.



oscillating cleaning blowers for feed belt cleaning

Our feed tables are manufactured with high rigidity T1 steel (300/400 Brinell) to ensure grinding-deburring precision tolerance (+ - 0,025mm). The surface is grinded to a very low rugosity maximize feed belt life. Our feed tables can be equipped with vacuum system to guarantee the hold-down and traction of small and oily parts.

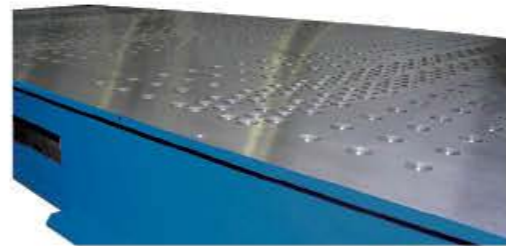

Feed tables surface with intakes for vacuum plant

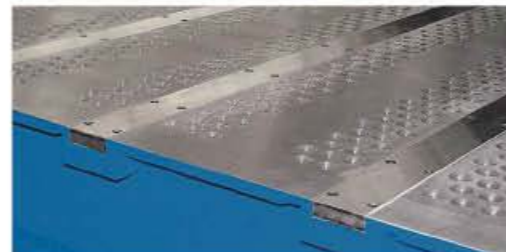

Interchangeable inserts in hardened or ceramized steel (opt.)

They are positioned under the working units and can be extracted easily for maintenance. The inserts can be equipped (opt.) with liquid cooling system (complete with heat exchanger), an important feature needed when the process require to hold very high precision tolerances.

Pressure units

The safe traction of the work-pieces is determined by the rigidity of the pressure units. At the same time these units must be able to adapt to the thickness variation of work-pieces.



Safety in-feed sensing roller for over thickness limit

Two switches installed onto the infeed sensing roller, allow this safety device to stop the feed and exclude all the working units if the roller detects a work-piece having thickness exceeding the programmed value.

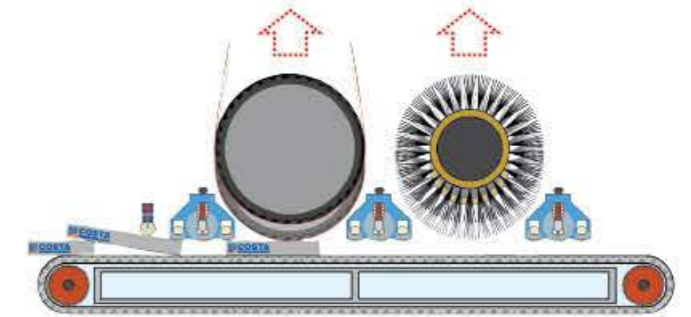

Optional devices

Magnetic Hold System

A series of magnetic elements are inserted in the feed table, either in the full width or in a partial section of the machine width. The magnets create a stronger hold and a better traction of smaller work-pieces.

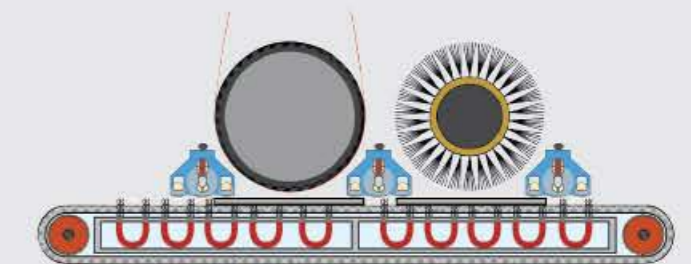

Floating Cylinder

Cylinder unit is equipped with floating system to allow the processing of warped work pieces.

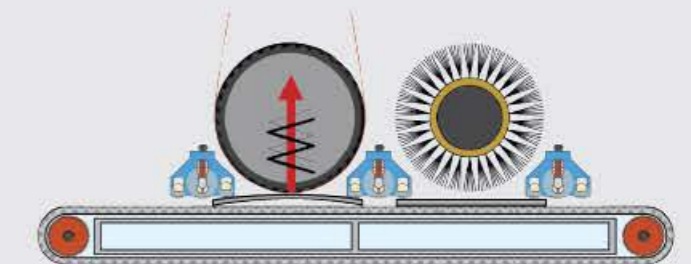

Feed with Automatic Return Cycle

It allows the return of the processed parts through the reverse of the feed direction and the automatic exclusion of all working units.

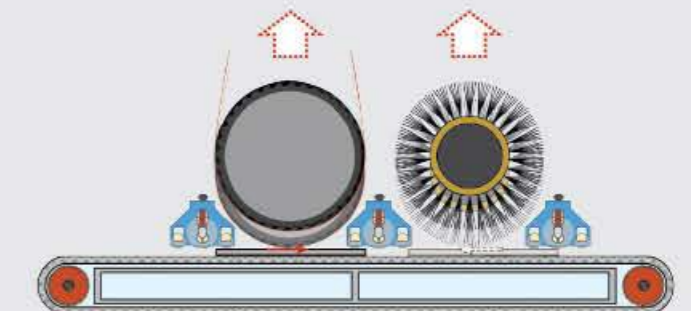

Working units: cylinders

Working unit with cylinder \varnothing 250 / 330 mm.
Cylinder covered with special rubber, oil and heat resistant with special high temperature bearings for high cutting speed applications.

hard rubber cylinder

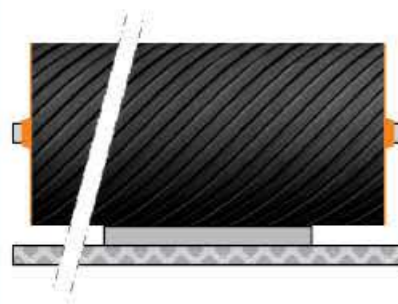

soft rubber cylinder

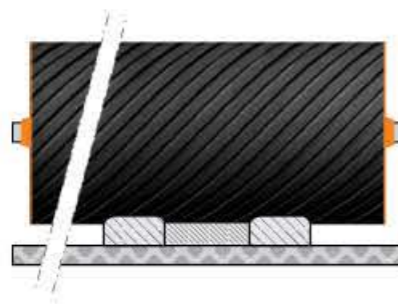

Pneumatic Grit-set + Stand by

Device for adjusting the cylinder height in relation to the grain of the abrasive belt used. It is equipped with a 9 position revolver selector and pneumatic stand by.

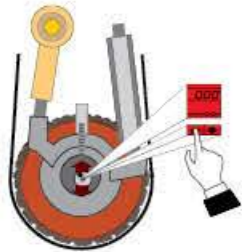

Electronic Grit-set (opt.)

System for centesimal positioning of the cylinder height in relation to the abrasive belt grit. Includes pneumatic stand by. Centesimal read-out display on the main control panel.



Sanding belt tracking

Electronic belt tracking photocell complete with self cleaning system.

Safety micro switch

To stop the machine in case of abrasive belt mis-tracking or breakage.



Working units: electronic sectioned pads



The perimetral deburring unit is composed of an identification system of the geometrical shape of the workpiece to be deburred. It is controlled by a PLC which activates a series of pneumatic sections (with 32 mm or 16 mm definition) that apply the necessary pressure on the abrasive belt on the perimeter of the workpiece only, thus removing the burrs. The advanced system management via PLC allows to vary the amplitude and the pressure of the working area as required.

The main benefits of this working unit are:

- to **process only the edges** (with control of width) to facilitate the welding operations;
- to **remove only the burrs** without affecting the remaining surface (significant power and sanding belts savings);
- **high capability to deburr / polish warped workpieces** thanks to the excursion control of each section of the perimetral unit (up to 6mm).

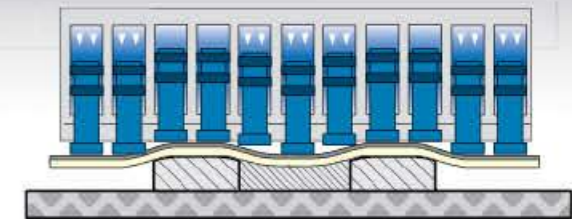

Perimetral deburring

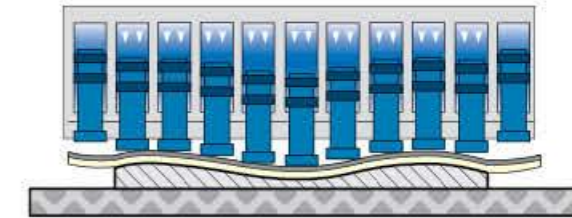

Polishing of deformed and/or uneven pieces

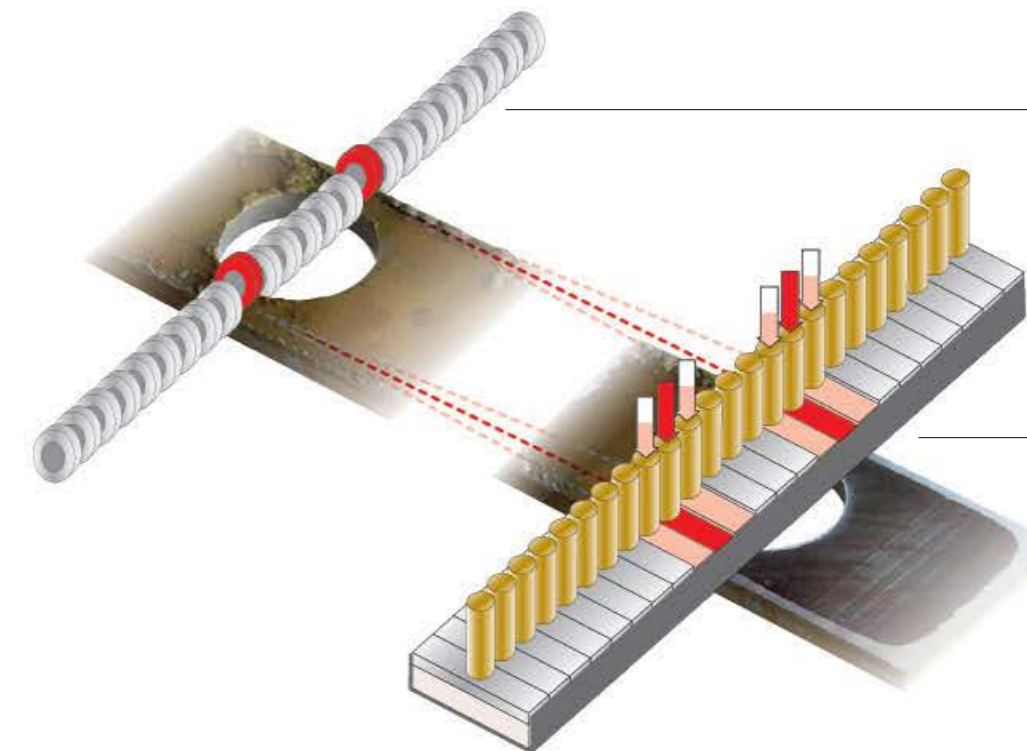

Form detecting

Infeed sensing bar with rubber covered wheels and inductive sensors. It detects the presence of the workpiece along with its form and size.

Form processing

Pressing system - acting on each-one section with pneumatic or electromagnetic pressure

metal pad section, it distributes the pressure of the upper element on the underlying layers composing the pad

intermediate contact element, interchangeable depending on the application

sliding surface made with low friction material, it works in contact with the abrasive belt and it is easily and economically replaceable in case of wear.

sanding belt

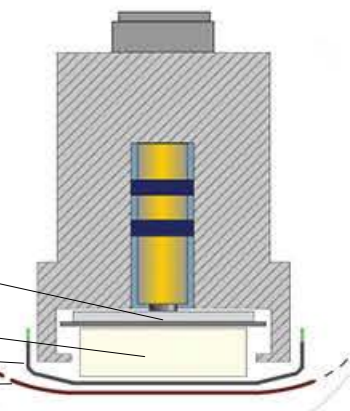



The stainless steel brushes eliminate the cutting edge without rounding the edges. The Scotch-Brite™ brushes are utilized for finishing and reducing the rugosity after the treatment with abrasive belts. Our brushes are installed inside the machine frame, they are available with diameters of 180 / 250 mm, they can be equipped with oscillation and feature high power motors.

Motorized height adjustment of the brush unit, with electronic control of the height quota and centesimal read-out on the control panel.



High frequency lateral oscillation system.

S18 / S25 - Stainless Steel brush

F2 - Brush with abrasive strips

SB18 / SB25 - Scotch-Brite™ brushes



XVS - top unit

It is composed of a series vertical brushes, rotating at high speed (inverter controlled) and oscillating side-ways at adjustable rate of oscillation. Combining the vertical axis rotation with high frequency oscillation allows to achieve a perfect deburring in all directions with a single working unit. The XVS unit is ideal for a multitude of operations: deburring, oxide removal, edge rounding, etc. The flexibility of the abrasive brush cups ensures a perfect burr removal also on up-formed parts, and on material with protective film, galvanized, pre-painted, zinc coated, etc.

The working pressure adjustment is electronically controlled through the main panel. The pressure units are adjacent to the brush unit to reliably process small parts. The XVS unit is extractable to simplify the tool change and regular maintenance.

It is designed to operate with standard, low-cost, brush cups as well as more specialized, custom-made, brushes.

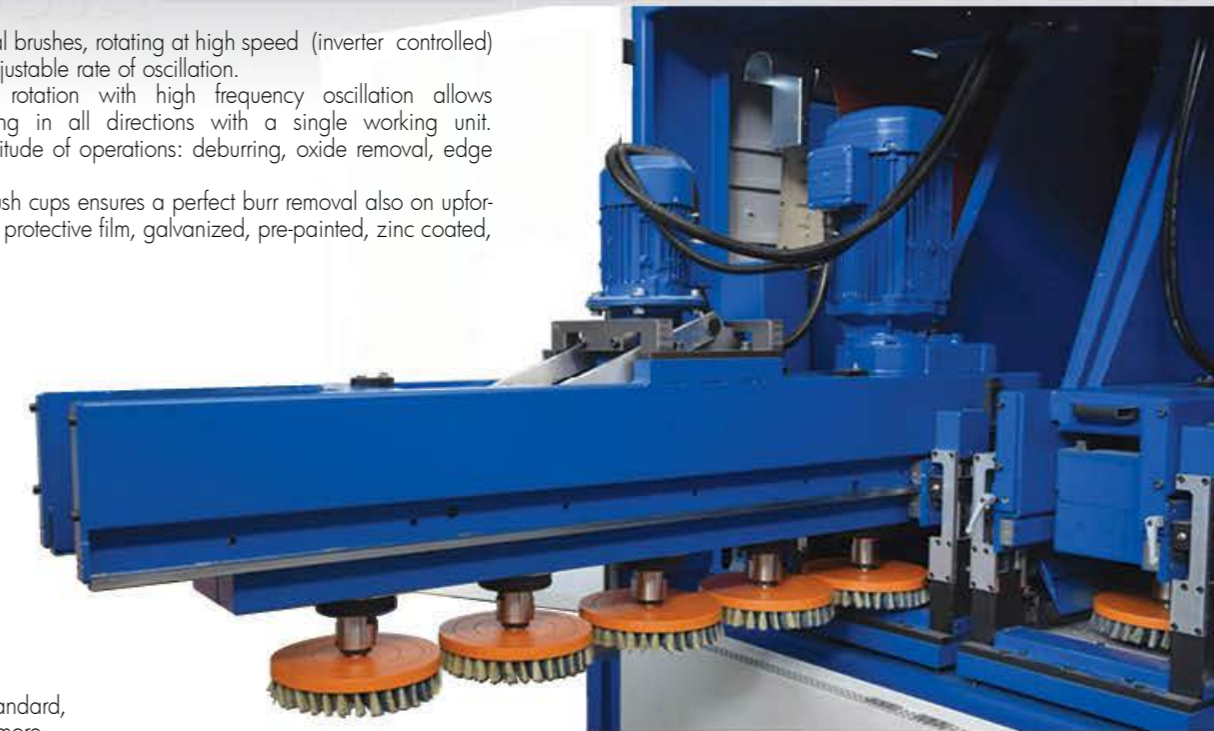

available units

XVS85
n° 15 x Ø 85 [mm]



XVS130
n° 11 x Ø 130 [mm]



XVS250
n° 5 x Ø 250 [mm]



for machines with 1350 [mm] working width

XVSi - bottom unit

It is installed in the rear side of the machines and it has the same features of the "XVS" unit. It can be used in combine with the top unit to process the pieces both sides in one single pass. If it is not required any bottom process the unit can be excluded by closing the machine, in this case it's possible to process also small parts.



Working units: **Orbital Multi-Brushes (Planetary)**

The R unit is extractable to facilitate brush tool replacement and maintenance operations.
The R unit is designed to operate with standard, low-cost, brush cups as well as custom-made brushes for special applications.
This working unit is installed inside the main machine frame. Depending upon the work type and feed speed, we can configure more R units in sequence.
The orbital brushes rotate on their axe and at the same time they rotate in number of three.
The entire unit is oscillating for covering all the working surface, giving a perfectly homogeneous rounding on the edges of any geometrical shape.

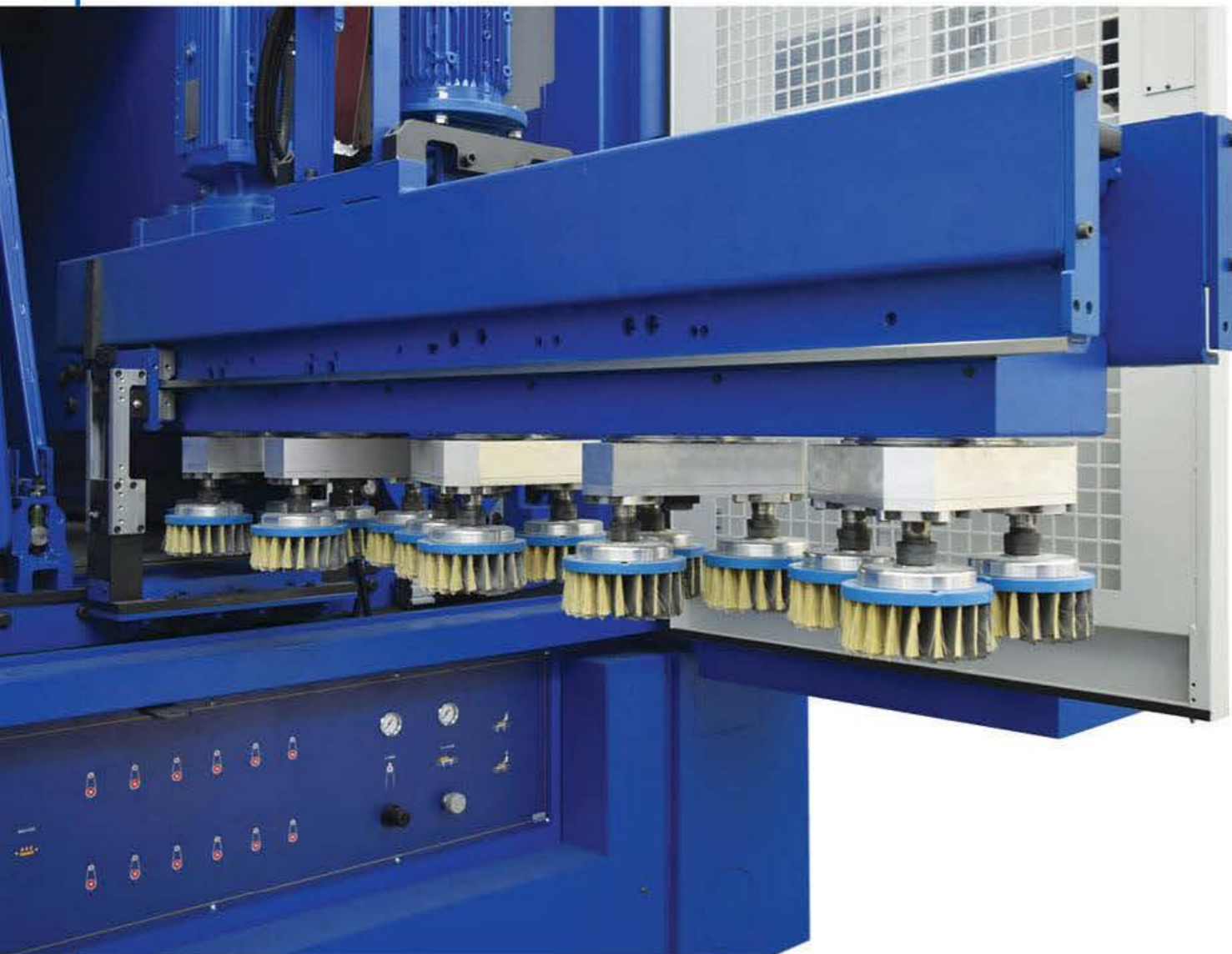
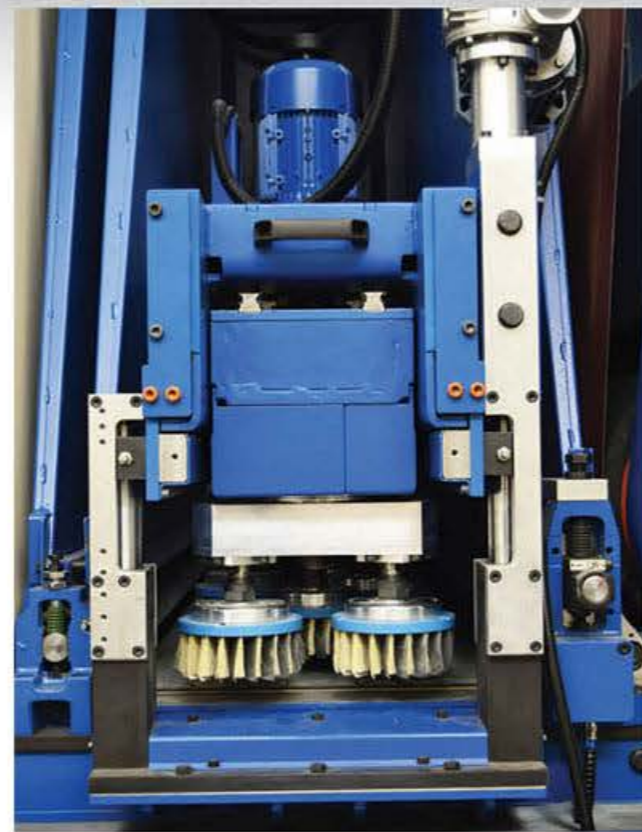

Air treatment systems



The dust generated by the process is removed through an exhaust hood and conveyed to the suction filter (optional) for the collection.

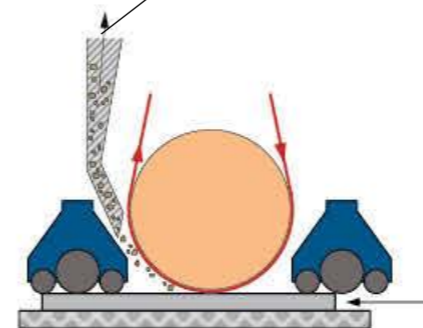

Optional devices

Air Return System

The air return system allows the recirculation of filtered air back into the machine.
This system is important in terms of energy savings.
The recirculation factor of the air-return system is of approximately 70% of the initial volume.
This option is only available on our constant pass-line height models.

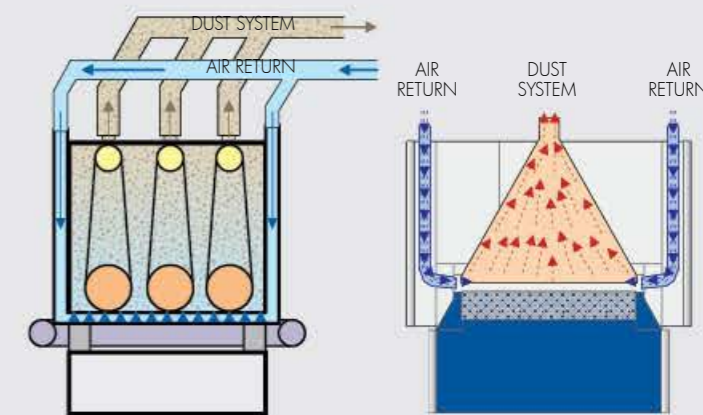

Double doors

Double doors, an internal door allows the visual inspection of the working units through a protective grid. The external door gives access to the working unit. It is equipped with soundproofing material and safety.



Soundproofing

Soundproofing booth to decrease noise emission, applicable to the vacuum system fan of all our series.

Optional devices

Cleaning brushes

SE18 - SE25 unit can be equipped with different motor power and with frequency drive.

The brushes can be:

- vegetal fibers for the dust removal;
- scotch-brite™
- with interchangeable inserts;
- steel, stainless steel, or Tynex .



Ultra-Fine antistatic cleaning brush

Brush complete with integrated micro-moistening, self-cleaning mechanism (compressed air nozzles, roto-rack), motor with inverter

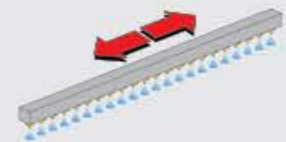
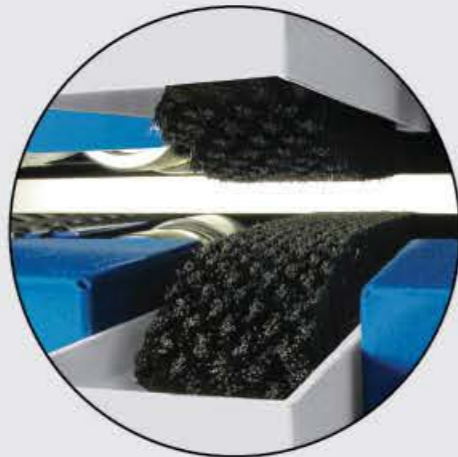

Oscillating cleaning blowers for processed parts (JL)

Timed oscillating unit for the removal of dust from the workpieces.

Feed belt cleaning blowers (JFB)

The feed belt cleaning blowers are positioned under the feed belt. They are connected to a timed entry system that enables automatically the blowing of air + water moisture to maintain a high grip of parts on the feed belt.

Transfer roller conveyor

Transfer roller conveyor, with nitrile rubber driven rollers, motorvariator + inverter and variable feed speed.



Optional devices

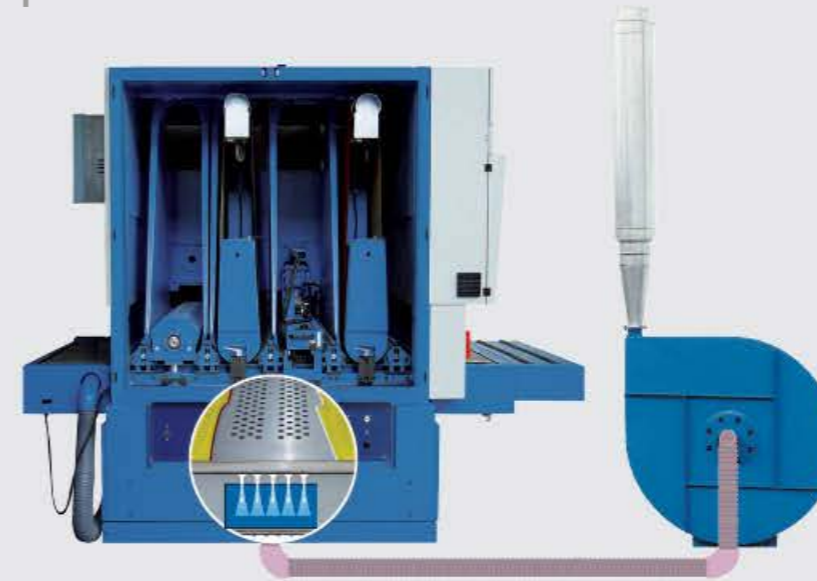

Vacuum hold system

A high speed electroventilator creates a vacuum hold under each working unit to secure the traction of sliding material or of workpieces smaller than the distance between the pressure units.

Loading/unloading table

The bearing balls table makes all loading/unloading operations easier, giving the possibility to move the workpieces being processed smoothly and with high speed transfer.

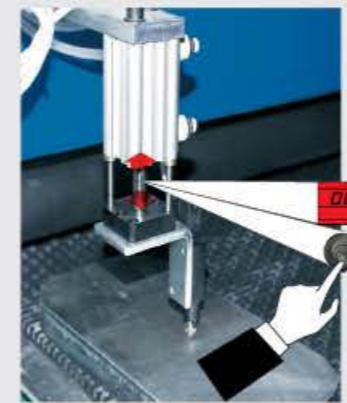

Auto-set

Automatic thickness positioning system

Air jet blowers

Oscillating unit for an efficient cleaning of sanding belts, it activates only when the workpiece is being processed.



Quick-fit

automatic arm extension to facilitate the insertion of sanding belt of length 3250 mm.



B-lock

An automatic pneumatic system locks the support of the working units to the machine frame with a precision conical coupling. This operator-friendly device helps reducing the sanding belt changing time while assuring an absolutely safe locking of the working unit.



Electromechanical Panel

Control panel positioned in front of the machine, with push-buttons for all motors and ammeter readers of power utilization of the working units.
 Digital positioner with read-out of the thickness adjustment with decimal accuracy.
 Emergency stop and reset
 Range change switch for the variation of the feed speed
 Diagnostic leds of electric-pneumaticsafety problems



PC-NC: Computer control with interconnecting possibilities

Computer controlled machine, with touch screen monitor positioned in a separate column or mounted inside self-standing board.
 This is a PC working position integrated in the company network.
 The PC control system allows to pre-set all the working programs; besides the usual controls of the machine, it can also supply complete production data such as: number of pieces processed, working time per each code, square meter produced, compressed air, volume of dust extraction, electric power consumption, etc..
 Through a modem we have the possibility to connect directly Costa Service for help and service.

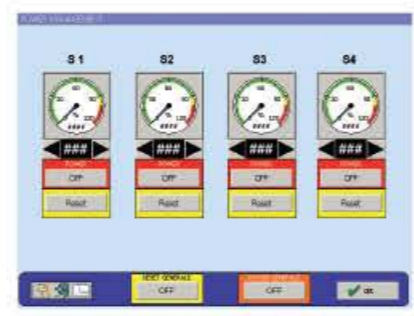
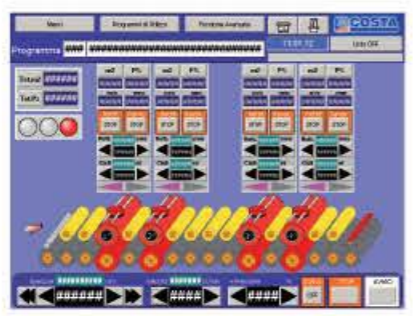

PLC VISION

The PLC panel VISION enables the visualization in a touch-screen monitor of the actual setup data and operation of the machine, and to store many complete working programmes.

Power Saving Features

The power saving features (standard), allow the use of the machine with maximum efficiency in respect of the environment.

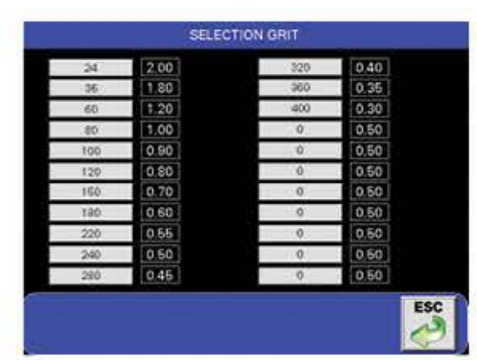
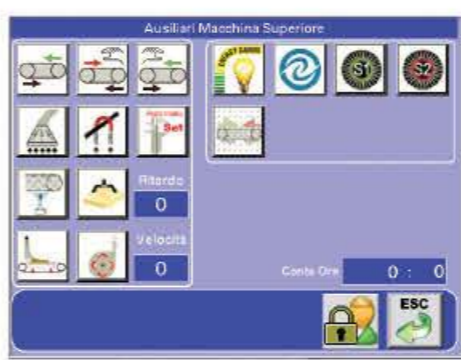
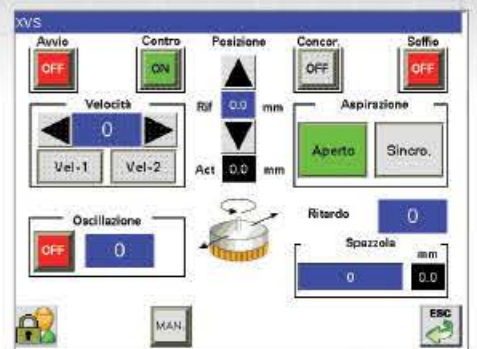
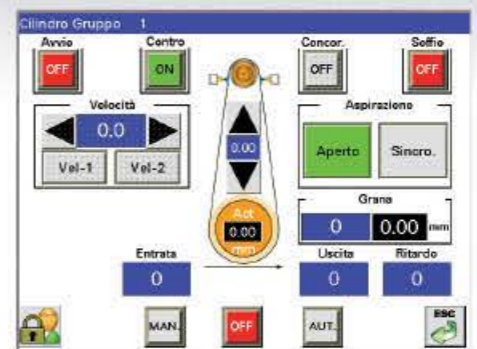

optional devices

Wireless caliper

Automatic thickness setting by means of Electronic Wireless Caliper; using this Caliper, the operator will be able to measure the work pieces being processed and send the information to the PLC VISION just with a simple click.

Barcode reader

This device allows to associate, via a gun reader, a bar code to a program saved on PLC.



touch screen monitor

Slag removal



"Wet" deburring



Oxide removal & edges rounding



Deburring, Polishing & Scotch-Brite™ Finishing

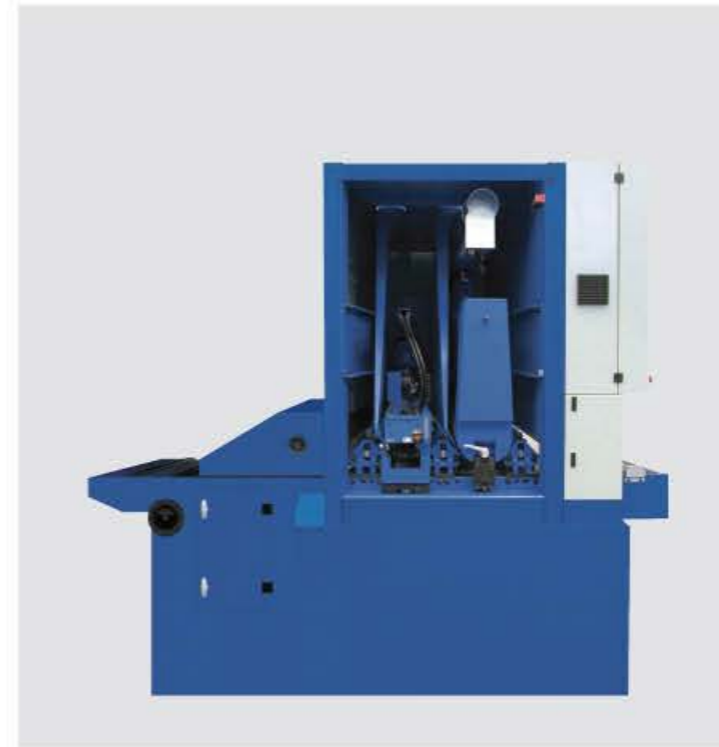
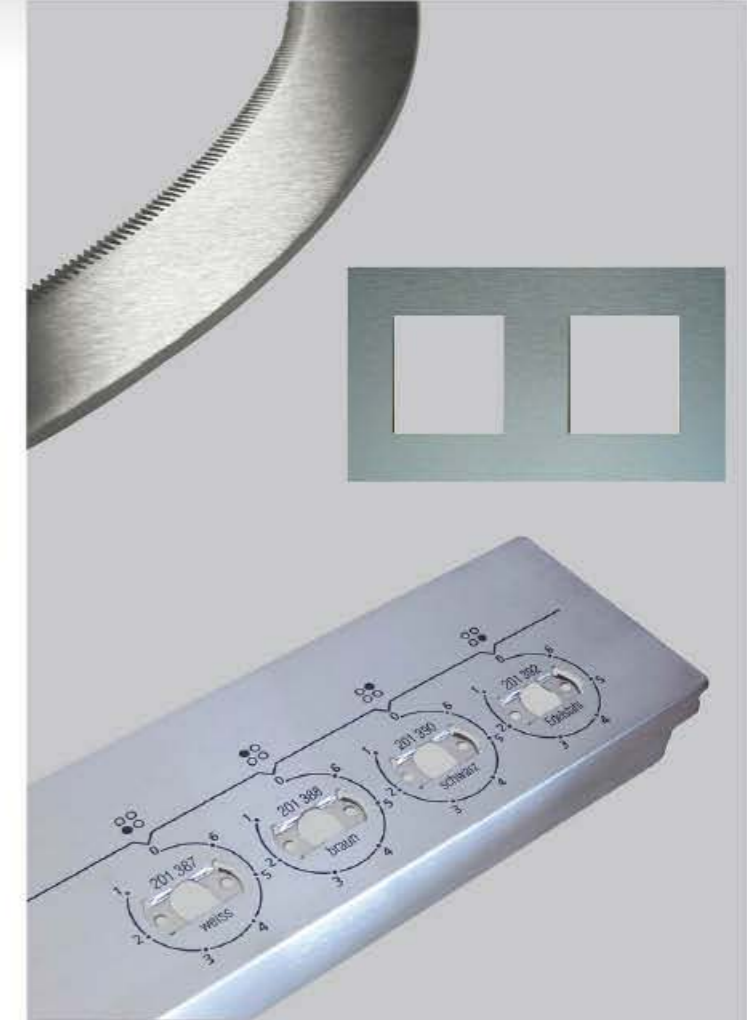

machine equipped with:

- 1° cylinder Ø 250 mm (C25)
- 2° electronic sectioned pad (CA32)
- 3° multi-function vertical brushes unit (XVS130)

machine equipped with:

- 1° cylinder Ø 250 mm (C25)
- 2° multi-function vertical brushes unit (XVS130)
- 3° cylinder Ø 250 mm (C25)

machine equipped with:

- 1° cylinder Ø 250 mm (C25)
- 2° multi-function vertical brushes unit (XVS130)
- 3° bottom multi-function vertical brushes unit (XVS85)

machine equipped with:

- 1° cylinder Ø 250 mm (C25)
- 2° orbital multi-brushes unit (XRS130)
- 3° cylinder Ø 250 mm (C25)
- 4° Scotch-Brite™ Brush (SB25)

Location: Italy - Veneto



Airports

Venezia: 90 Km - 1 h drive
Treviso: 75 Km - 1,5 h drive
Verona: 65 Km - 45 min drive
Bologna: 160 Km - 2h drive

Train Station

Vicenza: 30 km - 30 min drive

Car Directions

To the Factories in Sandrigo
Highway A31 - Exit Dueville - 3,5 km

To the Main Office in Schio
Highway A31 - Exit Thiene-Schio - 13 Km



Headquarter of Schio Via Venezia, 144 - 36015 Schio

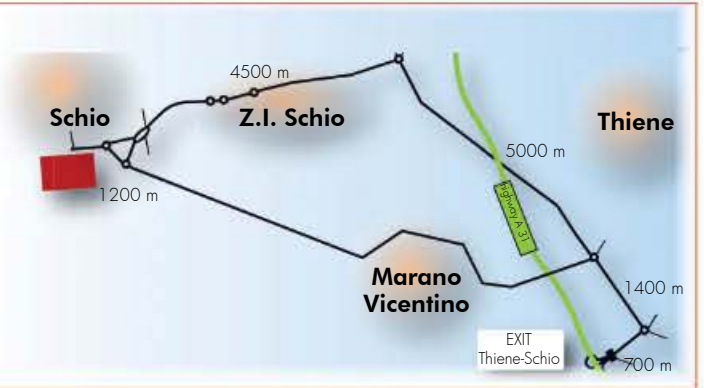

Factory of Sandrigo 2 / Sandrigo3 Via G.Galilei, 5 / Via Galvani, 3-5 - 36066 Sandrigo

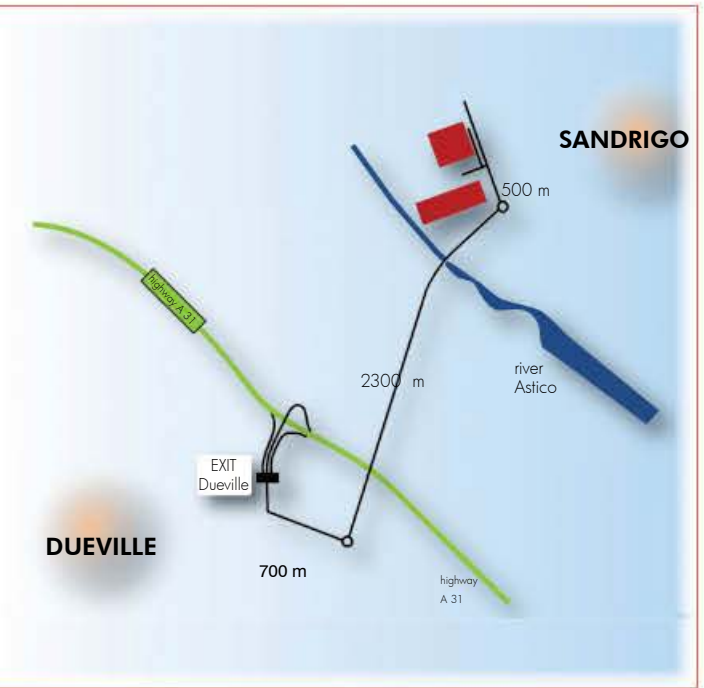

We reserve the right to change features without any notice



Costa Levigatrici S.p.A.
Via Venezia, 144 - 36015 Schio (VI) Italy
Tel. (+39) 0445-675000 - Fax (+39) 0445-675110
www.costalev.com - info@costalev.com