



AHB

TOOLING & MACHINERY, INC.

COMPLETE METALWORKING SOLUTIONS

(800) 991-4225

www.ahbinc.com

ISO Certified

customerservice@ahbinc.com

sheet metal
working center

EUROMAC®

general catalogue



Punching,
forming,
bending,
threading,
beading.
Sheet metal working center.

Euromac evolves the concept of the punching machine with a new generation of genuine sheet metal working centres. Unbeatable versatility and a vast range of machining processes compared to laser machines.

EUROMAC®

MUCH MORE THAN JUST A PUNCHING MACHINE

New monoblock frame in Meehanite® Increases productivity and reliability

greater strength and stability with twin motors on Y axis (STX) which assures: + 30% Volume +30% Speed +50% Acceleration.

Precision and stability. Your best guarantees

Designed by FEM (Finite Element Method), it provides resistance of 700N/mm² with an increase in size that enables the machine to operate at higher speeds with greater stability and thus machining precision. The head is directly built into the monoblock. Thanks to the more stable frame, machining and handling speeds can be increased even on large, heavy sheet sizes, also assisted by the third clamp and the balls fitted on the worktable.

In other words, Euromac punching machines meet the demand for high-performance, high-output units while also cutting operating costs.

Extraordinary punching flexibility

Choose your ideal configuration: single tool (A, B, C or D up to Ø 88,90 mm) or a Multitool. Who cares about the number of "stations"? What matters is the ability to set up your machine, quickly and easily, with the tools needed for the job on hand. Euromac gives you all this, and we focus on the number of "tools" (up to 66, 30 of them indexable).

Much more than just a punching machine: a complete Sheet Metal Working Centre

Often, we don't make full use of all the possibilities technology has to offer. Euromac punching machines are really complete sheet metal working centres. Every station can be tooled for forming, bending, beading and threading. Where lasers let you down.... Euromac gets the job done!

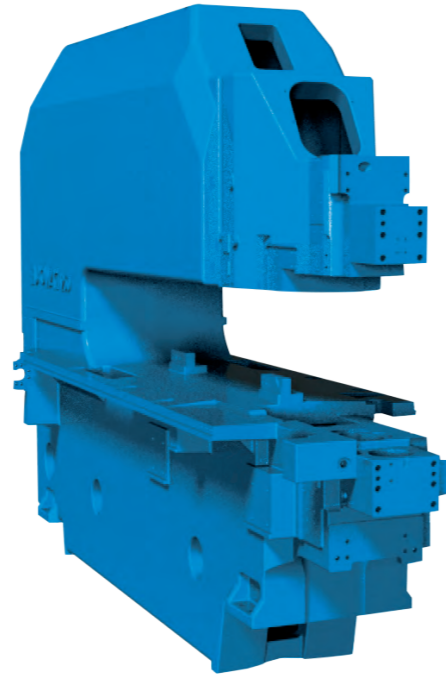

Maximum
machining
flexibility

FLEX
hybrid

FLEX Hybrid System

Which is better, Electric or Hydraulic? Why not get the best of both? Our **unique hybrid system**, which we call **FLEX**, is **patented** and combines the power of hydraulics with the precision and speed of electronic control. And it combines this with energy saving: rated at just 8.5 kW, it achieves average **consumption of a mere 4.5 kW/hour** when punching. Apart from setting the stroke of every punch, with the FLEX system you can also control:

- Hit rate from 10 to 2000 Hits/min
- Acceleration/Deceleration of ram movement
- Dwell time

Thanks to the Flex System every Euromac owner now has full control of forming operations, with absolute, constant precision, as well as the capability to handle any application with speed, reliability and cost-effectiveness.

Axis interpolation synchronised with ram travel gives excellent results in beading and offset processes, with no marks or deformations.

Innovative Autoindex system

The **direct drive** tool rotation in Euromac AutoIndex stations uses fewer mechanical components to guarantee strength, increased reliability and reduced maintenance. This improves productivity while reducing costs (patented).

Multiindex: index stations are able to index (i.e.rotate) with both single tools and our **XMTE 4, XMTE 6 and XMTE 10** Multitools.

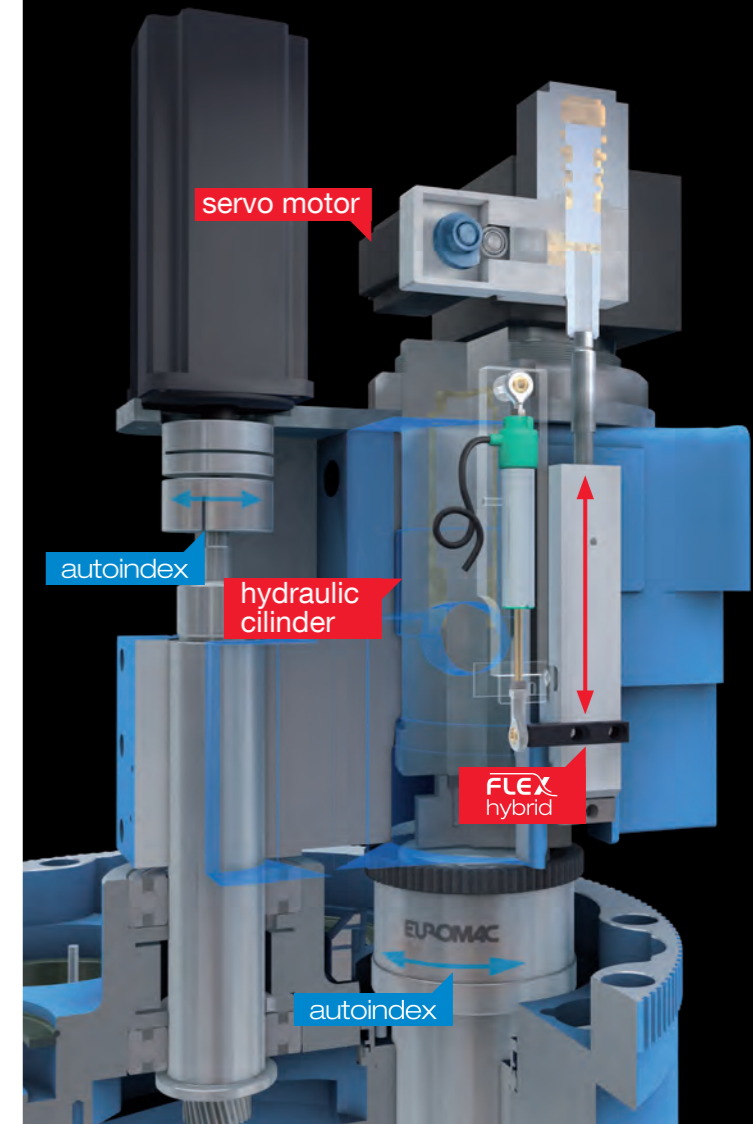

stx

FLEX 6
hybrid

FLEX 12
hybrid



Some examples from a vast array of configurations.

FLEX 6
hybrid

FLEX 12
hybrid

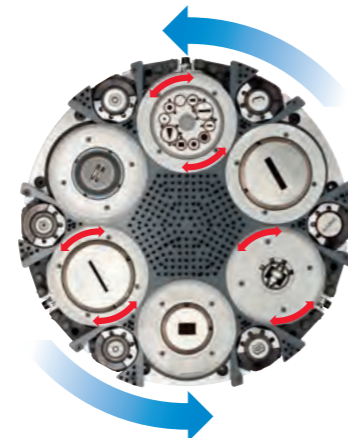

15 Tools
12 Indexed tools
3 Fixed tools

27 Tools
24 Indexed tools
3 Fixed tools

21 Tools
12 Indexed tools
9 Fixed tools

43 Tools
20 Indexed tools
23 Fixed tools

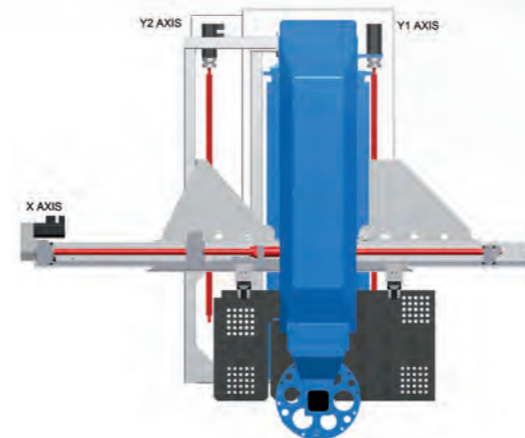

Speed, stability and precision.

The Y axis is driven by two motors for higher speed and acceleration combined with outstanding machining precision.

+30% volume
+30% speed
+50% acceleration

STX meets the demand for a high-performance, high-output machine able to optimise operating costs. Thanks to the more stable "Y" axis, machining and handling speeds can be increased even on large, heavy sheet sizes. The STX series is available with full optionals: X axis up to 2500 mm, loading and unloading, vacuum, side chute door with part sensor, combined brush and ball tables and automatic hydraulic third clamp.



Side chute door with part sensor

Eliminate micro-joints and reduce labour costs and secondary procedures with the automatic side chute door. With this innovative unloading system, finished parts of up to 1250x1000 or 1500x1000 mm (depending on machine throat size) can be discharged with no operator action). Available for STX and MTX plus.

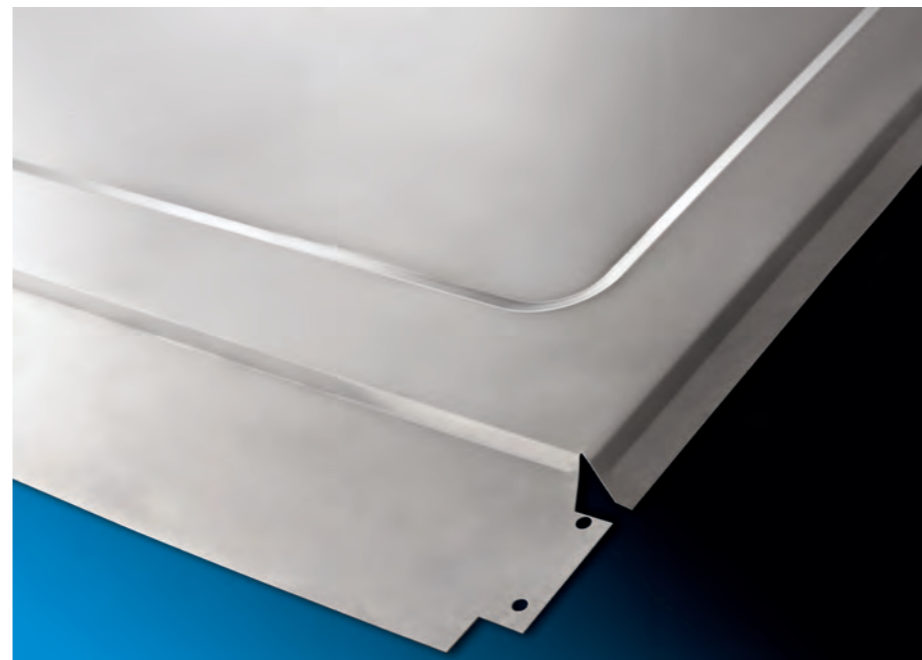
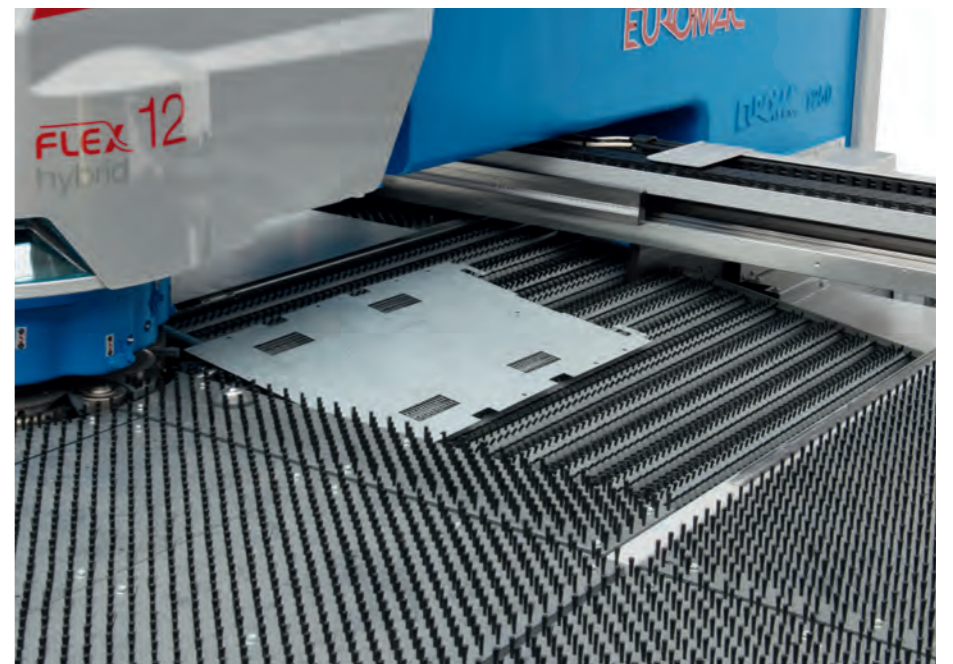

mtx plus

FLEX 6
hybrid

FLEX 12
hybrid



Some examples from a vast array of configurations.

FLEX 6
hybrid

FLEX 12
hybrid



15 Tools
12 Indexed tools
3 Fixed tools



27 Tools
24 Indexed tools
3 Fixed tools



21 Tools
12 Indexed tools
9 Fixed tools



43 Tools
20 Indexed tools
23 Fixed tools

Speed,
stability,
extreme
flexibility and
precision

The frame of the MTX plus is a Meehanite® nodular cast iron monoblock resistant to 700N/mm², designed by FEM (finite element method). The punching head is directly built into the monoblock frame. In practical terms, like all the other new punching machines, the MTX has a more robust (no welding points), reliable, precise frame which is also particularly compact, using less floor space and ensuring impressive flexibility in loading different sheet sizes. What's more, thanks to the Flex system, the MTX can punch at high speed while maintaining a constant punching depth.

This flexibility also extends to the turret setup, with 60 or 66 tools.

Autoindex System

The direct drive tool rotation in the Euromac AutoIndex stations uses fewer mechanical components to guarantee strength, more reliable machining results and reduced maintenance, with huge time savings.

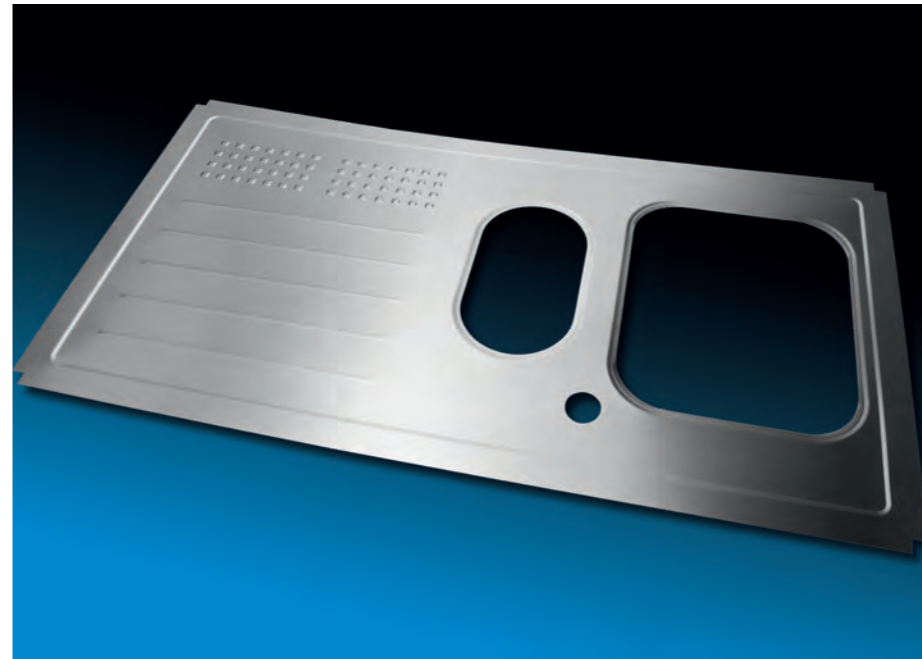

Upforming System

The 6 B stations of the MTX FLEX 12 turret feature **retractable dies** for more forming flexibility. Standard thick turret-tooling forming tools usually have an “active” die. These dies protrude a few millimeters over the normal height of a standard punch die, requiring special

attention to setup and programming. All additional 6 B-Stations of the MTX FLEX 12 can be raised up to 6 mm only when the tool is actually employed and lowered when it is passive eliminating any restriction.

PUNCHING

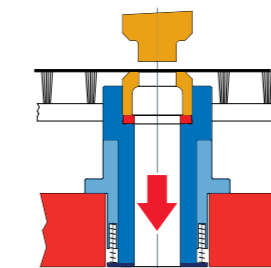

FORMING TOOL

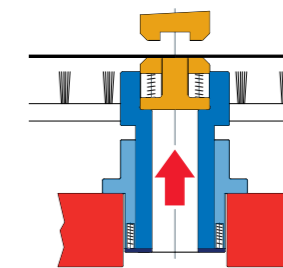

FORMING

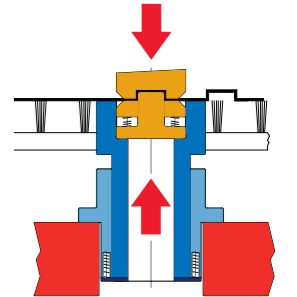

mbx plus

6
autoindex



Some examples from a vast array of configurations.



15 Tools
12 Indexed tools
3 Fixed tools



23 Tools
20 Indexed tools
3 Fixed tools



27 Tools
24 Indexed tools
3 Fixed tools

Strong,
affordable,
easy,
fast and
more ...

The frame of the MBX plus is a **Meehanite®** nodular cast iron monoblock resistant to 700N/mm², designed by **FEM** (finite element method). It is a high-performance hydraulic machine with the same high-speed axis travel as the MTX plus, achieving a hit rate of 600 per minute. It has some of the key features of Euromac Punching Machines, such as the **capability for forming, beading and notching**. The MBX plus can also be equipped with up to 60 tools, 30 of them indexed.

Autoindex System

The direct drive tool rotation in the EUROMAC AutoIndex stations uses fewer mechanical components to guarantee strength, more reliable machining results and reduced maintenance, with huge time savings.

The range of optionals available for the MBX plus comprises vacuum system, combined brush and ball tables, Multitool FMTE 10, Multitool FMTE6 and Multitool FMTE4

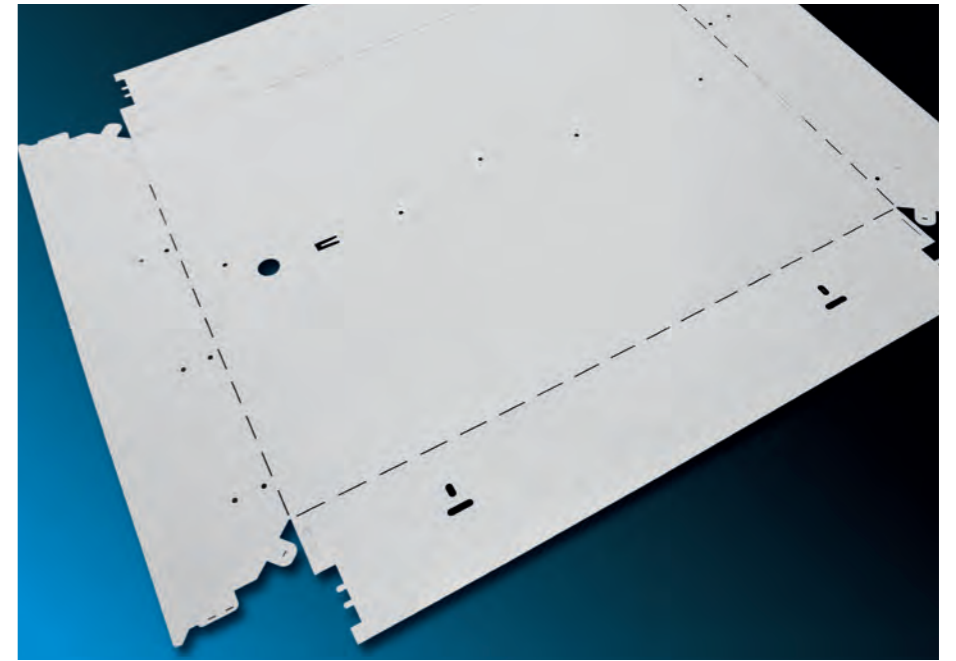

Vacuum system

Our vacuum system prevents scraps from remaining on the sheet, potentially damaging its surface and sometimes even the tool itself. Strongly recommended when processing thin materials, material with protective film or aluminium in general. Optional on all models.

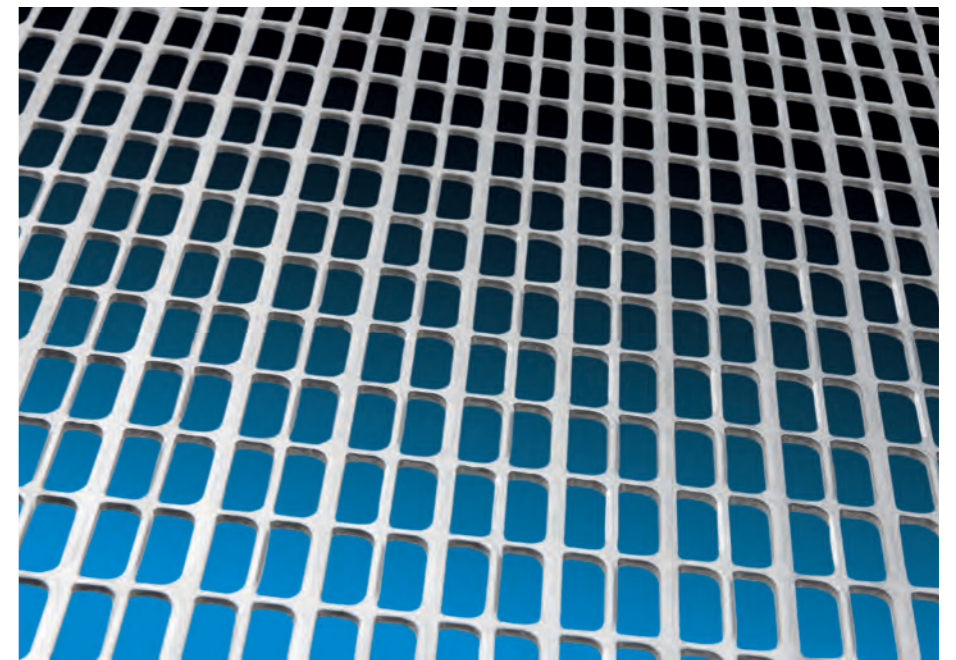

Optional

AUTOMATIC LOADING/ UNLOADING SYSTEM

Flexibility and productivity, all in one



With its unique, compact, rugged design, the Euromac automatic loading/unloading system, is available on all punching machine models (except the BX) and can be shipped fully assembled: **installation at the customer's site is quick and easy and the system is ready to go into production within just a few hours.**

Loading and unloading capacity

Easy loading of material for machining and unloading of finished parts generates much higher productivity for you.

Machining capability

As for all Euromac products, flexibility is key: just one machine can process a vast assortment of sizes. All sizes between the stated minimum and maximum dimensions can be processed.

Max. sheet size (mm)	3000 x 1500
Min. sheet size (mm)	500 x 200
Thickness (mm)	0.5-6
Sheet weight (kg)	up to 200

Double sheet loading avoidance

Magnetic blocks	Yes
Shaker system	Yes
Air blow	Yes
Automatic sheet thickness measuring system	Yes
Separator brushes for non-magnetic materials	Yes

Productivity depends not only on the machine's throughput capacity but also on a host of other factors: system programming and operation can often be critical, but not with Euromac! The single console makes programming and operation of the machine and

automatic loading and unloading system fast and simple.

Low Space Requirements

Example: an STX 1250/30-2500 combined with the automatic loading/unloading system occupies just L 6270 mm x D 5030 mm.



Loading

Max. load (kg)	3000
Max. height (mm)	300
Adjustable suction cup layout	YES



Manual loading is still possible to speed up production of small parts or batches.

Unloading

Max. load (kg)	3000
Max. height (mm)	400

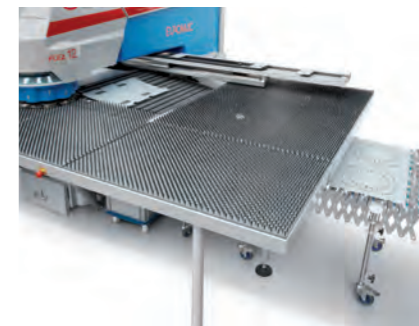

In combination with machines with side chute door, two additional unloading points are provided:
 1) up to max part size 200x200 mm
 2) up to max part size 1500x1000 mm depending on machine throat size.



machine range

All Euromac machines comply with the latest EC regulations

stx
FLEX6
hybrid

stx
FLEX12
hybrid



Optionals

Third automatic clamp.
Chute door 1250 (Y) x 1000 (X) mm or 1500 (Y) x 1000.
Vacuum system.

technical data

	stx flex 1250/30-2500	stx flex 1500/22-2500
Max. punching force (kN)	300	220
Y axis with Multitool /Monopunch (mm)		
Y = 1250	1300 / 1250	-
Y = 1500	-	1550 / 1500
X axis (mm)	2500	2500
Automatic repositioning in X (mm)	up to 10000	up to 10000
Numerically control stroke dept (mm)	from 0.1 to 31	from 0.1 to 31
Hydraulic servomotor controlled system	standard	standard
Position accuracy (mm)	+/- 0.05	+/- 0.05
Precision in forming repeatability (mm)	+/- 0.1	+/- 0.1
Bidirectional Autoindex stations	3	3
Opening of clamps (mm)	11	11
Automatic positioning clamps	2	2
Max. hit rate (1/min):		
Punching with 20 mm pitch	460	460
Nibbling with 1 mm pitch	1080	1080
Marking	2000	2000
Thickness range (mm)	0.6 - 6.5	0.6 - 6.5
Max. weight at reduced axis speed (kg)	180 *	180 *
USB port	6	6
Installed power (kW)	8.5	8.5
Average consumption (kW/h)	4.5	4.5
Approx. weight (kg)		
X = 2500	9500	9800
Overall dimensions (mm)		
X = 2500	4850 x 3630	4850 x 3880

* for sheets of over 50 kg weight combined brush and balls tables are required

mtx^{plus}
FLEX6
hybrid

mtx^{plus}
FLEX12
hybrid



Optionals

Third automatic clamp.
Chute door 1250 (Y) x 1000 (X) mm or 1500 (Y) x 1000.
Vacuum system.

technical data

	mtx flex 1250/30-1300 1250/30-2250 1250/30-2500	mtx flex 1500/22-2250- 2500
Max. punching force (kN)	300	220
Y axis with Multitool /Monopunch (mm)		
Y = 1250	1300 / 1250	-
Y = 1500	-	1550 / 1500
X axis (mm)	1300 / 2250 / 2500	2250-2500
Automatic repositioning in X (mm)	up to 10000	up to 10000
Numerically control stroke dept (mm)	from 0.1 to 31	from 0.1 to 31
Hydraulic servomotor controlled system	standard	standard
Position accuracy (mm)	+/- 0.05	+/- 0.05
Precision in forming repeatability (mm)	+/- 0.1	+/- 0.1
Bidirectional Autoindex stations	3	3
Opening of clamps (mm)	11	11
Automatic positioning clamps	2	2
Max. hit rate (1/min):		
Punching with 20 mm pitch	375	375
Nibbling with 1 mm pitch	1000	1000
Marking	2000	2000
Thickness range (mm)	0.6 - 6	0.6 - 5
Max. weight at reduced axis speed (kg)	150*	150*
USB port	6	6
Installed power (kW)	8.5	8.5
Average consumption (kW/h)	4.5	4.5
Approx. weight (kg)		
X = 1300	8100	-
X = 2250	8400	9100
X = 2500	8500	9200
Overall dimensions (mm)		
X = 1300	2230 x 3630	-
X = 2250	3990 x 3630	-
X = 2500	4850 x 3630	4850 x 3880

* for sheets of over 50 kg weight combined brush and balls tables are required

mbx_{plus}

6 autoindex



Optionals

Vacuum system.

technical data

	mbx 6 1250/30-2250	mbx 6 1250/30-1300
Max. punching force (kN)	300	300
Y axis with Multitool/Monopunch (mm)		
Y = 1250	1300 / 1250	1300/1250
X axis (mm)	2250	1300
Automatic repositioning in X (mm)	up to 10.000	up to 10.000
Hydraulic servomotor controlled system	not available	not available
Precision in forming repeatability (mm)	+/- 0.1	+/- 0.1
Bidirectional Autoindex stations	3	3
Opening of clamps (mm)	11	11
Automatic positioning clamps	2	2
Max. hit rate (1/min - 1 mm stroke):		
Punching with 20 mm pitch	300	250
Nibbling with 1 mm pitch	625	550
Thickness range (mm)	0.6 - 6	0.6 - 6
Max. weight at reduced axis speed (kg)	150*	150*
USB port	6	6
Installed power (kW)	8.5	8.5
Average consumption (kW/h)	4.5	4.5
Approx. weight (kg)		
X = 1300	-	8100
X = 2250	8400	-
Overall dimensions (mm)		
X = 1300	-	2230 x 3630
X = 2250	3990 x 3630	-

* for sheets of over 50 kg weight combined brush and balls tables are required

ZX_{plus}

FLEX hybrid

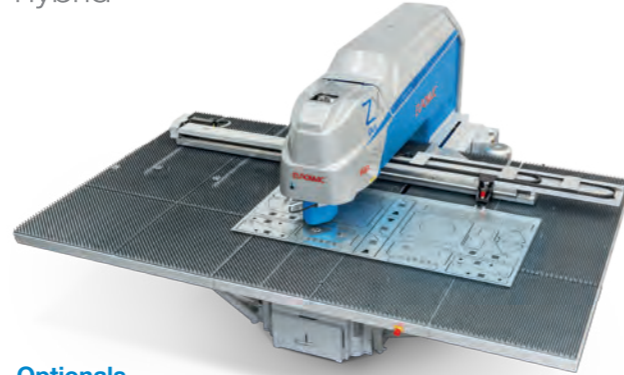

Optionals

Third automatic clamp.
Vacuum system.

technical data

	ZX flex 1250/30-1300	ZX flex 1250/30-2250- 2500
Max. punching force (kN)	300	300
Y axis with Multitool/Monopunch (mm)	1300 / 1250	1300 / 1250
X axis (mm)	1300	2250/2500
Automatic repositioning in X (mm)	up to 10.000	up to 10.000
Numerically control stroke depth (mm)	from 0.1 to 31	from 0.1 to 31
Hydraulic servomotor controlled system	standard	standard
Positioning accuracy (mm)	+/- 0.05	+/- 0.05
Precision in forming repeatability (mm)	+/- 0.1	+/- 0.1
Bidirectional "D" Autoindex stations	1	1
Opening of clamps (mm) - standard	11	11
Automatic positioning clamps	2	2
Max. hit rate (1/min):		
Punching with 20 mm pitch	375	375
Nibbling with 1 mm pitch	1000	1000
Marking	2000	2000
Thickness range (mm)	0.6 - 6	0.6 - 6
Max. thickness (mm) with op. clamps 13 mm (for copper / aluminium)	12.5	12.5
Max. weight at reduced axis speed (kg)	150*	150*
USB port	6	6
Installed power (kW)	8.5	8.5
Average consumption (kW/h)	4.5	4.5
Approx. weight (kg)		
X = 1300	7900	-
X = 2250	-	8200
X = 2500	-	8300
Overall dimensions (mm)		
X = 1300	2230 x 3630	-
X = 2250	-	3990 x 3630
X = 2500	-	4850 x 3630

* for sheets of over 50 kg weight combined brush and balls tables are required

bx_{plus} bx_{multitool}



Optionals

Vacuum system.

technical data

	bx multitool 1000/30-1250 1000/30-2250	bx autoindex 1000/30-1250 1000/30-2250	bx autoindex 1250/30-2250 1250/30-2500
Max. punching force (kN)	300	300	300
Y axis with Multitool/Monopunch (mm)			
Y = 1000	1050 / 1000	1050 / 1000	-
Y = 1250	-	1250 / 1300	1250/1300
Positioning accuracy (mm)	+/- 0.05	+/- 0.05	+/- 0.05
Opening of clamps (mm) - standard	11	11	11
Max. hit rate (1/min):			
Punching with 20 mm pitch	250	250	250
Nibbling with 1 mm pitch	550	550	550
Thickness range (mm)	0.6 - 7	0.6 - 7	0.6 - 11
Max. thickness (mm) with standard clamps	11	11	11
Max. thickness (mm) with op. clamps 13 mm (for copper / aluminium)	12.5	12.5	12.5
Max. weight at reduced axis speed (kg)	150	150	150
USB port	6	6	6
Installed power (kW)	6	7.5	8.5
Approx. weight (kg)			
X = 1250	5000	5100	-
X = 2250	5300	5400	7900
X = 2500	-	-	8500
Overall dimensions (mm)			
X = 1250	2230 x 3250	2230 x 3250	-
X = 2250	3990 x 3250	3990 x 3250	3980 x 3630
X = 2500	-	-	4850 x 3630

* for sheets of over 50 kg weight combined brush and balls tables are required



Software

PROGRAMMING

TopPunch® is the special Euromac-designed control software that runs on the machine



Optional

TOP PUNCH TOUCH

TopPunchTouch® State-of-the-art Touch Screen programming



Euromac has put a lot of effort into the development of the console software to allow simple, intuitive, yet productive programming.

TopPunch® is the special control program used on the machine. The key TopPunch® features include:

- A simple, intuitive user interface that allows parts to be produced in seconds
- Total control of the punch list, enabling you to program the stroke, speed, acceleration and dwell time for every single tool. The software also provides also automatic compensation for sheet thickness. Programmable tool grinding alerts are also available.
- Graphic turret setup management with automatic checking of consistency between the tools required by the current program and the actual configuration./
- Multitasking: programming, testing and simulation of the next part are all possible while the machine is running
- Customization to material: different lubrication rates, axis acceleration and target die clearance can be set for each material.
- Batch manager: it is not only possible but actually easy to create a job queue with full programming of the whole output of the day, week or even a longer period.

Console

The Euromac console is equipped with UPS for electrical backup avoiding data loss in case of a power failure. TopPunch® is also able to recover an interrupted program and restart operation from any point. An additional copy of the TopPunch® control software can also be installed on any PC or Laptop, allowing not only simultaneous programming but also

operation of the machine in the event of a console failure.

Teleservice and diagnostics: the user just connects the console to the Internet and using customized software Euromac will safely and remotely connect to the console to update, diagnose, check or take full control.

Online graphic diagnostics allow the operator to quickly check sensors, signals or machine status to swiftly locate the cause of any malfunctions.

Off-line programming

Customer-generated drawings in

DXF format (or most common CAD formats) can be speedily converted into Euromac CNC code by many CAD-CAM packages, readily available on the market or through our dealer network.

Languages

TopPunch® is available in the following languages: Chinese, Czech, German, Greek, English, Spanish, Persian, Finnish, French, Hungarian, Italian, Korean, Lithuanian, Dutch, Polish, Rumanian, Russian, Slovenian, Turkish, Thai, Turkish and others.

Innovation in Euromac machines includes their programming. Now, the TopPunch® software is also available in **Touch Screen** version.

This package maintains all the special features of the existing TopPunch®, but as the name suggests it **runs on a 21.5 inch rear project LCD touch screen**.

Characteristics

- Bigger, brighter screen
- Updated user-friendly graphics
- Extremely sensitive. It can even be used with working gloves.

- Step-by-step forward and backward simulation
- *Optional for the whole range of Euromac machines*
- Integral wi-fi

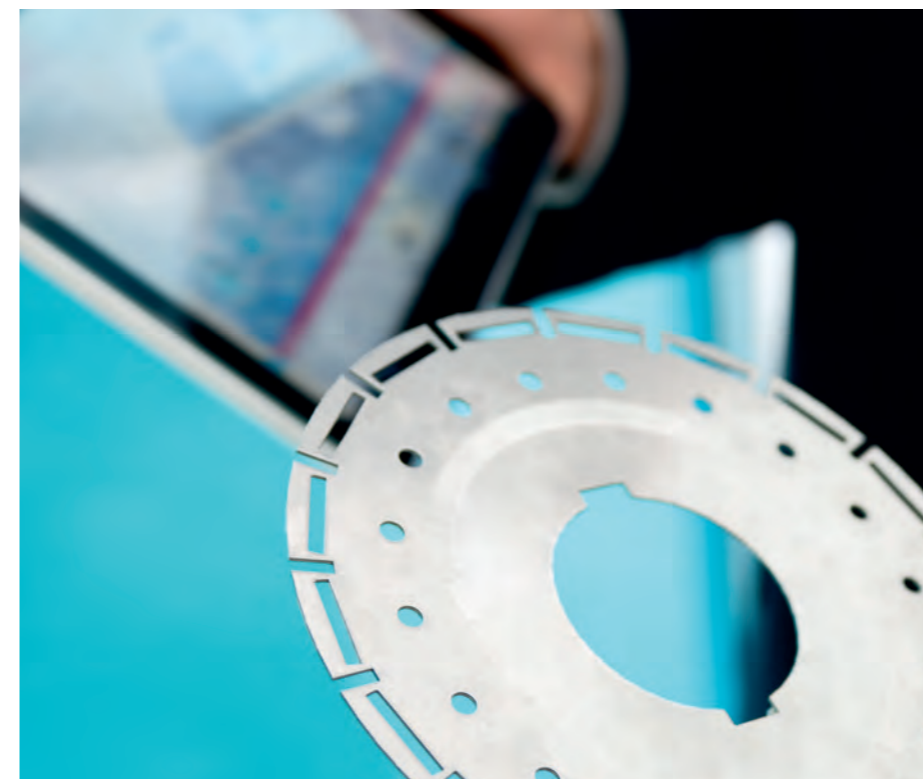
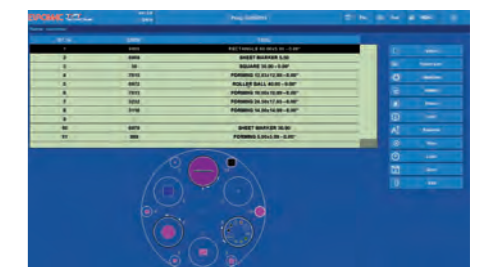

TPT
Top Punch Touch

TOOLING

Definitely one of the unique features of Euromac machines is the **flexibility of the tool system**

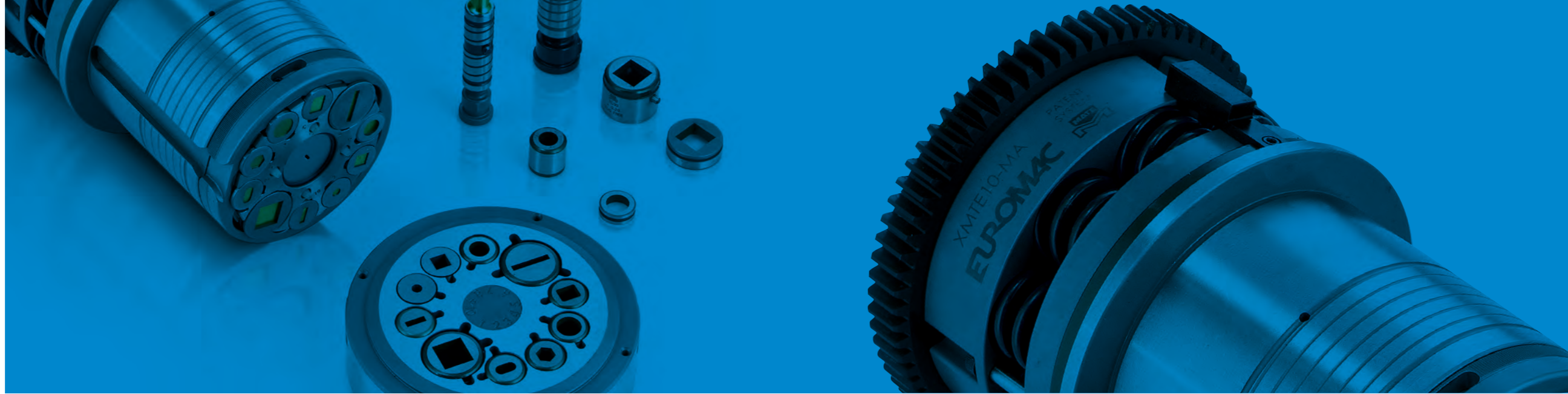

In their D stations, all Euromac punching machines accept either a single thick turret tool (type A, B, C and D – max Ø 88.9 mm) or a Euromac **FMTE 4, FMTE 6 or FMTE 10** Multitool. All Euromac Multitools can nibble or punch **up to a 200 KN capacity**. Euromac Multitools are protected by several international patents. The punch is fully guided inside the body of the Multitool, ensuring that

the hammer does not generate any side loads. Tool configuration is quick and easy thanks, once again, to innovative design. **The stripping force can be adjusted** by means of the top springs. This allows processing of both thick sheets and particularly delicate or thin materials (patented system). An optional **anti-marking** system is available for use on delicate materials. All Multitool

punches are also available in **adjustable length version** for longer working life (8mm grind life when using 1mm thick material) and optimised punch stroke.

Punching



FMTE 10
2 - Ø 24 mm /
8 - Ø 12.7 mm

FMTE 6
6 - Ø 24 mm

FMTE 4
4 - Ø 31.7 mm

Forming



Bending

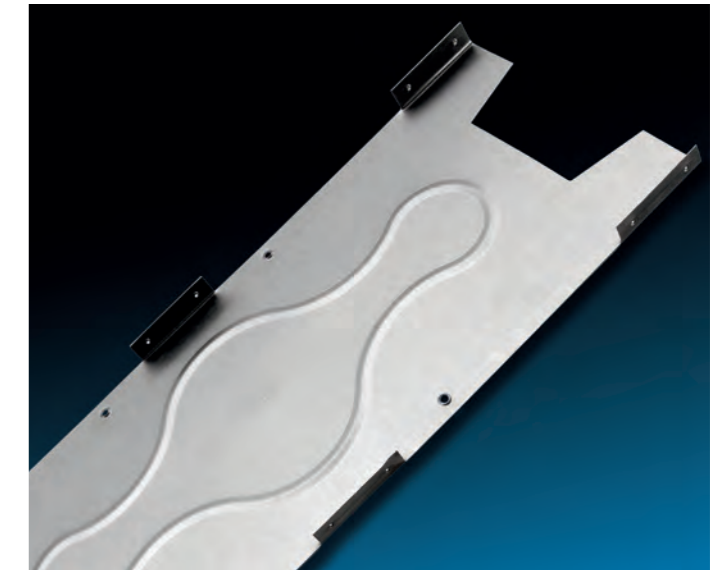

Beading

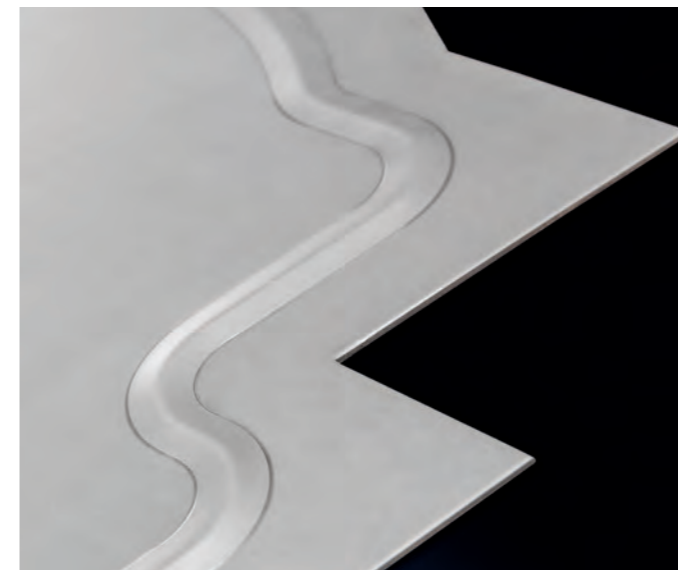

Threading

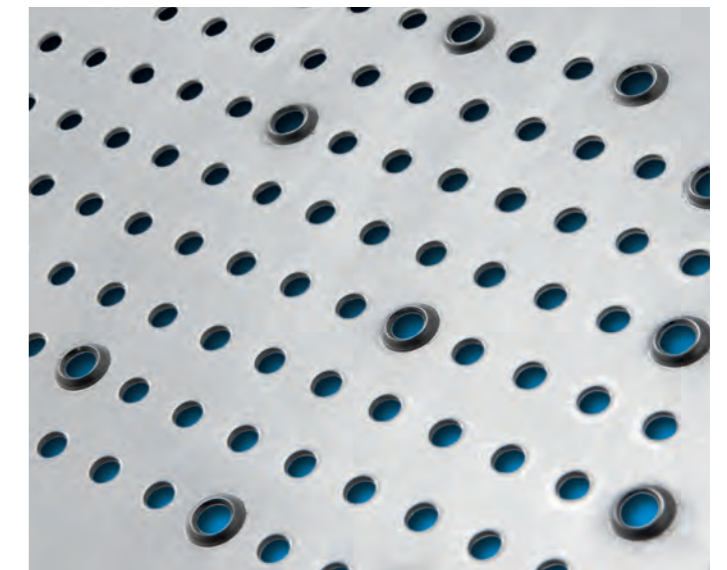

Euromac also produces:

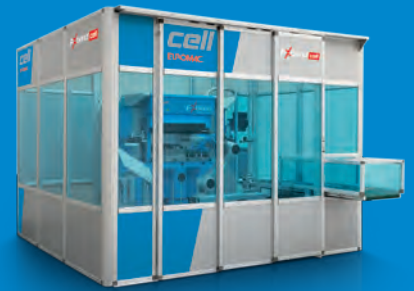

automated electric press brake



electric press brake



horizontal bending machines



notching machines

EUROMAC®

Euromac Spa
Via per Sassuolo, 68/g
41043 Formigine (MO) - Italy
Tel. +39 059 579511
Fax +39 059 579512
info@euromac.it

PRODUCED & ASSEMBLED
IN ITALY BY EUROMAC



Disclaimer.
Actual product may differ slightly from images shown in this catalogue.
All information and data on this catalogue is subject to change without notice.

www.euromac.com