

 **Flow**

SHAPE TECHNOLOGIES GROUP®

Mach 100
Waterjet Series

AHB

TOOLING & MACHINERY

COMPLETE METALWORKING SOLUTIONS

(800) 991-4225

www.ahbinc.com

ISO Certified

customerservice@ahbinc.com



Mach 100

start now.

Mach 100:

THE ESSENTIAL WATERJET

Remarkable versatility.
Maximum value.

Designed to expand your business with minimum investment, the Mach 100 waterjet is a reliable and versatile cutting solution. Made up of the same genuine Flow core components available on our elite waterjets, the Mach 100 gives you the versatility and value to kick start your production, backed by comprehensive service and support.

Whether you're adding new capabilities to your operations, are looking to prototype, or are just getting started in waterjet, the Mach 100 is the key to taking your business to the next level. **Start now.**

Cold Cutting Process » No heat or stress is imparted into your cut materials.

Satin Smooth Edge » Take the part directly off of the cutting table, no secondary finishing required.

Minimal Kerf » Minimal kerf and high accuracy combined with the ability to cut virtually any material means more opportunities.

PRECISION MOTION SYSTEM
High-end ball screw and digital drive system for premium accuracy.

ADVANCED CUTTING
Optimal cut quality and efficiency with Paser[®] 4 cutting head. Use UltraPierce[™] Vacuum Assist for piercing of delicate materials.

3-SIDED ACCESS
Easy loading and unloading of materials.

ROLL AROUND CONTROL
Move freely around your waterjet as you operate your system.

AUTO-LUBE SYSTEM
Automatically lubricates components to ensure continuous peak performance.

RIGID MACHINE CONSTRUCTION
Engineered with durable solid steel construction to support heavy production.



Pump Selection

Select from a wide array of industry leading pump technology. As the only manufacturer of both Intensifier and Direct Drive pumps, we have the right pump for every application.

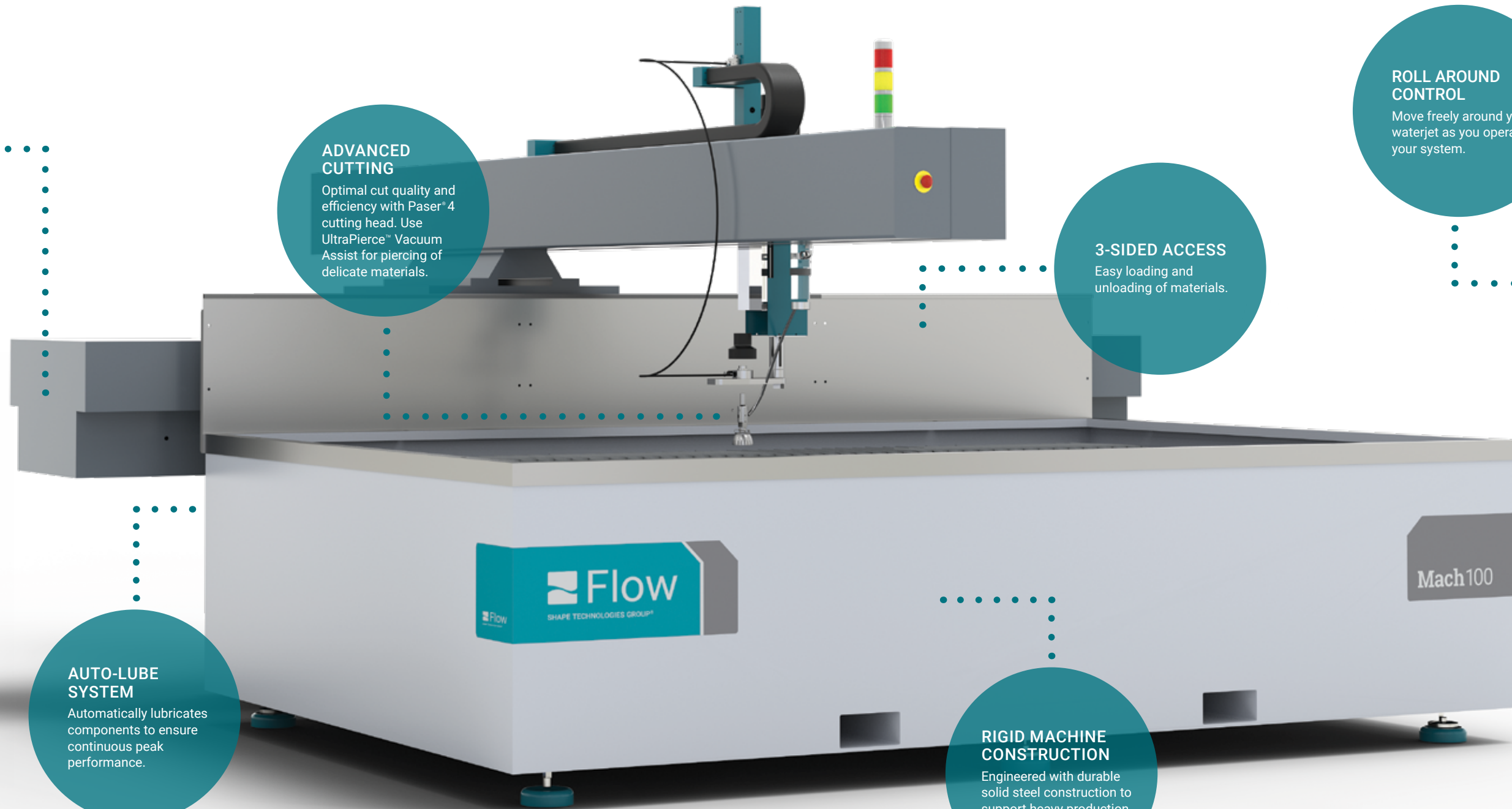

FlowXpert[®] 3D Modeling CAD/CAM Software Suite

You don't have to be an expert to program a Flow waterjet. With 40+ years of waterjet expertise built in, the software will calculate important specifications behind the scenes for you. Load your part, input material specifications, and start!

Mach 100 start now.

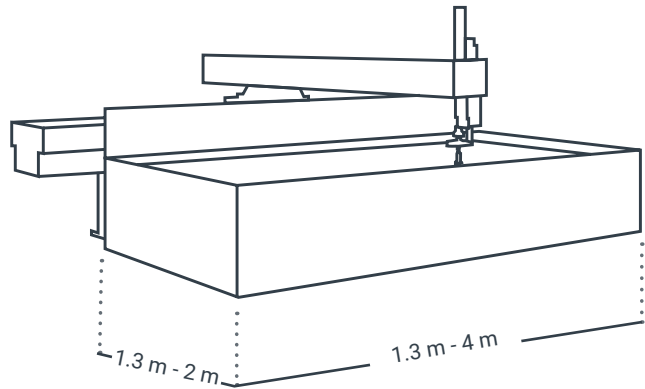

SPECIFICATIONS & CONFIGURATIONS

Linear Straightness Accuracy	→	± 0.1 mm/m / (± 0.005 in/3 ft)
Rapid Traverse Maximum	→	10 m/min / 400 in/min
Acceleration	→	0.05 g
Repeatability	→	± 0.06 mm / ± 0.0025 in
Ballbar Circularity	→	± 0.1 mm / ± 0.005 in
Z-Axis Travel	→	178 mm / 7 in
Base	→	1.3 – 4 m / 4.3 – 13 ft
Bridge	→	1.3 – 2 m / 4.3 – 6.5 ft

ANCILLARY OPTIONS & ACCESSORIES

Service Packages

FlowPath™

FlowNest®

FlowXpert®

FlowCut™

Paser CF900 Continuous Feed Hopper

UltraPierce™ Vacuum Assist

Laser Edge Finder

UNITED STATES & CANADA
23500 64th Avenue South
Kent, Washington 98032 USA
Tel: 253-850-3500
TOLL-FREE: 800-446-3569
Fax: 253-813-3285
info@flowcorp.com
FlowWaterjet.com

CENTRAL AMERICA, SOUTH AMERICA,
MEXICO & CARIBBEAN
Tel: +55-11-3616-2820
flowlatino@flowcorp.com

EUROPE, MIDDLE EAST & AFRICA
Tel: +49 (0) 6151 3095-0
info-germany@flowcorp.com







TAIWAN, CHINA, KOREA, SOUTHEAST
ASIA, AUSTRALIA & NEW ZEALAND
Tel: +86-21-5438-2222
sales.fac@flowcorp.com

JAPAN
Tel: +81-3-5789-5920
fjp@flowcorp.com

Industry Leading Support with FlowCare™

Maximize uptime and profits with our unique FlowCare support. From installation and training, to maintenance and more, we are with you every step of the way.

With FlowCare, we care for your waterjet so you can care for your business.

-  Industry leading service network
-  Rigorously trained Flow technicians
-  Comprehensive operator training programs
-  Applications support for tough cutting needs
-  Delivery of genuine OEM parts
-  Online parts ordering and abrasive packages



 **Flow**

SHAPE TECHNOLOGIES GROUP®

 **FlowCare™**