



## Attenuator guard

for 100-hp, 125-hp, and 150-hp pumps and 60-hp and 75-hp pumps with redundant intensifiers



Installation guide

809640 | Revision 0 | English

HyPrecision and Hypertherm are trademarks of Hypertherm Inc. and may be registered in the United States and other countries. All other trademarks are the property of their respective holders.

© 2016 Hypertherm Inc.

# ***Attenuator guard***

## **Installation guide**

809640  
Revision 0

English  
Original Instructions

June 2016

Hypertherm Inc.  
Hanover, NH 03755 USA  
[www.hypertherm.com](http://www.hypertherm.com)

**Hypertherm Inc.**

Etna Road, P.O. Box 5010  
Hanover, NH 03755 USA  
603-643-3441 Tel (Main Office)  
603-643-5352 Fax (All Departments)  
info@hypertherm.com (Main Office Email)

**800-643-9878 Tel (Technical Service)**

technical.service@hypertherm.com (Technical Service Email)

**800-737-2978 Tel (Customer Service)**

customer.service@hypertherm.com (Customer Service Email)

**866-643-7711 Tel (Return Materials Authorization)****877-371-2876 Fax (Return Materials Authorization)**

return.materials@hypertherm.com (RMA email)

**Hypertherm México, S.A. de C.V.**

Avenida Toluca No. 444, Anexo 1,  
Colonia Olivar de los Padres  
Delegación Álvaro Obregón  
México, D.F. C.P. 01780  
52 55 5681 8109 Tel  
52 55 5683 2127 Fax  
Soporte.Tecnico@hypertherm.com (Technical Service Email)

**Hypertherm Plasmatechnik GmbH**

Sophie-Scholl-Platz 5  
63452 Hanau  
Germany

00 800 33 24 97 37 Tel  
00 800 49 73 73 29 Fax

**31 (0) 165 596900 Tel (Technical Service)****00 800 4973 7843 Tel (Technical Service)**

technicalservice.emea@hypertherm.com (Technical Service Email)

**Hypertherm (Singapore) Pte Ltd.**

82 Genting Lane  
Media Centre  
Annexe Block #A01-01  
Singapore 349567, Republic of Singapore  
65 6841 2489 Tel  
65 6841 2490 Fax  
Marketing.asia@hypertherm.com (Marketing Email)  
TechSupportAPAC@hypertherm.com (Technical Service Email)

**Hypertherm Japan Ltd.**

Level 9, Edobori Center Building  
2-1-1 Edobori, Nishi-ku  
Osaka 550-0002 Japan  
81 6 6225 1183 Tel  
81 6 6225 1184 Fax  
HTJapan.info@hypertherm.com (Main Office Email)  
TechSupportAPAC@hypertherm.com (Technical Service Email)

**Hypertherm Europe B.V.**

Vaartveld 9, 4704 SE  
Roosendaal, Nederland  
31 165 596907 Tel  
31 165 596901 Fax  
31 165 596908 Tel (Marketing)  
**31 (0) 165 596900 Tel (Technical Service)**  
**00 800 4973 7843 Tel (Technical Service)**  
technicalservice.emea@hypertherm.com  
(Technical Service Email)

**Hypertherm (Shanghai) Trading Co., Ltd.**

B301, 495 ShangZhong Road  
Shanghai, 200231  
PR China  
86-21-80231122 Tel  
86-21-80231120 Fax  
**86-21-80231128 Tel (Technical Service)**  
techsupport.china@hypertherm.com  
(Technical Service Email)

**South America & Central America: Hypertherm Brasil Ltda.**

Rua Bras Cubas, 231 – Jardim Maia  
Guarulhos, SP – Brasil  
CEP 07115-030  
55 11 2409 2636 Tel  
tecnico.sa@hypertherm.com (Technical Service Email)

**Hypertherm Korea Branch**

#3904. APEC-ro 17. Heaundae-gu. Busan.  
Korea 48060  
82 (0)51 747 0358 Tel  
82 (0)51 701 0358 Fax  
Marketing.korea@hypertherm.com (Marketing Email)  
TechSupportAPAC@hypertherm.com  
(Technical Service Email)

**Hypertherm Pty Limited**











GPO Box 4836  
Sydney NSW 2001, Australia  
61 (0) 437 606 995 Tel  
61 7 3219 9010 Fax  
au.sales@Hypertherm.com (Main Office Email)  
TechSupportAPAC@hypertherm.com  
(Technical Service Email)

**Hypertherm (India) Thermal Cutting Pvt. Ltd**

A-18 / B-1 Extension,  
Mohan Co-Operative Industrial Estate,  
Mathura Road, New Delhi 110044, India  
91-11-40521201/ 2/ 3 Tel  
91-11 40521204 Fax  
HTIndia.info@hypertherm.com (Main Office Email)  
TechSupportAPAC@hypertherm.com  
(Technical Service Email)

### Information and hazard symbols

Some symbols in this table could be relevant to other products.

 <b>DANGER</b>	<p>This symbol identifies an imminently hazardous situation, which, if not avoided, will result in death or serious injury.</p>
 <b>DANGER</b>	<p>Dangerous voltage To reduce the risk of serious injuries or death, wear approved protection and follow safety recommendations when working with electricity.</p>
 <b>WARNING</b>	<p>This symbol identifies a potentially hazardous situation, which, if not avoided, could result in death or serious injury.</p>
 <b>WARNING</b>	<p>Do not operate this equipment without the guard installed</p>
 <b>WARNING</b>	<p>Risk of explosion</p>
 <b>CAUTION</b>	<p>This symbol identifies a potentially hazardous situation, which, if not avoided, could result in minor or moderate injury, or property damage.</p>
	<p>Refer to the instruction manual. Read and understand all of the safety guidelines in this manual.</p>
	<p>This symbol identifies a mandatory action.</p>
	<p>This symbol identifies a prohibited action.</p>
	<p>This symbol identifies tools or materials that are required or recommended for a procedure.</p>
	<p>This symbol identifies a note or helpful information.</p>



## Section 1

### Product description

---

This guard is designed to be used on a 2-liter Hypertherm or AccuStream attenuator.

The attenuator guard is intended to keep personnel safe from studs or end caps, which can become projectiles if the attenuator fails.

### Specifications

<b>2-liter attenuator</b>	181.44 kg (400 lb)
<b>Attenuator guard</b>	99.06 cm × 22.2 cm × 18.26 cm (39 in × 8-3/4 in × 7-3/16 in)
	25.85 kg (57 lb)





## Section 2

### Installation

---

Hypertherm products are designed and manufactured with a commitment to continuous quality control and safety. Contact a Hypertherm Technical Service Associate for information and support regarding the installation and repair of this equipment.





**These installation instructions are for 2-liter attenuators installed on:**

- HyPrecision models 150D, 100D, 75S with redundant intensifiers, and 60S with redundant intensifiers
- AccuStream models AS-6075, AS-60100, AS-60125, and AS-60150

For 60-hp and 75-hp models with single intensifiers, refer to 809630 *Attenuator guard installation guide for 60-hp and 75-hp pumps with single intensifiers*.

For models not identified here, contact a Hypertherm Technical Service Associate.

### Safety

	Refer to the instruction manual. Read and understand all of the safety guidelines in this manual.
 <b>DANGER</b>	Dangerous voltage To reduce the risk of serious injuries or death, wear approved protection and follow safety recommendations when working with electricity.
 <b>WARNING</b>	Personal protective equipment is recommended. Failure to wear personal protective equipment can result in injuries or death.
 <b>WARNING</b>	A person who works on deenergized machinery may be seriously injured or killed if the machinery is reenergized without permission. All workers must respect lock-out and tag-out devices. Only the person who applies a hazardous energy control device should remove it. All workers in an area where energy-control procedures are used must receive training regarding the energy-control procedure and the prohibition against removing a lock-out or tag-out device.
	Keep the work area clean and free of fluid spills.

## Installation

---

### Unpack the guard

Make sure that these items are included:

- Attenuator guard
- Attenuator guard strap kit

The attenuator guard strap kit contains:

- 2 guard straps
- 4 adhesive-backed rubber pads
- 3/8-inch wrench
- 16323 Attenuator guard installation tool kit

Refer to **16323 Attenuator guard installation tool kit** on page 26 for a list of contents.

- 16342 High-pressure tubing kit (for model 150D only)



Refer to **16342 150D attenuator guard high-pressure tubing kit** on page 26 for a list of contents.

Make sure that the equipment was not damaged during shipping. If the equipment is damaged, a claim must be filed with the carrier. Report shortages or damages to the OEM or to Hypertherm Waterjet within 10 days of receipt of the equipment.

**To install the guard on 125-hp and 100-hp models and 60-hp and 75-hp models with redundant intensifiers, refer to page 11.**

**To install the guard on a 150-hp model, refer to page 17.**

## Install the guard on 125-hp and 100-hp models and 60-hp and 75-hp models with redundant intensifiers

 <b>WARNING</b>	<p>Disconnect and lock out or tag out the electrical main and relieve all water and hydraulic pressure from the pump before installing this equipment.</p>
 <b>WARNING</b>	<p>This installation procedure requires 2 people for some tasks.</p>

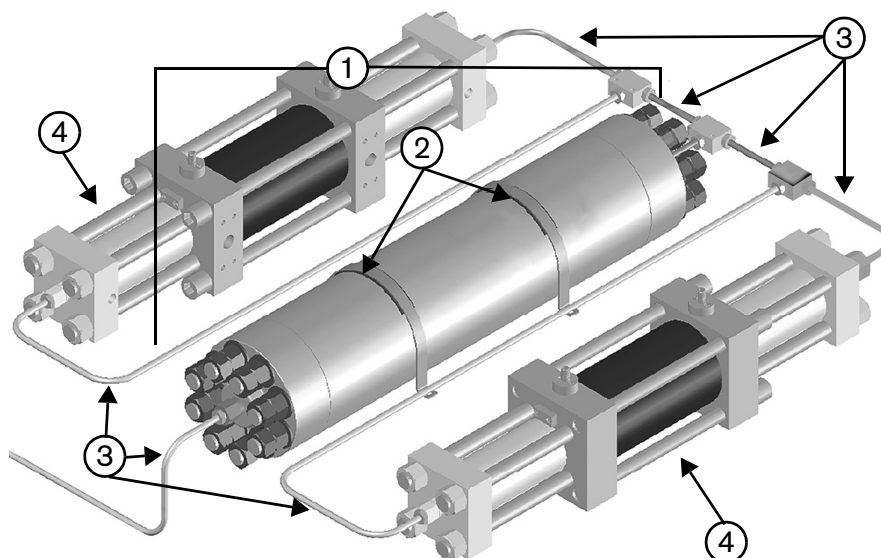

- |                     |                        |
|---------------------|------------------------|
| 1 Attenuator        | 3 High-pressure tubing |
| 2 Attenuator straps | 4 Intensifiers         |



### Required parts, tools, and materials

16320 Attenuator guard strap kit

16323 Attenuator guard installation tool kit

High-pressure antiseize lubricant such as Blue Goop or AccuGoop

13/16-inch open-ended wrench

Crane or forklift

## Installation

---

### Remove the covers and the bridge from the pump

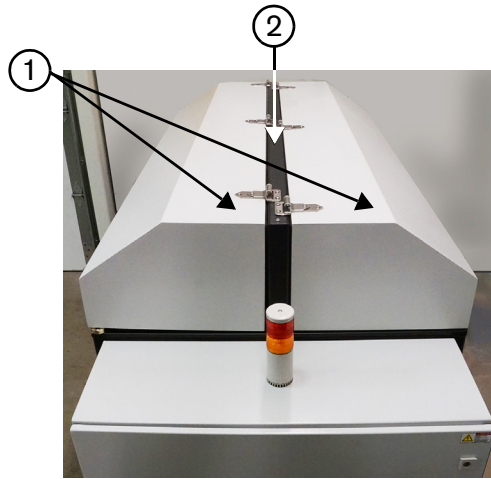

1 Covers

2 Bridge

1. Remove the screws at both ends of the bridge. If there are not screws in the location shown, remove the outermost hinge screws.

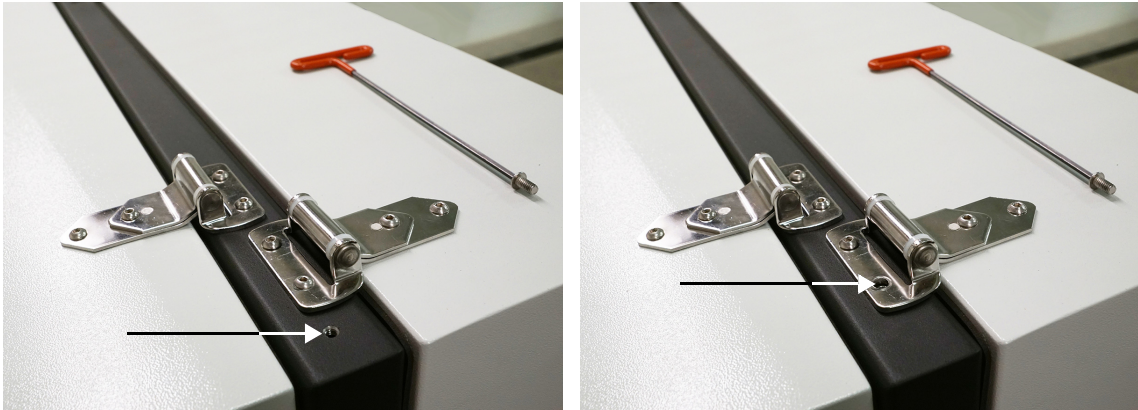

2. Put eye bolts into the bridge screw holes. Put the shackles on the eye bolts. Put a lifting strap through each shackle.



3. Use an assistant to hold 1 pump cover open.

4. Disconnect the gas shocks from both ends of the cover.
  - a. Use a small screwdriver to pry the spring-steel retainer off of the end of the shock.



- b. Hit the shock with an open hand to release it from the ball.

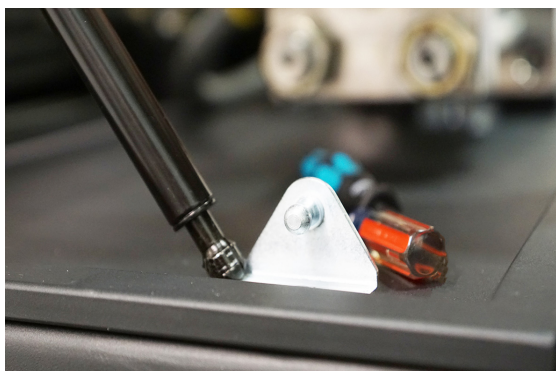

5. Remove the mounting bolts at both ends of the bridge.

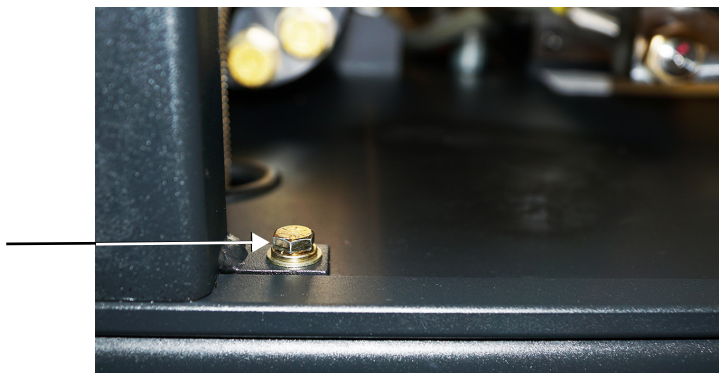



6. Close the cover.
7. Repeat steps 4 through 7 for the other cover.

## Installation

---

8. Use a forklift or a crane to lift the bridge and covers off of the pump as one unit.

 <b>WARNING</b>	Misuse of lifting equipment could cause the load to become unstable, which can result in property damage, personal injury, or death.
 <b>WARNING</b>	Lifting must be done by a trained operator. Follow all of the relevant work site safety requirements, the safety instructions for the lifting equipment, and the safety information in this guide.

### Install the attenuator guard

1. Disconnect the high-pressure tubing from both ends of the attenuator. The tubing and connections are indicated in red.

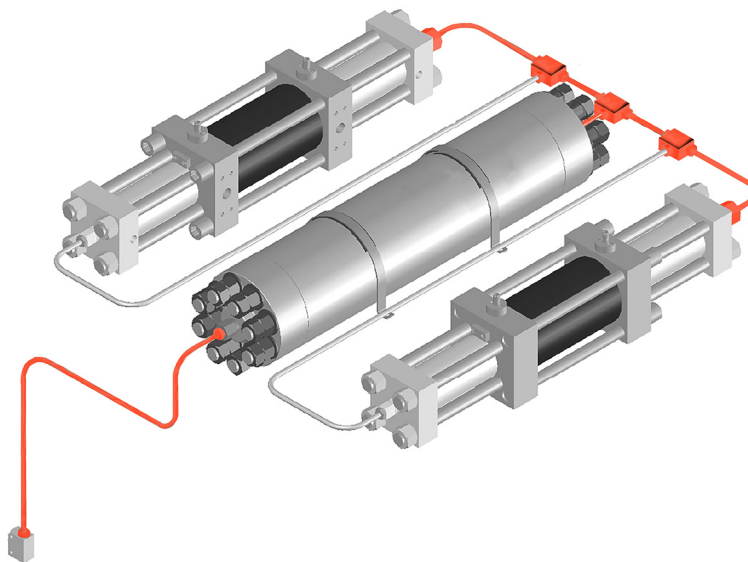

2. Put the adhesive-backed rubber pads on the tabs on both ends of the attenuator guard.

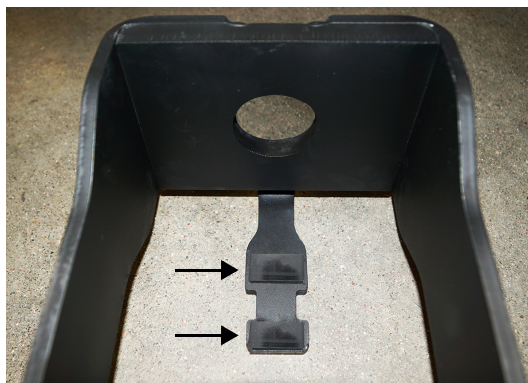

3. Use an assistant to help put the guard over the attenuator.

## Install the guard straps

1. Put the guard straps inside the guard and around the attenuator.



2. Put the ends of the guard straps into the bolt drives.

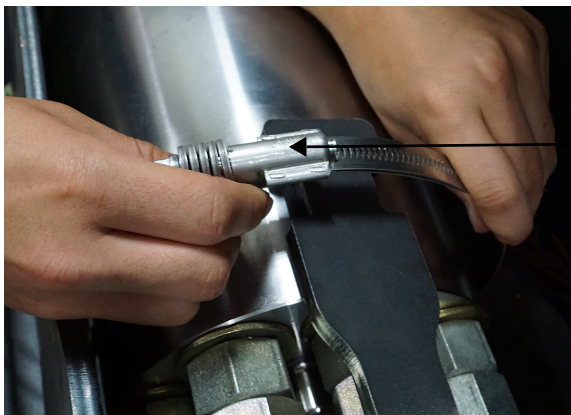

3. Put the guard straps over the tabs on the top of the attenuator guard.



4. Turn the bolt drives clockwise to tighten the guard straps.

## Installation

---



### Assemble the pump

1. Connect the high-pressure tubing to the attenuator. Torque the connectors to 68 N·m (50 lbf·ft).





Put high-pressure antiseize lubricant on the threads of all high-pressure connectors.

2. Replace the bridge and covers on the pump with a forklift or a crane.
3. Use an assistant to hold 1 pump cover open.
4. Install the mounting bolts on each end of the bridge.
5. Reconnect the gas shocks.
  - a. Hit the shock with an open hand to set it on the ball.
  - b. Install the spring-steel retainer.
6. Repeat steps 3 through 5 for the other cover.
7. Remove the eye bolts and replace the screws in the bridge or the hinge.
8. Turn ON the pump in cooling mode. Monitor for leaks. Identify the source of a leak and repair the problem.

 <b>WARNING</b>	Use a piece of cardboard or other solid material to find leaks when the pump is operating. Do not use hands, cloth, paper, or towels.
 <b>WARNING</b>	Do not repair a leak with high-pressure water in the system. Discharge all high-pressure water before working on this equipment.



## Install the guard on a 150-hp model

 <b>WARNING</b>	Disconnect and lock out or tag out the electrical main and relieve all water and hydraulic pressure from the pump before installing this equipment.
 <b>WARNING</b>	This installation procedure requires 2 people for some tasks.

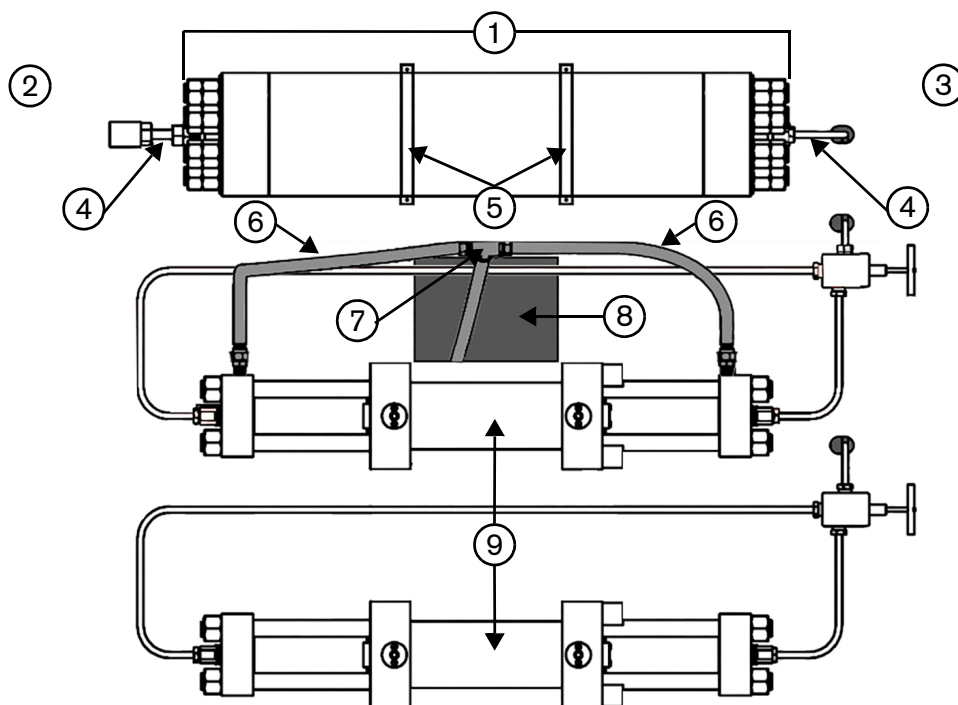

- |                        |                      |
|------------------------|----------------------|
| 1 Attenuator           | 6 Low-pressure hoses |
| 2 Left end             | 7 Tee connector      |
| 3 Right end            | 8 Access hole        |
| 4 High-pressure tubing | 9 Intensifiers       |
| 5 Attenuator straps    |                      |



### Required parts, tools, and materials

- 16320 Attenuator guard strap kit
- 16323 Attenuator guard installation tool kit
- 16342 High-pressure tubing kit
- High-pressure antiseize lubricant such as Blue Goop or AccuGoop
- 13/16-inch open-ended wrench
- Crane or forklift

## Installation

---

### Remove the attenuator from the pump

1. Remove the attenuator access cover.

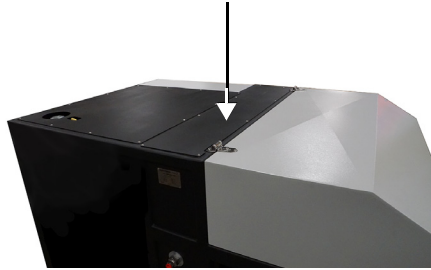

2. Disconnect the high-pressure tubing from the right end of the attenuator. The tubing and connections are shown in red.

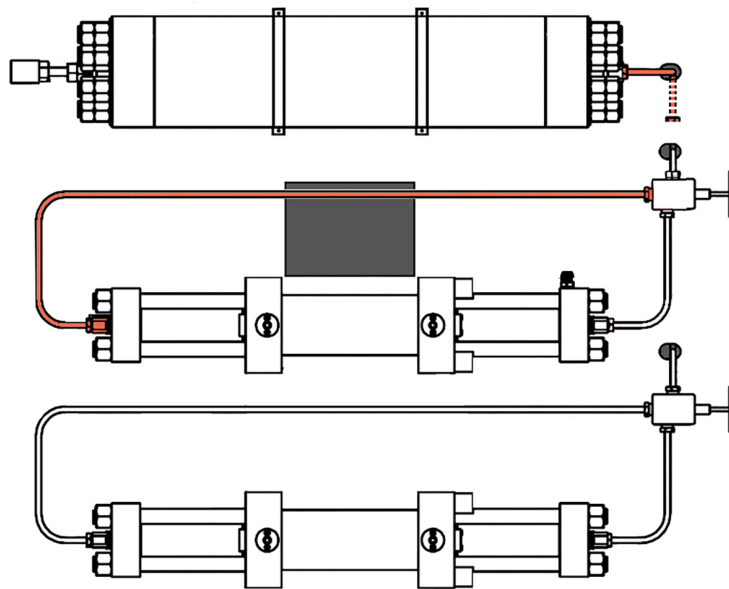

 It might be necessary to loosen or remove other high-pressure connections.

3. Remove the high-pressure fitting and tubing from the left end of the attenuator. Remove the elbow, the fitting, and the tubing that connect to the high-pressure tee below the pump 's top deck. Dispose of these parts.

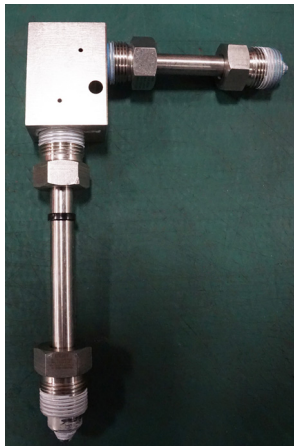

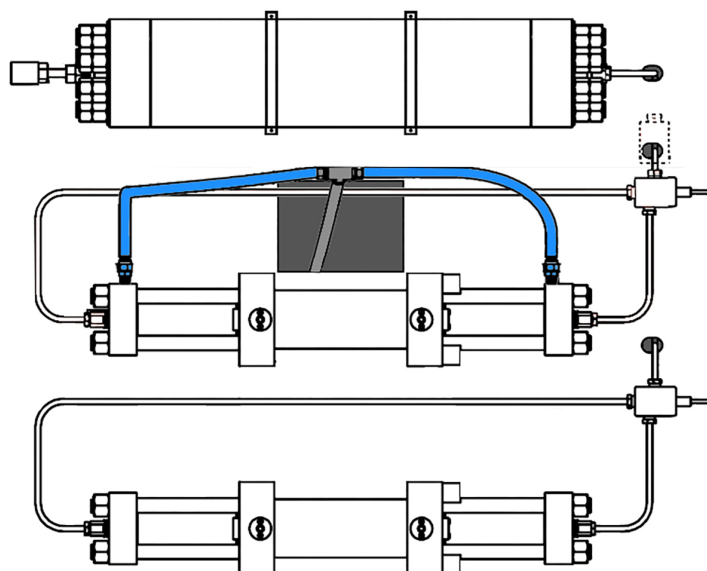

4. Disconnect the low-pressure water hose from both ends of the intensifier. The hoses and connections are shown in blue.



5. Push the low-pressure hoses and tee connector down through the access hole in the pump's top deck.
6. Remove the 2 attenuator straps.
7. Install an adapter from the 16323 Attenuator guard installation tool kit in the left end of the attenuator. Torque the adapter to 149.14 N·m (110 lbf·ft).

 Put high-pressure antiseize lubricant on the threads of all high-pressure connectors.

8. Lift the attenuator through the attenuator access hole with a forklift or crane.

 <b>WARNING</b>	<p>Misuse of lifting equipment could cause the load to become unstable, which can result in property damage, personal injury, or death.</p>
 <b>WARNING</b>	<p>Lifting must be done by a trained operator. Follow all of the relevant work site safety requirements, the safety instructions for the lifting equipment, and the safety information in this guide.</p>

 It is recommended that the lifting straps be secured under the 3 top bolts on the attenuator.

## Installation

---

### Install the attenuator guard

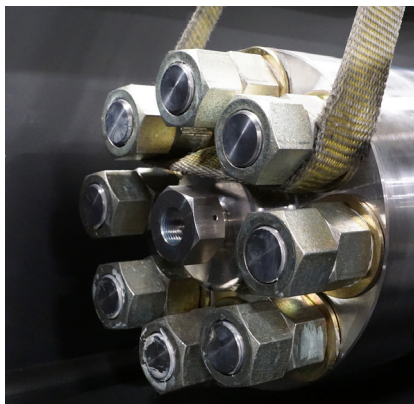

1. Put the adhesive-backed rubber pads on the tabs on both ends of the attenuator guard.

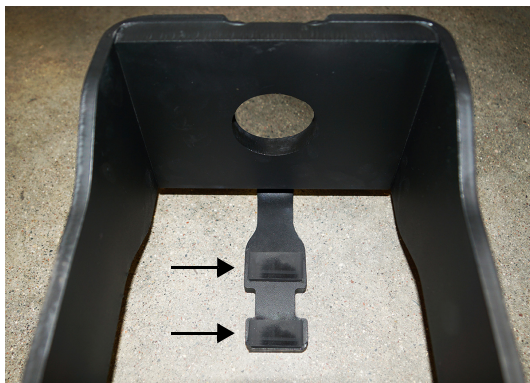

2. Use an assistant to help put the guard through the attenuator access hole onto the pump's top deck.

 Put the attenuator guard on its side with the top of the guard toward the intensifiers.



- Put the attenuator onto the attenuator supports.

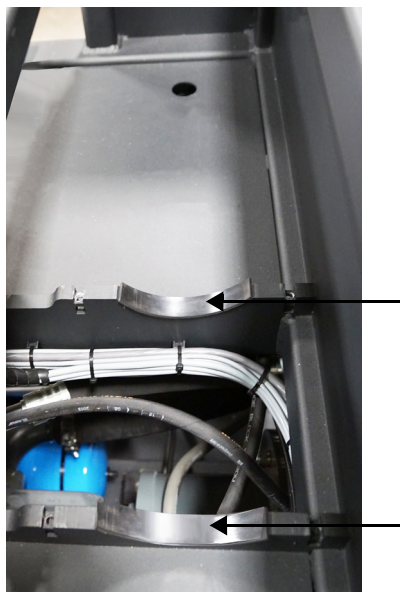

- Use the attenuator locating tool from the 16323 Attenuator guard installation tool kit to make sure that the attenuator is centered on the supports. Line up the notched end of the tool with the flat face of the attenuator body. The attenuator is centered when the support end of the tool is flat against the attenuator support.

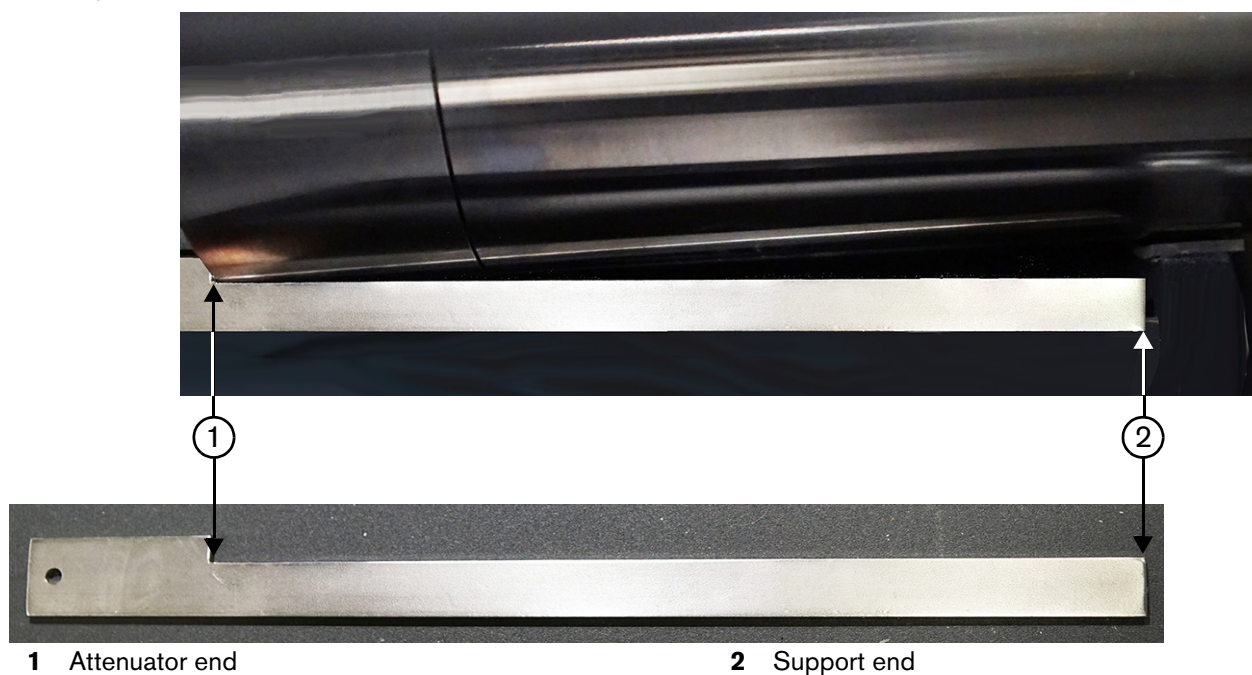

- Replace the 2 attenuator straps. Tighten the strap bolts.
- Use an assistant to help put the guard over the attenuator.

## Installation

---

### Install the guard straps

1. Put the guard straps inside the guard and around the attenuator.



2. Put the ends of the guard straps into the bolt drives.

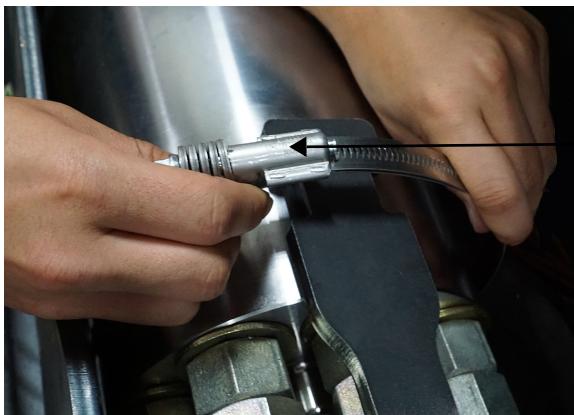

3. Put the guard straps over the tabs on the top of the attenuator guard.



4. Turn the bolt drives clockwise to tighten the guard straps.

## Assemble the pump

1. Connect the high-pressure tubing to the right end of the attenuator. Torque the connector to 68 N·m (50 lbf·ft).

 Put high-pressure antiseize lubricant on the threads of all high-pressure connectors.

2. Install the high-pressure tubing on the left end of the attenuator.



- a. Put the shorter end of the tubing assembly into the adapter in the attenuator (installed on page 19). Torque the connector to 68 N·m (50 lbf·ft).
- b. Install the remaining adapter in the high-pressure tee below the pump's top deck. Torque the adapter to 149.14 N·m (110 lbf·ft).

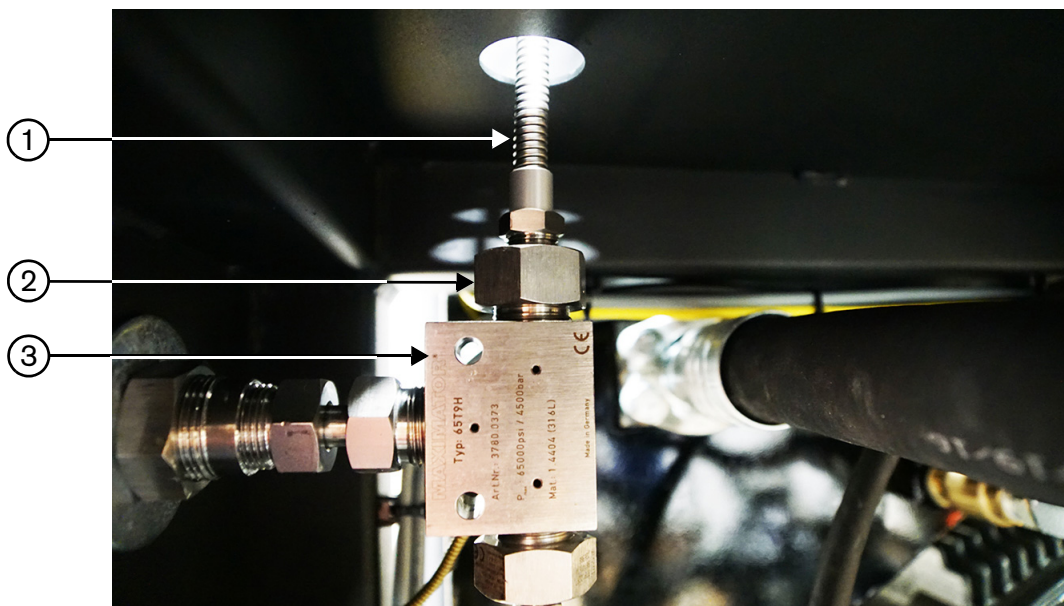

1 Tubing assembly

2 Adapter



3 High-pressure tee

- c. Put the longer end of the tubing assembly into the adapter in the high-pressure tee. Torque the connector to 68 N·m (50 lbf·ft).
3. Retrieve the low-pressure hose assembly from the access hole in the pump's top deck. Connect the low-pressure hoses to the intensifier.

## Installation

---

4. Replace the attenuator access cover.
5. Turn ON the pump in cooling mode. Monitor for leaks. Identify the source of a leak and repair the problem.

 <b>WARNING</b>	Use a piece of cardboard or other solid material to find leaks when the pump is operating. Do not use hands, cloth, paper, or towels.
 <b>WARNING</b>	Do not repair a leak with high-pressure water in the system. Discharge all high-pressure water before working on this equipment.



## Section 3

### Parts lists

---

Genuine Hypertherm parts are the factory-recommended replacement parts for this pump. The Hypertherm warranty might not cover damage caused by using nongenuine Hypertherm parts.

To order parts, contact the original equipment manufacturer (OEM) or Hypertherm Inc. with the part numbers and quantities.

Hypertherm Waterjet  
305 2nd Ave NW, Suite 115  
New Brighton, MN 55112 USA  
+1 866-566-7099  
+1 651-294-8620 fax

Quantity refers to the number of units included with each part number.

#### **16320 2-liter attenuator guard assembly kit**

<b>Part number</b>	<b>Description</b>	<b>Quantity</b>
16308	Guard strap	2
16309	Adhesive-backed rubber pad	4
16322	3/8-inch wrench	1
80963	Attenuator guard installation guide for 60-hp and 75-hp pumps with single intensifiers	1

## Parts lists

---

### 16323 Attenuator guard installation tool kit

Not used for 60-hp and 75-hp pumps with single intensifiers

Part number	Description	Quantity
809640	Attenuator guard installation guide for 100-hp, 125-hp, and 150-hp pumps and 60-hp and 75-hp pumps with redundant intensifiers	1
—	6-foot lifting strap	1
—	5/32-inch hex-head wrench	1
<b>Used only for 125-hp and 100-hp models and 60-hp and 75-hp models with redundant intensifiers</b>		
—	Flat-blade screwdriver	1
—	1/4-20 eye bolt (rated for 226 kg/500 lb)	2
—	Shackle	2
<b>Used only for 150-hp models</b>		
—	Attenuator locating tool	1
—	3/8-inch square-drive socket wrench	1
—	3/8-inch socket extension, 15 in.	1
—	9/16-inch hex socket	1

### 16342 150D attenuator guard high-pressure tubing kit

Used only for 150-hp models

Part number	Description	Quantity
16330	3/8-inch high-pressure tubing	1
12580	3/8-inch protective sheathing	1
14687	Protective sheathing end cover	2
13162-60-6F9M	9/16-inch male to 3/8-inch female adapter	2

## Other parts

### Lubricants

Part number	Description
11111	Blue Goop high-pressure antiseize lubricant
11448	AccuGoop food-grade high-pressure antiseize lubricant