

Hypertherm[®]

DynaMAX™ 3-series waterjet pumps

Simplifying service

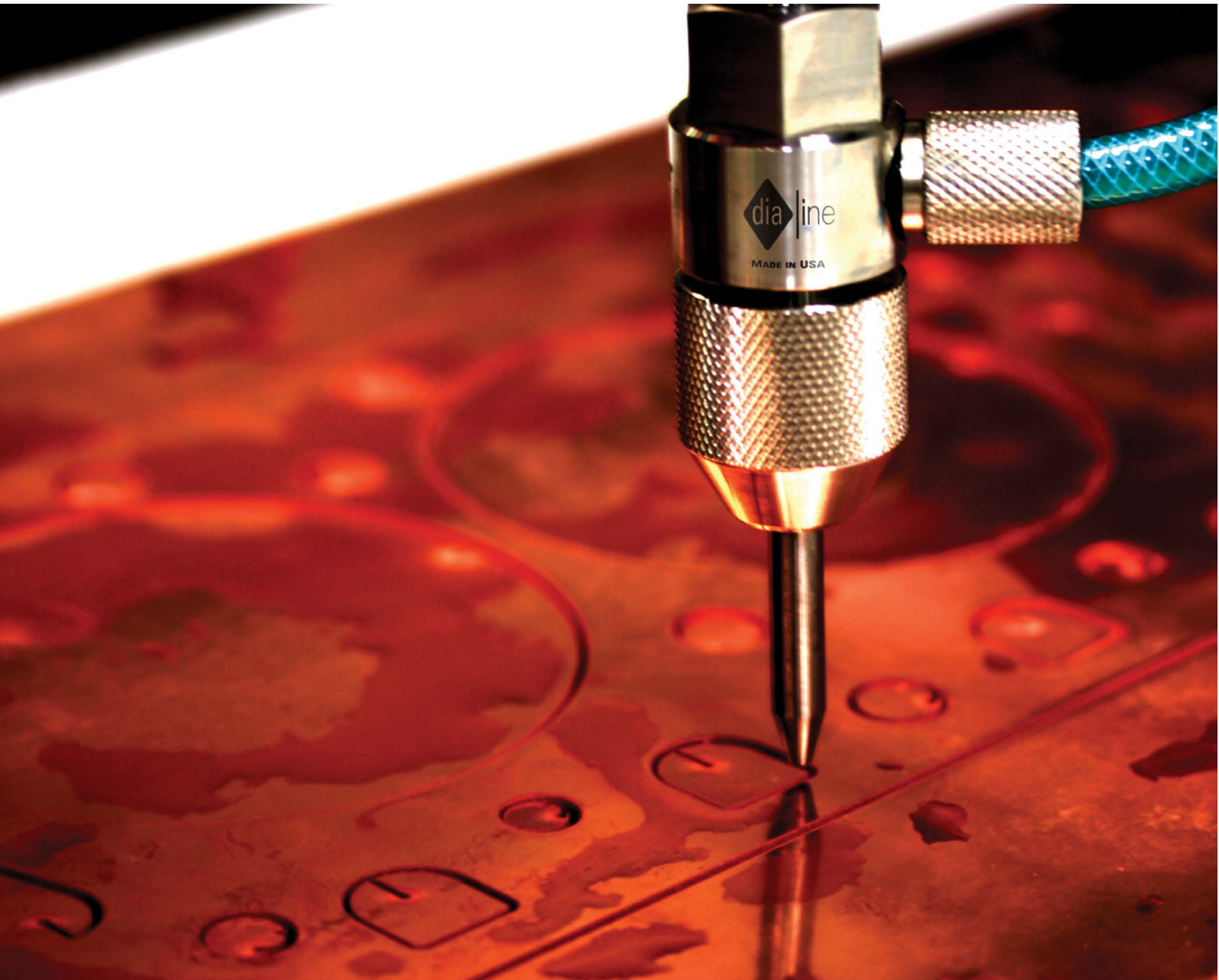



DynaMAX
330

naMAX
330

DynaMAX 3-series pumps

Designed and built to simplify service

DynaMAX™ 3-series pumps are the first waterjet pumps to incorporate cartridge seals that substantially reduce time to conduct maintenance. Equipped with standard features such as our next evolution of Advanced Intensifier Technology™ (AIT) and closed-loop proportional pressure control, our pumps offer you consistent cut quality while ensuring trouble-free operation and reliability.

Reduced maintenance time

DynaMAX 3-series pumps include the next evolution of Hypertherm's Advanced Intensifier Technology. This technology eliminates soft, static high-pressure seals and incorporates industry-leading cartridge seal design, enabling rapid replacement of common consumables.

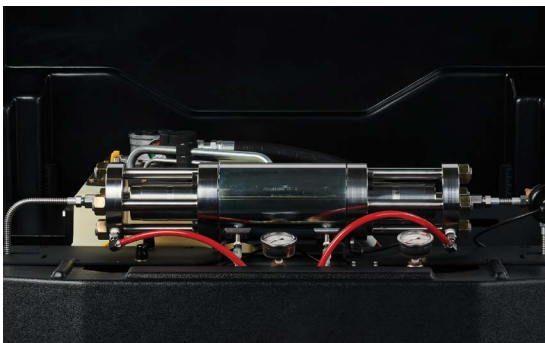

Increased performance

Standard on all DynaMAX 3-series pumps, closed-loop proportional pressure control adjusts for ambient pressure and temperature, oil viscosity and hydraulic system wear parts, to deliver consistent quality at optimum cutting speeds.

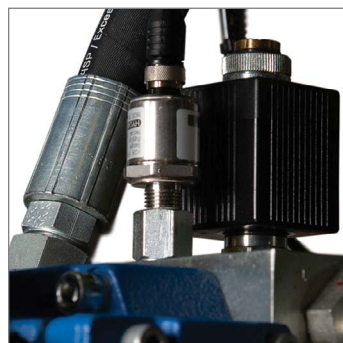

Improved reliability and ease of service

With 20% fewer parts than earlier generations, DynaMAX 3-series pumps include user-friendly features such as common service components located front and center, quick-connect fittings, and an easy access bleed-down valve, to make maintenance faster, easier, and less expensive.

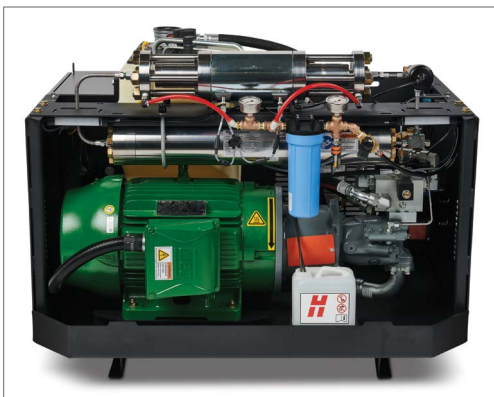

Reduced footprint

Smart industrial design, including fully integrated cooling, allows a reduced footprint, enabling integration into small, tight spaces.

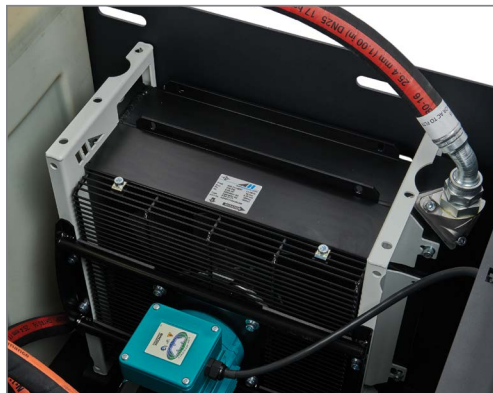

The next evolution of Advanced Intensifier Technology simplifies system maintenance

Say goodbye to complicated seal repair. DynaMAX™ 3-series pumps incorporate cartridge seals, enabling rapid replacement of common consumables, leading to quicker return to service. Add this to other key features of AIT and it's easy to see why Hypertherm is an unstoppable force in waterjet!

Reversible cylinders

Enables error-proof maintenance

Advanced piston design

Minimizes seal wear and improves component life

Hard static seal

Reduces maintenance cost through elimination of soft seal components and no specialized tools

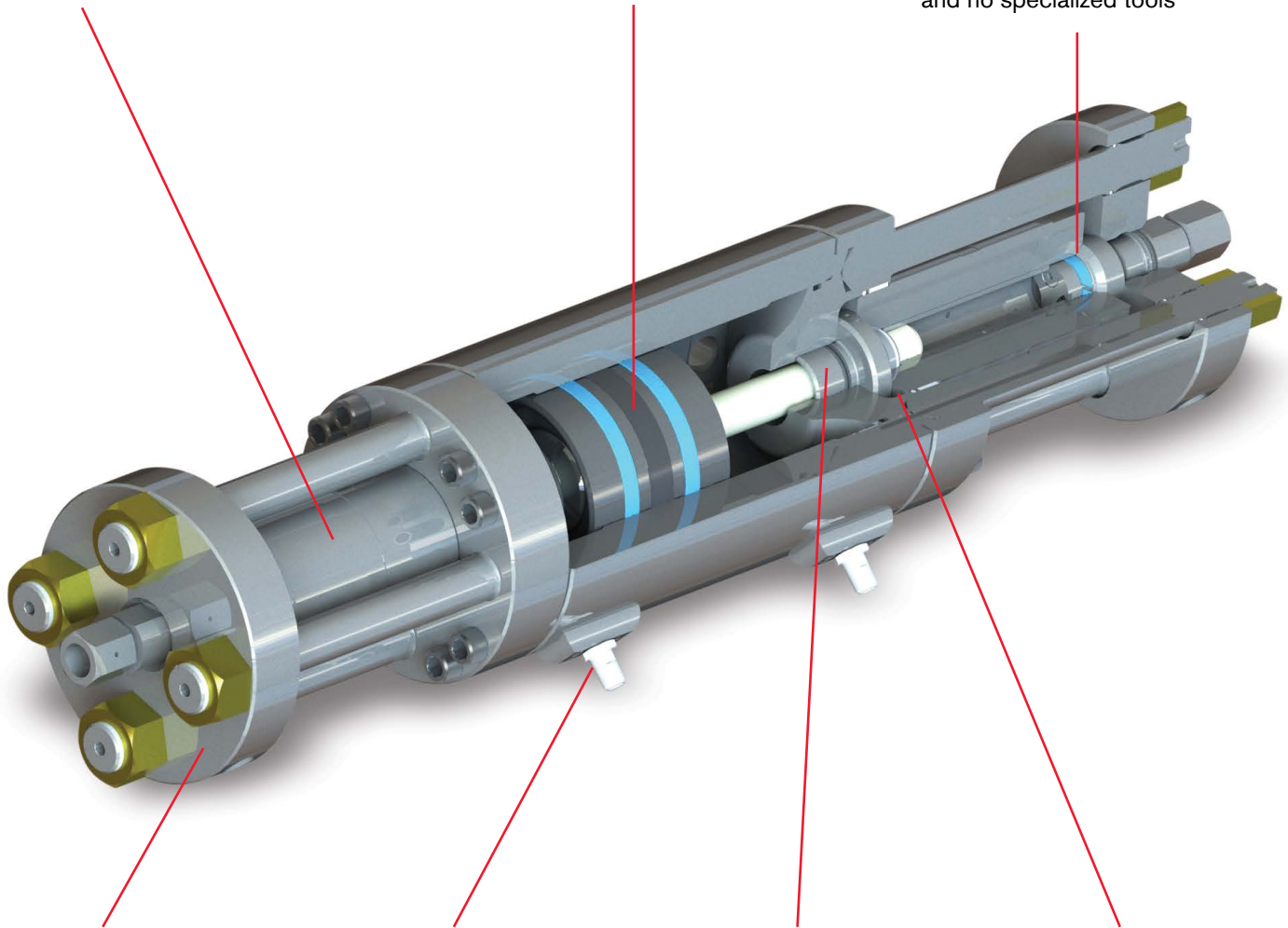

Simple high-pressure ends

Enables easy access for maintenance

Direct sense piston

Improves reliability and enables rapid stroke reversal to optimize system operation

Oil and water seal access

Simplifies maintenance by locating seal access external to the center section

Fluid routing

Collects fluid leaks to help keep your floor clean

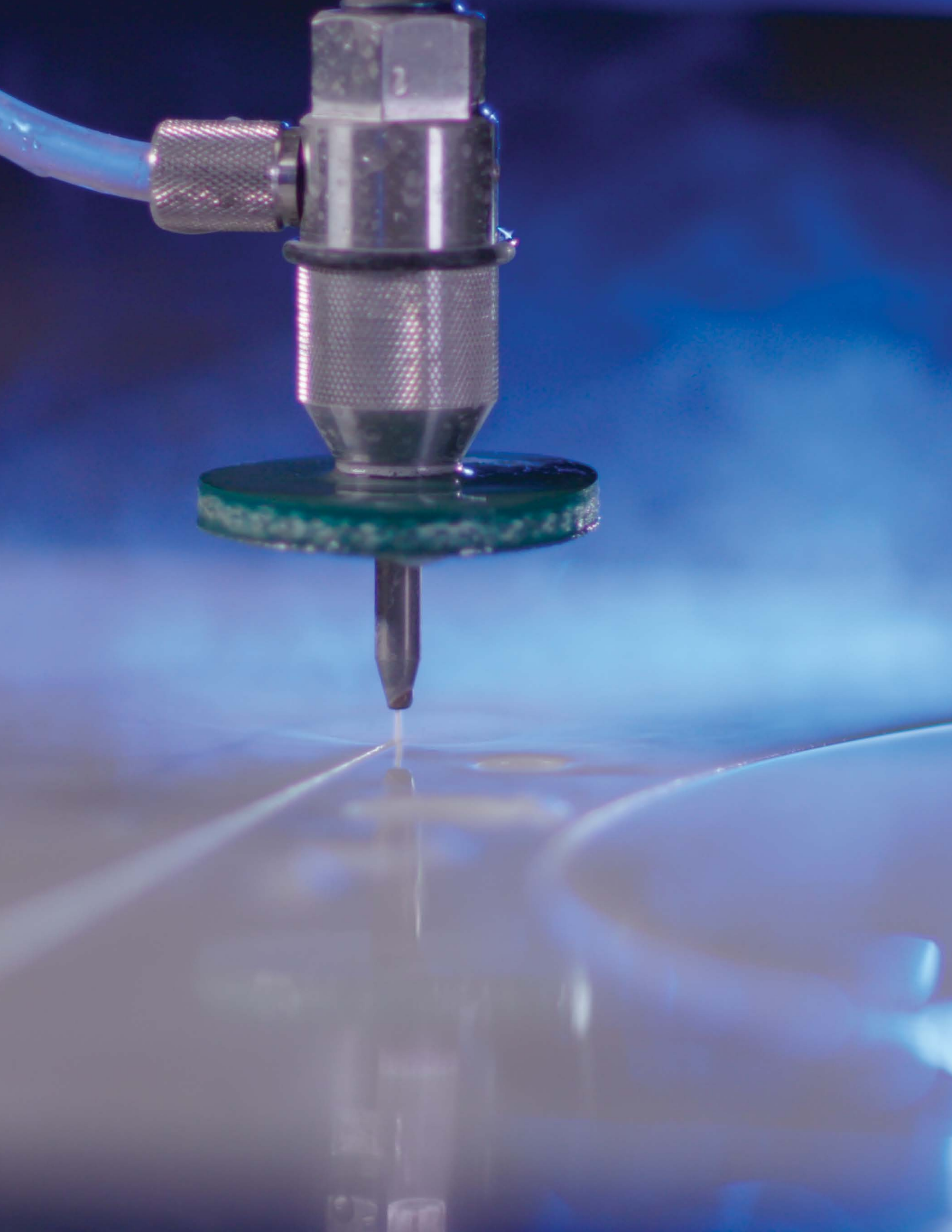

Choosing the right DynaMAX™ 3-series pump for your application

System specifications



		DynaMAX 315			DynaMAX 330			DynaMAX 350		
		50 Hz		60 Hz	50 Hz		60 Hz	50 Hz		60 Hz
GENERAL	Maximum output	1.1 lpm (0.3 gpm)			2.3 lpm (0.6 gpm)			3.8 lpm (1.0 gpm)		
	Maximum orifice	0.18 mm (0.007")			0.28 mm (0.011")			0.35 mm (0.014")		
	Output pressure	Adjustable to 4,100 bar (60,000 psi)								
	Pressure control	Closed loop proportional pressure control – standard equipment								
	Bleed down valve	Air-actuated								

PUMP POWER	Motor power	11.2 kW (15 HP)			22.4 kW (30 HP)			37.3 kW (50 HP)		
	Voltage	400 V	208-230 V	460 V	400 V	208-230 V	460 V	400 V	208-230 V	460 V
	Full load	23 A	45-41 A	21 A	44 A	82-76 A	38 A	74 A	136-124 A	62 A
	Main breaker	30 A	60 A	30 A	60 A	100 A	60 A	100 A	200 A	100 A
	Motor starter (options if more than 1 listed)	Across-the-line			Wye-Delta Soft Start	Across-the-line	Across-the-line Soft Start	Wye-Delta Soft Start	Wye-Delta	Wye-Delta Soft Start

SPECIAL FEATURES	Advanced Intensifier Technology	Included as standard equipment								
	Closed loop proportional pressure control	Included as standard equipment								

PHYSICAL	Width	1,090 mm (43")								
	Length	1,350 mm (53")								
	Height	1,010 mm (40")								
	Operating weight	775 kg (1,700 lbs.)			825 kg (1,850 lbs.)			925 kg (2,050 lbs.)		

ACCESSORIES	Boost pump	Optional								
	Integrated air over oil cooling	Optional								
	Bulkhead connection kit	Optional								
	Metric conversion kit	Optional								
	Pump mounted whip kit	Optional								

A close-up, low-angle shot of a black, rugged electronic device. The device has a textured, matte black finish. On the left side, there is a vertical stack of four diamond-shaped ventilation grilles. Above the top grille, a small, rectangular red LED light is illuminated. The top of the device features a recessed horizontal slot, possibly for a handle or a display. The overall design is industrial and compact.

DynaMAX

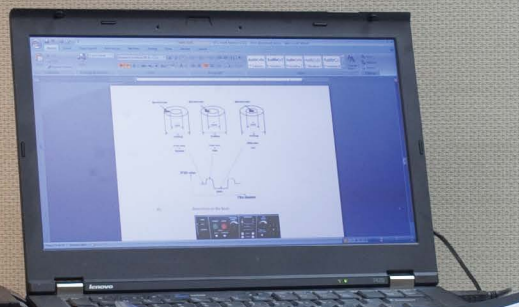
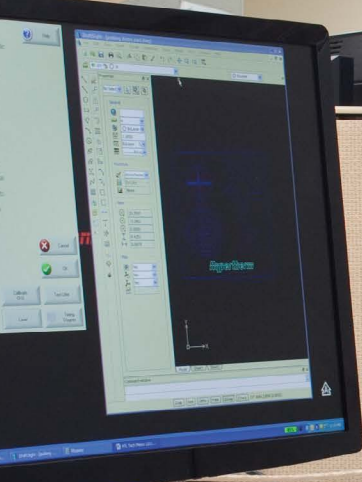

STEP 200

	SAFETY OPERATION
	DANGER
Read the instruction manual before use. Do not use the laser without the appropriate safety glasses. Do not look directly into the laser beam.	
	DANGER
Do not touch the laser beam. Do not touch the laser beam directly. Do not touch the laser beam.	
	DANGER
Do not touch the laser beam. Do not touch the laser beam directly. Do not touch the laser beam.	
WARNING	
Do not touch the laser beam. Do not touch the laser beam directly. Do not touch the laser beam.	



A knowledgeable partner who knows what you need

Hypertherm built the most robust information tools in the cutting industry. From responsive waterjet experts working the customer service lines, to mobile applications and 24/7 online technical service guides, Hypertherm provides what you need to know. And we offer it to our customers free of charge.

Information is only good when you have it. Be informed, be connected, and stay ahead of profit-losing troubles and delays with insights from Hypertherm.

We ship faster, so you are back to work sooner

We strive to fill every order the day it is received. Our goal as owners is to ensure you get what you need when you need it. If we can not ship the same day, we will call you. From our job shop roots, we know how it feels to be down, so we will do everything we can to keep you cutting.

- Voicemail-free, expert waterjet support during business hours
- Global distribution ensures fast response and speedy parts delivery
- Hypertherm Waterjet Assistant mobile application for iOS and Android
- Online technical guides with step-by-step repair instructions (<http://assist.hypertherm.com>)
- Available on-site product training

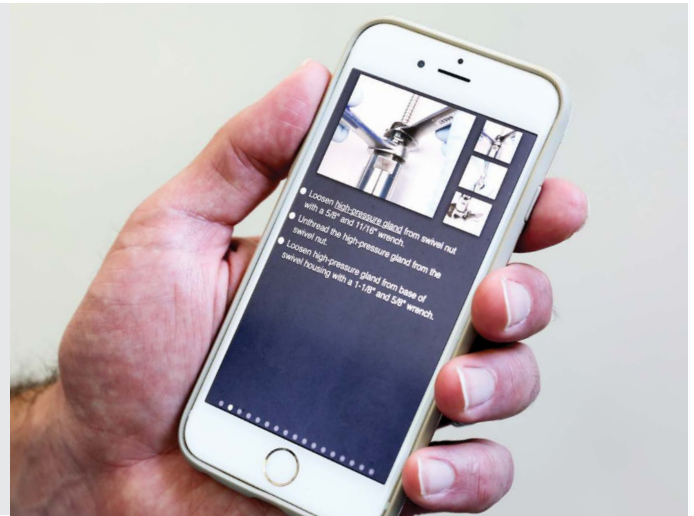

Waterjet Assistant gives you instant access to detailed, step-by-step maintenance and repair procedures, including part numbers.

Get the mobile app

Download the Hypertherm Waterjet Assistant mobile app from the App Store for iOS or from Google Play for Android using the links below.





Shaping Possibility®

With the right tools and a relentless focus on innovation, partnership, and community, we believe anything is possible.

More than fifty years ago, in a small two car garage, Hypertherm® began our journey with simple, powerful ideas about business and an invention that shaped the future of industrial cutting. The same ideals that fueled our inception all those years ago are still what drive us today: a passion for challenging what is achievable with the products we create, the culture we foster, and the experience we deliver to our customers. As we look to the horizon and the next 50 years, we are proud that our people, partners, and innovations will shape the future with solutions that make anything possible for industries around the world.

At Hypertherm, we give shape to our customers' vision with the world's leading industrial cutting solutions. Every day we help individuals and companies around the world envision better, smarter and more efficient ways to produce the products that shape our world. So whether you're cutting precision parts in North America, constructing a pipeline in Norway, fabricating agricultural machinery in Brazil, cutting stone in Italy, gouging out welds in the mines of South Africa, or building a skyscraper in China, you can count on Hypertherm to help you not just cut parts but achieve your vision.

100% employee ownership matters

At Hypertherm, we are not just employees: we are all owners. Ownership is a powerful motivator that ensures our customers are our top priority. As owners, we make sure every product is built to the highest quality and that our service is second to none. And we build long-term relationships that deliver value for us, our partners and our customers.

Worldwide presence and strength

Hypertherm is a key partner for your fabrication needs and has built a global organization focused on providing high-performance cutting solutions.

Key elements of the Hypertherm formula include:

- Dedicated Associates focused on customer-centered product design and support
- Local sales and service
- Broad application experience and proven results
- Sustainable and ethical business practices benefit our customers and communities

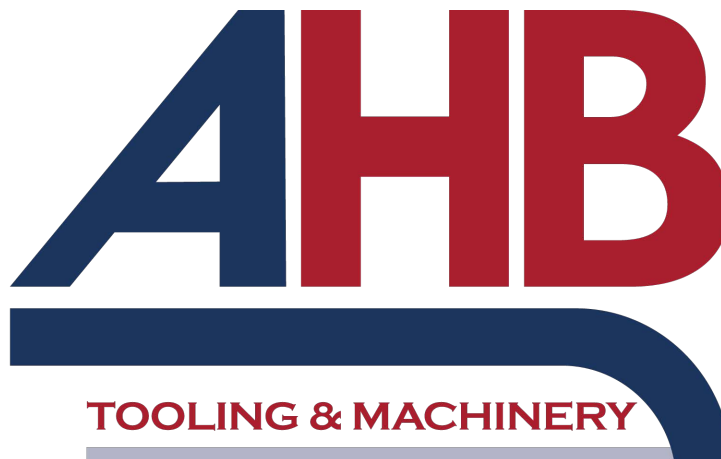

COMPLETE METALWORKING SOLUTIONS

(800) 991-4225

www.ahbinc.com

ISO Certified

customerservice@ahbinc.com

**HELPING YOU
SHAPE THE WORLD.**



PLASMA | LASER | WATERJET | AUTOMATION | SOFTWARE | CONSUMABLES

For more information, visit:
www.hypertherm.com

Hypertherm, DynaMAX, Advanced Intensifier Technology, and Shaping Possibility are trademarks of Hypertherm, Inc. and may be registered in the United States and/or other countries.

Please visit www.hypertherm.com/patents for more details about Hypertherm patent numbers and types.

© 11/2021 Hypertherm, Inc. Revision 1

897920EN-EU

As 100% Associate owners, we are all focused on delivering a superior customer experience. www.hypertherm.com/ownership

Environmental stewardship is one of Hypertherm's core values. www.hypertherm.com/environment

Hypertherm[®]
SHAPING POSSIBILITY[®]

100% Associate-owned

