



Reliable. Repeatable. Clean.

That's the OTC DAIHEN Single-Source Solution.



The OTC DAIHEN Single-Source Solution

Reliable.
Repeatable.
Clean.



Reliable. Repeatable. Clean.

That's the OTC DAIHEN Single-Source Solution.



Reliable. Experience

- DAIHEN founded: 1919 in Osaka, Japan

DAI HEN = 大阪 変圧器 株式会社 = Osaka Transformer Company

- 1st product was power transformers
- Began producing welding power sources in 1934
- DAIHEN, Inc. established as the American subsidiary in 1979
- Began producing welding robots in 1980
- 100+ years delivering innovation in welding and robotics and 40+ years supporting American manufacturing

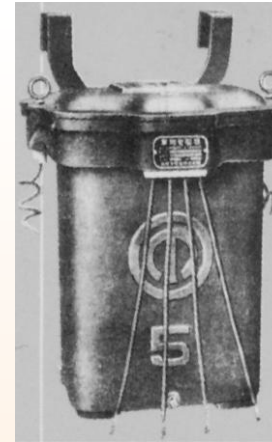
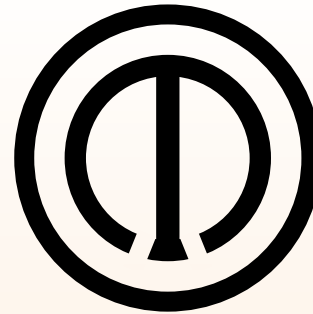



Reliable. Repeatable. Clean.

That's the OTC DAIHEN Single-Source Solution.



Reliable. Support

24/7/365 Expert Support

- Support Hotline
 - 1-888-OTC-ROBO [888-682-7626]
- After-Hours Hotline
 - 1-866-460-8566
- Best Warranty in the Industry
 - WELBEE Welding Power Sources
 - 3 years parts & labor, 1 year exchange
 - Robots
 - 3 year parts, 1 year labor



BEST WARRANTY IN THE INDUSTRY

3 YEARS Parts
1 YEAR Labor
on all Robots

3 YEARS
Parts & Labor
on all WELBEE's



Reliable. Repeatable. Clean.

That's the OTC DAIHEN Single-Source Solution.



Repeatable. Consistent Welds

**Welding's
Best
Electronic
Engine**



Mild steel, stainless steel,
aluminum, galvanized steel,
galvanneal, titanium & other exotic
metals

**3 Billion weld arc
adjustments every second**





Reliable. Repeatable. Clean.

That's the OTC DAIHEN Single-Source Solution.



Repeatable. The Golden Contact Tip

- Ford Motor Company solicited benchmark tests of aluminum contact tips from robotic welding suppliers
- How many consecutive 1" welds could be performed?
- Competing brands maxed out at 10,000 welds
- Our "Golden Tip" remains on display at our U.S.A. headquarters having achieved 22,700 aluminum welds!





Reliable. Repeatable. Clean.

That's the OTC DAIHEN Single-Source Solution.



Repeatable. Consistent productivity



**DR-1000 (circa 1994)
still producing**



**All-V6 (circa 2009)
still producing**



**FD-V8 (circa 2018)
just 2 years in**



Reliable. Repeatable. Clean.

That's the OTC DAIHEN Single-Source Solution.



Clean. Single Source

OTC DAIHEN produces and delivers Single-Source solutions that are built from the ground up to cooperatively work together, delivering consistent results

- Weld power source + welding robot + production system
 - No 2nd or 3rd party equipment required
 - One call does it all
- All the necessary components and know-how from a single-source supplier
 - Robots, welders, torches, weld consumables, wire feeders, control and software



Reliable. Repeatable. Clean.

That's the OTC DAIHEN Single-Source Solution.



Clean. Single Source

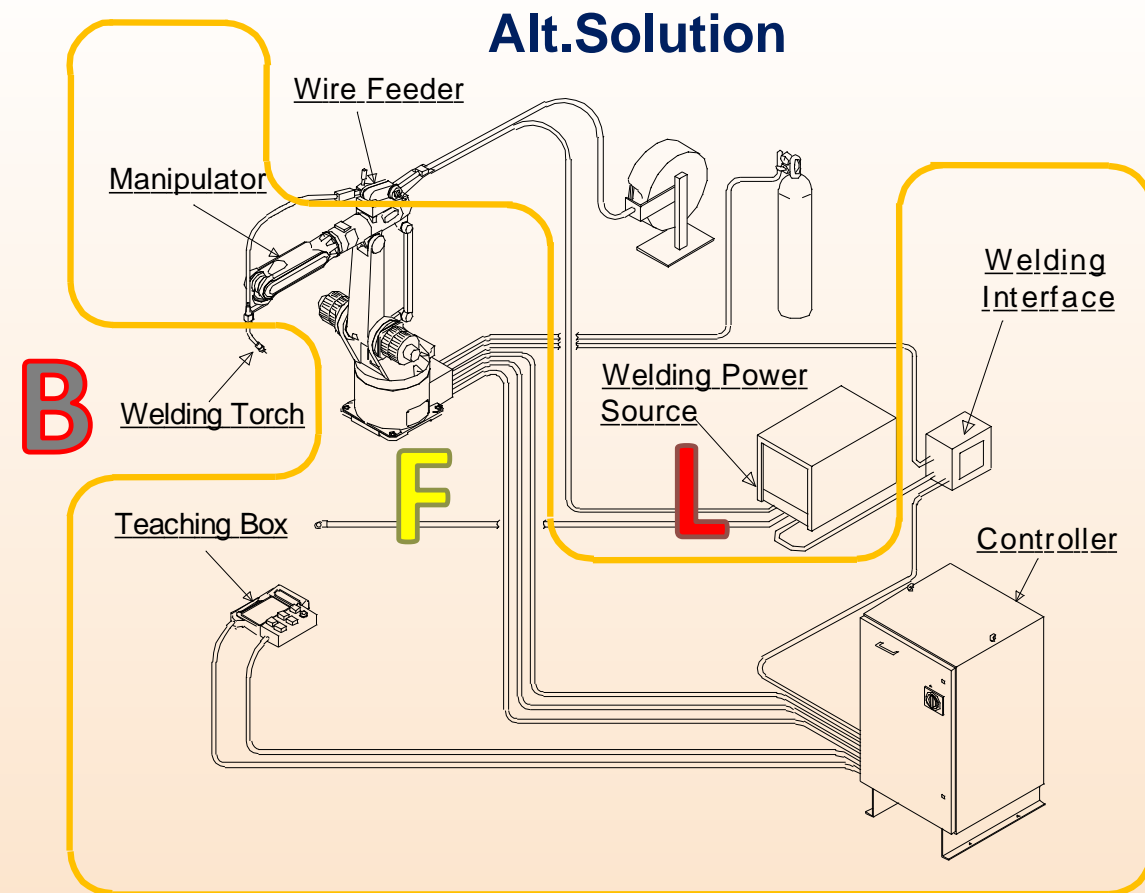
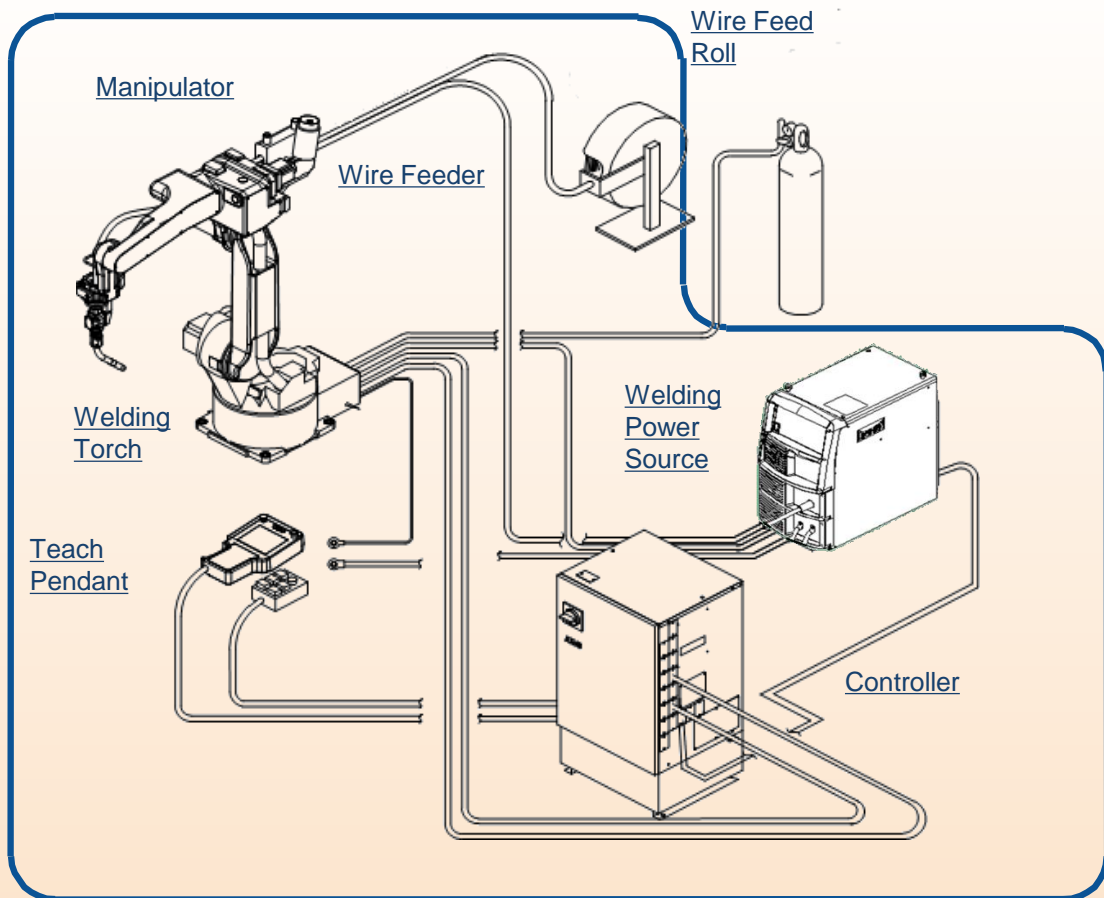



Reliable. Repeatable. Clean.

That's the OTC DAIHEN Single-Source Solution.



Clean. Simple solutions

- Pre-Engineered, production-ready robotic weld cells
 - 14 unique cells x 11 robot models x 8 weld power sources x 10 weld positioners = over 12,000 varieties of robot weld cells
- Unique robot models representing 40 years of advancing welding automation
 - Into our 9th generation of design with our 10th generation on-the-way
 - 11 robot models include our 7-axis series that “swivel in the middle”
- Welding power source networked to the robot controller, delivering seamless integration
 - All weld teaching and operation through a single, touch-screen pendant



Reliable. Repeatable. Clean.

That's the OTC DAIHEN Single-Source Solution.



Clean. Simple solutions



ED-ARC 100
Educational System



ECO-ARC Series
2 Stationary Tables
(4 models)



PT-ARC Series
Pneumatic Turn-Table
(2 Models)

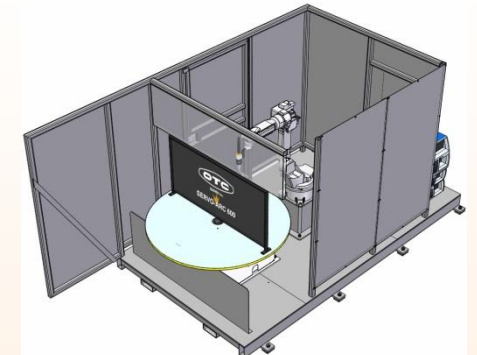

SERVO-ARC Series
Servo Turn-Table
(4 Models)

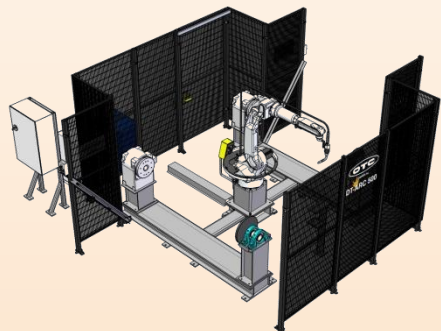

DT-ARC
Dual Head/Tail Stocks

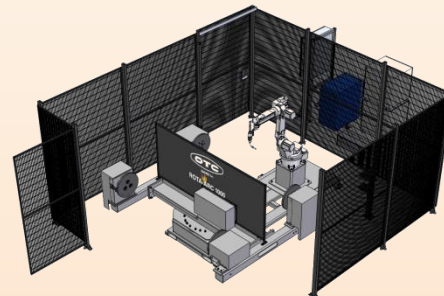

ROTA-ARC
Pivoting Head/Tail Stocks

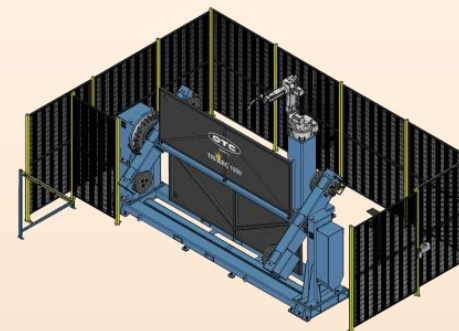

TRI-ARC
Ferris Wheel



LT-ARC
Slider Axis



Reliable. Repeatable. Clean.

That's the OTC DAIHEN Single-Source Solution.



Clean. Simple solutions



FD-H5



FD-B6



FD-B6L



FD-V8



FD-V8L



FD-V25

6-axis Series



FD-V80



FD-V100



FD-V130

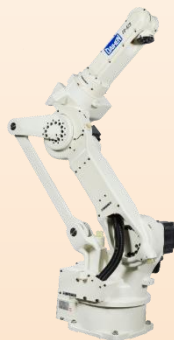

FD-A20

FD-Series Robots



FD-B4S



FD-B4LS



FD-V6S



FD-V6LS



FD-V20S

7-axis Series



Reliable. Repeatable. Clean.

That's the OTC DAIHEN Single-Source Solution.



Clean. Simple solutions

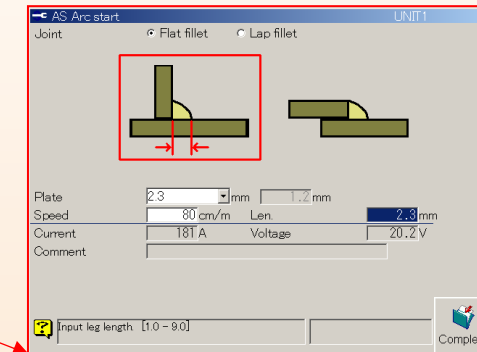
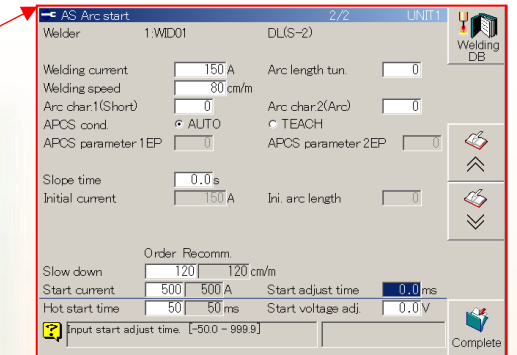
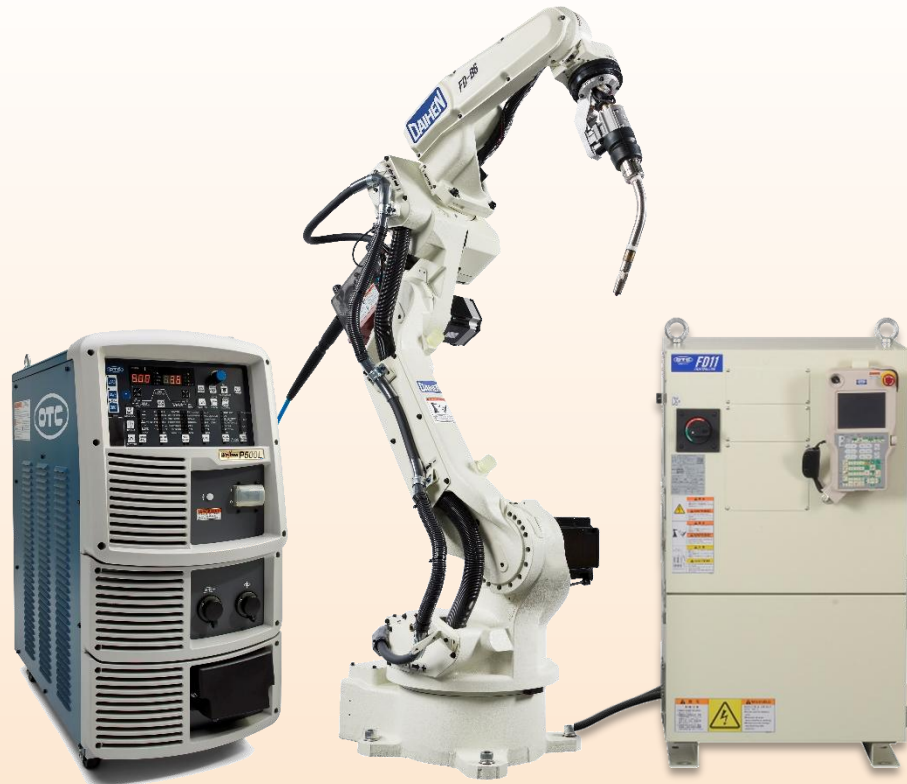

No finger-pointing: ALL delivered by DAIHEN

Jog dial: quickly adjust 7 weld parameters



Reliable. Repeatable. Clean.

That's the OTC DAIHEN Single-Source Solution.



Clean. Better welds

- Exclusive technology producing clean welds without spatter
 - WavePulse II – stacked pulse, inverter welding with synchronized wire feeding on a variety of material (steel, stainless, aluminum, galvanized and exotic metals)
 - Reducing weld porosity and improving weld strength
 - Low-Spatter Mode
- Synchro-feed robotic welding
 - Combining robotic wire feed control with WELBEE weld processing
 - PulseDip transfer for spatter-free welding up to 330A
 - Faster processing delivers 4X better results than our closest competition
 - All this translates to faster welding speeds for higher productivity and cleaner welds



Reliable. Repeatable. Clean.

That's the OTC DAIHEN Single-Source Solution.



**COMPLETE
METALWORKING
SOLUTIONS**

(800) 991-4225

www.ahbinc.com

ISO Certified

customerservice@ahbinc.com

For more about
OTC DAIHEN visit
www.DAIHEN-USA.com