



DIVERSITECH
Air Pollution Solutions

Operation & Maintenance Manual

INDUSTRIAL DOWNDRAFT TABLES



DD-3X4, DD-3X6, DD-3X8
Single Workstation Tables



DD-4X4, DD-4X6
DD-4X8, DD-5X10
Multi Workstation Tables



READ AND SAVE THESE INSTRUCTIONS

Visit our Website for more information on this product

www.diversitech.ca

1200 55th Avenue, Montreal, Quebec H8T 3J8
Tel: 1.800.361.3733 | Fax: 1.514.631.9480 | info@diversitech.ca

Table of Contents

SECTION 1 – SAFETY PRECAUTIONS OF FUME & DUST EXTRACTION/COLLECTION	3
1.1 Symbols	3
1.2 User Responsibility	3
1.3 Fume Extraction Hazards	3
1.4 Dust Collection Hazards	3
SECTION 2 – SPECIFICATIONS	4
2.1 Model Configuration & Description	4
2.2 Product Specifications	5
2.3 Filter Specifications	5
2.4 Dimensions	6
SECTION 3 – SETUP / INSTALLATION	7
3.1 To Setup or Install Safely	7
3.2 Un-Packaging	7
3.3 Selecting a Location	7
3.4 Installation	7
3.5 Preparing Unit for Operation	8
SECTION 4 – OPERATION	8
4.1 To Operate Safely	8
4.2 Controls	8
4.3 Pre-Use Checklist	9
4.4 Principles of Operation	9
4.5 DD-2x4 Pulse Filter Cleaning System	9
SECTION 5 – MAINTENANCE & TROUBLESHOOTING	11
5.1 To Maintain this Product Safely	11
5.2 Tools Required	11
5.3 Routine Maintenance Schedule	12
5.4 Filter Replacement	13
5.5 Troubleshooting Procedure	14
APPENDIX 1 – ELECTRICAL DIAGRAM MANUAL [230/460/575v] 3-Phase Power	15
APPENDIX 2 – MAINTENANCE RECORD	16
APPENDIX 3 – REPLACEMENT PARTS	17
APPENDIX 4 – TABLE OPTIONS	18
APPENDIX 5 – INSTALLING SIDE & BACK WALLS	19
NOTES.....	20,21,22,23
Limited Equipment Warranty	Back Cover
Freight Claims	Back Cover
Return Material Policy	Back Cover

SECTION 1 - SAFETY PRECAUTIONS OF FUME & DUST EXTRACTION/COLLECTION



READ
BEFORE
USE

This manual contains specific cautionary statements related to worker safety. To protect yourself and others, read this manual thoroughly and follow as directed before use. Not all hazards of fume & dust control are listed in this manual, and no hazards related to welding, cutting, grinding, painting, deburring or other applications are listed. Consult a qualified safety professional.



DO
NOT
USE

Do not use this equipment:

- To extract combustible dusts, liquid vapors, aggressive fumes such as acids.
- To extract smoke or fumes above 180°F / 82°C.
- If the power cord has been damaged or ground (third prong) removed.
- Without a filter.

1.1 Symbols

This manual uses several symbols to highlight specific hazards. Be familiar with these symbols and when you see them in this manual, read adjoining warning text to avoid the hazard.



WARNING!
DANGER!



ELECTRIC
SHOCK



MOVING
PARTS



HOT
PARTS

1.2 Users Responsibility

- Improper use can be hazardous.
- It is your responsibility to follow all applicable ANSI, OSHA, UL, CSA, National & Local Fire Codes, and other regulatory guidelines covering the safe use of equipment that extracts fumes, collects dusts, and exhausts filtered air either indoors or outdoors.
- Before use, inspect the unit for damage and verify it is working properly.
- Only qualified persons should install, operate, maintain, or repair this unit.
- Do not modify or repair the unit with parts or accessories not supplied by the manufacturer.
- Consult filter manufacturer's instructions for filter use and reuse, including instructions for cleaning.

1.3 Fume Extraction Hazards

- Breathing smoke, fumes, or dusts produced in applications such as welding, cutting, grinding, painting, deburring are hazardous to user's health. Proper ventilation or use of well maintained fume extraction and/or dust collection equipment helps the user avoid these hazards.
- Breathable contaminants may not be visible or have an odor.
- Stop operation and leave the area immediately if 1) breathing becomes difficult, 2) experience dizziness, impaired vision, 4) or eye/nose/mouth irritation.

1.4 Dust Collection Hazards

- Dusts from many welding, cutting, grinding, painting, or deburring applications can be combustible.
- Do not use or install equipment where any potential for combustible fumes or dusts are present, until a qualified person has indicated it is safe to do so.
- Never use or install equipment where the potential for combustible fumes or dusts are present without a fire/explosion protection system.
- If you are unsure if the product you purchased is correct for your application, call Diversitech at 1-800-361-3733.

SECTION 2 - SPECIFICATIONS

2.1 Model Configurations & Description

Model	Open Works surface	Side/Back Walls	Clean Air Workstation
DD-3X4			
DD-3X6			
DD-3X8			
DD-4X4			
DD-4X6			
DD-4X8			
DD-5X10			

2.2 Product Specifications

Model	Motor (H.P)	Power				Nominal Airflow (CFM)	Static Pressure (in.)	Face Velocity (FPM)	Noise @5ft (dB)
		Phase (hz)	@230V F.L.A (amps)	@460V F.L.A (amps)	@575V F.L.A (amps)				
Industrial Downdraft Tables, three phase									
DD-3X4	5.0	3P/60Hz	12.8	6.4	4.6	4300	4.0	450	79
DD-3X6	5.0	3P/60Hz	12.8	6.4	4.6	4300	4.0	325	79
	7.5	3P/60Hz	17.0	8.5	7.2	5050	4.0	375	81
DD-3X8	7.5	3P/60Hz	17.0	8.5	7.2	5050	4.0	330	81
	10.0	3P/60Hz	24.0	12.0	9.6	6300	4.0	338	83
Industrial Multi-operator Downdraft Tables, three phase									
DD-4X4	5.0	3P/60Hz	12.8	6.4	4.6	4300	4.0	425	79
DD-4X6	7.5	3P/60Hz	17.0	8.5	7.2	5050	4.0	325	81
	10.0	3P/60Hz	24.0	12.0	9.6	6300	4.0	375	83
DD-4X8	10.0	3P/60Hz	24.0	12.0	9.6	6300	4.0	300	83
DD-5X10	15.0	3P/60Hz	42.0	21.0	17.0	8600	4.0	330	85

2.3 Filter Specifications

Model	Part Number	Filter Media	Filter Area (sq. ft.)	Cleaning Method	Filter Efficiency	Quantity Filters Required
Downdraft Tables, standard filter						
DD-3X4	S-3X4-16NF13	Nanofiber	139	Compressed Air	MERV 15	2
DD-3X6	S-3X6-16NF13	Nanofiber	139	Compressed Air	MERV 15	2
DD-3X8	S-3X8-16NF13	Nanofiber	139	Compressed Air	MERV 15	4
DD-4X4	S-4X4-16NF13	Nanofiber	139	Compressed Air	MERV 15	2
DD-4X6	S-4X6-16NF13	Nanofiber	139	Compressed Air	MERV 15	2
DD-4X8	S-4X8-16NF13	Nanofiber	139	Compressed Air	MERV 15	4
DD-4X10	S-5X10-16NF13	Nanofiber	139	Compressed Air	MERV 15	6
Downdraft Tables, optional filter						
DD-3X4	S-3X4-16PT13	Spunbond Poly	55	Air + Water	MERV 11	2
DD-3X6	S-3X6-16PT13	Spunbond Poly	55	Air + Water	MERV 11	2
DD-3X8	S-3X8-16PT13	Spunbond Poly	55	Air + Water	MERV 11	4
DD-4X6	S-4X4-16PT13	Spunbond Poly	55	Air + Water	MERV 11	2
DD-4X6	S-4X6-16PT13	Spunbond Poly	55	Air + Water	MERV 11	2
DD-4X8	S-4X8-16PT13	Spunbond Poly	55	Air + Water	MERV 11	4
DD-5X10	S-5X10-16PT13	Spunbond Poly	55	Air + Water	MERV 11	6

For information on inspecting and cleaning filter, or purchasing replacement filters, contact Diversitech at 1-800-361-3733.

2.4 Dimensions

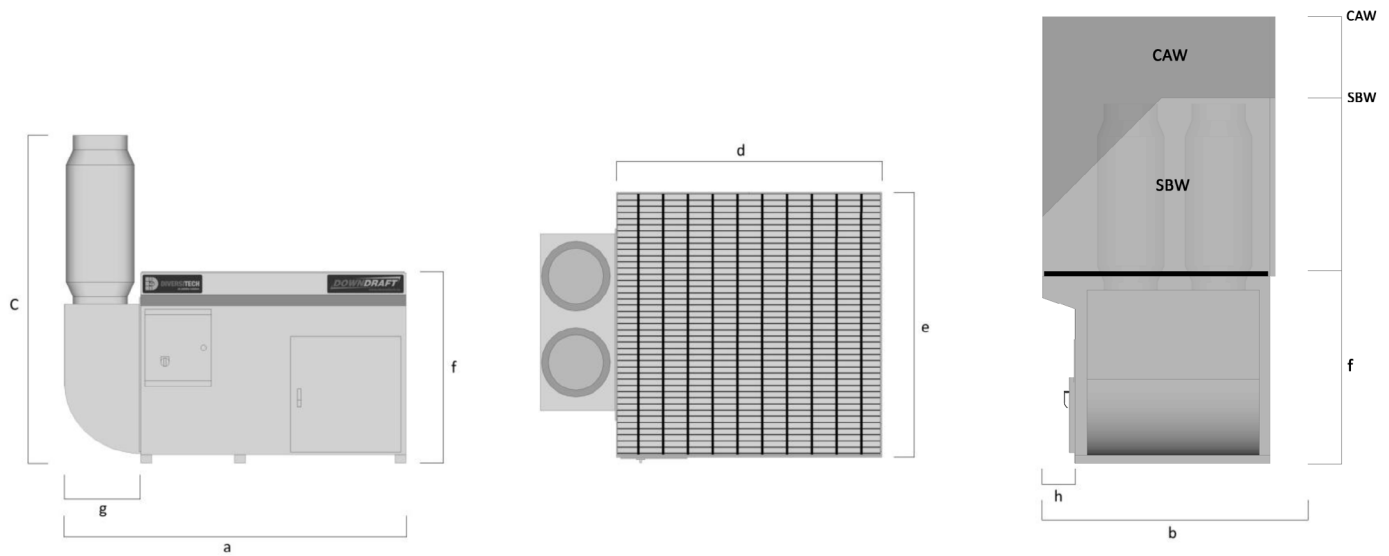

Model	Exhaust Diameter (in.)	Footprint (in.)			Work surface (in.)		Table Height [f/S&B/CAW]	Net Weight (lbs.)	Exhaust [g]	Overhang [h] (in.)
		Length [b]	Width [a]	Height [C]	Length [e]	Width [d]				
Downdraft Tables, Standard Size										
DD-3X4	10 x 2	43	62	68.5	42	48	36/69/84	258	14	6
DD-3X6	10 x 2	43	87	68.5	42	72	36/69/84	329	14	6
DD-3X8	10 x 2	43	111	68.5	42	96	36/69/84	421	14	6
DD-4X4	10 x 2	49	63	68.5	48	48	36/69/84	621	14	6 x 2
DD-4X6	10 x 2	49	87	68.5	48	72	36/69/84	729	14	6 x 2
DD-4X8	10 x 2	49	111	68.5	48	96	36/69/84	875	14	6 x 2
DD-5X10	10 x 2	61	155	68.5	60	120	36/69/84	1107	34	12 x 2
Downdraft Tables, extended overhang										
DD-3X4-EO	10 x 2	49	63	68.5	48	48	36/69/84	258	14	12
DD-3X6-EO	10 x 2	49	87	68.5	48	72	36/69/84	329	14	12
DD-3X8-EO	10 x 2	49	111	68.5	48	96	36/69/84	421	14	12
DD-4X4-EO	10 x 2	61	63	68.5	60	48	36/69/84	621	14	12 x 2
DD-4X6-EO	10 x 2	61	87	68.5	60	72	36/69/84	729	14	12 x 2

SECTION 3 - SETUP / INSTALLATION

3.1 To Setup or Install Safely



- Do not place unit near flammables or combustible surface.
- Refer to **SECTION 2: Specifications**, to know the electrical requirements of the unit you are installing and ensure adequate input power that is properly sized, rated, and protected.
- This unit must be grounded for safe operation.

3.2 Un-Packaging

1. Immediately upon receiving the unit, carefully examine the carton for damage during transit.
2. Remove packing material.
3. Avoid tipping or inverting during handling.
4. The item serial number, model, and electrical ratings are listed on the nameplate. Record this information in the Maintenance Record provided in **APPENDIX 2: Maintenance Record**, or your own preventative maintenance system.

3.3 Selecting a Location

- Choose a location where the unit will be used, near the operator.
- Choose a location sufficiently close to a grounded power source.

3.4 Installation

- Electrical Connection for units requiring: 3-phase (230/460/575V) direct connection.:
 - See **APPENDIX 1: Electrical Diagram** for wiring instructions.
 - Have a certified electrician install electrical connection according to local regulations.
 - All three power leads must be connected to L1, L2 and L3 on the contactor.
 - This unit must be grounded for safe operation.
 - If on start-up the downdraft table seems to be lacking performance or the table sounds very loud, the motor is most likely running in the reverse direction. Reversing leads L1 and L3 will reverse motor rotation in the right direction.
 - Correct direction of BLOWER WHEEL ROTATION = CLOCKWISE.
- For units requiring Compressed Air:
 - Supply 80-90 PSI of CLEAN, DRY, compressed air to the bulkhead bushing on the side of the unit.
 - The air tank in the downdraft table is fabricated to allow a maximum of 90 PSI, DO NOT attempt to supply air pressure greater than 90 PSI without a properly installed pressure regulator.
 - Moisture in airline can damage filter(s); use an air dryer if required.
- Special Installation steps for table options:
 - Side & Back Walls Installation – See **APPENDIX 4A: Installing Side & Back Walls**
 - Plasma Cutting Packages & Kits
 - Spray Painting Packages & Kits

3.5 Preparing Unit for Operation

- Remove all packaging and shipping protection before use, in accordance with **SECTION 3.2: Un-Packaging**
- Select a location appropriate for use that complies with all safety instructions contained herein, and **SECTION 3.3: Selecting a Location**
- Confirm installation of correct input power source, compressed air, and any special installation requirements, in accordance with **SECTION 3.3: Installation**. Look at the manufacturer's label located on the exterior of the unit and ensure the source is correctly sized in terms of Voltage and Amperes.
- Prior to use in your application, turn the unit ON, and perform a function test. To do so:
 - Turn switch to ON position
 - LOOK: Is the unit level, stable, and that nothing is obstructing the extraction path?
 - LISTEN: Does the motor and suction sound smooth and within expected volumes?
 - FEEL: Place your hand on top of the unit and sense for unexpected vibration. Place your hand in front of the intake surface and sense for expected level(s) of suction.
- Inform all potential users of this equipment where they may find and review this manual.

SECTION 4 - OPERATION

4.1 Operate Safely



- Read and understand **SECTION 1: Safety Precautions** and **SECTION 4: Operation before use**
- Read and understand all Material Safety Data Sheets and Manufacturer's instructions of all process materials, consumables, and equipment used in conjunction with this equipment.
- Keep away from all mechanical moving parts including motor, gears, and other pinch points.
- Do not use product without first confirming if a Spark Arrestor is required and installed for the type of dust, or fumes you are extracting and/or collection. If you are unsure, call a Diversitech representative at 1-800-361-3733.

4.2 Controls

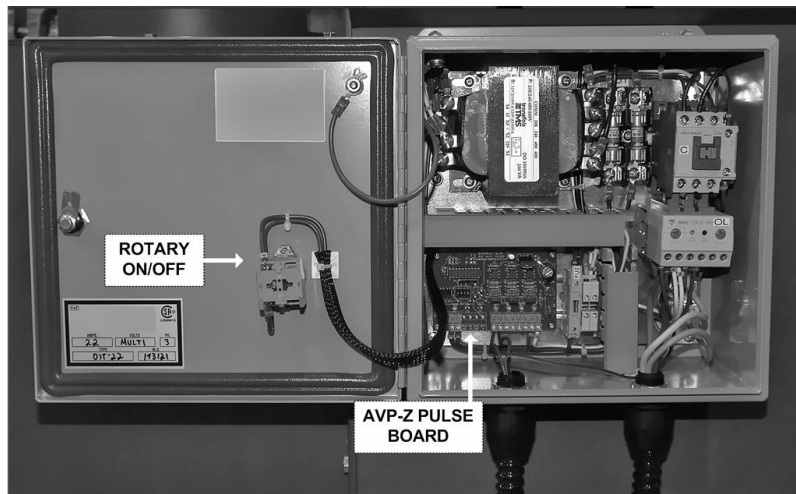
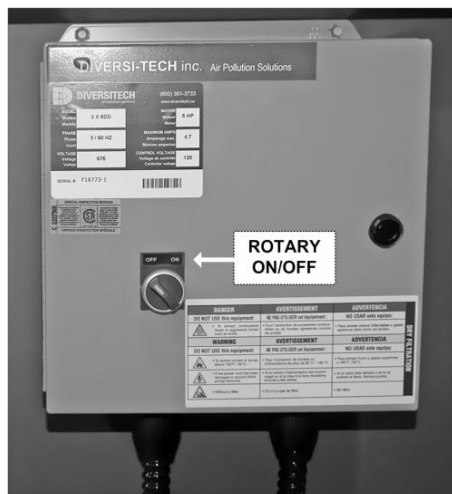

4.3 Pre-Use Checklist

- Prior to use in your application, turn the unit ON, and perform a function test. To do so:
 - Turn switch to ON position
 - LOOK: Is the unit level, stable, and that nothing is obstructing the extraction path?
 - LISTEN: Does the motor and suction sound smooth and within expected volumes?
 - FEEL: Place your hand on top of the unit and sense for unexpected vibration. Place your hand in front of the intake surface and sense for expected level(s) of suction.
- Inform all potential users of this equipment where they may find and review this manual.

4.4 Principles of Operation

This product is designed to capture and clean smoke and dust from medium & heavy duty welding, soldering, and grinding applications. When operating, air is drawn in through the table surface grating, passes through spark-arrestor baffling, then through the table's filtration system, and exhausted through the side exhaust.

This product consists of seven basic components:

1. Protective table surface grating(s)
2. Multi-stage spark-Arrestance baffling
3. Table cabinet
4. Cartridge Filter(s)
5. Motor/Blower Assembly
6. Reverse pulse filter cleaning system
7. Dust Drawer

4.5 Reverse Pulse Filter Cleaning System

The downdraft table is equipped with a reverse pulse automatic filter cleaning system. This system is controlled by a PC board inside the control box (Labelled "AVP-Z"). Changing the dip switch settings on the AVP-Z board, allows you to control:

1. Pulsing online or offline
2. Number of pulses
3. Pulse duration

Solenoid operated air valves discharge large blasts of air through the filter cartridges thus dislodging particles embedded in the filter media. The particles fall into a dust drawer located below the cartridge. The angled v-shaped baffles above the drawer prevent the dust from re-entering the cabinet when the machine is turned on.

Neglecting to pulse the filter regularly will reduce filter life.

Factory Setting

DIP SWITCH #	FACTORY SETTING
1	ON
2	OFF
3	ON
4	OFF

This factory setting allows for online & offline pulsing. 1 x 0.5 second air blast every 45 seconds, while online, and 20 x 0.5 second air blast when offline.

Recommended for Aluminum Dust

DIP SWITCH #	FACTORY SETTING
1	OFF
2	OFF
3	ON
4	OFF

This factory setting allows for only offline pulsing, 20 x 0.5 second air blast each time the machine is switched off.

Custom Application Settings

DIP SWITCH #	PURPOSE	LEFT	RIGHT
1	ON	Online & Offline	Offline Only
2	OFF	0.5 second	1 second
3	Number of Pulses		
4			

# OF PULSES	DIP SWITCH #3	DIP SWITCH #4
5	OFF	OFF
10	OFF	ON
20	ON	OFF
30	ON	ON

AVP-Z Board

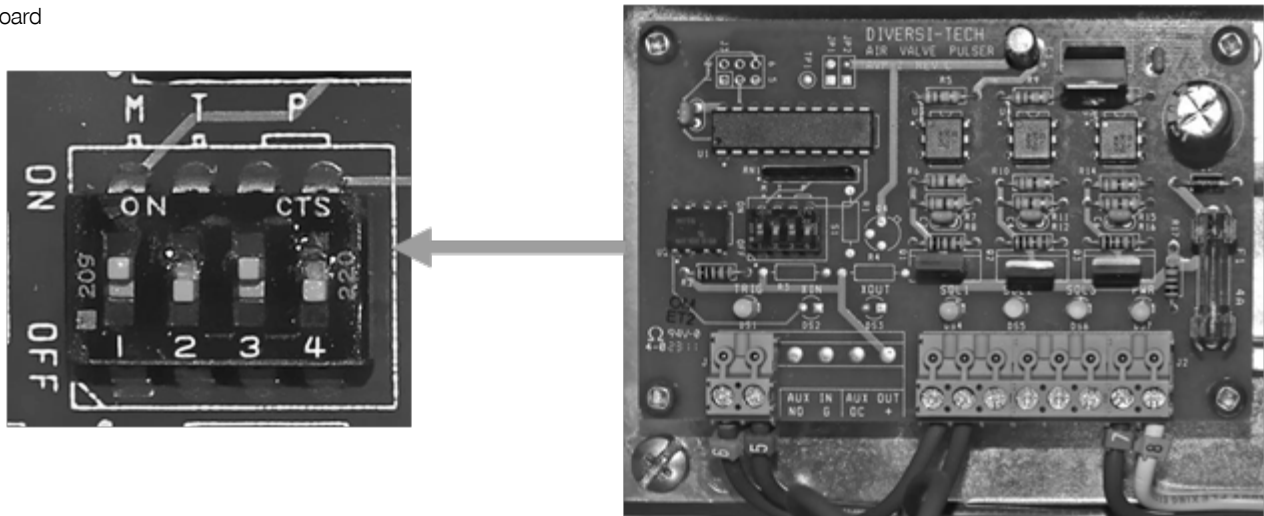

SECTION 5 - MAINTENANCE & TROUBLESHOOTING

5.1 To Maintain this Product Safely



- Read and understand **SECTION 1: Safety Precautions** and **SECTION 4: Operation before maintenance**.
- Do not breathe the dust collected from product while changing/cleaning filters or performing maintenance on this product.



- Disconnect power before performing any maintenance on unit, including filter inspection. The input power to this unit is high voltage, and touching any live electrical parts can cause fatal shocks or severe burns. Do not touch live electrical parts.



- Keep away from all mechanical moving parts including motor, gears, and other pinch points while operating.



- Operating this unit causes some parts to heat to a point that will burn bare hands. Before maintenance allow parts to cool, or use proper tools and personal protection equipment during maintenance.

5.2 Tools Required



EYE
PROTECTION



RESPIRATOR



GLOVES



WASTE
CONTAINER

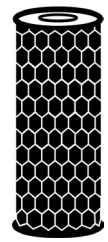

REPLACEMENT
FILTER
(if required)

5.3 Routine Maintenance Schedule

Warning

- Do not attempt to clean filters containing hazardous materials; refer to local regulations regarding disposal procedures as some captured contaminants may be flammable, explosive, or toxic.
- Cleaning cartridge filters with compressed air, water, or solvents can damage/destroy the filter media. Always check the manufacturer's instructions and specifications prior to cleaning.



Nanofiber / Paper-pleated filters

- Do not wet or clean the cartridge with any liquid, as it may cause the forming of unwanted blockage on the filter media.

Spunbond-poly filters

- Cleaning should be carried out on water-soluble materials only.
- Hydrocarbons may not be removable.
- The use of solvents may attack certain components of the filter. Consult the instructions and specifications prior to cleaning.

The manufacturer recommends the following routine maintenance based on light-duty use in normal operating conditions. Service more frequently if the unit is used in severe conditions.

Frequency	Manual Reference
Pre-Use	
<ul style="list-style-type: none"> • Perform pre-use inspection to ensure operating correctly. • If your application involves grinding, or any process that produces heat/sparks – lift the top grate and visually confirm that metal-mesh pre-filters (spark arrestors) are correctly seated on the baffle tray, and that no holes are present. 	4.3
Every (1) Week or 20 Operating Hours - Empty Dust Drawer/Clean Surface	
<ul style="list-style-type: none"> • Remove and wipe clean surface matting (if used). Remove dust drawer and deposit accumulated particulate in appropriate waste container. Refer to local regulations regarding disposal procedures as some captured contaminants may be flammable, explosive, or toxic. • Particles and stray material on the surface should be blown into the table towards the filter using compressed air. If a cushion grid mat (option) is used, direct particles into the table using a broom or brush. <p>Recommended frequency is one week, but may be less or more depending on application and duty cycle.</p>	
Every (4) Week or 80 Operating Hours – Inspect/Clean Cabinet	
<ul style="list-style-type: none"> • Remove and wipe down dust drawer, baffle trays, and metal mesh prefilters, depositing accumulated particulate in appropriate waste container. Refer to local regulations regarding disposal procedures as some captured contaminants may be flammable, explosive, or toxic. • Inspect, and clean if necessary the cabinet interior and dust drawer slats. • Inspect Metal Mesh Prefilter for any holes, or damage caused by hot sparks. Metal Mesh Prefilter can be cleaned by either blowing out with compressed air, or submerging and washing in warm, soapy water. 	
As Required – Replace Filter	
<ol style="list-style-type: none"> 1. Replace Filter, see SECTION 5.4: Filter Replacement for instruction 	
Every (12) months Inspect Basic Components	
<ol style="list-style-type: none"> 1. Clean unreadable labels and exterior surfaces 2. Cabinet: Check for loose wiring. 	

5.4 Filter Replacement

The table's reverse-pulse filter system works to extend the life expectancy of your filter(s). The actual usable life of the filter varies greatly on application, density, particle size, humidity, oil, but the typical range when pulsed regularly is 6-18 months.

As part of routine maintenance, it is important to visually inspect the filter. Replace the filter if you see:

1. Overloading or accumulation of particles
2. Rips, tears, or warping of filter media
3. Decreased table performance due to excessive static build up

To remove the filter, follow this 8-step procedure:

1. Open the cabinet door



2. Unhook barrel bolt latch.



3. Slide filter cartridge(s) out



4. Inspect cabinet interior for debris.



5. Open dust drawer and remove material.



6. Insert clean replacement filter.



7. Hook barrel bolt latch.



8. Close the cabinet door.



5.5 Troubleshooting Procedure

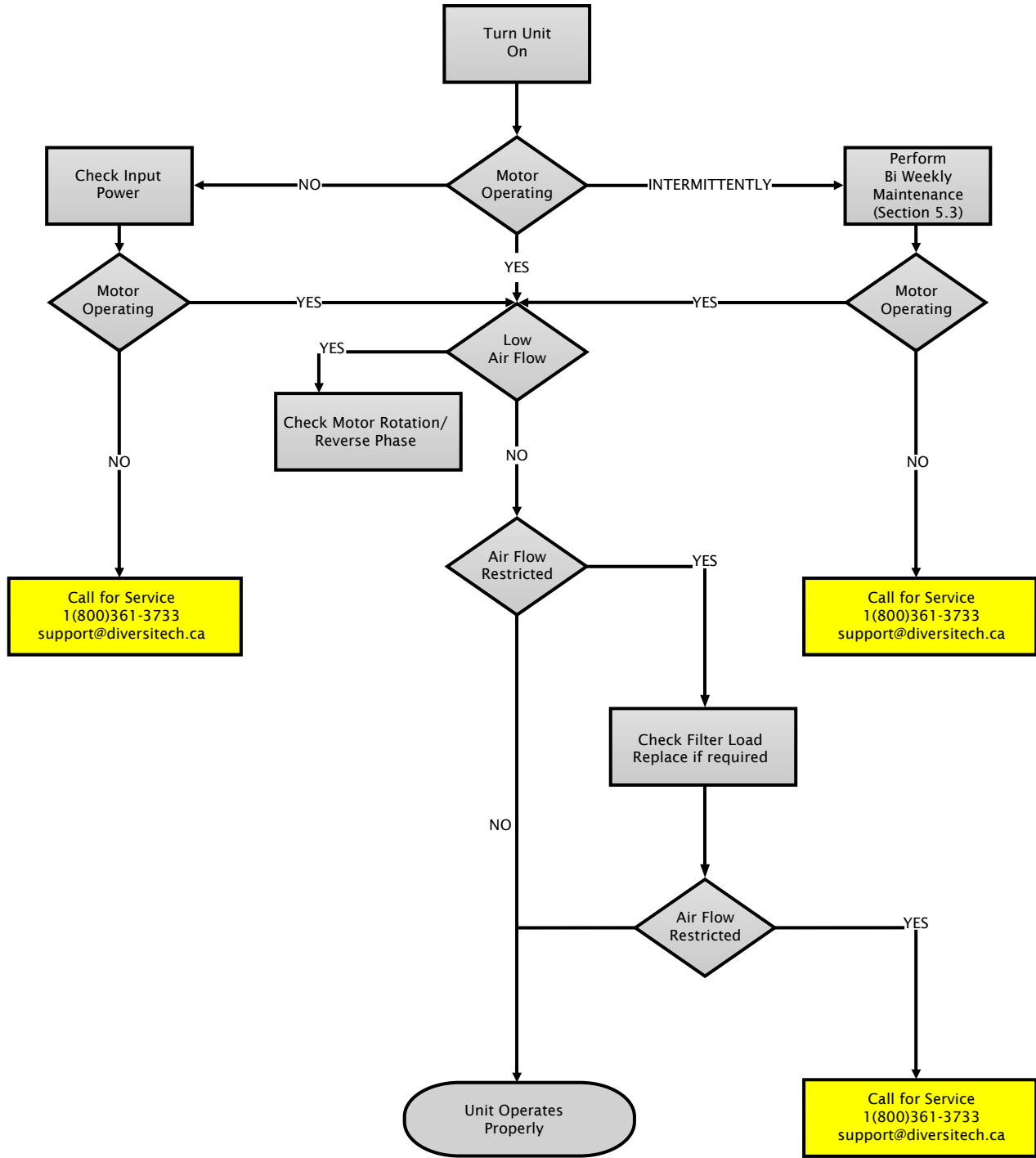

APPENDIX 1 - ELECTRICAL DIAGRAM MANUAL

[230/460/575v] 3-Phase Power



ELECTRIC SHOCK HAZARD

Disconnect power before performing any maintenance on unit, including filter inspection. The input power to this unit is high voltage, and touching any live electrical parts can cause fatal shocks or severe burns. Do not touch live electrical parts.

DiversiTech
CONTROL & POWER DIAGRAM
DST-22A

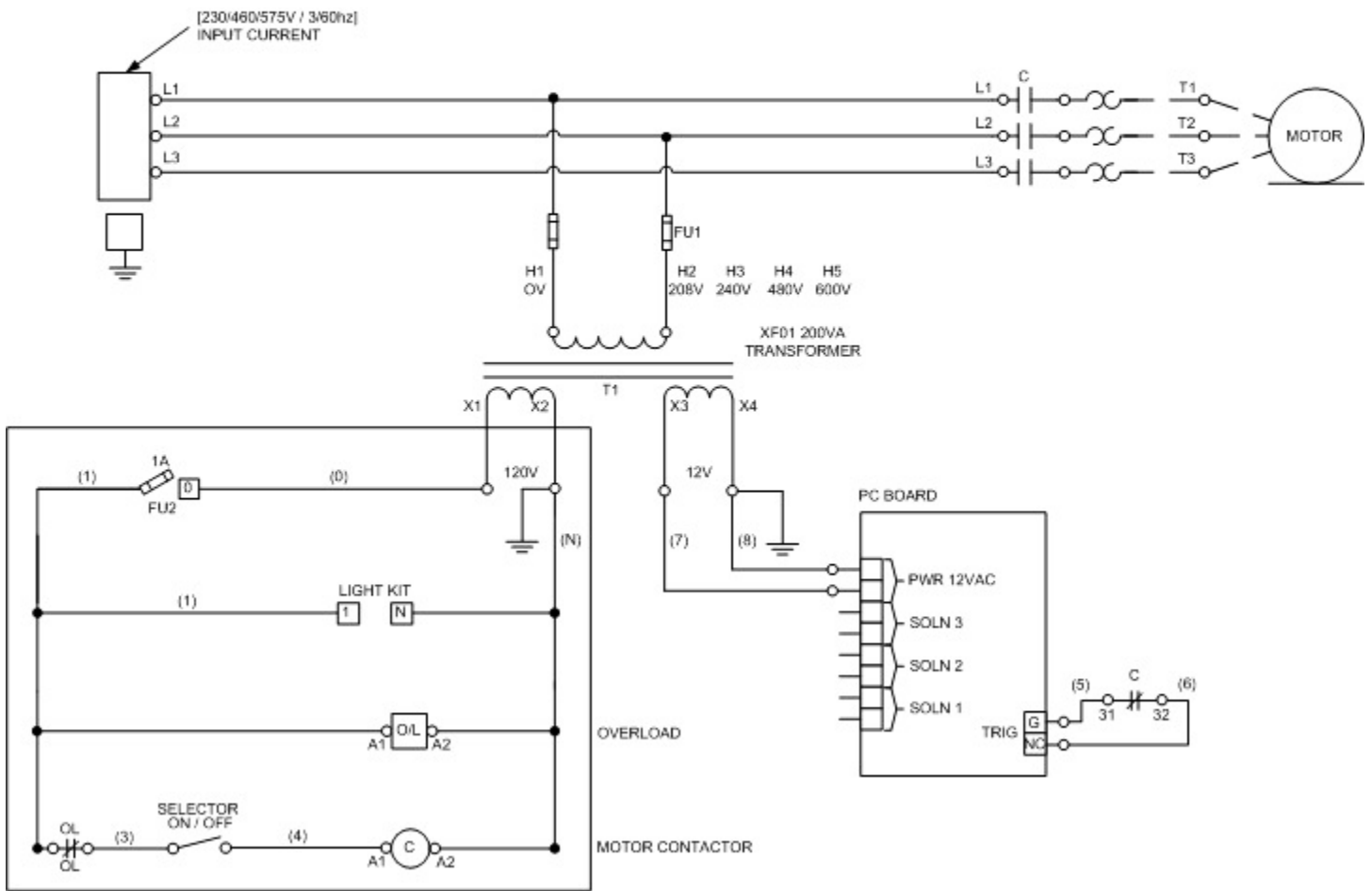

APPENDIX 2 - MAINTENANCE RECORD

Diversitech Inc. authorizes this page to be photocopied or otherwise reproduced as needed for management of maintenance records.

MANUFACTURER:	DIVERSITECH INC.	MODEL N°	DOWNDRAFT	SERIAL N°	
SERVICE LOCATION:				CONTROL N°	

Date	Description of Service	Serviced By	Location	Comments

Only use manufacturer approved replacement parts on this unit.

APPENDIX 3 - REPLACEMENT PARTS

Industrial Downdraft Tables

ITEM NUMBER	DESCRIPTION	DD-3X4	DD-3X6	DD-3X8	DD-4X4	DD-4X6	DD-4X8	DD-5X10
S-DXD-0907	3/4" Air Valve, DD	✓	✓	✓	✓	✓	✓	✓
S-DXD-0808	Solenoid Valve 12V AC 60Hz	✓	✓	✓	✓	✓	✓	✓
S-DXD-0106	AVP-Z Pulse Cleaning Control Board	✓	✓	✓	✓	✓	✓	✓
S-C ONE-0074	5.0HP Motor Cone, Plastic	✓	✓		✓			
S-C ONE-0063	7.5/10HP Motor Cone, Steel		✓	✓		✓	✓	
S-C ONE-0064	15.0HP Motor Cone, Steel							✓
S-WHEL-0003	5.0HP Composite Blower Wheel, Backward Inclined	✓	✓		✓			
S-WHEL-0010	7.5HP Aluminum Blower Wheel, Backward Inclined		✓	✓		✓		
S-WHEL-0011	10.0HP Aluminum Blower Wheel, Backward Inclined			✓		✓	✓	
S-WHEL-0012	15.0HP Aluminum Blower Wheel, Backward Inclined							✓
S-184T-050T2	5.0HP TEFC MOTOR [230/3/60]	✓	✓		✓			
S-184T-050T4	5.0HP TEFC MOTOR [460/3/60]	✓	✓		✓			
S-184T-050T5	5.0HP TEFC MOTOR [575/3/60]	✓	✓		✓			
S-213T-075T2	7.5HP TEFC MOTOR [230/3/60]		✓	✓		✓		
S-213T-075T4	7.5HP TEFC MOTOR [460/3/60]		✓	✓		✓		
S-213T-075T5	7.5HP TEFC MOTOR [575/3/60]		✓	✓		✓		
S-215T-100T2	10.0HP TEFC Motor [230/3/60]			✓		✓	✓	
S-215T-100T4	10.0HP TEFC Motor [460/3/60]			✓		✓	✓	
S-215T-100T5	10.0HP TEFC Motor [575/3/60]			✓		✓	✓	
S-254T-150T2	15.0HP TEFC Motor [230/3/60]							✓
S-254T-150T4	15.0HP TEFC Motor [460/3/60]							✓
S-254T-150T5	15.0HP TEFC Motor [575/3/60]							✓

APPENDIX 4 - TABLE OPTIONS

Industrial Downdraft Tables

PART NUMBER	DESCRIPTION	DD-3X4	DD-3X6	DD-3X8	DD-4X4	DD-4X6	DD-4X8	DD-5X10
Enclosure Options								
A-#X#-SBW-01	Side & back walls, powder coated mild steel	✓	✓	✓				✓
A-#X#-SBW-02	Hinged right side & fixed back/left side walls, powder coated mild steel	✓	✓	✓				
A-#X#-SBW-04	Hinged left/right side walls & fixed back wall, powder coated mild steel	✓	✓	✓				
A-#X#-SBW-11	Side & back walls, 4" steel frame with clear lexan insert	✓	✓	✓				
A-#X#-SBW-12	Hinged right wall & fixed back/left walls, 4" steel frame w/ clear lexan insert	✓	✓	✓				
A-#X#-SBW-14	Hinged left/right side walls & fixed back, 4" steel frame w/ clear lexan insert	✓	✓	✓				
A-#X#-SMW-01	Side walls & middle separator, powder coated mild steel				✓	✓	✓	✓
A-#X#-SMW-11	Side walls & middle separator, 4" steel frame with clear lexan insert				✓	✓	✓	✓
Build Options								
O-#X#-LK-24L	24" Dust & Vapor Proof LED Light Kit	✓			✓✓			
O-#X#-LK-48L	48" Dust & Vapor Proof LED Light Kit		✓	✓		✓✓	✓✓	✓✓
O-#X#-BDH	Backdraft hood w/sliding gates	✓	✓	✓				
O-#X#-XA	Extractor Arm w/bracket, flexhose, and blast gate (6" x 10')	✓	✓	✓	✓	✓	✓	✓
O-#X#-MH	Minihelic gauge	✓	✓	✓	✓	✓	✓	✓
O-#X#-SC	3" Swivel caster set	✓	✓	✓	✓	✓	✓	✓
O-#X#-MR	Mirror table	✓	✓	✓	✓	✓	✓	✓
Build Options								
O-#X#-CC	Odor Kit Adds: Carbon Canister module w/activated carbon granules	✓	✓	✓	✓	✓	✓	
A-#X#-HEPA2	Dual HEPA afterfilters w/frames, MERV 17	✓	✓	✓	✓	✓	✓	✓
A-#X#-OPT	Set of Opti-Flow grates	✓	✓	✓	✓	✓	✓	✓
A-#X#-C GM-B	Blue cushion grid matting	✓	✓	✓	✓	✓	✓	✓
A-#X#-GL	Grounding lug	✓	✓	✓	✓	✓	✓	✓

APPENDIX 5 - INSTALLING SIDE & BACK WALLS

To install the side & back walls, follow this 3-step procedure:

1. Prepare hardware



- Locate the bolt holes on the side and back of the cabinet
- Loosely attach the bolts, lock washers, and washers
- Leave a sufficient gap to fit the wall between the cabinet and the washers

2. Attach walls.



- Place one back wall, and one side wall with the flange facing outwards between the cabinet and the washers
- While resting the wall edge on the bolts, check for alignment of bolt holes

3. Fasten hardware

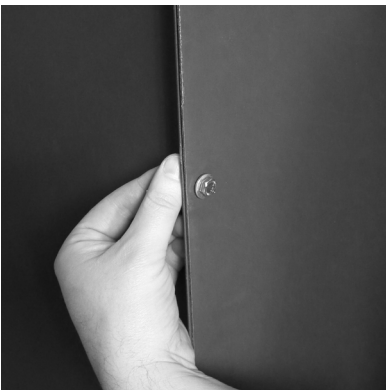

- Fasten bolt, lock washer, washer, nut on the vertical edge – attaching one side wall to one back wall
- Repeat process to all walls
- Ensure hardware is tight, securing the side and back walls to the cabinet

NOTES

NOTES

NOTES

NOTES

LIMITED EQUIPMENT WARRANTY

For a period of 2 years from the date of purchase, all Diversitech products are warranted to be free from defects in material, workmanship, and construction, when used in accordance with installation, maintenance instructions, and expressly stated proper use application(s). Diversitech Inc. will repair or replace, at our option, any defective parts which fail during the warranty period. This warranty is limited to replacement parts ONLY, and does not cover personal liability, property loss, normal wear; and does not cover losses resulting from (or due to) improper installation, inadequate maintenance, misapplication, misuse, or use above rated capacities.

FREIGHT CLAIMS

Shipments must be inspected upon arrival. All Diversitech units are sold ex-plant. Therefore, it is the receiver's responsibility to file any freight claims with the carrier for obvious or concealed damages. Damaged shipments must be refused at time of receipt, by consignee.

RETURN MATERIAL POLICY

Prior to the return of material, for whatever reason, a return manufacturing authorization number (RMA#) is required from the Diversitech customer service department. This procedure is necessary for proper control and handling of returned materials. Call 1-800-361-3733 or email support@diversitech.ca to obtain an RMA.

All material must be returned prepaid. Credit will be given for returns for warranty repair or replacement. Freight collect shipments, or freight without an RMA, will not be accepted. It is the shipper's responsibility to ensure that material being returned to Diversitech is adequately packaged for shipment to preclude damages.



Visit our Website for more
information on this product
www.diversitech.ca

1200 55th Avenue
Montreal, Quebec H8T 3J8
Email: info@diversitech.ca