

# Hypertherm®

## Echion™

### Operator Manual

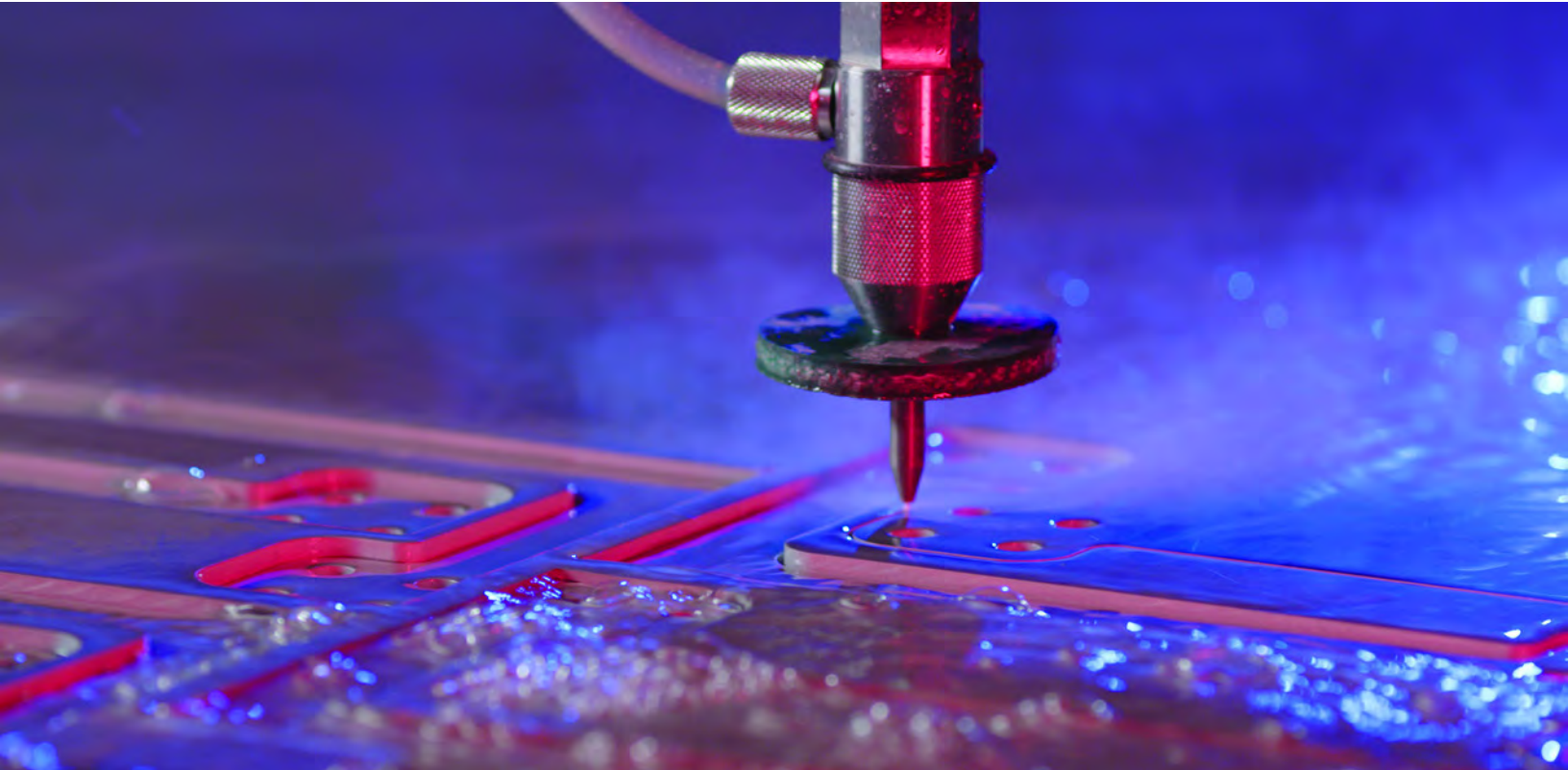

810770 - REVISION 1

ENGLISH



**COMPLETE  
METALWORKING  
SOLUTIONS**

(800) 991-4225

[www.ahbinc.com](http://www.ahbinc.com)

ISO Certified

[customerservice@ahbinc.com](mailto:customerservice@ahbinc.com)



HyPrecision, Echion, and Hypertherm are trademarks of Hypertherm, Inc. and may be registered in the United States and other countries. All other trademarks are the property of their respective holders.

Environmental stewardship is one of Hypertherm's core values, and it is critical to our success and our customers' success. We are striving to reduce the environmental impact of everything we do. For more information: [www.hypertherm.com/environment](http://www.hypertherm.com/environment).

© 2020 Hypertherm, Inc.

***Echion***

**Operator Manual**

810770  
REVISION 1

ENGLISH  
Original instructions

March 2020

Hypertherm, Inc.  
Hanover, NH 03755 USA  
[www.hypertherm.com](http://www.hypertherm.com)

**Hypertherm, Inc.**

Etna Road, P.O. Box 5010

Hanover, NH 03755 USA

603-643-3441 Tel (Main Office)

603-643-5352 Fax (All Departments)

info@hypertherm.com (Main Office Email)

**800-643-9878 Tel (Technical Service)**

technical.service@hypertherm.com (Technical Service Email)

**800-737-2978 Tel (Customer Service)**

customer.service@hypertherm.com (Customer Service Email)

**866-643-7711 Tel (Return Materials Authorization)**

**877-371-2876 Fax (Return Materials Authorization)**

return.materials@hypertherm.com (RMA email)

**Hypertherm México, S.A. de C.V.**

Avenida Toluca No. 444, Anexo 1,

Colonia Olivar de los Padres

Delegación Álvaro Obregón

México, D.F. C.P. 01780

52 55 5681 8109 Tel

52 55 5683 2127 Fax

Soporte.Tecnico@hypertherm.com (Technical Service Email)

**Hypertherm Plasmatechnik GmbH**

Sophie-Scholl-Platz 5

63452 Hanau

Germany

00 800 33 24 97 37 Tel

00 800 49 73 73 29 Fax

**31 (0) 165 596900 Tel (Technical Service)**

**00 800 4973 7843 Tel (Technical Service)**

technicalservice.emea@hypertherm.com (Technical Service Email)

**Hypertherm (Singapore) Pte Ltd.**

82 Genting Lane

Media Centre

Annexe Block #A01-01

Singapore 349567, Republic of Singapore

65 6841 2489 Tel

65 6841 2490 Fax

Marketing.asia@hypertherm.com (Marketing Email)

TechSupportAPAC@hypertherm.com (Technical Service Email)

**Hypertherm Japan Ltd.**

Level 9, Edobori Center Building

2-1-1 Edobori, Nishi-ku

Osaka 550-0002 Japan

81 6 6225 1183 Tel

81 6 6225 1184 Fax

HTJapan.info@hypertherm.com (Main Office Email)

TechSupportAPAC@hypertherm.com (Technical Service Email)

**Hypertherm Europe B.V.**

Vaartveld 9, 4704 SE

Roosendaal, Nederland

31 165 596907 Tel

31 165 596901 Fax

31 165 596908 Tel (Marketing)

**31 (0) 165 596900 Tel (Technical Service)**

**00 800 4973 7843 Tel (Technical Service)**

technicalservice.emea@hypertherm.com

(Technical Service Email)

**Hypertherm (Shanghai) Trading Co., Ltd.**

B301, 495 ShangZhong Road

Shanghai, 200231

PR China

86-21-80231122 Tel

86-21-80231120 Fax

**86-21-80231128 Tel (Technical Service)**

techsupport.china@hypertherm.com

(Technical Service Email)

**South America & Central America: Hypertherm Brasil Ltda.**

Rua Bras Cubas, 231 – Jardim Maia

Guarulhos, SP – Brasil

CEP 07115-030

55 11 2409 2636 Tel

tecnico.sa@hypertherm.com (Technical Service Email)

**Hypertherm Korea Branch**

#3904. APEC-ro 17. Heaundae-gu. Busan.

Korea 48060

82 (0)51 747 0358 Tel

82 (0)51 701 0358 Fax

Marketing.korea@hypertherm.com (Marketing Email)

TechSupportAPAC@hypertherm.com

(Technical Service Email)

**Hypertherm Pty Limited**

GPO Box 4836

Sydney NSW 2001, Australia

61 (0) 437 606 995 Tel

61 7 3219 9010 Fax

au.sales@Hypertherm.com (Main Office Email)

TechSupportAPAC@hypertherm.com

(Technical Service Email)

**Hypertherm (India) Thermal Cutting Pvt. Ltd**

A-18 / B-1 Extension,

Mohan Co-Operative Industrial Estate,

Mathura Road, New Delhi 110044, India

91-11-40521201 / 2 / 3 Tel

91-11 40521204 Fax

HTIndia.info@hypertherm.com (Main Office Email)

TechSupportAPAC@hypertherm.com

(Technical Service Email)



For training and education resources, go to the Hypertherm Cutting Institute (HCI) online at [www.hypertherm.com/hci](http://www.hypertherm.com/hci).

Hypertherm products are designed and manufactured with a commitment to continuous quality control and safety. Contact a Hypertherm Technical Service Associate for information and support regarding the installation, operation, maintenance, and repair of this equipment.

# Contents

<b>Warranty</b> .....	<b>SC-11</b>
Waterjet product warranty .....	SC-11
Disclaimer .....	SC-12
<b>Product stewardship</b> .....	<b>SC-13</b>
National and local safety regulations.....	SC-13
Certification test marks.....	SC-14
Differences in national standards.....	SC-15
Higher-level systems .....	SC-16
<b>Environmental stewardship</b> .....	<b>SC-17</b>
Hypertherm products: waste and recycling.....	SC-17
Chemical handling and usage.....	SC-18
Particle emission and waste water quality .....	SC-19
<b>Safety</b> .....	<b>SC-21</b>
User qualification and training.....	SC-23
Emergency medical information and treatment.....	SC-24
Safety information for operation, maintenance, repair, and installation .....	SC-25
<b>Symbols and marks</b> .....	<b>SC-29</b>
Information and symbols.....	SC-29
Symbols and marks found on the equipment .....	SC-30

**1 Optional equipment ..... 33**

**2 Operation ..... 35**

Safety ..... 36

Operation panel..... 36

Operator interface: Primary operation screen ..... 37

Turn on the pump: beginning of day ..... 39

    Prepare the pump ..... 39

    Examine the hydraulic fluid..... 41

    Turn on the utilities ..... 42

    Turn on the controls ..... 42

    Start the pump ..... 43

    Do the preoperation maintenance inspections ..... 44

Operate the pump..... 47

    Select the pressure mode ..... 47

    Set the target water pressure ..... 47

Stop the pump ..... 48

    Stop the pump remotely ..... 48

    Stop the pump locally ..... 48

    Emergency stop..... 49

Turn off the pump: end of day ..... 50

**3 Preventive maintenance ..... 51**

Safety ..... 52

Benefits of preventive maintenance ..... 53

Training ..... 53

Operator interface: Maintenance screens..... 54

    Move the plunger..... 54

    Start the pump after maintenance..... 55

    Prepare for storage..... 55

    Inputs and outputs ..... 56

    Alarm log ..... 56

Tools ..... 57

Preventive maintenance schedule..... 58

Intensifier maintenance ..... 60

    Replace the plunger and the T-seal ..... 64

    Repair the high-pressure cylinder, the check valve, and the low-pressure poppet ..... 66

    Install the high-pressure components ..... 69

    Examine the output adapter and the high-pressure poppet assembly ..... 73

    Assemble the check valve and the low-pressure poppet ..... 74

Repair the bleed-down valve.....	75
Clean the air cooler .....	78
Clean the air side of the cooler.....	78
Clean the hydraulic fluid side of the cooler.....	79
Replace the water filter.....	80
Test the total dissolved solids (TDS) level .....	81
Test the water quality.....	83
Replace the hydraulic filter element.....	84
Add hydraulic fluid .....	85
Replace the hydraulic fluid.....	86
Lubricate the primary motor bearings.....	88
Start the pump after maintenance.....	90
Postmaintenance start procedure .....	91
Prepare for storage.....	93
Recycling and end of product life .....	96
<b>4 Parts lists.....</b>	<b>97</b>
Tools .....	98
Intensifier repair tools .....	99
Maintenance and repair kits.....	100
Optional equipment kits.....	103
Replacement parts.....	104
Lubricants .....	104
Electrical system.....	105
High-pressure water system.....	106
Low-pressure water system.....	108
Hydraulic system .....	109
<b>5 Troubleshooting.....</b>	<b>111</b>
Safety.....	112
General.....	112
Primary operation screen.....	113
Alarms.....	114
Types of alarms .....	114
Primary motor .....	117
Intensifier.....	118
Leaks.....	118
Overstroke .....	121

Hydraulic fluid ..... 123  
    Temperature..... 124  
    Pressure ..... 125  
    Level ..... 126  
    Appearance ..... 127  
Water ..... 128  
    Low-pressure water..... 128  
    High-pressure water..... 129  
    Leaks ..... 131  
The pump makes noise during operation ..... 133  
Controller errors ..... 134  
    Input/output status..... 134

**6 Specifications..... 135**

All Echion-model pumps ..... 136  
    Environmental conditions ..... 136  
    Hydraulic fluid ..... 136  
    Utilities ..... 137  
Echion 15..... 138  
    Dimensions and weights ..... 138  
    Electrical..... 138  
    Water..... 138  
Echion 30..... 139  
    Dimensions and weights ..... 139  
    Electrical..... 139  
    Water..... 139  
Echion 50..... 140  
    Dimensions and weights ..... 140  
    Electrical..... 140  
    Water..... 140  
Orifices ..... 141  
Stroke rate ..... 141  
Torque values ..... 142  
    Fasteners..... 142  
    Fittings ..... 144



<b>7</b>	<b>Installation .....</b>	<b>147</b>
	Safety .....	148
	Buyer responsibilities .....	148
	Requirements .....	149
	Location .....	149
	Cooling .....	149
	Hydraulic fluid .....	149
	Utilities .....	150
	Receive and unpack the equipment .....	151
	Install the pump .....	152
	Install the pump-mounted plumbing kit (optional) .....	153
	Connect the utilities to the pump .....	156
	Connect the water and the air .....	157
	Connect the electrical power .....	158
	Examine the hydraulic fluid .....	159
	Do the first start .....	159
	Do a preoperation inspection .....	160
	Turn on the utilities .....	160
	Make sure that the primary motor turns in the correct direction .....	161
	Turn on the pump .....	162
	Adjust the boost pump pressure .....	162
	Flush the pump and the high-pressure tubing .....	163
	Operator interface: Adjustment screens .....	164
	Pump Adjustments .....	164
	Pressure .....	169
	Date / Time / Language .....	169
	Intensifier Control .....	170
	SD Card .....	171
<b>8</b>	<b>Declaration of Conformity .....</b>	<b>173</b>
<b>9</b>	<b>Touchscreen maps .....</b>	<b>175</b>
	Primary operation screen .....	177
	Adjustment screens .....	181
	Maintenance screens .....	185
<b>10</b>	<b>Technical drawings .....</b>	<b>189</b>



# Warranty

## Waterjet product warranty

Product	Warranty coverage up to
Echion™ pump HyPrecision™ pump	27 months from the ship date, or 24 months from the date of proven installation, or 4,000 hours of operation, whichever occurs first
PowerDredge™ abrasive removal system EcoSift™ abrasive recycling system Reverse osmosis system Bulk abrasive pot Abrasive regulator On/off valve air actuator	15 months from the ship date, or 12 months from the date of proven installation, whichever occurs first
Diamond orifice	600 hours of operation with the use of a thimble filter and compliance with Hypertherm's water quality requirements

Hypertherm's warranty does not extend to defects, failures, damages, deficiencies, or errors that are:

- not reported to Hypertherm within the warranty period; or
- the result of modification, abuse, misuse, noncompliance with the installation or operation instructions, unauthorized repair, inadequate maintenance, neglect, accident, or the use of unapproved parts; or
- the result of normal wear; or
- the result of the system being operated contrary to Hypertherm's instructions or stated limits of rated and normal use.

**Warranty**

For information about the manufacturer's warranty, refer to the conditions of sale provided when the product was purchased.

Consumable parts are not included in this warranty. Consumable parts include high-pressure water seals, check valves, cylinders, bleed-down valves, low-pressure seals, high-pressure tubing, and filters.

All third-party motors, pumps, and plumbing accessories are warranted by the respective manufacturers and are not included in this warranty.

**Disclaimer**

---

All product information contained in this manual is believed to be reliable as of the date of publication. The manual could contain technical inaccuracies or typographical errors and can be changed or updated without notice.

# ***Product stewardship***

Hypertherm maintains a global regulatory management system to make sure that products comply with regulatory and environmental requirements.

## **National and local safety regulations**

---

National and local safety regulations shall take precedence over instructions supplied with the product. The product shall be imported, installed, operated, and discarded in compliance with national and local regulations applicable to the installation site.

## Certification test marks

Certified products are identified by 1 or more certification test marks from accredited testing laboratories.

The certification test marks are on the pump's data plate.

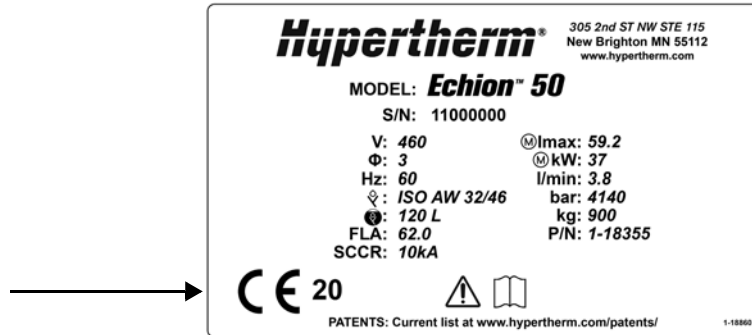

Each certification test mark means that the product and its safety-critical parts conform to the national safety standards as reviewed and determined by that testing laboratory.

Hypertherm puts a certification test mark on its products only after that product is manufactured with safety-critical parts that have been approved by the accredited testing laboratory.

Once the product has left the Hypertherm factory, the certification test marks are invalid if one or more of these events occurs.

- The product is modified in a manner that causes danger or does not conform with the applicable standards.
- Safety-critical parts are replaced with unapproved spare parts.
- Assembly is unauthorized.
- An accessory that uses or generates dangerous voltage is added.
- A safety circuit or other feature that is designed into the product as part of the certification has been tampered with.

**CE** The Conformité Européene (CE) mark affixed to a product signifies the manufacturer's declaration of conformity to applicable European directives and standards.

Only those versions of Hypertherm products with a CE mark on or near the data plate have been tested for compliance with the applicable European directives, such as the Low Voltage Directive, the Electromagnetic Compatibility Directive, and the Machinery Directive.



If this product has a Declaration of Conformity, a copy (in English) is included. Refer to [Declaration of Conformity](#) on page 173.

## Differences in national standards

---

Nations can apply different performance, safety, or other standards. National differences in standards include, but are not limited to:

- voltage.
- plug and cord ratings.
- language requirements.
- electromagnetic compatibility requirements.

Differences in national or other standards can make it impractical or impossible for all certification test marks to be put on the same version of a product. For example, the Canadian Standards Association (CSA) versions of Hypertherm's products do not comply with European electromagnetic compatibility requirements; therefore, they do not have a CE mark on the data plate.

Countries where the CE mark is necessary or that have compulsory electromagnetic compatibility regulations must use CE versions of Hypertherm products with the CE mark on the data plate.

These could include:

- countries in the European Union.
- Australia.
- New Zealand.
- Russia.

It is important that the product and its certification test mark be suitable for the end-use installation site. When Hypertherm products are shipped to one country for export to a different country, the product must be correctly configured and certified for the end-use installation site.

## Higher-level systems

---

When an original equipment manufacturer (OEM) or a system integrator adds equipment such as cutting tables, motor drives, motion controllers, or robots to a Hypertherm waterjet cutting system, the system is considered a higher-level system. A higher-level system with dangerous moving parts can constitute industrial machinery or robotic equipment, in which case the OEM, system integrator, or end-use customer can be subject to more regulations and standards than those applicable to the waterjet cutting system manufactured by Hypertherm.

It is the responsibility of the end-use customer and the OEM or system integrator to do a risk assessment for the higher-level system and to provide protection against dangerous moving parts.

Unless the higher-level system is certified when the OEM or system integrator incorporates Hypertherm products into it, the installation can be subject to approval by local authorities. Get advice from legal counsel and local regulatory experts if you are not sure about compliance.

External cables connecting parts of the higher-level system must be made for exposure to contamination and movement as necessary for the end-use installation site. When the external interconnecting cables are subject to exposure to oil, dust, water, or other contamination, hard usage ratings could be necessary.

When external interconnecting cables are subject to continuous movement, constant flexing ratings can be necessary. It is the responsibility of the OEM, system integrator, or end-use customer to make sure that external connecting cables are correct for the application and obey all national, state, and local regulations.



# ***Environmental stewardship***

## **Hypertherm products: waste and recycling**

---

Hypertherm waterjet cutting systems, like all products with electronics, can contain materials or parts, such as printed circuit boards, that cannot be discarded with ordinary waste. It is your responsibility to discard Hypertherm products or parts in an environmentally suitable manner and in compliance with national and local codes.

In the United States, read all national, state, and local laws. In the European Union (EU), read the EU directives, national, and local laws. In other countries, refer to national and local laws. Consult with legal or other compliance experts, when applicable. For information, go to [www.hypertherm.com/customer-support/product-service/recycling](http://www.hypertherm.com/customer-support/product-service/recycling).

## Chemical handling and usage

Material safety data sheets (MSDS) and safety data sheets (SDS) are part of a hazard communication plan that supplies detailed information about dangerous chemicals. The information includes the chemical's toxicity and reactivity, first aid for exposure, approved storage and disposal, recommended protective equipment, and spill-handling procedures.

The Occupational Safety and Health Administration (OSHA) has presented new dangerous chemical labeling requirements as a part of its recent revision of the Hazard Communication Standard (29 CFR 1910.1200), to align with the United Nations' Globally Harmonized System of Classification and Labelling of Chemicals (GHS). The GHS is an international system for standardizing chemical classification and labeling.

Chemical regulations in the USA, Europe, and other locations require that MSDS and SDS be made available for chemicals that are supplied with the product and chemicals used in or on the product. The list of chemicals is supplied by Hypertherm.

To see MSDS and SDS:

1. Go to [www.hypertherm.com/docs](http://www.hypertherm.com/docs).
2. Look for "To view all regulatory and compliance documents, click here" below the Select your product box.

Documents library

The screenshot shows a web interface titled "Documents library". Underneath, there is a section titled "Select your product" which contains a dropdown menu with "Products" selected. Below the dropdown is a checkbox labeled "Include discontinued items" which is currently unchecked. At the bottom of the section, there is a note: "You can also enter a document part number in the search documents box."

To view all regulatory and compliance documents, [click here](#).

3. Look for Safety Data Sheets. Click +.

Safety Data Sheets (SDS)



These navigation instructions can change without notice.

## **Particle emission and waste water quality**

---

Hypertherm does not manufacture or supply the materials that are cut and has no knowledge about the particles released from materials that are cut and if they can pose a physical danger or health risk. Get advice from your supplier or other technical advisor for guidance concerning the properties of the material you cut with a Hypertherm product.

If you are not familiar with the current applicable government regulations and legal standards for the installation site, get advice from a local expert before you purchase, install, and operate this equipment.



# ***Safety***

The end user is responsible for the safe operation of this equipment.

**WARNING**

Before operating Hypertherm equipment, read the safety instructions in your product's manual.

## Safety

Copies of Hypertherm manuals can accompany the product in electronic and printed formats. Copies of the manuals are online, in all languages available for each manual.

1. Go to [www.hypertherm.com/docs](http://www.hypertherm.com/docs).
2. Under Select your product, choose **Waterjet Family** in the dropdown list.
3. Go to the **Operator and instruction manuals** section and click **+**.
4. Click on the manual for your product. You may have to click on **SHOW ALL** at the bottom of the section.

A PDF of the manual downloads to your device.



These navigation instructions can change without notice.

The safety precautions in this manual are general and cannot anticipate every situation. Hypertherm, Inc. acknowledges that unforeseen situations such as equipment failure, site variability, insufficient maintenance, failure of control equipment, and other events can cause equipment damage, injuries, or death. It is the user's responsibility to identify dangers and to take the steps necessary to minimize risks.

Keep these instructions near the equipment. This manual is intended to familiarize the user with the equipment and its parts, safe operation, and maintenance.

All personnel who operate or have access to this equipment must know this information:

- applicable safety standards.
- the use, limitations, and maintenance of personal protective equipment.
- the location of the written hazard communication program and safety data sheets.
- how to recognize dangerous energy sources.
- the correct methods for isolating and controlling energy, to include lock out–tag out procedures.

## User qualification and training

---

All users must read and understand these instructions before installing, operating, or doing maintenance on this equipment.



Do not let an untrained person operate this equipment. Operators must be approved to operate and maintain this equipment.

Training should include:

- how to start and stop the equipment during operation and in an emergency situation.
- conditions and procedures that can lead to injuries to personnel and damage to the equipment.
- how to operate all controls.
- how to identify and respond to a problem with the equipment.
- how to do maintenance procedures.
- a copy of the operator manual.

This list is not all-inclusive.

## Emergency medical information and treatment

<p><b>WARNING</b></p> 	<p>A waterjet is a cutting tool.</p> <p>Keep away from high-pressure streams and leaks. Pressurized fluid can cause injuries.</p> <p>Delayed treatment can cause injuries or death.</p>
<p><b>WARNING</b></p> 	<p>Do not put ice or heat on a waterjet injury.</p> <p>If possible, use a support to keep injured body parts above heart level.</p>

High-pressure equipment puts the operator and other personnel at risk of contact with high-pressure water. Possible injuries include eye damage, lacerations, infections, and amputations.









Waterjet operators should have a waterproof emergency medical tag or card that describes the recommended treatment for high-pressure water injuries. Show the tag or card to emergency responders and medical professionals.









This wallet-size card can be copied, laminated, and folded.





<p><b>MEDICAL INFORMATION</b></p>  <p>A high-pressure injection injury is a surgical emergency. Get medical treatment immediately for all high-pressure waterjet injuries.</p>	<p>The person with this card has been exposed to a waterjet of up to 4,140 bar (60,000 psi) and a velocity of 609 m/s (2,000 feet/second). Abrasive waterjets can eject water and abrasive materials that can be injected into body tissues, leading to a dangerous infection.</p> <ul style="list-style-type: none"> <li>■ Skin can appear to be not damaged or show a small pinhole-sized puncture wound.</li> <li>■ The injured area can become swollen, painful, and pale over the next 4 to 6 hours.</li> <li>■ Tissue becomes ischemic and necrotic within 12 hours.</li> </ul>
<ul style="list-style-type: none"> <li>■ Do not use digital or local nerve blocks.</li> <li>■ Give analgesics by mouth or injection.</li> </ul>	<ul style="list-style-type: none"> <li>■ Consult a surgical specialist immediately for decompression, removal of foreign materials, and debridement.</li> <li>■ Give broad-spectrum, intravenous antibiotics for Gram-negative and Gram-positive organisms.</li> <li>■ X-ray is the preferred imaging method.</li> <li>■ Acute compartment syndrome is possible.</li> <li>■ Leave the wound open.</li> <li>■ Do not use solvents other than isotonic sodium chloride solution for irrigating the wound.</li> </ul>



## Safety information for operation, maintenance, repair, and installation

<b>WARNING</b>	Make sure that all connections, fasteners, locking devices, hoses, and fittings are tight before operation.
	
<b>WARNING</b>	Make sure that the shaft access cover and all other safety devices are correctly installed before operating this machine.
	
<b>WARNING</b>	Do not stand in line with high-pressure fittings when operating this equipment. If a high-pressure fitting fails, it can cause a stream of water or hydraulic fluid to eject from the system with force.
	
<b>WARNING</b>	Do not leave waterjet cutting equipment unattended while it is operating.
	
<b>WARNING</b>	During operation, keep a restricted-access area clear that is larger than the maximum movement range of the cutting equipment's moving parts.
	
<b>WARNING</b>	Let only approved personnel operate this machinery.
	
<b>DANGER</b>	Before opening the electrical enclosure or doing maintenance or repairs on this equipment, turn off the electrical power and release water pressure and hydraulic pressure from the system. Use standard lock out-tag out procedures. Isolate all sources of electrical, mechanical, hydraulic, pneumatic, chemical, thermal, or other energy with a lockable energy-isolating device that satisfies national and local requirements.
	
<b>WARNING</b>	Release all high-pressure water before doing work on this equipment.
	
<b>WARNING</b>	Do not touch a hot surface. Water leaking from a high-pressure fitting or the bleed-down valve can be hot.
	

<p><b>WARNING</b></p> 	<p>Obey all safety requirements and applicable safety laws and regulations.</p> <p>Obey national and local codes regarding installation, repairs, and maintenance of the electrical and plumbing systems.</p> <p>All work that requires opening the electrical enclosure or removing covers or panels from this equipment must be done only by an approved technician.</p> <p>It is your responsibility to investigate and obey all local codes.</p>
<p><b>WARNING</b></p> 	<p>A person who works on deenergized machinery can be injured or killed if the machinery is energized without permission.</p> <p>All personnel in an area where energy-control procedures are used must receive training for energy-control procedures.</p>
<p><b>WARNING</b></p> 	<p style="text-align: center;"><b>DANGEROUS VOLTAGE/RISK OF SHOCK</b></p> <p>Doing work on this equipment while it is energized is dangerous.</p> <p>Personnel who maintain and repair this equipment can be injured or killed if dangerous energy is not controlled.</p> <p>Injuries can include burns, cuts, fractures, or electrocution.</p>
<p><b>WARNING</b></p> 	<p>Before removing a lock-out device:</p> <ul style="list-style-type: none"> <li>• obey the employer's energy-control procedure.</li> <li>• examine machines and parts to make sure that they are operational.</li> <li>• make sure that all personnel are safely away from machines.</li> </ul> <p>After removing energy-isolation devices, make sure that all personnel in the area know that the devices are removed and that the machine is being energized.</p>
<p><b>WARNING</b></p> 	<p>To reduce the risk of injuries or death, wear approved protection and obey safety recommendations when doing work with electricity.</p>
<p><b>WARNING</b></p> 	<p>When work must be done in a small space or an area with limited access, the access must not be blocked by ventilation ducts, hoses, pipes, or other equipment.</p>
<p><b>WARNING</b></p> 	<p>Do not block or remove warnings, cautions, or instructions.</p>
<p><b>WARNING</b></p> 	<p>Personal protective equipment is recommended.</p> <p>If you do not use personal protective equipment, there is a risk of injury or death.</p>
<p><b>WARNING</b></p> 	<p>High-pressure water can cause eye injuries.</p> <p>Wear approved eye protection when operating or doing work near this equipment.</p>







<p><b>WARNING</b></p> 	<p>This waterjet equipment could make more noise than is permitted by national or local codes. When this intensifier is operating, the noise level is 75 dB(A) to 85 dB(A).</p> <p>Water flow rate, pipe layout, and the acoustical characteristics of the building have an effect on noise level.</p> <p>Long periods of exposure to noise can cause permanent hearing loss.</p> <p>Wear approved ear protection and control exposure time when operating or doing work near this equipment.</p>
<p><b>WARNING</b></p> 	<p>High-pressure water can cause cuts, abrasions, and punctures.</p> <p>Precision parts can have sharp corners or edges.</p> <p>Wear approved hand protection when operating or doing work near this equipment and when touching parts.</p>
<p><b>WARNING</b></p> 	<p>Some materials can cause airborne contamination or particles when cut.</p> <p>Wear approved respiratory protection when operating or doing work near this equipment.</p>
<p><b>CAUTION</b></p> 	<p>Examine and clean the equipment regularly.</p> <p>Refer to the <a href="#">Preventive maintenance schedule</a> on page 58.</p> <p>Do repairs immediately.</p>





# Symbols and marks

## Information and symbols









Some symbols in this table could apply to other products.







<p><b>DANGER</b></p> 	<p><b>DANGER</b> identifies an imminently dangerous condition or a situation that <b>WILL</b> cause serious injuries or death if ignored.</p>
<p><b>WARNING</b></p> 	<p><b>WARNING</b> identifies a dangerous condition or a situation that <b>COULD</b> cause injuries or death if ignored.</p>
<p><b>CAUTION</b></p> 	<p><b>CAUTION</b>, when used with the yellow warning sign, identifies a dangerous condition or a situation that <b>COULD</b> cause minor or moderate injuries or <b>WILL</b> cause damage to the equipment if ignored.</p>
<p><b>NOTICE</b></p>	<p><b>NOTICE</b> identifies a condition or a situation that <b>COULD</b> cause damage to the equipment if ignored.</p>
	<p>This symbol identifies a mandatory action.</p>
	<p>This symbol identifies a prohibited action.</p>
	<p>This symbol identifies tools or materials that are necessary or recommended for a procedure.</p>

	This symbol identifies information that could cause the user to fail at the task if ignored.
	This symbol identifies a tip or helpful information.











## Symbols and marks found on the equipment

Some symbols or marks in this table could apply to other Hypertherm products.

<b>DANGER</b> 	<b>DANGER</b> identifies an imminently dangerous condition or a situation that <b>WILL</b> cause serious injuries or death if ignored.
<b>DANGER</b> 	<b>ARC FLASH AND SHOCK HAZARD</b> Follow all requirements in NFPA 70E for safe work practices and for Personal Protective Equipment.
<b>WARNING</b> 	<b>WARNING</b> identifies a dangerous condition or a situation that <b>COULD</b> cause injuries or death if ignored.
<b>WARNING</b> 	<b>HAZARDOUS VOLTAGE</b> Disconnect power before servicing.
<b>WARNING</b> 	<b>WARNING</b> This product can expose you to chemicals including lead and lead compounds, which are known to the State of California to cause cancer and birth defects or other reproductive harm. For more information go to <a href="http://www.p65warnings.ca.gov">www.p65warnings.ca.gov</a> .
<b>WARNING</b> 	Hydraulic, water, and electrical connections can come loose during shipping and normal operation. It is recommended that all connections are examined at installation and annually.
<b>WARNING</b> 	Read and fully understand operator's manual before using this machine. Failure to follow operating instructions could result in death or serious injury.
<b>CAUTION</b> 	<b>CAUTION</b> , when used with the yellow warning sign, identifies a dangerous condition or a situation that <b>COULD</b> cause minor or moderate injuries or <b>WILL</b> cause damage to the equipment if ignored.

<p><b>CAUTION</b></p> 	<p>Do not touch a hot surface.</p>
	<p>Correct direction of motor rotation (motor rotation arrow)</p>
<p><b>S/N</b></p>	<p>Serial number</p>
<p><b>V</b></p>	<p>Volts</p>
<p><b>Φ</b></p>	<p>Number of phases in a power system</p>
<p><b>HZ</b></p>	<p>Frequency (hertz)</p>
	<p>Type of hydraulic fluid recommended</p>
	<p>Hydraulic fluid tank volume (liters)</p>
<p><b>FLA</b></p>	<p>Full-load current (amperage)</p>
<p><b>SCCR</b></p>	<p>Short-circuit current rating</p>
<p><b>(M) IMAX</b></p>	<p>Primary motor maximum current draw (amperes)</p>
<p><b>(M) KW</b></p>	<p>Primary motor power output (kilowatts)</p>
<p><b>L/MIN</b></p>	<p>Maximum outlet flow rate (liters/minute)</p>
<p><b>BAR</b></p>	<p>Maximum outlet water pressure (bar)</p>
<p><b>KG</b></p>	<p>Weight (kilograms)</p>
<p><b>P/N</b></p>	<p>Electrical enclosure part number</p>
<p><b>CE</b></p>	<p>The Conformité Européene (CE) mark affixed to a product signifies the manufacturer's declaration of conformity to applicable European directives and standards.</p> <p>Only those versions of Hypertherm products with a CE mark on or near the data plate have been tested for compliance with the applicable European directives, such as the Low Voltage Directive, the Electromagnetic Compatibility Directive, and the Machinery Directive.</p>
	<p>Use caution when operating this equipment.</p> <p>Refer to the instruction manual. Read and understand all of the safety guidelines in this manual.</p>
	<p>Identifies the terminal of a protective earth (ground) electrode or a terminal intended to connect to an external conductor for protection against electric shock during a fault condition</p>

**Symbols and marks**

	Controls
	Remote key switch off The key switch is in the Local position.
	Remote key switch on The key switch is in the Remote position.
	<b>COMPRESSED AIR</b> The bleed-down valve uses compressed air to operate.
	<b>CUTTING WATER IN</b> This line carries low-pressure water from a water softener, a reverse osmosis system, a well, or a public utility to the pump.
	<b>CUTTING WATER OUT</b> This tubing carries high-pressure water from the intensifier to the cutting table.
	<b>WASTE WATER OUT</b> This hose carries water from the bleed-down valve to a drain.
	<b>COOLING IN</b> This line carries low-pressure water from the local utility or a chiller to the pump's cooling loop.
	<b>COOLING OUT</b> This line carries low-pressure water from the heat exchanger to the chiller or to the drain.
	Start the pump symbol
	Stop the pump symbol



# 1

## ***Optional equipment***

### **Boost pump**

The pump will not operate satisfactorily if the supply-water pressure is too low for the pump to get to a stable pressure. A boost pump increases the water pressure to a value higher than the minimum requirement.

### **Modbus TCP/IP communication**

All Hypertherm waterjet pumps can use Ethernet to communicate with a CNC.

### **Utility connection panel kit**

The utility connections for the Echion pump are inside the pump, at the point of use. With this kit, utility connections are made on the outside of the pump.

### **Metric conversion kit**

This kit includes adapter fittings for use in countries where metric connections are standard.

### **Pump-mounted high-pressure plumbing kit**



This kit includes a bracket and a high-pressure tube to connect a high-pressure line directly to the pump.

For part numbers, refer to [Optional equipment kits](#) on page 103.

# 1 *Optional equipment*

# 2

## ***Operation***

	This section assumes that the user is familiar with the <a href="#">Safety</a> , <a href="#">Preventive maintenance</a> , <a href="#">Troubleshooting</a> , and <a href="#">Specifications</a> sections of this manual.
	Images in this manual are for reference purposes. It is possible that your product configuration is not shown accurately.
	It is possible that not all of the information in this section applies to all pump models.

## Safety

**WARNING**

**Read and understand all of the safety guidelines in this manual.**

Before operating, doing maintenance on, repairing, and installing your pump, read the [Safety](#) section, which starts on [page 21](#).

## Operation panel

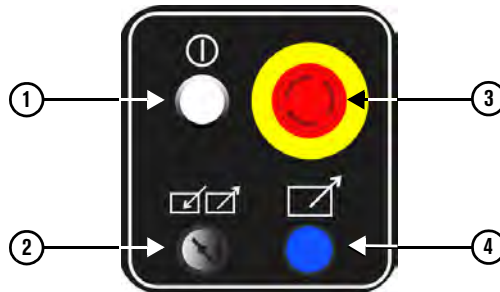

### 1 Controls button

Push the Controls button to turn **ON** the control circuit in the pump. The button lights when the control circuit is on.

### 2 Local/Remote key switch

- When the key switch is in the Local position, use the operator interface to operate the pump.
- When the key switch is in the Remote position, use the remote source, such as a computer numerical control (CNC) operator console, to control the pump.

Most functions on the operator interface are not available when the key switch is in the Remote position.

### 3 EMERGENCY STOP button

Push the Emergency Stop button to turn **OFF** the control circuit. Refer to [Emergency stop](#) on page 49.

### 4 Remote indicator light

When the key switch is in the Remote position, this indicator light is on.

## Operator interface: Primary operation screen



Refer to [Touchscreen maps](#) on page 175 to see all of the screens available on the controller.

These elements are on most screens.

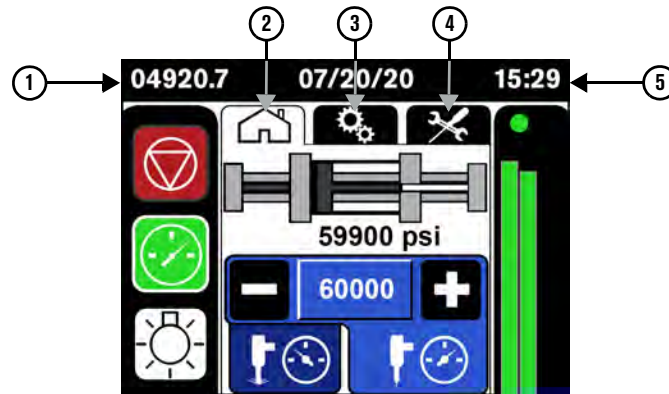

### 1 Hour meter

This shows the total hours the pump motor has been in operation.

### 2 Primary operation screen tab

- Turn the pump on or off.
- Select the pressure mode (cut or pierce).
- Set or change the water pressure.
- Monitor the status of the intensifier.

### 3 Adjustment screens tab

- See information about your system.
- Change some display options, such as pressure units (bar or psi) or language.
- Change timer durations.
- Turn features such as Modbus mode on or off.

Refer to [page 164](#).

### 4 Maintenance screens tab

- Move the plunger to one end of the intensifier.
- Prepare the pump for storage.
- See the alarm log.
- See the inputs-outputs from the controller.

Refer to [page 54](#).

### 5 Date and time

Refer to [page 169](#).

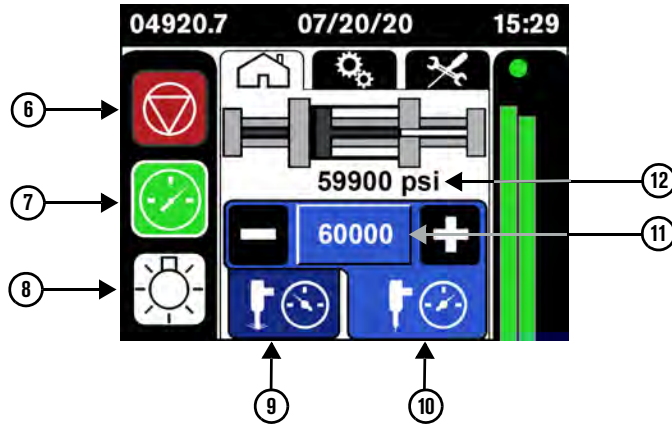

**6 Stop**

Touch this symbol to stop the pump.

**7 Start**

Touch this symbol to start the pump.

**8 LED light on/off**

Touch this symbol to turn the red LED lights **ON** or **OFF**.

**9 Pierce-pressure mode (off)**

Touch this symbol to put the pump in pierce-pressure mode.

**10 Cut-pressure mode (on)**

Touch this symbol to put the pump in cut-pressure mode.



Cut-pressure mode is active in this image.

Refer to [page 47](#) for information about pressure modes.

**11 Target water pressure**

**12 Output water pressure**

This shows the actual water pressure when the pump is operating.

This is the target water pressure set by the user. [Set the target water pressure](#) on page 47.

**Intensifier status indicator and stroke-rate bars**

The stroke-rate bars show the speed of the piston moving to each side of the intensifier.

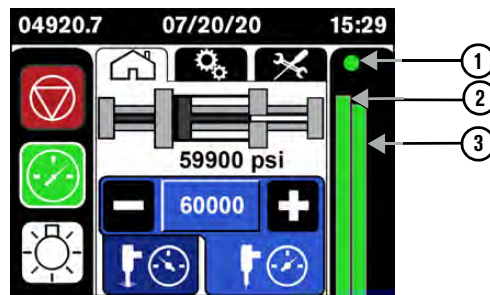

**1 Intensifier status indicator**

- Enabled (green)
- Not enabled (red)

**2 Intensifier stroke rate to the left**

**3 Intensifier stroke rate to the right**

- The stroke rate is within the permitted range (green).
- The stroke rate is at the limit of the permitted range (yellow).
- The intensifier is overstroking (red).

Refer to [page 113](#) for more information.

## Turn on the pump: beginning of day

Follow this procedure when starting the pump for the first time each day or at the beginning of each work shift. Daily preventive maintenance tasks are included in these instructions.

### Prepare the pump



Unless otherwise recommended, install the top cover and the front panel before operating the pump.

1. Remove the top cover.

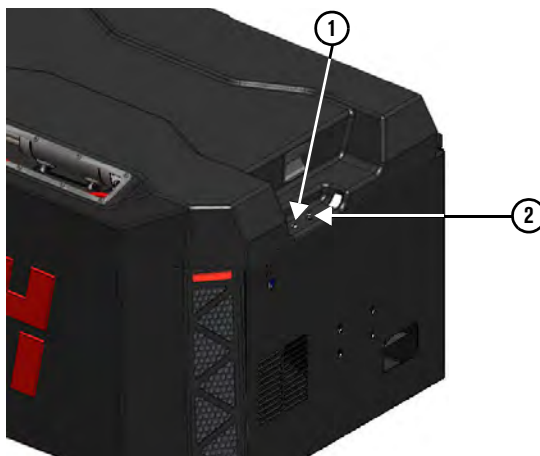

- a. Use a standard screwdriver to turn the bolt ① on each end counterclockwise 1/4 turn.
- b. Lift the cover off of the alignment pins ②.

2. Remove the front panel.

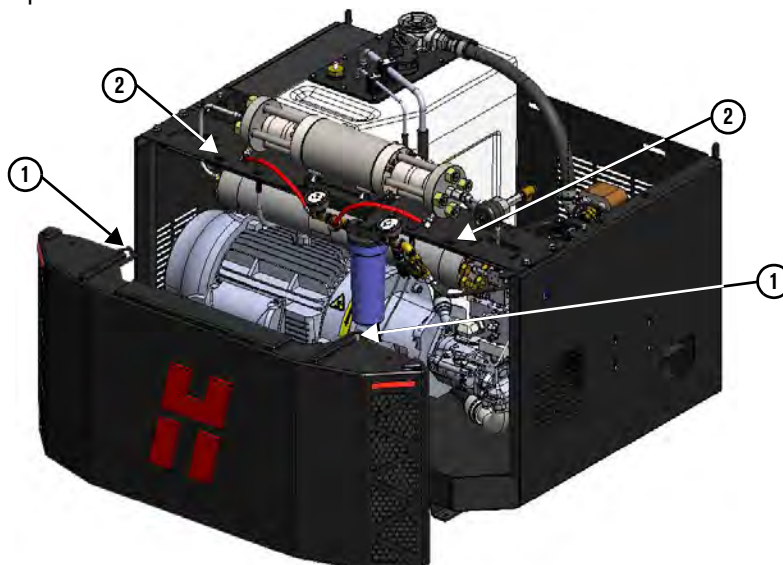

Push down on the horizontal surface on top of the panel ① to release the retainers tabs from the frame ②.

## 2 Operation

3. Clean all debris, water, and hydraulic fluid off of the hydraulic fluid tank ①, the intensifier bridge ②, and the bottom deck ④.

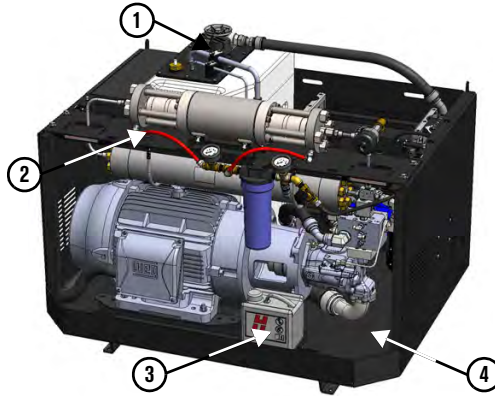

4. Empty the dirty water container ③, if necessary.



Refer to local regulations regarding waste water. Environmental rules can apply to disposal.

5. Clean the operator interface, if necessary.



To prevent damage to the operator interface:

- do not use cleaners that contain alcohol, ammonia, acetone, phosphates, or ethylene glycol.
- do not push hard on the touchscreen.
- do not use paper towels, abrasive cloth, or dirty rags.
- do not put liquid directly onto the touchscreen.

- Gently wipe the touchscreen and keys with a clean microfiber cloth.
- Use a cleaner made for touchscreens or use a 1:1 solution of distilled water and white vinegar.

6. Examine electrical cords and cables for kinks or damage to the insulation. Examine electrical plugs and other electrical connections for corrosion or damage.
7. Look for leaks, deterioration, damage, or other conditions that can interfere with operation.
8. Make sure that all connections, fasteners, locking devices, hoses, and fittings are tight.
9. Make sure that all warning decals are visible and legible.  
Contact Hypertherm for replacement decals.



## Examine the hydraulic fluid

Replace the hydraulic fluid:

- every 3,000 hours.
- if it is dark or milky in color.
- if it has a strong odor.
- if a test laboratory finds the quality is unsatisfactory.

Refer to [Replace the hydraulic fluid](#) on page 86.

### CAUTION



Heat and other conditions cause hydraulic fluid to degrade. Degraded hydraulic fluid can cause damage to hydraulic components.

Collect a sample of hydraulic fluid from the hydraulic fluid tank and send it to a test laboratory for analysis.

Refer to [Hydraulic fluid](#) on page 136 for recommended limits.



Contact a hydraulic fluid supplier for a precise report about your hydraulic fluid quality.

### Do this task when the pump is not operating.

1. Look through the sight gauge to see the color of the hydraulic fluid. Good hydraulic fluid is almost transparent.

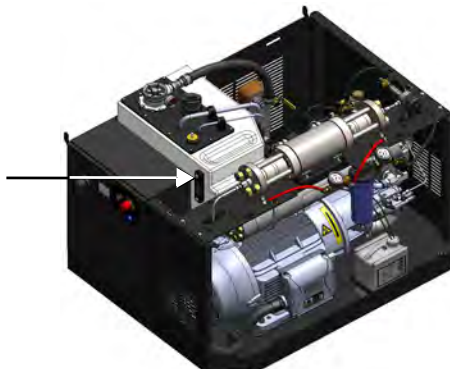

2. Remove the filler cap.
3. Smell the hydraulic fluid. Good hydraulic fluid has almost no odor.
4. Install the filler cap.

### Turn on the utilities

1. Turn **ON** the water to the pump.
2. Turn **ON** the compressed air source.
3. Turn **ON** the electrical main (line disconnect switch).
4. Turn the primary breaker disconnect lever on the electrical enclosure door to **ON**.



### Turn on the controls

#### Turn on the controls remotely



Refer to the OEM's instructions for starting the pump and for operating the pump from a remote source.

1. Make sure that the EMERGENCY STOP ① is not engaged. If the button is pushed in, turn the button clockwise until it releases.
2. Make sure that the key switch ② is set to Local .
3. Push the Controls button ③ to turn **ON** the control circuit in the pump.
4. Turn the key switch ② to Remote . The remote indicator light is on ④.

### Turn on the controls locally

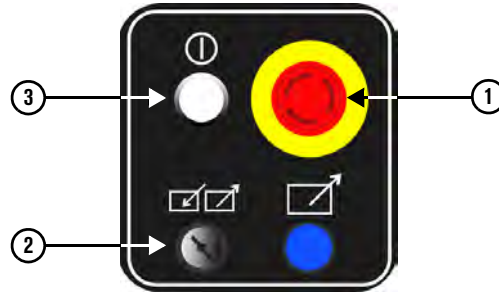

1. Make sure that the EMERGENCY STOP ① is not engaged. If the button is pushed in, turn the button clockwise until it releases.
2. Make sure that the key switch ② is set to Local .
3. Push the Controls button ③ to turn **ON** the control circuit in the pump.

### Start the pump

**CAUTION**



Use the [Postmaintenance start procedure](#) on page 91 if maintenance or repairs have been done on:

- the high-pressure water system.
- intensifier components.
- the primary motor.

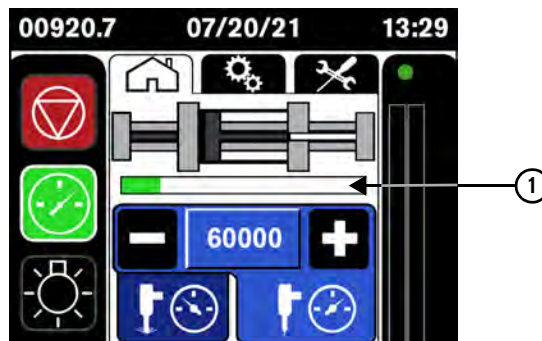

1. On the operator interface, touch the  symbol to turn **ON** the pump.
  - The controller starts the pump.
  - A progress bar ① shows below the intensifier on the screen.

The normal start sequence is fully automated. Refer to [Primary operation screen](#) on page 177 for a description of the sequence.

Monitor for leaks.

2. When the start sequence is complete, complete the **Daily** preventive maintenance tasks. Refer to the [Preventive maintenance schedule](#) on page 58.

## Do the preoperation maintenance inspections

### Examine the pump for leaks or damage

**Do this task when the pump is operating and the system is pressurized.**

1. Look for hydraulic fluid leaks. Monitor these areas.
  - Hydraulic connections
  - Valves
  - Intensifier bridge and bottom deck
2. Examine the low-pressure tubes and the hoses for leaks.
3. Examine the bleed-down valve for leaks or damage.



A hot bleed-down valve can suggest that there is a leak.

4. Examine the weep holes in the high-pressure ends for leaks. Water leaking from a weep hole is a sign of a faulty part or a loose connection.

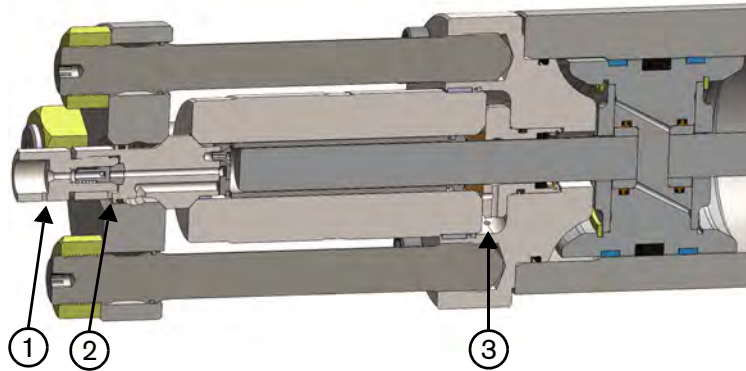

- |  |   |
|--|---|
| <ol style="list-style-type: none"> <li>1 Output adapter leak</li> <li>2 High-pressure seat leak</li> </ol> | <ol style="list-style-type: none"> <li>3 Dynamic seal leak</li> </ol> |
|--|---|

5. Examine the high-pressure tubing for leaks.
6. Look for deterioration, damage, or other problems.

## Check the hydraulic fluid level

**Do this task when the pump is operating.**

Make sure that the hydraulic fluid level is at the top mark on the sight gauge.

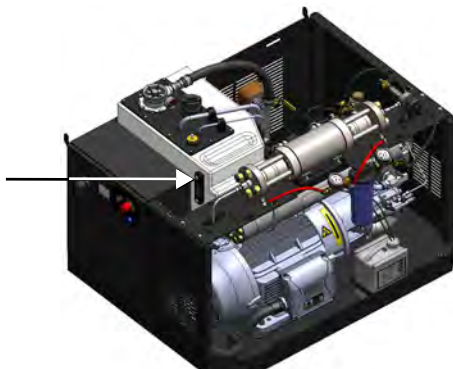

Add hydraulic fluid, if necessary. Refer to [Add hydraulic fluid](#) on page 85 for instructions.

## Check the hydraulic filter gauge

Replace the hydraulic filter element:

- every 1,500 hours.
- when the needle on the gauge stays in the red zone while the pump is operating.

Refer to [Replace the hydraulic filter element](#) on page 84.

**Do this task when the pump is operating at a stable temperature.**



Make sure that the needle on the hydraulic gauge is not in the red zone.

## Check the low-pressure water pressure gauges

Replace the water filter:

- every 1,000 hours.
- if the difference between the values is more than 0.7 bar (70 kPa / 10 psi).

Refer to [Replace the water filter](#) on page 80.

The prefilter water-pressure gauge shows the water pressure before the water goes through the filter. The postfilter water-pressure gauge shows the water pressure after the water goes through the filter.

The usual range is 2.8 bar to 7.6 bar (280 kPa to 760 kPa / 40 psi to 110 psi).

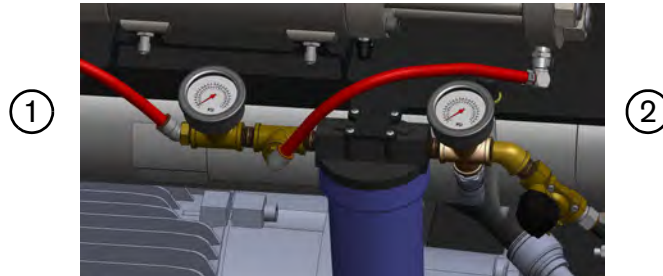

1 Postfilter water-pressure gauge

2 Prefilter water-pressure gauge

### Do this task when the pump is operating.

Subtract the value shown on the postfilter water pressure from the value shown on the prefilter water pressure.

If the difference between the values is more than 0.7 bar (70 kPa / 10 psi), replace the water filter.

### Make sure that the emergency stop operates correctly

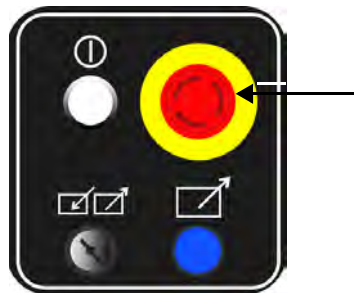

### Do this task when the pump is operating.

On the operation panel, push the EMERGENCY STOP button. Refer to [Emergency stop](#) on page 49.

## Operate the pump

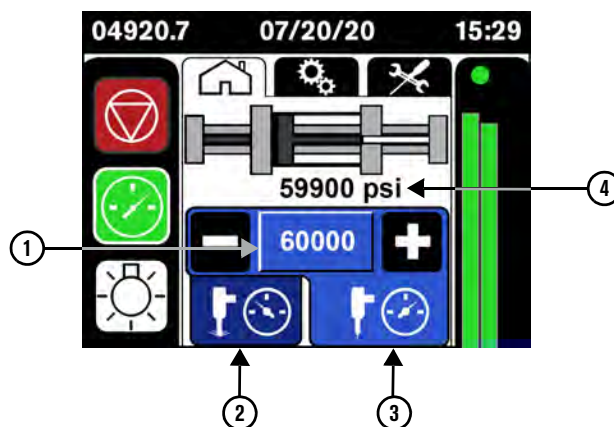

### 1 Target water pressure

Touch this to set the target water pressure.

### 2 Pierce-pressure mode (off)

Touch this symbol to put the pump in pierce-pressure mode.

### 3 Cut-pressure mode (on)

Touch this symbol to put the pump in cut-pressure mode.

### 4 Output water pressure

This shows the actual water pressure when the pump is operating.

## Select the pressure mode

Cut-pressure mode ③ is used for most cutting jobs.



Pierce-pressure mode (low-pressure mode) ② is applicable for:

- making a hole in the material to be cut.
- decreasing the risk of cracking when cutting brittle materials, such as glass or ceramic.
- preventing composite materials like carbon fiber from delaminating.

Pierce pressure is typically less than or equal to 1,380 bar (138,000 kPa / 20,000 psi).

## Set the target water pressure

There are 2 ways to change the target water pressure on the operator interface.

- Touch the  symbol or the  symbol to change the target water pressure in preset increments.





To change the increments, refer to [Pressure Adjustments](#) on page 167.

- Touch the target water pressure button ① to open a numeric keypad. Type the number and then touch **Enter**.

## Stop the pump

### Stop the pump remotely

	<p>You can stop the pump from the operator interface while using remote controls. On the operator interface, touch the  symbol to stop the pump.</p> <p>Refer to <a href="#">Stop the pump</a> on page 48.</p>
	<p>Refer to <a href="#">Emergency stop</a> on page 49 for information about the EMERGENCY STOP button.</p>

Refer to the OEM's instructions for turning the pump off.

### Stop the pump locally

Use this procedure during normal operation.

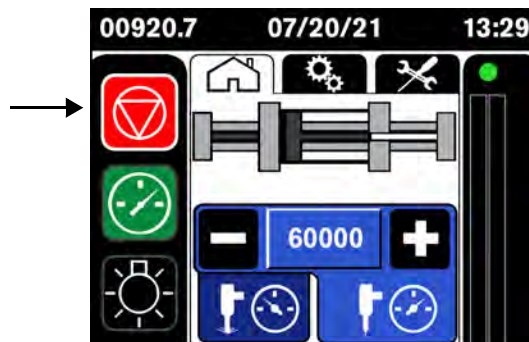

On the operator interface, touch the  symbol.

- The pump, the primary motor, and the intensifier turn off.
- The bleed-down valve opens to release high-pressure water from the system.
- The supply-water valve closes to stop low-pressure water from entering the system.
- No output water pressure shows.
- The control circuit stays on.



## Emergency stop

**WARNING**

The EMERGENCY STOP button does not disconnect main electrical power from the machine.

Use the emergency stop to stop the controls immediately to prevent injury or to reduce the risk of injury to personnel, machinery, or work in progress. **This is not the preferred method of turning off the pump.**

On the operation panel, push the EMERGENCY STOP button.

- The control circuit turns off, which turns off the pump, the primary motor, and the intensifier.
- Remote controls that are wired to the pump controller turn off.
- The bleed-down valve opens to release high-pressure water from the system.
- The supply-water valve closes to stop low-pressure water from entering the system.



The EMERGENCY STOP button must be reset before the equipment can be turned on. Turn the button clockwise until it releases.

## Turn off the pump: end of day

Do this procedure at the end of the day.

1. On the operator interface, touch the  symbol to stop the pump.
2. Turn the primary breaker disconnect lever on the electrical enclosure door to **OFF**.



3. Turn **OFF** the utility water to the pump. Make sure that the water pressure gauges show 0.0 bar (0 kPa / 0 psi).
4. Turn **OFF** the compressed air source.
5. Turn **OFF** the electrical main (line disconnect switch). Use standard lock out–tag out procedures.
6. Remove the top cover and the front panel.
7. Clean all debris, water, and hydraulic fluid off of the hydraulic fluid tank ①, the intensifier bridge ②, and the bottom deck ④.

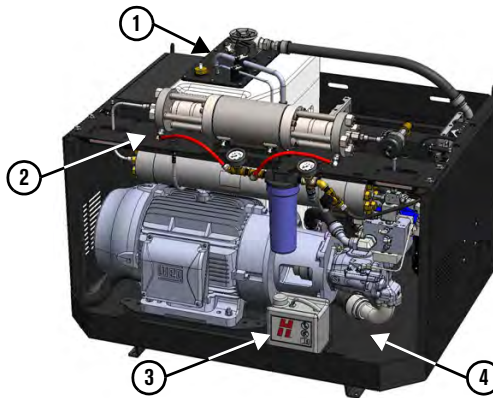



8. Empty the dirty water container ③, if necessary.













Refer to local regulations regarding waste water. Environmental rules can apply to disposal.

# 3

## ***Preventive maintenance***

	This section assumes that the user is familiar with the <a href="#">Safety</a> , <a href="#">Operation</a> , <a href="#">Troubleshooting</a> , and <a href="#">Specifications</a> sections of this manual.
	Images in this manual are for reference purposes. It is possible that your product configuration is not shown accurately.
	It is possible that not all of the information in this section applies to all pump models.

# Safety

<p><b>WARNING</b></p> 	<p><b>Read and understand all of the safety guidelines in this manual.</b></p> <p>Before operating, doing maintenance on, repairing, and installing your pump, read the <a href="#">Safety</a> section, which starts on <a href="#">page 21</a>.</p>
<p><b>CAUTION</b></p> 	<p>Do not tighten a fitting too much. The fitting can fail.</p>
<p><b>CAUTION</b></p> 	<p>Hydraulic, water, and electrical connections can become loose during shipping and normal operation. Examine all connections at installation and during regular maintenance.</p>
<p><b>CAUTION</b></p> 	<p>When replacing wiring, use only the same size, type, and color as the original wiring.</p>
<p><b>CAUTION</b></p> 	<p>Before assembling high-pressure or hydraulic parts, clean the parts to remove grease and other contamination.</p>
	<p>Clean and examine parts that will be replaced to identify wear patterns or damage that can show other problems.</p>
	<p>Clean each part with a towel and isopropyl alcohol. Examine all parts for deterioration, corrosion, or damage.</p> <p>Do not use soap, detergent, or solvents.</p>
	<p>Keep the work area clean and dry. Clean fluid spills immediately.</p> <p>Use a pan or a tray below areas where water or hydraulic fluid can spill during maintenance or repair procedures.</p>
	<p>Obey local protocols for recycling or disposal of parts, materials, and fluids.</p> <p>National and local environmental rules can apply to disposal.</p> <p>Refer to <a href="#">Recycling and end of product life</a> on page 96.</p>
	<p>Keep accurate maintenance records. Records can help with predicting and preventing maintenance problems.</p>
	<p>Keep spare parts and repair kits available.</p>

## Benefits of preventive maintenance

---

Hypertherm recommends preventive and scheduled maintenance for Echion pumps. High-quality equipment that is maintained on a schedule lasts longer than equipment that is not maintained regularly. This maintenance includes adjustments, cleaning, lubrication, repairs, and replacement of parts.

- Improves reliability
- Finds possible problems before they cause unplanned downtime and become expensive repairs
- Extends the life of equipment and decreases the frequency of replacement
- Contributes positively to reputation and profits
- Gives traceability through records

## Training

---

The employer must provide training for maintenance procedures. Retrain personnel when:

- there is a change in job assignment, machinery, or procedures that can present a new danger.
- energy-control procedures change.
- there is reason to believe there is a deficiency in a person's knowledge of the energy-control procedure.

## Operator interface: Maintenance screens



Refer to [Touchscreen maps](#) on page 175 to see all of the screens available on the controller.

On the operator interface, touch the maintenance tab to open the primary maintenance screen.

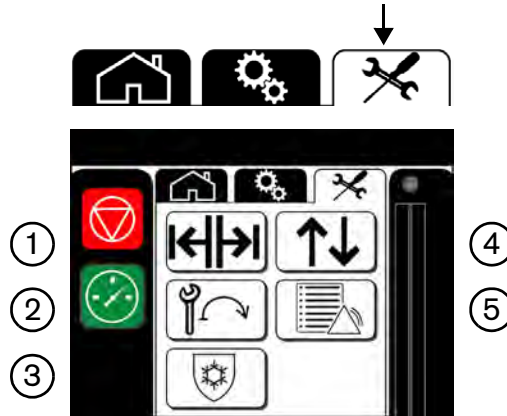

- |                                    |                      |
|------------------------------------|----------------------|
| 1 Move the plunger                 | 4 Inputs and outputs |
| 2 Start the pump after maintenance | 5 Alarm log          |
| 3 Prepare for storage              |                      |

### Move the plunger



Touch this symbol to open the **Move the Plunger** screen.

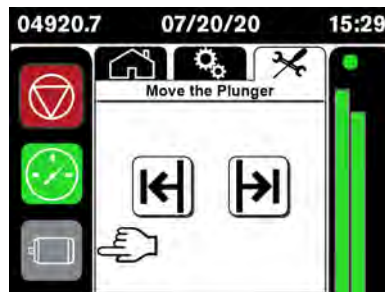

Refer to [Move the plunger](#) on page 54 for instructions.

## Start the pump after maintenance



Touch this symbol to open the **Start Procedure** screen.

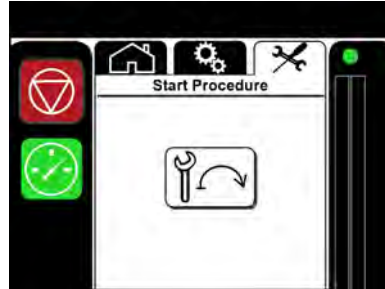

Refer to [Postmaintenance start procedure](#) on page 91 for more information.

## Prepare for storage



Touch this symbol to open the **Prepare for Storage** screen.



Refer to [Prepare for storage](#) on page 93 for more information.

## Inputs and outputs



The inputs and outputs screen is useful for troubleshooting. Touch this symbol to open a screen that shows inputs and outputs for the controller.

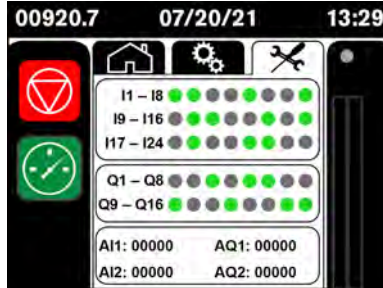

Refer to [Input/output status](#) on page 134 for more information.

## Alarm log



The alarm log is useful for troubleshooting. Touch this symbol to open the Alarm Log screen.

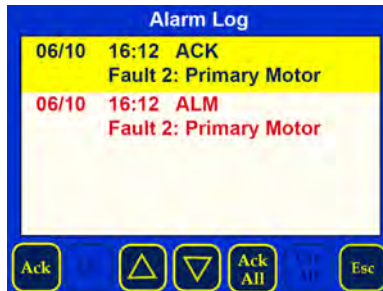

Refer to [Alarms](#) on page 114 for more information.



## Tools

	Use the correct tools for maintenance procedures. Some tools are designed to make the procedure easier and to prevent damage to the equipment.
	Personnel who maintain and repair this equipment must know how to use standard hand tools.
	Use SAE (US standard) tools for most procedures.

Special tools are recommended or necessary for some maintenance and repair procedures.

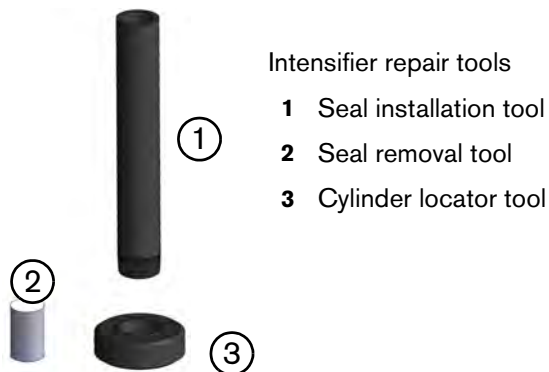
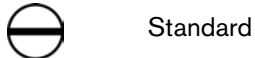

## Preventive maintenance schedule

These maintenance intervals are recommended guidelines. Find the procedures on the page numbers listed in the Hours columns.

Task	Hours							
	Daily	500	1,000	1,500	2,000	3,000	6,000	12,000
<b>Before starting the pump</b>								
<ul style="list-style-type: none"> <li>Clean and examine the pump.</li> </ul>	39							
<ul style="list-style-type: none"> <li>Examine the hydraulic fluid.</li> </ul>	41							
<b>After starting the pump</b>								
<ul style="list-style-type: none"> <li>Examine the pump for leaks or damage.</li> </ul>	44							
<ul style="list-style-type: none"> <li>Check the hydraulic fluid level.</li> </ul>	45							
<ul style="list-style-type: none"> <li>Check the hydraulic filter gauge.</li> </ul>	45							
<ul style="list-style-type: none"> <li>Check the low-pressure water pressure gauges.</li> </ul>	46							
<ul style="list-style-type: none"> <li>Make sure that the emergency stop operates correctly.</li> </ul>	46							
<b>Intensifier</b>								
<ul style="list-style-type: none"> <li>Repair the high-pressure cylinders, the check valves, and the low-pressure poppets.</li> </ul>		66						
<ul style="list-style-type: none"> <li>Replace the high-pressure seal cartridges.</li> </ul>		69						
<b>Intensifier</b>								
<ul style="list-style-type: none"> <li>Replace the high-pressure poppet assemblies.</li> </ul>			69					
<ul style="list-style-type: none"> <li>Replace the low-pressure poppets and seats.</li> </ul>			74					
<b>Low-pressure water system</b>								
<ul style="list-style-type: none"> <li>Clean the air cooler.</li> </ul>			78					
<b>Bleed-down valve</b>								
<ul style="list-style-type: none"> <li>Repair the bleed-down valve.</li> </ul>			75					
<b>Low-pressure water system</b>								
<ul style="list-style-type: none"> <li>Replace the water filter.</li> </ul>			80					
<ul style="list-style-type: none"> <li>Test the low-pressure water TDS level.</li> </ul>			81					
<b>Hydraulic system</b>								
<ul style="list-style-type: none"> <li>Replace the hydraulic filter element.</li> </ul>				84				
<b>Intensifier</b>								
<ul style="list-style-type: none"> <li>Flip the high-pressure cylinder.</li> </ul>				66				
<b>Intensifier</b>								
<ul style="list-style-type: none"> <li>Replace the plungers and T-seals.</li> </ul>					69			

Task	Hours							
	Daily	500	1,000	1,500	2,000	3,000	6,000	12,000
<b>Intensifier</b> <ul style="list-style-type: none"> <li>Replace the high-pressure cylinders and the check valve assemblies.</li> </ul>						66		
<b>Bleed-down valve</b> <ul style="list-style-type: none"> <li>Replace the bleed-down valve body.</li> </ul>						75		
<b>Hydraulic system</b> <ul style="list-style-type: none"> <li>Replace the hydraulic fluid.</li> </ul>						86		
<b>Intensifier</b> <ul style="list-style-type: none"> <li>Replace the output adapters.</li> <li>Replace the seal housing assemblies.</li> </ul>						73	60	
<b>Motor</b> <ul style="list-style-type: none"> <li>Lubricate the primary motor bearings.</li> </ul>							88	
<b>Intensifier</b> <ul style="list-style-type: none"> <li>Replace the spacer tubes.</li> <li>Repair the hydraulic center section.</li> </ul>								60
								64

# Intensifier maintenance

**Every 500 hours**

- Repair the check valves and the low-pressure poppets.
- Repair the high-pressure cylinders.
- Replace the high-pressure seal cartridges.

**Every 1,000 hours**

- Replace the high-pressure poppet assemblies.
- Replace the low-pressure poppets and seats.

**Every 1,500 hours**

- Flip the high-pressure cylinders.

**Every 2,000 hours**

- Replace the plungers and T-seals.

**Every 3,000 hours**

- Replace the high-pressure cylinders.
- Replace the check-valve assemblies.





**Every 6,000 hours**

- Replace the output adapters.
- Replace the seal housing assemblies.

**Every 12,000 hours**

- Replace the spacer tubes.
- Repair the hydraulic center section.

Preventive maintenance

<p><b>CAUTION</b></p> 	<p>To prevent causing damage or premature failure, use 2 wrenches when loosening or tightening a high-pressure connection.</p> <p>Always tighten fittings to the specified torque value.</p>
<p><b>CAUTION</b></p> 	<p>Do not use an adjustable wrench on high-pressure fittings.</p>
	<p>Use clean hands when changing high-pressure parts.</p>
	<p>To reduce downtime, Hypertherm recommends doing preventive maintenance on both ends of the intensifier at the same time.</p>

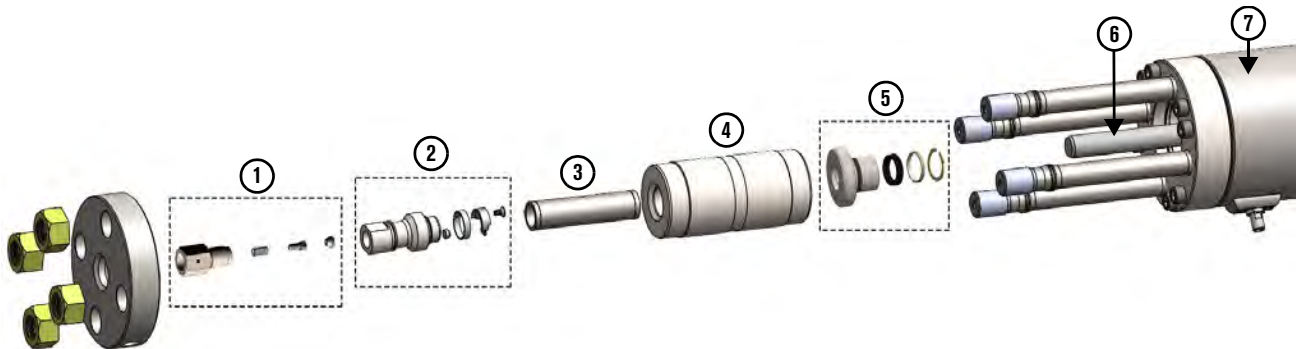

- 1 Output adapter and high-pressure poppet assembly
- 2 Check-valve assembly
- 3 Spacer tube

- 4 High-pressure cylinder
- 5 Seal housing assembly
- 6 Plunger
- 7 Hydraulic center section

## Parts, tools, and materials

Intensifier repair tools

1-18770 Echion high-pressure seal repair kit

1-18771 Echion high-pressure poppet repair kit

1-18849 Echion low-pressure poppet repair kit

1-18768 Standard tool kit

13/16-inch open-ended wrench or socket

1-inch open-ended wrench

1-1/16-inch open-ended wrench

1-inch socket

Torque wrench

Rubber mallet

2 O-ring picks (or similar tool)

2 standard screwdrivers

Large snap-ring pliers

Small snap-ring pliers

Isopropyl alcohol

Antiwear (AW) mineral oil or synthetic hydraulic fluid, ISO viscosity grade (VG) 32 or 46

Clean towels

Nonstick scouring pad

Masking tape

### Recommended materials

Bench vise



Refer to [Intensifier high-pressure ends](#) on page 107 for individual replacement parts.

### Do this task when the pump is not operating.

1. On the operator interface, touch the maintenance symbol to open the primary maintenance screen.



2. Touch this symbol to open the **Move the Plunger** screen.



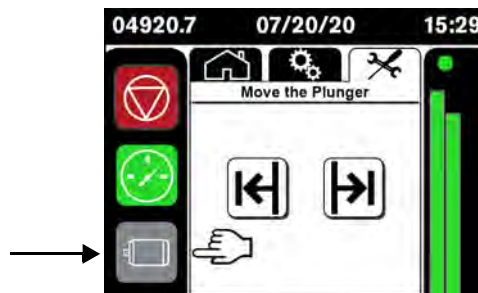

3. Touch the motor symbol to start the motor.

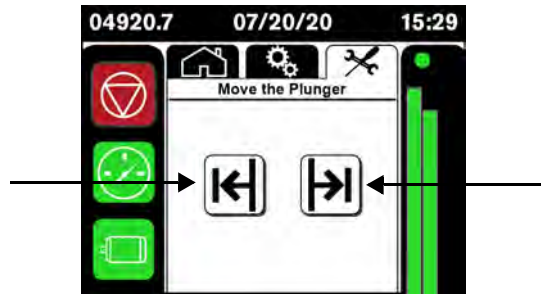

### 3 Preventive maintenance

4. Touch a symbol to move the intensifier plunger to the end you will be working on.



5. On the operator interface, touch the  symbol to stop the pump.
6. Turn the primary breaker disconnect lever on the electrical enclosure door to **OFF**.
7. Turn **OFF** the utility water to the pump. Make sure that the water pressure gauges show 0.0 bar (0 kPa / 0 psi).
8. Turn **OFF** the compressed air source.
9. Turn **OFF** the electrical main (line disconnect switch). Use standard lock out–tag out procedures.
10. Use a 13/16-inch open-ended wrench to disconnect the high-pressure tubing from the intensifier.
11. Remove the bleed-down valve. Refer to [step 5](#) through [step 10](#) on page 76.
12. Push the button on the quick-disconnect fitting to remove the low-pressure water line from the intensifier.

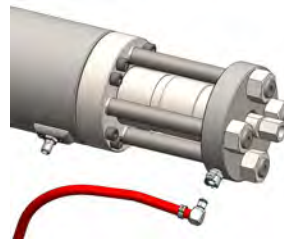

It is possible that some water will spray from the connection when this tubing is disconnected.

13. Use the breaker bar and the 1-1/2-inch 12-point socket to remove the endcap nuts. Use a repeating cross pattern.



14. Remove the end cap.



Hydraulic fluid and water will leak during this procedure. Put towels on the intensifier bridge under the work area.

15. Pull out the check valve.
16. Pull the high-pressure cylinder off of the plunger.



Make sure that the spacer tube does not fall out. Dropping the spacer tube can cause damage to it.

17. Put the cylinder locator tool and the seal installation tool together.



18. Put the tool on the seal housing and turn it clockwise so that the threads engage. Pull the seal housing assembly off of the plunger.



A small amount of hydraulic fluid could leak from the hydraulic cylinder. This is normal.

### STOP

If you are not replacing the plunger and the T-seals or repairing the hydraulic center section, go to [Examine the output adapter and the high-pressure poppet assembly](#) on page 73.

## Replace the plunger and the T-seal

- Replace the plungers and T-seals every 2,000 hours.
- Repair the hydraulic center section every 12,000 hours.

The hydraulic center section includes the piston, the hydraulic cylinder, the hydraulic end caps, the low-pressure seals, and the proximity switches.

Preventive maintenance on these parts requires special tools. Contact a Hypertherm Technical Service Associate for information and support regarding the installation, operation, maintenance, and repair of this equipment.

1. Remove the 1/4-inch leak tube from the hydraulic end cap. The leak tube goes to the dirty water container.
2. Use a 3/8-inch hex-head socket to loosen the bolts on the hydraulic end cap. Use a repeating cross pattern.



3. Remove the hydraulic end cap.



Hydraulic fluid could leak from the hydraulic cylinder. This is normal.



If the end cap does not come off easily, use two standard screwdrivers to pry the end cap loose.

4. Use large snap-ring pliers to remove the plunger retainer snap ring from the piston.
5. Pull the plunger out of the piston.
6. Use 2 O-ring picks to remove the T-seal and the T-seal retaining rings. Dispose of the used parts.
7. Lubricate the new T-seal with hydraulic fluid.
8. Install the T-seal in the groove.
9. Install the first T-seal retaining ring. The raised lettering on the ring should face the center of the intensifier.



Make sure that the angled ends of the T-seal retaining ring butt up against each other and do not overlap.



10. Install the other T-seal retaining ring.



11. Install the retainer on the plunger.
12. Put hydraulic fluid on the plunger head. Push the plunger into the piston until it is flush with the recess.
13. Push the retainer into place. Orientation does not matter.
14. Install the snap ring. Make sure that the ring is fully seated.

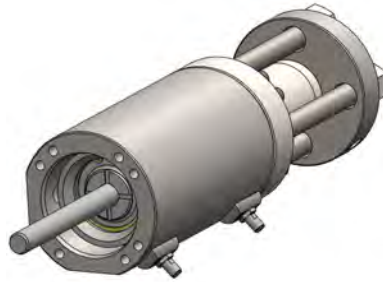

15. Examine the O-ring on the outside of the hydraulic end cap. Lubricate the O-ring with high-vacuum grease.
16. Install the end cap. Lubricate the bolt threads with antiseize bolt lubricant (white lithium grease).
17. Use a 3/8-inch hex-head socket and a torque wrench to tighten the hydraulic end cap bolts to 70 N·m (50 lbf·ft). Then tighten the nuts to 90 N·m (65 lbf·ft). Use a repeating cross pattern.

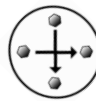

## Repair the high-pressure cylinder, the check valve, and the low-pressure poppet

- Repair the high-pressure cylinders every 500 hours.
- Repair the check valves and the low-pressure poppets every 500 hours.
- Replace the high-pressure seal cartridges every 500 hours.
- Replace the low-pressure poppets and seats every 1,000 hours.
- Replace the high-pressure cylinders every 3,000 hours or if the cylinder is chipped or cracked.
- Replace the check-valve assemblies every 3,000 hours.

**CAUTION**



Debris in the cylinder can cause the seals or the poppets to fail.



This procedure is for a moderately worn check valve. Replace very worn components.

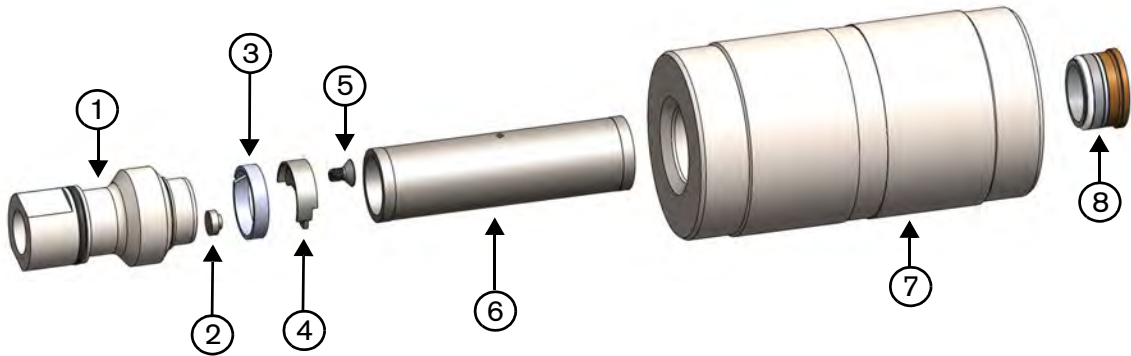

- 1 Check-valve body
- 2 Low-pressure poppet
- 3 Check-valve wear ring
- 4 Poppet retainer

- 5 Low-pressure poppet screw
- 6 Spacer tube
- 7 High-pressure cylinder
- 8 High-pressure seal cartridge

1. Disassemble and examine the cylinder and the check valve.
2. Disassemble the cylinder locator tool and the seal installation tool.



3. Put the high-pressure cylinder on the seal locator tool. Make sure that the spacer tube is inside the cylinder.

4. Put the end of the push tool against the spacer tube inside the cylinder.



5. Tap on the end of the push tool with a rubber mallet to push the bottom seal and the hoop out of the high-pressure cylinder.
6. Take the spacer tube out of the cylinder.
7. Disassemble all of the parts.
8. Examine the cylinder. If the area around the bore is marked or pitted or has rough edges or burrs, remove the defects with a nonstick scouring pad.
9. Cut a nonstick pad in half. Put half of the pad in the end of the cylinder. Put 1 thumb in each end of the cylinder and push down evenly on the pad while rolling the cylinder back and forth.

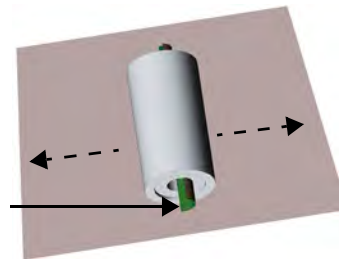



Nonstick scouring pad

10. Clean the inner surfaces of the cylinder with a towel and isopropyl alcohol.
11. Use a 1/8-inch hex wrench to remove the low-pressure poppet screw from the check valve.



12. Tape a sheet of lapping paper on a granite lapping block. Make sure that the paper is smooth and flat.

- Put the check-valve face or the low-pressure poppet face flat on the lapping paper and move it back and forth. Use light pressure. Do this procedure until the face is smooth and flat and has a mirrorlike finish.

<b>CAUTION</b> 	Do not rock the parts or use too much pressure. Doing so can cause damage to the part faces.
<b>CAUTION</b> 	Keep the low-pressure poppet and the poppet retainer clean. Grease can cause the poppet to stick.
	Do not put grease or lubricant on the check-valve face or in the cylinder bore. These components are designed for dry contact.

## Install the high-pressure components

Replace the seal housing assemblies every 6,000 hours.

### CAUTION



Water can enter the hydraulic system if the weep holes in the dynamic seal backup or the seal housing are blocked. Make sure that there is no debris in the weep holes.

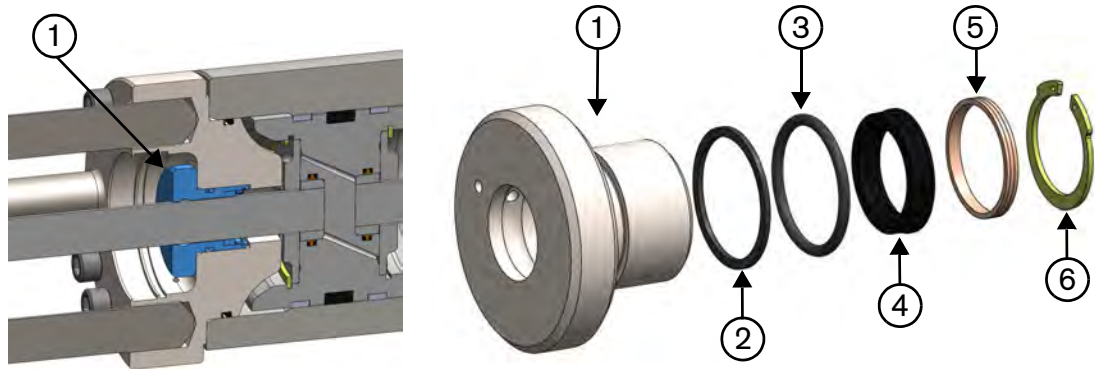

- 1 Seal housing
- 2 O-ring backup
- 3 O-ring

- 4 Energized spring seal
- 5 Rod seal spacer
- 6 Snap ring

1. Use small snap-ring pliers to remove the snap ring from the seal housing.
2. Remove the rod seal spacer.
3. Use an O-ring pick to remove the energized seal spring.
4. Remove the O-ring and the O-ring backup from the seal housing.
5. Clean all surfaces. Examine the seal housing and the high-pressure seal backup. Make sure that the inner grooves are clean.

Make sure that the weep hole is clear. If necessary, use compressed air to blow debris out.

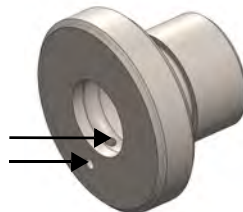

6. Put high-vacuum grease on the backup ring and the seal housing O-ring.

7. Put the seal housing O-ring backup and the seal housing O-ring on the seal housing.

The seal housing O-ring backup ① has a flat side and a concave side. Make sure that the flat side of the O-ring backup faces the wide end of the seal housing. The O-ring ② fits into the concave groove on the O-ring backup.

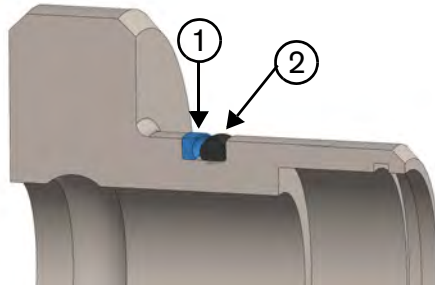

8. Put the new components in the seal housing, as shown.

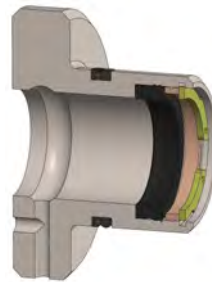

9. Use snap-ring pliers to insert the snap ring. Make sure that the snap ring is seated correctly in the groove.
10. Put the cylinder locator tool and the seal installation tool together.



11. Put the tool on the seal housing and turn it clockwise so that the threads engage.
12. Put the seal housing on the plunger with the narrow end of the seal housing toward the center of the intensifier.



13. Turn the seal housing so that the weep hole faces down.
14. Push the seal housing tightly against the hydraulic end cap. You should feel it click.
15. Remove the tool from the seal housing.

16. Put the cartridge in the seal installation tool.



17. Hold the seal installation tool with both hands and push the cartridge and the tool onto the plunger in a smooth motion. Push until the cartridge is touching the seal housing.

18. Remove the seal installation tool, leaving the cartridge on the plunger.



Part of the cartridge stays inside the seal installation tool. This is by design.

19. Make sure that the cartridge parts are tight and none of the components are hanging down on the plunger.

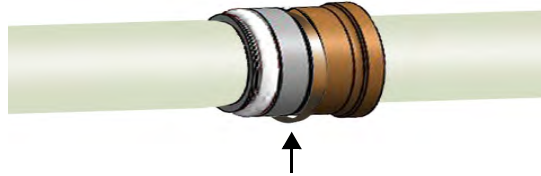

20. Put the spacer tube on the plunger.

21. Find the end of the high-pressure cylinder that was repaired with the nonabrasive pad. Put the high-pressure cylinder over the spacer tube with that end facing the center of the intensifier. Push the cylinder as far as possible.



Turn the high-pressure cylinder around at 1,500 hours to promote even wear.

22. Put the check valve in the end of the high-pressure cylinder. Make sure that the weep hole faces down toward the ground.

23. Put the high-pressure end cap over the check valve and onto the studs. Push the endcap until it is tight against the check valve. Make sure that the low-pressure water connection points toward the attenuator.

24. Use a clean rubber mallet to tap the exposed part of the check valve until the cylinder is fully seated in the end of the hydraulic end cap.

25. Lubricate the stud threads with antiseize bolt lubricant (white lithium grease).

### 3

#### **Preventive maintenance**

- 26.** Put the nuts on the studs by hand. Use a torque wrench to tighten the nuts to 375 N·m (275 lbf·t). Do this in 70 N·m (50 lbf·ft) increments. Use a repeating cross pattern.

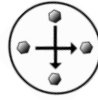



## Examine the output adapter and the high-pressure poppet assembly

- Replace the high-pressure poppet assemblies every 1,000 hours.
- Replace the output adapters every 6,000 hours.

### CAUTION



The high-pressure poppet seat can cause cracks, erosion marks, or dents in the output adapter.



If a poppet part is damaged, replace all 3 components.

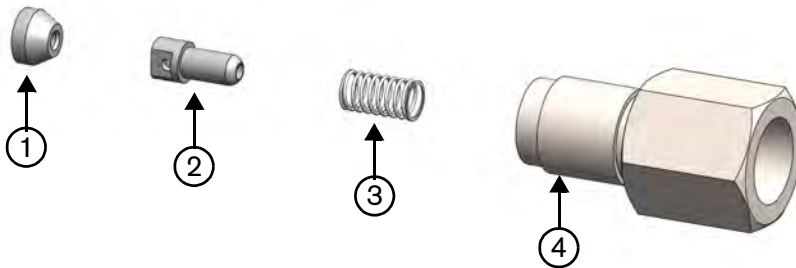

- 1 High-pressure poppet seat
- 2 High-pressure poppet

- 3 High-pressure poppet spring
- 4 Output adapter

Use a cotton-tipped applicator to guide the high-pressure poppet seat out of the check valve.

Tap the output adapter gently on a wooden or other soft surface to eject the poppet from the output adapter.

## Assemble the check valve and the low-pressure poppet

1. Use a cotton-tipped applicator to put high-pressure antiseize lubricant in the recess in the bottom of the check valve.
2. Use a cotton-tipped applicator to guide the high-pressure poppet seat into the check valve. The wide end of the poppet seat faces toward the check valve.
3. Push the high-pressure poppet seat into the high-pressure antiseize lubricant in the check valve.
4. Put high-pressure antiseize lubricant on the threads of the output adapter.
5. Put the high-pressure poppet spring and the high-pressure poppet in the output adapter.
6. Put the output adapter in the check valve and tighten it by hand. Use a torque wrench to tighten the output adapter to 115 N·m (85 lbf·ft).

**CAUTION**



Tightening the output adapter with the high-pressure poppet in an incorrect position can cause damage.

When the output adapter is correctly installed, the gap between the wide part of the output adapter and the check valve is 2.5 mm (3/32 inch) and no threads are visible. If the gap is too large or if threads are visible, make sure that the poppet parts have not moved.



7. Use a torque wrench to tighten the high-pressure water fitting to 70 N·m (50 lbf·ft).
8. Repeat this procedure on the other end of the intensifier.
9. Connect the high-pressure tubing.

**CAUTION**



Make sure that some of the threads on the high-pressure tubing are visible at the fitting. Refer to [High-pressure water fittings](#) on page 144.

10. Connect the low-pressure water lines.

## Repair the bleed-down valve

Repair the bleed-down valve:

- every 1,000 hours.
- if water leaks from the **Waste water out** connection or from the weep holes while the pump is operating.

Replace the bleed-down valve body every 3,000 hours.

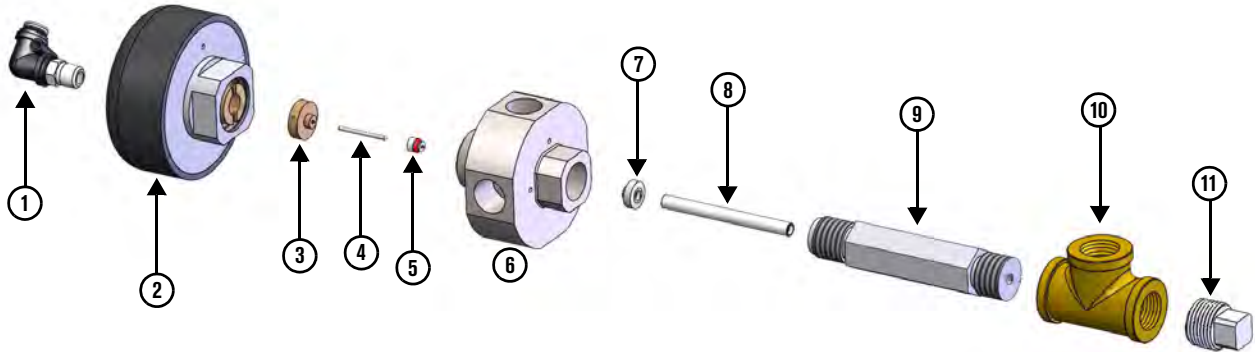

- |                            |                         |
|----------------------------|-------------------------|
| 1 Air fitting              | 7 Bleed-down valve seat |
| 2 Actuator                 | 8 Flow reducer          |
| 3 Needle guide             | 9 Outlet adapter        |
| 4 Needle                   | 10 Tee fitting          |
| 5 High-pressure valve seal | 11 Plug                 |
| 6 Bleed-down valve body    |                         |

### Parts, tools, and materials

- |                                     |                              |
|-------------------------------------|------------------------------|
| 1-17434 Bleed-down valve repair kit | 1-1/8-inch open-ended wrench |
| 1-18311 Bleed-down valve body       | 13/16-inch crowfoot wrench   |
| 3/4-inch open-ended wrench          | Torque wrench                |
| 5/8-inch open-ended wrench          | Clean towels                 |
| 13/16-inch open-ended wrench        | Isopropyl alcohol            |
| 1-inch open-ended wrench            |                              |

### Do this task when the pump is not operating.

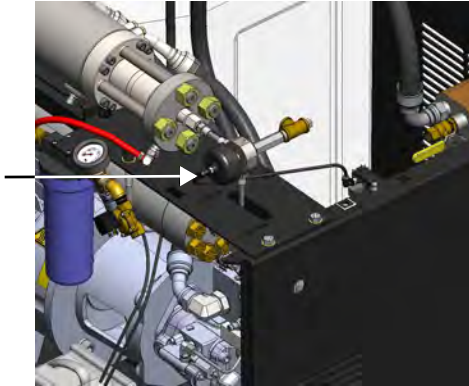

1. Turn the primary breaker disconnect lever on the electrical enclosure door to **OFF**.
2. Turn **OFF** the utility water to the pump. Make sure that the water pressure gauges show 0.0 bar (0 kPa / 0 psi).
3. Turn **OFF** the compressed air source.
4. Turn **OFF** the electrical main (line disconnect switch). Use standard lock out–tag out procedures.

5. Remove the top cover and the front panel. Refer to [Prepare the pump](#) on page 39 for instructions.
6. Disconnect the compressed air hose from the air fitting on top of the actuator.



7. Disconnect the water drain tube from the bleed-down valve.
8. Use 13/16-inch open-ended wrench to loosen the high-pressure fittings attached to the bleed-down valve body.
9. If the pump-mounted plumbing kit is installed on this machine, loosen the high-pressure fitting near the bleed-down valve.
10. Remove the bleed-down valve assembly from the pump.
11. Remove the outlet adapter from the valve body.
12. Remove the seat and the flow reducer from the outlet adapter.
13. Remove the actuator from the valve body.
14. Push a dowel through the bottom of the valve body to remove the seal, the needle guide, and the needle.
15. Put high-pressure antiseize lubricant on the seat.
16. Put the flow reducer into the outlet adapter.
17. Put the seat into the outlet adapter.
18. Install the outlet adapter in the bleed-down valve body. Use a torque wrench to tighten the adapter to 95 N·m (70 lbf·ft).
19. Put the needle through the needle guide and the valve seal. Make sure that the point of the needle faces the seal.
20. Put high-vacuum grease on the red O-ring on the valve seal. Make sure that the red O-ring on the valve seal faces away from the needle.



21. Put the needle-and-seal assembly into the valve body until the needle guide is even with the top of the bore.
22. Install the actuator on the valve body. Tighten the actuator by hand.
23. Use a torque wrench to tighten the high-pressure fittings on the valve body. Refer to [High-pressure water fittings](#) on page 144.
24. Connect the water drain tube to the bleed-down valve.
25. Connect the compressed air hose to the fitting on top of the actuator.
26. Turn **ON** the utility water to the pump.
27. Turn **ON** the compressed air source.
28. Turn **ON** the electrical main (line disconnect switch).
29. Turn the primary breaker disconnect lever on the electrical enclosure door to **ON**.
30. Make sure that the EMERGENCY STOP is not engaged. If the button is pushed in, turn the button clockwise until it releases.
31. Make sure that the key switch is set to Local .
32. Push the Controls button to turn **ON** the control circuit in the pump.
33. On the operator interface, touch the  symbol to turn **ON** the pump.
34. Monitor for leaks.

## Clean the air cooler

Do this task:

- every 1,000 hours.
- if you receive a [Fault 1: Hydraulic Fluid >65C](#) alarm.

**CAUTION**



Detergent can give better cleaning results. Think about the environment when selecting and using cleaning chemicals.

Detergent **must** be compatible with aluminum.

**CAUTION**



Protect the motor and all electronics during the cleaning procedure.



### Parts, tools, and materials

- Compressed air source
- Pressurized-water source or a steam cleaner
- Operation or equivalent oil

### Recommended materials

- Aluminum-compatible detergent
- Ethylene perchlorate detergent
- Oil carbon detergent

### Do this task when the pump is off.

Remove the top cover and the front panel. Refer to [Prepare the pump](#) on page 39 for instructions.

## Clean the air side of the cooler

**CAUTION**



To prevent damage, the stream of water or air must be parallel to the fin.  
Point the water stream against the air direction.

**CAUTION**



Detergent can give better cleaning results. Think about the environment when selecting and using cleaning chemicals.  
Detergent **must** be compatible with aluminum.

1. Refer to the label on the cooler to find the cooler's air direction.
2. Clean oil and grease off of the cooler with compressed air, pressurized water, or a steam cleaner. Direct the cleaning stream against the cooler's air direction.
3. After cleaning, dry the cooler.

## Clean the hydraulic fluid side of the cooler

1. Disassemble the blast oil cooler to find the degree of contamination.

If contamination is moderate, connect the oil side to a closed cleaning system with a pump and a filter.



Ethylene perchlorate detergent can be used. Pump the detergent through the blast oil cooler for 10 minutes.

If contamination is very bad, use an oil carbon detergent. Rinse cleaned surfaces for 30 minutes.

2. Use compressed air to remove remaining detergent.
3. Rinse the blast oil cooler with operation or equivalent oil.

## Replace the water filter

Do this task:

- every 1,000 hours.
- if the difference between the values on the prefilter water-pressure gauge and the postfilter water-pressure gauge is more than 0.7 bar (70 kPa / 10 psi).

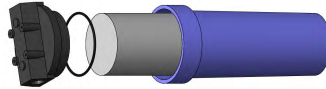



### Parts, tools, and materials

Filter cartridge, water, 1.0 micron, 10-inch  
Filter wrench (included in the standard tool kit)

### Recommended materials

Bucket or pail

### Do this task when the pump is off.

1. Turn **OFF** the water to the pump.
2. Remove the top cover and the front panel. Refer to [Prepare the pump](#) on page 39 for instructions.
3. Use the filter wrench to loosen the filter canister.
4. Remove the used filter cartridge from the filter canister. Discard the used filter.
  -  There is an O-ring in the top of the canister.
5. Pour all of the water and debris out of the canister. Rinse or wipe out the canister, if necessary.
6. Put a new filter cartridge in the canister. The filter does not have a designated top or bottom.
7. Use the filter wrench to install the filter canister.
8. Turn **ON** the water to the pump.
9. Turn **ON** the pump.
10. On the operator interface, touch the  symbol turn **ON** the pump.
11. Make sure that the difference between the values on the prefilter water-pressure gauge and the postfilter water-pressure gauge is less than 0.7 bar (70 kPa / 10 psi).



## Test the total dissolved solids (TDS) level

Do this task every 1,000 hours.

### CAUTION



The meter is not waterproof. Do not submerge the meter in water.



Some TDS meters must be calibrated before use. For best results, calibrate the meter at 25°C (77°F). Refer to the instructions supplied with the TDS meter.

Instructions for testing water quality are found on [page 83](#).

A total dissolved solids (TDS) test measures the total concentration of dissolved substances in postfilter water. Dissolved solids cause deposits that can cause damage to check valves, seals, orifices, and other consumables.



### Parts, tools, and materials

- 1-13897 TDS meter
- Container for a water sample
- Clean, deionized water or filtered water

### Recommended materials

- Bucket or pail

### Do this task when the pump is off.

1. Push the button on a quick-disconnect fitting to remove a low-pressure water line from the intensifier.

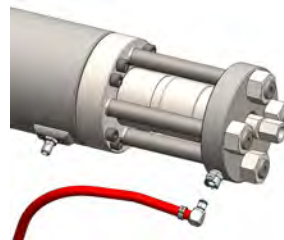

2. Disable the intensifier.
  - a. On the operator interface, touch the adjustments symbol to open the primary adjustments screen.



- b. Touch this symbol to open the **Intensifier Control** screen.



c. Touch the **Intensifier On** box.

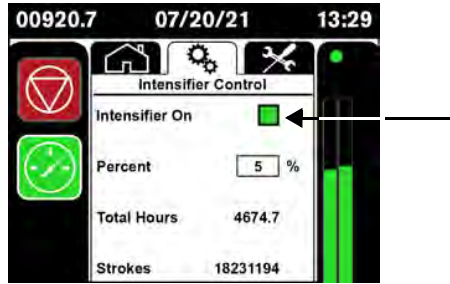

Refer to [Intensifier Control](#) on page 170.

3. Set the target water pressure to 345 bar (5,000 psi). Refer to [Set the target water pressure](#) on page 47 for instructions.
4. Turn **ON** the pump.
5. Take a sample of the water from a low-pressure water line after the water filter. Make sure that the water is clear and odorless.
6. Put the TDS meter in the water sample up to the maximum immersion level (5 cm/2 inches). Tap the meter gently to release air bubbles.



Wait approximately 20 seconds for the reading to become stable.



If multiple readings are taken, turn **OFF** the TDS meter between readings.

7. Compare the reading to the table.

Unsatisfactory	Optimal	Satisfactory	Unsatisfactory
Lower than 0.005% (50 ppm)	0.005% to 0.015% (50 ppm to 150 ppm)	0.015% to 0.022% (150 ppm to 220 ppm)	Higher than 0.022% (220 ppm)
Use nonmetallic or stainless-steel fittings	—	A reverse osmosis system can be used to remove TDS	Use a reverse osmosis system to remove TDS

**CAUTION**



A TDS level that is lower than 0.005% (50 ppm) can harm waterjet parts and requires the use of nonmetallic or stainless steel fittings.  
A TDS value of lower than 0.0005% (5 ppm) can damage stainless steel parts.



Treat water with a TDS level that is higher than 0.015% (150 ppm) with reverse osmosis.

8. Rinse the meter in clean, deionized water or filtered water after use.
9. Connect the low-pressure water line.
10. Go to the **Intensifier Control** screen and enable the intensifier.

## Test the water quality



### Parts, tools, and materials

TDS meter

Container for a water sample

Clean, deionized water or filtered water

pH tester

Silica test kit

Water hardness (calcium carbonate) test kit

### Do this task when the pump is not operating.

1. Take a sample from the **Waste water out** ① hose. If you cannot access the hose, take a sample from the boost pump ② or from the hose going to the inlet water solenoid ③ (for pumps without a boost pump).

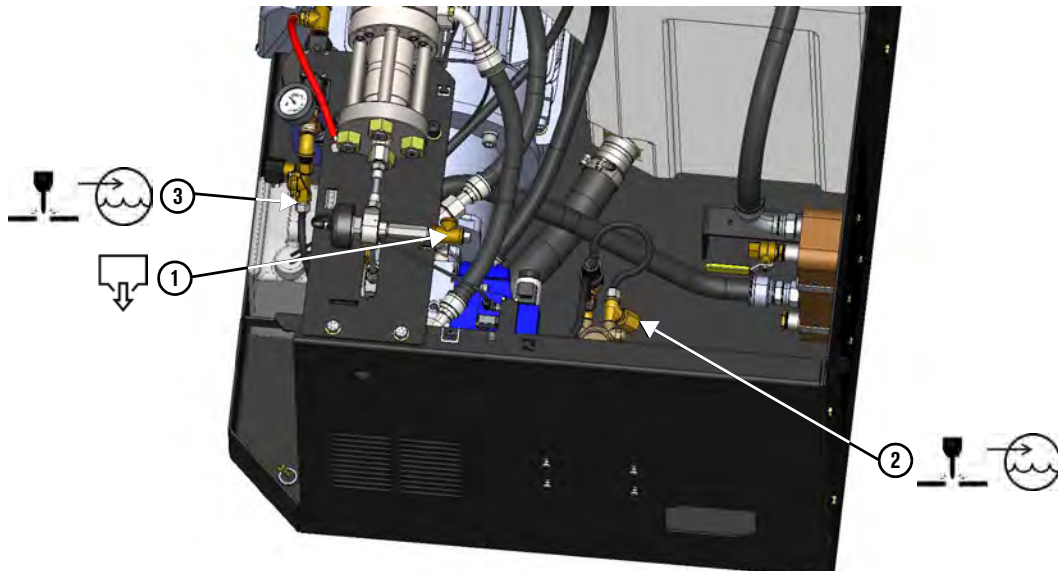

2. Make sure that the water is clear and odorless.
3. Test the pH. The optimal pH measurement is between 6.0 and 8.0.
4. Test the silica ( $\text{SiO}_2$ ) content. The silica content must be lower than 0.0015% (15 parts per million [ppm]).
5. Test the water hardness. The result must be equal to or lower than 0.006% (60 ppm / 3.5 grains per gallon).
6. Test the total dissolved solids (TDS) concentration. The optimal range is 0.005% to 0.015% (50 ppm to 150 ppm). Refer to [Test the total dissolved solids \(TDS\) level](#) on page 81.

## Replace the hydraulic filter element

Do this task:

- every 1,500 hours.
- when the needle on the hydraulic gauge is in the red zone while the pump is at a stable temperature.

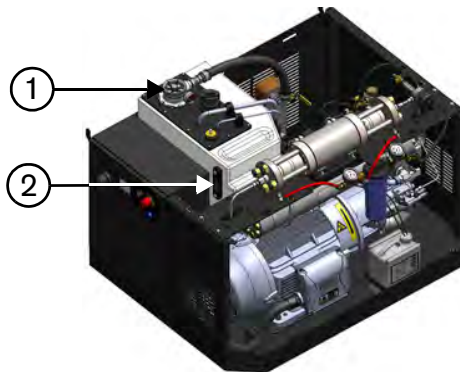

1 Filter head

2 Sight gauge

### Parts, tools, and materials

Hydraulic filter element

Antiwear (AW) mineral oil or synthetic hydraulic fluid, ISO viscosity grade (VG) 32 or 46

Torque wrench

15/16-inch crowfoot wrench or socket

### Recommended materials

Clean funnel

Clean towels

### Do this task when the pump is not operating.

1. Remove the top cover and the front panel. Refer to [Prepare the pump](#) on page 39.
2. Remove the used filter element from the filter head.



Use a 15/16-inch crowfoot wrench or a socket if the filter element is too tight to remove by hand.

3. Put clean hydraulic fluid on the gasket of the new filter element.
4. Twist the filter element into the filter head.
5. Use a torque wrench to tighten the filter to a value between 13.5 N·m (10 lbf·ft) and 16 N·m (12 lbf·ft).
6. Turn **ON** the pump in pierce-pressure mode.
7. Look at the sight gauge to check the hydraulic fluid level. Add hydraulic fluid, if necessary.

## Add hydraulic fluid



Do not put too much hydraulic fluid in the tank.

The capacity of the hydraulic fluid tank is 120 L (32 gallons).



### Parts, tools, and materials

Antiwear (AW) mineral oil or synthetic hydraulic fluid, ISO viscosity grade (VG) 32 or 46

### Recommended materials

Clean funnel

### Do this task when the pump is not operating.

1. Remove the top cover and the front panel. Refer to [Prepare the pump](#) on page 39 for instructions.
2. Remove the filler cap.

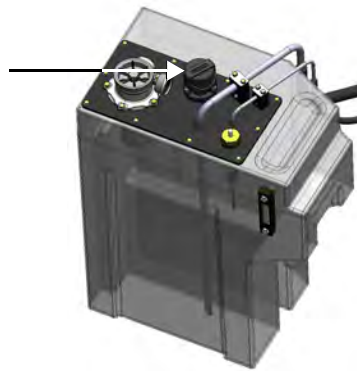

3. Fill the tank with hydraulic fluid until the fluid is at the top mark on the sight gauge.
4. Install the filler cap.

## Replace the hydraulic fluid

Do this task:

- every 3,000 hours.
- if the hydraulic fluid is dark or milky in color or has a strong odor.
- if a test laboratory finds the quality is unsatisfactory.

Refer to [Examine the hydraulic fluid](#) on page 159.



Do not put too much hydraulic fluid in the tank.

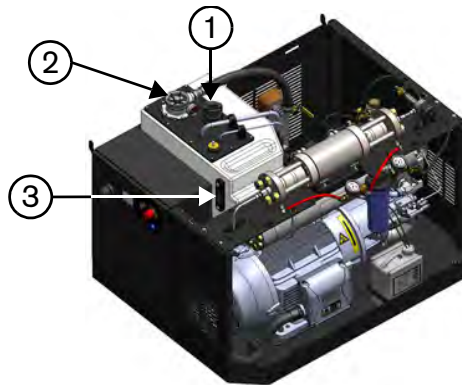

- 1 Filler cap
- 2 Filter head

- 3 Sight gauge



### Parts, tools, and materials

- 1-18772 Hydraulic fluid replacement kit
- Antiwear (AW) mineral oil or synthetic hydraulic fluid, ISO viscosity grade (VG) 32 or 46
- Clean towels
- Siphon or siphon pump
- Torque wrench
- 15/16-inch crowfoot wrench or socket



### Recommended materials

- Clean funnel
- Container for used hydraulic fluid
- Isopropyl alcohol

### Do this task when the pump is not operating.

1. Remove the top cover and the front panel. Refer to [Prepare the pump](#) on page 39 for instructions.
2. Remove the filler cap or the filter head.
3. Use a siphon or a siphon pump to remove the hydraulic fluid from the tank.

4. Disconnect the lower ends of the hydraulic hoses that enter the top of the tank.
5. Remove the filter element and install a new element. Refer to [Replace the hydraulic filter element](#) on page 84 for instructions.
6. Disassemble the hydraulic tank cover.
  - a. Disconnect the temperature/level sensor cable.
  - b. Disconnect the hydraulic hose from the filter.
  - c. Remove the 2 hoses that pass through the cover.
  - d. Use a 7/16-inch open-ended wrench to remove the bolts and washers (10 each) from the tank cover.
7. Clean the inner surfaces of the tank with clean towels. Make sure that no debris is left in the bottom of the tank.

<b>CAUTION</b> 	Remove all towels from the tank before putting hydraulic fluid in it.
<b>CAUTION</b> 	Do not use soap, detergent, or solvents. Isopropyl alcohol can be used to clean the tank.

8. Assemble the hydraulic tank cover.
  - a. Install the tank cover bolts and washers (10 each).
  - b. Install the 2 hoses that pass through the cover.
  - c. Connect the hydraulic hose from the filter
  - d. Connect the temperature/level sensor cable.
9. Fill the tank with hydraulic fluid until the fluid is at the top mark on the sight gauge.
10. Install a new filler cap.
11. Discard the used parts.
12. Turn **ON** the pump in pierce-pressure mode.
13. Monitor for leaks.
14. Add hydraulic fluid, if necessary. Refer to [Add hydraulic fluid](#) on page 85.
15. Operate the pump in pierce-pressure mode for 15 to 20 minutes.



If air is in the hydraulic system, the pump can be noisy during operation. Refer to [The pump makes noise during operation](#) on page 133.

## Lubricate the primary motor bearings

Do this task every 3,000 hours.

**CAUTION**



Correct lubrication is important for motor performance. Use the correct types and amounts of grease and oil.

**CAUTION**



The bearing can overheat if too much or not enough grease is used to lubricate the bearing



Most handheld pump grease guns have an output of 1.25 grams of grease per pump. Refer to documentation from the manufacturer of your grease gun.



**Parts, tools, and materials**

- Low-pressure handheld grease gun
- NLGI grade 2 bearing grease
- Clean towels

**Recommended materials**

Mobil Polyrex™ EM

**Do this task when the pump is operating.**

1. Remove the top cover and the front panel. Refer to [Prepare the pump](#) on page 39 for instructions. [Prepare the pump](#) on page 39
2. Remove the grease fitting cap.



3. Remove the plastic plug on the bottom side of the motor.
4. Clean the grease fitting with a towel, if necessary.
5. Attach a grease gun coupler to the grease fitting.



6. Use a grease gun to put the specified quantity of grease in the motor.





Echion 15	Echion 30	Echion 50
13 grams	18 grams	21 grams

7. Replace the grease cap.

<b>CAUTION</b> 	Use only the recommended volume of grease.
---	--

8. Do this procedure again on the other end of the motor.
9. Use the postmaintenance start procedure after working on the primary motor. Refer to [page 91](#).

## Start the pump after maintenance

<p><b>CAUTION</b></p> 	A turning motor shaft can be dangerous. Close all doors and replace all covers, including access covers.
<p><b>CAUTION</b></p> 	Do not try to repair a leak with pressure in the system.
<p><b>CAUTION</b></p> 	Remove all tools, towels, and rags from the work area before starting the equipment.
<p><b>CAUTION</b></p> 	Make sure that all fittings are tight after doing maintenance on or repairs to this equipment.

Start the pump normally if maintenance done on the pump was limited to:

- replacing the water filter.
- replacing the hydraulic filter element.
- replacing the hydraulic fluid.
- repairing or replacing the bleed-down valve.
- working on the electrical system.



Refer to [Start the pump](#) on page 43 for instructions.

Use the [Postmaintenance start procedure](#) on page 91 if maintenance or repairs have been done on:

- the high-pressure water system.
- intensifier components.
- the primary motor.

## Postmaintenance start procedure

A smooth start after maintenance can give the high-pressure seal longer life.

 Touch the  symbol to stop the procedure and to turn **OFF** the pump.

Use this program to increase the water pressure gradually. The procedure takes approximately 6 minutes. Refer to [Touchscreen maps](#) on page 175 for details about the program.

1. Turn **ON** the utility water to the pump.
2. Turn **ON** the compressed air source.
3. Turn **ON** the electrical main (line disconnect switch).
4. Turn the primary breaker disconnect lever on the electrical enclosure door to **ON**.
5. Make sure that the EMERGENCY STOP is not engaged. If the button is pushed in, turn the button clockwise until it releases.
6. Make sure that the key switch is set to Local .
7. Push the Controls button to turn **ON** the control circuit in the pump.
8. On the operator interface, touch the maintenance symbol to open the primary maintenance screen.



9. Touch this symbol to open the **Start Procedure** screen.



10. Touch the symbol on the screen to start the procedure.

	<p>While the procedure continues, examine the pump for high-pressure water leaks and hydraulic fluid leaks. Monitor these areas.</p> <ul style="list-style-type: none"> <li>● Hydraulic connections</li> <li>● Valves</li> <li>● Intensifier bridge and bottom deck</li> </ul>
---	--

11. When **Turn On the Cutting Head** flashes on the screen:
  - a. Move the cutting head to a safe location on the table.
  - b. Turn **ON** the cutting head.
  - c. Touch the  symbol to continue.

12. When **Turn Off the Cutting Head** flashes on the screen:

- a. Turn **OFF** the cutting head.
- b. Touch the  symbol to continue.

13. When **Examine the Pump** flashes on the screen:

- a. Examine the pump for loose fittings or leaks.
- b. Examine the attenuator connections for leaks.

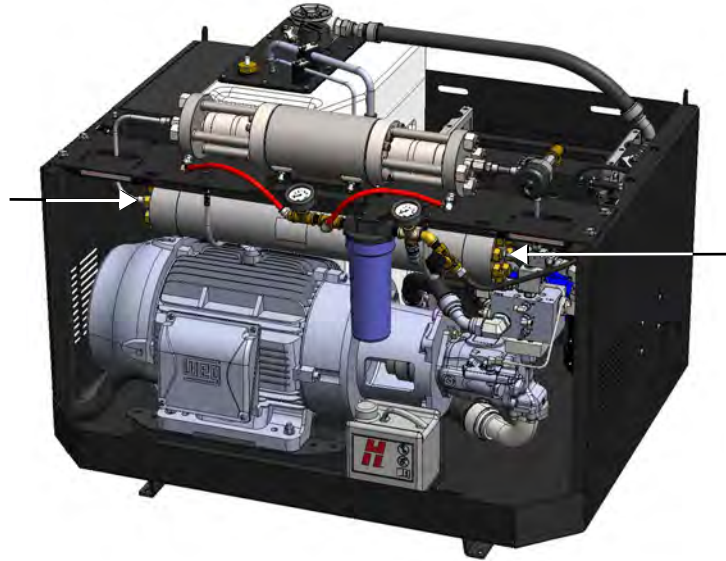



- c. Touch the  symbol to continue.
  - The main motor turns off.
  - The primary operation screen opens.

14. Install the top cover and the front panel.

The pump is ready for operation.

## Prepare for storage

<b>WARNING</b> 	<p>High-pressure water can cause eye injuries. Wear approved eye protection when operating or doing work near this equipment.</p> <p>Do not stand over components such as tubes or valves while drying the system.</p>
	<p>All low-pressure water connections use push-to-connect fittings.</p>

Use this procedure to prepare the system for storage. Clearing the water lines prevents freezing, which can cause damage to the pump.

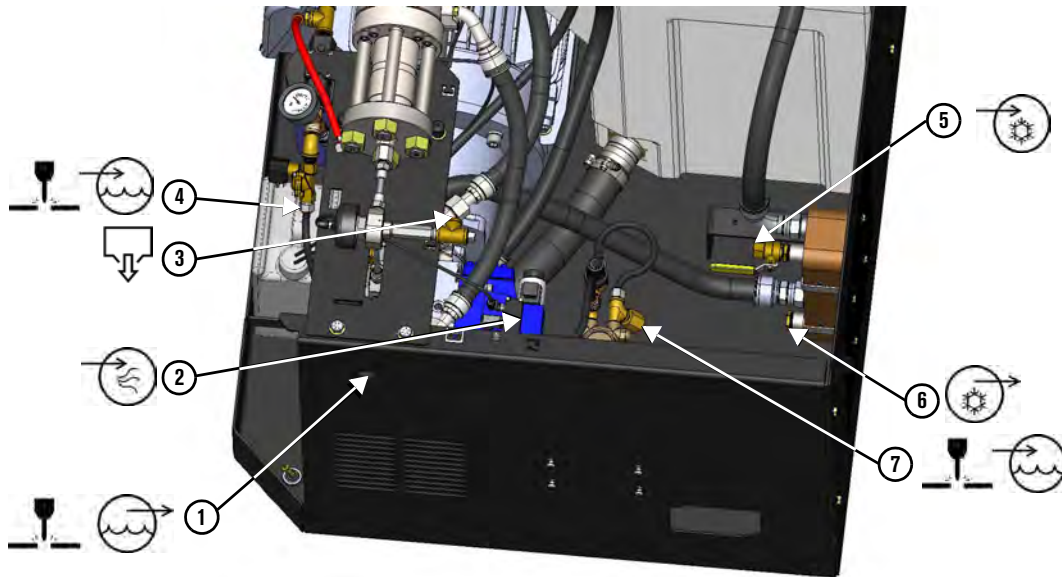

- Cutting water in**
- ⑦ Boost pump
  - ④ Inlet water solenoid (for systems without a boost pump)
- Water out**
- ③ Waste water out
  - ② Compressed air
  - ① Cutting water out

- Water-cooled system**
- ⑤ Cooling in
  - ⑥ Cooling out

Refer to [Connect the water and the air](#) on page 157 for information about the connections.



### Parts, tools, and materials

1/8-inch male to 1/2-inch male adapter  
(compressed air to **cutting water in**)  
1/8-inch male to 1-inch male adapter  
(compressed air to **cooling in**)

7/16-inch open-ended wrench  
1-1/16-inch open-ended wrench  
Filter wrench (included in the standard tool kit)

### Water-cooled system

1-inch open-ended wrench  
1-3/16-inch open-ended wrench

### Do this task when the pump is not operating.

1. Remove the water filter from the filter canister. Refer to [Replace the water filter](#) on page 80.
2. Pour the water out of the filter canister.
3. Install the water filter canister without the filter.
4. Disconnect the compressed air from the pump. Connect the compressed air hose to the **Cutting water in** connection.



The **compressed air** hose connection is 1/8-inch NPT male. The **Cutting water in** connection is 1/2-inch NPT female. An adapter (not included) is necessary.

5. Use a 1-1/16-inch open-ended wrench to disconnect the **Waste water out** hose from the pump.
6. On the operator interface, touch the maintenance symbol to open the primary maintenance screen.



7. Touch this symbol to open the **Prepare for Storage** screen.



8. Touch the symbol on the screen to start the procedure.  
The supply-water valve opens.
9. Turn **ON** the compressed air for a minimum of 5 minutes to dry the system.
10. Turn **OFF** the compressed air.

11. Touch the  symbol to continue.

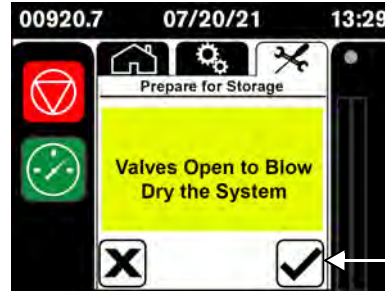

The water valve closes.

12. Disconnect the compressed air hose from the **Cutting water in** connection.
13. Make sure that the water filter canister is empty. Water can collect in the canister when the system is cleared.
14. Install the water filter canister with the filter.
15. Do this procedure for a water-cooled system.



Air-cooled systems do not require fluid removal.

- a. Use a 1-inch open-ended wrench to connect the compressed air hose to the **Cooling in** connection.



The **Cooling in** connection is 1/2-inch NPT female. An adapter (not included) is necessary.

- b. Use a 1-3/16-inch open-ended wrench to disconnect the **Cooling out** line from the pump.
- c. Disconnect the compressed air hose from the **Cooling in** connection.
- d. Do [step 8](#) through [step 12](#) again.
16. Install the original caps and the plugs for the utility connections.

## Recycling and end of product life

---

At the end of the life of the product or its parts, recycle or discard materials and parts. Use an environmentally satisfactory method and in accordance with local regulations. If the product contains substances that could cause damage to the environment, remove and dispose of them in accordance with current local regulations. This includes liquids such as hydraulic fluid.

Make sure that dangerous substances are disposed of safely and that the correct personal protective equipment is used. The safety specifications must be in accordance with the current local regulations at all times.



# 4

## ***Parts lists***

Genuine Hypertherm parts are the factory-recommended replacement parts for this pump. It is possible that the Hypertherm warranty will not cover damage caused by nongenuine Hypertherm parts.

To order parts, contact the original equipment manufacturer (OEM).

## Tools

### 1-18768 Standard tool kit



	Part number	Description	Quantity
1	1-12091	Torque wrench, 3/4-inch drive, 80 N·m to 400 N·m (60 lbf·ft to 300 lbf·ft)	1
2	1-17490	Breaker bar, 40-inch	1
3	1-18038	White lithium grease, 44.3 ml (1.5 fluid oz)	1
4	1-13537	PURE Goop halocarbon-based antiseize lubricant, 28 g (1 oz)	1
5	1-11111	Blue Goop oil-based antiseize lubricant, 57 g (2 oz)	1
6	1-11136	High-vacuum grease, 150 g (5.3 oz)	1
7	1-13972	Water filter wrench	1
8	1-18851	Square drive adapter, 3/4-inch female to 1/2-inch male	1
9	1-18852	Hex-bit socket, 1/2-inch square drive, 3/8-inch	1
10	1-12021	12-point socket, 3/4-inch square drive, 1-1/2-inch	1
11	1-13281	Granite lapping block	1
12	1-11210-12	Lapping paper, 12 micron, 1 sheet	10

The tool case contains all of the above items except:

- The torque wrench has a separate case.
- The granite lapping block is shipped in a wooden box.
- The breaker bar is shipped in a bag.

## Intensifier repair tools



	Part number	Description	Quantity
1	1-18416	Seal installation tool	1
2	1-18848	Cylinder locator tool	1
3	1-18803	Seal removal tool	1

These tools are shipped with the pump.

## Maintenance and repair kits

### 1-18769 Echion standard spare parts kit

Part number	Description	Quantity
1-18770	Repair kit, high-pressure seal, Echion	2
1-18771	Repair kit, high-pressure poppet, Echion	1
1-18849	Repair kit, low-pressure poppet, Echion	1
1-17434	Repair kit, bleed-down valve	1
1-18772	Replacement kit, hydraulic fluid	1
1-11106	Filter cartridge, water, 1.0 micron, 10-inch	1

### 1-18770 Echion high-pressure seal repair kit



	Description	Quantity
1	Spring, energized seal, 7/8-inch	2
2	O-ring backup, seal housing, -122	2
3	O-ring, seal housing, -122	2
4	Seal cartridge, high-pressure	2
5	Poppet screw, low-pressure	2

Each high-pressure seal cartridge includes:

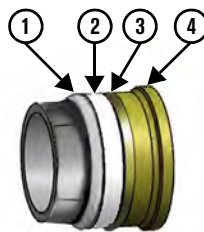

1	High-pressure seal O-ring, greased, -119	3	High-pressure hoop
2	High-pressure seal	4	High-pressure seal backup, bronze

### 1-18771 Echion high-pressure poppet repair kit



	Description	Quantity
1	Cotton-tipped applicator	2
2	Poppet, high-pressure	2
3	Poppet spring, high-pressure	2
4	Poppet seat, high-pressure	2

### 1-18849 Echion low-pressure poppet repair kit



	Description	Quantity
1	Wear ring, check-valve	2
2	O-ring, check-valve, -120	2
3	Poppet screw, low-pressure	2
4	Poppet, low-pressure	2

Parts lists

### 1-17434 Bleed-down valve repair kit

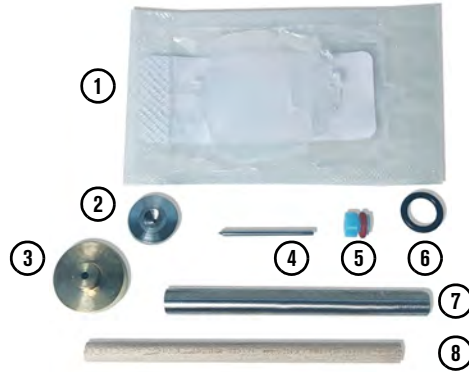

	Description	Quantity
1	High-vacuum grease, 150 g (5.3 oz)	1
2	Poppet seat, high-pressure	1
3	Valve seal, high-pressure	1
4	Needle, bleed-down valve	1
5	Needle guide, bleed-down valve	1
6	O-ring, -01 1	1
7	Flow reducer insert, bleed-down valve	1
8	Wooden dowel	1

### 1-18772 Hydraulic fluid replacement kit



	Description	Quantity
1	Filter element, hydraulic, 5-micron	1
2	Filler cap	1

## Optional equipment kits

---

Part number	Description
1-18603	Boost pump kit 100 gallons per hour, 208 V / 230 V
1-18576	Boost pump kit 100 gallons per hour, 400 V / 460 V
1-18551	Modbus TCP/IP communication kit
1-18552	Utility connection panel kit
1-18553	Metric conversion kit
1-18695	Pump-mounted plumbing kit

## Replacement parts



Item numbers in **orange** are not shown in the illustration. The number shows the relative location of the part in or on the machine.

Colors (blue, green, pink, and yellow) are used in the illustrations to show where one component ends and another begins. The colors are used for contrast and do not mean anything specific.

### 1-18938 Top-cover hardware replacement kit

Description	Quantity
Snap-in handle	2
Latch receptacle	2
Latch stud	2
Latch retainer	2
Latch spring	2

### Lubricants

Part number	Description
1-11111	Blue Goop oil-based antiseize lubricant, 57 g (2 oz)
1-13537	PURE Goop halocarbon-based antiseize lubricant, 28 g (1 oz)
1-11136	High-vacuum grease, 150 g (5.3 oz)
1-18038	White lithium grease, 44.3 ml (1.5 fluid oz)



## Electrical system

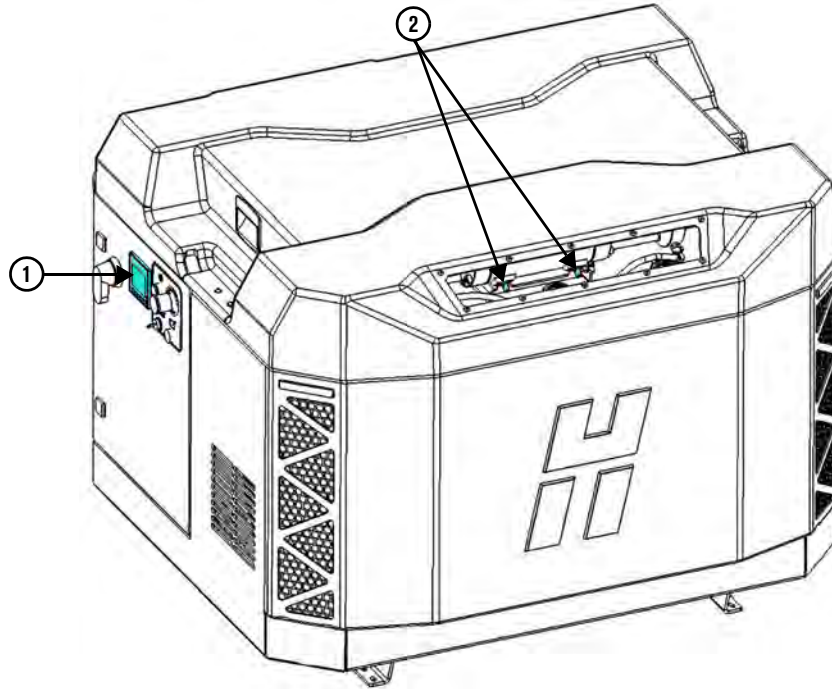

	Part number	Description
1	1-15005	PLC, Horner XL4 (requires program 1-18855)
2	1-18755	Proximity switch
—	1-17355	Memory card, SDHC MicroSD, 32GB (not shown)

## High-pressure water system

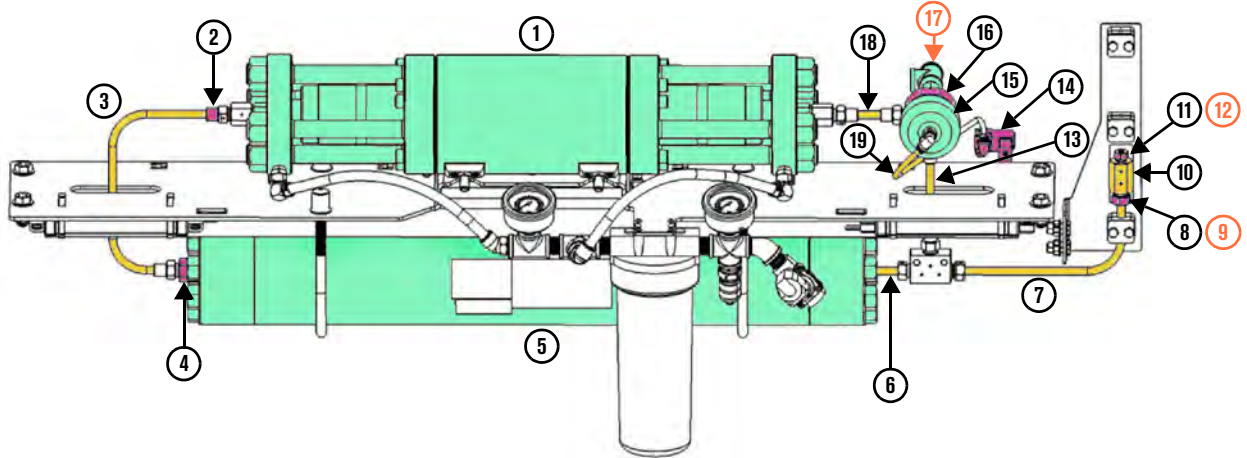

	Part number	Description
1	1-18314	Echion intensifier
2	1-14687	Sheathing end cover, high-pressure tubing, 3/8-inch
3	1-18445	Tube, high-pressure, intensifier left
4	1-12982	Inlet adapter, 3/8-inch male × 3/8-inch female
5	1-12280	Attenuator assembly, 1 liter
6	1-WJN6600375	Tube nipple, high-pressure, attenuator-to-tee
7	1-18694	Tube, high-pressure, L-shaped
8	1-13158-60-6	Gland nut, high-pressure, 3/8-inch
9	1-13157-60-6	Collar, high-pressure, 3/8-inch (not shown)
10	1-13160-60-4F6F	Reducing coupling, high-pressure, 3/8-inch female × 1/4-inch female
11	1-13158-60-4	Gland nut, high-pressure, 1/4-inch
12	1-13157-60-4	Collar, high-pressure, 1/4-inch (not shown)
13	1-WJN6600725	Tube nipple, bleed-down valve-to-tee
14	1-13949	Air solenoid, bleed-down valve
15	1-18310	Bleed-down valve assembly, air-actuated
16	1-18311	Bleed-down valve body
17	1-17130	Plug, stainless steel NPT, 1/2-inch (not shown)
18	1-WJN6600500	Tube nipple, high-pressure, intensifier right
19	1-18784	Replacement kit, bleed-down valve air tube, 1/4-inch
—	1-12580	Protective sheathing, 3/8-inch (not shown)

### Intensifier high-pressure ends

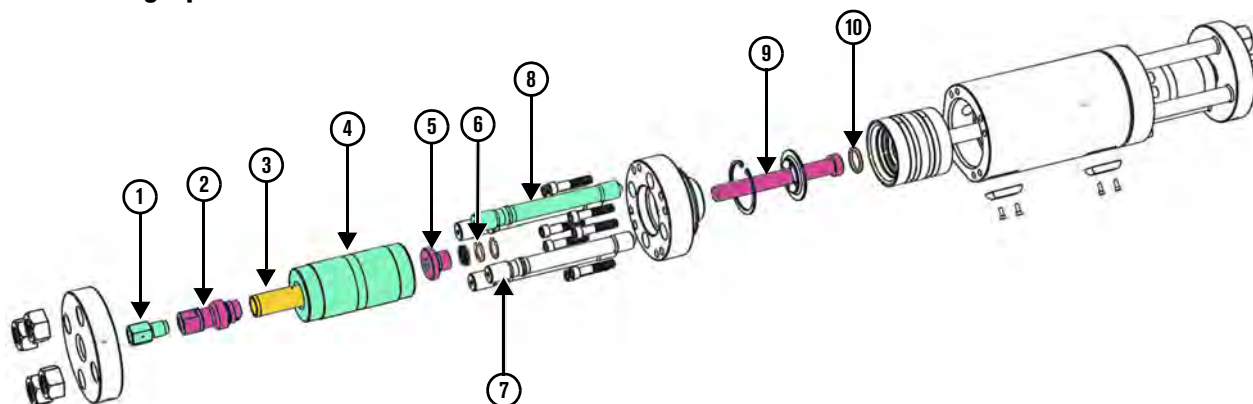

	Part number	Description
1	1-18381	Output adapter
2	1-18631	Check-valve assembly
3	1-18395	Spacer tube
4	1-18386	Cylinder, high-pressure
5	1-18384	Seal housing assembly
6	1-11468	Spacer, rod seal
7	1-12370	Snap ring, rod seal
8	1-18935	Stud assembly
9	1-11309	Plunger, 7/8-inch
10	1-12367	Plunger T-seal

The check-valve assembly includes:

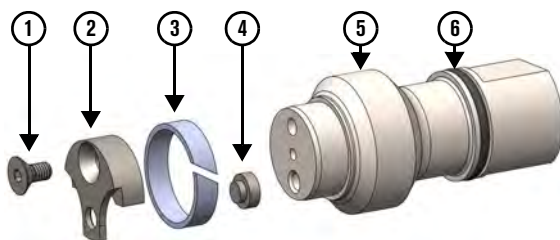

1	Low-pressure poppet screw	4	Low-pressure poppet
2	Low-pressure poppet retainer	5	Check-valve body
3	Check-valve guide ring	6	Check-valve O-ring, -120

Parts lists

## Low-pressure water system

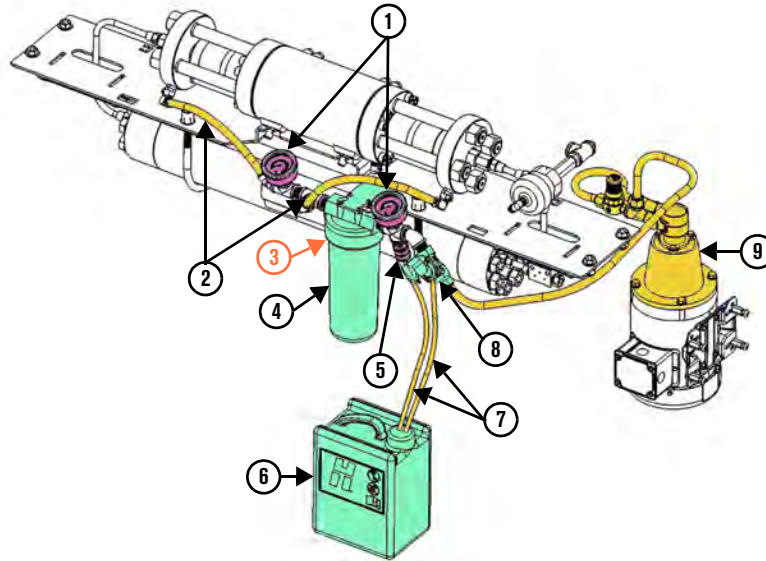

	Part number	Description	Quantity
1	1-11832	Gauge, low-pressure water	1
2	1-18782	Replacement kit, intensifier inlet water tube	1
3	1-11679-237	O-ring, low-pressure, filter canister (not shown)	1
4	1-18318	Canister assembly, water filter	1
5	1-18417	Switch, low-pressure water	1
6	1-18577	Dirty water container	1
7	1-18783	Replacement kit, fluid management tube	2
8	1-12614	Solenoid valve, inlet water	1
9	1-18931	Boost pump wet end assembly	1
—	1-13897	Meter, TDS (not shown)	1

## Hydraulic system

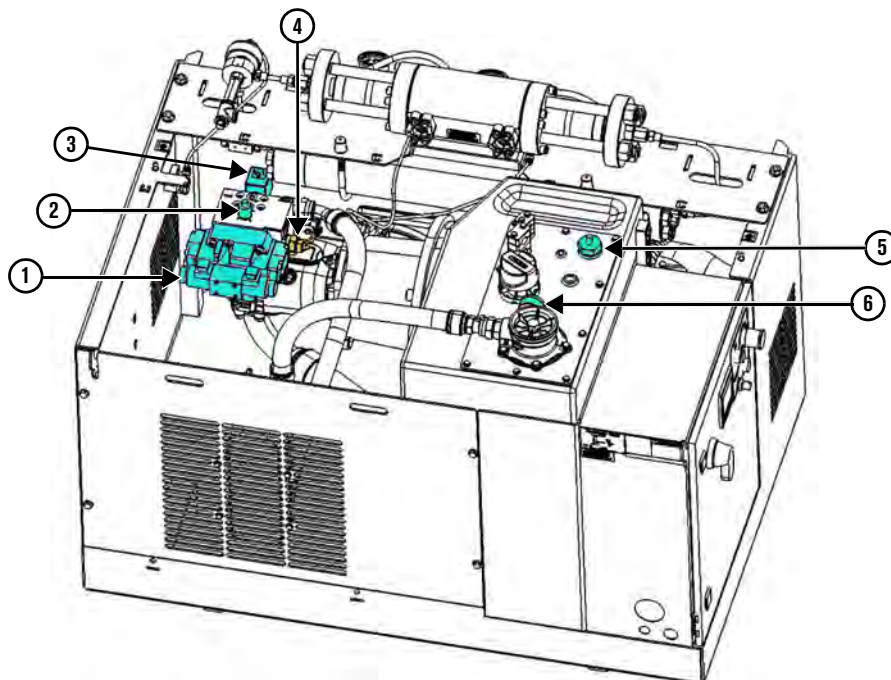



	Part number	Description
1	1-11733	Assembly, shift valve, 24 VDC
2	1-17348	Transducer, hydraulic
3	1-17347	Valve and coil, proportional cartridge
4	1-17349	Relief valve, hydraulic high-pressure, preset
5	1-12617	Switch, temperature and fluid level
6	1-18898	Gauge, hydraulic filter







# 5



## **Troubleshooting**

	This section assumes that the user is familiar with the <b>Safety</b> , <b>Operation</b> , <b>Preventive maintenance</b> , and <b>Specifications</b> sections of this manual.
	Images in this manual are for reference purposes. It is possible that your product configuration is not shown accurately.
	It is possible that not all of the information in this section applies to all pump models.

## Safety

<p><b>WARNING</b></p> 	<p><b>Read and understand all of the safety guidelines in this manual.</b></p> <p>Before operating, doing maintenance on, repairing, and installing your pump, read the <a href="#">Safety</a> section, which starts on <a href="#">page 21</a>.</p>
	<p>Keep the work area clean and dry.</p> <p>Clean fluid spills immediately.</p> <p>Use a pan or a tray below areas where water or hydraulic fluid can spill during maintenance or repair procedures.</p>
	<p>Obey local protocols for recycling or disposal of parts, materials, and fluids.</p> <p>National and local environmental rules can apply to disposal.</p> <p>Refer to <a href="#">Recycling and end of product life</a> on page 96.</p>
	<p>Coordinate maintenance and repairs with facility and safety staff.</p>

## General

	<p>If the problem is not found in this section, contact a Hypertherm Technical Service Associate for information and support.</p>
	<p>Keep accurate maintenance records.</p> <p>Records can help with predicting and preventing maintenance problems.</p>
	<p>Use SAE (US standard) tools for most procedures.</p>



# Primary operation screen

## Intensifier stroke-rate bars and status indicator

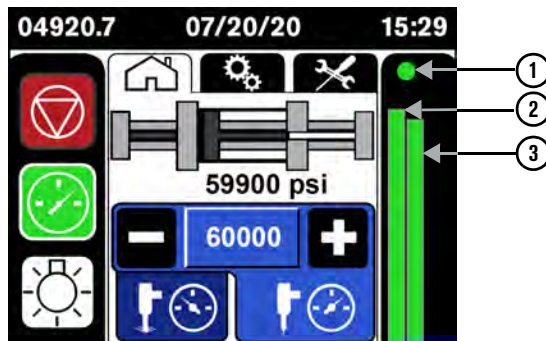

- |  |   |
|--|---|
| <p>1 Intensifier status indicator</p> <ul style="list-style-type: none"> <li><span style="color: green;">●</span> Enabled (green)</li> <li><span style="color: red;">●</span> Not enabled (red)</li> </ul> | <p>2 Intensifier stroke rate to the left</p> <p>3 Intensifier stroke rate to the right</p> <ul style="list-style-type: none"> <li><span style="color: green;">■</span> The stroke rate is within the permitted range (green).</li> <li><span style="color: yellow;">■</span> The stroke rate is at the limit of the permitted range (yellow).</li> <li><span style="color: red;">■</span> The intensifier is overstroking (red).</li> </ul> |
|--|---|

During normal operation, the intensifier strokes smoothly to the left and to the right at the same speed.

It is normal for the intensifier to stroke faster during the start sequence and when changing from pierce pressure to cut pressure.

The stroke-rate bars show the speed of the piston and the plunger moving to each side of the intensifier (if you are facing the front of the pump.)

The height of the bars in relation to each other show if the piston is stroking evenly from side to side or if one side is stroking faster than the other (overstroking). This information is useful during troubleshooting. Uneven bars can mean that poppet maintenance required.

If a bar is red, then an overstroke has caused an alarm condition on that side.

## Alarms

The controller monitors the pump while the pump is operating. When the controller senses a problem that is likely to cause damage to the equipment, the operator interface shows the **Alarms** screen.

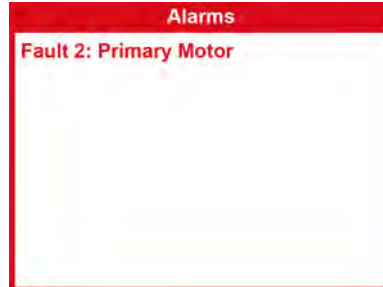

To acknowledge an alarm, touch the screen. The **Alarm Log** screen opens.

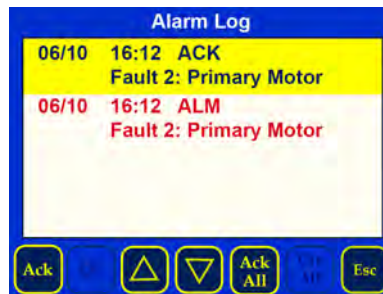

Touch **Ack** (acknowledge) or **Ack All** (acknowledge all) on the screen.

The alarm screen closes.

## Types of alarms

	The intensifier is...	The primary motor is...	Cause of alarm
<b>Warning</b>	Enabled	On	The controller senses a condition that can cause a problem or a failure.
<b>Fault 1</b>	Off	Off	The controller senses a condition that will cause a problem or a failure.
<b>Fault 2</b>	Off	Off	The controller senses a failure condition.



## Warnings

Alarm	Cause	Solution
<p><b>Warning: Battery Error</b></p>	<p>The controller battery is not operating correctly.</p>	<p>Contact a Hypertherm Technical Service Associate for information and support.</p>
<p><b>Warning: Boost Motor</b> <b>Warning: Fan Motor</b></p> <div style="text-align: center;">  <p><b>On</b>                      <b>Tripped</b>                      <b>Off</b></p> </div>	<p>The boost motor or the fan motor did not start because the thermal overload relay has tripped.</p>	<p>Reset the relay.</p> <ul style="list-style-type: none"> <li>▪ Find the thermal overload relay on the motor starter.</li> <li>▪ Turn the knob clockwise to the <b>ON</b> position (I).</li> <li>▪ Release the knob. It snaps counterclockwise to the <b>OFF</b> position (O).</li> <li>▪ Turn the knob clockwise to the <b>ON</b> position (I) again.</li> </ul>
<p><b>Warning: Start Procedure Hydraulics</b></p>	<p>An error occurred during stage 3 of the start sequence.</p> <ul style="list-style-type: none"> <li>▪ The cutting head is on.</li> <li>▪ The bleed-down valve is leaking.</li> <li>▪ The bleed-down valve is not receiving air.</li> <li>▪ The Hydraulics timer setting is too short.</li> </ul>	<ul style="list-style-type: none"> <li>▪ Make sure that the cutting head is off.</li> <li>▪ Repair or replace the bleed-down valve.</li> <li>▪ Make sure that the compressed air supply is on.</li> <li>▪ Adjust the timer on the Start-procedure Timers screen. Refer to <a href="#">Start Procedure Timers</a> on page 166.</li> </ul>
<p><b>Warning: Start Procedure Ramp to Pierce Pressure</b></p>	<p>An error occurred during stage 4 of the start sequence.</p>	
<p><b>Warning: Start Procedure Ramp to Cut Pressure</b></p>	<p>An error occurred during stage 5 of the start sequence.</p>	
<p><b>Warning: Too Many Motor Starts in 15 Minutes</b></p>	<p>Starting and stopping the motor rapidly can cause damage to the motor.</p>	<p>Wait longer between stopping and starting the motor.</p>

## Faults

Fault conditions cause the pump to turn off.

Alarm	Cause	Solution
<b>Fault 1: Hydraulic Fluid &gt;65C</b> The hydraulic fluid temperature is higher than 65°C (149°F).	The system is not cooling sufficiently.	Refer to <a href="#">Temperature</a> on page 124.
<b>Fault 1: Intensifier Overstroke to Left</b> <b>Fault 1: Intensifier Overstroke to Right</b>	An overstroke fault occurs when the hydraulic piston travels faster than the pump can sustain. A poppet (high-pressure or low-pressure) is stuck or is leaking.	Examine the low-pressure poppet on the same side as the overstroke. Examine the high-pressure poppet on the opposite end from the overstroke. Refer to <a href="#">Overstroke</a> on page 121.
<b>Fault 1: Low Inlet Water Pressure</b>	The supply-water pressure is lower than 2.8 bar (280 kPa / 40 psi).	Increase the supply pressure.
	Pressure is lost because of a leak.	Identify the source of a leak and correct the problem.
	The supply water is off.	Turn <b>ON</b> the supply water.
<b>Fault 2: Hydraulic Fluid 45C Sensor</b>	The temperature sensor in the hydraulic fluid tank has failed.	Replace the sensor.
<b>Fault 2: Hydraulic Fluid Level is Low</b> The float switch in the hydraulic fluid tank monitors the fluid level.	A hydraulic fitting or a hydraulic hose is leaking.	Fix the leak. Refer to <a href="#">Hydraulic fluid</a> on page 123.
	The sensor is faulty.	If the tank is full, replace the sensor.
	A poppet (high-pressure or low-pressure) is stuck or leaking.	Repair or replace the component.
<b>Fault 2: Input to Primary Motor Not Received</b>	The controller did not receive a signal from the starter when the pump was turned on.	Contact a Hypertherm Technical Service Associate for information and support.
<b>Fault 2: Water Pressure Control Error</b>	The pump did not get to the target water pressure within the expected time. <ul style="list-style-type: none"> <li>▪ The hydraulic pressure transducer on the pump manifold has failed.</li> <li>▪ The proportional valve has failed.</li> <li>▪ The proportional valve coil has failed.</li> <li>▪ The hydraulic pump has failed.</li> </ul>	Repair or replace the component.
	The orifice has failed.	Examine the orifice. Replace it, if necessary.
	A component inside the hydraulic center section has failed.	Contact a Hypertherm Technical Service Associate for information and support.



Alarm	Cause	Solution
<b>Fault 2: Primary Motor</b> The primary motor did not start.	The thermal overload relay has tripped.	Reset the relay. Refer to <a href="#">Warning: Boost Motor</a> on page 115.   The relay can take several minutes to cool before resetting.
	The motor is too hot.	Refer to <a href="#">Primary motor</a> on page 117.
	The soft starter sensed a fault.	<ol style="list-style-type: none"> <li>Turn the primary breaker disconnect lever on the electrical enclosure door to <b>OFF</b>.  The pump is not energized.</li> <li>Turn the primary breaker disconnect lever on the electrical enclosure door to <b>ON</b>.  The pump is energized.</li> </ol>  It can take several minutes for the system to reboot.
	A fuse in the electrical enclosure has blown.	Replace the blown fuse.

## Primary motor

Problem	Cause	Solution
<b>The motor is too hot.</b>	The motor is not cooling sufficiently.	Clean the air inlet.
		Clean the air outlet and the cooling fins.
		Reduce the ambient air temperature, if possible.
	The motor is being started too frequently.	Wait longer between stopping and starting the motor.
	The motor bearing is too hot.	Lubricate the bearing. Refer to <a href="#">Lubricate the primary motor bearings</a> on page 88.

# Intensifier

## Leaks

<p><b>CAUTION</b></p> 	<p>If a high-pressure poppet part is damaged, replace the assembly (high-pressure poppet, spring, and seat).</p>
	<p>Fluid leaking from a weep hole is a sign of a defective part or a loose connection.</p>

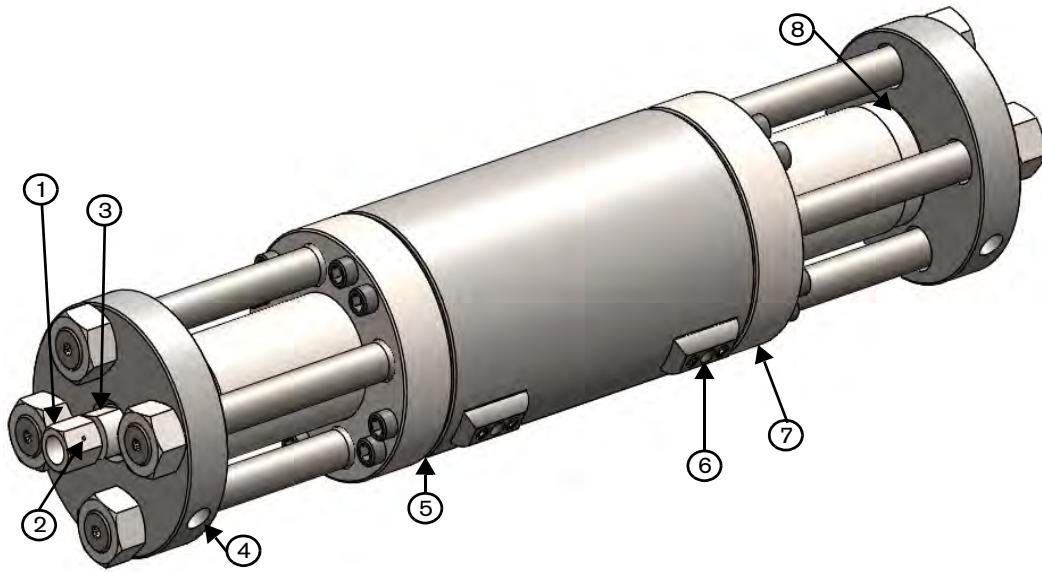

Numbers pointing to items in the illustration refer to corresponding numbers in the table.

	Symptom	Cause	Solution
1	The fitting or the output adapter is hot	The high-pressure poppet is leaking.	<ul style="list-style-type: none"> <li>Disassemble the parts and look for flaws, deterioration, erosion marks, or cracks.</li> <li>Make sure that the mating surfaces are smooth and clean.</li> <li>If damage is found, replace the component.</li> </ul>
2	Water leaks from the weep hole	A high-pressure tubing connection is loose or damaged.	<ul style="list-style-type: none"> <li>Examine the connection.</li> <li>Make sure that the fitting is tightened correctly and to the correct torque value.</li> </ul> <p>Refer to <a href="#">High-pressure water fittings</a> on page 144.</p>
		The output adapter has failed.	Replace the component.

	Symptom	Cause	Solution
3	<b>Hot water is leaking.</b>	The output adapter is loose.	Make sure that the adapter is tightened to the correct torque value. Refer to <a href="#">High-pressure water fittings</a> on page 144.
		The high-pressure seat has failed.	<ul style="list-style-type: none"> <li>▪ Disassemble the parts and look for flaws, deterioration, erosion marks, or cracks.</li> <li>▪ Make sure that the mating surfaces are smooth and clean.</li> <li>▪ If damage is found, replace the component.</li> </ul>
		The face of the check valve is cracked.	Replace the check valve.
	<b>Cold water is leaking.</b>	The O-ring on the check-valve body has failed.	Replace the O-ring.
4	<b>Cold water leaks from the weep hole.</b>	A fitting connection is bad.	Make sure that the fitting is tightened to the correct torque value. Refer to <a href="#">High-pressure water fittings</a> on page 144.
	<b>The fitting is warm or the low-pressure water line is pulsing.</b>	The low-pressure poppet is leaking.	Repair or replace the poppet. The check valve is cracked. Replace the check valve.
5	<b>Hydraulic fluid is leaking from between a high-pressure end cap and a high-pressure cylinder.</b>	The hydraulic end cap bolts are not tightened.	Make sure that the end cap bolts are tightened to the correct torque value. Refer to <a href="#">Fittings</a> on page 144.
		An O-ring has failed.	Examine and replace the O-ring.
		A high-pressure seal is damaged or has failed.	<ul style="list-style-type: none"> <li>▪ Disassemble the parts and look for flaws, deterioration, erosion marks, or cracks.</li> <li>▪ Make sure that the mating surfaces are smooth and clean.</li> <li>▪ If damage is found, replace the component.</li> </ul>
6	<b>Hydraulic fluid is leaking.</b>	The O-ring on the proximity switch has failed.	Replace the O-ring or the sensor.

## 5 Troubleshooting

	Symptom	Cause	Solution
7	Water leaks at a rate of more than 30 ml/minute.	The high-pressure seal has failed.	Replace the seal.
	Hydraulic fluid leaks at a rate of more than 30 ml/minute.	The hydraulic seal has failed.	Replace the seal.
8	Water is leaking.	The high-pressure cylinder has failed.	Replace the cylinder.
		The check-valve body has failed.	Replace the check-valve body.



# Overstroke

## Alarm

If an overstroke alarm shows on the operator interface:

1. Turn **OFF** the cutting head.
2. Acknowledge the alarm.
3. Turn the pump on in cut-pressure mode. The intensifier starts stroking.
4. Turn **ON** the cutting head.
5. Monitor the intensifier stroke rate indicator on the operator interface.

If 1 side of the intensifier is stroking too fast, is there a leak from a weep hole on the intensifier?

<b>Yes</b>	Check-valve weep hole leak	<ul style="list-style-type: none"> <li>▪ Examine the high-pressure seal.</li> <li>▪ Make sure that the output adapter torque value is correct.</li> <li>▪ Make sure that the high-pressure fitting torque value is correct.</li> </ul>
<b>No</b>	Is the water from the weep hole hot?	
	Yes	Examine the high-pressure poppet.
	No	<p>Examine the low-pressure poppet and the check-valve body.</p> <ul style="list-style-type: none"> <li>▪ Make sure that the mating surfaces are clean and smooth with a mirrorlike finish.</li> <li>▪ Repair or replace the low-pressure poppet.</li> <li>▪ Repair or replace the poppet retainer.</li> <li>▪ Make sure that the low-pressure poppet fits in the poppet retainer without sticking. Shake the assembly and listen for the poppet moving inside.</li> </ul>
	If the overstroke is to the left:	<p>A poppet is sticking, worn, or damaged.</p> <ul style="list-style-type: none"> <li>▪ Examine the low-pressure poppet on the left side of the intensifier.</li> <li>▪ Examine the high-pressure poppet on the right side of the intensifier.</li> </ul>
	If the overstroke is to the right:	<p>A poppet is sticking, worn, or damaged.</p> <ul style="list-style-type: none"> <li>▪ Examine the low-pressure poppet on the right side of the intensifier.</li> <li>▪ Examine the high-pressure poppet on the left side of the intensifier.</li> </ul>

If both sides of the intensifier are stroking too fast, is a leak visible?

<b>Yes</b>	The high-pressure tubing or a fitting is leaking.	Identify the source of a leak and correct the problem.
	A high-pressure water seal is worn or damaged.	<ul style="list-style-type: none"> <li>▪ Disassemble the intensifier.</li> <li>▪ Examine the parts. Look for flaws, deterioration, erosion marks, corrosion, or cracks.</li> <li>▪ Make sure that the mating surfaces are smooth and clean.</li> <li>▪ If damage is found, replace the component.</li> </ul>
	The bleed-down valve is leaking or has failed.	Repair or replace the bleed-down valve.
	The needle and the seat in the cutting head are leaking. The on/off valve has failed. The cutting head has failed.	<ul style="list-style-type: none"> <li>▪ Examine the parts. Look for flaws, deterioration, erosion marks, corrosion, or cracks.</li> <li>▪ Make sure that the mating surfaces are smooth and clean.</li> <li>▪ If damage is found, replace the component.</li> </ul>
<b>No</b>	The orifice is worn, has failed, or is incorrectly installed. A worn or damaged orifice can increase the demand for high-pressure water from the intensifier.	Replace the orifice.
	The orifice is the wrong size.	

Is the bleed-down valve hot?

<b>Yes</b>	The bleed-down valve has failed.	Repair or replace the bleed-down valve.
	The bleed-down valve is not getting air.	<ul style="list-style-type: none"> <li>▪ Make sure that the compressed air source is on.</li> <li>▪ Make sure that the compressed air hose is not damaged.</li> <li>▪ Make sure that the compressed air hose is connected correctly.</li> </ul>
<b>No</b>	The postfilter water-pressure gauge shows that the low-pressure water is lower than 2.8 bar (280 kPa / 40 psi).	Replace the water filter if the difference between the values on the prefilter water-pressure gauge and the postfilter water-pressure gauge is lower than 0.7 bar (70 kPa / 10 psi).
	The prefilter water-pressure gauge shows that the low-pressure water is lower than 2.8 bar (280 kPa / 40 psi).  Low water pressure can cause an overstroke without triggering the low-pressure alarm for the low-pressure water.	
		<ul style="list-style-type: none"> <li>▪ Make sure that the water to the pump is on.</li> <li>▪ Make sure that the low-pressure water line is connected to the intensifier.</li> <li>▪ If the pump has a boost pump, examine the water filter. If the filter is black, the boost pump has failed and must be replaced. Contact a Hypertherm Technical Service Associate for information and support.</li> </ul>

# Hydraulic fluid

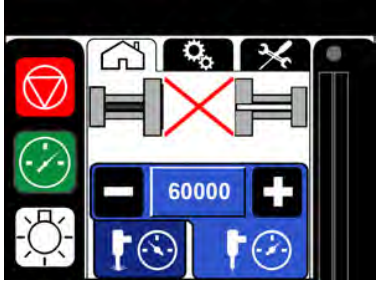
Problem	Cause	Solution
<p><b>The intensifier does not stroke.</b></p>	<p>Intensifier control is off. When intensifier control is off, the primary screen shows a red x on the intensifier symbol.</p> 	<p>Turn intensifier control on. Refer to <a href="#">Intensifier Control</a> on page 170.</p>
	<p>The cutting head is off.</p>	<p>Turn <b>ON</b> the cutting head.</p>
	<p>A proximity switch has failed.</p>	<p>Replace the switch. Contact a Hypertherm Technical Service Associate for information and support.</p>
<p><b>High-pressure water seal life is short.</b></p>	<p>A component is damaged or has failed.</p>	<ul style="list-style-type: none"> <li>▪ Do preventive maintenance according to the recommended schedule. Refer to <a href="#">page 58</a>.</li> <li>▪ Examine the high-pressure cylinder, the plunger, and the high-pressure water seal.</li> <li>▪ Look for flaws, deterioration, erosion marks, corrosion, or cracks.</li> <li>▪ Make sure that the mating surfaces are smooth and clean. If damage is found, replace the component.</li> </ul>
	<p>The supply-water flow or pressure is too low.</p>	<p>Make sure that the supply-water flow and pressure are sufficient. Refer to <a href="#">Specifications</a> on page 135.</p>
	<p>The proportional control valve is not operating correctly.</p>	<p>Contact a Hypertherm Technical Service Associate for information and support.</p>
	<p>The water quality is not sufficient.</p>	<p>Make sure that the water quality is within satisfactory range. Refer to <a href="#">Test the water quality</a> on page 83.</p>

## Temperature

Hydraulic fluid that is too cool is thick, which can cause increased friction and insufficient lubrication.

Hydraulic fluid that is too hot is thin, which can accelerate wear on the parts, increase the formation of sludge, degrade the fluid, and decrease its lubrication and protective qualities.

A sensor monitors the hydraulic fluid temperature in the tank. Increased temperature can mean that there is a problem with the cooling system.



High altitude and ambient air temperatures can have an effect on the temperature of hydraulic fluid.

### **The hydraulic pump has failed.**

Contact a Hypertherm Technical Service Associate.

### **A relief valve has failed.**

Contact a Hypertherm Technical Service Associate.

### **There is a problem in the hydraulic center section of the intensifier.**

Contact a Hypertherm Technical Service Associate.

### **The supply water or the chiller is turned off.**

Turn **ON** the supply water or the chiller.

## **Water-cooled system**

### **The supply water is not turned on.**

Turn **ON** the supply water.

### **The supply water is too warm.**

If the supply-water temperature is higher than 24°C (75°F), cool the water before use. Water that is too warm can shorten high-pressure seal life.

Make sure that the heat exchanger fins are not dirty or clogged. Flush the heat exchanger.

## Air-cooled system



Do not adjust the setting on the thermal overload relay unless instructed to do so by a Hypertherm Technical Service Associate.

### The ambient air temperature is too high.

Ambient air temperature can affect cooling. If a pump that is installed in a small space or in a high-temperature location, consider adding a chiller to the system for supplemental cooling.

### The fan is not generating enough airflow.

Make sure that the fan motor breaker is not tripped.

Clean the air cooler. Refer to [Clean the air cooler](#) on page 78.

### The thermal overload relay turned off the fan motor.

Reset the relay. Refer to [Warning: Boost Motor](#) on page 115.

### The sensor is not sensing the correct temperature.

Plug in the sensor.

Replace the cord.

### The temperature sensor is faulty or damaged.

Replace the sensor.

## Pressure

### The hydraulic fluid pressure is too low.

#### The cut pressure is not set correctly.

Make sure that the cut pressure is set correctly.

#### The pump is in pierce-pressure mode.

Make sure that the pump is in cut-pressure mode.

#### The relief valve on the hydraulic manifold has failed.

Contact a Hypertherm Technical Service Associate for information and support.

## **Level**

A float switch in the hydraulic fluid tank causes an alarm when the hydraulic fluid level is too low.

### **The hydraulic fluid level is too low.**

Make sure that the hydraulic fluid level is at the top mark on the sight gauge.

### **A hydraulic fitting or a hydraulic hose is leaking.**

Fix the leak.

Tighten the fitting to the correct torque value.

Replace the hose.

Replace the O-ring.

### **Hydraulic fluid was lost during maintenance.**

Add hydraulic fluid. Refer to [Add hydraulic fluid](#) on page 85.

### **Hydraulic fluid leaks from the intensifier.**

#### **An O-ring or an energized seal spring has failed.**

Disassemble the intensifier.

Disassemble the parts and look for flaws, deterioration, erosion marks, or cracks.

Make sure that the mating surfaces are smooth and clean.

If damage is found, replace the component.

## Appearance

### The hydraulic fluid in the tank has a milky appearance.

A leaking high-pressure seal in the intensifier can push water past the energized seal spring and into the hydraulic fluid. Contaminated hydraulic fluid can cause damage to the hydraulic pump.

### Water has leaked into the heat exchanger.

#### Water-cooled system: The heat exchanger has failed.

1. Replace the hydraulic fluid. Refer to [page 86](#).



It could be necessary to drain and flush other areas such as the shift valve, the hydraulic manifold, and the hydraulic pump.

2. Examine the parts, including the inner surfaces of the hydraulic fluid tank, the hydraulic hoses, and the seals. Look for flaws, deterioration, erosion marks, corrosion, or cracks.

If damage is found, replace the component.

# Water

---

## Low-pressure water

### The supply-water pressure is too low.

A pressure switch before the water filter senses the supply-water pressure. If the value on the prefilter water-pressure gauge is lower than 2.8 bar (280 kPa / 40 psi), the water pressure to the intensifier is too low. This causes a fault.

### The supply-water pressure or flow is not sufficient.

Make sure that the supply water meets requirements found in [Specifications](#) on page 135.

### The supply-water pressure is too high.

If the value on the prefilter water-pressure gauge is higher than 7.6 bar (760 kPa / 110 psi), the water pressure is too high.

### The boost pump is not needed.

The low-pressure water parts are rated for a maximum pressure of 8.6 bar (860 kPa / 125 psi).

In environments with high supply-water pressure, the boost pump can increase the water pressure to higher than the maximum. This can cause damage to the water filter and other parts.

If the value on the prefilter water-pressure gauge is higher than 4.8 bar (480 kPa / 70 psi):

- ❑ In the electrical enclosure, turn the switch on the boost pump motor contactor to **0**.
- ❑ On the operator interface, turn **OFF** boost pump monitoring. Refer to [Pump Fault Behavior](#) on page 168.

### The boost pump bypass relief valve is not adjusted correctly.

Refer to [Adjust the boost pump pressure](#) on page 162 for instructions for adjusting the valve.



## High-pressure water

### The pump cannot get to the target water pressure.

#### The orifice is defective.

Replace the orifice.

#### There is a leak.

If the intensifier strokes when it is in cut-pressure mode with the cutting head turned off, examine the on/off valve at the cutting head, the bleed-down valve, and the high-pressure tubing for leaks.

Refer to [Leaks](#) on page 118.

#### A check valve is damaged.

Disassemble the parts and look for flaws, deterioration, erosion marks, or cracks.

Make sure that the mating surfaces are smooth and clean with a mirrorlike finish.

If damage is found, replace the component.

#### The pump is in pierce-pressure mode or is set incorrectly.

Put the pump in cut-pressure mode.

Make sure that the cut pressure is set correctly.

#### The supply water is not turned on.

Turn **ON** the supply water.

#### A water filter is clogged.

Replace the water filter.

#### The boost pump has failed.

Examine the water filter. If the filter is black, the boost pump has failed and must be replaced.

Contact a Hypertherm Technical Service Associate for information and support.

#### A poppet is sticking, worn, or damaged.

Disassemble the parts and look for flaws, deterioration, erosion marks, or cracks.

Make sure that the mating surfaces are smooth and clean with a mirrorlike finish.

If damage is found, replace the component.

**Pressure at the cutting head is too low.**

**The thimble filter on the on/off valve is clogged.**

Clean or replace the thimble filter.

**There is a blockage in the high-pressure tubing or at the orifice.**

Remove the blockage from the high-pressure tubing.

Clean or replace the orifice.

**The high-pressure poppet has failed.**

**CAUTION**



If a high-pressure poppet part is damaged, replace the full assembly (high-pressure poppet, spring, and seat).

If an output adapter feels hot:

Disassemble the parts and look for flaws, deterioration, erosion marks, or cracks.

Make sure that the mating surfaces are smooth and clean.

If damage is found, replace the component.

**A component in the high-pressure end has failed.**

Replace the high-pressure seal.

If a high-pressure cylinder feels hot:

- Disassemble the parts and look for flaws, deterioration, erosion marks, or cracks.
- Make sure that the mating surfaces are smooth and clean.

If damage is found, replace the component.



If the high-pressure seal is removed from the plunger when you disassemble the intensifier, replace the seal.

**The orifice is not the correct size or too many are being used at the same time.**

Make sure that the number of orifices and their sizes are sufficient for the pump's output.

**An orifice has failed.**

Replace the orifice.

**The bleed-down valve has failed.**

If the bleed-down valve feels hot or if water comes out of the drain hose, repair or replace the bleed-down valve.

## Leaks

### Water leaks from the intensifier.

Refer to [page 118](#).

### Water leaks through the intensifier drain tubes.

#### A high-pressure water seal is damaged.

A damaged high-pressure water seal is the most common cause of water leaking from the intensifier.

Replace the high-pressure seal.

If a high-pressure cylinder feels hot:

- ❑ Disassemble the parts and look for flaws, deterioration, erosion marks, or cracks.
- ❑ Make sure that the mating surfaces are smooth and clean.

If damage is found, replace the component.



If the high-pressure seal is removed from the plunger when you disassemble the intensifier, replace the seal.

### A fitting is leaking.

#### A low-pressure water line is not seated fully in the fitting.

Make sure that the low-pressure water line is pushed all the way into the fitting.

Make sure that the O-ring is not damaged or missing. Replace, if necessary.

#### The collar on a high-pressure water fitting is not correctly installed.

Refer to [High-pressure water fittings](#) on page 144.

#### A fitting on the high-pressure tubing is not tight enough.

Tighten the fitting to the maximum torque value.

Disassemble the parts and look for flaws, deterioration, erosion marks, or cracks.

Make sure that the mating surfaces are smooth and clean.

If damage is found, replace the component.

#### A tubing end is cracked or damaged.

Replace the tubing.

**The end cap nuts are not correctly tightened.**

Loosen all of the end cap nuts. Use a torque wrench to tighten the nuts to 375 N·m (275 lbf·t). Do this in 70 N·m (50 lbf·ft) increments. Use a repeating cross pattern.

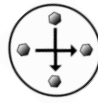

**Water leaks onto the floor or into the pump frame.**

**The dirty water container is full.**

Empty the container.

**The dirty water container is misaligned.**

Move the container.

## The pump makes noise during operation

The pump can make unusual noise during operation if air is in the hydraulic system.

1. Use a 10-mm socket or an open-ended wrench to tighten the hose clamp on the suction hose that goes from the hydraulic fluid tank to the hydraulic pump.

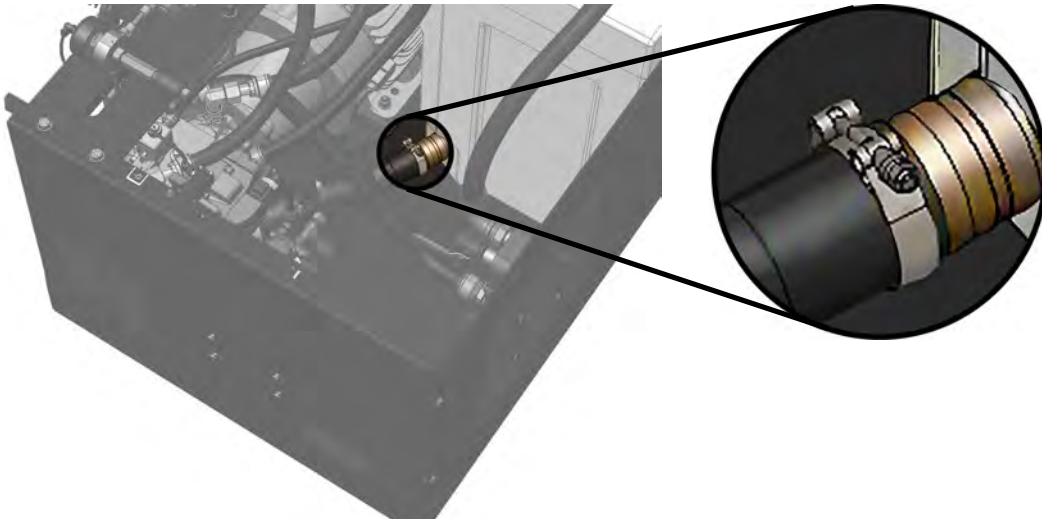

2. Use a torque wrench to tighten the hose clamp to a maximum of 16 N·m (12 lbf·ft).

If the pump continues to make noise after the hose clamp is tightened, contact a Hypertherm Technical Service Associate for information and support.

# Controller errors

## Input/output status

This screen shows the status of inputs to and outputs from the controller.

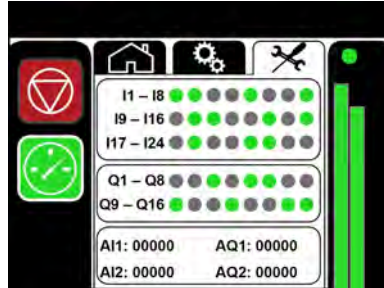

Status: ● = enabled    ● = not enabled

This table describes the assigned inputs and outputs. These can be helpful for troubleshooting.

I1	Not used	I13	Not used
I2	Not used	I14	Not used
I3	Hydraulic fluid temperature is higher than 65°C (149°F)	I15	Controls on
I4	Hydraulic fluid temperature is higher than 45°C (113°F)	I16	Remote mode on
I5	Low inlet pressure switch	I17	Remote pump on
I6	Front intensifier left proximity switch	I18	Remote pump off
I7	Front intensifier right proximity switch	I19	Not used
I8	Not used	I20	Remote pierce-pressure on
I9	Not used	I21	Primary motor fault
I10	Not used	I22	Primary motor on
I11	Not used	I23	Boost pump on
I12	Not used	I24	Heat exchanger fan on
Q1	Low-pressure on	Q9	Not used
Q2	Proportional control output	Q10	Not used
Q3	Not used	Q11	Not used
Q4	Pump on	Q12	Primary motor on
Q5	Fan motor on	Q13	Boost pump motor on
Q6	Enable bleed-down valve	Q14	Remote fault light
Q7	Front-left shift-valve solenoid	Q15	Left frame light (red)
Q8	Front-right shift-valve solenoid	Q16	Right frame light (red)
AI1	Hydraulic pressure	AQ1	Not used
AI2	Remote pressure control	AQ2	Not used

# 6

## **Specifications**



When applicable, measurements are presented in metric units, followed by International System of Units (SI) units and US Customary units in parentheses.

*1 bar (100 kPa / 15 psi)*

*10 mm (3/8 inch)*

*115 N·m (85 lbf·ft)*

This equipment is manufactured in the US, so a metric equivalent is not always available because of inexact conversion.

## All Echion-model pumps

### Environmental conditions



Glycol can be added to the cooling circuit to prevent freezing, but glycol is less efficient for cooling than water.

Hypertherm recommends using a solution of not more than 25% glycol in chillers for this system.

<b>Ambient air temperature</b>	4°C to 35°C (40°F to 95°F)
<b>Relative humidity</b> Noncondensing	95%
<b>Storage temperature</b> Water not drained	2°C to 55°C (35°F to 131°F)

### Hydraulic fluid



Domestic pumps ship from the factory with AW 32 hydraulic fluid.

<b>Type</b>	Antiwear (AW) mineral oil or synthetic hydraulic fluid, ISO viscosity grade (VG) 32 or 46
<b>Hydraulic fluid tank capacity</b>	120 L (32 gallons)
<b>Maximum pressure</b> Set at the factory	217 bar (21,700 kPa / 3,150 psi)
<b>Operation temperature</b>	46°C to 54°C (115°F to 130°F)

A laboratory analysis of hydraulic fluid can tell you if replacement is recommended.

The maximum contamination from particulates that is permitted is 19/17/14 when tested according to ISO 4406. The maximum recommended contamination from water is 300 ppm when tested according to ASTM D6304c-04. If it is not practical to analyze a sample of your hydraulic fluid, Hypertherm recommends replacing it every 3,000 hours.

Refer to [Replace the hydraulic fluid](#) on page 86.



## Utilities

### Electrical power

The motor size determines the full load amperes, the overload settings, and the wire sizes. Refer to your pump model (starting on [page 138](#) in this section) or to the electrical drawings.



The electrical drawings are shipped in an envelope that is found inside the electrical cabinet.

The pump uses 3-phase alternating current (AC) electricity. Some parts, such as valve solenoids and sensors, use 24-volt direct current (VDC) electricity from a power supply in the electrical enclosure.

### Supply water



Do not use deionized water unless the system has stainless steel water fittings. Deionized water can cause the plumbing parts to fail.

Softened water is necessary for most systems. Get advice from a specialist for recommendations for choosing a water treatment system. Reverse osmosis systems are available from Hypertherm.

If the supply-water temperature is higher than 24°C (75°F), cool the water before use. Water that is too warm can shorten high-pressure seal life.

### Cooling

Pump model	kW (minimum)	Refrigeration tons (minimum tons)	Heat removal requirement (minimum Btu/hour)
Echion 15	3	0.85	10,000
Echion 30	6	1.70	20,000
Echion 50	9	2.70	32,000

### Compressed air

	Minimum	Maximum
Pressure	4.8 bar (70 psi)	5.5 bar (80 psi)

## Echion 15

### Dimensions and weights

Length	135 cm (53 in.)
Width	109 cm (43 in.)
Height	101 cm (40 in.)

Shipping weight	850 kg (1,850 lb)
Operating weight	775 kg (1,700 lb)

The shipping weight is for the pump, the pallet, and the packaging. Exact weights are measured at shipment. Operating weight is for an unpackaged pump with hydraulic fluid.

### Electrical

11.2 kW, 15hp	50 Hz		60 Hz	
Voltage	400 V	208 V to 230 V	460 V	
Full-load current	23 A	45 A to 41 A	21 A	
Primary circuit breaker rating	30 A	60 A	30 A	

### Water

	Minimum	Maximum
<b>Cutting water in</b>		
Flow	3.8 L/minute (1.0 gallon/minute)	—
Pressure	2.8 bar (280 kPa / 40 psi)	7.6 bar (760 kPa / 110 psi)
<b>Cutting water out</b>		
Flow	—	1.1 L/minute (0.3 gallon/minute)
Pressure	345 bar (34,500 kPa / 5,000 psi)	4,140 bar (414,000 kPa / 60,000 psi)
Cut-pressure factory setpoint	—	4,140 bar (414,000 kPa / 60,000 psi)
Pierce-pressure factory setpoint	1,380 bar (138,000 kPa / 20,000 psi)	—
<b>Cooling in and Cooling out</b>		
Flow	11.4 L/minute (3 gallons/minute)	—
Pressure	2.8 bar (280 kPa / 40 psi)	7.6 bar (760 kPa / 110 psi)

# Echion 30

## Dimensions and weights

<b>Length</b>	135 cm (53 in.)
<b>Width</b>	109 cm (43 in.)
<b>Height</b>	101 cm (40 in.)

<b>Shipping weight</b>	900 kg (2,000 lb)
<b>Operating weight</b>	825 kg (1,850 lb)

The shipping weight is for the pump, the pallet, and the packaging. Exact weights are measured at shipment. Operating weight is for an unpackaged pump with hydraulic fluid.

## Electrical

22.4 kW, 30 hp	<b>50 Hz</b>	<b>60 Hz</b>	
<b>Voltage</b>	400 V	208 V to 230 V	460 V
<b>Full-load current</b>	44 A	82 A to 76 A	38 A
<b>Primary circuit breaker rating</b>	60 A	100 A	60 A

## Water

	Minimum	Maximum
<b>Cutting water in</b>		
Flow	4.5 L/minute (1.2 gallons/minute)	—
Pressure	2.8 bar (280 kPa / 40 psi)	7.6 bar (760 kPa / 110 psi)
<b>Cutting water out</b>		
Flow	—	2.3 L/minute (0.6 gallon/minute)
Pressure	345 bar (34,500 kPa / 5,000 psi)	4,140 bar (414,000 kPa / 60,000 psi)
Cut-pressure factory setpoint	—	4,140 bar (414,000 kPa / 60,000 psi)
Pierce-pressure factory setpoint	1,380 bar (138,000 kPa / 20,000 psi)	—
<b>Cooling in and Cooling out</b>		
Flow	11.4 L/minute (3 gallons/minute)	—
Pressure	2.8 bar (280 kPa / 40 psi)	7.6 bar (760 kPa / 110 psi)

## Echion 50

### Dimensions and weights

<b>Length</b>	135 cm (53 in.)	<b>Shipping weight</b>	1,000 kg (2,200 lb)
<b>Width</b>	109 cm (43 in.)	<b>Operating weight</b>	925 kg (2,050 lb)
<b>Height</b>	101 cm (40 in.)		

The shipping weight is for the pump, the pallet, and the packaging. Exact weights are measured at shipment. Operating weight is for an unpackaged pump with hydraulic fluid.

### Electrical

37.3 kW, 50 hp	50 Hz	60 Hz	
<b>Voltage</b>	400 V	208 V to 230 V	460 V
<b>Full-load current</b>	74 A	136 A to 124 A	62 A
<b>Primary circuit breaker rating</b>	100 A	200 A	100 A

### Water

	Minimum	Maximum
<b>Cutting water in</b>		
Flow	7.6 L/minute (2 gallon/minute)	—
Pressure	2.8 bar (280 kPa / 40 psi)	7.6 bar (760 kPa / 110 psi)
<b>Cutting water out</b>		
Flow	—	3.8 L/minute (1 gallon/minute)
Pressure	345 bar (34,500 kPa / 5,000 psi)	4,140 bar (414,000 kPa / 60,000 psi)
Cut-pressure factory setpoint	—	4,140 bar (414,000 kPa / 60,000 psi)
Pierce-pressure factory setpoint	1,380 bar (138,000 kPa / 20,000 psi)	—
<b>Cooling in and Cooling out</b>		
Flow	11.4 L/minute (3 gallons/minute)	—
Pressure	2.8 bar (280 kPa / 40 psi)	7.6 bar (760 kPa / 110 psi)

# Orifices

## US Customary (inches)

Number of orifices	Echion 15	Echion 30	Echion50
1	0.007	0.011	0.014
2	0.005	0.007	0.010
3	0.004	0.006	0.008
4	—	0.005	0.007
5	—	0.004	0.006
6	—	—	0.005

## Stroke rate

The maximum intensifier stroke rate is calculated using the motor wattage and the size of the hydraulic pump.

Echion pump model	Maximum strokes/minute
Echion 15	40
Echion 30	79
Echion 50	107

Default overstroke percentage = 5%  
 Maximum overstroke percentage = 20%

## Torque values



### Fasteners

 <p><b>WARNING</b></p>	Do not use more torque than the values specified in these tables for load-carrying fasteners.
---	---

### End cap fasteners

These torque values are for bolts that are coated with antiseize bolt lubricant (white lithium grease).

	Torque value		Wrench size
	N·m	lbf·ft	
High-pressure end cap nut	375	275	1-1/2-inch socket
Hydraulic end cap screw	90	65	3/8-inch hex

	<p>Tighten each end cap nut in 70 N·m (50 lbf·ft) increments. Use a repeating cross pattern.</p> <div style="text-align: center;">  </div>
--	---

### SAE J518 flange bolts

These torque values are for bolts that are coated in antiseize bolt lubricant (white lithium grease).

1/16-inch dash size	Code 61 grade 8 (low pressure)			Code 62 grade 8 (high pressure)		
	Bolt size (inch)	N·m	lbf·ft	Bolt size (inch)	N·m	lbf·ft
-08	5/16-18	24	18	5/16-18	24	18
-12	3/8-16	43	32	3/8-16	43	32
-16	3/8-16	43	32	7/16-14	70	52
-20	7/16-14	70	52	1/2-13	108	80
-24	1/2-13	108	80	5/8-11	217	160

## Install a flange



### Parts, tools, and materials

Hydraulic fluid

Antiseize bolt lubricant (white lithium grease)

Open-ended wrench (refer to [Wrench size](#) in the table on [page 142](#))

Torque wrench

1. Examine the parts. Look for flaws, deterioration, erosion marks, corrosion, or cracks. Make sure that the mating surfaces are smooth and clean.

If damage is found, replace the component.

2. Put the O-ring in the flange groove.



Lubricate the O-ring with hydraulic fluid before installing it.

3. Put the flange halves together.



To make a good seal, the sealing face must be parallel to the mating surface and the bolt tension must be even. Align the flange face with the mating surface.

4. Lubricate the bolt threads with antiseize bolt lubricant.

5. Put the lock washers on the bolts.

6. Install the bolts.

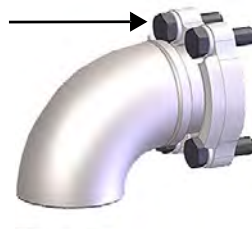

7. Tighten the bolts by hand.

8. Use a torque wrench to tighten the bolts to the specified value.









Tighten each bolt in small increments. Use a repeating cross pattern.



## Fittings

<b>WARNING</b> 	Do not tighten a fitting too much. The fitting can fail.
---	--

### High-pressure water fittings

<b>WARNING</b> 	High-pressure water fittings are designed to make a tight seal. If a fitting is installed incorrectly, it can fail.
<b>CAUTION</b> 	To prevent causing damage or premature failure, use 2 wrenches when loosening or tightening a high-pressure connection.  Always tighten fittings to the specified torque value.
<b>CAUTION</b> 	Do not use an adjustable wrench on high-pressure fittings.
	Use a high-pressure antiseize lubricant such as Blue Goop or PURE Goop on high-pressure water fittings.
	Use only enough torque to make a sufficient seal.  Torque values can vary depending on thread condition. A sufficient seal can be made at values much lower than the maximum values shown in the table.
	If a fitting leaks after tightening it to the maximum torque value, disassemble the parts.  Repair or replace parts that show deterioration, corrosion, or damage.

	Torque value		Wrench size
	N·m	lbf·ft	
<b>Output adapter</b>	102	75	1 inch
<b>High-pressure water fitting (gland nut)</b>			
1/4 inch	34	25	5/8 inch
3/8 inch	68	50	13/16 inch
9/16 inch	150	110	1-3/16 inch

	This table shows maximum values. The torque necessary to make a sufficient seal depends on the condition of the tube threads and can be much lower than the maximum.
---	--



## Install a gland nut



### Parts, tools, and materials

Open-ended wrench (refer to the **Torque value** table on [page 144](#))

Torque wrench

High-pressure antiseize lubricant such as Blue Goop or PURE Goop

- Put high-pressure antiseize lubricant on the gland nut threads, the threads inside the collar, and on the cone and the threads on the high-pressure tube.



1 High-pressure tube

2 Gland nut

3 Collar

- Put the gland nut on the high-pressure tube.

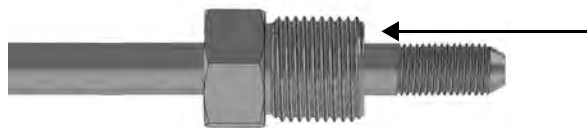

- Put the collar on the high-pressure tube.

Make sure that some of the threads on the high-pressure tubing are visible at the fitting.



Incorrectly installed collar: The collar interferes with the seal surface.



Correctly installed collar: The seal surface is showing.

- Push the high-pressure tube fully into the fitting.
- Tighten the gland nut by hand.
- Use a torque wrench to tighten the gland nut to the specified value.

## Low-pressure water fittings





Do not use lubricants on low-pressure water fittings.

All low-pressure water connections use push-to-connect fittings.

# 7

## **Installation**

	This section assumes that the user is familiar with the <b>Safety</b> , <b>Operation</b> , <b>Preventive maintenance</b> , <b>Troubleshooting</b> , and <b>Specifications</b> sections of this manual.
	Images in this manual are for reference purposes. It is possible that your product configuration is not shown accurately.
	It is possible that not all of the information in this section applies to all pump models.

## Safety

---

**WARNING**

**Read and understand all of the safety guidelines in this manual.**

Before operating, doing maintenance on, repairing, and installing your pump, read the [Safety](#) section, which starts on [page 21](#).

## Buyer responsibilities

---

**WARNING**

This pump can supply water pressure of up to 4,140 bar (414,000 kPa / 60,000 psi).  
Only use tubing that is rated for this pressure.

**WARNING**





Use supports for plumbing to prevent damage to plumbing from bending stress and fatigue from vibration.

The buyer is responsible for these obligations.

- Cooperate with Hypertherm and the Hypertherm original equipment manufacturer (OEM) regarding the installation of the equipment.
- Obey all setup and first-time start up instructions in this manual.
- Research and obey all local codes, including requirements for waste water disposal.
- Install high-pressure tubing.
- Install water-treatment equipment before the pump is installed.
- Make sure that all utilities are available during installation.
- The site must have sufficient electrical power, air, water, and drain access.
- Make all connections to the pump.
- Fill the hydraulic fluid tank.
- Perform user qualification and training. Refer to [User qualification and training](#) on page 23.

## Requirements

### Location

<p><b>WARNING</b></p> 	<p>Some locations can be dangerous if the atmosphere contains explosive gas, vapors, or dust. Refer to requirements from the National Electric Code (NEC), the International Electrotechnical Commission (IEC), the Occupational Safety and Health Administration (OSHA), and other national and local codes for information about environmental criteria.</p>
	<p>Make sure that there is a minimum clearance of 91 cm (36 inches) on all sides of the equipment. This lets air movement help cool the machine and keeps space available for doing maintenance and repairs.</p>
	<p>Do not install this equipment in an area where the temperature is below freezing. Freezing can cause damage to the pump.</p>

Install the pump on a solid, flat surface that can hold the weight of the equipment and is thick enough to resist vibration.

Make sure that there is sufficient space for auxiliary equipment such as a water softener, a reverse osmosis system, or a chiller.

High altitude or ambient conditions can have an effect on the temperature of hydraulic fluid. Fluid that is too cool is thick, which causes increased friction and poor lubrication. Fluid that is too hot is thin, which can accelerate wear on the parts, increase the formation of sludge, degrade the fluid, and decrease its lubrication and protective qualities.

Refer to [Environmental conditions](#) on page 136 for air temperature and humidity specifications.

### Cooling

	<p>If this pump is installed in a small space or in a high-temperature location, consider adding a chiller to the system for supplemental cooling. Use the <a href="#">Cooling</a> table on <a href="#">page 137</a> to calculate the cooling load.</p>
---	---

If the supply-water temperature is higher than 24°C (75°F), cool the water before use. Water that is too warm can shorten high-pressure seal life.

### Hydraulic fluid

	<p>Hypertherm does not ship all pumps with hydraulic fluid in the tank.</p>
---	---

Refer to [Hydraulic fluid](#) on page 136 for specifications.

## Utilities



Refer to [Utilities](#) on page 137 for system specifications.

### Electrical power

**WARNING**



A line disconnect switch for incoming electrical power must be installed near the power supply.

This is a supply-voltage disconnecting device or an energy-isolating device.

**CAUTION**



The primary feed circuit breaker or fuse must be the correct size to control inrush and steady-state current.

Use a motor-start circuit breaker or an equivalent if time-delay high-inrush fuses are not permitted by national or local codes.

### Compressed air

The bleed-down valve uses compressed air to operate.

### Supply water



Local codes can require a backflow prevention valve to separate the pump from the facility's potable water.

### Water quality

The quality of the water supplied to the intensifier has a direct effect on the life of the intensifier and consumables.



Bad water quality increases operating costs by causing unnecessary wear on pump parts and shortening maintenance intervals.

Before installing this equipment, test the supply water.



Water quality reports that show pH, silica, and hardness levels are frequently available for no charge from public utility water suppliers.



## Receive and unpack the equipment

<b>WARNING</b>	Lifting must be done by a trained operator.
	Obey all work site safety requirements, the safety instructions for the lifting equipment, and the safety information in this manual.
	For easy reference, write your pump information on the Pump information page at the back of this manual.
	Boxes and parts are frequently packed in the pump, or in crates, boxes, and packaging. Look for accessories and spare parts before discarding the packaging.

1. Examine containers, crates, and pallets for damage.
2. Remove the equipment from the shipping crates and pallets.
3. Examine the equipment to make sure that it was not damaged during shipping. If the equipment is damaged, a claim must be filed with the carrier.
4. Make sure that the delivery and shipping documents match the equipment that was ordered and what was received. Report shortages or damages to the OEM or to Hypertherm Waterjet within 10 days of receipt of the equipment.
5. Make sure that these items are included with the pump.
  - Dirty water container
  - [Intensifier repair tools](#), refer to [page 99](#)
  - These items are shipped inside the electrical enclosure:
    - key for the Local/Remote key switch
    - MicroSD card adapter
    - electrical drawings
  - Optional items
    - [1-18768 Standard tool kit](#), refer to [page 98](#)
    - [1-18769 Echion standard spare parts kit](#), refer to [page 100](#)
    - [Optional equipment kits](#), refer to [page 103](#)

## Install the pump

---

<b>CAUTION</b> 	Hydraulic, water, and electrical connections can become loose during shipping and normal operation. Examine all connections at installation and during regular maintenance.
	To connect the pump directly to an external control device, such as a CNC, refer to the CNC manual and contact your OEM or a Hypertherm Technical Service Associate for information and support.
	These instructions are for a typical installation. It could be necessary to install the components in a different order.

Install the pump in a location that agrees with the requirements and recommendations for this equipment. Refer to [Specifications](#), which starts on [page 135](#).



Hypertherm recommends installing the Echion pump on a level surface with a difference in height of no more than 8 cm (1/4 inch) between opposite ends.



## Install the pump-mounted plumbing kit (optional)



Refer to [Fittings](#) on page 144 for torque values and information about how to correctly install high-pressure water fittings.

The plumbing kit makes installing high-pressure tubing from the pump to the cutting table easier.



The reducing adapter for this kit changes the 3/8-inch high-pressure connection to 1/4 inch.

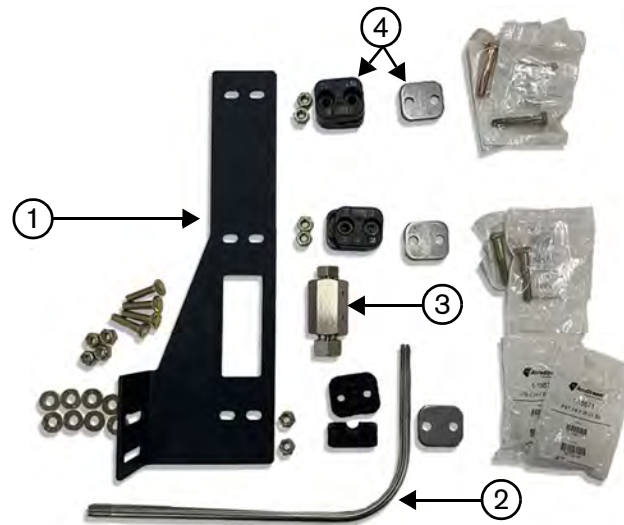

- |   |                 |   |  |
|---|-----------------|---|--|
| 1 | Tubing bracket  | 3 | Reducing adapter, 3/8-inch to 1/4-inch |
| 2 | L-shaped tubing | 4 | Clamp                                  |



### Parts, tools, and materials

#### [1-18695 Pump-mounted plumbing kit](#)

Two 1/16-inch open-ended wrenches

5/8-inch open-ended wrench

1-1/16-inch open-ended wrench

13/16-inch open-ended wrench

5/8-inch crowfoot wrench

13/16-inch crowfoot wrench

Torque wrench

High-pressure antiseize lubricant such as Blue Goop or PURE Goop

## 7 Installation

1. Find the mounting holes for the plumbing kit on the right side of the pump.



2. Use two 7/16-inch open-ended wrenches and hardware from the kit to install the tubing bracket on the pump frame.

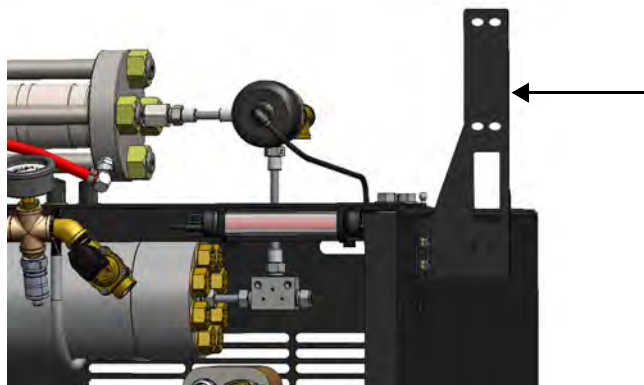

3. Use a 1-1/16-inch open-ended wrench to hold the high-pressure tee on the attenuator. Use a 13/16-inch open-ended wrench to install the long end of the L-shaped tubing into the fitting.

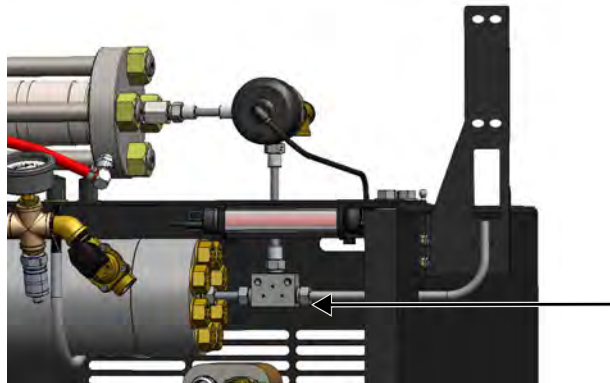



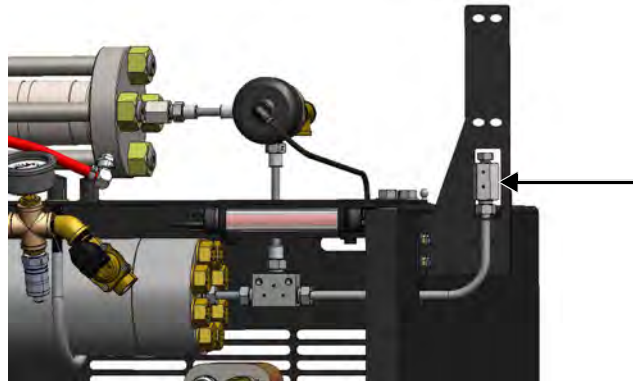

4. Use a 13/16-inch open-ended wrench to install the reducing adapter on the short end of the L-shaped tubing. Use a torque wrench to tighten the fitting to 70 N·m (50 lbf·ft).

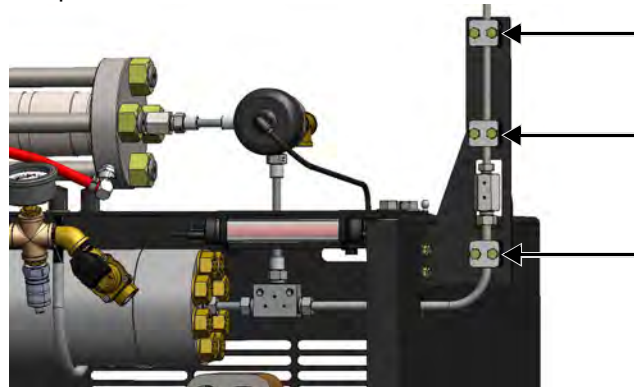

5. Use a 5/8-inch open-ended wrench to install your 1/4-inch high-pressure tubing from the cutting head into the top of the reducing adapter. Use a torque wrench to tighten the fitting to 34 N·m (25 lbf·ft).
6. Use two 7/16-inch open-ended wrenches and hardware from the kit to attach the tubing to the tubing bracket with the clamps.



## Connect the utilities to the pump

<p><b>CAUTION</b></p> 	<p>Compressed air is an energy source that can eject with force. Be careful when connecting to and disconnecting from this energy source.</p>
<p><b>CAUTION</b></p> 	<p style="text-align: center;"><b>WATER-COOLED SYSTEM</b></p> <p>Do not connect the <b>Waste water out</b> hose and the <b>Cooling out</b> line together. Connecting these hoses can cause cooling water to back up into the system, which can cause damage to the bleed-down valve and intensifier parts.</p>
<p><b>CAUTION</b></p> 	<p>To prevent dirty water from entering the bleed-down valve, install the <b>Waste water out</b> hose so that it is below the bleed-down valve.</p>
	<p>Refer to <a href="#">Fittings</a> on page 144 for torque values and information about how to correctly install high-pressure water fittings.</p>

The utility connections are identified with hang tags. The tags have symbols on them that correspond with the table on [page 157](#).



### Parts, tools, and materials

9/16-inch open-ended wrench	1/8-inch NPT male fitting
13/16-inch open-ended wrench	3/8-inch high-pressure male fitting
1-1/16-inch open-ended wrench	Two 1/2-inch NPT male fittings
Torque wrench	
High-pressure antiseize lubricant such as Blue Goop or PURE Goop	

### Water-cooled system

1-inch open-ended wrench	Two 1/2-inch NPT male fittings
1-3/16-inch open-ended wrench	







1. Remove the top cover and the front panel. Refer to [Prepare the pump](#) on page 39 for instructions.
2. Remove the caps from the fittings and the plugs from the utility connections.

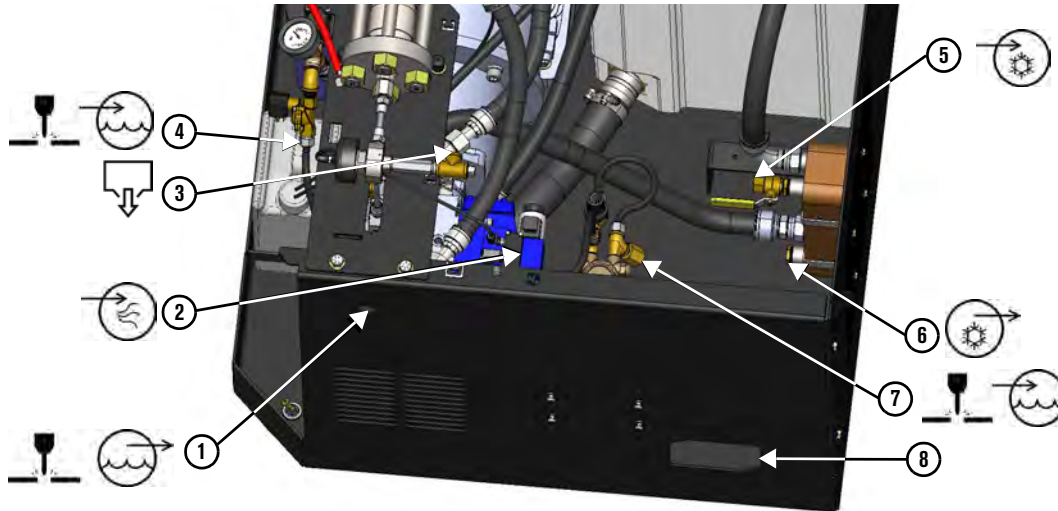

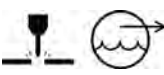

Keep the caps and the plugs to use if the pump is stored or shipped.

## Connect the water and the air





Name of connection and symbol on tag	
<ul style="list-style-type: none"> <li>Factory-installed connection</li> </ul>	<ul style="list-style-type: none"> <li>Fitting required (not included)</li> </ul>
 <p><b>Cutting water out</b></p> <p>This tubing carries high-pressure water from the intensifier to the cutting table.</p> <ul style="list-style-type: none"> <li>3/8-inch high-pressure female</li> </ul>	<p>Connect 1 end of the high-pressure tubing to the cutting head.</p> <p>Put the other end of the tubing through the hose access hole ① on the side of the pump.</p> <p>Connect the tubing to the high-pressure tee inside the pump frame.</p> <ul style="list-style-type: none"> <li>3/8-inch high-pressure male</li> </ul>
<p>Put the other utility hoses and lines into the pump through the larger cutout ⑧.</p>	
 <p><b>Cutting water in</b></p> <p>This line carries low-pressure water from a water softener, a reverse osmosis system, a well, or a public utility to the pump.</p> <ul style="list-style-type: none"> <li>1/2-inch NPT female</li> </ul>	<p>Connect 1 end of this line to the supply water.</p> <p>Connect the other end to the inlet-water solenoid ④ or to the boost pump ⑦, if equipped.</p> <p> All low-pressure water connections use push-to-connect fittings.</p> <ul style="list-style-type: none"> <li>1/2-inch NPT male</li> </ul>
 <p><b>Waste water out</b></p> <p>This hose carries water from the bleed-down valve to a drain.</p> <ul style="list-style-type: none"> <li>1/2-inch NPT female</li> </ul>	<p>Connect 1 end of this hose to the drain.</p> <p>Connect the other end to the brass tee ③ on the bleed-down valve assembly.</p> <p> To make maintenance of the bleed-down valve easier, make this connection easy to remove.</p> <ul style="list-style-type: none"> <li>1/2-inch NPT male</li> </ul>
 <p><b>Compressed air</b></p> <p>The bleed-down valve uses compressed air to operate.</p> <ul style="list-style-type: none"> <li>1/8-inch NPT female</li> </ul>	<p>Connect a compressed air hose to the solenoid valve ② mounted to the frame near the bleed-down valve.</p> <ul style="list-style-type: none"> <li>1/8-inch NPT male</li> </ul>

### Water-cooled system

 <p><b>Cooling in</b></p> <p>This line carries low-pressure water from the local utility or a chiller to the pump's cooling loop.</p> <ul style="list-style-type: none"> <li>• 1/2-inch NPT female</li> </ul>	<p>Connect 1 end of this line to the supply water or to the chiller.</p> <p>Connect the other end to the ball valve at the heat exchanger inlet ⑤.</p> <ul style="list-style-type: none"> <li>• 1/2-inch NPT male</li> </ul>
 <p><b>Cooling out</b></p> <p>This line carries low-pressure water from the heat exchanger to the chiller or to the drain.</p> <ul style="list-style-type: none"> <li>• 1/2-inch NPT female</li> </ul>	<p>Connect 1 end of this line to the to the chiller or to the drain.</p> <p>Connect the other end to the heat exchanger outlet ⑥.</p> <ul style="list-style-type: none"> <li>• 1/2-inch NPT male</li> </ul>

### Connect the electrical power

<p><b>CAUTION</b></p> 	<p>This waterjet pump can leak up to 160 mA.</p> <p>To reduce the effects of a high leakage current, connect the pump to a dedicated supply transformer that has separate windings.</p>
	<p>Use electrical parts that are certified by national or local electrical codes.</p>
	<p>Hydraulic, water, and electrical connections can become loose during shipping and normal operation.</p> <p>Examine all connections at installation and during regular maintenance.</p>

1. Attach a ground leg to the grounding lug in the electrical enclosure.

Use this table to find the minimum cross-sectional area of the external copper ground leg.

If the cross-sectional area ( $S$ mm <sup>2</sup> ) of the copper phase conductors supplying the equipment is	The minimum cross-sectional area ( $S_p$ mm <sup>2</sup> ) is
equal to or higher than 16	equal to $S$
higher than 16 and lower than or equal to 35	16
higher than 35	$S/2$

2. Connect electrical power to the primary circuit breaker. The breaker is labeled on the technical drawing and in the electrical enclosure as CB-1.

## Examine the hydraulic fluid

**CAUTION**

Make sure that hydraulic fluid is available during installation and for the first start.

Make sure that the hydraulic fluid level is at the top mark on the sight gauge. Add hydraulic fluid, if necessary. Refer to [Add hydraulic fluid](#) on page 85 for instructions.

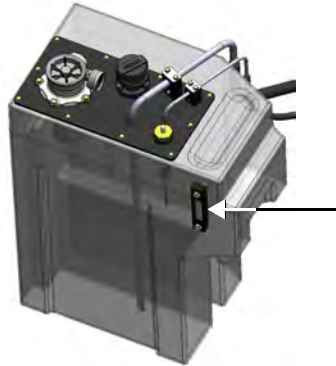

## Do the first start

**CAUTION**

If a water line, a fitting, or a valve could be frozen, do not operate the pump. Thaw the equipment until water moves easily through the system.

Examine the parts for damage. Replace parts, if necessary.

**CAUTION**

This procedure could cause damage to the orifice.

Do not do the first start with a diamond orifice installed. Hypertherm recommends using a ruby orifice during the first 40 hours of operation.

Use this procedure:

- at installation.
- when putting the equipment into operation after storage or shipping.
- after maintenance or repairs are done on the intensifier, the high-pressure water system, or the low-pressure water system.

## Do a preoperation inspection

**WARNING**

Make sure that all connections, fasteners, locking devices, hoses, and fittings are tight.

- Look for leaks, deterioration, damage, or other conditions that can interfere with operation.
- Make sure that the hydraulic fluid level is at the top mark on the sight gauge. Add hydraulic fluid, if necessary.
- Make sure that all warning decals are visible and legible.

## Turn on the utilities

**CAUTION**

A leak can cause damage to the water fittings.

Monitor for leaks during this procedure.

Identify the source of a leak and correct the problem.

1. Turn **ON** the utility water to the pump.
2. Turn **ON** the compressed air source. Set the air pressure between 4.8 bar and 5.5 bar (70 psi and 80 psi).

**CAUTION**



Air pressure that is too low can prevent the bleed-down valve from closing and can cause the intensifier to overstroke.



Air pressure that is too high can cause damage to the needle and the seat in the bleed-down valve. If the available air pressure is too high, install an air regulator (not included) to reduce the pressure.

3. Turn **ON** the electrical main (line disconnect switch).
4. Turn the primary breaker disconnect lever on the electrical enclosure door to **ON**.
5. Make sure that the EMERGENCY STOP is not engaged. If the button is pushed in, turn the button clockwise until it releases.



## Make sure that the primary motor turns in the correct direction

<p><b>WARNING</b></p> 	<p>It is necessary to have access to a turning shaft for this procedure. Do not put an object or a body part near the shaft while the access cover is off.</p>
<p><b>CAUTION</b></p> 	<p>Make sure that the primary motor turns in the correct direction before starting the pump. If the motor turns in the opposite direction, the impeller could turn and loosen. This can cause damage to the hydraulic pump.</p>

1. Make sure that the key switch is set to Local .
2. Remove the shaft access cover.
3. Push the Controls button to turn **ON** the control circuit in the pump.
4. Touch the  symbol to turn **ON** the pump momentarily. Make sure that the primary motor turns in the direction shown by the rotation arrow.
5. Touch the  symbol to turn **OFF** the pump.

If the pump motor turned in the wrong direction:

- a. Turn the primary breaker disconnect lever on the electrical enclosure door to **OFF**.
- b. Turn **OFF** the electrical main (line disconnect switch). Use standard lock out–tag out procedures.
- c. Inside the electrical enclosure, interchange 2 cables on the top of the primary circuit breaker.

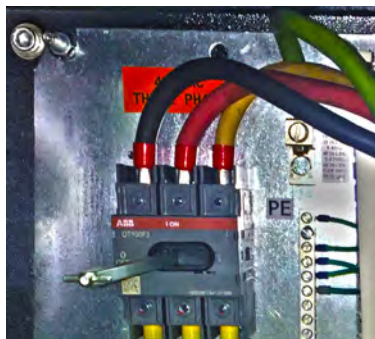

- d. Turn **ON** the electrical main (line disconnect switch).
  - e. Turn the primary breaker disconnect lever on the electrical enclosure door to **ON**.
  - f. Do [step 3](#) through [step 4](#) again. Make sure that the primary motor turns in the direction shown by the rotation arrow.
6. Install the shaft access cover.

## Turn on the pump

**CAUTION**



A leak can cause damage to the water fittings.  
Identify the source of a leak and correct the problem.

1. Set the pressure to 345 bar (5,000 psi).
2. On the operator interface, touch the  symbol to turn **ON** the pump.
3. Let the pump operate for 2 to 3 minutes.
4. Monitor for leaks.

## Adjust the boost pump pressure

**CAUTION**



Do not set the boost pump pressure higher than 7.6 bar (760 kPa / 110 psi). The components are rated for a maximum of 8.6 bar (860 kPa / 125 psi).

Pressure that is too high can cause damage to the components.



If the supply-water is from a reverse osmosis system, contact a Hypertherm Technical Service Associate for information and support.

1. Make sure that the value on the prefilter water-pressure gauge is between 6.9 bar and 7.6 bar (690 kPa and 760 kPa / 100 psi and 110 psi).



1 Postfilter water-pressure gauge

2 Prefilter water-pressure gauge

If the pressure is not in range:

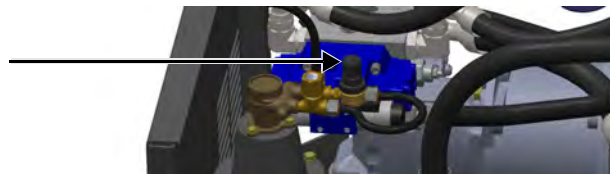

- a. Pull the boost pump adjustment knob out.





- b. Turn the knob clockwise to increase the pressure. Turn the knob counterclockwise to decrease the pressure.
- c. Push the knob in to lock it.

2. Close all doors and replace all panels and covers, including the top cover.

## Flush the pump and the high-pressure tubing



<p><b>CAUTION</b></p> 	<p>This procedure can cause damage to the on/off valve needle and the seat and to the orifice. Keep spare parts and orifices available.</p>
	<p>If this pump was purchased through an OEM, the OEM could recommend a different procedure to flush out the high-pressure tubing.</p>

It is common for small pieces of metal and debris to be present in newly installed high-pressure tubing. Flush the system to prevent damage to orifices, on/off valve parts, and other components of the high-pressure system.

1. Remove the cutting head and the orifice.
2. Make sure that the on/off valve is closed.
3. Turn **ON** the pump.
4. Set the pressure to 345 bar (5,000 psi).
5. On the operator interface, touch the  symbol to turn **ON** the pump.
6. Make a program that turns the valve **ON** and **OFF** in 1-second increments. Operate the program in a loop for 15 minutes.  
If a program is not available, turn the cutting head **ON** and **OFF** in 1-second intervals for 15 minutes. This loosens debris in the high-pressure tubing.
7. Turn **OFF** the pump.
8. Install a ruby orifice in the cutting head. For orifice sizes, refer to [Orifices](#) on page 141.
9. Turn **ON** the pump.
10. On the operator interface, touch the  symbol to turn **ON** the pump.
11. Increase the pressure to 2,760 bar (40,000 psi). Operate the program in a loop for 15 minutes.
12. Increase the pressure to 4,140 bar (60,000 psi). Operate the program in a loop for 15 minutes.  
If the on/off valve leaks, examine the needle, the seat, the seals, and the orifice for damage. Replace parts, if necessary.

The pump is ready for normal operation.

## Operator interface: Adjustment screens

	Not all screens are used when installing the pump.
	Touch the current screen symbol to go back 1 screen.
	Refer to <a href="#">Touchscreen maps</a> on page 175 to see all of the screens available on the controller.

The adjustment screens on the operator interface let the user change the system configuration.

On the operator interface, touch the adjustments tab to open the primary adjustments screen.

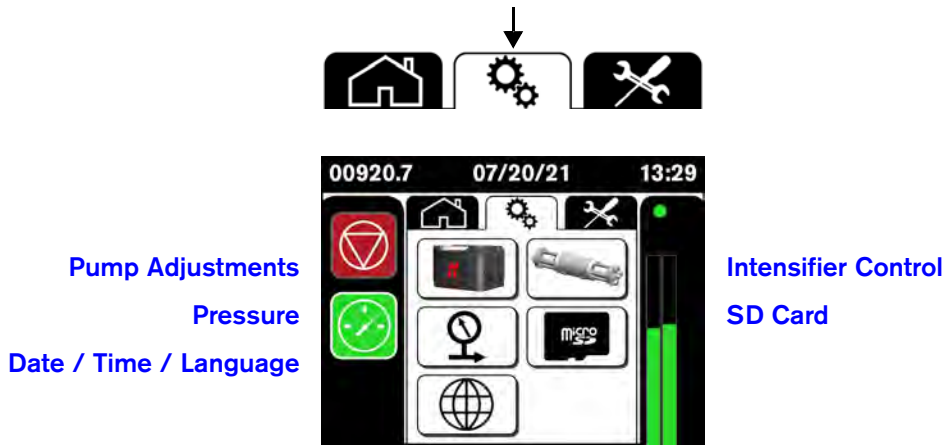

### Pump Adjustments

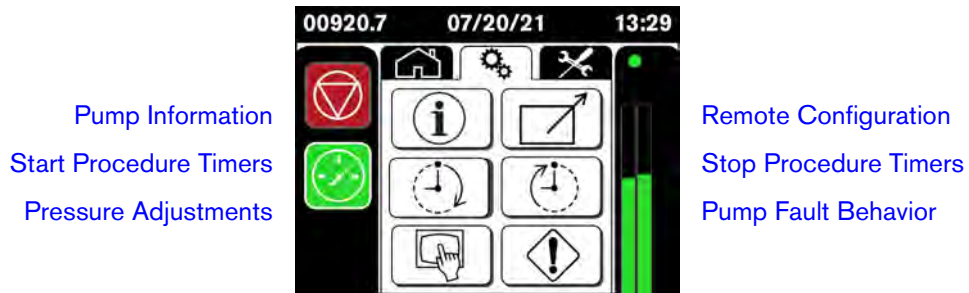

## Pump Information

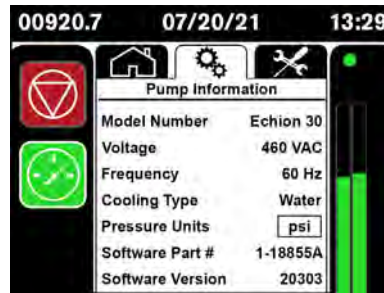

<b>Model Number</b>	This is the model number of the pump.
<b>Voltage</b>	This is the line voltage of the pump
<b>Frequency</b>	This is the line voltage frequency of the pump.
<b>Cooling Type</b>	This the type of heat exchanger the pump uses (water or air).
<b>Pressure Units</b>	<ul style="list-style-type: none"> <li>▪ Touch this field to open a numeric keypad.</li> <li>▪ Touch the up or down arrows to select the units (bar or psi) that show on the operator interface screens.</li> </ul>
<b>Software Part #</b>	This is the Hypertherm part number and the revision version for the software installed on the controller.
<b>Software Version</b>	This is the version of the software on the controller.

### Start Procedure Timers





All time is in seconds. Refer to [page 179](#) for information about the start procedure.

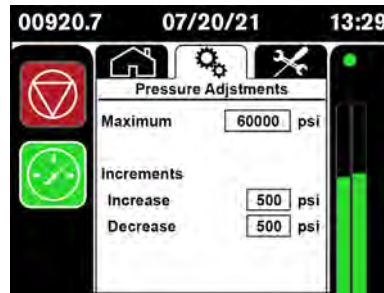
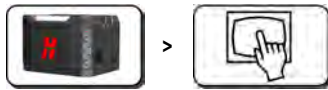

<b>Ramp Time</b>	<p>This is the time that the system takes to increase the high-pressure water pressure from 0 to the target water pressure.</p> <p>Increase the value to slow the process.</p> <p>The timer default is between 3 seconds and 8 seconds, based on the pump model.</p>
<b>Intensifier</b>	<p>The system goes to the next stage when the time between intensifier strokes is longer than this value.</p> <p>The timer default is 1.5 seconds.</p>
<b>Inlet Water</b>	<p>Stage 1</p> <p>After the system gets to the target water pressure, the Inlet Water timer starts.</p> <p>The timer default is 5 seconds.</p>
<b>Bleed Valve</b>	<p>Stage 2</p> <p>The intensifier strokes and has this much time to push air that is in the system out through the open bleed-down valve.</p> <p>The timer default is 5 seconds.</p>
<b>Hydraulics</b>	<p>Stage 3</p> <p>After the bleed-down valve closes, the system has this much time to get to the minimum hydraulic pressure.</p> <p>The timer default is 5 seconds.</p> <p>The hydraulic pressure setpoint default is 17 bar (250 psi).</p> <p>Refer to the <a href="#">Hydraulic fluid</a> table in the <a href="#">Specifications</a> section.</p>
<b>Pierce</b>	<p>Stage 4</p> <p>The system has this much time to get to the pierce-pressure setpoint.</p> <p>The timer default is 5 seconds.</p> <p>Refer to the <a href="#">Water</a> table for your pump model in the <a href="#">Specifications</a> section.</p>
<b>Cut</b>	<p>Stage 5</p> <p>If the pump is in cut-pressure mode, the system has this much time to get to the cut-pressure setpoint.</p> <p>The timer default is 5 seconds.</p> <p>Refer to the <a href="#">Water</a> table for your pump model in the <a href="#">Specifications</a> section.</p>

### Pressure Adjustments



<b>Maximum</b>	This is the maximum pressure that the system can be adjusted to. The default is 4,140 bar (60,000 psi).
<b>Increments</b>	
<b>Increase</b>	This is how much the target water pressure increases each time you touch the  symbol on the primary operation screen. The default is 34 bar (500 psi). The smallest increment is 10 bar (100 psi).
<b>Decrease</b>	This is how much that the target water pressure decreases each time you touch the  symbol on the primary operation screen. The default is 34 bar (500 psi).

### Remote Configuration

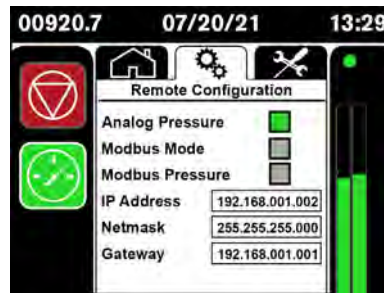
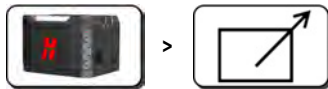

<b>Analog Pressure</b>	This turns the remote analog pressure input on or off.
<b>Modbus Mode</b>	This turns Modbus mode on or off. When this mode is on, the pump is controlled by Modbus TCP over Ethernet.
<b>Modbus Pressure</b>	This turns Modbus control of the pump pressure on or off.
<b>IP Address</b>	Enter a static IP address.
<b>Netmask</b>	Enter the netmask.
<b>Gateway</b>	Enter the gateway.

Installation

### Stop Procedure Timers



The pump is idle when the intensifier stops stroking.

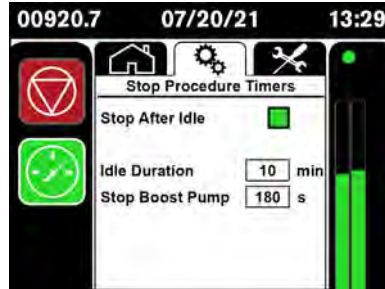

<b>Stop After Idle</b>	When this feature is on, the pump turns off after the idle duration timer expires.
<b>Idle Duration</b>	This timer determines how long the pump is idle before it turns off. The default is 10 minutes.
<b>Stop Boost Pump</b>	This timer determines how long the pump is idle before the boost pump turns off. The default is 180 seconds.

### Pump Fault Behavior



<b>Boost Fault Monitor</b>	The system can monitor a boost pump for fault conditions. This turns monitoring on or off.
<b>Fan Fault Monitor</b>	The system can monitor a heat exchanger for fault conditions. This turns monitoring on or off.



## Pressure



### Hydraulic

<b>Actual</b>	This shows the hydraulic pressure in the system.
---------------	--

## Date / Time / Language



Change the time, and language that shows on the operator interface.



	<p><b>Date symbol and field</b></p> <p>Touch this symbol to change the date format. Options are DD-MM-YY or MM/DD/YY.</p> <p>Touch the field next to the symbol to open a numeric keypad. Use the keypad to adjust the date.</p>
	<p><b>Time symbol and field</b></p> <p>Touch this symbol to change the time format. Options are a 12-hour clock or a 24-hour clock.</p> <p>Touch the field next to the symbol to open a numeric keypad. Use the keypad to adjust the time.</p>
	<p><b>Language field</b></p> <p>Touch the field next to this symbol to open a numeric keypad. Use the keypad to change the language.</p>

## Intensifier Control

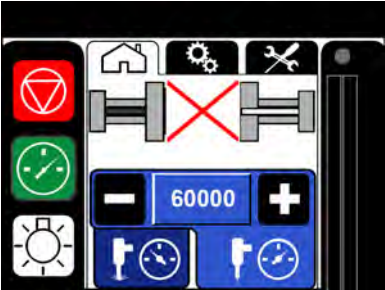

<p><b>Intensifier On</b></p>	<p>This enables and disables the intensifier.</p> <p>When intensifier control is off:</p> <ul style="list-style-type: none"> <li>▪ the <b>Intensifier On</b> box is gray.</li> <li>▪ the primary screen shows a red x on the intensifier symbol.</li> </ul> 
<p><b>Percent</b></p>	<p>Overstroke percent is the increased stroke rate that is permitted before an overstroke fault condition occurs. The maximum intensifier stroke rate is calculated using the motor wattage and the size of the hydraulic pump. Refer to <a href="#">Stroke rate</a> on page 141. The rate can be adjusted to compensate for variations in plumbing configurations and flow rates.</p> <ol style="list-style-type: none"> <li>1. Touch this field to open a numeric keypad.</li> <li>2. Use the keypad to enter the maximum overstroke percentage permitted before a fault occurs. The default is 5%. The maximum is 20%.</li> <li>3. Touch <b>Enter</b>.</li> </ol>
<p><b>Total Hours</b></p>	<p>This shows the total hours that the intensifier has been in operation.</p>
<p><b>Strokes</b></p>	<p>This shows the total number of strokes on the intensifier. A stroke is counted each time a proximity switch is activated.</p>

## SD Card



The microSD card stores the current program, the alarm log files, and the maintenance log.



Touch the microSD card symbol to see the contents of the card.

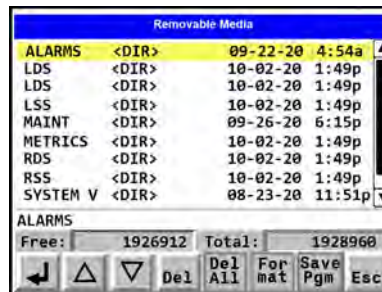

If the microSD card is missing or damaged, the screen shows **SD Card Not Found**.

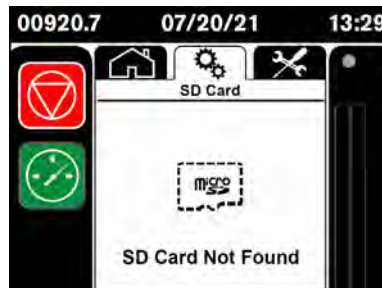



# 8

## ***Declaration of Conformity***

To see the Declaration of Conformity in English and other languages:

1. Go to [www.hypertherm.com/docs](http://www.hypertherm.com/docs).
2. Under Select your product, choose **Waterjet Family** in the dropdown list.
3. Go to the **Regulatory information section** and click the **+**.
4. Click on the Declaration of Conformity for your product.



You might have to click on **SHOW ALL** at the bottom of the section.

A PDF of the document downloads to your device.

These navigation instructions can change without notice.



For information about this document, refer to [page 14](#).



## MANUFACTURER'S DECLARATION OF CONFORMITY

Declaration of conformity (DOC) applies to the following Echion Waterjet Pump Models based on testing performed on model Echion™ 50:

Echion 15

Echion 30

Echion 50

Date of first fixing of CE marking (DOC issued): 06-MAR-2020

Date of this DOC: 06-MAR-2020

The undersigned official of the company hereby declares, on behalf of Hypertherm Waterjet Business Team, that model units with CE Marking on the data plate meet the essential requirements of the following EU Directives:

2006/42/EC Machinery Directive

2014/30/EU Electromagnetic Compatibility Directive

Using the relevant sections of the following EU standards and other normative documents:

2014/30/EU:

EN 61000-6-2: 2005/AC: 2005

EN 55011:2009+A1:2010, Group 1 Class A Limit

2006/42/EC

EN/IEC 60204-1:2018+A1:2009

ANSI / ISO 12100:2012

EN 1829-1:2010

Sara Mancell, Business Team Leader – Waterjet

Note 1: The Technical Construction File including the test reports and other information required by these EU Directives is maintained at the above address.

Note 2: This DOC is not valid on units without CE Marking on the data plate.

Note 3: For European customer inquiries, contact Arne van der Boon, European Customer Service Hypertherm Europe B.V. Vaartveld 9 4704 SE, Roosendaal, The Netherlands Telephone +31(0)165 596907

# 9

## ***Touchscreen maps***

### **In this section**

These pages can help you navigate through all of the screens that are on the operator interface.





# Primary operation screen



Refer to [Operator interface: Primary operation screen](#) on page 37 for more information about these screens.



Pierce-pressure mode

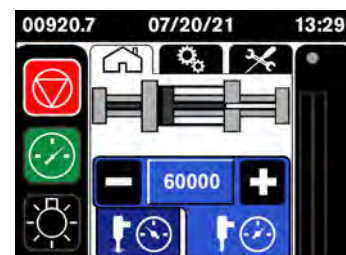

Cut-pressure mode

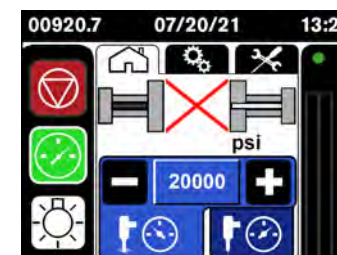

The intensifier is disabled.  
Refer to [Intensifier Control](#) on page 170.

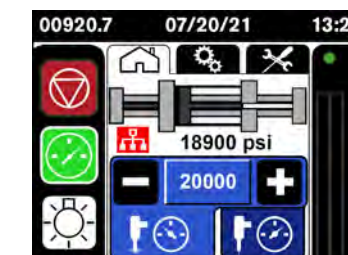

Modbus mode is enabled.  
Refer to [Remote Configuration](#) on page 167.



Push the Controls button to turn **ON** the control circuit in the pump.

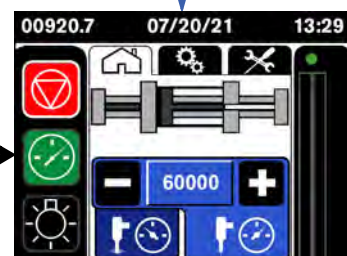

Touch the Start symbol to turn **ON** the pump.

Go to [page 179](#).

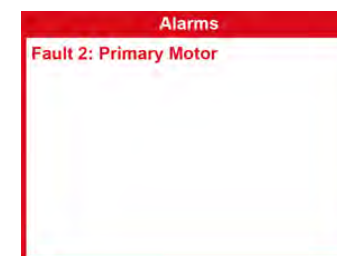

Refer to [Alarms](#) on page 114.







**i** The start procedure timers are adjustable. Refer to [Start Procedure Timers](#) on page 166 for instructions.

**Stage 1**

The supply-water pressure increases.

- The primary motor starts.
- The hydraulic pump operates at minimum pressure until stage 4.
- After the system gets to the target water pressure, the Inlet Water timer starts. The timer default is 5 seconds.

**Stage 2**

Air is removed from the system.

- The intensifier starts stroking.
- The Bleed Valve timer starts. The timer default is 5 seconds.

**Stage 3**

The system fills with water.

- The bleed-down valve closes.
- Pressure in the system increases to the hydraulic pressure setpoint.
- The Hydraulics timer starts. The timer default is 5 seconds.

**Stage 4**

The pressure increases to the pierce-pressure setpoint

- Water pressure in the system increases to the pierce-pressure setpoint.
- The Pierce timer starts. The timer default is 5 seconds.

**If the pump is in pierce-pressure mode, the start procedure is complete.**

**Stage 5**

The pressure increases to the cut-pressure setpoint.

- If the pump is in cut-pressure mode, water pressure in the system increases to the cut-pressure setpoint.
- The Cut timer starts. The timer default is 5 seconds.

**The start procedure is complete.**

**The pump is at operating pressure and is ready to use.**



# Adjustment screens



Refer to [Operator interface: Adjustment screens](#) on page 164 for more information about these screens.

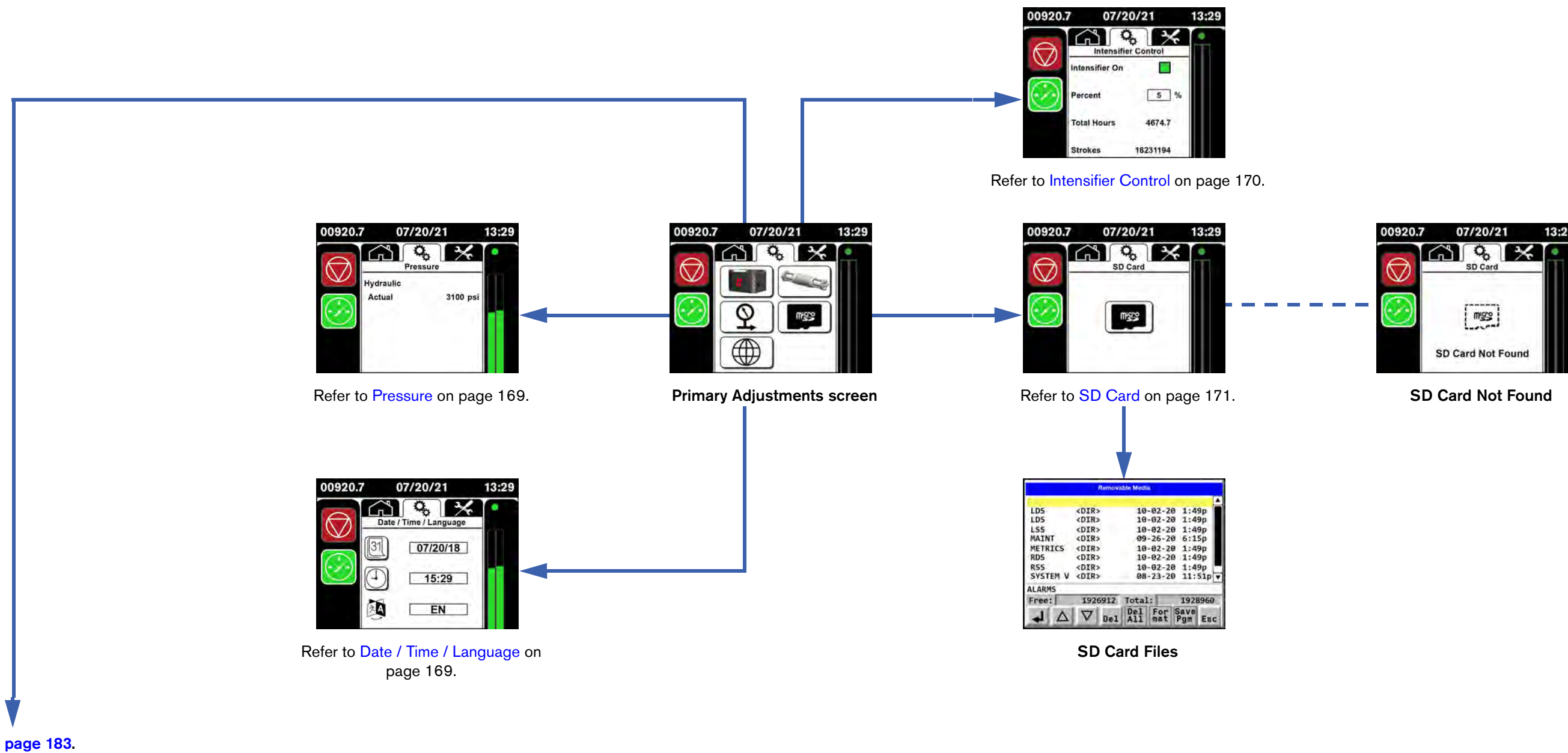



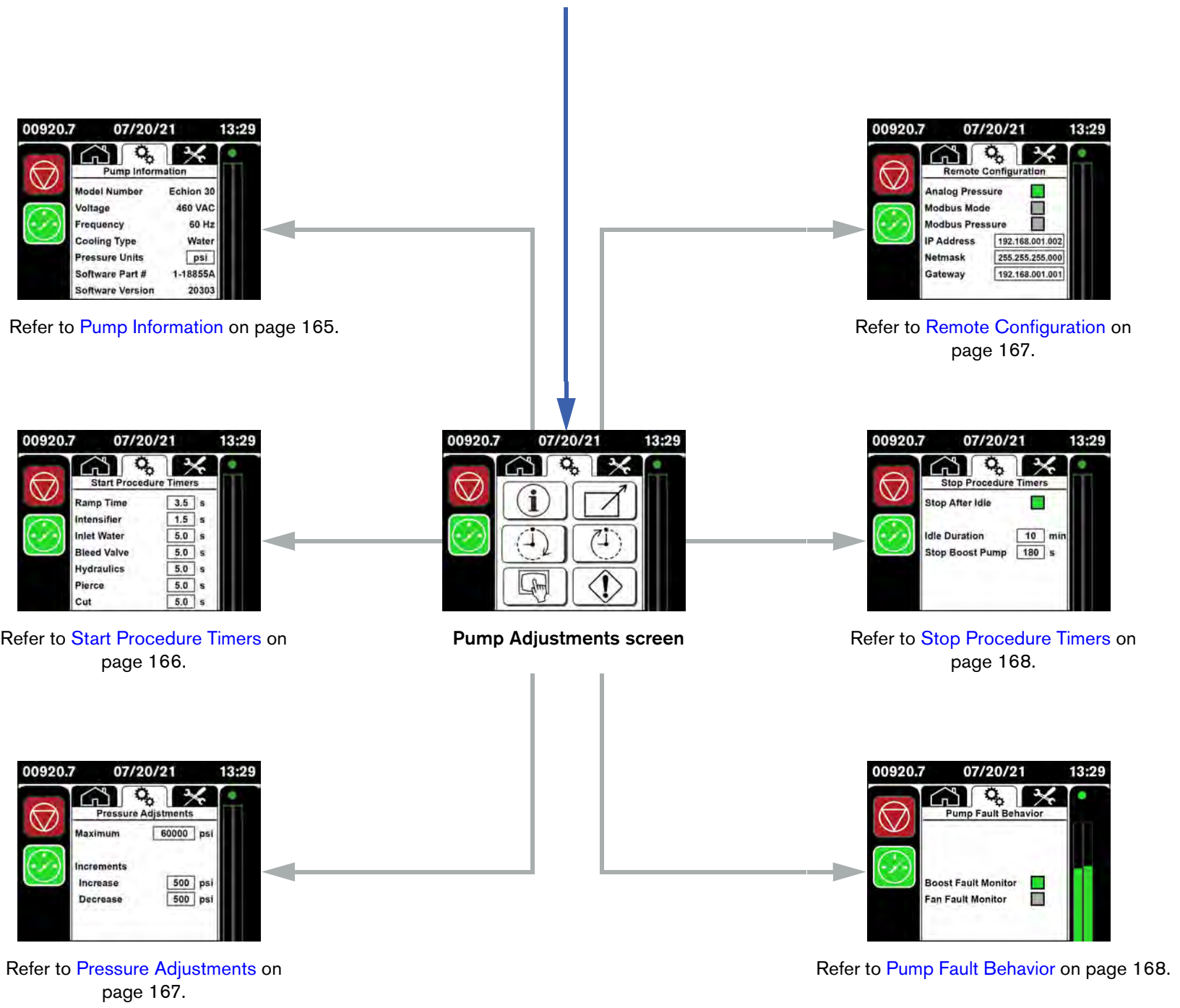





# Maintenance screens



Refer to [Intensifier maintenance](#) on page 60 for more information about these screens.



Refer to [Move the plunger](#) on page 54.

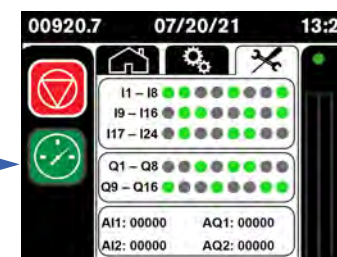

Refer to [Inputs and outputs](#) on page 56.

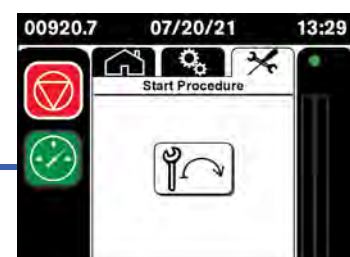

**Postmaintenance Start Procedure**  
Refer to [Start the pump after maintenance](#) on page 90.

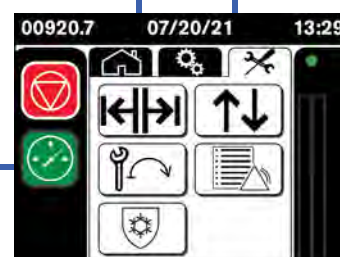

**Primary Maintenance screen**

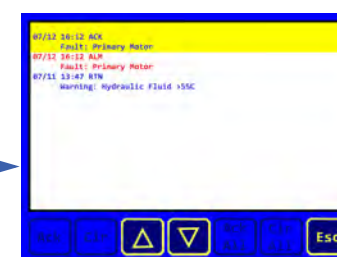

**Alarm Log**  
Refer to [Alarms](#) on page 114.



Refer to [Prepare for storage](#) on page 55.

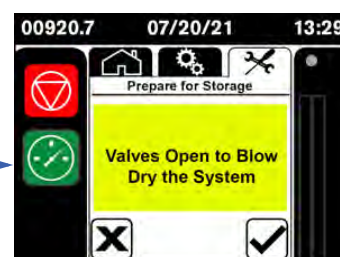

Go to [page 187](#).





**Stage 1**

**Countdown is starting**

The supply-water pressure increases.

- The primary motor starts.
- If the system has a boost pump, it turns on.
- The hydraulic pump operates at minimum pressure.
- The supply-water pressure increases until the it gets to the target water pressure.

The minimum setpoint is 2.76 bar (40 psi).

Touch the  symbol to stop the procedure and turn off the pump.

**Stage 2**

**Pump Starting**

Air is removed from the system.

- The intensifier starts stroking.
- The bleed-down valve is open.

**Stage 3**

**Pressure is Increasing**

The system fills with water.

- The bleed-down valve closes.
- Water pressure in the system increases to 690 bar (10,000 psi).

**Stage 4**

**Turn On the Cutting Head**

1. Move the cutting head to a safe location on the table.

2. Turn **ON** the cutting head.
3. Touch the  symbol to continue.

**Stage 5**

**Pressure is Increasing**

The water pressure increases in 690 bar (10,000 psi) increments until the pump is at 4,140 bar (60,000 psi).

**Stage 6**

**Turn Off the Cutting Head**

The system waits for you to turn off the cutting head.

1. Turn **OFF** the cutting head.
2. Touch the  symbol to continue.

**Stage 7**

**Examine the Pump**

The system waits for you to examine the pump.

1. Examine the pump for loose fittings or leaks.
2. Examine the attenuator connections for leaks.
3. Touch the  symbol to continue.

The main motor turns off.  
The primary operation screen opens.

**The start procedure is complete.**



# 10

## ***Technical drawings***

### **In this section**

1-18947 Hydraulic and water system drawings



The electrical drawings are shipped in an envelope that is found inside the electrical cabinet.



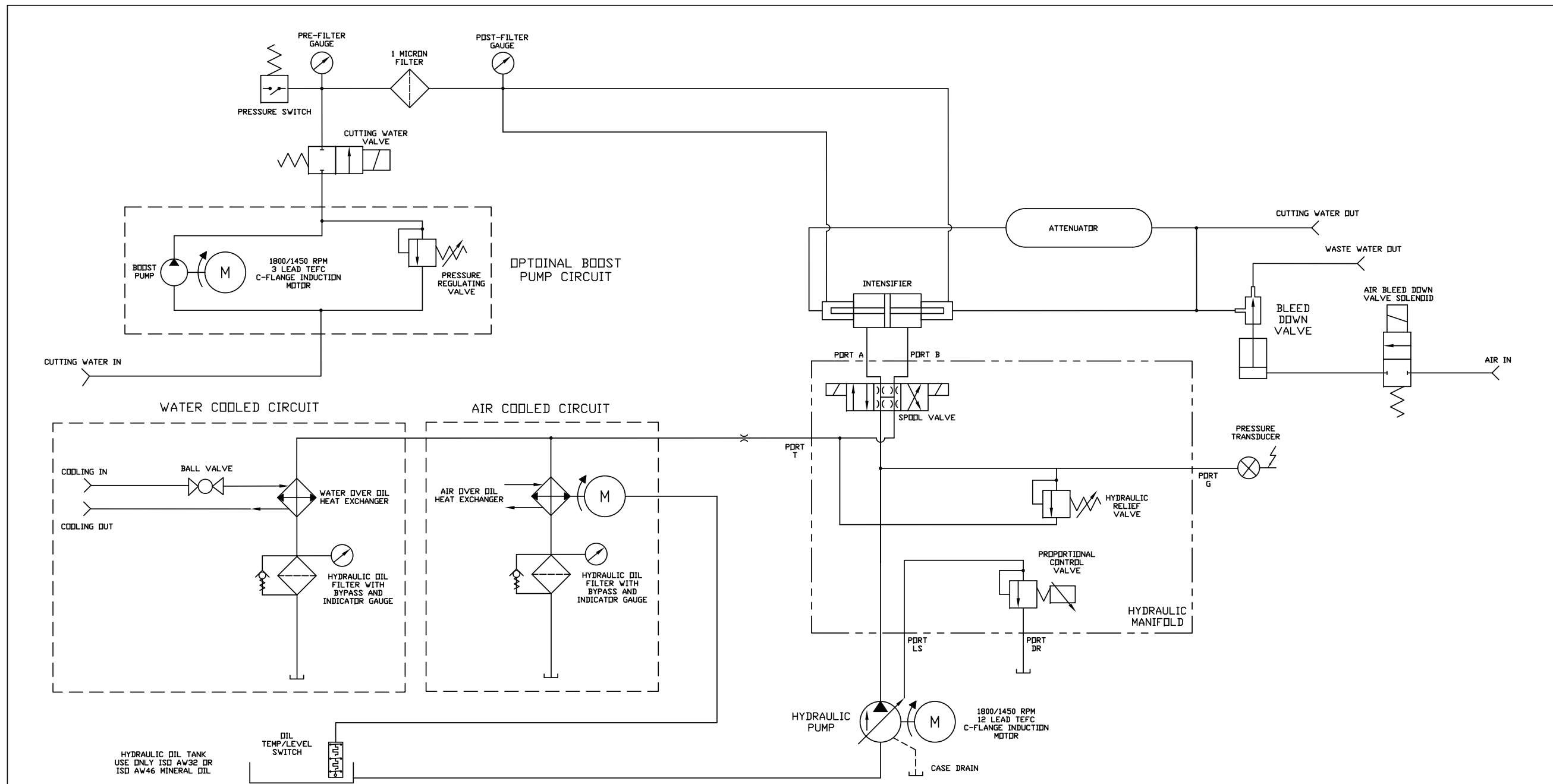

HYDRAULIC OIL TANK  
USE ONLY ISO AW32 OR  
ISO AW46 MINERAL OIL

HYDRAULIC OIL PROBE  
-TEMP SENSOR TURNS FAN MOTOR ON AT 45°C  
(113°F). STAYS ON FOR 10 MINUTES OR UNTIL TEMP  
DROPS BELOW 45°C (113°F), WHICHEVER IS LONGER.  
-TEMP SENSOR SHUTS PUMP DOWN AT 65°C (150°F)  
FLOT SWITCH OPENS ON LOW OIL LEVEL

HIGHLY CONFIDENTIAL PROPRIETARY INFORMATION	309 5TH AVENUE NW NEW BRIGHTON, MN 55112 PHONE: 651-294-8600 FAX: 651-294-8620 EMAIL: WATERJET@HYPERTHERM.COM WEB: WWW.HYPERTHERM.COM		TITLE: SCHEM:ECHION HYD & WTR		
			SHEET 1 OF 1	SCALE: 1:1	FINISH
THIS DRAWING AND ALL INFORMATION CONTAINED THEREIN IS CONSIDERED PROPRIETARY AND MAY NOT BE USED FOR MANUFACTURING OR FABRICATION PURPOSES WITHOUT PERMISSION FROM HYPERTHERM, INC.	-TOLERANCES- UNLESS OTHERWISE SPECIFIED DIMENSIONS IN INCHES ANGULAR: MACH ± 1 BEND ± 1 ONE PLACE DECIMAL ± .05 TWO PLACE DECIMAL ± .015 THREE PLACE DECIMAL ± .005 BREAK AND DEBURR ALL EDGES .015 MAX		NAME NJK	DATE 02/18/2020	MATERIAL HARDNESS WEIGHT
		DRAWN CHECKED ENG APPR.	SIZE B	DWG. NO. 1-18947	REV A





## Your pump information

---

Model \_\_\_\_\_

Serial number \_\_\_\_\_

The serial number is on the data plate, which is found on the back of the pump.

Electrical drawing number \_\_\_\_\_

The electrical drawing number is found inside the electrical enclosure door on a green label.

Purchase date \_\_\_\_\_

Distributor \_\_\_\_\_

Installation date \_\_\_\_\_

Installed by \_\_\_\_\_

## Thank you

---

### **We appreciate hearing from you and receiving your feedback**

We review your comments and ideas regularly and use them when planning changes. We promise to consider every suggestion. Your satisfaction is our highest priority.

Recommend changes for the next update to this manual.

Send this information with your comments to [Technical.Service@hypertherm.com](mailto:Technical.Service@hypertherm.com).

- Echion Operator Manual 810770 Revision 1
- Include page numbers, if applicable.
- Tell us the problem or make a suggestion.

Thank you for helping us improve our products.

# AHB

**TOOLING & MACHINERY**

**COMPLETE METALWORKING SOLUTIONS**

**(800) 991-4225**

**[www.ahbinc.com](http://www.ahbinc.com)**

**ISO Certified**

**[customerservice@ahbinc.com](mailto:customerservice@ahbinc.com)**