



HIGH PRECISION

# TOOL-A-THON<sup>®</sup>

# AHB

TOOLING & MACHINERY

COMPLETE METALWORKING SOLUTIONS

(800) 991-4225

[www.ahbinc.com](http://www.ahbinc.com)

ISO Certified

[customerservice@ahbinc.com](mailto:customerservice@ahbinc.com)



**Come Visit Us At Our Booth 134360!**



# IMTS2024

International Manufacturing Technology Show  
Sept. 9<sup>th</sup> - 14<sup>th</sup> | McCormick Place | Chicago, IL

**Volume 24.2** Valid May 1<sup>st</sup> - Aug. 31<sup>st</sup>

[www.fowlerprecision.com](http://www.fowlerprecision.com)

# Fowler Trimos THV Horizontal Calibration Packages



### Specifications:

Overall Application Range	Using standard probe
External measurement	0 4" /0 100mm
Internal measurement	0 4 4" /10 100mm
Scale Range (travel)	Absolute display up to 2"/50mm
Max Measuring Band Error	0 000016"/0 4µm reference
Temperature 20°C	
Resolution on Heidenhain ND 287	0 00001" 0 000001"
Repeatability	0 000005" ±2s ( 0 1µm)
Adjustable Measuring Force	0 to 12N (0 40 oz )

## THV Package 1 includes...

For checking pins, plugs and plain rings up to 4"

Includes	Description
54-198-558-0	HV with loading table
54-198-100-0	Block Support or H-Plate
54-198-101-0	H - Plate, provides clearance or plugs
54-198-261-0	Reverse Attachment American style

\*THV Readout Required

Order No. 54-198-777-P1

**Special Package Price \$26,054.<sup>00</sup>**

List Price \$30,652.31

## THV Package 2 includes...

For checking thread plugs and plain rings up to 4"

Includes	Description
54-198-508-0	HV with Standard table
54-198-100-0	Block Support or H-Plate
54-198-101-0	H - Plate, provides clearance or plugs
54-197-007-0	thread Wire Set

\*THV Readout Required

Order No. 54-198-777-P2

**Special Package Price \$21,652.<sup>00</sup>**

List Price \$25,473.64

### THV Readouts - sold separately

Order No.	Description	List Price	Sale Price
54-198-400-0	USB Signal Converter w/ W N DH Software (Laptop required)	\$4,597 70	<b>\$4,460.00</b>
54-198-111-0	HV Digital Display	\$3,808 53	<b>\$3,460.00</b>

# Fowler Trimos Mini Horizontal Calibration Package

This economical yet precise set allows you to easily calibrate internal and external setting standards as well as measure parts up to 4" OD and as small as 0.24" ID.

The Fowler Trimos Mini Horizontal Specification includes the Trimos Mini Horizontal and the Syvac Nano Indicator with Bluetooth. Includes everything to get started! Add the optional accessories available, contact our technical department 1-800-788-2353.

 **TRIMOS**

 **SWISS MADE**



## Mini-Horizontal Features:

- Internal range 0.24" - 4" / 6 - 100mm
- External range 0 - 4" / 0 - 100mm
- Resolution 0.0001" / 0.0001mm
- Accuracy 0.00008" / 0.0022mm
- Monoblock construction with probe guide track
- Adjustable end stop with anvil location
- Adjustable measuring pressure
- Adjustable measuring table



## Mark VI NANO Electronic Indicator Features:

- Range 1"/25mm
- Resolution 0.0001" / 0.0001mm
- Accuracy 0.00008" / 0.0022mm
- Repeatability 0.0002" / 0.0005mm
- Lifetime warranty
- Large display
- Bluetooth
- P54 protected against fluid and dust

 **Fowler**   
LIFETIME WARRANTY

 **sylvac**  **SWISS PRECISION**



Order No. 53-190-012-TP

**Special Package Price \$9,095.00**

List Price \$9,995.00

Prices & Specifications are subject to change without notice

# Fulcrum Revolutionary Manual CMM



## Features

- Small footprint allowing measurements right next to your machine
- Intuitive software allows quick and easy measurement
- Minimal setup
- Programmable magnetic soft buttons allow you to quickly change between software features without using a mouse
- Magnetic fixture templates allow you to quickly fix your part
- Volumetric accuracy of  $0.0002"/0.005\text{mm}$
- Uses a single USB cable to connect and requires no air

ABERLINK   
Innovative Metrology

Fowler FUSION   
Metrology Software

Order No. 54-960-400-0

## NEW Star Styli Probe Kit *optional*

The Fulcrum can be supplied with our optional star styli kit. The star styli ensures excellent metrology performance and accessibility to side face features measured in the X Z or Y Z projection planes.

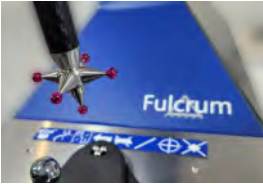

Order No. 54-960-403-0

### Kit Includes:

3mm Star Stylus



6mm Star Stylus

Calibration Artifact



## Extol CMM (Mark 1)

### Features:

- Shop floor hardened for use at the machine center
- Easy to use FUS ON Software
- Robust enough to use around the clock
- 5 temp sensors allow for use in uncontrolled environments

ABERLINK   
Innovative Metrology

Fowler FUSION   
Metrology Software



Order No.	Description
MK1-EXT-370	(XY) 370mm x (Z) 270mm
MK1-EXT-520	(XY) 520mm x (Z) 300mm

## zCAT Portable CMM

### Features:

- Compact for use at the machine center
- Easy to use FUSION Software
- Completely portable only 30 lbs
- High accuracy
- Ethernet communication (Bluetooth optional)



Order No. 54-950-001-0

## Horizontal Setting and Calibration

*Setting of measuring equipment with variable dimensions.*

### HC5



### Features:

- Designed for the calibration of fixed and variable measuring equipment
- Available in sizes up to 120"
- Adjustable measuring force

Order No. 54-197-370-0



### HS6

### Features:

- For setting equipment with variable dimensions quickly and accurately
- Available in sizes up to 120"
- Large selection of accessories to handle any job



Order No. 54-196-900-5



# NEW Rapid Measuring Systems

## 5000

Up to 5000  
dimensions

## 1024

Up to 1024  
workpieces

## 2

Finish  
measurements  
in 2 seconds



Measures multiple parts  
simultaneously



One touch measuring

Order No. 54-830-830-0

#### Features:

- Simultaneous measuring up to 100 parts
- Simple place and press measurement finish in 3 seconds
- No more operator errors
- Powerful yet easy to use measuring software
- Up to 12" x 8" field of view
- High resolution 0.00004"/0.0001mm

Model No.	Measuring Range
54-830-310-0	100mm x 200mm
54-830-320-0	200mm x 200mm
54-830-830-0	300mm x 200mm

**Call for more information, 1-800-788-2353!**

## Venture 3030 XT Multi-Sensor Vision System

### XT



#### Features:

- 11 8"/300mm x 11 8"/300mm x 7 8"/200mm XYZ stage
- Teach and repeat programming with Fowler FUSION
- 6.5 1 zoom optics (with optional CNC control)
- High resolution 0.5µm scales for increased accuracy

**baty**   
Made in ENGLAND

**Fowler FUSION**  
Metrology Software 

Order No. 54-242-000-0

# The BEST Solution for Shaft Scanning!

Increase productivity while reducing scrap and inspection cycle times by a factor of 10.

 **sylvac**

 **SWISS  
MADE**



## SCAN S25T

*Fast, Accurate, Reliable & Repeatable!*

### Features:

- Ideal for small cylindrical parts
- Measuring range 1.02"/26mm Diameter 7.87"/200mm Length
- High resolution and high accuracy
- One click rapid measuring
- 30° tilting optics for complete thread measurements

**Order No. 54-902-025-5**



## SCAN F60T

*For Larger Parts!*

### Features:

- Complete 2D part scan in less than 3 seconds
- Measuring range 2.3"/60mm diameter 12"/300mm length
- Reduce inspection time & scrap increase productivity
- High resolution and high accuracy
- One click rapid measuring
- 30° tilting optics for complete thread measurements

**Order No. 54-902-406-5**

## SCAN S145's

*Our Largest Machines!*

### Features:

- Full part measurement in just a few seconds
- Measuring range 5.7"/145mm diameter 50.3"/1280mm length
- Reduce inspection time & scrap increase productivity
- High resolution and high accuracy
- One click rapid measuring
- Optional measuring probe for measuring keyways holes and hole locations

**Order No. 54-902-145-5**

**NEW  
Measuring  
Probe**



## Fowler Trimos V Series Electronic Height Gages

The Fowler Trimos V series vertical measuring instruments have been developed for the most difficult shop floor environments. Manufactured in Switzerland, they guarantee precise and repeatable measurements with superior ease of use.

### Features:

- Electronically adjustable measuring force 0.75/1.5 (N)
- Lithium ion rechargeable batteries last up to 40 hours
- Bluetooth transmitter available

### All models Include:

- Charging unit
- Measuring probe with ruby ball Ø4mm
- Probe holder elbow Ø8mm
- Setting gage
- Test certificate



54-192-340-0



54-199-570-0



54-199-970-0



54-191-440-0



54-199-770-0

*Measures ID/OD, centerlines, heights, widths, depths, min/max/delta, slots, grooves and more!*



# V-Series Electronic Height Gages Comparison Chart

24.2

	V9	V8	V7	V6	V5	V4	V3
<b>Accuracy</b>							
1 2 + L(mm)/1000 μm	✓	✓					
2 + L(mm)/400 μm			✓	✓			
2 5 + L(mm)/300 μm					✓		
4 5 6 μm						✓	
7 8 μm							✓
<b>Range</b>							
400/700mm	✓	✓	✓	✓	✓	✓	✓
1100mm	✓	✓	✓	✓	✓		
<b>Smart Reverse for Ø</b>	✓	✓	✓	✓	✓	✓	✓
<b>Air Cushion</b>	✓	✓	✓	✓	✓	✓	
<b>Wireless Option</b>	✓	✓	✓	✓	✓	✓	
<b>Manual/Motorized</b>	✓		✓	✓	✓		
<b>Manual ONLY</b>		✓				✓	✓
<b>Fine Adjustment</b>		✓					
<b>Color Display</b>	✓		✓				
<b>2D Measuring</b>	✓		✓				

**Certify Any Height Gage**

**Below For Only \$199.00**

Valid only for Tool A Thon 24 2

Height Gages

Order No.	Range	Range with Probe Inverted	List Price	Sale Price
<b>V3</b>				
54-192-340-0	16"/407mm	20"/508mm	\$5,419 97	<b>\$5,149.00</b>
54-192-370-0	28"/711mm	31 9"/812mm	\$5,511 60	<b>\$5,237.00</b>
<b>V4</b>				
54-191-440-0	16"/407mm	28 3"/719mm	\$6,584 83	<b>\$6,256.00</b>
54-191-470-0	28"/711mm	40 2"/1023mm	\$8,305 31	<b>\$7,891.00</b>
<b>V5</b>				
54-199-540-0	16"/407mm	28 3"/719mm	\$7,257 34	<b>\$6,895.00</b>
54-199-570-0	28"/711mm	40 2"/1023mm	\$8,600 23	<b>\$8,171.00</b>
54-199-590-0	43 7"/1110mm	56"/1422mm	\$13,583 85	<b>\$12,905.00</b>
<b>V6</b>				
54-199-640-0	16"/407mm	28 3"/719mm	\$9,014 34	<b>\$8,564.00</b>
54-199-670-0	28"/711mm	40 2"/1023mm	\$10,458 85	<b>\$9,936.00</b>
54-199-690-0	43 7"/1110mm	56"/1422mm	\$15,163 41	<b>\$14,406.00</b>
<b>V7</b>				
54-199-740-0	16"/407mm	28"/719mm	\$11,963 78	<b>\$11,366.00</b>
54-199-770-0	28"/711mm	40"/1023mm	\$12,781 27	<b>\$12,143.00</b>
54-199-790-0	44"/1100mm	56"/1422mm	\$18,311 10	<b>\$17,396.00</b>
<b>V8 - ine Adjustment</b>				
54-199-840-0	16"/407mm	28"/724mm	\$13,157 00	<b>\$12,500.00</b>
54-199-870-0	28"/710mm	40"/1028mm	\$14,508 73	<b>\$13,784.00</b>
54-199-890-0	43"/1109mm	56"/1427mm	\$21,389 93	<b>\$20,321.00</b>
<b>V9</b>				
54-199-940-0	16"/407mm	28"/724mm	\$13,871 20	<b>\$13,178.00</b>
54-199-970-0	28"/710mm	40"/1028mm	\$14,254 65	<b>\$13,542.00</b>
54-199-990-0	43"/1109mm	56"/1427mm	\$21,462 33	<b>\$20,390.00</b>
<b>Probe Sets</b>				
54-199-105-0	4mm Probe Set, 21 piece		\$1,923 23	<b>\$1,828.00</b>
54-199-106-0	8mm Probe Set, 16 piece		\$1,556 00	<b>\$1,479.00</b>
54-199-107-0	8mm Basic Probe Set, 7 piece		\$509 53	<b>\$485.00</b>
<b>Accessories</b>				
45-300-002-0	SO Certification		\$379 00	<b>\$199.00</b>
54-199-400-0	12"/300mm Holder - or 8mm probes		\$1,167 27	<b>\$1,109.00</b>
54-199-022-BT	Bluetooth transmitter (Not available or V3 models)		\$675 78	<b>\$642.00</b>
54-777-120-0	Vmux so tware - or connecting multiple units to one PC		\$538 54	<b>\$485.00</b>

Fowler

# Fowler Sylvac Hi\_Cal V2 Electronic Height Gages

For your finer, more delicate parts.

**FREE 1mm Ball Probe**  
with 6"/150mm and 12"/300mm Hi\_Cal Purchase!

**sylvac**



54-931-150-BT



54-931-300-BT



54-931-450-BT

## Features:

- Bluetooth for quick, easy recorded measurements
- Extra low measuring force from 0 2N
- Measure internal and external diameters centerlines heights widths depths and M N/MAX/T R capability
- Excellent repeatability thanks to the motorized carriage
- High reliability
- Bluetooth USB and RS232 data outputs
- Battery life 40 hours rechargeable during operation
- Touch sensitive probe speed for easy operation
- Base with small footprint
- Includes protective cover charging set ruby ball probe Ø3mm setting gage and calibration certificate

## Full Probe Set



54-930-215-0

## FREE Basic Probe Set

with 54 931 450 BT Hi\_Cal Purchase  
\$951 03 Value!



54-930-217-0

**ISO Certification available  
for \$199.<sup>00</sup> extra!**

Order No.	Range	Accuracy	List Price	Sale Price
54-931-150-BT	6"/150mm	0 00013"/0 0034mm	\$6,080 26	<b>\$5,473.00</b>
54-931-150-BT-C	6"/150mm with ISO/A2LA Certification			<b>\$5,672.00</b>
54-931-300-BT	12"/300mm	0 00016"/0 0042mm	\$6,636 83	<b>\$5,974.00</b>
54-931-300-BT-C	12"/300mm with ISO/A2LA Certification			<b>\$6,173.00</b>
54-931-450-BT	17 5"/450mm	0 00020"/0 005mm	\$7,554 76	<b>\$6,442.00</b>
54-931-450-BT-C	17 5"/450mm with ISO/A2LA Certification			<b>\$6,641.00</b>
Accessories				
54-930-215-0	ull Probe Set		\$1,771 05	<b>\$1,594.00</b>
54-930-217-0	Basic Probe Set		\$951 03	<b>\$856.00</b>

# NEW V1 & V1+ Electronic Height Gages

Introducing the next generation of Trimos entry-level height gages for the workshop.

Coming Soon,  
July 2024



### Features:

- V1 features a fine adjust hand wheel for scribing (optional scriber)
- V1+ features bi directional measuring force hand wheel for measuring bores centerlines heights min/max/delta
- Accuracy 0 0012"/0 03mm
- Supplied with 0 236"/6mm ball probe
- Bluetooth/RS232 data output
- Steel base and extra large display with simplified keypad



TRIMOS



SWISS  
MADE



Order No.	Range	Range	Resolution	List Price	Sale Price
54-180-424-0	V1	24"/611mm	0 0005"/0 01mm	\$3,299 99	<b>\$2,999.99</b>
54-180-524-0	V1+	24"/611mm	0 0005"/0 01mm 0 00005"/0 001mm	\$4,399 99	<b>\$3,999.99</b>



## Z-HEIGHT

### Electronic Height Gages

With handwheel and fine adjust.

### Features:

- Base design has a more comfortable grip and is finely ground and lapped for smooth movement on surface plates
- Fine adjust feature allows precise adjustment to required settings
- Preset feature allows setting pre determined or reference measurements
- Indicator holding bar included
- Resolution 0 0005"/0 01mm
- Large high contrast LCD display
- Coarse adjustment hand wheel
- Carriage locking lever
- Carbide tipped scriber

54-175-024-0 shown

Calibration certificates available for all sizes.

Order No.	Range	Accuracy	List Price	Sale Price
54-175-012-0	12"/300mm	0 0015"/0 04mm	\$584 91	<b>\$510.00</b>
54-175-018-0	18"/450mm	0 002"/0 05mm	\$696 17	<b>\$627.00</b>

Prices & Specifications are subject to change without notice

# Fowler Bowers **BLUETOOTH**



## XTH3 Bluetooth Holematic Pistol Grips

### Features:

- Coolant proof dust proof P67
- Resolution: 0 00005"/0 001mm
- Bluetooth connectivity to your phone or tablet
- Self centering 3 point heads above 0 250"
- Tungsten carbide measuring faces on all 3 point heads from 0 5"/12 5mm and up
- Sizes over 0 500"/12 5mm feature blind bore capability
- Includes UKAS certificates for all pistol grip heads and rings



54-567-100-BT

For special application heads, contact the  
Fowler Technical Department 1-800-788-2353



2 and 3 Point  
Screw Threads



2 and 3 Point  
Grooves



3 Point Spherical



Order No.	Range	Includes	List Price	Sale Price
<b>Pistol Grip individual Sets</b>				
54-567-720-BT	0 750" - 1"/20 - 25mm	1 head, 1 handle, 1 ring	\$2,774 23	<b>\$2,372.00</b>
54-567-725-BT	1" - 1 375"/25 - 35mm	1 head, 1 handle, 1 ring	\$2,995 57	<b>\$2,697.00</b>
54-567-735-BT	1 375" - 2"/35 - 50mm	1 head, 1 handle, 1 ring	\$3,075 38	<b>\$2,768.00</b>
<b>Pistol Grip Complete Sets</b>				
54-567-009-BT	0 080" - 0 250"/2 - 6mm (2 pt )	5 heads, 1 handle, 3 rings	\$7,033 38	<b>\$6,014.00</b>
54-567-010-BT	0 250" - 0 375"/6 - 10mm	2 heads, 1 handle, 1 ring	\$2,757 87	<b>\$2,358.00</b>
54-567-020-BT	0 375" - 0 750"/10 - 20mm	3 heads, 1 handle, 2 rings	\$3,226 40	<b>\$3,049.00</b>
54-567-050-BT	0 750" - 2"/20 - 50mm	3 heads, 1 handle, 2 rings	\$4,165 94	<b>\$3,937.00</b>
54-567-100-BT	2" - 4"/50 - 100mm	3 heads, 1 handle, 2 rings	\$4,636 93	<b>\$4,174.00</b>
54-567-105-BT	4" - 6"/100 - 150mm	2 heads, 1 handle, 1 ring	\$4,165 94	<b>\$3,937.00</b>
54-567-110-BT	6" - 8"/150 - 200mm	2 heads, 1 handle, 1 ring	\$5,498 92	<b>\$4,702.00</b>
54-567-200-BT	4" - 8"/100 - 200mm	4 heads, 1 handle, 2 rings	\$8,703 75	<b>\$8,226.00</b>
54-567-210-BT	0 750" - 4"/20 - 100mm	6 heads, 1 handle, 4 rings	\$5,091 00	<b>\$4,836.00</b>
54-567-620-BT	0 250" - 0 750"/6 - 20mm	5 heads, 1 handle, 3 rings	\$3,722 00	<b>\$3,434.00</b>
<b>Connectivity Cables/Accessory</b>				
54-115-526-0	Proximity cable with USB connection		\$223 37	<b>\$202.00</b>
54-115-527-0	Proximity cable with serial connection		\$216 29	<b>\$195.00</b>
54-115-246-BT	USB bluetooth receiver		\$49 45	<b>\$43.00</b>

# Bore Gaging Systems



## XTD3 Bluetooth Electronic Holemikes

**BIGGEST SALE EVER**

### Features:

- Coolant proof dust proof P67
- Resolution 0.00005"/0.001mm
- Bluetooth connectivity to your phone or tablet
- Self centering 3 point heads above 0.250"
- Tungsten carbide measuring faces on all 3 point heads from 0.5"/12.5mm and up
- Sizes over 0.500"/12.5mm feature blind bore capability
- Includes UKAS certificates for all pistol grip heads and rings



Internal & External Measuring

Order No.	Range	Includes	List Price	Sale Price
Holemike individual Sets ( traditional style)				
2-Point Heads				
54-367-003-BT	0.080" - 0.100"/2 - 2.5mm	1 head, 1 handle, 1 ring	\$2,643.30	<b>\$2,403.00</b>
54-367-004-BT	0.100" - 0.120"/2.5 - 3mm	1 head, 1 handle, 1 ring	\$2,643.30	<b>\$2,403.00</b>
54-367-005-BT	0.120" - 0.160"/3 - 4mm	1 head, 1 handle, 1 ring	\$2,872.63	<b>\$2,403.00</b>
54-367-006-BT	0.160" - 0.200"/4 - 5mm	1 head, 1 handle, 1 ring	\$2,643.30	<b>\$2,403.00</b>
54-367-007-BT	0.200" - 0.250"/5 - 6mm	1 head, 1 handle, 1 ring	\$2,872.63	<b>\$2,403.00</b>
3-Point Heads				
54-367-008-BT	0.250" - 0.312"/6 - 8mm	1 head, 1 handle, 1 ring	\$1,437.70	<b>\$1,307.00</b>
54-367-011-BT	0.312" - 0.375"/8 - 10mm	1 head, 1 handle, 1 ring	\$1,669.80	<b>\$1,518.00</b>
54-367-012-BT	0.375" - 0.500"/10 - 12.5mm	1 head, 1 handle, 1 ring	\$1,685.20	<b>\$1,532.00</b>
54-367-014-BT	0.500" - 0.625"/12.5 - 16mm	1 head, 1 handle, 1 ring	\$1,835.90	<b>\$1,669.00</b>
54-367-016-BT	0.625" - 0.750"/16 - 20mm	1 head, 1 handle, 1 ring	\$1,835.90	<b>\$1,669.00</b>
54-367-018-BT	0.750" - 1"/20 - 25mm	1 head, 1 handle, 1 ring	\$1,879.90	<b>\$1,709.00</b>
54-367-021-BT	1" - 1.375"/25 - 35mm	1 head, 1 handle, 1 ring	\$1,879.90	<b>\$1,709.00</b>
54-367-022-BT	1.375" - 2"/35 - 50mm	1 head, 1 handle, 1 ring	\$1,923.90	<b>\$1,749.00</b>
54-367-024-BT	2" - 2.625"/50 - 65mm	1 head, 1 handle, 1 ring	\$2,106.50	<b>\$1,915.00</b>
54-367-026-BT	2.625" - 3.250"/65 - 80mm	1 head, 1 handle, 1 ring	\$2,106.50	<b>\$1,915.00</b>
54-367-028-BT	3.250" - 4"/80 - 100mm	1 head, 1 handle, 1 ring	\$2,165.90	<b>\$1,969.00</b>
54-367-030-BT	4" - 5"/100 - 125mm	1 head, 1 handle, 1 ring	\$2,901.80	<b>\$2,638.00</b>
54-367-032-BT	5" - 6"/125 - 150mm	1 head, 1 handle, 1 ring	\$2,933.70	<b>\$2,667.00</b>
54-367-034-BT	6" - 7"/150 - 175mm	1 head, 1 handle, 1 ring	\$3,082.20	<b>\$2,802.00</b>
54-367-036-BT	7" - 8"/175 - 200mm	1 head, 1 handle, 1 ring	\$3,219.70	<b>\$2,927.00</b>
54-367-037-BT	8" - 9"/200 - 225mm	1 head, 1 handle, 1 ring	\$3,429.80	<b>\$3,118.00</b>
54-367-038-BT	9" - 10"/225 - 250mm	1 head, 1 handle, 1 ring	\$5,527.60	<b>\$3,185.00</b>
54-367-039-BT	10" - 11"/250 - 275mm	1 head, 1 handle, 1 ring	\$5,723.01	<b>\$3,296.00</b>
54-367-040-BT	11" - 12"/275 - 300mm	1 head, 1 handle, 1 ring	\$3,683.90	<b>\$3,349.00</b>
Holemike Complete Sets ( traditional style)				
54-367-000-BT	0.080" - 0.250"/2 - 6mm (2 pt )	5 heads, 1 handle, 3 rings	\$4,545.20	<b>\$4,132.00</b>
54-367-010-BT	0.250" - 0.375"/6 - 10mm	2 heads, 1 handle, 1 ring	\$2,670.76	<b>\$2,430.00</b>
54-367-020-BT	0.375" - 0.750"/10 - 20mm	3 heads, 1 handle, 2 rings	\$3,187.03	<b>\$2,899.00</b>
54-367-050-BT	0.750" - 2"/20 - 50mm	3 heads, 1 handle, 2 rings	\$4,326.12	<b>\$3,935.00</b>
54-367-100-BT	2" - 4"/50 - 100mm	3 heads, 1 handle, 2 rings	\$4,791.89	<b>\$4,360.00</b>
54-367-105-BT	4" - 6"/100 - 150mm	2 heads, 1 handle, 1 ring	\$3,818.10	<b>\$3,471.00</b>
54-367-110-BT	6" - 8"/150 - 200mm	2 heads, 1 handle, 1 ring	\$5,034.70	<b>\$4,577.00</b>
54-367-200-BT	4" - 8"/100 - 200mm	4 heads, 1 handle, 2 rings	\$8,332.50	<b>\$7,575.00</b>
Connectivity Cables/Accessory				
54-115-526-0	Proximity cable with USB connection		\$223.37	<b>\$202.00</b>
54-115-527-0	Proximity cable with serial connection		\$216.29	<b>\$195.00</b>
54-115-246-BT	USB bluetooth receiver		\$49.45	<b>\$43.00</b>



# XT-Series Holemikes

Vernier Bore Micrometers



52-255-316-0



52-255-312-0



BOWERS GROUP



MADE IN ENGLAND



### Features:

- 3 pt contact with tungsten carbide measuring anvils above 0.5"
- Blind bore measuring heads featured above 0.5"
- Ratchet stop for consistent measuring
- Extensions available for deep measuring
- Includes UKAS certificates for all Holemikes and setting rings

Order No.	Range	Grads.	Meas. Accuracy	Ring Depth	Ring Included	List Price	Sale Price
52-255-310-0	0 250" - 0 312"	0 00025"	0 00015"	2 28"	0 312"	\$829 07	<b>\$622.00</b>
52-255-311-0	0 312" - 0 375"	0 00025"	0 00015"	2 28"	0 312"	\$767 67	<b>\$576.00</b>
52-255-312-0	0 375" - 0 500"	0 00025"	0 00015"	2 28"	0 5"	\$767 67	<b>\$576.00</b>
52-255-313-0	0 500" - 0 625"	0 00025"	0 00015"	2 44"	0 5"	\$767 67	<b>\$576.00</b>
52-255-314-0	0 625" - 0 750"	0 00025"	0 00015"	2 44"	0 75"	\$787 25	<b>\$591.00</b>
52-255-315-0	0 750" - 1"	0 00025"	0 00015"	2 60"	0 75"	\$864 56	<b>\$649.00</b>
52-255-316-0	1" - 1 375"	0 00025"	0 00015"	2 60"	1 375"	\$1,231 87	<b>\$924.00</b>
52-255-317-0	1 375" - 2"	0 00025"	0 00015"	3 15"	1 375"	\$1,261 24	<b>\$946.00</b>
52-255-318-0	2" - 2 625"	0 00025"	0 0002"	3 15"	2 625"	\$1,504 52	<b>\$1,129.00</b>
52-255-319-0	2 625" - 3 250"	0 00025"	0 0002"	3 15"	2 625"	\$1,517 98	<b>\$1,139.00</b>
52-255-320-0	3 250" - 4"	0 00025"	0 0002"	3 94"	3 25"	\$1,893 75	<b>\$1,421.00</b>
Sets							
52-255-565-0	0 250" - 0 375"	2 heads, 2 handles, 1 ring				\$1,686 00	<b>\$1,265.00</b>
52-255-665-0	0 375" - 0 750"	3 heads, 3 handles, 2 rings				\$2,096 32	<b>\$1,573.00</b>
52-255-775-0	0 750" - 2"	3 heads, 3 handles, 2 rings				\$3,293 82	<b>\$2,471.00</b>
52-255-885-0	2" - 4"	3 heads, 3 handles, 2 rings				\$4,465 29	<b>\$3,349.00</b>

## MicroGage

Pocket sized 2-point bore gaging system.



Replaces 100's of pin gages!

### Features:

- System range 0 040" 0 250"/1 6mm
- Switchable resolution 0 0005" 0 00005"/0 01 0 001 0 0005mm
- Repeatability 0 00005"/0 001mm
- Sets include setting rings with UKAS certificates
- Depth stops available call our technical department 1 800 788 2353



BOWERS GROUP



MADE IN ENGLAND

Order No.	Description	List Price	Sale Price
54-551-010-0	0 037" - 0 096"/0 95 - 2 45mm	\$3,950 93	<b>\$3,556.00</b>
54-551-011-0	0 060" - 0 167"/1 5 - 4 25mm	\$3,866 75	<b>\$3,481.00</b>
54-551-012-0	0 089" - 0 250"/2 25 - 6 35mm	\$4,162 44	<b>\$3,747.00</b>
Connectivity Cables			
54-115-526-0	Proximity cable with USB connection	\$223 37	<b>\$202.00</b>
54-115-527-0	Proximity cable with serial connection	\$216 29	<b>\$195.00</b>

# Ultima Bore Gaging Systems

World's most accurate system!



D62S

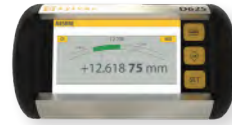

Display not included

**Features:**

- Accuracies of 0 00004" up to 1 97"
- Ceramic anvils with blind bore capabilities above 0 472"
- Uses compact multi function Sylvac display



BOWERS GROUP



MADE IN ENGLAND

Order No.	Description	Set Includes	List Price	Sale Price
54-565-006-1	0 078" - 0 236"/2 - 6mm	ncludes handle, rings & heads	\$7,642 60	<b>\$6,497.00</b>
54-565-010-1	0 236" - 0 393"/6 - 10mm	ncludes handle, rings & heads	\$4,150 90	<b>\$3,529.00</b>
54-565-020-1	0 393" - 0 787"/10 - 20mm	ncludes handle, rings & heads	\$6,175 54	<b>\$5,250.00</b>
54-565-070-1	0 236" - 0 787"/6 - 20mm	ncludes handle, rings & heads	\$9,658 72	<b>\$7,727.00</b>
54-565-080-1	0 787" - 1 97"/20 - 50mm	ncludes handle, rings & heads	\$10,589 24	<b>\$8,472.00</b>
54-565-090-1	1 97" - 3 94"/50 - 100mm	ncludes handle, rings & heads	\$11,758 98	<b>\$9,408.00</b>
54-565-100-1	0 787" - 3 94"/20 - 100mm	ncludes handle, rings & heads	\$18,007 01	<b>\$16,207.00</b>
Digital Displays				
54-618-106-2	Sylvac D62S Digital Display		\$1,535 33	<b>\$1,382.00</b>
54-618-106-3	Sylvac D62S Advanced Digital Display		\$1,982 16	<b>\$1,884.00</b>

## Deluxe Universal Gage

Internal & External Measurements up to 118" (with optional extensions)



BOWERS GROUP



MADE IN ENGLAND

**Features:**

- Used for internal and external measurement
- D range 1 18" 10" OD range 0 8 4"
- Large range of accessories with constant measuring pressure and digital readout
- Stackable extensions for increasing range available
- Anvil travel of 0 78"

**Available on special order**

Pair of ball inserts for gear/spline measurements Thread inserts for internal/external threads Special anvils such as cones balls pins etc Contact our Technical Department for price quotes

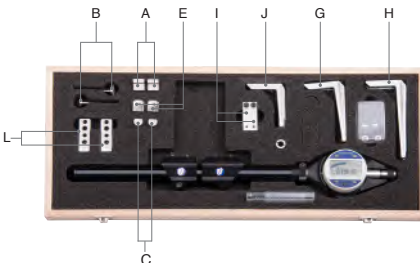

**Accessories included**

A.	54-265-045-0	Pair of Flat Shoulder Anvils
B.	54-265-048-0	Pair of Internal Disc Anvils (large)
C.	54-265-049-0	Pair of Internal/External Disc Anvils (small)
D.	54-265-055-0	Pair of Clamping adaptors
E.	54-265-047-0	Pair of Cylindrical Shoulder Anvils
F.	54-265-015-0	Pair of Spherical Tip Contact Points
G.	54-265-030-0	Pair of Measuring Arms 3"(75mm) long
H.	54-265-040-0	Pair of Measuring Arms 4"(100mm) long
I.	54-265-043-0	Pair of Depth Stops
J.	54-265-020-0	Pair of Measuring Arms 2"(50mm) long
K.	54-265-010-0	Pair of Flat Contact Points
L.	54-265-041-0	Pair of Mounting attachments

Order No. 54-265-777-0

**Sale \$6,199.00**

List Price \$6,950.00

Prices & Specifications are subject to change without notice

# XTENDER Electronic Bore Gage Set

with Carbide Anvils

Industry's two most popular bore gage ranges combined in one easy-to-use electronic set!

Preset size of master for absolute reading and use minimum hold feature to lock on the bore size as the gage is rocked in the part to be measured



#### Bore Gage features:

- Range 1 4" - 6"/35mm - 150mm
- Carbide anvils
- Self centering

#### Indicator features:

- Bar graph for reversal point indication
- Preset with recall
- ABS/ NC measurement
- Min/Max/T R

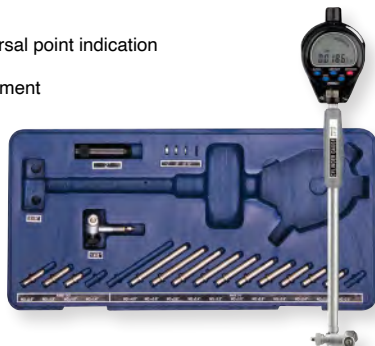

Use with Bore Gage Setting Master Kits, page 17.

Order No.	Range	Resolution	List Price	Sale Price
54-646-401-0	1 4" - 6"/35 - 150mm	0 00005"/0 001mm	\$420 79	<b>\$358.00</b>
Extensions				
52-646-450-0	20" depth extension		\$108 40	<b>\$98.00</b>
52-646-475-0	40" depth extension		\$121 82	<b>\$110.00</b>

## Dial Cylinder Bore Gages

2-point bore measuring



52-646-300-0

#### Features:

- Carbide Anvils
- Easy to read
- Great value
- Graduation 0 0005" 0 0001" or 0 01mm
- Insulated grip
- 9 5" depth above 1 5"
- Chrome plated handle

# XTENDER



52-646-400-0

Use with Bore Gage Setting Master Kits, page 17.

Order No.	Range	Graduation	List Price	Sale Price
52-646-100-0	0 7" - 1 5"	0 0005"	\$169 38	<b>\$128.00</b>
52-646-300-0	2" - 6"	0 0005"	\$160 27	<b>\$137.00</b>
52-646-400-0	1 4" - 6"	0 0005"	\$212 85	<b>\$160.00</b>
52-646-500-0	1 4" - 6"	0 0001"	\$276 34	<b>\$235.00</b>
52-646-220-0	35 - 60mm	0 01mm	\$277 40	<b>\$236.00</b>
Extensions				
52-646-450-0	20" depth extension	<i>*Not for use with 52-646-100-0</i>	\$108 40	<b>\$98.00</b>
52-646-475-0	40" depth extension	<i>*Not for use with 52-646-100-0</i>	\$121 82	<b>\$110.00</b>

# Internal & External Electronic Caliper Gages

For grooves and recesses.



54-554-611-0



54-554-711-0

## Features:

- Accuracy  $\pm 0.0008"/\pm 0.02\text{mm}$
- Resolution  $0.0002"/0.005\text{mm}$
- Analog scale for reversal point indication
- Large LCD display
- Preset capability
- Absolute and incremental measurements modes
- High impact aircraft aluminum case
- Rugged housing

## Dimensions for Internal Calipers

Metric	Inch	L	S	H	Tip Radius
5-15mm	0.2-0.6"	20mm	1.0mm	1.5mm	0.3mm
5-25mm	0.2-1.0"	35mm	1mm	1.5mm	0.3mm
10-30mm	0.4-1.2"	55mm	2mm	3.5mm	0.5mm
20-40mm	0.8-1.6"	80mm	3mm	6.5mm	0.5mm
30-50mm	1.2-2.0"	80mm	3mm	8.5mm	0.5mm

## Dimensions for External Calipers

Metric	Inch	L	S	H	Tip Radius
0-10mm	0-0.4"	40mm	3mm	8mm	0.5mm
0-20mm	0-0.8"	80mm	6.5mm	25mm	0.75mm
10-30mm	0.4-1.2"	80mm	6.5mm	25mm	0.75mm
20-40mm	0.8-1.6"	80mm	6.5mm	25mm	0.75mm
30-50mm	1.2-2.0"	80mm	6.5mm	25mm	0.75mm

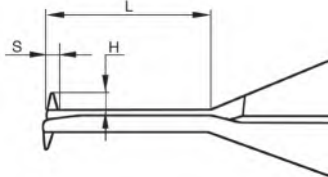

Order No.	Range	List Price	Sale Price
Internal Caliper Gages			
54-554-611-0	0 200" - 0 590"/5 - 15mm	\$207 51	<b>\$177.00</b>
54-554-622-0	0 200" - 1"/5 - 25mm	\$222 49	<b>\$190.00</b>
54-554-623-0	0 400" - 1 2"/10 - 30mm	\$232 88	<b>\$198.00</b>
54-554-624-0	0 790" - 1 6"/20 - 40mm	\$266 52	<b>\$227.00</b>
54-554-625-0	1 2" - 2"/30 - 50mm	\$266 52	<b>\$227.00</b>
External Caliper Gages			
54-554-711-0	0 - 0 400"/0 - 10mm	\$237 48	<b>\$202.00</b>
54-554-722-0	0 - 0 790"/0 - 20mm	\$254 63	<b>\$217.00</b>
54-554-723-0	0 4" - 1 2"/10 - 30mm	\$266 52	<b>\$227.00</b>
54-554-724-0	0 790" - 1 6"/20 - 40mm	\$266 52	<b>\$227.00</b>
54-554-725-0	1 2" - 2"/30 - 50mm	\$232 88	<b>\$198.00</b>

## Bore Gage Setting Master Kits - Inch & Metric

Fowler's Bore Gage Setting Master Kit is used for accurately setting any 2 point cylinder bore gage up to 6"/150mm in diameter to an accuracy of 0.0001"/0.003mm



### Each Set includes: Setting Device

- Base anvil 3 950" x 1 050"
- Adjustable anvil 2 375" x 375" (two each)
- Internal capacity 6"/150mm
- Centralizer capacity width 2 750"
- Quick release holder for fast adjustment

### Economy Gage Block Sets

#### Inch model:

- 36 piece
- Tolerances to 00005"
- Certificate of Calibration to N ST

#### Metric model:

- 33 piece
- AS 2 grade
- Certificate of Calibration to N ST

Bore gage shown not included

### Includes:

**Bore gage setting master and gage block set!**  
**All in a custom-fitted case!**

Order No.	Description	List Price	Sale Price
53-646-000-1	Inch Bore Gage Setting Master Kit	\$400 72	<b>\$341.00</b>
53-646-010-0	Metric Bore Gage Setting Master Kit	\$407 18	<b>\$347.00</b>
53-646-005-0	Bore Gage Setting Master Kit - <b>without</b> Gage Blocks	\$247 69	<b>\$211.00</b>

## Electronic Calipers Comparison Chart

	Data Output	Wireless	IP Rating	IN/MM/Frac.	Sizes
Ultra-Cal VI Calipers	✓	✓	P67		6" 8" 12"
Ultralight IV Calipers	✓	✓	P67		15" 24" 40" 60" 80" 100"
IP67 Calipers	✓	✓	P67		6" 12"
Digital Calipers	✓	✓	P40		4" 6" 8" 12"
Carbon Fiber Calipers	✓		P65		24" 40" 60"
Xtra-Range Calipers	✓		P54		12" 24"
Xtra-Value PLUS Calipers			P54	✓	6" 12"
Xtra-Value Calipers					6" 8" 12"

## Swiss Ultralight IV Electronic Calipers

When you have **HUGE** parts to measure, this is the caliper you need!



### Features:

- P67 protected against fluid and dust
- Built in Bluetooth
- Reinforced frame
- XXL display with 0.79"/20mm high digits
- Lengthened jaws 7.9"/200mm
- includes upper D measuring pins (5mm dia)
- Movable left jaw
- Stainless steel titanium coated jaws
- Hold feature
- Preset function
- Min/Max functions
- Tolerance mode
- Internal and external measurement indicator



Alternative jaws available, contact the Fowler Technical Department for more information 1-800-788-2353

Order No.	Range	Accuracy	List Price	Sale Price
54-110-512-0	0 - 15"/0 - 400mm	0.0012"/30 μm	\$2,532.88	<b>\$2,153.00</b>
54-110-524-0	0 - 24"/0 - 600mm	0.0016"/40 μm	\$3,016.86	<b>\$2,565.00</b>
54-110-540-0	0 - 40"/0 - 1000mm	0.002"/50 μm	\$3,474.34	<b>\$2,954.00</b>
54-110-560-0	0 - 60"/0 - 1500mm	0.0035"/90 μm	\$4,564.28	<b>\$3,880.00</b>
54-110-580-0	0 - 80"/0 - 2000mm - <i>special order</i>	0.0048"/120 μm	\$7,048.49	<b>\$5,992.00</b>
54-110-600-0	0 - 100"/0 - 2500mm - <i>special order</i>	0.0078"/200 μm	\$8,585.95	<b>\$7,299.00</b>
Connectivity Cables/Accessories				
54-981-713-2	Sylcom Basic Data Processing Software		\$810.69	<b>\$771.00</b>
54-115-526-0	Proximity USB Cable		\$223.37	<b>\$202.00</b>
54-115-527-0	Proximity Serial Cable		\$216.29	<b>\$195.00</b>
54-115-246-BT	USB Bluetooth Receiver		\$49.45	<b>\$43.00</b>



# Swiss Ultra-Cal VI Electronic Calipers

3 styles to suit your needs.



54-100-167-0



54-100-444-1



## Features:

- P67 protected against fluid and dust
- Available with Bluetooth proximity cable or no SPC output
- Heavy duty frame
- Extra large display
- Available with SO Cert
- 12"/300mm is supplied without depth rod



**Calibration certificates available for all sizes.**

Order No.	Range	Accuracy	Resolution	List Price	Sale Price
Bluetooth Communication					
54-100-167-0	6"/150mm	0 0008"/20µm	0 0005"/0 01mm	\$425 08	<b>\$383.00</b>
54-100-168-0	8"/200mm	0 0012"/30µm	0 0005"/0 01mm	\$725 47	<b>\$653.00</b>
54-100-169-0	12"/300mm	0 0012"/30µm	0 0005"/0 01mm	\$886 25	<b>\$754.00</b>
Proximity Cable Communication					
54-100-444-1	6"/150mm	0 0008"/20µm	0 0005"/0 01mm	\$196 06	<b>\$177.00</b>
54-100-448-1	8"/200mm	0 0012"/30µm	0 0005"/0 01mm	\$439 69	<b>\$396.00</b>
54-100-412-1	12"/300mm	0 0012"/30µm	0 0005"/0 01mm	\$593 06	<b>\$534.00</b>
Without Data Output					
54-100-177-0	6"/150mm	0 0008"/20µm	0 0005"/0 01mm	\$169 18	<b>\$153.00</b>
54-100-178-0	8"/200mm	0 0012"/30µm	0 0005"/0 01mm	\$398 79	<b>\$359.00</b>
54-100-179-0	12"/300mm	0 0012"/30µm	0 0005"/0 01mm	\$460 06	<b>\$415.00</b>
Connectivity Cables/Accessories					
54-981-713-2	Sylcom Basic Data Processing Software			\$810 69	<b>\$771.00</b>
54-115-526-0	Proximity cable with USB Connection			\$223 37	<b>\$202.00</b>
54-115-527-0	Proximity cable with Serial Connection			\$216 29	<b>\$195.00</b>
54-115-246-BT	USB Bluetooth Receiver			\$49 45	<b>\$43.00</b>

Prices & Specifications are subject to change without notice

## IP67 Electronic Calipers

Smart Wireless Communication to most phones or tablets.



54-100-556-BT



### Features:

- P67 protected against fluid and dust
- Wireless connectivity for quick error free data collection
- Supplied with N ST certification
- Heavy duty frame with 4 way measuring inside outside depth and step
- Super large display
- Includes fitted case extra battery tray and a 1" setting standard

Order No.	Range	Accuracy	List Price	Sale Price
54-100-556-BT	0 - 6"/150mm	0 001"/0 02mm	\$211 24	<b>\$191.00</b>
54-100-512-BT	0 - 12"/300mm	0 0015"/0 04mm	\$259 54	<b>\$234.00</b>

## XTRA-VALUE<sup>Plus</sup> Electronic Calipers

IP54 protected with inch/metric/fractions.



### Features:

- Range 6"/150mm
- Accuracy  $\pm 0 001"/0 02mm$
- Inch/Metric/Fraction reading 0 0005"/0 01mm/ 1/128"
- Heavy Duty frame for extra rigidity and wear resistance
- Super large easy to read display
- Includes fitted case

Order No.	Range	Accuracy	List Price	Sale Price
54-103-006-0	0 - 6"/150mm	0 001"/0 02mm	\$98 98	<b>\$80.00</b>
54-103-012-0	0 - 12"/300mm	0 0015"/0 03mm	\$149 79	<b>\$128.00</b>

# Electronic Calipers

Absolute location retention after shut off.



54-100-000-2

### Features:

- Resolution 0.0005"/0.01mm
- Absolute/Incremental Measurement
- Stainless steel frame
- Direct Inch/Metric conversion
- 4 way measuring inside outside depth and step
- Wireless SPC data option
- Includes fitted case

Order No.	Range	Accuracy	List Price	Sale Price
54-100-004-2	4"/100mm	0.001"/0.02mm	\$143.24	<b>\$122.00</b>
54-100-000-2	6"/150mm	0.001"/0.02mm	\$161.96	<b>\$146.00</b>
54-100-008-2	8"/200mm	0.0015"/0.04mm	\$164.57	<b>\$140.00</b>
54-100-112-2	12"/300mm	0.0015"/0.04mm	\$226.48	<b>\$193.00</b>
Accessories				
54-115-100-0	Wireless transmitter		\$119.81	<b>\$114.00</b>

## XTRA-VALUE CAL Electronic Calipers

Value priced verniers.



54-101-150-2



54-101-300-1

### Features:

- Stainless steel frame
- Large easy to read display
- Resolution 0.0005"/0.01mm
- Absolute/Incremental measurement
- 4 way measuring inside outside depth and step
- 6" and 12" regular display models include N ST Cert
- Includes fitted case



Order No.	Range	Accuracy	List Price	Sale Price
54-101-150-2	6"/150mm - Regular Display	0.001"/0.02mm	\$54.93	<b>\$47.00</b>
54-101-600-1	6"/150mm - Large Display with Hold feature	0.0015"/0.04mm	\$75.62	<b>\$65.00</b>
54-101-200-1	8"/200mm - Regular Display	0.0015"/0.04mm	\$102.31	<b>\$87.00</b>
54-101-300-1	12"/300mm - Regular Display	0.0015"/0.04mm	\$125.48	<b>\$107.00</b>
54-101-900-1	12"/300mm - Large Display with Hold feature	0.0015"/0.04mm	\$165.55	<b>\$141.00</b>

Prices & Specifications are subject to change without notice

# XTRA-RANGE® Carbon Fiber Electronic Calipers



54-100-140-0

**NEW!**

## Features:

- P65 protected against fluid and dust
- Lightweight carbon fiber frame
- Stainless steel jaws with D nibs
- D/OD pressure device for repeatability
- USB data output (works with 54 520 399 0)
- Preset ABS/ NC Floating zero N/MM Hold function
- Super large display
- Fitted wooden case

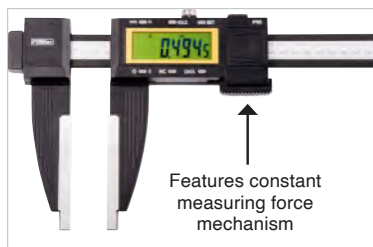

Features constant measuring force mechanism

Order No.	Range	Accuracy	Jaw Depth	Weight	List Price	Sale Price
54-100-124-0	0 - 24"/600mm	0 0020"/0 05mm	5 4"/138mm	2 85 lbs	\$825 00	<b>\$743.00</b>
54-100-140-0	0 - 40"/1000mm	0 0025"/0 06mm	5 4"/138mm	3 45 lbs	\$1,495 00	<b>\$1,346.00</b>
54-100-160-0	0 - 60"/1500mm	0 0055"/0 13mm	5 9"/150mm	4 4 lbs	\$1,995 00	<b>\$1,796.00</b>

# XTRA-RANGE® Electronic Calipers

For large measurements

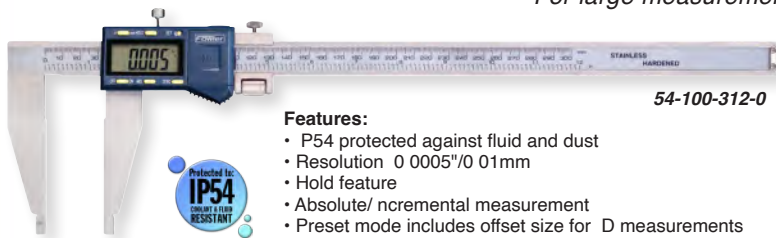

54-100-312-0

## Features:

- P54 protected against fluid and dust
- Resolution 0 0005"/0 01mm
- Hold feature
- Absolute/ incremental measurement
- Preset mode includes offset size for D measurements
- Both sizes feature fine adjustment



Order No.	Range	Accuracy	Jaw Depth	List Price	Sale Price
54-100-312-0	0 - 12"/300mm	0 002"/0 05mm	3 5"	\$266 68	<b>\$241.00</b>
54-100-024-1	0 - 24"/600mm	0 003"/0 075mm	4"	\$412 94	<b>\$372.00</b>

# XTRA-RANGE® Dial Calipers

With full length depth rod

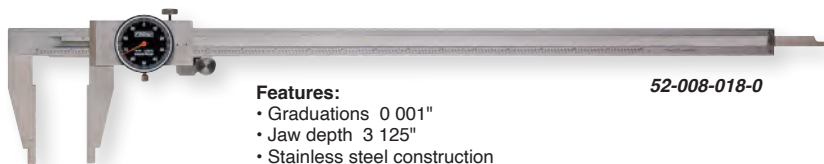

52-008-018-0

## Features:

- Graduations 0 001"
- Jaw depth 3 125"
- Stainless steel construction
- Satin chrome finish
- Full length depth rod
- 0 50" internal measuring nibs on jaws

Order No.	Range	Accuracy	List Price	Sale Price
52-008-018-0	0 - 18"	0 003"	\$292 40	<b>\$234.00</b>
52-008-024-0	0 - 24"	0 003"	\$354 33	<b>\$302.00</b>

# Premium Grade Dial Calipers

With mono-block housing for added protection.



24.2



52-008-706-0



52-008-707-0

### Features:

- Tough shockproof gearing with ultra smooth movement
- 4 way measuring inside outside depth and step
- nverted/covered rack
- Solid stainless steel construction with lapped measuring faces
- 0 100" range per revolution
- 0 001" reading dial

Order No.	Range	Dial Color	Accuracy	List Price	Sale Price
52-008-704-1	0 - 0"	White	0 001"	\$90 00	<b>\$77.00</b>
52-008-714-1	0 - 0"	Black	0 001"	\$90 00	<b>\$77.00</b>
52-008-706-0	0 - 6"	White	0 001"	\$102 74	<b>\$88.00</b>
52-008-707-0	0 - 6"	Black	0 001"	\$102 74	<b>\$88.00</b>
52-008-708-0	0 - 8"	White	0 0015"	\$123 37	<b>\$105.00</b>
52-008-712-0	0 - 12"	White	0 002"	\$165 88	<b>\$141.00</b>
Metric					
52-008-709-0	0 - 150mm	Yellow	0 02mm	\$105 93	<b>\$91.00</b>

## Dial Calipers



52-008-005-1

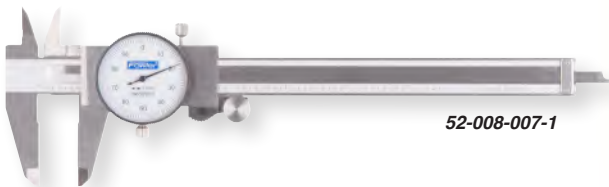

52-008-007-1

### Features:

- 4 way measuring for outside inside depths and steps
- Graduation 0 001"
- Hardened stainless steel throughout
- Covered rack
- Shockproof gearing

Order No.	Range	Dial Color	Accuracy	List Price	Sale Price
52-008-005-1	0 - 6"	Black	0 001"	\$85 00	<b>\$73.00</b>
52-008-007-1	0 - 6"	White	0 001"	\$85 00	<b>\$73.00</b>
52-008-008-1	0 - 8"	White	0 0015"	\$100 00	<b>\$85.00</b>
52-008-012-1	0 - 12"	White	0 002"	\$150 00	<b>\$128.00</b>

Calipers





## Electronic Micrometers Comparison Chart

	Data Output	Wireless	IP Rating	Sizes
RAPID-MIC Micrometers	✓	✓	P67	0 4"
DIGI-MIC Micrometers		✓	P67	0 1"
Xtra-MIC PLUS Mics	✓		P54	0 4"
Coolant Resistant Mics			P54	0 4"
Xtra-Value II Micrometers			P40	0 4"

## Rapid-Mic Quick-Displacement Electronic Micrometers

*Fastest micrometer on the market!*



54-815-030-0



### Features:

- P67 protected against fluid and dust
- Non rotating spindle with 0 39"/10mm travel per thimble rotation
- Adjustable measuring force 5N/10N (54 815 030 0 and 54 815 130 0 only)
- Menu customizable with free software
- Larger sizes and specialty anvil micrometers also available

**Calibration certificates available for all sizes.**

Order No.	Range	Accuracy	List Price	Sale Price
54-815-030-0	0 - 1 18"/0 - 30mm	0 00012"/0 003mm	\$625 88	<b>\$532.00</b>
54-815-060-0	1 18" - 2 6"/30 - 66mm	0 00016"/0 004mm	\$1,134 49	<b>\$1,022.00</b>
54-815-100-0	2 6" - 4 0"/66 - 102mm	0 00020"/0 005mm	\$1,237 69	<b>\$1,114.00</b>
Set				
54-815-111-0	0 - 4"/0 - 102mm		\$2,851 16	<b>\$2,424.00</b>
Bluetooth Models				
54-815-130-0	0 - 1 18"/0 - 30mm	0 00012"/0 003mm	\$986 19	<b>\$888.00</b>
54-815-160-0	1 18" - 2 6"/30 - 66mm	0 00016"/0 004mm	\$1,311 38	<b>\$1,216.00</b>
54-815-110-0	2 6" - 4 0"/66 - 102mm	0 00020"/0 005mm	\$1,553 60	<b>\$1,259.00</b>
Bluetooth Set				
54-815-112-0	0 - 4"/0 - 102mm		\$3,706 17	<b>\$3,218.00</b>
Connectivity Cables/Accessories				
54-981-713-2	Sylcom Basic Data Processing So tware		\$810 68	<b>\$771.00</b>
54-981-724-5	Sylcom Pro Data Processing So tware		\$1,939 95	<b>\$1,843.00</b>
54-115-526-0	Proximity cable with USB connection		\$223 37	<b>\$202.00</b>
54-115-527-0	Proximity cable with serial connection		\$216 29	<b>\$195.00</b>
54-115-246-BT	USB Bluetooth receiver		\$49 45	<b>\$43.00</b>

# DigiMic Electronic Micrometer

The world standard of precision with IP67 and Bluetooth®.



24.2



### Features:

- P67 protected against fluid and dust
- Very High Accuracy 0.00008"/0.002mm (0.1"/25mm)
- Bluetooth OT ready no dongle or cable required for SPC data collection
- Carbide measuring surfaces sleep and absolute modes



BOWERS GROUP



Order No. 54-816-025-0

Calibration certificate available.

**Sale \$644.00**

List Price \$886.83

## XTRA-MIC PLUS Electronic Micrometers



54-880-001-0



**25% off**

Limited quantities



### Features:

- P54 protected against fluid and dust
- Super large LCD display 14mm height
- Resolution 0.00005"/0.001mm
- Carbide tipped anvil and spindle

Order No.	Range	Accuracy	List Price	Sale Price
54-880-001-0	0 - 1"/0 - 25mm	0.00016"/0.004mm	\$152.25	<b>\$115.00</b>
54-880-002-0	1 - 2"/25 - 50mm	0.00016"/0.004mm	\$194.98	<b>\$153.00</b>
54-880-003-0	2 - 3"/50 - 75mm	0.0002"/0.005mm	\$208.44	<b>\$163.00</b>
54-880-004-0	3 - 4"/75 - 100mm	0.0002"/0.005mm	\$239.01	<b>\$162.00</b>
Set				
54-880-103-0	0 - 3"/0 - 75mm		\$538.08	<b>\$384.00</b>

## Electronic IP54 Blade Micrometers



54-860-241-0



### Features:

- P54 protected against fluid and dust
- Blades are 0.030" thick x 0.255" long
- Accuracy 0.00016"
- Resolution 0.00005"/0.001mm
- Friction thimble

Order No.	Range	List Price	Sale Price
54-860-241-0	0 - 1" Blade Anvil	\$300.90	<b>\$241.00</b>
54-860-242-0	1" - 2" Blade Anvil with standard	\$374.04	<b>\$300.00</b>

Prices & Specifications are subject to change without notice

25

Micrometers



# Electronic Coolant Resistant Micrometers

For basic outside measurements with higher protection.



#### Features:

- P54 protected against fluid and dust
- Resolution 0 00005"/0 001mm
- Carbide measuring faces
- Absolute & incremental modes
- Ratchet thimble
- Automatic switch off
- Free ball attachment included
- Sizes over 1"/25mm include a calibration standard

Order No.	Range	Accuracy	List Price	Sale Price
54-860-001-1	0 - 1"/0 - 25mm	0 00016"/0 004mm	\$157 14	<b>\$126.00</b>
54-860-002-1	1 - 2"/25 - 50mm w/standard	0 00016"/0 004mm	\$181 88	<b>\$146.00</b>
54-860-003-1	2 - 3"/50 - 75mm w/standard	0 0002"/0 005mm	\$190 70	<b>\$138.00</b>
54-860-004-1	3 - 4"/75 - 100mm w/standard	0 0002"/0 005mm	\$221 40	<b>\$169.00</b>
Set				
54-860-103-1	0 - 3"/0 - 75mm w/standard		\$516 67	<b>\$414.00</b>

## XTRA-VALUE II Electronic Micrometers



#### Features:

- P40 protected against fluid and dust
- Resolution 0 00005"/0 001mm
- Carbide measuring faces
- Absolute and incremental modes
- Ratchet thimble
- Free ball attachment included
- Sizes over 1"/25mm include a calibration standard

Order No.	Range	Accuracy	List Price	Sale Price
54-870-001-0	0 - 1"/0 - 25mm	0 00016"/0 004mm	\$107 28	<b>\$86.00</b>
54-870-002-0	1" - 2"/25 - 50mm	0 00016"/0 004mm	\$115 85	<b>\$93.00</b>
54-870-003-0	2" - 3"/50 - 75mm	0 0002"/0 005mm	\$138 56	<b>\$111.00</b>
54-870-004-0	3" - 4"/75 - 100mm	0 0002"/0 005mm	\$169 62	<b>\$136.00</b>
Set				
54-870-103-0	0 - 3"/0 - 75mm		\$346 42	<b>\$278.00</b>

# Digit Counter Micrometers

0.001" digit counter.



52-224-001-1

### Features:

- Digital counter reads to 0 001"
- Graduations 0 0001" (using vernier)
- Microfine graduations on satin chrome
- Carbide tipped measuring faces
- Sizes over 1"/25mm include a standard
- Includes case

Order No.	Range	Accuracy	List Price	Sale Price
52-224-001-1	0 - 1"	0 00016"	\$125 49	<b>\$95.00</b>
52-224-002-1	1" - 2"	0 00016"	\$131 81	<b>\$93.00</b>
52-224-003-1	2" - 3"	0 0002"	\$150 12	<b>\$106.00</b>
52-224-004-1	3" - 4"	0 0002"	\$189 08	<b>\$133.00</b>
52-224-005-1	4" - 5"	0 00024"	\$194 27	<b>\$123.00</b>
52-224-006-1	5" - 6"	0 00024"	\$203 08	<b>\$128.00</b>
Sets				
52-224-103-0	0 - 3" set (set finished in grey enamel)		\$396 05	<b>\$278.00</b>
52-224-104-0	0 - 4" set (set finished in grey enamel)		\$561 69	<b>\$394.00</b>
52-224-220-0	0 - 75mm set (set finished in grey enamel)		\$463 37	<b>\$292.00</b>

# Digit Counter Ball Anvil Micrometers



52-244-201-1

### Features:

- Microfine graduations on satin chrome
- Digital counter reads to 0 001" sleeve reads to 0 0001"
- Spindle hardened and precision ground with a carbide tipped measuring face
- Ratchet stop thimble
- Accuracy 0 00016" Graduation 0 0001"

Order No.	Range	List Price	Sale Price
52-244-201-1	0 - 1" Ball Anvil	\$135 89	<b>\$96.00</b>
52-244-301-1	1" - 2" Ball Anvil/Ball Spindle	\$164 99	<b>\$116.00</b>

# Digit Counter Disc Micrometers



### Features:

- Anvil and spindle are hardened and precision ground
- Flatness 0 00004"
- Accuracy 0 00016" Graduation 0 0001"
- Disc edge thickness 0 035" disc dia 0 708"
- Ratchet thimble
- The disc type anvil and spindle simplifies measuring the thickness of difficult closely spaced sections

Order No. 52-250-301-1

**Sale \$143.00**

List Price \$178.70

# Outside Vernier Micrometers

0.0001" graduations for higher accuracy.



52-240-001-1



52-215-003-1

### Features:

- Graduation 0 0001"
- Microfine graduations on satin chrome finish and carbide tipped measuring faces
- Diameter of measuring faces 0 256"
- Flatness 0 00003"
- Spindle thread hardened ground and lapped for ultimate accuracy
- Includes a wrench and case
- Sizes over 1"/25mm include a standard

Order No.	Range	Accuracy	Thimble	List Price	<del>Safe Price</del>
52-240-001-1	0 - 1"	0 00016"	raction	\$45 94	<b>\$40.00</b>
52-240-101-1	0 - 1"	0 00016"	Ratchet	\$45 94	<b>\$40.00</b>
52-240-002-1	1" - 2"	0 00016"	raction	\$53 43	<b>\$46.00</b>
52-240-102-1	1" - 2"	0 00016"	Ratchet	\$61 14	<b>\$52.00</b>
52-240-003-1	2" - 3"	0 0002"	Ratchet	\$62 43	<b>\$54.00</b>
52-240-004-1	3" - 4"	0 0002"	Ratchet	\$79 78	<b>\$68.00</b>
52-240-005-1	4" - 5"	0 00024"	Ratchet	\$88 36	<b>\$76.00</b>
52-240-006-1	5" - 6"	0 00024"	Ratchet	\$96 81	<b>\$83.00</b>
52-240-007-1	6" - 7"	0 00028"	Ratchet	\$105 26	<b>\$90.00</b>
52-240-008-1	7" - 8"	0 00028"	Ratchet	\$108 25	<b>\$93.00</b>
52-240-009-1	8" - 9"	0 00032"	Ratchet	\$123 03	<b>\$105.00</b>
52-240-010-1	9" - 10"	0 00032"	Ratchet	\$139 52	<b>\$119.00</b>
52-240-011-1	10" - 11"	0 00036"	Ratchet	\$154 30	<b>\$132.00</b>
52-240-012-1	11" - 12"	0 00036"	Ratchet	\$193 48	<b>\$165.00</b>
Sets					
52-215-003-1	0 - 3" with standards and fitted shop hardened case			\$183 19	<b>\$147.00</b>
52-215-004-1	0 - 4" with standards and fitted shop hardened case			\$262 46	<b>\$224.00</b>
52-215-006-1	0 - 6" with standards and fitted shop hardened case			\$445 54	<b>\$379.00</b>
52-215-012-1	0 - 12" with standards and fitted case			\$1,350 70	<b>\$1,130.00</b>
52-215-612-1	6 - 12" with standards and fitted case			\$891 07	<b>\$758.00</b>



# Outside Vernier Micrometers

0.001" readings.



52-253-001-1



**Features:**

- Graduation 0 001"
- Carbide tipped measuring faces
- Diameter of measuring faces 0 256"
- Anvil & spindle hardened and precision ground with microlap finish on tips
- Sizes over 1"/25mm include a standard

Order No.	Range	Accuracy	Thimble	List Price	Sale Price
52-253-001-1	0 - 1"	0 001"	raction	\$38 66	<b>\$33.00</b>
52-253-101-1	0 - 1"	0 001"	Ratchet	\$38 66	<b>\$33.00</b>
52-253-002-1	1" - 2"	0 001"	raction	\$52 58	<b>\$45.00</b>
52-253-102-1	1" - 2"	0 001"	Ratchet	\$45 94	<b>\$40.00</b>
52-253-003-1	2" - 3"	0 001"	Ratchet	\$61 15	<b>\$52.00</b>
52-253-004-1	3" - 4"	0 001"	Ratchet	\$62 43	<b>\$54.00</b>
52-253-005-1	4" - 5"	0 001"	Ratchet	\$69 71	<b>\$60.00</b>
52-253-006-1	5" - 6"	0 001"	Ratchet	\$77 21	<b>\$66.00</b>

# Outside Vernier Micrometer Set

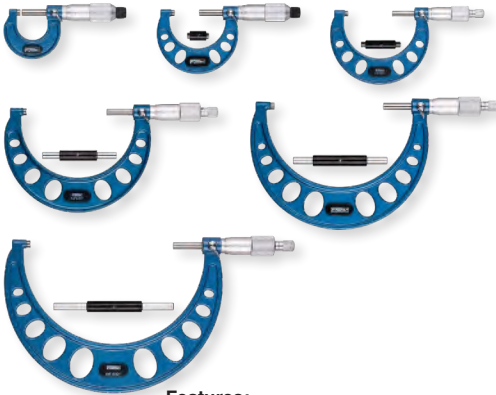

**Features:**

- Range 0 6"
- Carbide tipped measuring faces
- Graduation 0 001"
- Diameter of measuring faces 0 256"
- Anvil & spindle hardened and precision ground with microlap finish on tips
- Sizes over 1" include a standard

Order No. 52-253-600-1

**Sale \$302.00**

L st Pr ce \$354.41



## Electronic IP65 Thread Micrometers

For accurate pitch diameter measurements



54-219-001-0

### Features:

- P65 protected against fluid and dust
- Thread range 64 3 5 TP /0 4 7mm
- Accuracy  $\pm 0.00008''/0.002\text{mm}$
- 60° measuring anvils
- Absolute and incremental measuring mode
- Resolution 0.00005''/0.001mm
- Friction thimble

Order No.	Range	Thread Range	Accuracy	List Price	Sale Price
54-219-001-0	0 - 1''/0 - 25mm	64 - 5 P /0 4 - 5mm	0.00008''/0.002mm	\$289.94	<b>\$261.00</b>
54-219-002-0	1'' - 2''/25 - 50mm	44 - 3.5 P /0 6 - 7mm	0.00008''/0.002mm	\$349.06	<b>\$315.00</b>

## Vernier Thread Micrometers



52-219-001-1

### Features:

- 60° measuring anvils
- Graduation 0.001''
- Ratchet thimble
- Sizes over 1'' include standard

Order No.	Range	Thread Range	Accuracy	List Price	Sale Price
52-219-001-1	0 - 1''	64 - 5 P /0 4 - 5mm	0.00016''	\$132.54	<b>\$120.00</b>
52-219-002-1	1'' - 2''	44 - 3.5 P /0 6 - 7mm	0.00016''	\$127.49	<b>\$115.00</b>

## Micrometer Stands



52-247-005-0

### Features:

- Unique locking system adjusts micrometer stand to any position for perfect use and viewing
- Stand folds for storage

## XTRA MAG®

### Features:

- Holds standard 0.125'' micrometers firmly to metal surfaces
- Use at machine centers assembly and inspection stations steel tables and shelves
- V bottom for mounting on cylindrical surfaces
- On/Off magnet switch
- Base is 2.30'' L x 1.20'' W x 3.50'' H



52-247-010-0

Micrometer not included

Order No.	Description	List Price	Sale Price
52-247-005-0	olding Micrometer Stand	\$48.66	<b>\$40.00</b>
52-247-010-0	Magnetic Micrometer Stand	\$77.48	<b>\$70.00</b>

# IP54 Electronic Depth Micrometer

## Features:

- P54 protected against fluid and dust
- Range 0 - 6"/150 mm
- Resolution 0.00005"/0.001mm
- Base surface hardened and microlapped to 0.00008" flatness
- Rod diameter 0.176"
- Includes fitted case



Order No. 54-225-456-0

**Sale \$226.00**

List Price \$250.55

# Digit Counter Depth Micrometers

## Features:

- Easy to read digit counter
- Microfine 0.001" graduations
- Base surface hardened and microlapped to 0.00008" flatness
- Ratchet thimble
- Rod diameter 0.176"
- Includes wrench and fitted case



52-225-226-0

Order No.	Range	Graduation	Accuracy	Base Size	List Price	Sale Price
52-225-176-0	0 - 6"	0.001"	0.0002"	2.5"	\$219.24	<b>\$198.00</b>
52-225-226-0	0 - 6"	0.001"	0.0002"	4"	\$243.57	<b>\$208.00</b>

# Vernier Depth Micrometers

## Features:

- Base surface hardened and microlapped to 0.00008" flatness
- Ratchet thimble
- Locking clamp
- Rod diameter 0.176"
- Includes fitted case

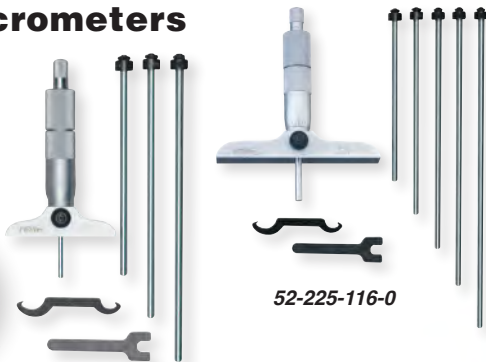

52-225-110-0

52-225-116-0

Order No.	Range	Graduation	Accuracy	Base Size	List Price	Sale Price
52-225-110-0	0 - 4"	0.001"	0.0002"	2.5"	\$157.44	<b>\$142.00</b>
52-225-112-0	0 - 6"	0.001"	0.0002"	2.5"	\$201.58	<b>\$182.00</b>
52-225-114-0	0 - 4"	0.001"	0.0002"	4"	\$161.14	<b>\$146.00</b>
52-225-116-0	0 - 6"	0.001"	0.0002"	4"	\$188.55	<b>\$170.00</b>

# Electronic Indicators Comparison Chart

	Data Output	Wireless Option	IP Rating	IN/MM/Frac.
MARK VI indicators	✓	✓	P54	
Mini-S indicators	✓	✓	P67	
Quadra-TEST indicators	✓	✓	P65	
Indi-X BT indicators		✓	P65	
Indi-X indicators				✓



54-530-335-0



## Mark VI Electronic Indicators

Our BEST electronic indicators!

**Features:**

- P54 protected against fluid and dust
- Output Proximity/Power USB/RS232/digimatic/Wireless
- Functions (M N/MAX/DELTA TOL Factor Preset Auto Off)
- Large display with LED tolerance indicators



Calibration certificates available for all sizes.

Order No.	Range	Accuracy	Resolution	List Price	Sale Price
Low Resolution					
54-530-125-0	0 - 0 500"/12 5mm	0 0004"/0 01mm	0 0005"/0 01mm	\$576 32	<b>\$519.00</b>
54-530-145-0	0 - 1"/25mm	0 0004"/0 01mm	0 0005"/0 01mm	\$657 81	<b>\$593.00</b>
High Resolution					
54-530-135-0	0 - 0 500"/12 5mm	0 00012"/0 003mm	0 00005"/0 001mm	\$713 10	<b>\$614.00</b>
54-530-155-0	0 - 1"/25mm	0 00016"/0 004mm	0 00005"/0 001mm	\$681 61	<b>\$642.00</b>
54-530-175-0	0 - 2"/50mm	0 00019"/0 005mm	0 00005"/0 001mm	\$1,368 02	<b>\$1,232.00</b>
Bluetooth					
54-530-335-0	0 - 0 500"/12 5mm	0 00012"/0 003mm	0 00005"/0 001mm	\$902 32	<b>\$813.00</b>
54-530-355-0	0 - 1"/25mm	0 00016"/0 004mm	0 00005"/0 001mm	\$841 84	<b>\$758.00</b>
Accessories					
54-981-713-2	Sylcom Basic Data Processing Software			\$810 69	<b>\$771.00</b>
54-981-724-5	Sylcom Pro Digital License			\$1 939 95	<b>\$1,843.00</b>
54-115-246-BT	USB Bluetooth Receiver			\$49 45	<b>\$43.00</b>



54-520-285-0



54-520-280-0



## INDI-X<sup>®</sup> BT Electronic Indicators

Smart Wireless Communication to most phones and tablets

**Features:**

- Bluetooth compatible to most phones and tablets
- Resolution 0 00005"/0 001mm
- Economical bluetooth option
- includes lifting hook ceramic ball contact point 2 specialty contact points (spline and point) N ST cert lug and flat backs

Calibration certificates available for all sizes.

Order No.	Range	Accuracy	List Price	Sale Price
54-520-280-0	0 - 1"/25mm	0 00035"/0 008mm	\$185 80	<b>\$165.00</b>
54-520-285-0	0 - 0 50"/12 5mm	0 00030"/0 007mm	\$179 67	<b>\$159.00</b>



Our most popular electronic indicators.



54-520-255-0

54-520-250-0



54-520-260-0

### Features:

- Accuracy  $\pm 0.001"/0.03\text{mm}$
- Resolution  $0.0005"/0.01\text{mm}$
- 54-520-260-0 also reads 1/64ths
- 2 1/4" dial face
- Lugback and 3/8" stem mountings
- Tolerance function
- Absolute/incremental reading
- Floating zero

Calibration certificates available for all sizes.

Order No.	Range	List Price	Sale Price
54-520-255-0	0.50"/12.5mm	\$117.77	<b>\$95.00</b>
54-520-250-0	1"/25mm	\$133.36	<b>\$107.00</b>
54-520-260-0	1"/25mm	\$135.38	<b>\$109.00</b>

## Mini S\_Dial Indicators

Small in size BIG in features!

### Features:

- Bluetooth connectivity to your phone or tablet
- P67 protected against fluid and dust
- All indicators feature 0.50"/12.5mm range
- Analog scale for reversal point indication Min/Max multiplication factor (Bluetooth® models only)
- 3/8" mounting diameter with 4-48 contact thread
- Auto power off feature
- Optional cable connectivity output



54-520-687-BT

54-520-692-0



Calibration certificates available for all sizes.

Order No.	Accuracy	Resolution	List Price	Sale Price
Bluetooth Models				
54-520-687-BT	0.0004"/0.01mm	0.0005"/0.01mm	\$592.58	<b>\$534.00</b>
54-520-690-BT	0.0002"/0.005mm	0.00005"/0.001mm	\$860.27	<b>\$775.00</b>
Basic Models (Zero set, preset, in/mm, measuring direction)				
54-520-691-0*	0.0004"/0.01mm	0.0005"/0.01mm	\$498.06	<b>\$449.00</b>
54-520-692-0*	0.0002"/0.005mm	0.00005"/0.001mm	\$687.64	<b>\$619.00</b>
Accessories				
54-981-713-2	Sylcom Basic Data Processing Software		\$810.69	<b>\$771.00</b>
54-115-528-0	USB Power Cable		\$323.34	<b>\$292.00</b>

\*Bluetooth models feature zero data preset direction min/max/delta resolution multiplication factor



# Premium Dial Indicators

Smooth, accurate and built tough.

**Features:**

- AGD Group 2 specifications
- Shockproof gearing
- Jeweled movement
- Tolerance markers
- Solid steel housing
- Carbide contact point
- Includes N ST Certification



52-520-135-0



52-520-105-0



52-520-110-1



Order No.	Range	Graduation	Reading	Balanced Reading	Dial Color	List Price	Sale Price
52-520-135-0	0 05"	0 0001"	0 - 10	0 - 5 - 0	White	\$205 54	<b>\$155.00</b>
52-520-105-0	0 50"	0 001"	0 - 100	0 - 50 - 0	White	\$105 64	<b>\$72.00</b>
52-520-110-1	1"	0 001"	0 - 100	—	Black	\$100 53	<b>\$76.00</b>
52-520-110-2	1"	0 001"	0 - 100	—	White	\$100 53	<b>\$76.00</b>
52-520-120-0	2"	0 001"	0 - 100	—	White	\$160 28	<b>\$121.00</b>
52-520-125-0	0 250"	0 0005"	0 - 100	—	White	\$147 39	<b>\$100.00</b>
52-520-129-0	1"	0 0005"	0 - 50	0 - 25 - 0	White	\$121 52	<b>\$92.00</b>
52-520-300-0	10mm	0 01mm	0 - 100	0 - 50 - 0	White	\$127 54	<b>\$87.00</b>
52-520-500-0	25mm	0 01mm	0 - 100	0 - 50 - 0	White	\$153 00	<b>\$115.00</b>

## Vertical Long Reach Test Indicator



**Features:**

- 3 077" extra long contact point
- Graduations 0 001"
- Jeweled movement
- Automatic reversal
- Dovetails on top and bottom of main body
- Includes fitted case

VERDICT



Order No. 52-555-022-0

**Sale \$356.00**

List Price \$374.85





# Electronic Test Indicators

### Features:

- Bluetooth connectivity to your phone or tablet
- P65 protected against fluid and dust
- 4 measuring modes Min Max T R and Direct
- 4 measuring resolutions 0.00005"/0.001mm or 0.0005"/0.01mm
- 1 1/2" diameter dial face rotates a full 360°
- Analog scale for reversal point indication
- Meets or exceeds D N/ SO Standards (Maximum error on 0.00005" scale at full range 0.0004")
- 54-562-890 BT is capable of interchanging contact point lengths



54-562-777-BT



Calibration certificates available for all sizes.

Order No.	Range	Contact Point Length	List Price	Sale Price
54-562-777-BT	0.030"/0.80mm	1/2"	\$582.41	<b>\$486.00</b>
54-562-888-BT	0.080"/2.0mm	1-7/16"	\$658.71	<b>\$560.00</b>
54-562-890-BT	0.030"/0.80mm 0.080"/2.0mm	1/2" 1-7/16"	\$820.82	<b>\$698.00</b>
Accessories				
54-981-713-2	Sylcom Basic Data Processing Software		\$810.68	<b>\$771.00</b>
54-115-528-0	USB Power Cable		\$323.33	<b>\$292.00</b>

# X-TEST®

## Horizontal & Vertical Test Indicators

### Features:

- Super smooth jeweled movement
- Smooth bezel adjustment for easy zero setting
- Solid brass anti-magnetic housing
- 0.080" and 0.120" carbide ball contact points (0.040" steel ball)
- 0.060" range with auto reverse and rev. counter
- Easy to read tilted dial
- 5/32" pivotable stem



52-562-005-0



52-562-001-0



52-562-002-BD

Order No.	Graduation	Dial Size	Dial Reading	List Price	Sale Price
Horizontal					
52-562-001-0	0.0005"	1-1/2"	0 - 15 - 0	\$143.15	<b>\$122.00</b>
52-562-001-BD	0.0005"	1-1/2"	0 - 15 - 0	\$143.15	<b>\$122.00</b>
52-562-002-BD	0.0005"	1-1/2"	0 - 15 - 0	\$159.05	<b>\$122.00</b>
52-562-003-0	0.001"	1"	0 - 15 - 0	\$163.82	<b>\$140.00</b>
52-562-008-0	0.01mm	38mm	0 - 40 - 0	\$159.41	<b>\$140.00</b>
Vertical					
52-562-004-0	0.0005"	1-1/2"	0 - 15 - 0	\$156.75	<b>\$118.00</b>
52-562-005-0	0.0005"	1"	0 - 15 - 0	\$174.16	<b>\$135.00</b>



## S Depth Gages

Perfect for measuring depths, groove widths, slot widths, recess heights, step heights and through holes.

### Features:

- P67 protected against fluid and dust
- Bluetooth connectivity to your phone or tablet
- 3 measuring styles available
- 4"/100mm measuring base as standard
- Optional probes available for 54 139 160 0 series
- Extra large display
- Absolute measuring system



Rotary Pin Series  
54-139-162-3



54-139-161-1



54-139-160-5



Contact our Technical Department for optional bases and contacts

Order No.	Description	List Price	Sale Price
54-139-160-1	8"/200mm interchangeable Anvil Bluetooth Depth Gage	\$1,349 30	<b>\$1,215.00</b>
54-139-160-3	12"/300mm interchangeable Anvil Bluetooth Depth Gage	\$1,555 30	<b>\$1,400.00</b>
54-139-160-5	19"/500mm interchangeable Anvil Bluetooth Depth Gage	\$2,080 60	<b>\$1,873.00</b>
54-139-161-1	8"/200mm Standard Style Bluetooth Depth Gage	\$1,240 00	<b>\$1,150.00</b>
54-139-161-3	12"/300mm Standard Style Bluetooth Depth Gage	\$1,410 00	<b>\$1,269.00</b>
54-139-161-5	19"/500mm Standard Style Bluetooth Depth Gage	\$1,780 00	<b>\$1,651.00</b>
54-139-162-1	8"/200mm Rotary Pin Bluetooth Depth Gage	\$1,340 00	<b>\$1,243.00</b>
54-139-162-3	12"/300mm Rotary Pin Bluetooth Depth Gage	\$1,510 00	<b>\$1,400.00</b>
54-139-162-5	19"/500mm Rotary Pin Bluetooth Depth Gage	\$2,111 50	<b>\$1,901.00</b>

## X-DEPTH 22" 0 - 22" Dial Depth Gage



### Features:

- 0 1" travel indicator with 4" base
- 0 001" Graduations
- Rods connect together for full 22" capacity
- Satin chrome finish
- Includes 2 extra points for small hole applications; one 0 078" dia x 1" long and one needle point x 1" long

Order No. 52-125-006-1

**Sale \$169.00**

List Price \$224.29

## X-DEPTH 22" 0 - 22" Electronic Depth Gage

Provides rapid electronic measurement of hole depths.



### Features:

- 0 1" AGD Group 2
- Resolution 0 0005"/0 01mm
- 4" base ground and lapped for flatness
- Rods connect for 22" capacity
- Includes 2 extra points (spline & needle)
- Tolerance function

Order No. 54-125-777-0

**Sale \$279.00**

List Price \$349.23

# Granite Dial Gage Stand

*Sturdy with 0.00005" flatness*

**Features:**

- 6" x 6" x 2" granite base
- Positive lock screw
- Fine adjustment knob for zero setting
- Column height is 8"
- Accepts all lug back indicators
- This stand is maintenance free



**Order No. 52-580-030-0**

**Sale \$108.00**

List Price \$133.84

## Magnetic Bases

**Features:**

- 9 5" Height and 85 lb pull
- Base dimensions are 2" x 2 11/32" x 1 13/16" (50mm x 58.7mm x 46mm)
- Accepts all AGD dial indicators
- V bottom base allows mounting on cylindrical surfaces
- Mounts test indicators with 1/4" post mount



52-585-005-0



52-585-010-0

Order No.	Description	List Price	Sale Price
52-585-005-0	Magnetic Base	\$66.08	<b>\$50.00</b>
52-585-010-0	Magnetic Base with fine adjustment	\$70.98	<b>\$54.00</b>

## Hydraulic Arm Magnetic Base

*Heavy duty holding power*

**Features:**

- Adjusts to virtually any position
- All purpose magnetic base with 180 lbs of pulling power
- Fine adjustment
- Base can be mounted vertically as well as horizontally
- V bottom base allows mounting on cylindrical surfaces



**Order No. 52-585-095-0**

**Sale \$201.00**

List Price \$267.42

## Clinotronic-S

The Clinotronic S is a portable precision instrument for measuring inclinations up to  $\pm 45^\circ$

The large backlit high contrast color display provides excellent readability even under adverse conditions in the workshop or under a machine

The Clinotronic S can be connected to an Android™ device which can then be used as a remote display This new feature makes the instrument much more versatile and suitable for many applications It is built on the success of the Clinotronic PLUS while retaining the features that made it famous like its reliability and versatility plus it adds the latest technology



### Features:

- Wireless functionality (APP wylerUN VERSAL for Android™)
- Data transmission via USB cable as well
- User friendly
- Adjustable to local gravity
- Improved mechanical accuracy
- Excellent color display with low power consumption



Order No. 54-635-605-0

**Sale \$3,762.00**

List \$4,181.48

## Clinotronic Plus

The Fowler Wyler Clinotronic Plus is an electronic level with unsurpassed versatility It is economically priced uses a specially designed microprocessor and the well proven Wyler inclination sensor



### Features:

- Range of  $\pm 45^\circ$  capacity of 0-360°
- Resolution of 0.01° (selectable)
- Absolute or relative measuring mode selectable by push button
- Seal tec technology for excellent performance even in difficult environmental conditions
- Interface connection RS 232 is integrated Special purpose cables available
- No loss of calibration data by power failure
- Response time value available within 5 seconds
- Repeatability < 0.1°
- Linearity 3 min of arc + 1
- Housing aluminum hard anodized
- Dimensions 4 x 3 x 1" (100 x 75 x 30mm)



Order No. 54-635-601-0

**Sale \$2,248.00**

List \$2,496.69



# mini-MAG Protractor

The mini MAG Protractor provides instant 360° digital inclination display of any angle

**Features:**

- Accuracy  $\pm 0.2^\circ$
- Resolution 0.05°
- Embedded magnets
- Display automatically inverts
- Dimensions 2.375" x 1.375" x 2.375"
- Hold feature
- Battery Life up to 250 hrs



Display inverts for easy reading!



Order No. 54-422-450-1

**Sale \$92.00**

List Price \$108.05

# mini-MAG II

The mini MAG Protractor provides instant 360° digital inclination display of any angle

**Features:**

- On/off tilt % light zero functions
- Display is backlit for low light areas
- Embedded magnets with 3.5lb pull
- Display automatically inverts
- Measuring range 360° (4 x 90°)
- Accuracy  $\pm 0.2^\circ$
- Resolution 0.05°
- Dimensions 2.375" x 1.375" x 2.375"
- Hold feature



Order No. 54-422-460-0

**Sale \$107.00**

List Price \$133.60

# Digi Level PLUS+

with smart wireless data



**Features:**

- P65 protected against fluid and dust
- Large auto inverting display
- Includes a 6" straight edge with beveled edge and 1/32nds graduations
- Smart wireless available to connect to phone or tablet
- V's on top and bottom for measuring on cylindrical surfaces
- Embedded magnets on bottom base for vertical and horizontal hold
- Accuracy  $\pm 0.2^\circ$
- Resolution 0.050°

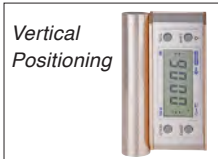

Order No.	Description	List Price	Sale Price
54-422-550-0	Digi-Level PLUS	\$156.88	<b>\$133.00</b>
54-422-550-BT	Digi-Level PLUS with smart wireless	\$177.30	<b>\$151.00</b>

Prices & Specifications are subject to change without notice

# Rules

## EZ-Read Black Face Rules

- Hardened stainless steel
- White easy to read microfine graduations against a black non glare finish

## Satin Chrome Rules

- Tempered steel
- Non glare
- Sharp easy to read microfine graduations

## Rigid Steel Rules

Order No.	Finish	Size	Reading	List Price	Sale Price
52-330-006-0	Satin Chrome	6"	4R	\$15 58	<b>\$14.00</b>
52-337-006-0	Black	6"	4R	\$12 39	<b>\$11.00</b>
52-330-012-0	Satin Chrome	12"	4R	\$26 60	<b>\$24.00</b>
52-337-012-0	Black	12"	4R	\$23 84	<b>\$22.00</b>
52-350-006-0	Satin Chrome	6"	16R	\$14 34	<b>\$13.00</b>
52-338-006-0	Black	6"	16R	\$15 23	<b>\$14.00</b>
52-350-012-0	Satin Chrome	12"	16R	\$32 70	<b>\$28.00</b>

## Flexible Steel Rules

Order No.	Finish	Size	Reading	List Price	Sale Price
52-295-006-0	Satin Chrome	6"	4R	\$12 93	<b>\$12.00</b>
52-297-006-0	Black	6"	4R	\$12 77	<b>\$11.00</b>
52-295-012-0	Satin Chrome	12"	4R	\$26 84	<b>\$25.00</b>
52-297-012-0	Black	12"	4R	\$18 75	<b>\$17.00</b>
52-308-006-0	Black	6"	16R	\$12 41	<b>\$11.00</b>
52-310-006-0	Satin Chrome	6"	16R	\$13 35	<b>\$12.00</b>
52-308-012-0	Black	12"	16R	\$18 75	<b>\$17.00</b>

## Metal Etching Pen



A "must" for any tool room and machine shop for general marking purposes. Fowler's metal etching pen is used on copper, copper alloy, stainless steel, hardened steel tools and castings, etc. Use it to initial personal tools. Its low cost, disposable design offers limitless applications. Over all length is 6 1/4"

Order No. 52-730-005-0

**Sale \$17.75**

List Price \$22.18

## Carbide Super Scriber



- Lightweight
- Retractable carbide tip
- Knurled grip
- Machined aluminum body
- Pocket clip

Order No.	Description	Overall Length	List Price	Sale Price
52-500-050-0	Carbide Super Scriber	6 5"	\$37 00	<b>\$34.00</b>
52-500-055-0	Carbide Refill		\$11 76	<b>\$11.00</b>

52-297-006-0



52-330-006-0



### GRADUATIONS

**4R:** 8 hs 16 hs 32nds 64 hs

**16R:** 32nds 64 hs 50 hs 100 hs

## Combination Squares



52-370-012-0

### Features:

- Blades are chrome plated fully hardened and tempered
- 4 piece includes square protractor and center heads with 12" blade
- 2 piece includes square head and 12" blade
- Square head has level and scriber point
- Double indexed protractor is graduated 180° in both directions
- Graduated in 8ths 16ths 32nds and 64ths

Order No.	Description	List Price	Sale Price
52-370-012-0	4 pc	\$263.46	<b>\$198.00</b>
52-373-012-0	2 pc	\$169.55	<b>\$136.00</b>

## Cylindrical Squares



3" Ø

4" Ø

52-750-006-0

52-750-012-0

### Features:

- Used for checking squares height gages and other instruments
- Hardened and the ends are lapped to 90° angular accuracy
- 6" cylindrical squares  $\pm 0.0001"$
- 12" cylindrical square  $\pm 0.00015"$

Order No.	Description	List Price	Sale Price
52-750-006-0	6"	\$256.44	<b>\$231.00</b>
52-750-012-0	12"	\$366.22	<b>\$330.00</b>

## Steel Squares and Sets

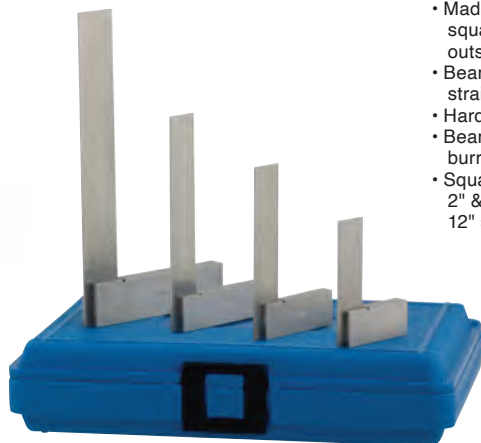

### Features:

- Made of carbon tool steel these economy squares have true right angles both inside and outside
- Beams and blades ground and lapped for straightness and parallelism
- Hardened blade
- Beam grooved at inner corner for clearance of burrs and dirt
- Squareness of blade edge to the working face  
2" & 3" =  $\pm 0.0006"$  4" & 6" =  $\pm 0.0008"$  9" & 12" =  $\pm 0.0012"$



Order No.	Description/Size	List Price	Sale Price
52-432-006-0	6" Square ONLY	\$33.36	<b>\$31.00</b>
52-432-009-0	9" Square ONLY	\$67.12	<b>\$61.00</b>
Sets			
52-432-246-0	4 piece Square Set, 2", 3", 4" & 6"	\$105.88	<b>\$96.00</b>
52-432-469-0	4 piece Square Set, 4", 6", 9" & 12"	\$182.18	<b>\$164.00</b>

## X-BLOX® V-Block Set

### 2 each @:

- Dimensions 1 1/2" L x 1 1/4" W x 1 1/4" H
- Work capacity Approximately 1"

### 2 each @:

- Dimensions 2" L x 1 1/2" W x 1 1/2" H
- Work capacity 1 1/2"

### All feature:

- Surfaces are square and parallel within 0 0005"
- V grooves are square and parallel with all surfaces within 0 0005"
- Corresponding dimensions for each pair are alike within 0 0005"



Order No. 52-475-500-0

**Sale \$131.00**

L st Pr ce \$144.98

## V-Block Set



### Features:

- Hardened steel All sides of V Blocks precision ground parallel and square within 0 0004"
- Height 2" Length 2 3/4" Width 2"
- Two clamps with screw hole at 90 degrees for positive clamping of work are included
- Clamping capacity= 2"/50m
- V Blocks are constructed with stepped grooves which allow the clamps to be inserted without protrusion thus allowing V Blocks to be used on base ends or sides
- Matched pair of V Blocks are perfectly aligned with 90 degree V grooves ground central and parallel to the sides and bases

Order No. 52-475-555-0

**Sale \$254.00**

L st Pr ce \$317.46

## Toolmaker's Vise

*Toolmaker's Vise makes precision holding possible for inspection, precision jig boring, milling and grinding*

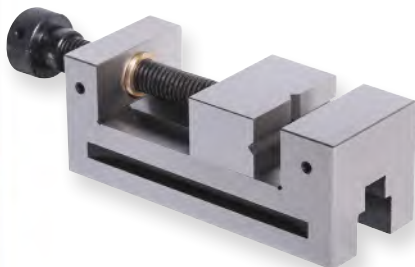

### Features:

- Maximum opening 2 48"
- Dimensions 6 1" x 1 9" x 2 0"
- Features solid base and front jaw construction
- Parallelism and squareness accuracy 0 0004"
- Clamping slots on the bottom of the base allow for easily affixing to angle plates vises etc

Order No. 52-466-000-1

**Sale \$197.00**

L st Pr ce \$245.07

# 1-2-3 & 2-4-6 Blocks

Useful in layout, inspection and grinding work

**Features:**

- 23 holes for easy clamping
- Sold in pairs
- Hardened 56 60 HRC
- Both styles include 5 threaded holes 3/8" 16

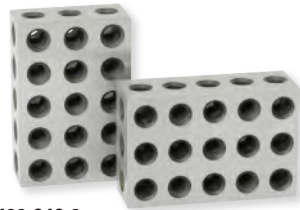

52-439-246-0

Order No.	Description	Accuracy	List Price	Sale Price
52-439-031-0	1-2-3 Blocks	0 0001"/1"	\$46 34	<b>\$38.00</b>
52-439-032-0	1-2-3 Blocks	0 0002"/1"	\$96 48	<b>\$80.00</b>
52-439-246-0	2-4-6 Blocks	0 0003"/1"	\$176 40	<b>\$142.00</b>

## Parallel Sets

2 thicknesses to choose from!

**Features:**

- 2 each of 1/2" 5/8" 3/4" 7/8" 1" 1 1/8" 1 1/4" 1 3/8" 1 1/2" & 1 5/8" heights
- Absolute heights are nominal
- Hardness 50 HRC 6" length
- 52 437 000 0 paired in height 0 001"
- 52 437 031 0 paired in height 0 0001"



52-437-031-0



52-437-000-0

Order No.	Description	Parallelism	List Price	Sale Price
52-437-000-0	1/8" Parallel Set	0 0008"	\$270 99	<b>\$231.00</b>
52-437-031-0	1/32" Parallel Set	0 0001"	\$291 81	<b>\$249.00</b>

## Angle Blocks

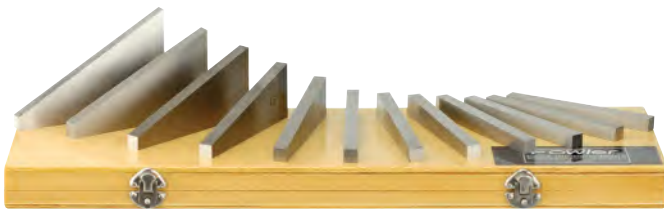

**Features:**

- Each 12 block set includes 1 thru 5° blocks in 1° increments and 5° through 30° blocks in 5° increments as well as 1/4° & 1/2° blocks
- Accuracy ± 2.5 arc minutes
- Use of the Solid Angle Block simplifies the setting and checking of angles during tooling production or inspection. This fast accurate method eliminates time consuming calculations sine bar and any setup errors
- All blocks precision ground
- All blocks are 3" long and 1/4" thick

Order No. 53-666-000-0

**Sale \$133.00**

List Price \$165.61





# COAX-2D 2 Dimensional Coaxial Indicator Sets

Use the 2D Coaxial Set for accurate component centering and positioning in most machining applications. The dial remains stationary during the rotation of the machine spindle.

## Features:

- Graduations and revolution counter 0.0005"/0.01mm
- 3 internal and 3 external feelers; ball dia. 1/8" (3mm)
- Includes center point feeler and staining arm
- Restraining arm
- Shank 3/8" dia. x 7/8" long (10mm x 20mm)
- Measuring range 0.250" (6mm) axis offset
- Speed recommended 800 RPM max
- Repeatability to within 0.0002" (0.005mm) of true center
- Capacity depending on feeler is 5/32 12"/4 300mm internal diameter; 1/2 12"/0 300mm external diameter



52-710-025-0

Order No.	Description	List Price	Sale Price
52-710-025-0	2D Coaxial Set - inch	\$289.56	<b>\$232.00</b>
52-710-030-0	2D Coaxial Set - Metric	\$279.67	<b>\$238.00</b>

## Electronic Edge Finders



### Features:

- Six equally spaced light ports provide visibility at any angle
- Edge finder lights instantly when stylus touches work edge
- Repeatability 0.0002"
- Works on any conductive metal



Along with light indication, model #54-575-650-0 emits an audible "beep" at time of contact

Order No.	Stylus	Shank	Audible	List Price	Sale Price
54-575-600-0	0.200"	1/2"	NO	\$45.42	<b>\$41.00</b>
54-575-625-0	0.200"	1/2"	NO	\$141.14	<b>\$128.00</b>
54-575-650-0	0.400"	3/4"	YES	\$163.10	<b>\$147.00</b>



## Quill Kit

Digital display for drill presses and milling machines

### Features:

- IP54 protected against fluid and dust
- Includes quill installation tool kit
- Range 0 - 6"/150mm
- Accuracy  $\pm 0.001"/0.03mm$
- Resolution 0.0005"/0.01mm/1/64"
- Preset zero in/mm absolute/incremental on/off functions
- Stainless steel construction
- Interchangeable mounting brackets with hardware



Order No. 54-050-100-0

**Sale \$162.00**

List Price \$189.81

# Z-CHECK 65 PLUS+

## Z-Axis Tool Setter

### Features:

- Supplied with zero reference setting block
- P65 protected against fluid and dust
- Back light turns on when zero reference is achieved
- 4 magnets embedded into base
- 2" default setting height
- Steel contact surface with 0.0002" flatness
- Resolution 0.00005"/0.001mm
- Repeatability 0.00015"/0.004mm
- Accuracy 0.0001"/0.003mm
- Includes a rugged aluminum fitted case



Order No. 54-188-200-0

**Sale \$113.00**

List Price \$125.06

## HIGH Accuracy Z-Axis Detectors



54-188-140-0



For use in CNC machines and other applications where high accuracy is required!



### Features:

- P67 protected against fluid and dust
- High accuracy and repeatability  $\pm 0.000039"/0.001mm$
- Carbide touch surface (0.196"/5mm)
- High precision bearing guide system for long life
- Interchangeable magnetic base
- High visibility LED indicator
- Movement stroke 0.78"/2mm
- Battery life approximately 250 hours (on time)

54-188-140-0

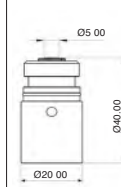

54-188-150-0

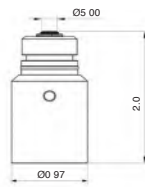

Order No.	Model	Dimensions	List Price	Sale Price
54-188-150-0	nch	Height 2 7/50 8mm, Dia 0.97"/24.638mm	\$268.63	<b>\$242.00</b>
54-188-140-0	Metric	Height 1.57"/40mm, Dia 0.78"/20mm	\$307.43	<b>\$277.00</b>

Prices & Specifications are subject to change without notice

# QUICK CHECK

## Multi-Function Check Standard



### Check

- ✓ Height Gages
- ✓ Micrometers
- ✓ Depth Gages
- ✓ Bore Gages
- ✓ Test & Dial Indicators
- ✓ Caliper Gages
- ✓ Protractors & more ....

#### Features:

- All sizes marked are actual
- Accuracy of indicated values  $\pm 0.00012''$
- One compact multi function precise standard
- Can be used to check and verify a multitude of measuring instruments
- Supplied with a manufacturer's test certificate and fitted wood case

Order No. 53-813-015-0

**Sale \$1,553.00**

List Price \$1,827.00

## SHOP-BLOX® Rectangular Gage Block Sets



53-672-081-0

#### Features:

- Manufactured to meet Federal Specification ASME B89 1.9 2002 tolerances on length for inch gage blocks
- Certificate of Calibration traceable to NIST
- Tolerances to  $\pm 0.00005''$
- In high quality fitted wood case

Order No.	Description	List Price	Sale Price
53-672-036-0	36 pc	\$358.63	<b>\$269.00</b>
53-672-081-0	81 pc	\$613.39	<b>\$461.00</b>

## Grade Ø Rectangular Steel Gage Block Set



53-670-038-0

#### Features:

- Grade Ø 36 piece
- Certificate of Calibration traceable to NIST
- Each block is individually serialized
- Sizes clearly marked on each block
- Complete with fitted wooden case

Order No. 53-670-038-0

**Sale \$450.00**

List \$529.13

# Tool Set 300 Presetter

Used for the quick checking of heights and diameters (radii) of various types of machine tools. Accuracy is guaranteed by a precise steel measuring column and displacement devices in X and Z coordinates utilizing constant measuring force.

## Tool Holding Spindle

Tool presetter is supplied with high precision tool pot (Grade 0)

- SO 50 taper
- Less than 0.00008"/0.002mm concentricity error

## Features:

- Measuring range (X)11.8"/300mm (Z)15.7"/400mm
- Min/Max functions for T R readings
- 2 reference indications
- Preset and Tolerance value inputs
- Radius or diameter indication on X axis display
- Resolution 0.00005"/0.001mm
- Floating zero function anywhere within axis range
- Carbide measuring insert for durability
- Counter balanced measuring carriage
- Constant measuring force in both axes
- **High precision Swiss measuring system**



Order No.	Description	List Price	Sale Price
54-188-300-0	ool Presetter	\$10,800.87	<b>\$9,721.00</b>
54-121-005-0	SO 50/40 ool Pot Adapter	\$751.82	<b>\$715.00</b>



# Portable Roughness Tester II

*Quick, easy roughness testing*

The X Pro Portable Roughness Tester can be used for various applications by selecting from a variety of accessories including special application probes and a swivel stand

RS232 data output is available on additional models (contact the Fowler technical department for more information 1 800 788 2353)

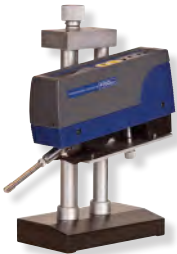

(X Pro shown with optional stand with swivel)



## Features:

- Small compact size
- 2 selectable parameters Ra and Rz
- Large LCD display
- Meets ISO and D N standards
- N ST traceable specimen included
- Uses 9 volt battery (approx. 3000 measurements)
- includes fitted case

## X-Pro Portable Roughness Tester II

Order No.	Description	List Price	Sale Price
54-410-500-0	Portable Surface Roughness Tester 0.0004" probe (N S specifications)	\$2,039.35	<b>\$1,836.00</b>
54-410-600-0	Portable Surface Roughness Tester 0.0002" probe (D N specifications)	\$2,039.35	<b>\$1,836.00</b>

## X-Pro Portable Roughness Tester II Stand with Swivel

Order No.	Description	List Price	Sale Price
54-400-896-0	Stand with Swivel Attachment	\$491.18	<b>\$443.00</b>



**COMPLETE  
METALWORKING  
SOLUTIONS**

**(800) 991-4225**

[www.ahbinc.com](http://www.ahbinc.com)

ISO Certified

[customerservice@ahbinc.com](mailto:customerservice@ahbinc.com)

**Headquarters**

780 Dedham Street • Canton • Massachusetts 02021

---

**Distribution Center & Showroom**

28010 Industry Drive

Valencia, California 91355