



COMPLETE METALWORKING SOLUTIONS
(800) 991-4225 www.ahbinc.com
ISO Certified customerservice@ahbinc.com

Mahr® | Precision measurement and solutions

A Guide to Our Best Seller's



Mahr will always deliver the best quality solution. Ensuring that you are provided with the necessary measurement equipment.

Best Performance in Every Step

The key to successful manufacturing is smart, efficient quality control. It depends on simple and accurate data acquisition, as well as, a structured processing of the data. Mahr's portfolio of products offers you maximum freedom of movement, allowing you to make faster and more targeted measurements - with full transparency. This increases your agility without sacrificing the traceability of measurement steps along the entire value chain.

Economical

By purchasing a USB receiver stick (i-Stick) for your computer, you can operate up to eight measuring devices at the same time and save additional costs for connection cables.

Unclutter

Keep your workplace clear of restrictive data cables.

ID Transmission

Serial and order numbers are sent out by the measuring device and stored in the recorded measurement log.



Reliable

With integrated transmission visual feedback is provided verifying data transmission. Error message signifies loss of data connector.



Full Freedom of Movement

Mahr measuring devices allow exact measuring - even in the machine or on hard-to-reach workpieces.

6 Meter (20 ft.)
Transmission Range

8 Measuring Devices
per i-Stick Receiver

70 Products for
Every Measuring Task

Integrated Transmitter

Eliminate hazards such as cable breakage and wear.

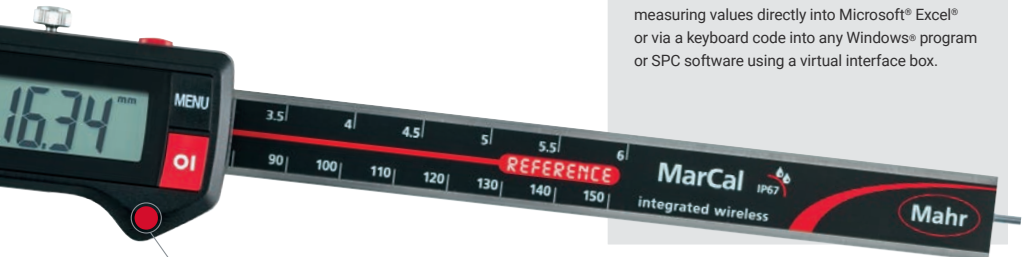

Free Software

Benefit from the MarCom Professional interface software and transfer the measurement data individually and conveniently to your Windows applications or CAQ software.



Scan for Marcom Download

MarCom Professional Software transfers measuring values directly into Microsoft® Excel® or via a keyboard code into any Windows® program or SPC software using a virtual interface box.

Mahr Community - Marcom

Sending Measuring Results

Data

Integrated Wireless Technology



Retrofitted Wireless Technology



Cable Technology



MarCom P
Free to D
www.mahr.com

Scan the QR code to watch simple and practical applications.

Professional
Download:
www.marcom.com/marcom

Virtual Interface
Box

CAQ-/SPC-Software



Intelligent Excel
Interface

Microsoft® Excel



Keyboard Emulation

Any Windows® Software



Text File

Flexible Data Processing





Mahr offers a full line of digital calipers including general purpose everyday use calipers, as well as, for harsh shop use, wired and integrated wireless versions and a full range of specialty calipers.



4103401



4112571



4126751

Compact and handy

always within reach

When things start to get bigger

Version with measuring blades



4126532

Order No.	Model	Measuring Range	Resolution	Depth Rod	Details
4103401	16 EWRI	0 - 150 mm / 0 - 6 in	0.01 mm / 0.0005 in	Round	IP67, with Integrated Wireless thumbwheel
4103403	16 EWRI	0 - 150 mm / 0 - 6 in	0.01 mm / 0.0005 in	Rectangular	IP67, with Integrated Wireless thumbwheel
9105795	16 EWRI	0 - 150 mm / 0 - 6 in	0.01 mm / 0.0005 in	Round	Starter pack including i-Stick
9105796	16 EWRI	0 - 150 mm / 0 - 6 in	0.01 mm / 0.0005 in	Rectangular	Starter pack including i-Stick
4112571	18 EWRI	0 - 300 mm / 0 - 12 in	0.01 mm / 0.0005 in	-	IP65, with Integrated Wireless
4112572	18 EWRI	0 - 500 mm / 0 - 20 in	0.01 mm / 0.0005 in	-	IP65, with Integrated Wireless
4112573	18 EWRI	0 - 750 mm / 0 - 30 in	0.01 mm / 0.0005 in	-	IP65, with Integrated Wireless
4126532	30 EWRI-N	0 - 100 mm / 0 - 4 in	0.01 mm / 0.0005 in	-	IP67, with Integrated Wireless
4126751	30 EWRI	0 - 25 mm / 0 - 1 in	0.01 mm / 0.0005 in	-	IP67, with Integrated Wireless

MarCal | Digital calipers

Digital with reference system – a reliable choice

The standard

in the workshop



4103011

The impervious

for production and workshop



4103301

As tough as they come

with carbide-tipped outer measuring surfaces



4103373



4126755



4118907

Order No.	Model	Measuring Range	Resolution	Depth Rod	Details
4103011	16 ER	0 - 150 mm / 0 - 6 in	0.01 mm / 0.0005 in	Round	With thumbwheel, no data
4103013	16 ER	0 - 150 mm / 0 - 6 in	0.01 mm / 0.0005 in	Rectangular	With thumbwheel, no data
4103301	16 EWR	0 - 150 mm / 0 - 6 in	0.01 mm / 0.0005 in	Round	IP67, with thumbwheel, no data
4103303	16 EWR	0 - 150 mm / 0 - 6 in	0.01 mm / 0.0005 in	Rectangular	IP67, with thumbwheel, no data
4103304	16 EWR	0 - 200 mm / 0 - 8 in	0.01 mm / 0.0005 in	Rectangular	IP67, with thumbwheel, no data
4103306	16 EWR	0 - 300 mm / 0 - 12 in	0.01 mm / 0.0005 in	-	IP67, no thumbwheel, no data
4103373	16 EWRi-H	0 - 150 mm / 0 - 6 in	0.01 mm / 0.0005 in	Round	IP67, carbide jaws
4126755	30 EWRi	0 - 150 mm / 0 - 6 in	0.01 mm / 0.0005 in	-	IP67, with Integrated Wireless
4126754	30 EWRi	0 - 200 mm / 0 - 8 in	0.01 mm / 0.0005 in	-	IP67, with Integrated Wireless
4126756	30 EWRi	0 - 300 mm / 0 - 12 in	0.01 mm / 0.0005 in	-	IP67, with Integrated Wireless
4118907	30 EWRi-V	0 - 200 mm / 0 - 8 in	0.01 mm / 0.0005 in	Rectangular	IP67, kit with Integrated Wireless

Micromar | Digital micrometers

The choice is yours: data output or Integrated Wireless



Micromar digital micrometers offer the latest designs for shop worthy measuring tools. The new modern look with large easy to read display with advanced feature provides the basis for a full range of shop tools. Models are available for general purpose everyday use, harsh shop use, wired and integrated wireless versions and a full range of specialty micrometers.



4157010



4157011



4157100



4157120



4157150



Order No.	Model	Measuring Range	Resolution	Details
4157010	40 ER	0 - 25 mm / 0 - 1 in	0.001 mm / 0.00005 in	-
4157011	40 EWR	0 - 25 mm / 0 - 1 in	0.001 mm / 0.00005 in	IP65, no data
4157012	40 EWR	25 - 50 mm / 1 in - 2 in	0.001 mm / 0.00005 in	IP65, data
4157100	40 EWRi	0 - 25 mm / 0 - 1 in	0.001 mm / 0.00005 in	IP65, Integrated Wireless
4157101	40 EWRi	25 - 50 mm / 1 in - 2 in	0.001 mm / 0.00005 in	IP65, Integrated Wireless
4157115	40 EWRi	0 - 100 mm / 0 - 4 in	0.001 mm / 0.00005 in	IP65, Integrated Wireless, 4 micrometer set
4157020	40 EWR-L	0 - 25 mm / 0 - 1 in	0.001 mm / 0.00005 in	IP65, data output, quick adjustment
4157021	40 EWR-L	25 - 50 mm / 1 in - 2 in	0.001 mm / 0.00005 in	IP65, data output, quick adjustment
4157120	40 EWRi-L	0 - 25 mm / 0 - 1 in	0.001 mm / 0.00005 in	IP65, Integrated Wireless, quick adjustment
4157121	40 EWRi-L	25 - 50 mm / 1 in - 2 in	0.001 mm / 0.00005 in	IP65, Integrated Wireless, quick adjustment
4157150	40 EWRi-V	0 - 25 mm / 0 - 1 in	0.001 mm / 0.00005 in	IP65, kit, Integrated Wireless, quick adjustment

Accessories for Measuring Instruments with Integrated Wireless

4102603	DK-U1	Bidirectional USB data cable with power supply, for micrometers only
4102606	DK-D1	Digimatic data cable
4102220	i-Stick	Wireless receiver for measuring instruments with Integrated Wireless
4158000	41 H	Stand for holding outside micrometers



A clear digital display, robust construction and high Mahr accuracy characterize our digital dial gages. The range includes measuring instruments for all applications. Various interfaces for data transfer and a high protection rating up to IP 54 leave no demands unfulfilled.



Order No.	Model	Measuring Range	Resolution	Details
4336010	1075 R	12.5 mm / 0.5 in	0.01 mm / 0.0005 in	LOCK function, output
4336020	1075 R	12.5 mm / 0.5 in	0.005 mm / 0.0001 in	LOCK function, output
4336030	1075 R	12.5 mm / 0.5 in	0.001 mm / 0.00005 in	LOCK function, output
4337620	1086 R	25 mm / 0.5 in	0.0005 mm / 0.000020 in	ABS, LOCK, Tol function, output
4337621	1086 R	25 mm / 1 in	0.0005 mm / 0.000020 in	ABS, LOCK, Tol function, output
4337697	1086 R-HR	12.5 mm / 0.5 in	0.0001 mm / 0.000010 in	ABS, LOCK, TOL function, high resolution, output
4337660	1087 R	12.5 mm / 0.5 in	0.0005 mm / 0.000020 in	ABS, LOCK, TOL function, dynamics
4337661	1087 R	25 mm / 1 in	0.0005 mm / 0.000020 in	ABS, LOCK, TOL function, dynamics
4337695	1087 R-HR	12.5 mm / 0.5 in	0.0001 mm / 0.000010 in	ABS, LOCK, TOL function, dynamics, high resolution, output
4337624	1086 Ri	12.5 mm / 0.5 in	0.0005 mm / 0.000020 in	ABS, LOCK, TOL function, Integrated Wireless
4337625	1086 Ri	25 mm / 1 in	0.0005 mm / 0.000020 in	ABS, LOCK, TOL function, Integrated Wireless
4337663	1087 Ri	12.5 mm / 0.5 in	0.0005 mm / 0.000020 in	ABS, LOCK, TOL function, dynamics, Integrated Wireless
4337665	1087 Ri	25 mm / 1 in	0.0005 mm / 0.000020 in	ABS, LOCK, TOL function, dynamics, Integrated Wireless

Accessories for Measuring Instruments with Integrated Wireless and Data Cable Connection

4102357	16 EXu	Data connection cable USB (2m)
4102220	i-Stick	Wireless receiver for measuring instruments with Integrated Wireless
4102410	16 EXr	Data connection cable RS232 (2 m)
4102915	16 Ewd	Digimatic data cable (2 m)

MarCal | The latest generation

Digital calipers for special applications



Mahr has a full line of calipers designed for special measuring applications with Integrated Wireless or with Marconnect wired data output.

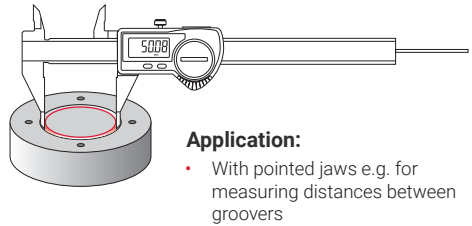
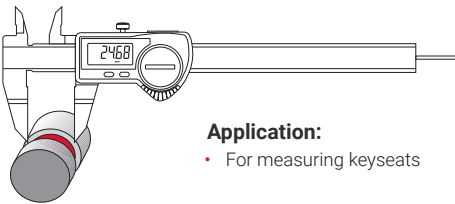
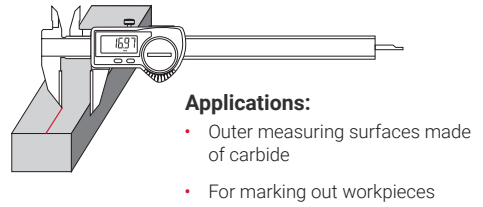
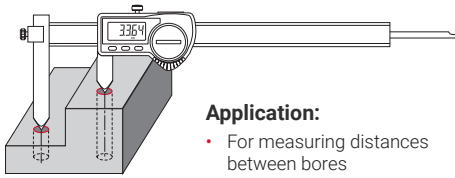

Order No.	Model	Measuring Range	Resolution
4103382	16 EWRI-AR	0 - 200 mm / 0 - 8 in	0.01 mm / 0.0005 in
4103384	16 EWRI-BA	10 mm - 210 mm / 0.4 in - 8.3 in	0.01 mm / 0.0005 in
4103374	16 EWRI-NA	0 - 150 mm / 0 - 6 in	0.01 mm / 0.0005 in
4103376	16 EWRI-SM	0 - 150 mm / 0 - 6 in	0.01 mm / 0.0005 in

Micromar | The latest generation

Digital Micrometers for special applications



Mahr has a full line of Digital micrometers designed for special measuring applications with integrated wireless or with Marconnect wired data output.



4157130



4157141

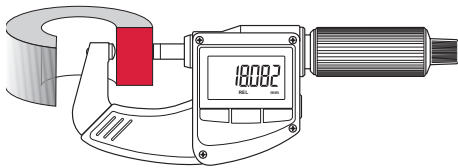

Application:

- For measuring the thickness of pipe walls

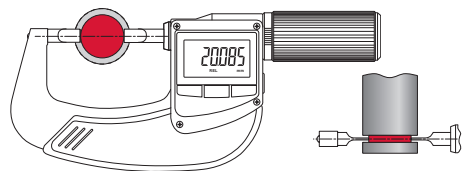

Application:

- For measuring recesses, grooves, etc.



4157132



4157140

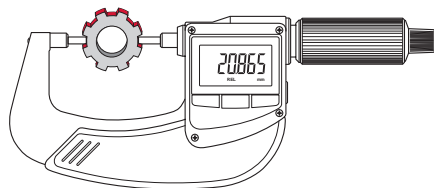

Application:

- For measuring grooves, spline shafts, recesses, etc.

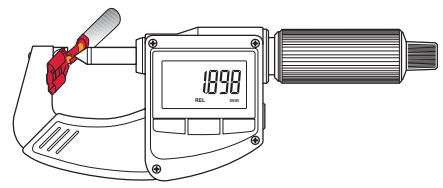

Application:

- For measuring crimp heights

Order No.	Model	Measuring Range	Resolution
4157130	40 EWRI-R	0 - 25 mm / 0 - 1 in	0.001 mm / 0.00005 in
4157132	40 EWRI-B	0 - 25 mm / 0 - 1 in	0.001 mm / 0.00005 in
4157141	40 EWRI-S	0 - 25 mm / 0 - 1 in	0.001 mm / 0.00005 in
4157140	40 EWRI-K	0 - 20 mm / 0 - 0.8 in	0.001 mm / 0.00005 in

MarTest® | Test indicators for high accuracy measurement

Ensures maximum precision



The sensitive computer-optimized measuring tool ensures maximum reliability and precision. For rough workshop use, the display is superbly protected against scratching or breakage by a hardened mineral glass pane, and a seal also provides reliable protection against penetrating liquids.

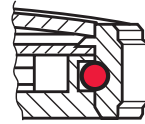
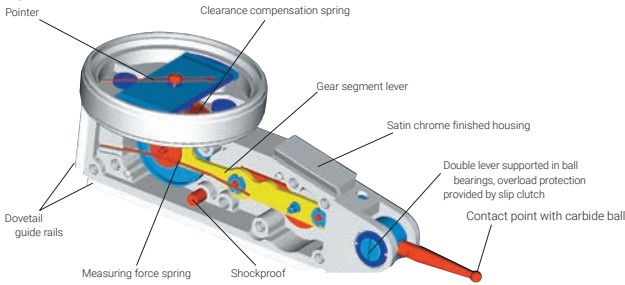

Dial face is sealed with an O-ring



4306200



4305200



4308200



4302200



4307950



4308985



4307960



4305120



Order No.	Model	Measuring Range	Reading	Dial Diameter	Feature
4305200	800 S	±0.4 mm	0.01 mm	27.5 mm / 1.1 in	-
4307950	801 SG	±0.015 in	0.0005 in	38 mm / 1.5 in	Large dial
4308200	800 SGM	± 0.1 mm	0.002 mm	38 mm / 1.5 in	Large dial, high accuracy
4308985	801 SGE	± 0.004 in	0.00005 in	38 mm / 1.5 in	Large dial, high accuracy
4306200	800 SL	± 0.25 mm	0.01 mm	27.5 mm / 1.1 in	Long stylus
4302200	800 V	±0.4 mm	0.01 mm	27.5 mm / 1.1 in	Vertical dial
4303950	801 H	±0.015 in	0.0005 in	27.5 mm / 1.1 in	Horizontal dial
4307960	801 SR	±0.030 in	0.0005 in	38 mm / 1.5 in	Large dial
4305120	800 EW	±0.4mm / ±0.015 in	0.001, 0.01mm / 0.00005, 0.0005 in	-	Digital

MarCator | Dial indicators

Accurate measuring results



Mahr dial indicators have been measuring precision parts for more than a century. Their long life and performance come from:

- One piece case for strength and durability
- Hardened gears and stainless steel racks provide lasting protection against indicator failure due to shock or wear
- Skeletonized, hobbled gears for more sensitive response, superior indicator accuracy with minimal hysteresis error
- Compliance with ANSI/AGD dimensional and accuracy specifications

Order No.	Model	AGD Size	Measuring Span	Graduation Value	Type of Dial Face
2011095	A6Q	0	0.100 in	0.001 in	0-20-0
2011000	12I	1	0.025 in	0.0001 in	0-5-0
2011110	B5M	1	0.050 in	0.0005 in	0-10-0
2011141	B8I	1	0.250 in	0.001 in	0-50-0
2011775	O6I	1	2.5 mm	0.01 mm	0-50-0
2015781	22I	2	0.025 in	0.0001 in	0-5-0
2015786	25M	2	0.075 in	0.0005 in	0-15-0
2015790	27I	2	0.125 in	0.0005 in	0-25-0
2015792	28IN	2	0.250 in	0.001 in	0-50-0
2011815	P11	2	0.5 mm	0.002 mm	0-10-0
2015794	26I	2	2.5 mm	0.01 mm	0-50-0
2015795	28IM	2	5 mm	0.02 mm	0-100-0



2011095



2011110



2011775

Millimess® | Dial comparators

High precision and extreme robustness



Millimess series of dial comparators have been synonymous with both high precision and extreme robustness. Providing both maximum accuracy and low reversal error they are the perfect match for bench and portable comparative gages.



4334900



4334000

Order No.	Model	Measuring Range	Readings	Overtravel	Measuring Force
4335000	1002	±25 µm	0.5 µm	2.8 mm	1 N
4335900	1002 Z	± 0.0010 in	0.00002 in	0.11 in	1 N
4334000	2003	±50 µm	1 µm	2.8 mm	1 N
4334900	1003 Z	± 0.0020 in	0.00005 in	0.11 in	1 N
4333000	1004	±0.13 µm	5 µm	2.5 mm	1 N
4333900	1004 Z	± 0.0050 in	0.0001 in	0.10 in	1 N
4332000	1010	±0.25 µm	0.01 µm	2.5 mm	1 N
4332900	1010 Z	± 0.0100 in	0.0005 in	0.10 in	1 N

Millimes 2000 W / 2000 Wi | Inductive comparators

Electronic comparators with inductive measuring system and touch operation



The Millimes 2000 W(i) and 2001 W(i) series of electronic comparators set new standards in metrology with their unique and innovative features.

- Tempered glass front with touch control panels provide a scratch and impact resistant surface, excellent protection against dust, coolants and wear-free touch operating keys
- High-contrast LCD display, is very clear and easy to read
- Clear tolerance symbols and colored LED signals (red, green, yellow) for measured value classification
- Highest resolution and accuracy in a digital comparator



Unique touch operation
- even works with gloves



Order No.	Model	Measuring Range	Resolution	Features
4346700	2000 W	± 1 mm / ± 0.040 in	0.0001 mm, 0.0002 mm, 0.0005 mm, 0.001 mm, 0.002 mm, 0.005 mm, 0.01 mm / 0.00005 in, 0.00001 in, 0.00002 in, 0.00005 in, 0.0001 in, 0.0002 in, 0.0005 in	-
4346701	2000 Wi	± 1 mm / ± 0.040 in	0.0001 mm, 0.0002 mm, 0.0005 mm, 0.001 mm, 0.002 mm, 0.005 mm, 0.01 mm / 0.00005 in, 0.00001 in, 0.00002 in, 0.00005 in, 0.0001 in, 0.0002 in, 0.0005 in	Wireless
4346800	2001 W	± 1 mm / ± 0.040 in	0.0001 mm, 0.0002 mm, 0.0005 mm, 0.001 mm, 0.002 mm, 0.005 mm, 0.01 mm / 0.00005 in, 0.00001 in, 0.00002 in, 0.00005 in, 0.0001 in, 0.0002 in, 0.0005 in	Analog scale dynamics
4346801	2001 Wi	± 1 mm / ± 0.040 in	0.0001 mm, 0.0002 mm, 0.0005 mm, 0.001 mm, 0.002 mm, 0.005 mm, 0.01 mm / 0.00005 in, 0.00001 in, 0.00002 in, 0.00005 in, 0.0001 in, 0.0002 in, 0.0005 in	Analog scale dynamics, wireless

µMaxµm® II | Dial comparators

For static and dynamic measurements



The high-precision inductive Millimes dial comparators are capable of digital increments of up to 0.2 µm. User-friendly operating functions such as tolerance monitoring, minimum or maximum recording for dynamic measurements, a combined numerical and scale display and simple data transfer make it an indispensable precision measuring instrument.



Order No.	Model	Measuring Range	Resolution	Stem
2034201	µMaxµm II	± 1.0 mm / ± 0.040 in	0.0002 mm, 0.0005 mm, 0.001 mm, 0.002 mm, 0.005 mm, 0.01 mm, 0.02 mm / 0.00001 in, 0.00002 in, 0.00005 in, 0.0001 in, 0.0002 in, 0.0005 in, 0.001 in	0.375 in x 0.46 in
2034203	µMaxµm II	± 1.0 mm / ± 0.040 in	0.0002 mm, 0.0005 mm, 0.001 mm, 0.002 mm, 0.005 mm, 0.01 mm, 0.02 mm / 0.00001 in, 0.00002 in, 0.00005 in, 0.0001 in, 0.0002 in, 0.0005 in, 0.001 in	1.5 in x 0.375 in

MarStand | Indicator stand with granite base

Can reach any position within its operating range

Measuring tables combine a precise and level measuring table, a stable measuring column and strong arm parts. MarStand measuring tables provide the basis for precise measuring results due to their extra stable design.

Order No.	Model	Working Range	Fine Adjustment	Mounting Hole
4430100	820 NG 0	0 - 130 mm / 0 - 5.1 in	No	8H7
4430110	820 NG 0	0 - 130 mm / 0 - 5.1 in	No	3/8 in
4431100	820 FG 0	0 - 130 mm / 0 - 5.1 in	Yes	8H7
4431110	820 FG 0	0 - 130 mm / 0 - 5.1 in	Yes	3/8 in

Note: Indicator sold separately



4430100



4420385

MarStand | Indicator stand with magnetic base

Can reach any position within its operating range

Measuring tripods provide the basis for precise measuring results due to their stable design. They offer the necessary support for your dial indicators, dial comparators, dial test indicator measuring devices and measuring probes.

Order No.	Fine Adjustment Range	Total Height	Projection (Max.)	Magnetic Force
4420385	2 mm / 0.078 in	224 mm / 8.818 in	130 mm / 5.118 in	300 N
4420386	2 mm / 0.078 in	316 mm / 12.440 in	200 mm / 7.784 in	800 N
4420387	2 mm / 0.078 in	401 mm / 15.787 in	280 mm / 9.8425 in	800 N
4420388	2 mm / 0.078 in	444 mm / 17.480 in	330 mm / 12.992 in	1000 N

Note: Indicator sold separately



MarStand | Radial Run-Out Gage with Center Supports

Ideal for quick and accurate concentricity runout checks

Radial run-out gages are the simplest method of detecting positional and form errors on shafts in a close-to-production environment. Due to the variety of models, the robust MarStand radial run-out gages form the basis for a wide range of workpiece requirements and precise measuring results.

Order No.	Distance Between Centers	Height of Centers	T-groove Width	Mounting Hole
4622200	0 - 200 mm	50 mm	10H7	8H7
4622201	0 - 350 mm	75 mm	10H7	8H7
4622202	0 - 450 mm	100 mm	12H7	8H7
4622203	0 - 450 mm	150 mm	12H7	8H7

Note: Indicator sold separately



4622200



Micromar | Precision bench micrometer
Easy and precise checking of small, high tolerance parts



The 40 TS is a rugged bench gage with built in micrometer. Can be used as a comparative gage or as a long range comparative micrometer.



4151030

Order No.	Model	Measuring Range	Retraction	Measuring Force
4154930	40 TSZ	0 - 2 in	0.045 in	5.5
4154030	40 TS	0 - 50 mm	1.2 mm	5.5

Applications:

- For rapid measurements of diameters of cylindrical parts (shafts, bolts and shanks)
- Measurements of thickness and length
- Recommended for standard precision parts

Micromar | Micrometer with integrated dial comparator

Easy and precise diameter measurement of shaft, bolts, shanks and other



With its integrated micrometer deviation can be measured comparatively against the reference setting allowing for faster measurement results in the production environment.

Order No.	Model	Measuring Range	Thumble Readings	Accuracy
4150900	40 F	0 - 1 in	0.0001 in	0.00008 in
4150901	40 F	0 - 2 in	0.0001 in	0.00008 in
4150000	40 F	0 - 25 mm	0.01 mm	2 µm
4150001	40 F	0 - 50 mm	0.01 mm	2 µm

Applications:

- For rapid measurements of diameters of cylindrical parts (shafts, bolts and shanks)
- Measurements of thickness and length
- Recommended for standard precision parts



4150900

Marameter | Indicating snap gage

For measuring shafts, bolts, spindles and other cylindrical parts for thickness and length



Precision snap gages are the perfect measuring tools for precision measurements of cylindrical parts such as shafts, bolts and shanks, especially for safe and fast tests on series parts. The dimensional accuracy is identified and read at a glance on the dial comparator.



4450000

Order No.	Model	Measuring Range	Measuring Force
4450000	840 F	0 - 1 in / 0 - 25 mm	7.5
4450001	840 F	1 in - 2.36 in / 25 mm - 60 mm	7.5
4450002	840 F	2 in - 4 in / 50 mm - 100 mm	7.5
4450003	840 F	4 in - 6 in / 100 mm - 150 mm	7.5
4450004	840 F	6 in - 8 in / 150 mm - 200 mm	7.5

Note: Excludes indicating instrument, recommend Millimess dial comparator

Marameter | Indicator snap gage

Design assures precisely parallel anvil surfaces



Mahr 300P series snap gages are robust and designed for the most demanding shop measuring environment.



Order No.	Model	Measuring Range	Resolution	Details
2050485	300 P-1	0 - 1 in / 0 - 25 mm	0.0001 in	Dial indicator
2050497	300 P-2	0 - 2 in / 0 - 50 mm	0.0001 in	Dial indicator
2051658	EDI-300P-1	0 - 1 in / 0 - 25 mm	Switchable	μMaxum II
2051664	EDI-300P-2	0 - 2 in / 0 - 50 mm	Switchable	μMaxum II
2204617	BA-26	-	-	Bench stand

Note: EDI-300P-1 with uMaxum II digital comparator. Shown with optional stand BA-26

Marameter | ID/OD gages

The economical way to check ID's and OD's at the point of manufacture



Universal Bench ID/OD gages are easily adjusted for ID/OD tasks. Their frictionless measuring transfer system is ideal for the shop floor providing high precision and long life.

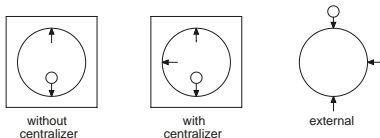

"T"-plates give a diameter reading directly across the diameter. A third contact may be used as a side-stop or centralizer

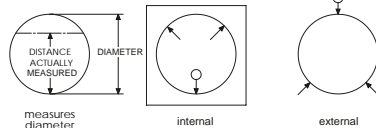

"V"-plates are self-centralizing. Three jaws are used and the measurement is of the distance between the sensitive contact and the chord formed by the two reference contacts.

Order No.	Model	ID and OD Capacity	Order Style	Resolution
2050643	36B-10	0.75 in - 3.50 in / 0.25 in - 5 in	T plate	0.0001 in
2050652	36B-9	0.812 in - 4.625 in / 0.312 in - 5 in	V plate	0.0001 in
2061657	3B-VT	0.75 in - 3.50 in / 0.25 in - 5 in	Both T and V	-

Multimar | Digital universal caliper

For easy adaptation to individual measuring tasks



No matter whether gear, thread, taper or recess: Multimar universal measuring instruments are an ideal solution for almost all internal and external measurements for which standard measuring instruments are not suitable. A choice of basic units and an extensive range of accessories are available.

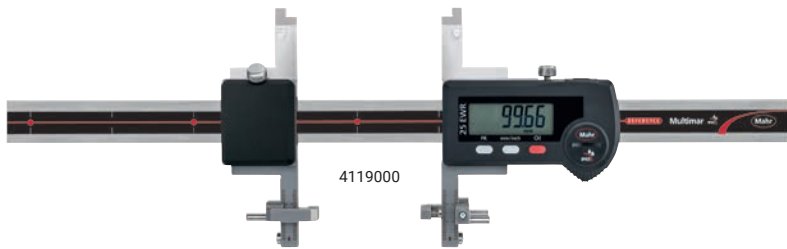

Order No.	Model	Application Range Outside	Resolution	Error Limit
4119000	25 EWR	0 - 300 mm	0.01 mm / 0.0005 in	0.03 mm
4119001	25 EWR	0 - 600 mm	0.01 mm / 0.0005 in	0.03 mm
4119002	25 EWR	0 - 1000 mm	0.01 mm / 0.0005 in	0.04 mm
4119003	25 EWR	0 - 1250 mm	0.01 mm / 0.0005 in	0.04 mm

Multimar | Universal measuring instrument

External and internal measurement of lengths, widths, diameters, distances



When the Multimar system is combined with a digital indicator or comparator performance is improved allowing for high precision comparative measurements at the point of manufacture.



Order No.	Model	Application Range Outside	Application Range Inside	Measuring Force	Product Weight
4503001	844 T	0 - 85 mm / 0 - 3.35 in	30 mm - 115 mm / 1.18 in - 4.52 in	5 N	0.78 kg
4503002	844 T	80 mm - 235 mm / 3.15 in - 9.25 in	110 mm - 265 mm / 4.33 in - 10.43 in	5 N	1.01 kg
4503003	844 T	230 mm - 585 mm / 9.06 in - 23.03 in	260 mm - 615 mm / 10.23 in - 24.21 in	5 N	1.59 kg
4503004	844 T	580 mm - 985 mm / 22.83 in - 38.78 in	610 mm - 1015 mm / 24.02 in - 39.96 in	5 N	2.22 kg
4503005	844 T	970 mm - 1470 mm / 38.19 in - 57.87 in	1000 mm - 1500 mm / 39.37 in - 59.05 in	10 N	2.52 kg
4503006	844 T	1470 mm - 1970 mm / 57.87 in - 77.56 in	1500 mm - 2000 mm / 59.05 in - 78.74 in	10 N	2.68 kg
4503007	844 T	1970 mm - 2470 mm / 77.56 in - 94.48 in	2000 mm - 2500 mm / 78.74 in - 98.42 in	10 N	2.86 kg

Multimar | Universal measuring instruments

Extreme versatility with a wide range of stock accessories

Mahr offers a wide variety of standard, interchangeable contacts and anvils. These provide truly universal application of the 844 T family for measuring lengths, ID's and OD's on large parts including gears.

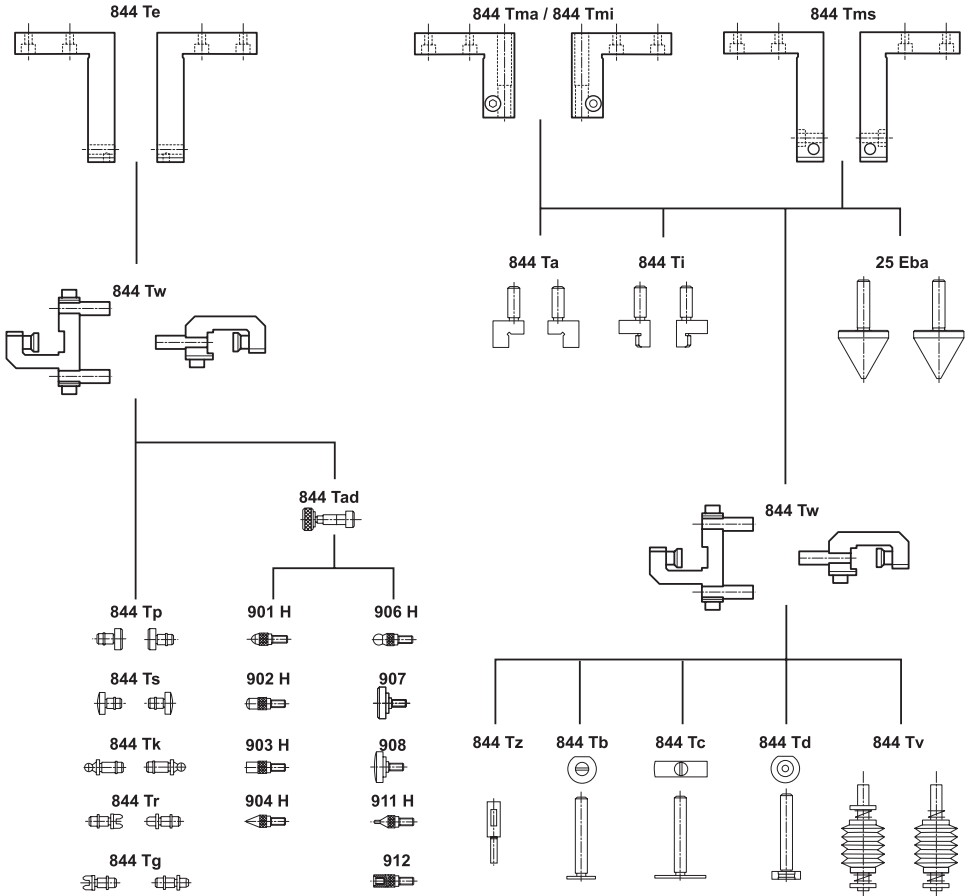
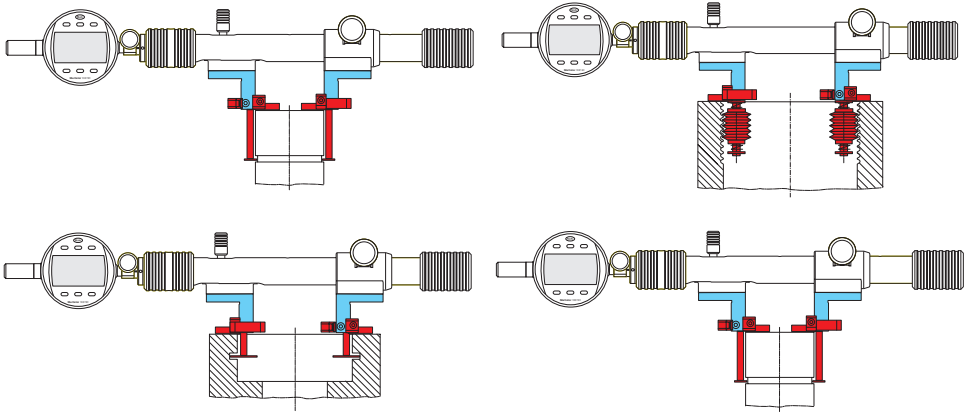

Micromar 844 A | Self-centering inside measuring pistol

Self-centering measuring head consists of 3 laterally positioned anvils



Available with scale or digital display or as a quick-measuring instrument with pistol-type grip.
The Mahr 3-point inner measuring devices always provide reliable results due to self-centering.



Note: Includes measuring head and pistol holder.
Digital Indicator sold separately.

Order No.	Model	Measuring Range	Error Limit	Measuring Depth	Measuring Depth with Extension
4487700	844 A	6 mm - 8 mm / 0.25 in - 0.3125 in	3 mm	58	133
4487701	844 A	8 mm - 10 mm / 0.3125 in - 0.4 in	3 mm	58	133
4487702	844 A	10 mm - 12 mm / 0.4 in - 0.4725 in	3 mm	58	133
4487703	844 A	12 mm - 16 mm / 0.4725 in - 0.625 in	3 mm	64	139
4487704	844 A	16 mm - 20 mm / 0.625 in - 0.775 in	3 mm	64	139
4487705	844 A	20 mm - 25 mm / 0.775 in - 1 in	3 mm	68	218
4487706	844 A	25 mm - 30 mm / 1 in - 1.2 in	3 mm	68	218
4487707	844 A	30 mm - 40 mm / 1.2 in - 1.6 in	3 mm	76	226
4487709	844 A	40 mm - 50 mm / 1.6 in - 2 in	3 mm	76	226
4487710	844 A	50 mm - 60 mm / 2 in - 2.35 in	4 mm	79	229
4487711	844 A	60 mm - 70 mm / 2.35 in - 2.75 in	4 mm	79	229
4487612	844 A	70 mm - 85 mm / 2.75 in - 3.35 in	4 mm	97	247

MaraMeter 844 N | Self-centering dial bore gage set

Measuring the diameter, roundness and conical form of a bore



Inner measuring devices are the perfect tools for precisely measuring the diameter, roundness and conicity of holes.

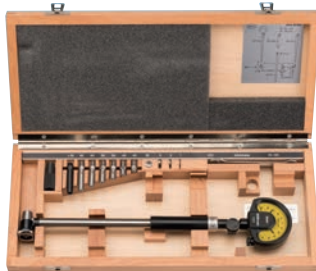

Note: Dial comparator or digital indicator sold separately.

Order No.	Model	Measuring Range	Measuring Depth	Design	Error Limit G
4474000	844 N	18 mm - 50 mm / 0.7 in - 2 in	115 mm	Standard, moveable anvil carbide-tipped	2 µm
4474001	844 N	35 mm - 100 mm / 1.4 in - 4 in	148 mm	Standard, moveable anvil carbide-tipped	2 µm
4474002	844 N	100 mm - 250 mm / 4 in - 10 in	230 mm	Standard, moveable anvil carbide-tipped	2 µm



With the new height measuring device Digimar 817 CLT you can measure components in no time at all. A pivotable touch display ensures that the Digimar 817 CLT is as easy-to-operate as a tablet. Large buttons, clearly structured menus, and self-explanatory icons ensure tasks can be completed quickly and efficiently while also reducing the number of mistakes. Function keys on the side and a thumbwheel make it easy to position the measuring slide and start the measurement. Handles on both sides and the integrated air bearing guarantee that you can accurately and easily move your device on the measuring plate. The new height measuring device is available in three measuring ranges: 350 mm, 600 mm and 1.000 mm.

Applications:

- Intuitive and easy to operate via touch display without the need of extensive training
- Pivotable and tiltable display provides a relaxed working environment
- Air bearing system and handles on both sides ensure easy and smooth movement
- Function keys and a dynamic thumbwheel Intuitive and easy to operate via touch display without the need of extensive training
- Powerful battery for independent operation for up to two shifts



4429601

Order No.	Model	Measuring Range	Resolution	Error Limit
4429600	817 CLT	0 - 350 mm / 0 - 14 in	0.01 mm, 0.005 mm, 0.001 mm, 0.0005 mm, 0.0001 mm / 0.001 in, 0.0005 in, 0.0001 in, 0.00005 in, 0.00001 in	(1.8 + L/600) L in mm
4429601	817 CLT	0 - 600 mm / 0.24 in		(1.8 + L/600) L in mm
4429602	817 CLT	0 - 1.000 mm / 0 - 40 in		(1.8 + L/600) L in mm
Accessories				
6910271	DP-81	Printer set including Bluetooth USB adaptor		
4102220	i-stick	USB adaptor for MarConnect wireless		



For scribing and marking workpieces in the workshop. Easy measurement of heights and distances.



4426100

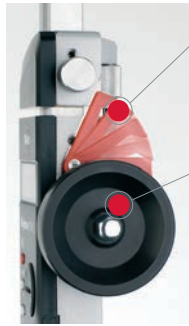

Clamping lever

for quickly securing the slide unit

Handwheel

for easy positioning and measuring



2210091



2247086

Applications:

- Scribing and marking of work pieces
- Measuring heights and distances



Order No.	Model	Measuring Range	Resolution	Details
4426100	814 SR	0 - 350 mm / 0 - 14 in	0.01 mm / 0.0005 in	Digit height 12 mm, handwheel for positioning and measuring
4426101	814 SR	0 - 600 mm / 0 - 24 in	0.01 mm / 0.0005 in	Digit height 12 mm, handwheel for positioning and measuring
2247086	814 SH	-	-	Adjustable mounting bracket to connect Adjustable mounting bracket to connect the PS 10 / RD 18 to a 814 SR
2210091	-	-	-	Height bracket for Pocket Surf IV

Millimar | Electrical length measuring instruments

Precision LVDT based transducers



Millimar probes are available in a wide range of configurations, ranges, air activated and compatibilities with other manufacturers. All probes use Mahr's rotary stroke bearings for high repeatability and long performance.



5313180



5313049



5324020



5323010

Order No.	Model	Measuring Range	Measuring Force	Details
5313180	1318	-0.3 mm - 1 mm	0.25 ± 0.05N	Test indicator style probe
5313049	1304 K	± 1 mm / ± 0.04 in	0.75N ± 0.15N	Small size, right angle probe
5324020	P2010A	± 5 mm / ± 0.197 in	0.75N ± 0.15N	Ball bushing guide, vacuum lifter
5323010	P2004M	±2 mm / ±0.08 in	0.75N ± 0.15N	Ball bushing guide

Millimar C 1200 | Evaluation instrument and measuring probe

Smart and versatile



Millimar length measuring instruments are compact, robust, and easy-to-use. They are versatile evaluation and indicating instruments for measuring tasks of manageable complexity in the production area and in the measuring room.



Note: Shown with optional stand and probe

Features:

- Full-feature bench amplifier
- One probe (LVDT) input
- Battery or line powered
- Bench, wall mount or portable
- Customizable display
- Replaces analog bench amplifiers



Order No.	Model	Numerical Display	Resolution	Details
5312012	C 1200 M	± 5000 μm / 0.19 in	10 μm, 1 μm, 0.1 μm / 0.0001 in, 0.00001 in, 0.000005 in	High resolution, high contrast TFT color display

Millimar C 1202 | Evaluation instrument and measuring probe

New dual channel evaluation unit



Millimar length measuring instruments are compact, robust, and easy to use. They are versatile evaluation and indicating instruments for measuring tasks of manageable complexity in the production area and in the measuring room.



5312025

Features:

- 2-channel length measuring instruments
- With an N 1700 module, the C 1202 becomes a measuring instrument
- One display unit for many applications, different N 1700 modules can be connected
- Maximum 2 measuring channels and 3 features
- E.g.: 1 x N 1702 M for inductive probes or 2 x N 1701 PF for air gaging systems
- Flexible for different measurement tasks



Order No.	Model	Numerical Display	Resolution	Details
5312025	C 1202	± 5000 µm / 0.19 in	10 µm, 1 µm, 0.1 µm / 0.0001 in, 0.00001in, 0.000005 in	High resolution, high contrast TFT color display

Millimar N 1700 | Evaluation modules for C 1202 measuring tasks

Evaluation modules for C1202 display



When the C1202 is combined with the following N1700 evaluation module a powerful and versatile measuring system is created.



5331120

5331155

Features:

- Flexible combination of modules for various sensors and probes
- LVDT, Pneumatic, Vss digital
- Modular and customizable selection of product combinations for solving each specific measuring task

Order No.	Details
5331120	N 1702 2-input LVDT module Mahr compatible
5331125	N 1702 M-HR 2-input LVDT module Mahr compatible - high resolution
5331155	N 1701 PF-2500/5000 Mahr compatible air tooling 1,2 or 3 jet tooling
5331161	N 1702 Vss digital input from probes and rotary encoders
Accessories	
4102603	Data cable DK-U1, USB
4102058	Footswitch 16 ESf
2258471	Air filter + pressure regulator PF
5312950	Extension rail for 2 x PtoE N1701 PF

Millimar | Measuring software

Powerfull and easy-to-use gaging software for use with N 1700 gaging modules



MarWin 13 Millimar Cockpit software, smart, universal software for complex measuring tasks in the manufacturing sector, interactive, touch-sensitive software.



Features:

- Powerful and easy-to-use measuring software
- Can be purchased separately or supplied with N 1700 PC
- 7", touch screen, Windows 10 based industrial PC
- Millimar N 1700 modules for:
 - LVDT – 2 or 4 input, <ahr and competitive brands
 - Air modules
 - Digital encoders
- Mahr measuring instruments with data interface (via USB)
- Measuring tasks can easily be created
- Create user displays in different formats
- Data export (in qs-stat or MS-Excel)



5331130



5331134



5331133



5331155



5331120

Order No.	Model	Details
5312801	C1700 PC	Shop form factor 7 in PC with Cockpit software
5312865	Cockpit software	Cockpit software Marwin 13, powerful and easy-to-use gaging software
5312802	History view	Add on software module Allows for basic graphical review of data, range, average
5331130	N 1701 USB	USB connection module, 430 ma
5331120	N 1702 M	Inductive probe module, 2 Mahr LVDT, range ± 1 mm, ± 2 mm, ± 5 mm / ± 0.040 in, ± 0.080 in, ± 0.2 in
5331140	N 1704 M	Inductive probe module, 4 Mahr LVDT, range ± 1 mm, ± 2 mm, ± 5 mm / ± 0.040 in, ± 0.080 in, ± 0.2 in
5331125	N 1701 M- HR	Inductive probe module, 2 Mahr LVDT with resolution of 0.01 μ m, 0.5 μ in
5331161	N 1702 Vss	Digital input module for Vss probes and rotary encoders
5331133	N 1701 PS	Power supply module, 2000 ma
5331134	N 1704 I/O	Input/output module, 4 inputs / 4 outputs, 10 V- 30 V, lamp/channel
5331155	N1700 PF	Module for Mahr Federal air tool 2500:1 / 5000:1 in, ± 76.5 μ m/ ± 0.0015 μ in

Accessories

2258471	Airkit	Air filter regulator kit for up to 3 air modules
4102058	Foot switch	Foot switch to trigger data transmission

Note: Other modules for Marpos and TESA probes are available

Marameter | Split Ball Bore Gage Systems 844K

Precision measurement for small bores



When combined with extensive accessories (indicating instruments, inside measuring probes with driving needle, holders, extensions and right-angle attachments), inside measuring probes become precision measuring instruments customized to the measuring task.



Note: indicator sold separately

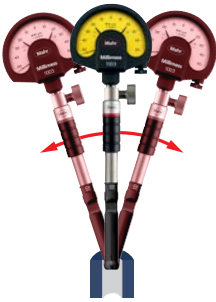

Features:

- Indicating bore a for small precision bores
- Tight tolerances ± 0.002 mm
- Sometimes there is no other solution
- Operator skill is required
- Potential for excellent results
- Options for steel, chrome material thru and blind hole designs split ball bore gage systems 844K

Order No.	Model	Measuring Range	Number of Plugs
4473005	844 K	0.95 mm - 1.55 mm	5
4473006	844 K	1.5 mm - 3.95 mm	9
4472007	844 K	3.7 mm - 9.80 mm	12
4473008	844 K	1.5 mm - 9.8 mm	21
4473009	844 K	9.4 mm - 20.6 mm	11

Marameter | Fixed Plug Gaging systems

Precision measurement for bores at the point of manufacture



Indicating measurement in highest precision plug gages from Mahr are 2-point indicating gages, combined with a precisely ground guide cylinder, which centers itself exactly in bores. This means that no reversal point needs to be determined by rocking. The measured value is displayed reliably, precisely and immediately.



Features:

- Clear benefits
- Fast and easy-to-use
- No operator influence
- Best performance
- Self-centering: no rocking required to determine the reversal point
- Especially suitable with use of digital indicators for processing the measured values
- Each plug is made specific for the requirements, matched to the bore diameter and tolerance

Millimar | Air gages

Inspection tool that allows you to measure many jobs faster



Air Gaging is the inspection tool that allows you to measure many jobs faster, more conveniently, and more accurately than other gaging methods. In the measurement of all hole conditions, air gaging is unsurpassed for speed and accuracy and while in checking any dimensional characteristic, air offers sufficient magnification and reliability to measure tolerances well beyond the scope of mechanical gages.

Air gages effectively measure all common types of dimensions and are particularly suited to checking dimensional relationships. Some of these are taper, parallelism, squareness, straightness, and center distance. Match gaging, which permits the selection of mating parts for a specific amount of clearance or interference, is easily accomplished with just one reading on one dial.

Small gage heads and display units give air gages a distinct advantage in measuring multiple dimensions. Fixtures are smaller and remote meters permit placing contacts in positions that are inaccessible for other types of gages. Air gaging is often combined with electronic signaling to provide instant indication of part size.

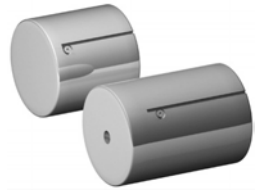

Through hole and blind hole air plugs



Complete ID and OP in process measurement



Ideal for precision taper measurement

MarGage | Setting Masters

Trust in Mahr setting standards and gages - because they are the basis for precise measuring results



Mahr knows metrology. Mahr not only manufactures setting masters for its own gaging, Mahr also manufactures the Precision Length equipment to measure and certify them. During the whole manufacturing process of Mahrs setting standards, the foundations for precision are employed to manufacture to standard set by national and international standards with certification only a step away from national calibration laboratories.



All setting masters are certified with Mahr precision length systems



Master Rings

- Traceable certification and calibration available on request
- Polished and lapped to size
- Non-gaging areas black oxidized – ring faces ground
- Meet all requirements of ANSI Specification B47.1-1988
- Manufactured in accordance with ANSI Specification B89.1.6-1984

Master Plugs

- Traceable certification and calibration available on request
- Stabilized and hardened
- 100 % usable gaging surface
- Ends ground square
- Lapped finish

Master Discs AGD Style 3

- Traceable certification and calibration available on request
- Polished and lapped to size
- Non-gaging areas black oxidized – ring faces ground
- Meet all requirements of ANSI Specification B47.1-1988
- Manufactured in accordance with ANSI Specification B89.1.5
- Furnished with clear insulators
- All dimensions are AGD style 3

Precimar | Length measuring bench

Robust construction makes it suitable for use in production



The Precimar SM 60 (shopfloor machine, measuring range 60 mm / 2.36 in) is an easy to use small length measurement system for fast and precise external measurements.

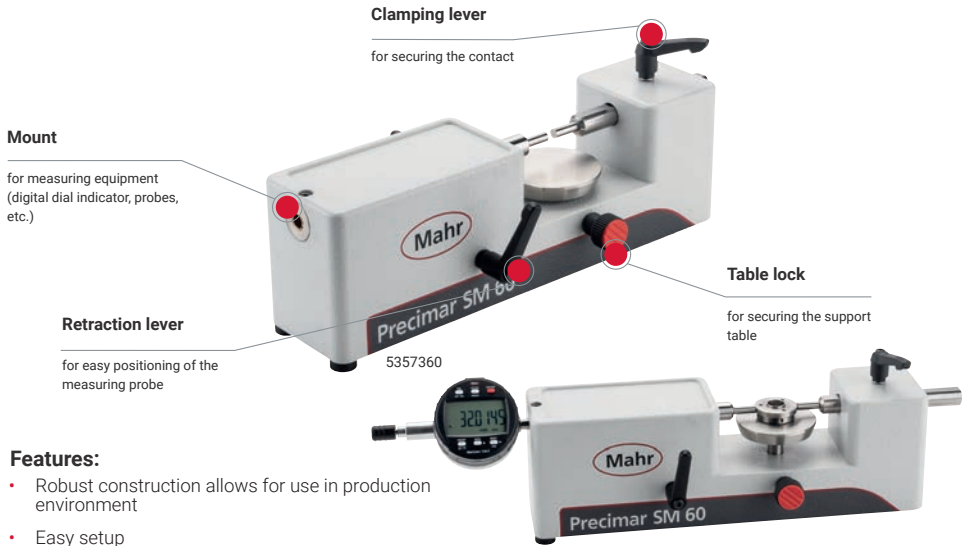

Features:

- Robust construction allows for use in production environment
- Easy setup
- Movable spindle with adjustable reference anvil
- Quickly adapts to new workpieces
- Operation for left and right handed users

Sample application:
Precimar SM 60 shown with MarCator 1086 R
Indicator sold separately

Order No.	Model	Measuring Range	Application Range	Details
5357360	SM 60	0 - 25 mm / 0 - 1 in	0 - 60 mm / 0 - 2.36 in	Size of table ø 60 mm / 2.36 in, mass 9 kg

Pocket Surf® IV | The portable surface roughness gage

Simple to use and easy-to-read



Mobile measuring instruments let you measure exactly where you need the results.

Features:

- 3 parameters Ra, Rmax, Rz
- Four probe positions
- Selectable traverse lengths
- The easiest to use portable surface gage



Order No.	Model	Traverse Length (Nominal)	Evaluation Length	Includes
2191800	Pocket Surf IV	2.0 mm / 0.075 in 3.5 mm / 0.135 in 5.0 mm / 0.195 in	0.8 mm / 0.030 in 2.4 mm / 0.090 in 4.0 mm / 0.150 in	10 µm radius
2191802	Pocket Surf IV	2.0 mm / 0.075 in 3.5 mm / 0.135 in 5.0 mm / 0.195 in	0.8 mm / 0.030 in 2.4 mm / 0.090 in 4.0 mm / 0.150 in	5 µm radius, certified specimen, probe
4102357	16EXu			Data Connection cable USB (2M)

MarSurf PS 10 | Mobile roughness measuring instruments

The best of the mobile



Mobile measuring instruments let you measure exactly where you need the results.

Application:

- Shafts and housing components
- Large machines
- Large workpieces
- Milled and turned parts
- Ground and honed workpieces
- On the production line or directly on the machine; ideal for rapid testing of the surface roughness of a workpiece



Order No.	Model	Measuring Range	Probe	Details
6910230	PS 10	350 μm	Skidded probe system	Minimum 3900 profiles, min. 500,000 results, minimum 1500 PDF measuring records, expandable to 32 GB with microSD card

MarSurf M 310 | Mobile roughness measuring instruments

Easy operation and a robust design.



Mobile measuring instruments let you measure exactly where you need the results.

Features:

- Simple operation concept for intuitive handling without training
- Pre-programmed functionalities and automatic filter selection (auto-cutoff) during measurement - no specialist knowledge required
- Large, bright display for easy operation and maximum overview
- Transmission of measurement protocols and data optionally via Bluetooth or cable
- Easy traceability of measurement results



Order No.	Model	Measuring Range	Probe	Details
6910260	M 310 set	350 μm	Skidded probe system 2 μm stylus tip	Memory for minimum 1500 PDF measuring records and 500,000 measuring results, expandable up to 32 GB using microSD card

MarSurf M 400 | Mobile roughness measuring instruments

Surface evaluations using skidless tracing



Both in the measuring room and increasingly also in the production area, there is a need for surface evaluations requiring skidless tracing.

Applications:

- Machine building: bearings, shafts, racks, valves
- Automotive industry: steering, brake system, gearbox, crankshaft, camshaft, cylinder head, cylinder block, turbocharger
- Steel industry: measurement of sheet metal surface and roller surface
- Medicine: surface roughness measurement for hip and knee endoprostheses
- Aerospace: turbine components



Sample application:
MarSurf M 400 with ST-G



6910404

Order No.	Model	Measuring Range	Probe	Details
6910404	M 400	+/- 250 μm (up to +/-750 μm with 3x probe arm length)	Skidless probe system	Over 50 surface parameters for R-, P- and W-profiles according to current ISO/JIS or MOTIF standards (ISO 12085)

Optimar 25 | Long range indicator calibrator

A precision benchtop instrument



A precision, manual bench top calibrator used to verify a wide variety of measuring instruments such as dial and digital indicators and comparators, test indicators and electronic probes. Includes Millimar C 1202 and digital module for high resolution readings with data output capabilities.



Versatile indicator calibrator



Order No.	Model	Measuring Range	Digital Resolution	Accuracy	Display Power
2062722	Optimar 25	25 mm / 1 in	0,0001 mm, 0,0005 mm, 0,001 mm, 0,005 mm, 0,01 mm, 0,1 mm / 0,000005 in, 0,00001 in, 0,00005 in, 0,0001 in, 0,0005 in, 0,001 in	$\pm 0,2 \mu\text{m}$ ($\pm 10 \mu\text{in}$)	110V - 60Hz, 240V - 50Hz



Mahr Inc.
1139 Eddy Street
Providence, RI 02905



COMPLETE METALWORKING SOLUTIONS
(800) 991-4225 www.ahbinc.com
ISO Certified customerservice@ahbinc.com

Copyright © 2022 Mahr Inc. All rights reserved. Due to technical improvements and/or further product developments, all of the specifications shown in this document are subject to change without notice. Other product and company names listed are trademarks or trade names of their respective companies.

A-808 0722