



Mahr | Production Metrology

Our Online Catalog



COMPLETE METALWORKING SOLUTIONS
(800) 991-4225 www.ahbinc.com
ISO Certified customerservice@ahbinc.com



Product Catalog
Page III

New Products
2022
Page 668



Main Catalog

Production metrology

61

Mahr | Main catalog

Your global partner
for **efficient**
quality assurance

Mahr's DNA

Maximum precision, modern technologies and a worldwide presence – that is what Mahr stands for. As a manufacturer of innovative production metrology, we have been supporting our customers for 161 years, in the measuring room and in production. This experience has made us experts in quality assurance for the automotive industry, mechanical engineering, aerospace, optics, and many other sectors. From manual calipers through to fully automated measuring stations: all of our products are built on the passion and expertise of our 1800 employees worldwide.

Increase productivity

As your global quality assurance partner, we offer products and solutions that combine proven precision with high efficiency. Short measuring times and easy operation speed up work processes. Through a clever combination of different measuring procedures, multiple tasks can be carried out by a single system – and in one setup. At the same time, innovative software tools and a wide choice of interfaces ensure that Mahr metrology is in tune with modern manufacturing requirements. Ensuring the productivity of your quality assurance is our aim.



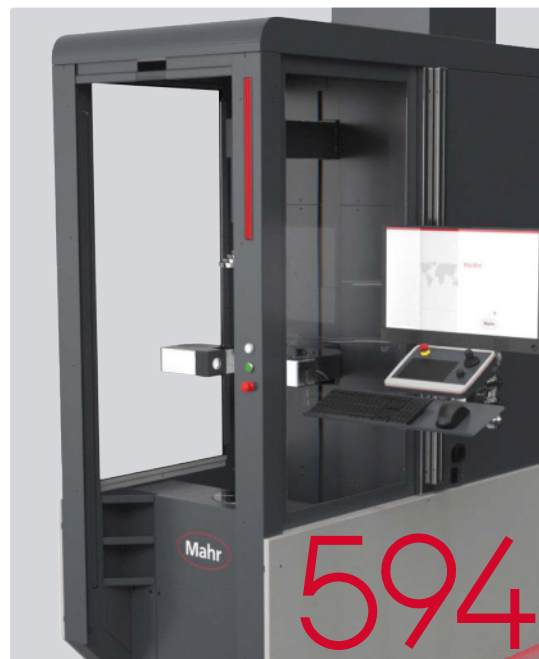
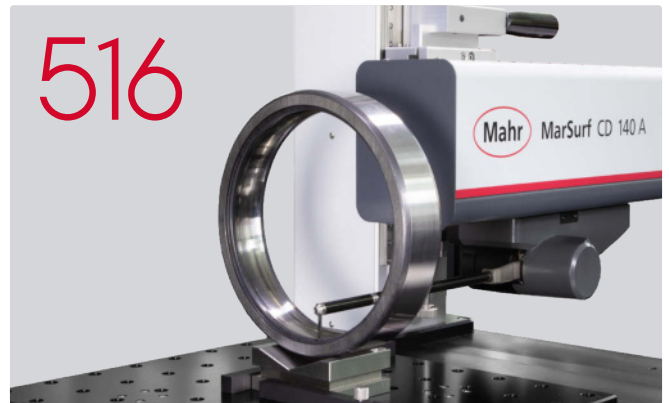

Contents

Data transfer	MarConnect Wireless / Cable interfaces Software	4
----------------------	--	---

Handheld metrology	MarCal Calipers	18
	Micromar Micrometers	60
	MarTest Dial test indicator measuring devices 3D touch probe	102
	MarCator Dial indicators	128
	Millimes Dial comparators	182
	MarStand Measuring stands Measuring tables Radial runout gages	268
	Marameter Indicating measuring devices	290
	Multimar Universal measuring devices	408
MarGage Standards Dimensional standards	440	

Length metrology	Millimar [®] Electronic and pneumatic length metrology	212
	Digimar Height measuring devices	472
	Precimar Precision length metrology	490

Surface, contour and topography metrology	MarSurf Tactile surface metrology	516
	MarSurf 3D Optical surface metrology	550

Metrology for form, position, gears and dimensions	Mar4D Cylinder coordinate metrology	594
	MarForm Form metrology	600
	MarShaft Shaft metrology	624
	MarGear Gear metrology	618
	MarOpto Metrology for the optical industry	580
	MarVision Measuring microscopes	570

Customized solutions	Mahr Engineered Solutions	638
-----------------------------	----------------------------------	-----

Service	Mahr Service Product-related services	646
----------------	--	-----

MarConnect | Measuring data processing

All new digital handheld measuring instruments come with the MarConnect flexible interface concept. Whether Integrated Wireless, external wireless modules, USB, Opto RS232, or Digimatic: Whatever interface standard you use, MarConnect always ensures an optimal connection.

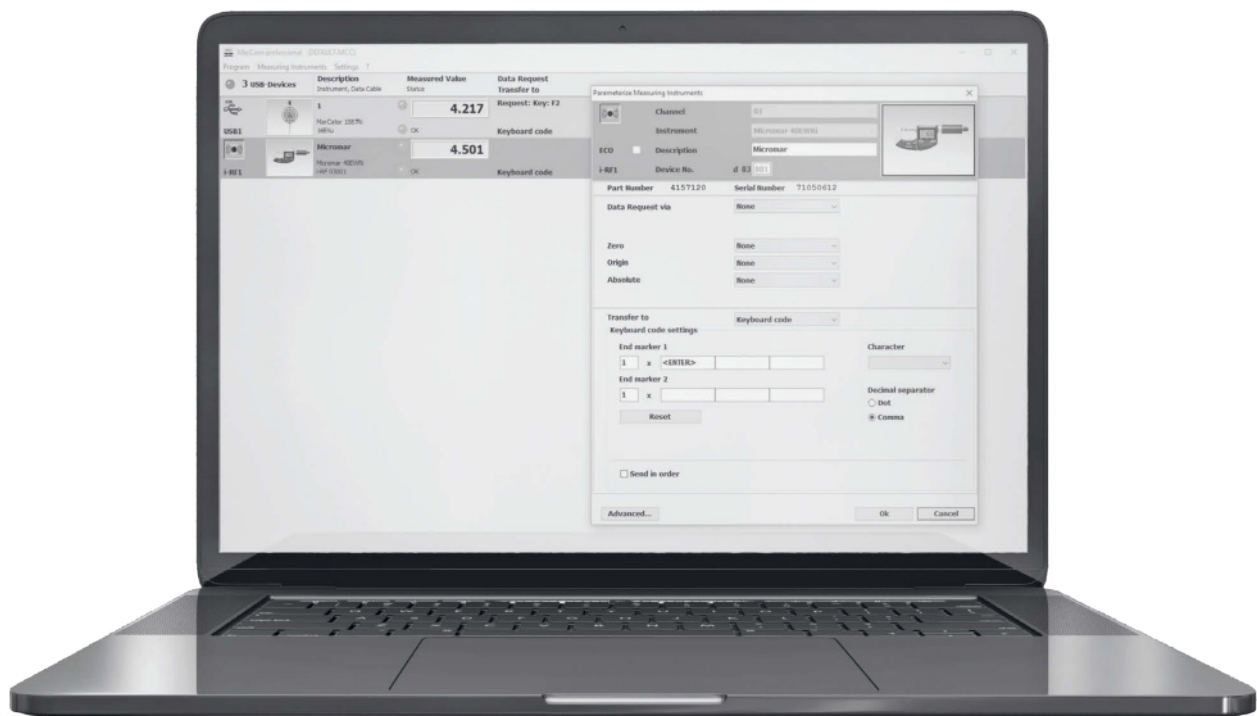

MarConnect measuring data processing Wireless to the result	6
MarConnect MarCom Professional Software interface	10
MarConnect i-Stick Wireless receiver for measuring devices with Integrated Wireless	12
MarConnect e-Stick Wireless receiver	14
MarConnect data cable	
MarConnect Opto USB / Millimar USB / 817 USB / 16 EXu / DK-U1 / MC-I / 800 EWu / 2000 USB / 838 USB USB data cable	15
MarConnect 16 EXr / 16 Esv / 800 EWr / 2000 r RS232C data cable	16
MarConnect DK-D1 / 16 EWd / 2000 d / 838 di (A) Digimatic data cable	17

Wireless to the result

Best performance in every step

Mahr's portfolio of wireless devices offers you maximum mobility for your measuring tasks. The wireless solution of Integrated Wireless measuring instruments means you can measure without impediment. Mahr measuring instruments are ideal tools for every manufacturing environment, reliably delivering the performance you have come to expect from state-of-the-art handheld measuring instruments.

Save costs

Use your wireless connection for the price of a cable. Purchasing a USB receiver stick (i-Stick) for your computer allows you to operate up to eight measuring devices simultaneously and saves you the additional cost of a connecting cable.

Unclutter

Keep your workplace clear of restrictive data cables.

ID transmission

Serial and order numbers are sent out by the measuring device and stored in the recorded measurement log.



Reliable

With integrated transmission, visual feedback is provided verifying data transmission. Error message signifies loss of data connector.



Maximum mobility

Measure autonomously and without limits. Thanks to their wireless, compact system, Mahr measuring instruments allow precise measuring – even in the machine or on difficult-to-reach workpieces.

6 meter range

8 measuring instruments simultaneously per i-Stick receiver

Integrated transmitter

Eliminate hazards such as cable breakage and wear.



Free software

Benefit from the MarCom Professional 5.3 interface software and transfer the measurement data individually and conveniently to your Windows applications or CAQ software.

81 device versions for every measuring task



It couldn't be easier!

Scan the QR code and see how Integrated Wireless handheld measuring instruments are used in practice.

Your interface for **even greater performance**

Two steps to the goal: combine your Integrated Wireless instruments with our multifunctional MarCom Professional software. This versatile interface tool combines data acquisition and data transfer with your data processing. How you process the collected data is entirely up to you – for maximum flexibility, choose from a range of output formats.

Enjoy maximum individuality at the workplace with a free choice of output medium and four output formats:

- Virtual interface box: CAQ/SPC software
- Intelligent Excel interface: Microsoft Excel
- Emulation keyboard: any Windows software
- Text file: flexible data processing

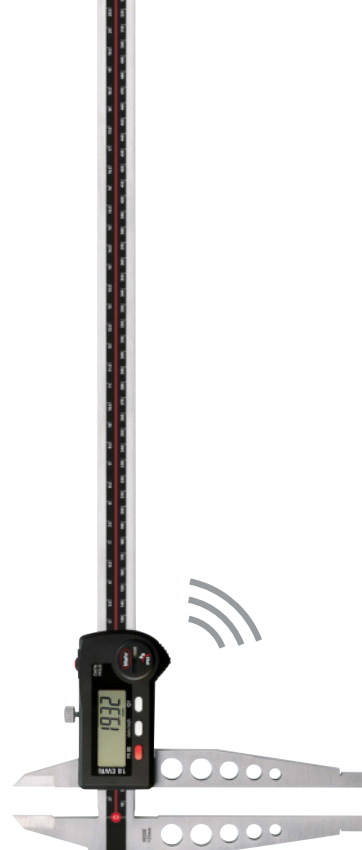

MarCal 18 EWRi workshop caliper with Integrated Wireless

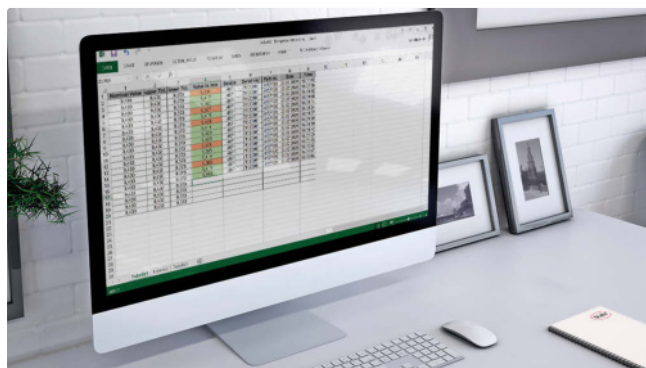

MarCom Professional is IATF ready and features a comprehensive range of functions for data transfer and data processing.

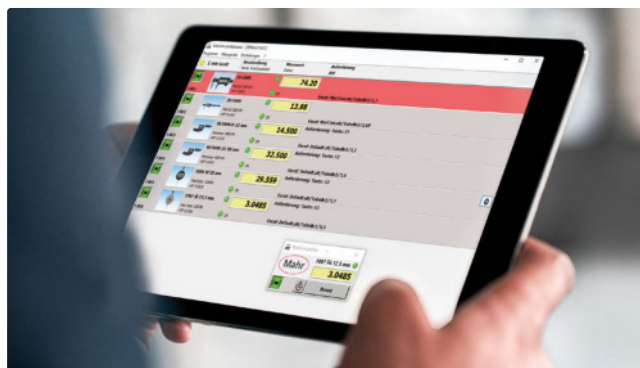



Micromar 40 EWRi micrometer with Integrated Wireless

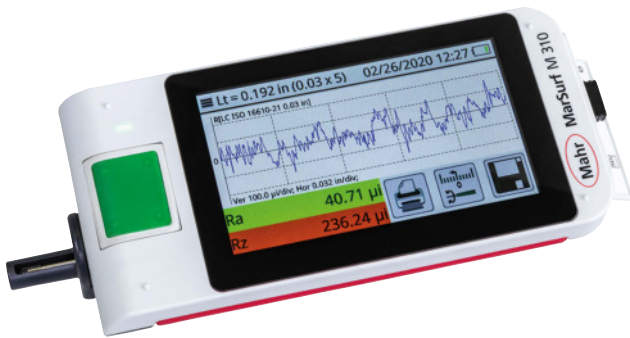

MarSurf M 310 roughness measuring instrument with Bluetooth® stick

Improved functions:

- Additional data: Additional values are transferred to supplementary columns (name, serial number, item number, date and time)
- Device parameters can now be preset: reference values (preset, tolerance limits, warning limits in %), as well as, function locks can be queried and changed on the instrument
- Improved Excel functionality:
 - Easily undo the last data transfer – right in the program with a simple click
 - Adapted column and row names: Z1S1 reference style for use with Excel as in practice

Powerful and user-friendly due to continual updates!

Perfectly coordinated: MarCom Professional is the ideal data transfer software for all your quality assurance and production needs then start new sentence It is perfectly equipped from the Integrated Wireless product line. A number of additional functions offer users maximum convenience when recording and transferring measurements.

3x

faster configuration

Save time: conveniently configure your measuring instruments via PC interface and eliminate the need for manually setting the instrument.

99 %

more reliable

Avoid operating errors: all information is automatically transferred and assigned thanks to the automatic identification of measurements and serial number transfers.

New features:

- IATF ready: transfers and displays the measuring equipment ID and item and serial number to clearly allocate the measuring equipment to the measurements
- Tab settings in up to 3 areas: settings, device parameters and goal
- Scalable measurement value display
- Manually sort the device overview using drag-and-drop



FEATURES

- Direct transfer of measuring values into MS Excel (version 97 or later), into SPC software via virtual interface box (MUX 50 format) (professional) or into a text file or via a keyboard code
- The measuring values for each connected measuring instrument can be copied into a separate column, table or folder in Excel
- USB hubs can also be connected as a measuring instrument interface
- Clear depiction of the selected measuring devices by means of icons
- Manual sorting of the device overview using drag-and-drop
- Scalable measurement value display
- Configure device parameters easily. Reference values (preset, tolerance limits, warning limits) as well as function locks can be queried and changed on the instrument
- Freely definable and configurable measurement cycles
- Flexible, user-friendly transfer of measuring values via the 'Data' button on the measuring device or data cable or via a PC keyboard, timer, foot switch connected to a USB interface or via wireless remote control
- Additional data: Transfers and displays the measuring equipment ID and item and serial number to clearly allocate the measuring equipment to the measurements
- Easily undo the last data transfer – right in the program with a simple click
- **Package contains:** driver, instruction manual
- **Software:** MarCom Professional free download: www.mahr.com/marcom (only for Mahr data cables and wireless systems with USB and RS-232 interface)

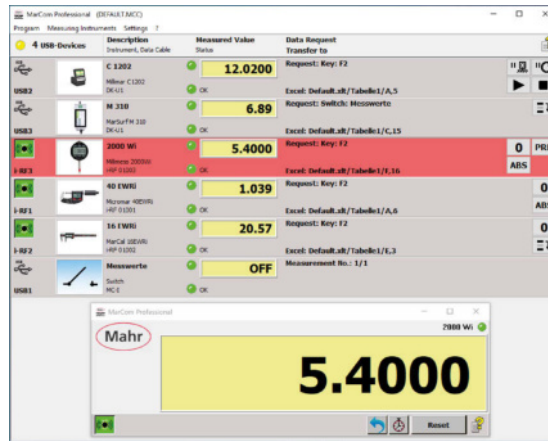

TECHNICAL DATA

Type	MarCom Professional
Number of connectable wireless receivers for i-Stick	4
Number of connectable measuring instruments with Integrated Wireless	32
Number of connectable wireless receivers for e-Stick	1
Number of connectable transmission modules for e-Stick	8
Number of connectable wireless receivers FM 2	1
Number of connectable transmission modules for wireless receiver FM 2	100
Number of connectable measuring instruments with USB interface	128
Number of connectable USB foot switches	128
Number of connectable measuring instruments with RS232C interface	2
Number of virtual interface boxes (8 inputs)	4
Languages	German, English, French, Italian, Spanish, Dutch, Russian, Polish, Portugese, Czech, Chinese, Romanian, Hungarian, Japanese

ACCESSORIES

Order no.	Description	Type	For measuring instrument
4102220	Receiver for instruments with Integrated Wireless	i-Stick	MarCal 16 EWri / 30 EWRi, MarCator 1086 Ri / 1086 WRi / 1087 Ri / 1087 BRi, Micromar 40 EWRi / 40 EWRi-L, Millimes 2000 W(i), 2001 W(i), Digimar 817 CLT
4102230	e-Stick Receiver	e-Stick	Transmission modules 16 EWe, 2000 e, RS232 e
4102305	Receiver	FM 2	Transmission modules 16 EXf, 1082 f, 2000f, 817 f, RS232 f
4102231	USB Bluetooth adapter	16 EWe	MarCal 16 ER, 16 EWR, 16 EWW, 18 EWR, 30 EWR, 30 EWN Digimar 814 SR Micromar 40 EWR (≤2017), 40 EWS, 40 EWW, 44 EWR, 46 EWR MarCator 1075 R, 1086 R, 1087 R, 1087 BR MarSurf PS1, PS10
4102306	16 EWe Transmitter for e-Stick	16 EXf	MarCal 16 ER, 16 EWR, 16 EWW, 18 EWR, 30 EWR, 30 EWN Digimar 814 SR Micromar 40 EWR (≤2017), 40 EWS, 40 EWW, 44 EWR, 46 EWR MarCator 1075 R, 1086 R, 1087 R, 1087 BR
4102357	16 EXf Transmitter for FM 2	16 EXu	MarCal 16 ER, 16 EWR, 18 EWR, 30 EWR, 30 EWN Digimar 814 SR Micromar 40 ER, 40 EWR (≤ 2017), 40 EWW, 40 EWS, 44 EWR, 46 EWR MarCator 1075 R, 1086 R, 1086 Ri, 1087 R, 1087 Ri, 1087 BR, 1087 BRi MarSurf PS1, PS10, M300, M300C
3003856	16 EXu Data connection cable USB (2 m)	USB BT	MarSurf M 310

MarConnect MarCom Professional

Software interface

ACCESSORIES

Order no.	Description	Type	For measuring instrument
4102410	Data connection cable RS232C (2 m)	16 EXr	MarCal 16 ER, 16 EWR, 18 EWR, 30 EWR, 30 EWN Digimar 814 SR Micromar 40 ER, 40 EWR (≤ 2017), 40 EWW, 40 EWS, 44 EWR, 46 EWR MarCator 1075 R, 1086 R, 1086 Ri, 1087 R, 1087 Ri, 1087 BR, 1087 BRi MarSurf PS1, PS10, M300, M300C
4102232	2000 e Transmitter for e-Stick	2000 e	Digimar 816 CL MarCator 1088 / 1088W Millimes 2000, 2001, 2100, μ Maxum II Millimar C1200
4102309	2000 f Transmitter for FM 2	2000 f	Digimar 816 CL, Millimar C 1200 MarCator 1088 / 1088W Millimes 2000, 2001, 2100, μ Maxum II
4346023	2000 USB data connection cable USB (2 m)	2000 USB	Digimar 816 CL, Millimar C1200 MarCator 1088, 1088 W Millimes 2000, 2001, 2100, μ Maxum II
4346020	Data connection cable RS232C (2 m)	2000 r	Digimar 816 CL, Millimar C1200 MarCator 1088, 1088 W Millimes 2000, 2001, 2100, μ Maxum II
7024634	Data connection cable RS232C (3 m)		Digimar 817 CLM Millimar C1208, C1216, 1240, C1245, S1840, S1841, X1715, X1745, 832
4102233	RS-232 e Transmitter for e-Stick	RS-232 e	Millimar C1208, C1216, C1245, S1840, Digimar 817 CLM
4102331	Millimar - USB Adapter cable RS-232-USB (0,2 m)	Millimar - USB	Millimar C1208, C1216, 1240, C1240, C1245, S1840, S1841, X1715, X1741, 832 (in conjunction with cable 7024634)
4102310	817 f Transmitter for FM 2	817 f	Digimar 817 CLM
4102333	817 USB Adapter cable RS232-USB (0,2 m)	817 USB	Digimar 817 CLM (in conjunction with cable 7024634)
4102311	RS232 f Transmitter for FM 2	RS232 f	Millimar C1208, C1216, C1245, S1840
4102307	1082 f Transmitter for FM 2	1082 f	Digimar M814 N/G Multimar 25 ES MarTool 106 ES
4102510	Data connection cable RS232C (2 m)	16 ESv	Digimar 814 G, 814 N Multimar 25 ES MarTool 106 ES
4102330	Opto USB Adapter cable RS232-USB (0,2 m)	Opto USB	Digimar M814 (in conjunction with cable 4102510) Multimar 25 ES (in conjunction with cable 4102510) MarTool 106 ES (in conjunction with cable 4102510)
4305121	800 EWu data connection cable USB (2 m)	800 EWu	MarCal 31 EW MarTest 800 EW, 800 EWL
4305122	Data connection cable RS232C (2 m)	800 EWr	MarCal 31 EW MarTest 800 EW, 800 EWL
4102553	USB-Hub 7-fold industrial model	USB-Hub	
4102782	MC-I adaption cable (for foot switch via MarCom): jack plug \varnothing 3.5 mm/USB (0,1 m)	MC-I	Foot switch 16 ESf
4102058	Foot switch to trigger data transmission	16 ESf	
4102221	Wireless remote control for MarCom	MC-R	
4102603	Data cable USB bi-directional (2 m)	DK-U1	Micromar 40 EWR (≥ 2018), Millimar C 1202, MarSurf M310, Millimes 2000 W(i), 2001 W(i), Digimar 817 CLT
4102606	Interface adapter with data cable Digimatic (2 m)	DK-D1	Micromar 40 EWR (≥ 2018), Millimar C 1202, Millimes 2000 W(i), 2001 W(i)





FEATURES

- Unlike conventional wireless solutions, which have a large external transmitter with separate battery, the transmitter in integrated wireless is fully integrated.
- The lack of external cables and modules allows for high mobility
- With Integrated Wireless, you can transfer your measured values to the PC using the i-Stick
 - As with a data cable, the measured values are accepted via the MarCom Software directly into MS Excel® or via a keyboard code into any Windows application
- Safe and reliable data transfer
 - Instruments display messages confirming data has been received
 - Confirms being in range of i-Stick
- Long battery life
 - Negates need for additional battery
- With Integrated Wireless, you can connect up to 8 measuring instruments per i-Stick receiver
 - Expensive interface boxes are no longer necessary
- **Package contains:** i-Stick wireless receiver, driver
- **Software:** MarCom Professional free download: www.mahr.com/marcom (only for Mahr data cables and wireless systems with USB and RS-232 interface)



TECHNICAL DATA

Order no.	4102220	
Number of channels		3
Frequency band	MHz	2400
Radio range		Up to 6 m
Type		i-Stick
Number of connectable wireless receivers for i-Stick		4
Number of connectable measuring instruments with Integrated Wireless		32
For measuring instrument		MarCal 16 EWRI / 18 EWRI / 30 EWRI MarCator 1086 Ri / 1086 WRi / 1087 Ri / 1087 BRi Micromar 40 EWRI / 40 EWRI-L Millimes 2000 W(i), 2001 W(i) Multimar 25 EWRI Digimar 817 CLT

MarConnect i-Stick

Receiver for instruments with Integrated Wireless

ACCESSORIES

Order no.	Description	Type
4103400	Digital caliper, 0 – 150 mm, 0.01 mm	16 EWRI
4103401	Digital caliper, 0 – 150 mm, 0.01 mm	16 EWRI
4103402	Digital caliper, 0 – 150 mm, 0.01 mm	16 EWRI
4103403	Digital caliper, 0 – 150 mm, 0.01 mm	16 EWRI
4103404	Digital caliper, 0 – 200 mm, 0.01 mm	16 EWRI
4103405	Digital caliper, 0 – 200 mm, 0.01 mm	16 EWRI
4103406	Digital caliper, 0 – 300 mm, 0.01 mm	16 EWRI
4103407	Digital caliper, 0 – 300 mm, 0.01 mm	16 EWRI
4112571	Digital workshop caliper, 0 – 300 mm, 0.01 mm	18 EWRI
4112572	Digital workshop caliper, 0 – 500 mm, 0.01 mm	18 EWRI
4112573	Digital workshop caliper, 0 – 750 mm, 0.01 mm	18 EWRI
4112574	Digital workshop caliper, 0 – 1000 mm, 0.01 mm	18 EWRI
4126755	Digital depth gage, 0 – 150 mm, 0.01 mm	30 EWRI
4126756	Digital depth gage, 0 – 300 mm, 0.01 mm	30 EWRI
4126757	Digital depth gage, 0 – 500 mm, 0.01 mm	30 EWRI
4119050	Digital universal calipers, 0 – 300 mm, 0.01 mm	25 EWRI
4119051	Digital universal calipers, 0 – 600 mm, 0.01 mm	25 EWRI
4119052	Digital universal calipers, 0 – 1000 mm, 0.01 mm	25 EWRI
4119053	Digital universal calipers, 0 – 1250 mm, 0.01 mm	25 EWRI
4337624	Digital indicator, 0.0005 mm, 12.5mm	1086 Ri
4337625	Digital indicator, 0.0005 mm, 25 mm	1086 Ri
4337626	Digital indicator, 0.0005 mm, 50 mm	1086 Ri
4337627	Digital indicator, 0.0005 mm, 100 mm	1086 Ri
4337628	Digital indicator, 0.0005 mm, 25 mm	1086 Ri
4337134	Digital indicator, 0.01 mm, 12.5mm	1086 Ri
4337135	Digital indicator, 0.01 mm, 25 mm	1086 Ri
4337136	Digital indicator, 0.01 mm, 50 mm	1086 Ri
4337137	Digital indicator, 0.01 mm, 100 mm	1086 Ri
4337142	Digital indicator, 0.0005 mm, 12.5mm	1086 WRi
4337143	Digital indicator, 0.0005 mm, 25 mm	1086 WRi
4337147	Digital indicator, 0.01 mm, 12.5mm	1086 WRi
4337148	Digital indicator, 0.01 mm, 25 mm	1086 WRi
4337663	Digital indicator, 0.0005 mm, 12.5mm	1087 Ri
4337665	Digital indicator, 0.0005 mm, 25 mm	1087 Ri
4337664	Digital indicator, 0.0005 mm, 12.5mm	1087 BRi
4157100	Digital bracket micrometer screw, 0 – 25 mm	40 EWRI
4157101	Digital micrometer, 25 – 50 mm	40 EWRI
4157102	Digital bracket micrometer screw, 50 – 75 mm	40 EWRI
4157103	Digital bracket micrometer screw, 75 – 100 mm	40 EWRI
4346701	Inductive dial comparator, $\pm 1 \mu\text{m}$	2000 Wi
4346801	Inductive dial comparator, $\pm 1 \mu\text{m}$	2001 Wi
4429600	Digimar 0 – 350 mm	817 CLT
4429601	Digimar 0 – 600 mm	817 CLT
4429602	Digimar 0 – 1000 mm	817 CLT



16 EWRI;
800 SR



30 EWRI



1086 Ri



40 EWRI



1087 Ri



FEATURES

- For upgrading all Mahr handheld measuring instruments with data interface
- Wireless measuring value transfer from measuring equipment to PC
- Secure data transfer thanks to receipt of measuring value confirmation from PC to measuring equipment
- Optical confirmation of receipt at transmission module
- Compact transmission modules without external antenna
- Bidirectional transmission path (remote enquiry from measuring equipment)
- Radio frequency of 2400 MHz
- **Package contains:** e-stick wireless receiver, driver
- **Software:** MarCom Professional free download: www.mahr.com/marcom (only for Mahr data cables and wireless systems with USB and RS-232 interface)



Application:

- Wireless data transmission from a measuring instrument to a PC

TECHNICAL DATA

Order no.	4102230		
Frequency band	MHz	2400	
Radio range	Up to 6 m		
Type	e-Stick		
Number of connectable wireless receivers for e-Stick	1		
Number of connectable transmission modules for e-Stick	8		
For measuring instrument	Transmission modules 16 EWe, 2000 e, RS232 e		

ACCESSORIES

Order no.	Description	Type	For measuring instrument
4102231	16 EWe Transmitter for e-Stick	16 EWe	MarCal 16 ER, 16 EWR, 16 EWW, 18 EWR, 30 EWR, 30 EWN Digimar 814 SR Micromar 40 EWR (≤2017), 40 EWS, 40 EWW, 44 EWR, 46 EWR MarCator 1075 R, 1086 R, 1087 R, 1087 BR MarSurf PS1, PS10
4102232	2000 e Transmitter for e-Stick	2000 e	Digimar 816 CL MarCator 1088 / 1088W Millimes 2000, 2001, 2100, µMaxum II Millimar C1200
4102233	RS-232 e Transmitter for e-Stick	RS-232 e	Millimar C1208, C1216, C1245, S1840, Digimar 817 CLM



16 EWe



2000 e

MarConnect Opto USB / Millimar - USB / 817 USB / 16 EXu / DK-U1 / MC-I / 800 EWu / 2000 USB / 838 USB



Adapter cable RS232-USB

FEATURES

- For connecting the measuring instrument to a PC
- Data transfer to MarCom or other applications via virtual communication interface
- **Package contains:** USB cable, driver
- **Software:** MarCom Professional free download: www.mahr.com/marcom (only for Mahr data cables and wireless systems with USB and RS-232 interface)



Application:

- Data recorded with PC, laptop or tablet using MS-Windows operating system

TECHNICAL DATA

Order no.	Cable length	Type	For measuring instrument
	m		
2121428	2		Maxum III (E2)
4102330	0.2	Opto USB	Digimar M814 (in conjunction with cable 4102510) Multimar 25 ES (in conjunction with cable 4102510) MarTool 106 ES (in conjunction with cable 4102510)
4102331	0.2	Millimar - USB	Millimar C1208, C1216, 1240, C1240, C1245, S1840, S1841, X1715, X1741, 832 (in conjunction with cable 7024634)
4102333	0.2	817 USB	Digimar 817 CLM (in conjunction with cable 7024634)
4102357	2	16 EXu	MarCal 16 ER, 16 EWR, 18 EWR, 30 EWR, 30 EWN Digimar 814 SR Micromar 40 ER, 40 EWR (≤ 2017), 40 EWW, 40 EWS, 44 EWR, 46 EWR MarCator 1075 R, 1086 R, 1086 Ri, 1087 R, 1087 Ri, 1087 BR, 1087 BRi MarSurf PS1, PS10, M300, M300C, PocketSurf IV
4102603	2	DK-U1	Micromar 40 EWR (≥ 2018) Millimar C 1202 MarSurf M310 Millimes 2000 W(i), 2001 W(i)
4102782	0.1	MC-I	Foot switch 16 ESf
4305121	2	800 EWu	MarCal 31 EW MarTest 800 EW, 800 EWL
4346023	2	2000 USB	Digimar 816 CL MarCator 1088, 1088 W Millimes 2000, 2001, 2100, μ Maxum II
4495079	1.5	838 USB	Marameter 838 EI, 838 EA

ACCESSORIES

Order no.	Description	Type
4102221	Wireless remote control for MarCom	MC-R
4102553	USB-hub 7-fold industrial model	USB-hub
4102058	Foot switch to trigger data transmission	16 ESf



FEATURES

- For connecting the measuring instrument to an interface box or PC
- Data transfer to MarCom or to other applications via communication interface
- **Software:** MarCom Professional free download: www.mahr.com/marcom (only for Mahr data cables and wireless systems with USB and RS-232 interface)



Application:

- Data collection with RS232 compatible devices

TECHNICAL DATA

Order no.	Cable length	Type	For measuring instrument
	m		
4102410	2	16 EXr	MarCal 16 ER, 16 EWR, 18 EWR, 30 EWR, 30 EWN Digimar 814 SR Micromar 40 ER, 40 EWR (≤ 2017), 40 EWW, 40 EWS, 44 EWR, 46 EWR MarCator 1075 R, 1086 R, 1086 Ri, 1087 R, 1087 Ri, 1087 BR, 1087 BRi MarSurf PS1, PS10, M300, M300C, PocketSurf IV
4102510	2	16 ESv	Digimar 814 G, 814 N Multimar 25 ES MarTool 106 ES
4305122	2	800 EWr	MarCal 31 EW MarTest 800 EW, 800 EWL
4346020	2	2000 r	Digimar 816 CL MarCator 1088, 1088 W Millimes 2000, 2001, 2100, µMaxum II
7024634	3		Digimar 817 CLM Millimar C1208, C1216, 1240, C1245, S1840, S1841, X1715, X1745, 832

MarConnect DK-D1 / 16 EWd / 2000 d / 838 di (A)



Interface adapter with data cable Digimatic

FEATURES

- For connection to Digimatic compatible interfaces and evaluation equipment



Application:

- Data collection with Digimatic-compatible devices

TECHNICAL DATA

Order no.	Cable length	Type	Inputs	For measuring instrument
	m			
2239035	2		Footswitch	Maxum III dial comparator with 6-pin data output
2239037	2			Maxum III μ Indicator with 10-pin output port
4102606	2	DK-D1		Micromar 40 EWR (≥ 2018) Millimar C 1202 Millimes 2000 W(i), 2001 W(i)
4102915	2	16 EWd		MarCal 16 ER, 16 EWR, 18 EWR, 30 EWR, 30 EWN Digimar 814 SR Micromar 40 ER, 40 EWR (≤ 2017), 40 EWW, 40 EWS, 44 EWR, 46 EWR MarCator 1075 R, 1086 R, 1086 Ri, 1087 R, 1087 Ri, 1087 BR, 1087 BRi MarSurf PS1, M300, M300C
4346021	2	2000 d		Digimar 816 CL MarCator 1088, 1088 W Millimes 2000, 2001, 2100, μ Maxum II Millimar C1200
4495083	1.5	838 di (A)		Marameter 838 EI, 838 EA

MarCal | Calipers

Calipers are some of the most important measuring instruments in production metrology because they are both versatile and easy to use. Digital devices are simple to operate, easy to read, and data acquisition is fast and uncomplicated.



Overview MarCal calipers	20
MarCal 16 EWRI / 16 EWR / 16 ER Digital calipers	24
MarCal 16 U Dial calipers	29
MarCal 16 FN / 16 GN / 16 DN With scale display	30
MarCal 18 EWRI / 18 EWR / 18 ESA Digital workshop calipers	32
MarCal 18 NA Workshop calipers	35
MarCal 16 EWRI-V / 16 EWR-V / 18 EWR-V Digital universal calipers	36
Digital special calipers Digital calipers for special applications	42
MarCal 30 EWRI / 30 EWR Digital depth gages	56
MarCal 30 EWRI-D / 30 EWR-D / 30 EWRI-N / 30 EWR-N Digital depth gages	58

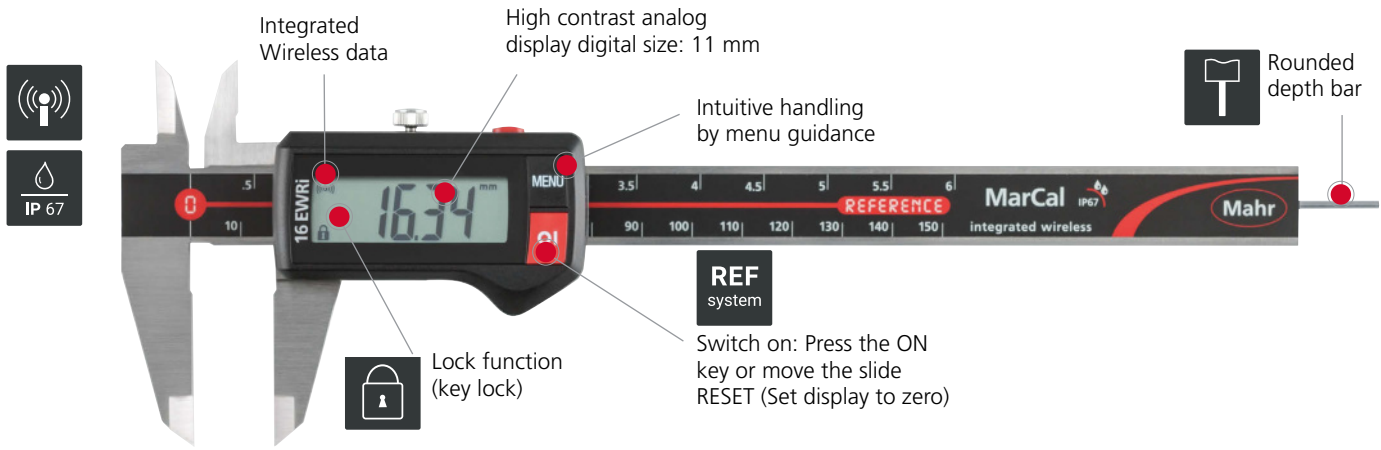
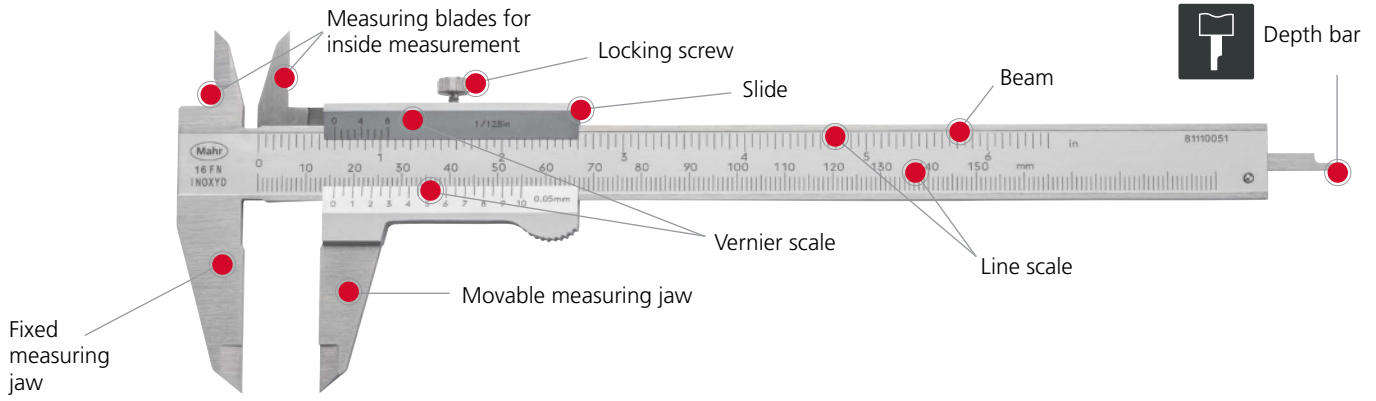

MarCal | Types of measurement

16 series calipers (e.g. 16 EWri, 16 U, 16 FN) can be used to conduct 4 different types of measurements:

a) Outside measurement

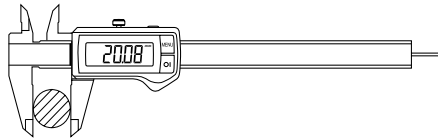

b) Inside measurement

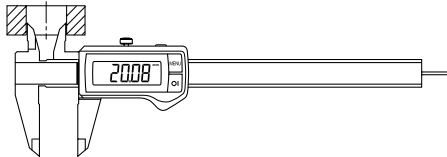

c) Depth measurement

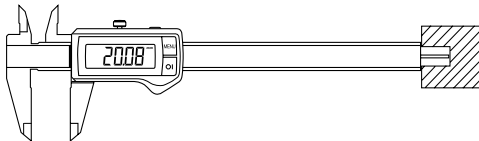

d) Step (distance) measurement

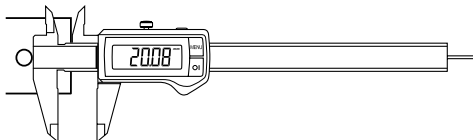

Error limits G according to DIN 862

Measuring length	Error limits G in μm		
	Scale interval and/or vernier interval		Resolution
mm	0.1 and 0.05	0.02	0.01
50	50	20	20
100			
200			
300	60	30	30
400			
500			
600	80	40	40
700			
800			
900	100	40	40
1000			
1200			
1400	140	50	—
1600			
1800			
2000	220	60	—

MarCal - The innovative Reference System



All Mahr digital calipers with this **REF system** logo are equipped with the innovative Reference System. The zero position only has to be set once: after setting the zero position, the zero remains stored for all further measurements. Therefore, once the caliper is switched ON or the slide is moved, the caliper is immediately ready for measurement. Once the caliper is initially set to zero, there is no need to reset to zero each time the caliper is turned on.

Conventional

- ① Switch ON
- ② Close the measuring jaws
- ③ Set to zero
- ④ Results of measurement

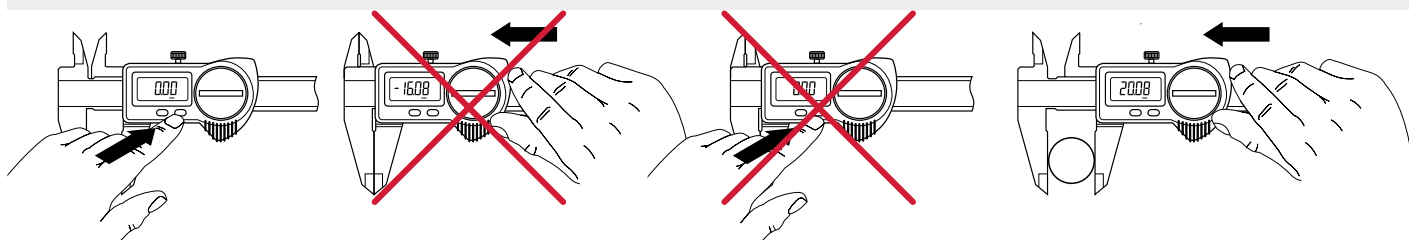

- ① Switch ON
- ② Results of measurement

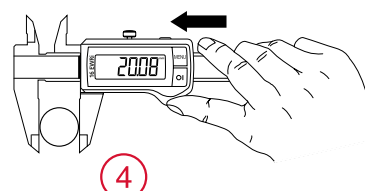
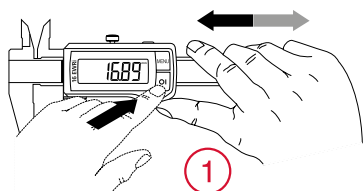

Press the ON key

or

move the slide

IP Protection classes

First digital is the degree of protection according to IEC 60529 – against particles, contaminants and dust

- 0 Not protected
- 1 Particles > 50.0 mm
- 2 Particles > 12.5 mm
- 3 Particles > 2.5 mm
- 4 Particles > 1.0 mm
- 5 Dust protected
- 6 Dust tight

Second digital is the degree of protection according to IEC 60529 (approximate) – against wet conditions (fluids)

- 0 Not protected
- 1 Falling water drops - vertical
- 2 Falling water drops - tilted < 15°
- 3 Spray water < 60°
- 4 Water splashing from all directions
- 5 Water jets from all directions
- 6 Powerful water jets
- 7 Temporary immersion in water
- 8 Continuous immersion under pressure



Example
IP67 means that the product is dust tight and is protected against temporary immersion in water.

MarCal | The new generation Waterproof digital calipers with the Reference System and Integrated Wireless

Security due to the Reference Lock function

- Zero-position is secured
- Operating error is not possible

The MarCal 16 EWRi digital caliper with the Reference System is equipped with a LOCK function. With this key lock, the zero position is secured and operating error is avoided.



Battery service life is 3 years

The Reference System is extremely energy efficient because of its standby mode feature; almost no power is required, thus extending the life of the battery up to 3 years*.

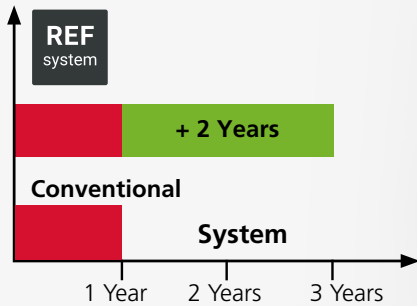

* When Integrated Wireless is deactivated

Superior quality of the guideways

Only MarCal calipers have lapped guideway surfaces that guarantee an even and sensitive run of the slide. Additionally, the service life of the caliper increases, compared to a ground guideway due to the greater contact area on the guideway surface.



Surface of the guideway

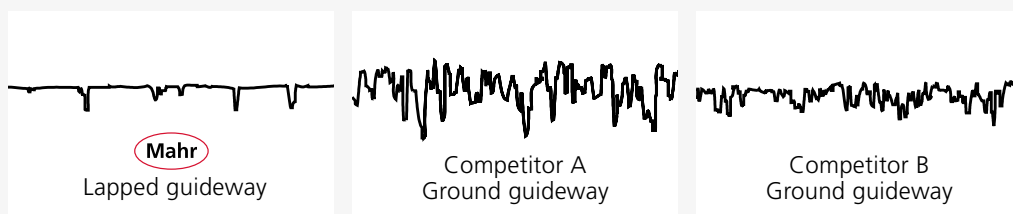

MarConnect Integrated Wireless



Wireless data transmission for the price of a data cable.

With Mahr's Integrated Wireless, users have a new Integrated Wireless data transmission system for the price of a data cable. Data acquisition with digital calipers is now even simpler: simply transmit your measured data directly into Microsoft Office Excel® or any Windows program with a keyboard code.

Secure data transmission



With Integrated Wireless, your data will be transferred to the digital indicator, which is confirmed with a message on the digital indicator's display. The message will show whether the sent data has been transferred correctly, and/or whether you are in the reception range of the i-Stick.

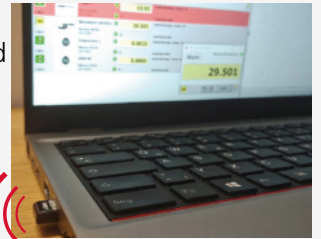

Ergonomic design

The handy non-slip thumb support of the MarCal 16 EWRi ensures, even in contaminated working conditions, trouble-free handling and therefore reliable measuring results.



Original size 11 mm



The high-contrast display with 11 mm sized digitals enables accurate, fatigue-free reading of the measurement results.

Excellent resistance against dust, coolant and lubricants



Due to the outstanding protection against dust and water, the MarCal 16 EWRi digital caliper with the Reference System delivers precise and secure results, even in the most difficult workshop conditions. The finished plastic components have an outstanding chemical resistance.

Code Initials	IP	International Protection
First digital	6	Dust-tight
Second digital	7	Protected against temporary immersion in water



FUNCTIONS

- ON/OFF
- AUTO-ON / OFF
- HOLD (storage of measured values)
- RESET (set display to zero)
- PRESET (for entering a numerical value)
- Reversal of counting direction
- mm/inch
- LOCK function (key lock)
- DATA (data transmission)



FEATURES

- High contrast digital display
- Locking screw above
- Lapped guideway
- Measuring blade for inside measurements
- Slide and beam made of hardened stainless steel
- Step measuring function
- Immediate measurements due to the Reference System
- Raised guideway for the protection of the scale
- Excellent resistance against dust, coolants and lubricants
- Dirt wipers are integrated in the slide
- Software: MarCom Professional free download: www.mahr.com/marcom (only for Mahr data cables and wireless systems with USB and RS-232 interface)
- **Digital height:** 11 mm
- **Data interface:** Integrated Wireless
- **Energy supply:** Battery life approx. 3 years (approx. 0.5 in wireless mode)
- **Battery type:** CR 2032 (3V Lithium)
- **IP protection category:** IP 67
- **Package contains:** battery, instruction manual, case

TECHNICAL DATA

Order no.	Type	Measuring range		Resolution	Error limit	Standard	Depth rod	Friction wheel
		mm	inch					
4103400	16 EWri	0 – 150	0 – 6"	0.01 / .0005"	0.03	DIN 862	round	
4103401	16 EWri	0 – 150	0 – 6"	0.01 / .0005"	0.03	DIN 862	round	•
4103402	16 EWri	0 – 150	0 – 6"	0.01 / .0005"	0.03	DIN 862	rectangular	
4103403	16 EWri	0 – 150	0 – 6"	0.01 / .0005"	0.03	DIN 862	rectangular	•
4103404	16 EWri	0 – 200	0 – 8"	0.01 / .0005"	0.03	DIN 862	rectangular	
4103405	16 EWri	0 – 200	0 – 8"	0.01 / .0005"	0.03	DIN 862	rectangular	•
4103406	16 EWri	0 – 300	0 – 12"	0.01 / .0005"	0.04	Factory standard		
4103407	16 EWri	0 – 300	0 – 12"	0.01 / .0005"	0.04	Factory standard		•

Order no.	a	b	c	d	e
	mm	mm	mm	mm	mm
4103400	10	40	16	235	16
4103401	10	40	16	235	16
4103402	10	40	16	235	16
4103403	10	40	16	235	16
4103404	10	50	19	285	16
4103405	10	50	19	285	16
4103406	14	64	19	388	16
4103407	14	64	19	388	16

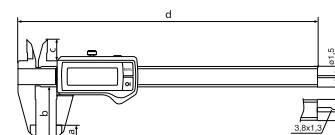

ACCESSORIES

Order no.	Description	Type
4102020	Depth bridge (75 x 7 mm)	16 Em
4102220	Receiver for instruments with Integrated Wireless	i-Stick

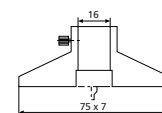

16 Em



i-Stick

MarCal 16 EWR

Digital caliper



FUNCTIONS

- ON/OFF
- AUTO-ON / OFF
- RESET (set display to zero)
- PRESET (for entering a numerical value)
- Reversal of counting direction
- mm/inch
- LOCK function (key lock)

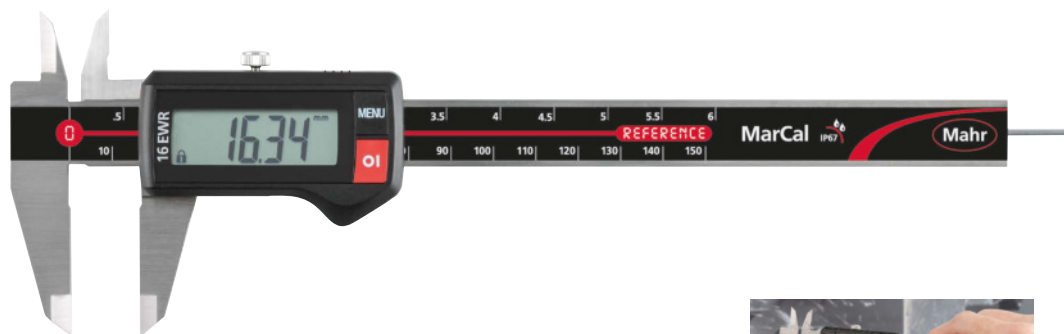

FEATURES

- High contrast digital display
- Locking screw above
- Lapped guideway
- Measuring blade for inside measurements
- Slide and beam made of hardened stainless steel
- Step measuring function
- Immediate measurements due to the Reference System
- Raised guideway for the protection of the scale
- Excellent resistance against dust, coolants and lubricants
- Dirt wipers are integrated in the slide
- **Digital height:** 11 mm
- **Data interface:** none
- **Energy supply:** Battery life approx. 3 years
- **Battery type:** CR 2032 (3V Lithium)
- **IP protection category:** IP 67
- **Package contains:** battery, instruction manual, case



TECHNICAL DATA

Order no.	Type	Measuring range	Measuring range	Resolution	Error limit	Standard	Depth rod	Friction wheel
		mm	inch	mm/inch	mm			
4103300	16 EWR	0–150	0–6"	0.01 / .0005"	0.03	DIN 862	round	
4103301	16 EWR	0–150	0–6"	0.01 / .0005"	0.03	DIN 862	round	•
4103302	16 EWR	0–150	0–6"	0.01 / .0005"	0.03	DIN 862	rectangular	
4103303	16 EWR	0–150	0–6"	0.01 / .0005"	0.03	DIN 862	rectangular	•
4103304	16 EWR	0–200	0–8"	0.01 / .0005"	0.03	DIN 862	rectangular	
4103305	16 EWR	0–200	0–8"	0.01 / .0005"	0.03	DIN 862	rectangular	•
4103306	16 EWR	0–300	0–12"	0.01 / .0005"	0.04	Factory standard		
4103307	16 EWR	0–300	0–12"	0.01 / .0005"	0.04	Factory standard		•

Order no.	a	b	c	d	e
	mm	mm	mm	mm	mm
4103300	10	40	16	235	16
4103301	10	40	16	235	16
4103302	10	40	16	235	16
4103303	10	40	16	235	16
4103304	10	50	19	285	16
4103305	10	50	19	285	16
4103306	14	64	19	388	16
4103307	14	64	19	388	16

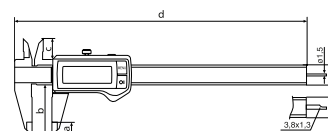

ACCESSORIES

Order no.	Description	Type
4102020	Depth bridge (75 x 7 mm)	16 Em

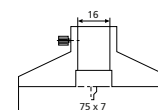

16 Em

MarCal 16 EWR

Digital caliper



FUNCTIONS

- ON/OFF
- AUTO-ON / OFF
- RESET (set display to zero)
- mm/inch
- LOCK function (key lock)
- DATA (data transmission via connection cable)

FEATURES

- High contrast digital display
- Locking screw above
- Lapped guideway
- Measuring blade for inside measurements
- Slide and beam made of hardened stainless steel
- Step measuring function
- Immediate measurements due to the Reference System
- Raised guideway for the protection of the scale
- Excellent resistance against dust, coolants and lubricants
- Dirt wipers are integrated in the slide
- **Software:** MarCom Professional free download: www.mahr.com/marcom (only for Mahr data cables and wireless systems with USB and RS-232 interface)
- **Digital height:** 8.5 mm
- **Data interface:** USB, Opto RS-232C, Digimatic
- **Energy supply:** Battery life approx. 3 years
- **Battery type:** CR 2032 (3V Lithium)
- **IP protection category:** IP 67
- **Package contains:** battery, instruction manual, case



TECHNICAL DATA

Order no.	Type	Measuring range		Resolution	Error limit	Standard	Depth rod	Friction wheel
		mm	inch					
4103064	16 EWR	0-150	0-6"	0.01 / .0005"	0.03	DIN 862	round	
4103065	16 EWR	0-150	0-6"	0.01 / .0005"	0.03	DIN 862	round	•
4103066	16 EWR	0-150	0-6"	0.01 / .0005"	0.03	DIN 862	rectangular	
4103067	16 EWR	0-150	0-6"	0.01 / .0005"	0.03	DIN 862	rectangular	•
4103068	16 EWR	0-200	0-8"	0.01 / .0005"	0.03	DIN 862	rectangular	
4103069	16 EWR	0-200	0-8"	0.01 / .0005"	0.03	DIN 862	rectangular	•
4103070	16 EWR	0-300	0-12"	0.01 / .0005"	0.04	Factory standard		
4103071	16 EWR	0-300	0-12"	0.01 / .0005"	0.04	Factory standard		•

Order no.	a	b	c	d	e
	mm	mm	mm	mm	mm
4103064	10	40	16	235	16
4103065	10	40	16	235	16
4103066	10	40	16	235	16
4103067	10	40	16	235	16
4103068	10	50	19	285	16
4103069	10	50	19	285	16
4103070	14	64	19	388	16
4103071	14	64	19	388	16

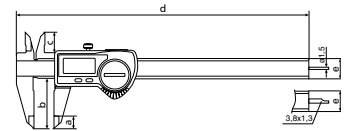

ACCESSORIES

Order no.	Description	Type
4102020	Depth bridge (75 x 7 mm)	16 Em
4102357	16 EXu data connection cable USB (2 m)	16 EXu
4102410	Data connection cable RS232C (2 m)	16 EXr
4102915	Interface adapter with data cable Digimatic (2 m)	16 EWd

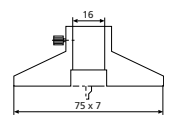

16 Em

MarCal 16 ER

Digital caliper



FUNCTIONS

- ON/OFF
- AUTO-ON / OFF
- RESET (set display to zero)
- mm/inch
- LOCK function (key lock)

FEATURES

- High contrast digital display
- Locking screw above
- Lapped guideway
- Measuring blade for inside measurements
- Slide and beam made of hardened stainless steel
- Step measuring function
- Immediate measurements due to the Reference System
- Raised guideway for the protection of the scale
- Dirt wipers are integrated in the slide
- **Digital height:** 11 mm
- **Data interface:** none
- **Energy supply:** Battery life approx. 3 years
- **Battery type:** CR 2032 (3V Lithium)
- **IP protection category:** None
- **Package contains:** instruction manual, battery, case

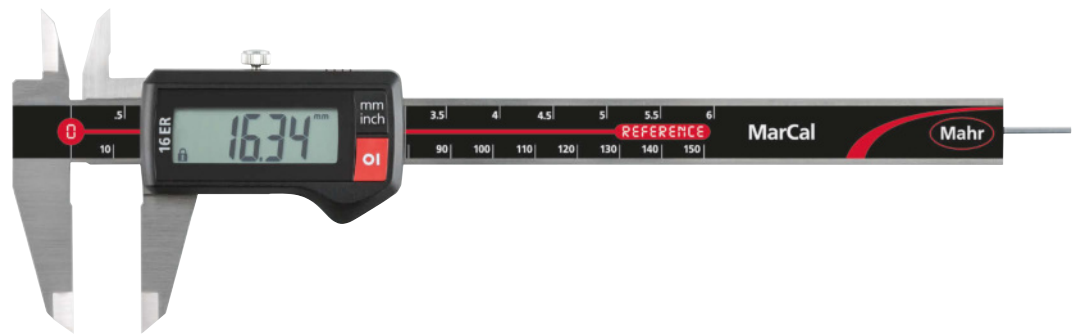

TECHNICAL DATA

Order no.	Type	Measuring range		Resolution	Error limit	Standard	Depth rod	Friction wheel
		mm	inch					
4103010	16 ER	0-150	0-6"	0.01 / .0005"	0.03	DIN 862	round	
4103011	16 ER	0-150	0-6"	0.01 / .0005"	0.03	DIN 862	round	•
4103012	16 ER	0-150	0-6"	0.01 / .0005"	0.03	DIN 862	rectangular	
4103013	16 ER	0-150	0-6"	0.01 / .0005"	0.03	DIN 862	rectangular	•
4103205	16 ER	0-200	0-8"	0.01 / .0005"	0.03	DIN 862	rectangular	
4103206	16 ER	0-200	0-8"	0.01 / .0005"	0.03	DIN 862	rectangular	•
4103207	16 ER	0-300	0-12"	0.01 / .0005"	0.04	Factory standard		
4103208	16 ER	0-300	0-12"	0.01 / .0005"	0.04	Factory standard		•

Order no.	a	b	c	d	e
	mm	mm	mm	mm	mm
4103010	10	40	16	235	16
4103011	10	40	16	235	16
4103012	10	40	16	235	16
4103013	10	40	16	235	16
4103205	10	50	19	285	16
4103206	10	50	19	285	16
4103207	14	64	19	388	16
4103208	14	64	19	388	16

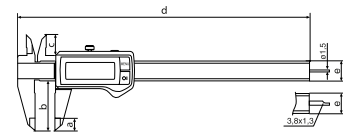

ACCESSORIES

Order no.	Description	Type
4102020	Depth bridge (75 x 7 mm)	16 Em

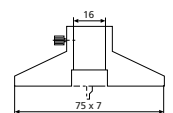

16 Em

MarCal 16 ER

Digital caliper



FUNCTIONS

- ON/OFF
- AUTO-ON / OFF
- RESET (set display to zero)
- mm/inch
- LOCK function (key lock)
- DATA (data transmission via connection cable)

FEATURES

- High contrast digital display
- Locking screw above
- Lapped guideway
- Measuring blade for inside measurements
- Slide and beam made of hardened stainless steel
- Step measuring function
- Immediate measurements due to the Reference System
- Raised guideway for the protection of the scale
- Dirt wipers are integrated in the slide
- **Software:** MarCom Professional free download: www.mahr.com/marcom (only for Mahr data cables and wireless systems with USB and RS-232 interface)
- **Digital height:** 8.5 mm
- **Data interface:** USB, Opto RS-232C, Digimatic
- **Energy supply:** Battery life approx. 3 years
- **Battery type:** CR 2032 (3V Lithium)
- **IP protection category:** None
- **Package contains:** instruction manual, battery, case

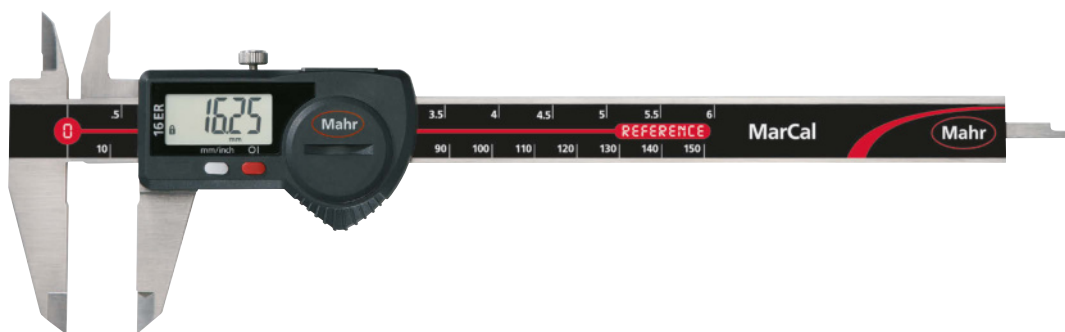

TECHNICAL DATA

Order no.	Type	Measuring range	Measuring range	Resolution	Error limit	Standard	Depth rod	Friction wheel
		mm	inch	mm/inch	mm			
4103014	16 ER	0–150	0–6"	0.01 / .0005"	0.03	DIN 862	round	
4103015	16 ER	0–150	0–6"	0.01 / .0005"	0.03	DIN 862	round	•
4103016	16 ER	0–150	0–6"	0.01 / .0005"	0.03	DIN 862	rectangular	
4103017	16 ER	0–150	0–6"	0.01 / .0005"	0.03	DIN 862	rectangular	•
4103018	16 ER	0–200	0–8"	0.01 / .0005"	0.03	DIN 862	rectangular	•
4103019	16 ER	0–200	0–8"	0.01 / .0005"	0.03	DIN 862	rectangular	•
4103020	16 ER	0–300	0–12"	0.01 / .0005"	0.04	Factory standard		
4103021	16 ER	0–300	0–12"	0.01 / .0005"	0.04	Factory standard		•

Order no.	a	b	c	d	e
	mm	mm	mm	mm	mm
4103014	10	40	16	235	16
4103015	10	40	16	235	16
4103016	10	40	16	235	16
4103017	10	40	16	235	16
4103018	10	50	19	285	16
4103019	10	50	19	285	16
4103020	14	64	19	388	16
4103021	14	64	19	388	16

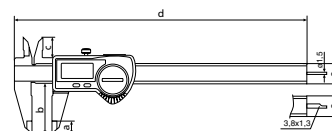

ACCESSORIES

Order no.	Description	Type
4102020	Depth bridge (75 x 7 mm)	16 Em
4102357	16 EXu Data connection cable USB (2 m)	16 EXu
4102410	Data connection cable RS232C (2 m)	16 EXr
4102915	Interface Adapter with data cable digimatic (2 m)	16 EWd

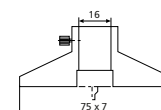

16 Em

MarCal 16 U

Dial caliper



SHOCK
PROOF

DIN
862

FEATURES

- Large, high contrast dial face
- Shockproof movement
- Zero setting through rotating the dial face and locking screw
- Satin chrome finished line scale
- Locking screw above
- Measuring surfaces made of steel
- Measuring blade for inside measurements
- Slide and beam made of hardened stainless steel
- Step measuring function
- Raised guideway for the protection of the scale
- Package contains: case



TECHNICAL DATA

Order no.	Type	Measuring range	Readings	Range per turn	Error limit	Standard	Depth rod	Friction wheel
		mm		mm	mm			
4107005	16 U	0–150	0.01	1	0.03	DIN 862	rectangular	•
4107107	16 U	0–150	0.02	2	0.03	DIN 862	rectangular	•

Order no.	a	b	c	d	e
	mm	mm	mm	mm	mm
4107005	10	40	16.5	234	16
4107107	10	40	16.5	234	16

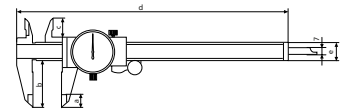

ACCESSORIES

Order no.	Description	Type
4100302	Synthetic leather pouch, black for pocket slide caliper 150 mm	
4102020	Depth bridge (75 x 7 mm)	16 Em

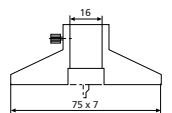

16 Em



FEATURES

- Vernier and scale have a satin chrome finish for glare free reading
- Locking screw above
- Measuring surfaces made of steel
- Measuring blade for inside measurements
- Slide and beam made of hardened stainless steel
- Step measuring function
- Raised guideway for the protection of the scale
- **Package contains:** thread table, case

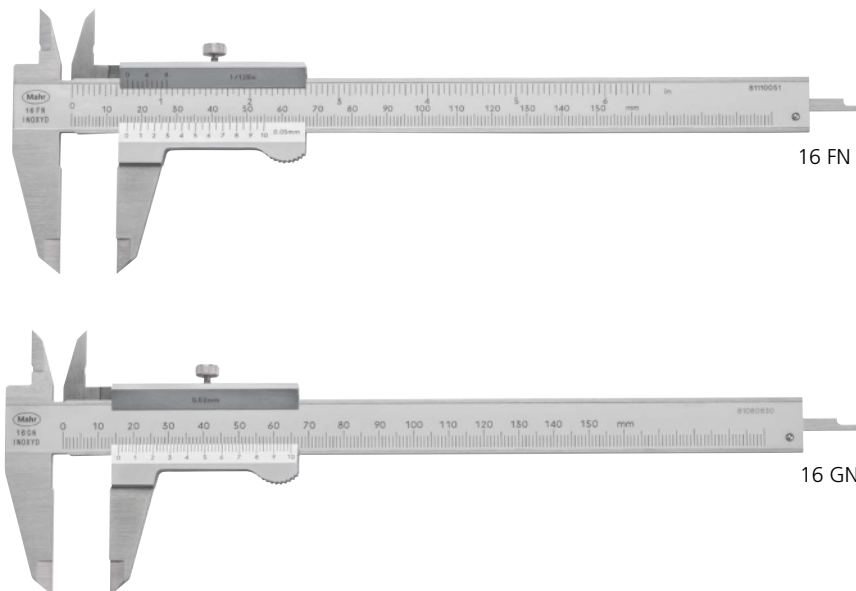

TECHNICAL DATA

Order no.	Type	Measuring range		Vernier value		Error limit		Standard	Depth rod
		mm	inch	mm	inch	mm	inch		
4100400	16 FN	0 – 150	0 – 6"	0.05	1/128"	0.05	0.002	DIN 862	rectangular
4100401	16 FN	0 – 200	0 – 8"	0.05	1/128"	0.05	0.002	DIN 862	rectangular
4100402	16 FN	0 – 300	0 – 12"	0.05	1/128"	0.05	0.002	DIN 862	rectangular
4100420	16 FN	0 – 150		0.05		0.05		DIN 862	rectangular
4100421	16 FN	0 – 200		0.05		0.05		DIN 862	rectangular
4100422	16 FN	0 – 300		0.05		0.05		DIN 862	rectangular
4100650	16 GN	0 – 150		0.02		0.05		Factory standard	rectangular
4100651	16 GN	0 – 200		0.02		0.05		Factory standard	rectangular
4100652	16 GN	0 – 300		0.02		0.05		Factory standard	rectangular

Order no.	a	b	c	d	e	f
	mm	mm	mm	mm	mm	mm
4100400	10	40	16	228	16	3.8
4100401	14	50	19	290	17	3.8
4100402	16	64	23	404	20	4.8
4100420	10	40	16	228	16	3.8
4100421	14	50	19	290	17	3.8
4100422	16	64	23	404	20	4.8
4100650	10	40	16	228	16	3.8
4100651	14	50	19	290	17	3.8
4100652	16	64	23	404	20	4.8

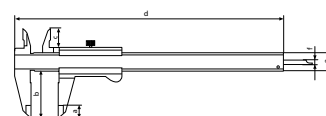

ACCESSORIES

Order no.	Description	Type
4100302	Synthetic leather pouch, black for pocket slide caliper 150 mm	
4102020	Depth bridge (75 x 7 mm)	16 Em

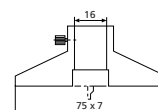

16 Em

MarCal 16 DN

Caliper with analog display



FEATURES

- Vernier and scale have a satin chrome finish for glare free reading
- Thumb clamp
- Measuring surfaces made of steel
- Measuring blade for inside measurements
- Slide and beam made of hardened stainless steel
- Step measuring function
- Raised guideway for the protection of the scale
- **Package contains:** thread table, case

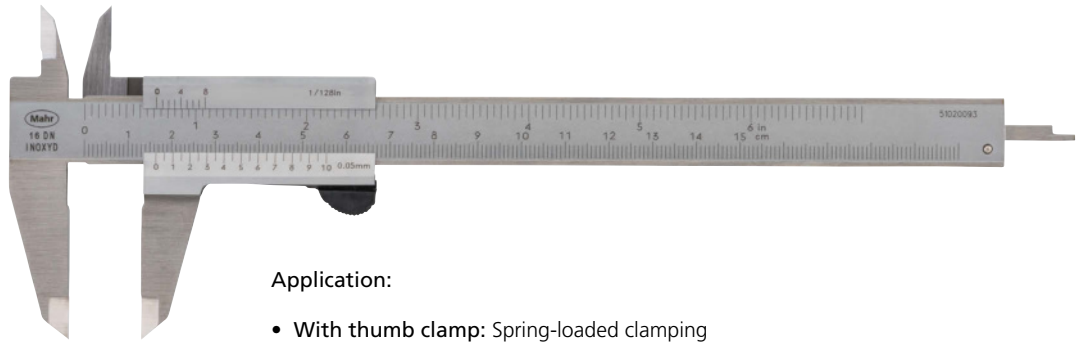

Application:

- **With thumb clamp:** Spring-loaded clamping lever causes self-locking of the slide when the thumb contact is released

TECHNICAL DATA

Order no.	Type	Measuring range	Measuring range	Vernier value	Vernier value	Error limit	Error limit	Standard	Depth rod
		mm	inch	mm	inch	mm	inch		
4100600	16 DN	0–150	0–6"	0.05	1/128"	0.05	0.002	DIN 862	rectangular

Order no.	a	b	c	d	e	f
	mm	mm	mm	mm	mm	mm
4100600	10	40	16	228	16	3.8

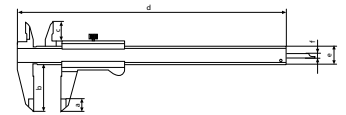

ACCESSORIES

Order no.	Description	Type
4100302	Synthetic leather pouch, black for pocket slide caliper 150 mm	
4102020	Depth bridge (75 x 7 mm)	16 Em

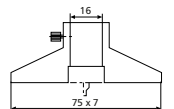

16 Em

FUNCTIONS

- ON/OFF
- AUTO-ON / OFF
- HOLD (storage of measured values)
- RESET (set display to zero)
- PRESET (for entering a numerical value)
- Reversal of counting direction
- mm/inch
- LOCK function (key lock)
- DATA (data transmission)

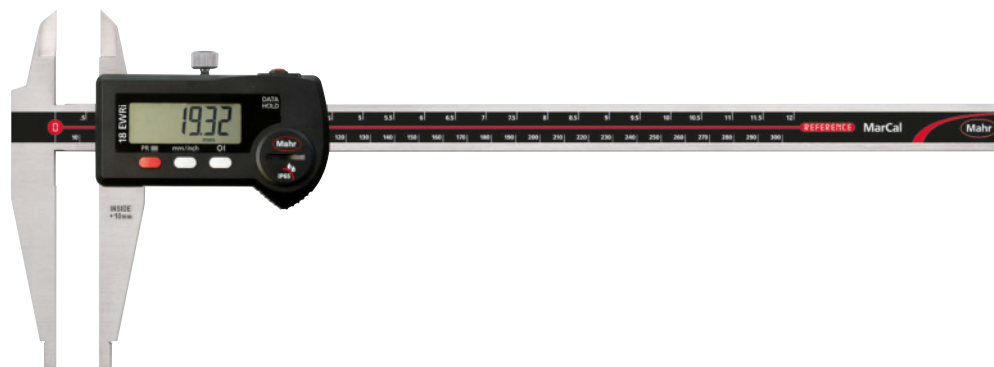

FEATURES

- High contrast digital display
- Locking screw above
- Rounded measuring blades for inside measurements
- Slide and beam made of hardened stainless steel
- Immediate measurements due to the Reference System
- Raised guideway for the protection of the scale
- Excellent resistance against dust, coolants and lubricants
- Dirt wipers are integrated in the slide
- **Software:** MarCom Professional free download: www.mahr.com/marcom (only for Mahr data cables and wireless systems with USB and RS-232 interface)
- **Digital height:** 12,5 mm
- **Data interface:** Integrated Wireless
- **Energy supply:** Battery life approx. 3 years (approx. 0.5 in wireless mode)
- **Battery type:** CR 2032 (3V Lithium)
- **IP protection category:** IP 65
- **Package contains:** battery, instruction manual, case

TECHNICAL DATA

Order no.	Type	Measuring range	Measuring range	Resolution	Measuring blades for outside measurements	Error limit	Standard
		mm	inch	mm/inch		mm	
4112571	18 EWri	0 – 300	0 – 12"	0.01 / .0005"	•	0.03	Factory standard
4112572	18 EWri	0 – 500	0 – 20"	0.01 / .0005"	•	0.04	Factory standard
4112573	18 EWri	0 – 750	0 – 30"	0.01 / .0005"	•	0.05	Factory standard
4112574	18 EWri	0 – 1000	0 – 40"	0.01 / .0005"	•	0.06	Factory standard

Order no.	a	b	c	d	e	f
	mm	mm	mm	mm	mm	mm
4112571	430	90	10	10	20	40
4112572	650	150	20	20	25	55
4112573	905	150	20	20	25	55
4112574	1165	150	20	20	30	60

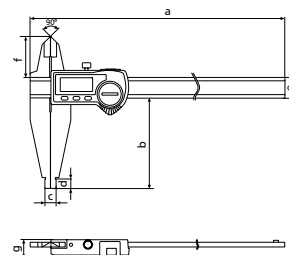

ACCESSORIES

Order no.	Description	Type
4102220	Receiver for instruments with Integrated Wireless	i-Stick



i-Stick

MarCal 18 EWR

Digital workshop caliper



FUNCTIONS

- AUTO-ON / OFF
- DATA (data transmission via connection cable)
- ON/OFF
- PRESET (for entering a numerical value)
- RESET (set display to zero)
- mm/inch
- LOCK function (key lock)
- High contrast digital display
- Locking screw above
- Rounded measuring blades for inside measurements
- Slide and beam made of hardened stainless steel
- Immediate measurements due to the Reference System
- Raised guideway for the protection of the scale
- Excellent resistance against dust, coolants and lubricants
- Dirt wipers are integrated in the slide



FEATURES

- **Software:** MarCom Professional free download: www.mahr.com/marcom (only for Mahr data cables and wireless systems with USB and RS-232 interface)
- **Digital height:** 10 mm
- **Data interface:** USB, Opto RS-232C, Digimatic
- **Energy supply:** Battery life approx. 3 years
- **Battery type:** CR 2032 (3V Lithium)
- **IP protection category:** IP 65
- **Package contains:** battery, instruction manual, case

TECHNICAL DATA

Order no.	Type	Measuring range	Measuring range	Resolution	Measuring blades for outside measurements	Error limit	Standard	Weight
		mm	inch	mm/inch		mm		kg
4112704	18 EWR	0–300	0–12"	0.01 / .0005"	•	0.03	Factory standard	0.45
4112712	18 EWR	0–500	0–20"	0.01 / .0005"	•	0.04	Factory standard	1.10
4112714	18 EWR	0–750	0–30"	0.01 / .0005"	•	0.05	Factory standard	1.35
4112716	18 EWR	0–1000	0–40"	0.01 / .0005"	•	0.06	Factory standard	2.20
4112705	18 EWR	0–300	0–12"	0.01 / .0005"		0.03	Factory standard	0.44
4112713	18 EWR	0–500	0–20"	0.01 / .0005"		0.04	Factory standard	1.00
4112715	18 EWR	0–750	0–30"	0.01 / .0005"		0.05	Factory standard	1.28
4112717	18 EWR	0–1000	0–40"	0.01 / .0005"		0.06	Factory standard	2.10

Order no.	a	b	c	d	e	f
	mm	mm	mm	mm	mm	mm
4112704	410	90	10	10	20	40
4112712	650	150	20	20	25	55
4112714	905	150	20	20	25	55
4112716	1165	150	20	20	30	60
4112705	410	90	10	10	20	
4112713	650	150	20	20	25	
4112715	905	150	20	20	25	
4112717	1165	150	20	20	30	

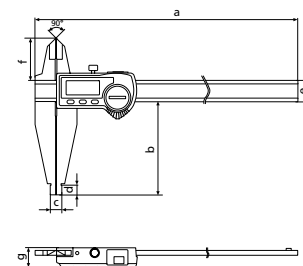

ACCESSORIES

Order no.	Description	Type
4102230	e-Stick receiver	e-Stick
4102231	16 EWe Transmitter for e-Stick	16 EWe
4102357	16 EXu Data connection cable USB (2 m)	16 EXu
4102410	Data connection cable RS232C (2 m)	16 EXr
4102915	Interface adapter with data cable digimatic (2 m)	16 EWd



16 EWe



e-Stick

FUNCTIONS

- ON/OFF
- RESET (set display to zero)
- mm/inch
- HOLD (storage of measured values)
- PRESET (for entering a numerical value)

FEATURES

- To reduce the overall weight the slide and beam are made from aluminum and are coated with a hard anodized surface coating (1100 HV)
- High contrast digital display
- Locking screw above
- Rounded measuring blades for inside measurements
- Prism guideway for a more smooth and even movement
- Measuring surfaces made of steel
- Measuring blades for outside measurements
- Dirt wipers are integrated in the slide
- **Software:** MarCom Professional free download: www.mahr.com/marcom (only for Mahr data cables and wireless systems with USB and RS-232 interface)
- **Digital height:** 12 mm
- **Data interface:** none
- **Energy supply:** Battery life approx. 2 years
- **Battery type:** CR 2032 (3V Lithium)
- **IP protection category:** None
- **Package contains:** battery, instruction manual, case



TECHNICAL DATA

Order no.	Type	Measuring range	Measuring range	Resolution	Measuring blades for outside measurements	Error limit	Standard	Weight
		mm	inch	mm/inch		mm		kg
4112621	18 ESA	0–500	0–20"	0.01 / .0005"	•	0.05	Factory standard	1.40
4112622	18 ESA	0–800	0–32"	0.01 / .0005"	•	0.07	Factory standard	1.60
4112623	18 ESA	0–1000	0–40"	0.01 / .0005"	•	0.08	Factory standard	1.80

Order no.	a	b	c	d	e	f	g	h	i
	mm	mm	mm	mm	mm	mm	mm	mm	mm
4112621	726	42	150	20.7	15	20	31.9	6	29
4112622	1026	42	150	20.7	15	20	31.9	6	29
4112623	1225	42	150	20.7	15	20	31.9	6	29

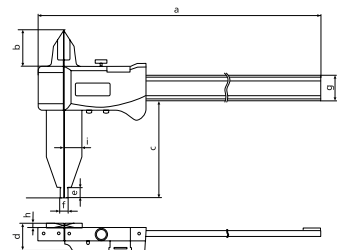

MarCal 18 NA

Workshop calipers

FEATURES

- To reduce the overall weight the slide and beam are made from aluminum and are coated with a hard anodized surface coating (1100 HV)
- Vernier and scale have a satin chrome finish for glare free reading
- Parallax-free reading
- Locking screw above
- Prism guideway for a more smooth and even movement
- Measuring surfaces made of steel
- Measuring blades for outside measurements
- Package contains: case



TECHNICAL DATA

Order no.	Type	Measuring range	Vernier value	Measuring blades for outside measurements	Error limit	Standard	Weight
		mm	mm		mm		kg
4112301	18 NA	0–500	0.02	•	0.05	Factory standard	1.40
4112302	18 NA	0–800	0.02	•	0.07	Factory standard	1.60
4112303	18 NA	0–1000	0.02	•	0.08	Factory standard	1.75

Order no.	a	b	c	d	e	f	g	h	i
	mm	mm	mm	mm	mm	mm	mm	mm	mm
4112301	726	42	150	20.7	15	20	31.9	6	29
4112302	1026	42	150	20.7	15	20	31.9	6	29
4112303	1226	42	150	20.7	15	20	31.9	6	29

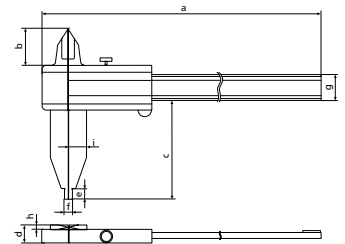

MarCal 16 EWRI-V

Digital universal caliper



FUNCTIONS

- AUTO-ON / OFF
- ON/OFF
- DATA (data transmission via connection cable)
- HOLD (storage of measured values)
- PRESET (for entering a numerical value)
- RESET (set display to zero)
- mm/inch
- LOCK function (key lock)

FEATURES

- High contrast digital display
- Locking screw above
- Lapped guideway
- Measuring blade for inside measurements
- Slide and beam made of hardened stainless steel
- Step measuring function
- Immediate measurements due to the Reference System
- Raised guideway for the protection of the scale
- Excellent resistance against dust, coolants and lubricants
- Dirt wipers are integrated in the slide
- **Software:** MarCom Professional free download: www.mahr.com/marcom (only for Mahr data cables and wireless systems with USB and RS-232 interface)
- **Digital height:** 11 mm
- **Data interface:** Integrated Wireless
- **Energy supply:** Battery life approx. 3 years (approx. 0.5 in wireless mode)
- **Battery type:** CR 2032 (3V Lithium)
- **IP protection category:** IP 67
- **Package contains:** battery, instruction manual, case, setting gage for inside measurement 16 Eel, measuring force device 16 Ec, depth measuring bridge 16 Em, anvils for outside measurement 16 Eea 1–3, anvils for inside measurement 16Eei 1–3

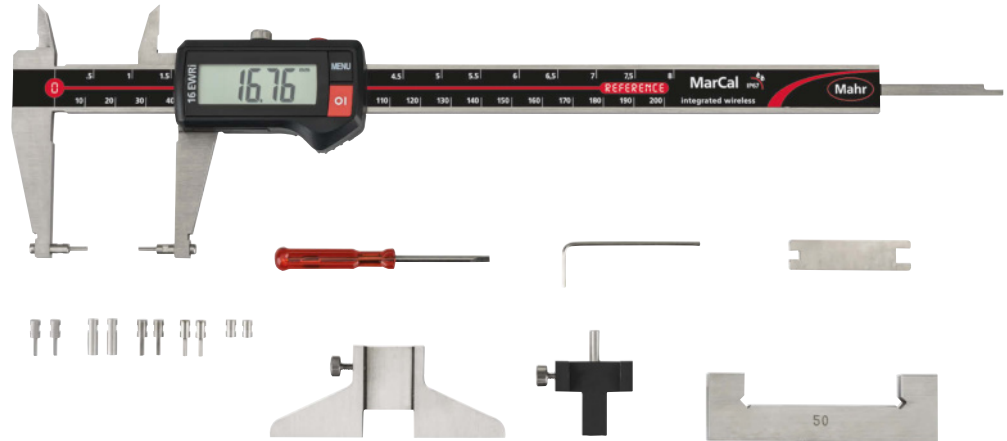

Applications:

- Can be used as standard calipers (four measuring directions) with standard accessories for measuring recesses, grooves, etc.
- Can be used with special accessories for measuring threads, bores and gears



TECHNICAL DATA

Order no.	Type	Measuring range	Measuring range	Resolution	Error limit	Standard	Depth rod	Accessories
		mm	inch	mm/inch	mm			
4118907	16 EWRI-V	0 – 200	0 – 8"	0.01 / .0005"	0.03	DIN 862	rectangular	•

Order no.	b	c	d	e
	mm	mm	mm	mm
4118907	48	16.5	285	16

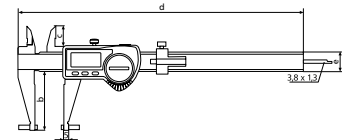

ACCESSORIES

Order no.	Description	Quantity	unit	Type
4102020	Depth bridge (75 x 7 mm)			16 Em
4118810	Anvil for outside measurement (3.5 x 12 mm)	Piece		16 Eea 1
4118811	Anvil for outside measurement (1.5 x 6 mm)	Piece		16 Eea 2
4118812	Anvil for outside measurement (3.5 x 6 mm)	Piece		16 Eea 3
4118813	Anvil for inside measurement (3.5 x 6 mm)	Piece		16 Eei 1
4118814	Anvil for inside measurement (1.5 x 6 mm)	Piece		16 Eei 2
4118815	Anvil for inside measurement (3.5 x 6 mm)	Piece		16 Eei 3
4118816	Anvil for inside measurement (4 x 2.5 mm)	Piece		16 Eei 4
4118817	Setting gage for inside measurement (50 mm)			16 Eel
4118818	Measuring force device			16 Ec
4879602	Screws M2x8	Piece		
4118819	Mounting attachment for thread anvils 844 TG/844 Tr and ball anvils 844 Tk			16 Eab
4102220	Receiver for instruments with Integrated Wireless			i-Stick

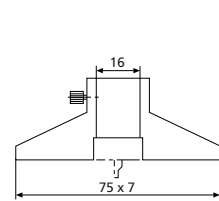

16 Em

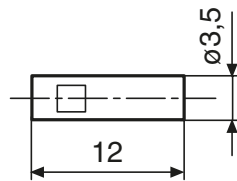

16 Eea 1

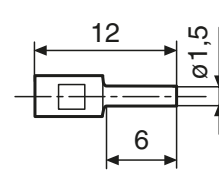

16 Eea 2

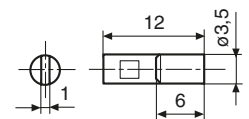

16 Eea 3

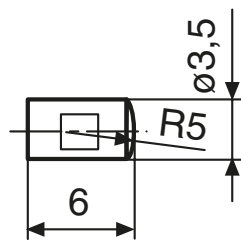

16 Eei 1

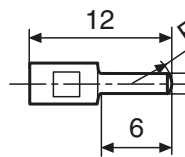

16 Eei 2

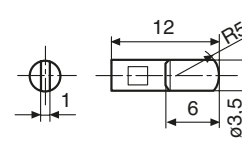

16 Eei 3

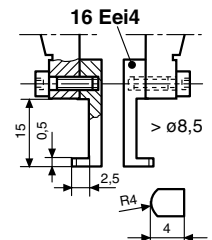

16 Eei 4

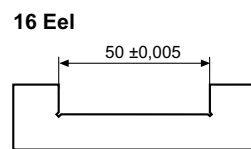

16 Eei

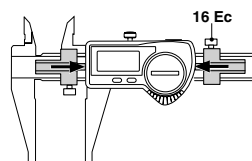

16 Ec

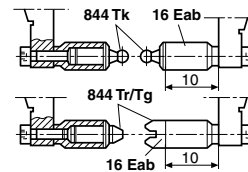

16 Eab



i-Stick

MarCal 16 EWR-V

Digital universal caliper



FUNCTIONS

- AUTO-ON / OFF
- DATA (data transmission via connection cable)
- ON/OFF
- PRESET (for entering a numerical value)
- RESET (set display to zero)
- mm/inch
- LOCK function (key lock)

FEATURES

- High contrast digital display
- Locking screw above
- Lapped guideway
- Measuring blade for inside measurements
- Slide and beam made of hardened stainless steel
- Step measuring function
- Immediate measurements due to the Reference System
- Raised guideway for the protection of the scale
- Excellent resistance against dust, coolants and lubricants
- Dirt wipers are integrated in the slide
- **Software:** MarCom Professional free download: www.mahr.com/marcom (only for Mahr data cables and wireless systems with USB and RS-232 interface)
- **Digital height:** 8.5 mm
- **Data interface:** USB, Opto RS-232C, Digimatic
- **Energy supply:** Battery life approx. 3 years
- **Battery type:** CR 2032 (3V Lithium)
- **IP protection category:** IP 67
- **Package contains:** battery, instruction manual, case, setting gage for inside measurement 16 Eel, measuring force device 16 Ec, depth measuring bridge 16 Em, anvils for outside measurement 16 Eea 1-3, anvils for inside measurement 16Eei 1-3, 4118808 without measuring anvils, adjustment bridge and measuring force equipment

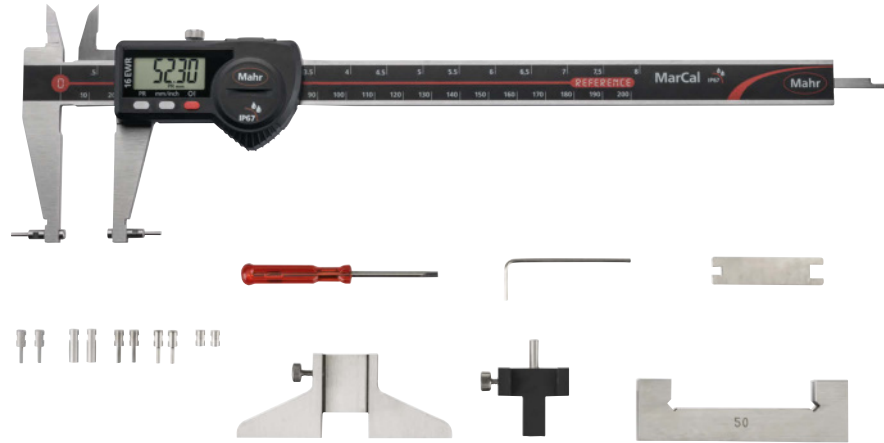

Applications:

- Can be used as a standard caliper (four types of measurements) with standard accessories to measure recesses, grooves, etc.
- Can be used with additional accessories to measure threads, bores and serration

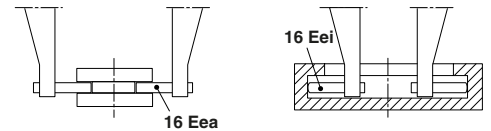

TECHNICAL DATA

Order no.	Type	Measuring range	Measuring range	Resolution	Error limit	Standard	Depth rod	Accessories
		mm	inch	mm/inch	mm			
4118807	16 EWR-V	0-200	0-8"	0.01 / .0005"	0.03	DIN 862	rectangular	•

Order no.	b	c	d	e
	mm	mm	mm	mm
4118807	48	16.5	285	16

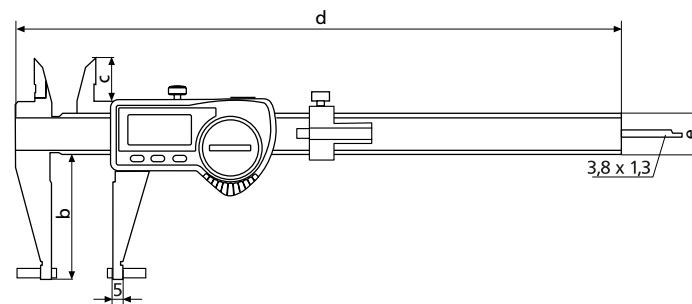

ACCESSORIES

Order no.	Description	Quantity	unit	Type
4118810	Anvil for outside measurement (3.5 x 12 mm)	Piece		16 Eea 1
4118811	Anvil for outside measurement (1.5 x 6 mm)	Piece		16 Eea 2
4118812	Anvil for outside measurement (3.5 x 6 mm)	Piece		16 Eea 3
4118813	Anvil for inside measurement (3.5 x 6 mm)	Piece		16 Eei 1
4118814	Anvil for inside measurement (1.5 x 6 mm)	Piece		16 Eei 2
4118815	Anvil for inside measurement (3.5 x 6 mm)	Piece		16 Eei 3
4118816	Anvil for inside measurement (4 x 2.5 mm)	Piece		16 Eei 4
4118817	Setting gage for inside measurement (50 mm)			16 Eel
4118818	Measuring force device			16 Ec
4879602	Screws M2x8	Piece		
4118819	Mounting attachment for thread anvils 844 TG/844 Tr and ball anvils 844 Tk			16 Eab
4102020	Depth bridge (75 x 7 mm)			16 Em
4102357	16 EXu Data connection cable USB (2 m)			16 EXu
4102915	Interface adapter with data cable Digimatic			16 EWd
4102410	Data connection cable RS232C (2 m)			16 EXr

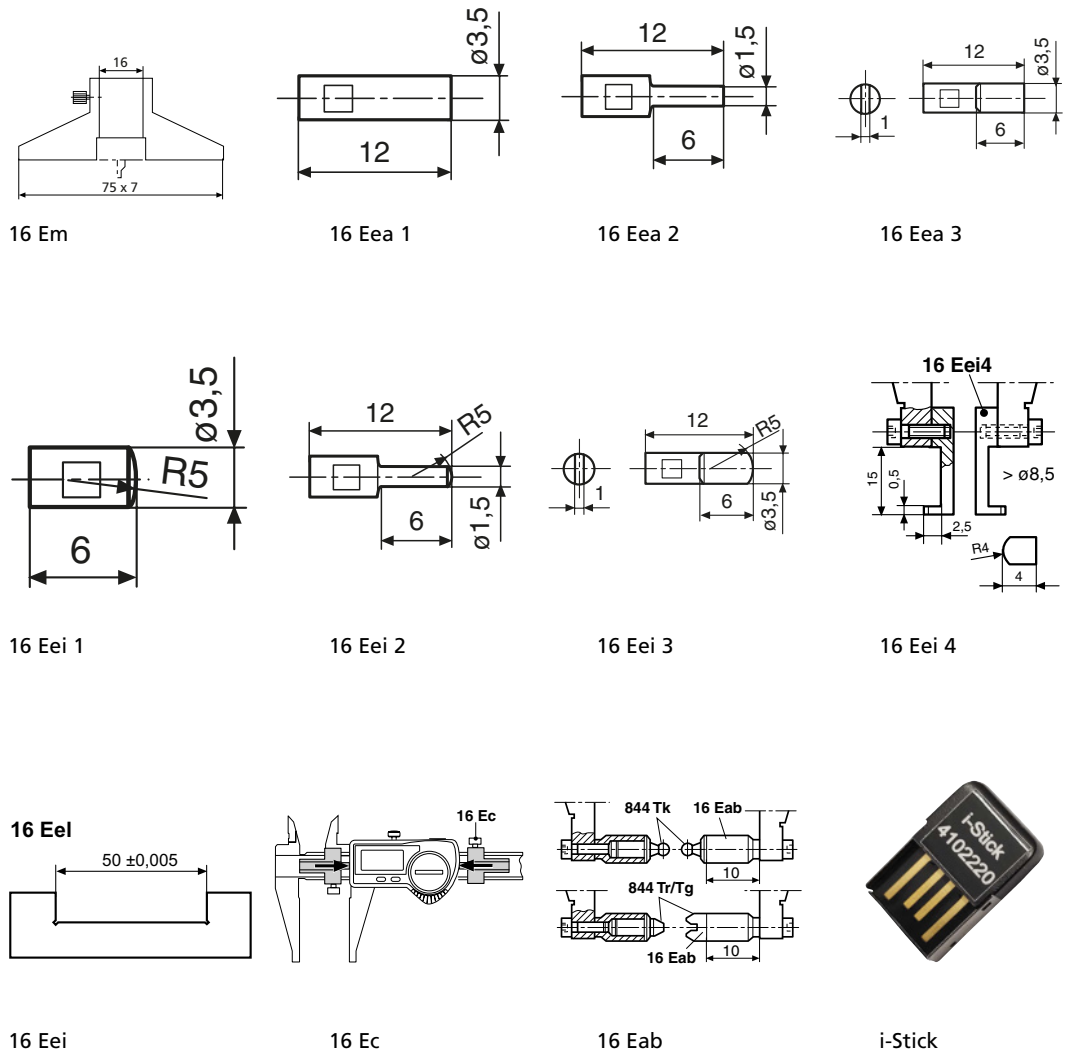

MarCal 18 EWR-V

Digital universal caliper



FUNCTIONS

- ON/OFF
- AUTO-ON / OFF
- RESET (set display to zero)
- PRESET (for entering a numerical value)
- mm/inch
- LOCK function (key lock)
- DATA (data transmission via connection cable)

FEATURES

- High contrast digital display
- Locking screw above
- Immediate measurements due to the Reference System
- Excellent resistance against dust, coolants and lubricants
- Dirt wipers are integrated in the slide
- Slide and beam made of hardened stainless steel
- Measuring faces for outside measurement
- Thread M2.5 measuring jaws to accommodate measuring anvils for internal and external measurements
- **Software:** MarCom Professional free download: www.mahr.com/marcom (only for Mahr data cables and wireless systems with USB and RS-232 interface)
- **Digital height:** 10 mm
- **Data interface:** USB, Opto RS-232C, Digimatic
- **Energy supply:** Battery life approx. 3 years
- **Battery type:** CR 2032 (3V Lithium)
- **IP protection category:** IP 65
- **Package contains:** battery, case, instruction manual, anvils

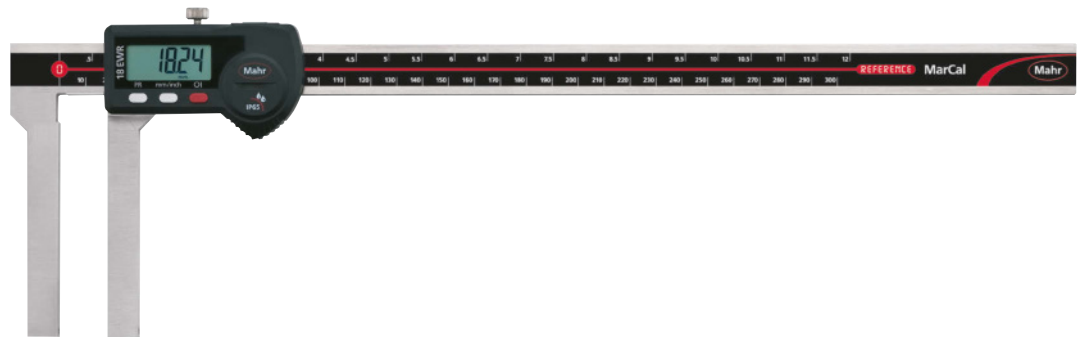

Applications:

- For inner and outer measurements of recesses, grooves, etc.
- Individual adjustment by means of measuring anvils with M2.5 thread



TECHNICAL DATA

Order no.	Type	Measuring range mm	Measuring range inch	Resolution mm/inch	Error limit mm	Standard
4112722	18 EWR-V	0 – 300	0 – 12"	0.01 / .0005"	0.06	Factory standard
4112723	18 EWR-V	0 – 500	0 – 20"	0.01 / .0005"	0.08	Factory standard

Order no.	a	b	c	d	e
	mm	mm	mm	mm	mm
4112722	410	90	12	75.5	20
4112723	680	100	16	81	25

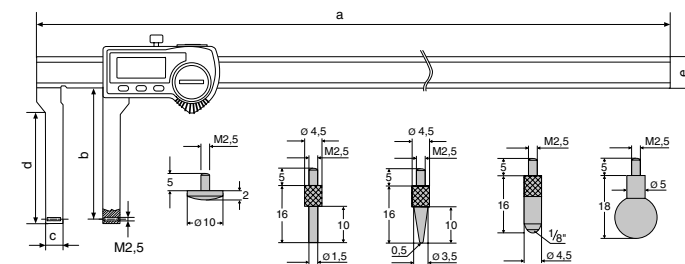

ACCESSORIES

Order no.	Description	Quantity unit	Type
4102230	e-Stick Receiver		e-Stick
4102231	16 EWe transmitter for e-Stick		16 EWe
4102357	16 EXu data connection cable USB (2 m)		16 EXu
4102410	Data connection cable RS232C (2 m)		16 EXr
4102915	Interface Adapter with data cable digimatic (2 m)		16 EWd
4112050	Replacement measuring anvil: Spherical plate \varnothing 10.0 mm	Piece	
4112051	Replacement measuring anvil: Cylindrical stylus \varnothing 1.5 mm x 10 mm	Piece	
4112052	Replacement measuring anvil: Tip, radius 0.5 mm x 10 mm	Piece	
4112053	Replacement measuring anvil: Sphere \varnothing 1/8" length 16 mm	Piece	
4112054	Replacement measuring anvil: Ball \varnothing 7.0 mm	Piece	
4112055	Replacement measuring anvil: Sphere \varnothing 10.0 mm	Piece	

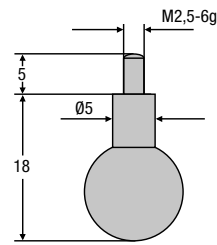
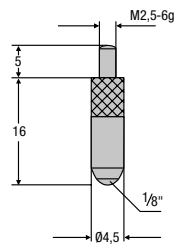
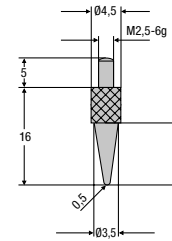
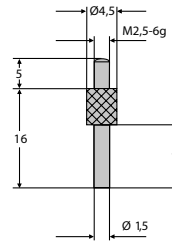
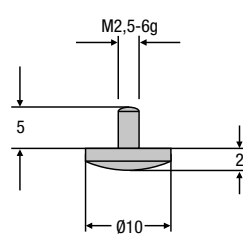

16 EWe



e-Stick

MarCal 16 EWri-C / 16 EWR-C

Digital special calipers

FUNCTIONS

16 EWri-C:

- ON/OFF
- AUTO-ON / OFF
- mm/inch
- LOCK function (key lock)
- RESET (set display to zero)
- PRESET (for entering a numerical value)
- DATA (data transmission)
- HOLD (storage of measured values)

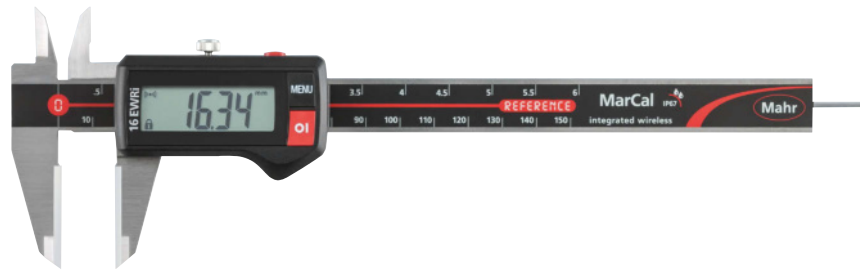

16 EWri-C

16 EWR-C:

- ON/OFF
- AUTO-ON / OFF
- mm/inch
- LOCK function (key lock)
- RESET (set display to zero)
- DATA (data transmission via connection cable)
- High contrast digital display
- Locking screw above
- Lapped guideway
- Measuring blade for inside measurements
- Slide and beam made of hardened stainless steel
- Step measuring function
- Immediate measurements due to the Reference System
- Raised guideway for the protection of the scale
- Excellent resistance against dust, coolants and lubricants
- Dirt wipers are integrated in the slide

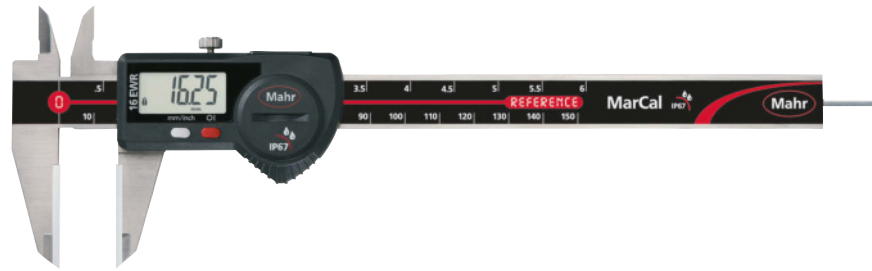

16 EWR-C

Application:

- Outer measuring surfaces made of ceramic, for measuring hard materials

TECHNICAL DATA

Order no.	Type	Measuring range	Measuring range	Resolution	Error limit	Standard	Depth rod
		mm	inch	mm/inch	mm		
4103372	16 EWri-C	0 - 150	0 - 6"	0.01 / .0005"	0.03	DIN 862	round
4103072	16 EWR-C	0 - 150	0 - 6"	0.01 / .0005"	0.03	DIN 862	round

Order no.	a	b	c	d	e
	mm	mm	mm	mm	mm
4103372	10	40	16	235	16
4103072	10	40	16	235	16

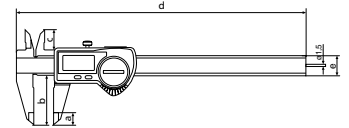

FEATURES 16 EWri-C:

- **Software:** MarCom Professional free download: www.mahr.com/marcom (only for Mahr data cables and wireless systems with USB and RS-232 interface)
- **Digital height:** 11 mm
- **Data interface:** Integrated Wireless
- **Energy supply:** Battery life approx. 3 years (approx. 0.5 in wireless mode)
- **Battery type:** CR 2032 (3V Lithium)
- **IP protection category:** IP 67
- **Package contains:** battery, instruction manual, case

FEATURES 16 EWR-C:

- **Digital height:** 8.5 mm
- **Data interface:** USB, Opto RS-232C, Digimatic
- **Energy supply:** Battery life approx. 3 years

ACCESSORIES

Order no.	For measuring instrument	Description	Type
4102220	16 EWri-C	Receiver for instruments with Integrated Wireless	i-Stick
4102357	16 EWR-C	16 EXu data connection cable USB (2 m)	16 EXu
4102410	16 EWR-C	Data connection cable RS232C (2 m)	16 EXr
4102915	16 EWR-C	Interface adapter with data cable Digimatic (2 m)	16 EWd



i-Stick

MarCal 16 EWri-H / 16 EWR-H

Digital special calipers

FUNCTIONS



16 EWri-H:

- ON/OFF
- AUTO-ON / OFF
- mm/inch
- LOCK function (key lock)
- RESET (set display to zero)
- PRESET (for entering a numerical value)
- DATA (data transmission)
- HOLD (storage of measured values)



16 EWri-H

16 EWR-H:

- ON/OFF
- AUTO-ON / OFF
- mm/inch
- LOCK function (key lock)
- RESET (set display to zero)
- DATA (data transmission via connection cable)
- High contrast digital display
- Locking screw above
- Lapped guideway
- Measuring blade for inside measurements
- Slide and beam made of hardened stainless steel
- Step measuring function
- Immediate measurements due to the Reference System
- Raised guideway for the protection of the scale
- Excellent resistance against dust, coolants and lubricants
- Dirt wipers are integrated in the slide

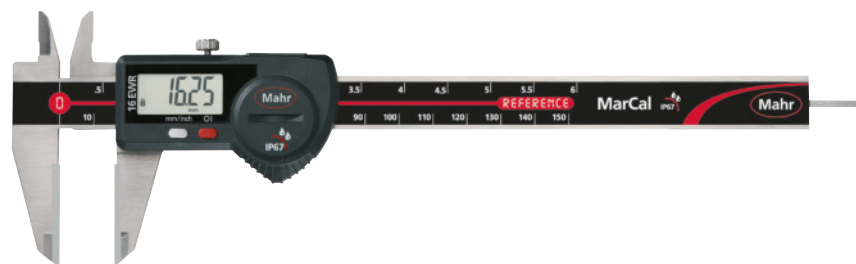

16 EWR-H



Application:

- Outer measuring surfaces made of carbide, for measuring hard materials

TECHNICAL DATA

Order no.	Type	Measuring range	Measuring range	Resolution	Error limit	Standard	Depth rod
		mm	inch	mm/inch	mm		
4103373	16 EWri-H	0 – 150	0 – 6"	0.01 / .0005"	0.03	DIN 862	round
4103073	16 EWR-H	0 – 150	0 – 6"	0.01 / .0005"	0.03	DIN 862	round

Order no.	a	b	c	d	e
	mm	mm	mm	mm	mm
4103373	10	40	16	235	16
4103073	10	40	16	235	16

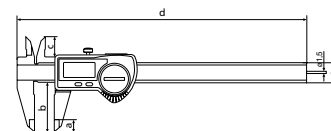

FEATURES 16 EWri-H:

- **Software:** MarCom Professional free download: www.mahr.com/marcom (only for Mahr data cables and wireless systems with USB and RS-232 interface)
- **Digital height:** 11 mm
- **Data interface:** Integrated Wireless
- **Energy supply:** Battery life approx. 3 years (approx. 0.5 in wireless mode)
- **Battery type:** CR 2032 (3V Lithium)
- **IP protection category:** IP 67
- **Package contains:** battery, instruction manual, case

FEATURES 16 EWR-H:

- **Digital height:** 8.5 mm
- **Data interface:** USB, Opto RS-232C, Digimatic
- **Energy supply:** Battery life approx. 3 years

ACCESSORIES

Order no.	For measuring instrument	Description	Type
4102220	16 EWri-H	Receiver for instruments with Integrated Wireless	i-Stick
4102357	16 EWR-H	16 EXu data connection cable USB (2 m)	16 EXu
4102410	16 EWR-H	Data connection cable RS232C (2 m)	16 EXr
4102915	16 EWR-H	Interface adapter with data cable Digimatic (2 m)	16 EWd



i-Stick

MarCal 16 EWri-AR / 16 EWR-AR

Digital special calipers

FUNCTIONS

16 EWri-AR:

- ON/OFF
- AUTO-ON / OFF
- mm/inch
- LOCK function (key lock)
- RESET (set display to zero)
- PRESET (for entering a numerical value)
- DATA (data transmission)
- HOLD (storage of measured values)

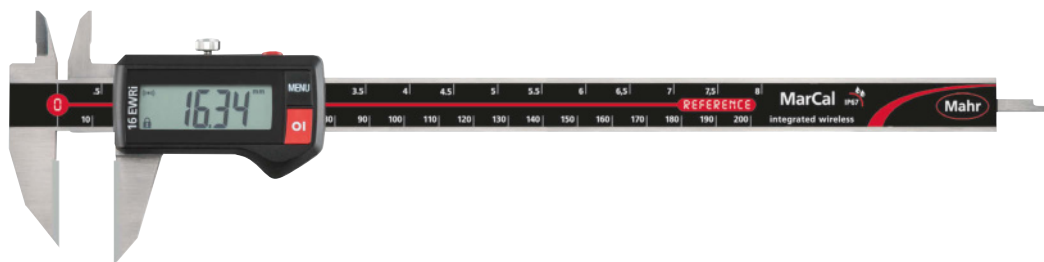

16 EWri-AR



16 EWR-AR:

- ON/OFF
- AUTO-ON / OFF
- mm/inch
- LOCK function (key lock)
- RESET (set display to zero)
- DATA (data transmission via connection cable)
- High contrast digital display
- Locking screw above
- Lapped guideway
- Measuring blade for inside measurements
- Slide and beam made of hardened stainless steel
- Step measuring function
- Immediate measurements due to the Reference System
- Raised guideway for the protection of the scale
- Excellent resistance against dust, coolants and lubricants
- Dirt wipers are integrated in the slide

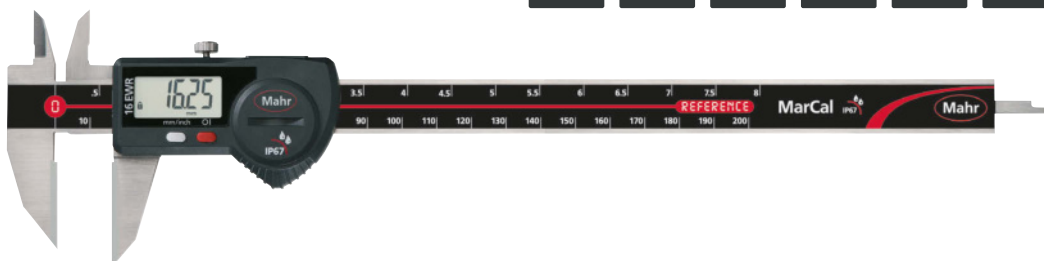

16 EWR-AR



Applications:

- Outer measuring surfaces made of carbide
- For marking out workpieces

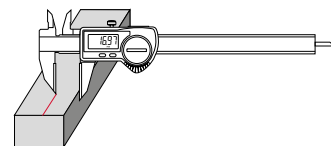

TECHNICAL DATA

Order no.	Type	Measuring range	Measuring range	Resolution	Error limit	Standard	Depth rod
4103382	16 EWri-AR	mm	inch	mm/inch	mm	Factory standard	rectangular
4103082	16 EWR-AR	0 – 200	0 – 8"	0.01 / .0005"	0.03	Factory standard	rectangular

Order no.	c	d	e
4103382	mm	mm	mm
4103082	16.5	285	16
4103082	16.5	285	16

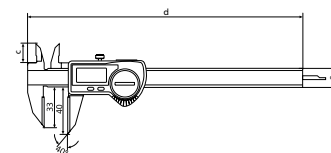

FEATURES 16 EWri-AR:

- **Software:** MarCom Professional free download: www.mahr.com/marcom (only for Mahr data cables and wireless systems with USB and RS-232 interface)
- **Digital height:** 11 mm
- **Data interface:** Integrated Wireless
- **Energy supply:** Battery life approx. 3 years (approx. 0.5 in wireless mode)
- **Battery type:** CR 2032 (3V Lithium)
- **IP protection category:** IP 67
- **Package contains:** battery, instruction manual, case

FEATURES 16 EWR-AR:

- **Digital height:** 8.5 mm
- **Data interface:** USB, Opto RS-232C, Digimatic
- **Energy supply:** Battery life approx. 3 years

ACCESSORIES

Order no.	For measuring instrument	Description	Type
4102220	16 EWri-AR	Receiver for instruments with Integrated Wireless	i-Stick
4102357	16 EWR-AR	16 EXu data connection cable USB (2 m)	16 EXu
4102410	16 EWR-AR	Data connection cable RS232C (2 m)	16 EXr
4102915	16 EWR-AR	Interface adapter with data cable Digimatic (2 m)	16 EWd



i-Stick

MarCal 16 EWri-NA / 16 EWR-NA

Digital special calipers

FUNCTIONS

16 EWri-NA:

- ON/OFF
- AUTO-ON / OFF
- mm/inch
- LOCK function (key lock)
- RESET (set display to zero)
- PRESET (for entering a numerical value)
- DATA (data transmission)
- HOLD (storage of measured values)

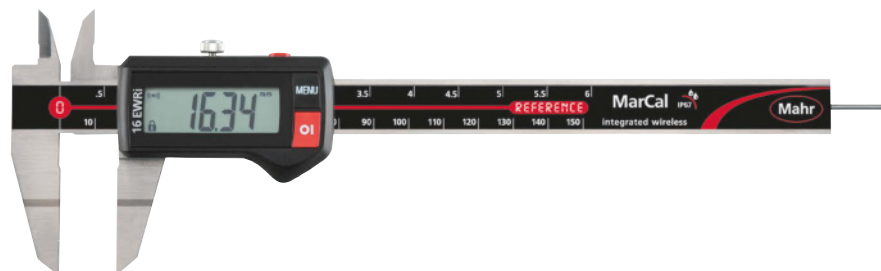

16 EWri-NA



16 EWR-NA:

- ON/OFF
- AUTO-ON / OFF
- mm/inch
- LOCK function (key lock)
- RESET (set display to zero)
- DATA (data transmission via connection cable)
- High contrast digital display
- Locking screw above
- Lapped guideway
- Measuring blade for inside measurements
- Slide and beam made of hardened stainless steel
- Step measuring function
- Immediate measurements due to the Reference System
- Raised guideway for the protection of the scale
- Excellent resistance against dust, coolants and lubricants
- Dirt wipers are integrated in the slide

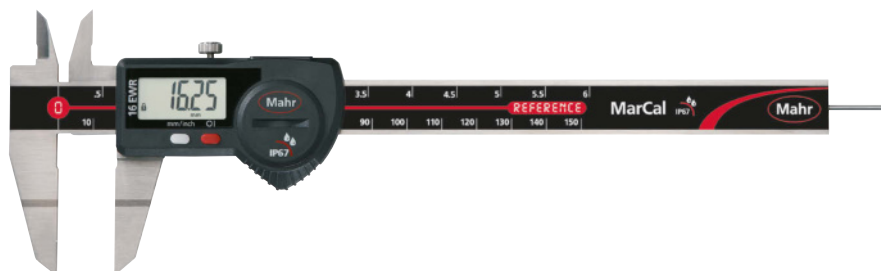

16 EWR-NA

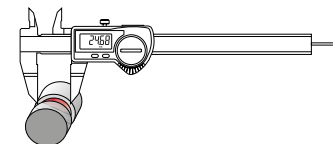

Application:

For measuring keyseats

TECHNICAL DATA

Order no.	Type	Measuring range	Measuring range	Resolution	Error limit	Standard	Depth Rod
4103374	16 EWri-NA	0-150	0-6"	0.01 / .0005"	0.03	Factory standard	round
4103074	16 EWR-NA	0-150	0-6"	0.01 / .0005"	0.03	Factory standard	round

Order no.	a	b	c	d	e
	mm	mm	mm	mm	mm
4103374	20	40	16.5	235	16
4103074	20	40	16.5	235	16

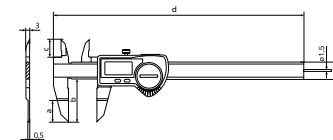

FEATURES 16 EWri-NA:

- **Software:** MarCom Professional free download: www.mahr.com/marcom (only for Mahr data cables and wireless systems with USB and RS-232 interface)
- **Digital height:** 11 mm
- **Data interface:** Integrated Wireless
- **Energy supply:** Battery life approx. 3 years (approx. 0.5 in wireless mode)
- **Battery type:** CR 2032 (3V Lithium)
- **IP protection category:** IP 67
- **Package contains:** battery, instruction manual, case

FEATURES 16 EWR-NA:

- **Digital height:** 8.5 mm
- **Data interface:** USB, Opto RS-232C, Digimatic
- **Energy supply:** Battery life approx. 3 years

ACCESSORIES

Order no.	For measuring instrument	Description	Type
4102220	16 EWri-NA	Receiver for instruments with Integrated Wireless	i-Stick
4102357	16 EWR-NA	16 EXu data connection cable USB (2 m)	16 EXu
4102410	16 EWR-NA	Data connection cable RS232C (2 m)	16 EXr
4102915	16 EWR-NA	Interface adapter with data cable Digimatic (2 m)	16 EWd



i-Stick

MarCal 16 EWri-S / 16 EWR-S

Digital special calipers

FUNCTIONS

16 EWri-S:

- ON/OFF
- AUTO-ON / OFF
- mm/inch
- LOCK function (key lock)
- RESET (set display to zero)
- PRESET (for entering a numerical value)
- DATA (data transmission)
- HOLD (storage of measured values)

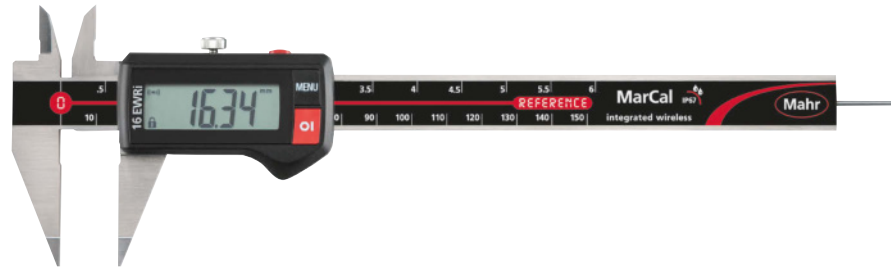

16 EWri-S

16 EWR-S:

- ON/OFF
- AUTO-ON / OFF
- mm/inch
- LOCK function (key lock)
- RESET (set display to zero)
- DATA (data transmission via connection cable)
- High contrast digital display
- Locking screw above
- Lapped guideway
- Measuring blade for inside measurements
- Slide and beam made of hardened stainless steel
- Step measuring function
- Immediate measurements due to the Reference System
- Raised guideway for the protection of the scale
- Excellent resistance against dust, coolants and lubricants
- Dirt wipers are integrated in the slide

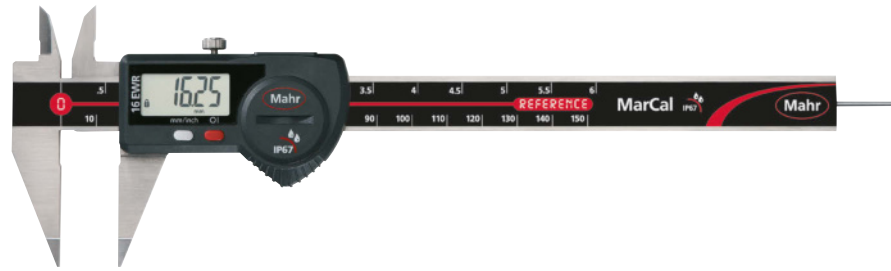

16 EWR-S

Application:

- With pointed jaws e.g. for measuring distances between grooves

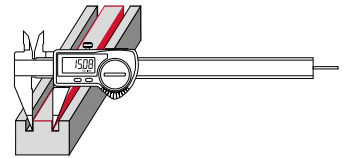

TECHNICAL DATA

Order no.	Type	Measuring range	Measuring range	Resolution	Error limit	Standard	Depth Rod
		mm	inch	mm/inch	mm		
4103375	16 EWri-S	0 – 150	0 – 6"	0.01 / .0005"	0.03	Factory standard	round
4103075	16 EWR-S	0 – 150	0 – 6"	0.01 / .0005"	0.03	Factory standard	round

Order no.	a	b	c	d	e
	mm	mm	mm	mm	mm
4103375	10	40	16.5	235	16
4103075	10	40	16.5	235	16

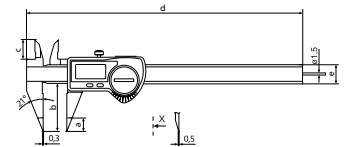

FEATURES 16 EWri-S:

- **Software:** MarCom Professional free download: www.mahr.com/marcom (only for Mahr data cables and wireless systems with USB and RS-232 interface)
- **Digital height:** 11 mm
- **Data interface:** Integrated Wireless
- **Energy supply:** Battery life approx. 3 years (approx. 0.5 in wireless mode)
- **Battery type:** CR 2032 (3V Lithium)
- **IP protection category:** IP 67
- **Package contains:** battery, instruction manual, case

FEATURES 16 EWR-S:

- **Digital height:** 8.5 mm
- **Data interface:** USB, Opto RS-232C, Digimatic
- **Energy supply:** Battery life approx. 3 years

ACCESSORIES

Order no.	For measuring instrument	Description	Type
4102220	16 EWri-S	Receiver for instruments with Integrated Wireless	i-Stick
4102357	16 EWR-S	16 EXu data connection cable USB (2 m)	16 EXu
4102410	16 EWR-S	Data connection cable RS232C (2 m)	16 EXr
4102915	16 EWR-S	Interface adapter with data cable Digimatic (2 m)	16 EWd



i-Stick

MarCal 16 EWri-SM / 16 EWR-SM

Digital special calipers

FUNCTIONS



16 EWri-SM:

- ON/OFF
- AUTO-ON / OFF
- mm/inch
- LOCK function (key lock)
- RESET (set display to zero)
- PRESET (for entering a numerical value)
- DATA (data transmission)
- HOLD (storage of measured values)

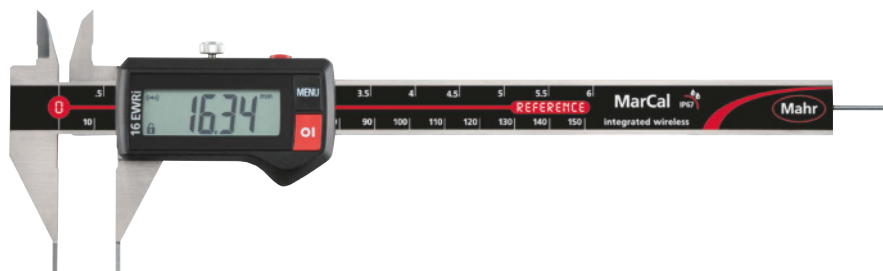

16 EWri-SM



16 EWR-SM:

- ON/OFF
- AUTO-ON / OFF
- mm/inch
- LOCK function (key lock)
- RESET (set display to zero)
- DATA (data transmission via connection cable)
- High contrast digital display
- Locking screw above
- Lapped guideway
- Measuring blade for inside measurements
- Slide and beam made of hardened stainless steel
- Step measuring function
- Immediate measurements due to the Reference System
- Raised guideway for the protection of the scale
- Excellent resistance against dust, coolants and lubricants
- Dirt wipers are integrated in the slide



16 EWR-SM

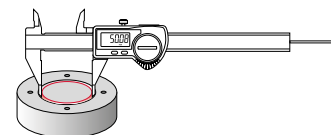

Application:

- With pointed jaws e.g. for measuring distances between grooves

TECHNICAL DATA

Order no.	Type	Measuring range	Measuring range	Resolution	Error limit	Standard	Depth rod
		mm	inch	mm/inch	mm		
4103376	16 EWri-SM	0 – 150	0 – 6"	0.01 / .0005"	0.03	Factory standard	round
4103076	16 EWR-SM	0 – 150	0 – 6"	0.01 / .0005"	0.03	Factory standard	round

Order no.	a	b	c	d	e
	mm	mm	mm	mm	mm
4103376	10	40	16.5	235	16
4103076	10	40	16.5	235	16

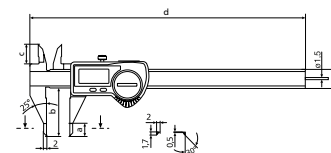

FEATURES 16 EWri-SM:

- **Software:** MarCom Professional free download: www.mahr.com/marcom (only for Mahr data cables and wireless systems with USB and RS-232 interface)
- **Digital height:** 11 mm
- **Data interface:** Integrated Wireless
- **Energy supply:** Battery life approx. 3 years (approx. 0.5 in wireless mode)
- **Battery type:** CR 2032 (3V Lithium)
- **IP protection category:** IP 67
- **Package contains:** battery, instruction manual, case

FEATURES 16 EWR-SM:

- **Digital height:** 8.5 mm
- **Data interface:** USB, Opto RS-232C, Digimatic
- **Energy supply:** Battery life approx. 3 years

ACCESSORIES

Order no.	For measuring instrument	Description	Type
4102220	16 EWri-SM	Receiver for instruments with Integrated Wireless	i-Stick
4102357	16 EWR-SM	16 EXu data connection cable USB (2 m)	16 EXu
4102410	16 EWR-SM	Data connection cable RS232C (2 m)	16 EXr
4102915	16 EWR-SM	Interface adapter with data cable Digimatic (2 m)	16 EWd



i-Stick

MarCal 16 EWri-VS / 16 EWR-VS

Digital special calipers

FUNCTIONS

16 EWri-VS:

- ON/OFF
- AUTO-ON / OFF
- mm/inch
- LOCK function (key lock)
- RESET (set display to zero)
- PRESET (for entering a numerical value)
- DATA (data transmission)
- HOLD (storage of measured values)



16 EWR-VS:

- ON/OFF
- AUTO-ON / OFF
- mm/inch
- LOCK function (key lock)
- RESET (set display to zero)
- DATA (data transmission via connection cable)
- High contrast digital display
- Locking screw above
- Lapped guideway
- Measuring blade for inside measurements
- Slide and beam made of hardened stainless steel
- Immediate measurements due to the Reference System
- Raised guideway for the protection of the scale
- Excellent resistance against dust, coolants and lubricants
- Dirt wipers are integrated in the slide

16 EWri-VS



16 EWR-VS

Application:

- With moving jaws for measuring stepped workpieces

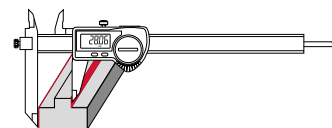

FEATURES 16 EWri-VS:

- **Software:** MarCom Professional free download: www.mahr.com/marcom (only for Mahr data cables and wireless systems with USB and RS-232 interface)
- **Digital height:** 11 mm
- **Data interface:** Integrated Wireless
- **Energy supply:** Battery life approx. 3 years (approx. 0.5 in wireless mode)
- **Battery type:** CR 2032 (3V Lithium)
- **IP protection category:** IP 67
- **Package contains:** battery, instruction manual, case

TECHNICAL DATA

Order no.	Type	Measuring range	Measuring range	Resolution	Error limit	Standard	Depth Rod
		mm	inch	mm/inch	mm		
4103383	16 EWri-VS	0-200	0-8"	0.01 / .0005"	0.04	Factory standard	rectangular
4103083	16 EWR-VS	0-200	0-8"	0.01 / .0005"	0.04	Factory standard	rectangular

Order no.	a	c	d	e
	mm	mm	mm	mm
4103383	14	18	278	16
4103083	14	18	278	16

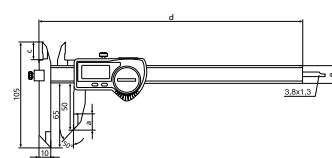

FEATURES 16 EWR-VS:

- **Digital height:** 8.5 mm
- **Data interface:** USB, Opto RS-232C, Digimatic
- **Energy supply:** Battery life approx. 3 years

ACCESSORIES

Order no.	For measuring instrument	Description	Type
4102220	16 EWri-VS	Receiver for instruments with Integrated Wireless	i-Stick
4102357	16 EWR-VS	16 EXu data connection cable USB (2 m)	16 EXu
4102410	16 EWR-VS	Data connection cable RS232C (2 m)	16 EXr
4102915	16 EWR-VS	Interface adapter with data cable Digimatic (2 m)	16 EWd



i-Stick

MarCal 16 EWri-BA / 16 EWR-BA

Digital special calipers

FUNCTIONS

16 EWri-BA:

- ON/OFF
- AUTO-ON / OFF
- mm/inch
- LOCK function (key lock)
- RESET (set display to zero)
- PRESET (for entering a numerical value)
- DATA (data transmission)
- HOLD (storage of measured values)



16 EWri-BA

16 EWR-BA:

- ON/OFF
- AUTO-ON / OFF
- mm/inch
- LOCK function (key lock)
- RESET (set display to zero)
- PRESET (for entering a numerical value)
- DATA (data transmission via connection cable)
- High contrast digital display
- Locking screw above
- Lapped guideway
- Slide and beam made of hardened stainless steel
- Immediate measurements due to the Reference System
- Raised guideway for the protection of the scale
- Excellent resistance against dust, coolants and lubricants
- Dirt wipers are integrated in the slide



16 EWR-BA

Application:

- For measuring the distance between bores

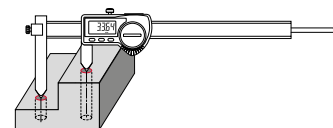

TECHNICAL DATA

FEATURES 16 EWri-BA:

- **Software:** MarCom Professional free download: www.mahr.com/marcom (only for Mahr data cables and wireless systems with USB and RS-232 interface)
- **Digital height:** 11 mm
- **Data interface:** Integrated Wireless
- **Energy supply:** Battery life approx. 3 years (approx. 0.5 in wireless mode)
- **Battery type:** CR 2032 (3V Lithium)
- **IP protection category:** IP 67
- **Package contains:** battery, instruction manual, case

Order no.	Type	Measuring range	Measuring range	Resolution	Error limit	Standard	Depth Rod
		mm	inch	mm/inch	mm		
4103384	16 EWri-BA	10 – 210	0.4 – 8.3"	0.01 / .0005"	0.04	Factory standard	rectangular
4103084	16 EWR-BA	10 – 210	0.4 – 8.3"	0.01 / .0005"	0.04	Factory standard	rectangular

Order no.	d	e
	mm	mm
4103384	278	16
4103084	278	16

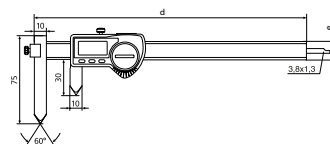

FEATURES 16 EWR-BA:

- **Digital height:** 8.5 mm
- **Data interface:** USB, Opto RS-232C, Digimatic
- **Energy supply:** Battery life approx. 3 years

ACCESSORIES

Order no.	For measuring instrument	Description	Type
4102220	16 EWri-BA	Receiver for instruments with Integrated Wireless	i-Stick
4102357	16 EWR-BA	16 EXu data connection cable USB (2 m)	16 EXu
4102410	16 EWR-BA	Data connection cable RS232C (2 m)	16 EXr
4102915	16 EWR-BA	Interface adapter with data cable Digimatic (2 m)	16 EWd



i-Stick

MarCal 16 EWri-SA / 16 EWR-SA

Digital special calipers

FUNCTIONS

16 EWri-SA:

- ON/OFF
- AUTO-ON / OFF
- mm/inch
- LOCK function (key lock)
- RESET (set display to zero)
- PRESET (for entering a numerical value)
- DATA (data transmission)
- HOLD (storage of measured values)



16 EWri-SA

16 EWR-SA:

- ON/OFF
- AUTO-ON / OFF
- mm/inch
- LOCK function (key lock)
- RESET (set display to zero)
- DATA (data transmission via connection cable)
- High contrast digital display
- Locking screw above
- Lapped guideway
- Slide and beam made of hardened stainless steel
- Immediate measurements due to the Reference System
- Raised guideway for the protection of the scale
- Excellent resistance against dust, coolants and lubricants
- Dirt wipers are integrated in the slide



16 EWR-SA

Application:

- Inward-angled measuring tips for measuring wall thicknesses and recesses on shafts

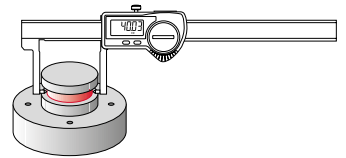

FEATURES 16 EWri-SA:

- **Software:** MarCom Professional free download: www.mahr.com/marcom (only for Mahr data cables and wireless systems with USB and RS-232 interface)
- **Digital height:** 11 mm
- **Data interface:** Integrated Wireless
- **Energy supply:** Battery life approx. 3 years (approx. 0.5 in wireless mode)
- **Battery type:** CR 2032 (3V Lithium)
- **IP protection category:** IP 67
- **Package contains:** battery, instruction manual, case

TECHNICAL DATA

Order no.	Type	Measuring range	Measuring range	Resolution	Error limit	Standard	Depth rod
		mm	inch	mm/inch	mm		
4103377	16 EWri-SA	0 – 140	0 – 6"	0.01 / .0005"	0.03	Factory standard	none
4103077	16 EWR-SA	0 – 140	0 – 6"	0.01 / .0005"	0.03	Factory standard	none

Order no.	b	d	e
	mm	mm	mm
4103377	40	235	16
4103077	40	235	16

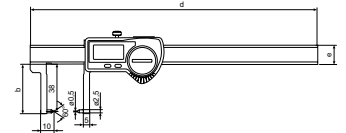

FEATURES 16 EWR-SA:

- **Digital height:** 8.5 mm
- **Data interface:** USB, Opto RS-232C, Digimatic
- **Energy supply:** Battery life approx. 3 years

ACCESSORIES

Order no.	For measuring instrument	Description	Type
4102220	16 EWri-SA	Receiver for instruments with Integrated Wireless	i-Stick
4102357	16 EWR-SA	16 EXu data connection cable USB (2 m)	16 EXu
4102410	16 EWR-SA	Data connection cable RS232C (2 m)	16 EXr
4102915	16 EWR-SA	Interface adapter with data cable Digimatic (2 m)	16 EWd



i-Stick

MarCal 16 EWri-AA / 16 EWR-AA

Digital special calipers

FUNCTIONS

16 EWri-AA:

- ON/OFF
- AUTO-ON / OFF
- mm/inch
- LOCK function (key lock)
- RESET (set display to zero)
- PRESET (for entering a numerical value)
- DATA (data transmission)
- HOLD (storage of measured values)



16 EWri-AA



16 EWR-AA:

- ON/OFF
- AUTO-ON / OFF
- mm/inch
- LOCK function (key lock)
- RESET (set display to zero)
- DATA (data transmission via connection cable)
- High contrast digital display
- Locking screw above
- Lapped guideway
- Slide and beam made of hardened stainless steel
- Immediate measurements due to the Reference System
- Raised guideway for the protection of the scale
- Excellent resistance against dust, coolants and lubricants
- Dirt wipers are integrated in the slide



16 EWR-AA



Application:

- Inward-angled measuring surfaces for measuring wall thicknesses and recesses on shafts

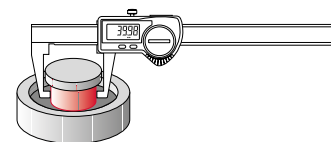

FEATURES 16 EWri-AA:

- **Software:** MarCom Professional free download: www.mahr.com/marcom (only for Mahr data cables and wireless systems with USB and RS-232 interface)
- **Digital height:** 11 mm
- **Data interface:** Integrated Wireless
- **Energy supply:** Battery life approx. 3 years (approx. 0.5 in wireless mode)
- **Battery type:** CR 2032 (3V Lithium)
- **IP protection category:** IP 67
- **Package contains:** battery, instruction manual, case

TECHNICAL DATA

Order no.	Type	Measuring range	Measuring range	Resolution	Error limit	Standard	Depth Rod
		mm	inch	mm/inch	mm		
4103379	16 EWri-AA	0 – 150	0 – 6"	0.01 / .0005"	0.03	Factory standard	none
4103079	16 EWR-AA	0 – 150	0 – 6"	0.01 / .0005"	0.03	Factory standard	none

Order no.	b	d	e
	mm	mm	mm
4103379	40	235	16
4103079	40	235	16

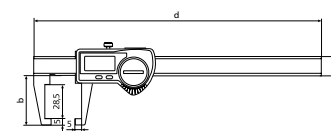

FEATURES 16 EWR-AA:

- **Digital height:** 8.5 mm
- **Data interface:** USB, Opto RS-232C, Digimatic
- **Energy supply:** Battery life approx. 3 years

ACCESSORIES

Order no.	For measuring instrument	Description	Type
4102220	16 EWri-AA	Receiver for instruments with Integrated Wireless	i-Stick
4102357	16 EWR-AA	16 EXu data connection cable USB (2 m)	16 EXu
4102410	16 EWR-AA	Data connection cable RS232C (2 m)	16 EXr
4102915	16 EWR-AA	Interface adapter with data cable Digimatic (2 m)	16 EWd



i-Stick

MarCal 16 EWri-SI / 16 EWR-SI

Digital special calipers

FUNCTIONS

16 EWri-SI:

- ON/OFF
- AUTO-ON / OFF
- mm/inch
- LOCK function (key lock)
- RESET (set display to zero)
- PRESET (for entering a numerical value)
- DATA (data transmission)
- HOLD (storage of measured values)



16 EWri-SI

16 EWR-SI:

- ON/OFF
- AUTO-ON / OFF
- mm/inch
- LOCK function (key lock)
- RESET (set display to zero)
- PRESET (for entering a numerical value)
- DATA (data transmission via connection cable)
- High contrast digital display
- Locking screw above
- Lapped guideway
- Slide and beam made of hardened stainless steel
- Immediate measurements due to the Reference System
- Raised guideway for the protection of the scale
- Excellent resistance against dust, coolants and lubricants
- Dirt wipers are integrated in the slide



16 EWR-SI

Application:

- Outward-angled measuring tips for measuring recesses in bores

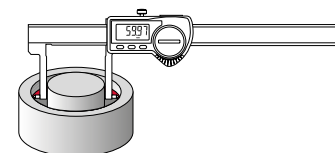

TECHNICAL DATA

Order no.	Type	Measuring range	Measuring range	Resolution	Error limit	Standard	Depth Rod
		mm	inch	mm/inch	mm		
4103378	16 EWri-SI	20–170	0.8–6.7"	0.01 / .0005"	0.03	Factory standard	none
4103078	16 EWR-SI	20–170	0.8–6.7"	0.01 / .0005"	0.03	Factory standard	none

Order no.	b	d	e
	mm	mm	mm
4103378	28	235	16
4103078	28	235	16

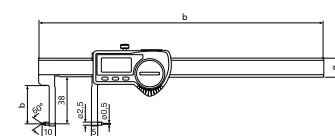

FEATURES 16 EWri-SI:

- **Software:** MarCom Professional free download: www.mahr.com/marcom (only for Mahr data cables and wireless systems with USB and RS-232 interface)
- **Digital height:** 11 mm
- **Data interface:** Integrated Wireless
- **Energy supply:** Battery life approx. 3 years (approx. 0.5 in wireless mode)
- **Battery type:** CR 2032 (3V Lithium)
- **IP protection category:** IP 67
- **Package contains:** battery, instruction manual, case

FEATURES 16 EWR-SI:

- **Digital height:** 8.5 mm
- **Data interface:** USB, Opto RS-232C, Digimatic
- **Energy supply:** Battery life approx. 3 years

ACCESSORIES

Order no.	For measuring instrument	Description	Type
4102220	16 EWri-SI	Receiver for instruments with Integrated Wireless	i-Stick
4102357	16 EWR-SI	16 EXu data connection cable USB (2 m)	16 EXu
4102410	16 EWR-SI	Data connection cable RS232C (2 m)	16 EXr
4102915	16 EWR-SI	Interface adapter with data cable Digimatic (2 m)	16 EWd



i-Stick

MarCal 16 EWri-AI / 16 EWR-AI

Digital special calipers

FUNCTIONS



16 EWri-AI:

- ON/OFF
- AUTO-ON / OFF
- mm/inch
- LOCK function (key lock)
- RESET (set display to zero)
- PRESET (for entering a numerical value)
- DATA (data transmission)
- HOLD (storage of measured values)



16 EWri-AI



16 EWR-AI:

- ON/OFF
- AUTO-ON / OFF
- mm/inch
- LOCK function (key lock)
- RESET (set display to zero)
- PRESET (for entering a numerical value)
- DATA (data transmission via connection cable)
- High contrast digital display
- Locking screw above
- Lapped guideway
- Slide and beam made of hardened stainless steel
- Immediate measurements due to the Reference System
- Raised guideway for the protection of the scale
- Excellent resistance against dust, coolants and lubricants
- Dirt wipers are integrated in the slide



16 EWR-AI

Application:

- Outward-angled measuring surfaces for measuring recesses in bores

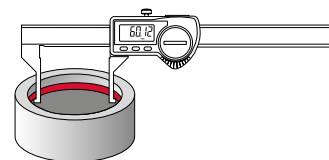

FEATURES 16 EWri-AI:

- **Software:** MarCom Professional free download: www.mahr.com/marcom (only for Mahr data cables and wireless systems with USB and RS-232 interface)
- **Digital height:** 11 mm
- **Data interface:** Integrated Wireless
- **Energy supply:** Battery life approx. 3 years (approx. 0.5 in wireless mode)
- **Battery type:** CR 2032 (3V Lithium)
- **IP protection category:** IP 67
- **Package contains:** battery, instruction manual, case

TECHNICAL DATA

Order no.	Type	Measuring range	Measuring range	Resolution	Error limit	Standard	Depth rod
		mm	inch	mm/inch	mm		
4103380	16 EWri-AI	10 – 160	0.4 – 6.3"	0.01 / .0005"	0.03	Factory standard	none
4103080	16 EWR-AI	10 – 160	0.4 – 6.3"	0.01 / .0005"	0.03	Factory standard	none

Order no.	b	d	e
	mm	mm	mm
4103380	40	235	16
4103080	40	235	16

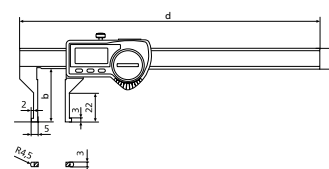

FEATURES 16 EWR-AI:

- **Digital height:** 8.5 mm
- **Data interface:** USB, Opto RS-232C, Digimatic
- **Energy supply:** Battery life approx. 3 years

ACCESSORIES

Order no.	For measuring instrument	Description	Type
4102220	16 EWri-AI	Receiver for instruments with Integrated Wireless	i-Stick
4102357	16 EWR-AI	16 EXu data connection cable USB (2 m)	16 EXu
4102410	16 EWR-AI	Data connection cable RS232C (2 m)	16 EXr
4102915	16 EWR-AI	Interface adapter with data cable Digimatic (2 m)	16 EWd



i-Stick

MarCal 16 EWRI-RW / 16 EWR-RW

Digital special calipers

FUNCTIONS

16 EWRI-RW:

- ON/OFF
- AUTO-ON / OFF
- mm/inch
- LOCK function (key lock)
- RESET (set display to zero)
- PRESET (for entering a numerical value)
- DATA (data transmission)
- HOLD (storage of measured values)



16 EWRI-RW

16 EWR-RW:

- ON/OFF
- AUTO-ON / OFF
- mm/inch
- LOCK function (key lock)
- RESET (set display to zero)
- DATA (data transmission via connection cable)
- High contrast digital display
- Locking screw above
- Lapped guideway
- Slide and beam made of hardened stainless steel
- Immediate measurements due to the Reference System
- Raised guideway for the protection of the scale
- Excellent resistance against dust, coolants and lubricants
- Dirt wipers are integrated in the slide



16 EWR-RW

Application:

- Measurement of wall thicknesses

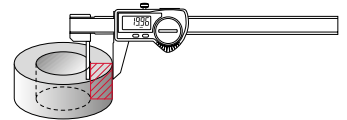

FEATURES 16 EWRI-RW:

- **Software:** MarCom Professional free download: www.mahr.com/marcom (only for Mahr data cables and wireless systems with USB and RS-232 interface)
- **Digital height:** 11 mm
- **Data interface:** Integrated Wireless
- **Energy supply:** Battery life approx. 3 years (approx. 0.5 in wireless mode)
- **Battery type:** CR 2032 (3V Lithium)
- **IP protection category:** IP 67
- **Package contains:** battery, instruction manual, case

FEATURES 16 EWR-RW:

- **Digital height:** 8.5 mm
- **Data interface:** USB, Opto RS-232C, Digimatic
- **Energy supply:** Battery life approx. 3 years

TECHNICAL DATA

Order no.	Type	Measuring range	Measuring range	Resolution	Error limit	Standard	Depth rod
		mm	inch	mm/inch	mm		
4103381	16 EWRI-RW	0 – 150	0 – 6"	0.01 / .0005"	0.05	Factory standard	none
4103081	16 EWR-RW	0 – 150	0 – 6"	0.01 / .0005"	0.05	Factory standard	none

Order no.	b	d	e
	mm	mm	mm
4103381	40	235	16
4103081	40	235	16

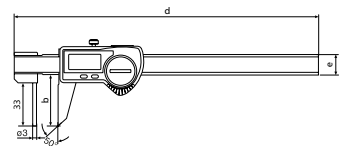

ACCESSORIES

Order no.	For measuring instrument	Description	Type
4102220	16 EWRI-RW	Receiver for instruments with Integrated Wireless	i-Stick
4102357	16 EWR-RW	16 EXu data connection cable USB (2 m)	16 EXu
4102410	16 EWR-RW	Data connection cable RS232C (2 m)	16 EXr
4102915	16 EWR-RW	Interface adapter with data cable Digimatic (2 m)	16 EWd



i-Stick

MarCal 16 EWri-LI / 16 EWR-LI

Digital special calipers

FUNCTIONS



16 EWri-LI:

- ON/OFF
- AUTO-ON / OFF
- mm/inch
- LOCK function (key lock)
- RESET (set display to zero)
- PRESET (for entering a numerical value)
- DATA (data transmission)
- HOLD (storage of measured values)



16 EWri-LI

16 EWR-LI:

- ON/OFF
- AUTO-ON / OFF
- mm/inch
- LOCK function (key lock)
- RESET (set display to zero)
- PRESET (for entering a numerical value)
- DATA (data transmission via connection cable)
- High contrast digital display
- Locking screw above
- Lapped guideway
- Measuring blade for inside measurements
- Slide and beam made of hardened stainless steel
- Immediate measurements due to the Reference System
- Raised guideway for the protection of the scale
- Excellent resistance against dust, coolants and lubricants
- Dirt wipers are integrated in the slide



16 EWR-LI

Application:

- With long internal cutting edges

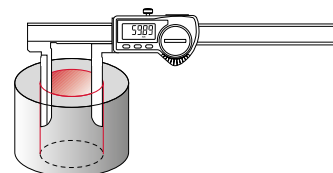

TECHNICAL DATA

Order no.	Type	Measuring range	Measuring range	Resolution	Error limit	Standard	Depth rod
		mm	inch	mm/inch	mm		
4103385	16 EWri-LI	10 – 200	0.4 – 8"	0.01 / .0005"	0.05	Factory standard	none
4103085	16 EWR-LI	10 – 200	0.4 – 8"	0.01 / .0005"	0.05	Factory standard	none

Order no.	b	d	e
	mm	mm	mm
4103385	60	285	16
4103085	60	285	16

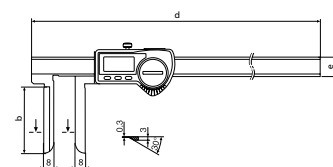

FEATURES 16 EWri-LI:

- **Software:** MarCom Professional free download: www.mahr.com/marcom (only for Mahr data cables and wireless systems with USB and RS-232 interface)
- **Digital height:** 11 mm
- **Data interface:** Integrated Wireless
- **Energy supply:** Battery life approx. 3 years (approx. 0.5 in wireless mode)
- **Battery type:** CR 2032 (3V Lithium)
- **IP protection category:** IP 67
- **Package contains:** battery, instruction manual, case

FEATURES 16 EWR-LI:

- **Digital height:** 8.5 mm
- **Data interface:** USB, Opto RS-232C, Digimatic
- **Energy supply:** Battery life approx. 3 years

ACCESSORIES

Order no.	For measuring instrument	Description	Type
4102220	16 EWri-LI	Receiver for instruments with Integrated Wireless	i-Stick
4102357	16 EWR-LI	16 EXu data connection cable USB (2 m)	16 EXu
4102410	16 EWR-LI	Data connection cable RS232C (2 m)	16 EXr
4102915	16 EWR-LI	Interface adapter with data cable Digimatic (2 m)	16 EWd



i-Stick

MarCal 30 EWRI / 30 EWR

Digital depth gage

FUNCTIONS

30 EWRI:

- ON/OFF
- AUTO-ON / OFF
- RESET (set display to zero)
- mm/inch
- PRESET (for entering a numerical value)
- LOCK function (key lock)
- HOLD (storage of measured values)
- Reversal of counting direction
- DATA (data transmission)

30 EWR:

- AUTO-ON / OFF
- DATA (data transmission via connection cable)
- ON/OFF
- PRESET (for entering a numerical value)
- RESET (set display to zero)
- mm/inch
- LOCK function (key lock)
- High contrast digital display
- Locking screw above
- Lapped guideway
- Measuring surfaces made of steel
- Slide and beam made of hardened stainless steel
- Immediate measurements due to the Reference System
- Raised guideway for the protection of the scale
- Excellent resistance against dust, coolants and lubricants
- Dirt wipers are integrated in the slide

FEATURES 30 EWRI:

- **Digital height:** 11 mm
- **Data interface:** Integrated Wireless
- **Energy supply:** Battery life approx. 3 years (approx. 0.5 in wireless mode)
- **Battery type:** CR 2032 (3V Lithium)
- **IP protection category:** IP 67
- **Package contains:** battery, instruction manual, case

FEATURES 30 EWR:

- **Digital height:** 8.5 mm
- **Data interface:** USB, Opto RS-232C, Digimatic
- **Energy supply:** Battery life approx. 3 years
- **Battery type:** CR 2032 (3V Lithium)
- **IP protection category:** IP 67
- **Package contains:** battery, instruction manual, case



TECHNICAL DATA

Order no.	Type	Measuring range		Resolution	Error limit	Standard
		mm	inch			
4126755	30 EWRI	0–150	0–6"	0.01 / .0005"	0.03	Factory standard
4126754	30 EWRI	0–200	0–8"	0.01 / .0005"	0.03	Factory standard
4126756	30 EWRI	0–300	0–12"	0.01 / .0005"	0.04	Factory standard
4126757	30 EWRI	0–500	0–20"	0.01 / .0005"	0.05	Factory standard
4126700	30 EWR	0–150	0–6"	0.01 / .0005"	0.03	Factory standard
4126699	30 EWR	0–200	0–8"	0.01 / .0005"	0.03	Factory standard
4126701	30 EWR	0–300	0–12"	0.01 / .0005"	0.04	Factory standard
4126702	30 EWR	0–500	0–20"	0.01 / .0005"	0.05	Factory standard

Order no.	a	b
	mm	mm
4126755	234	100
4126754	284	100
4126756	384	150
4126757	584	150
4126700	234	100
4126699	284	100
4126701	384	150
4126702	584	150

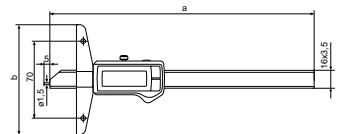

ACCESSORIES

Order no.	For measuring instrument	Description	Quantity	unit	Type
4102220	30 EWRI	Receiver for instruments with Integrated Wireless			i-Stick
4102357	30 EWR	16 EXu data connection cable USB (2 m)			16 EXu
4102410	30 EWR	Data connection cable RS232C (2 m)			16 EXr
4102915	30 EWR	Interface adapter with data cable Digimatic (2 m)			16 EWd
4125611	30 EWRI, 30 EWR	Anvil (4 mm)		Piece	30 ESa
4126510	30 EWRI, 30 EWR	Cross beam extension (300 mm)			30 EXm
4126511	30 EWRI, 30 EWR	Cross beam extension (200 mm)			30 EXm

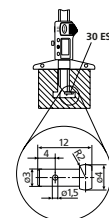
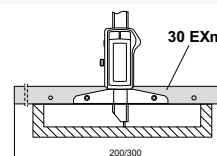

MarCal 30 EWri

Digital depth gage



FUNCTIONS

- ON/OFF
- AUTO-ON / OFF
- RESET (set display to zero)
- mm/inch
- PRESET (for entering a numerical value)
- LOCK function (key lock)
- HOLD (storage of measured values)
- Reversal of counting direction
- DATA (data transmission)



FEATURES

- High contrast digital display
- Locking screw above
- Lapped guideway
- Measuring surfaces made of steel
- Slide and beam made of hardened stainless steel
- Immediate measurements due to the Reference System
- Raised guideway for the protection of the scale
- Excellent resistance against dust, coolants and lubricants
- Dirt wipers are integrated in the slide
- **Software:** MarCom Professional free download: www.mahr.com/marcom (only for Mahr data cables and wireless systems with USB and RS-232 interface)
- **Data interface:** Integrated Wireless
- **Energy supply:** Battery life approx. 3 years (approx. 0.5 in wireless mode)
- **Battery type:** CR 2032 (3V Lithium)
- **IP protection category:** IP 67
- **Package contains:** battery, instruction manual, case

Applications:

- Small, handy, practical
- Ideal for mobile use in manufacturing and inspection as well as assembly
- For small measuring depths in holes, grooves, etc.

TECHNICAL DATA

Order no.	Type	Measuring range	Measuring range	Resolution	Error limit	Standard	Depth rod
		mm	inch	mm/inch	mm		
4126751	30 EWri	0–25	0–1"	0.01 / .0005"	0.02	Factory standard	round

Order no.	a	b
	mm	mm
4126751	129	48

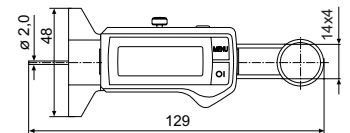

ACCESSORIES

Order no.	Description	Type
4102220	Receiver for instruments with Integrated Wireless	i-Stick



i-Stick

MarCal 30 EWri-D / 30 EWR-D

Digital depth gage

FUNCTIONS

30 EWri-D:

- ON/OFF
- AUTO-ON / OFF
- mm/inch
- LOCK function (key lock)
- RESET (set display to zero)
- PRESET (for entering a numerical value)
- DATA (data transmission)
- HOLD (storage of measured values)



30 EWri-D



30 EWR-D:

- ON/OFF
- AUTO-ON / OFF
- mm/inch
- LOCK function (key lock)
- RESET (set display to zero)
- PRESET (for entering a numerical value)
- DATA (data transmission via connection cable)
- High contrast digital display
- Locking screw above
- Lapped guideway
- Measuring surfaces made of steel
- Slide and beam made of hardened stainless steel
- Immediate measurements due to the Reference System
- Raised guideway for the protection of the scale
- Excellent resistance against dust, coolants and lubricants
- Dirt wipers are integrated in the slide



30 EWR-D



Application:

- Measuring groove widths and distances between grooves

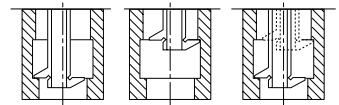

TECHNICAL DATA

Order no.	Type	Measuring range		Resolution	Error limit	Standard
		mm	inch			
4126533	30 EWri-D	0 – 200	0 – 8"	0.01 / .0005"	0.03	Factory standard
4126534	30 EWri-D	0 – 300	0 – 12"	0.01 / .0005"	0.04	Factory standard
4126523	30 EWR-D	0 – 200	0 – 8"	0.01 / .0005"	0.03	Factory standard
4126524	30 EWR-D	0 – 300	0 – 12"	0.01 / .0005"	0.04	Factory standard

Order no.	a	b	c
	mm	mm	mm
4126533	281	100	12
4126534	381	150	12
4126523	281	100	12
4126524	381	150	12

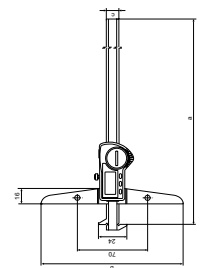

FEATURES 30 EWri-D:

- **Digital height:** 11 mm
- **Data interface:** Integrated Wireless
- **Energy supply:** Battery life approx. 3 years (approx. 0.5 in wireless mode)
- **Battery type:** CR 2032 (3V Lithium)
- **IP protection category:** IP 67
- **Package contains:** battery, instruction manual, case

FEATURES 30 EWR-D:

- **Digital height:** 8.5 mm
- **Data interface:** USB, Opto RS-232C, Digimatic
- **Energy supply:** Battery life approx. 3 years
- **Battery type:** CR 2032 (3V Lithium)
- **IP protection category:** IP 67
- **Package contains:** battery, instruction manual, case

ACCESSORIES

Order no.	For measuring instrument	Description	Type
4102220	30 EWri-D	Receiver for instruments with Integrated Wireless	i-Stick
4102357	30 EWR-D	16 EXu data connection cable USB (2 m)	16 EXu
4102410	30 EWR-D	Data connection cable RS232C (2 m)	16 EXr
4102915	30 EWR-D	Interface adapter with data cable Digimatic (2 m)	16 EWd
4126510	30 EWri-D, 30 EWR-D	Cross beam extension (300 mm)	30 EXm
4126511	30 EWri-D, 30 EWR-D	Cross beam extension (200 mm)	30 EXm

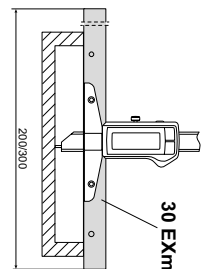

i-Stick

MarCal 30 EWri-N / 30 EWR-N

Digital depth gage

FUNCTIONS

30 EWri-N:

- ON/OFF
- AUTO-ON / OFF
- mm/inch
- LOCK function (key lock)
- RESET (set display to zero)
- PRESET (for entering a numerical value)
- DATA (data transmission)
- HOLD (storage of measured values)



30 EWR-N:

- ON/OFF
- AUTO-ON / OFF
- mm/inch
- LOCK function (key lock)
- RESET (set display to zero)
- PRESET (for entering a numerical value)
- DATA (data transmission via connection cable)
- High contrast digital display
- Locking screw above
- Lapped guideway
- Measuring surfaces made of steel
- Slide and beam made of hardened stainless steel
- Immediate measurements due to the Reference System
- Raised guideway for the protection of the scale
- Excellent resistance against dust, coolants and lubricants
- Dirt wipers are integrated in the slide



Application:

- Measuring groove widths and distances between grooves

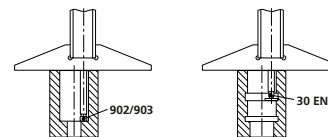

TECHNICAL DATA

Order no.	Type	Measuring range		Resolution	Error limit	Standard
		mm	inch			
4126532	30 EWri-N	0 – 100	0 – 4"	0.01 / .0005"	0.03	Factory standard
4126513	30 EWR-N	0 – 100	0 – 4"	0.01 / .0005"	0.03	Factory standard

FEATURES 30 EWri-N:

- **Digital height:** 11 mm
- **Data interface:** Integrated Wireless
- **Energy supply:** Battery life approx. 3 years (approx. 0.5 in wireless mode)
- **Battery type:** CR 2032 (3V Lithium)
- **IP protection category:** IP 67
- **Package contains:** battery, instruction manual, anvils 30 Ent (1mm), 902 (4mm) and 903 (4mm), case

Order no.	a	b	c
	mm	mm	mm
4126532	268	85	16
4126513	268	85	16

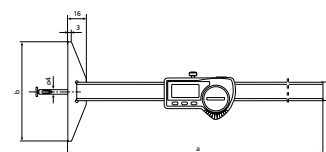

FEATURES 30 EWR-N:

- **Digital height:** 8.5 mm
- **Data interface:** USB, Opto RS-232C, Digimatic
- **Energy supply:** Battery life approx. 3 years

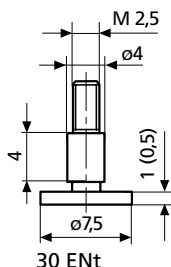

ACCESSORIES

Order no.	For measuring instrument	Description	Quantity	unit	Type
4102220	30 EWri-N	Receiver for instruments with Integrated Wireless			i-Stick
4102357	30 EWR-N	16 EXu data connection cable USB (2 m)	16	EXu	
4102410	30 EWR-N	Data connection cable RS232C (2 m)	16	EXr	
4102915	30 EWR-N	Interface adapter with data cable Digimatic (2 m)	16	EWd	
4126310	30 EWR-N, 30 EWri-N	Disc type anvil (7.5 x 0.5 mm)	Piece		30 ENT
4882022	30 EWR-N, 30 EWri-N	Disc type anvil (7.5 x 1 mm)	Piece		30 ENT



Micromar | Micrometers

Micrometers are among the most frequently used handheld measuring instruments. Products in the Micromar series boast superior precision and impressive reliability. The latest generation of waterproof digital micrometers can be used in even the toughest workshop conditions.



Overview Micromar micrometers	62
Outside micrometers	
Micromar 40 EWRI / 40 EWR / 40 ER With digital display	64
Micromar 40 EWRI-L / 40 EWR-L With digital display	68
Micromar 40 A / 40 SA With scale display	70
Micromar 40 F / 40 FC / 40 T / 40 TS Dial comparators	71
Micromar 40 EWRI-V / 40 EWR-V Digital outside micrometers	74
Micromar 40 EWRI-S / 40 EWR-S Digital outside micrometers	80
Micromar 40 EWRI-B / 40 EWR-B Digital outside micrometers	82
Micromar 40 EWRI-R / 40 EWR-R Digital outside micrometers	84
Micromar 40 EWRI-K / 40 EWR-K Digital outside micrometers	86
Micromar 44 F / 44 Cm / 44 Cms Inside micrometers	88
Micromar 44 A / 44 AS / 44 EWR / 844 A / 844 AS Self-centering inside micrometers	90
Micromar individual sub-elements 44 EWg / 844 Ag / 44 Ak / 45 T	98

Micromar | Digital micrometer Micromar 40 EWRi micrometers with Integrated Wireless

With the Micromar 40 EWRi digital waterproof micrometer,, precise and reliable results are obtained even in the most difficult conditions.



Integrated Wireless

offers you much more freedom. Whether at the measuring workspace, for inspections inside or on the machine, in the case of large workpieces, you get fully autonomous measuring without limits by a cable.

High-contrast display

with 10 mm high digits enables accurate, fatigue-free reading of the measurement results.



Reference Lock

function prevents operating error caused by accidental usage of the operating buttons.

Stainless steel, hardened spindle



Tolerance function with warning limits:

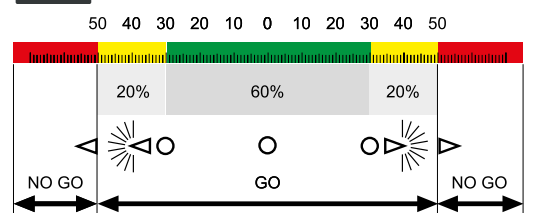

Steel frame

Sturdy hard lacquered

ABS

Absolute function

Micrometer can be set in any position to 0.000 mm / .0000" without the reference to the preset value being lost

Hold

Freezes the measured value after the measurement. Practical function for measuring tasks, where the display is not visible, i.e. measurements in the machine.

The ergonomically formed and thermally insulated handle as well as the integrated ratchet in the thimble ensures both trouble free handling and accurate measurement results.



Protection class IP65 in accordance to IEC 60529, the waterproof measuring system FPS (Fluid Protected measuring System) with a sealed housing.



Micromar | Design features

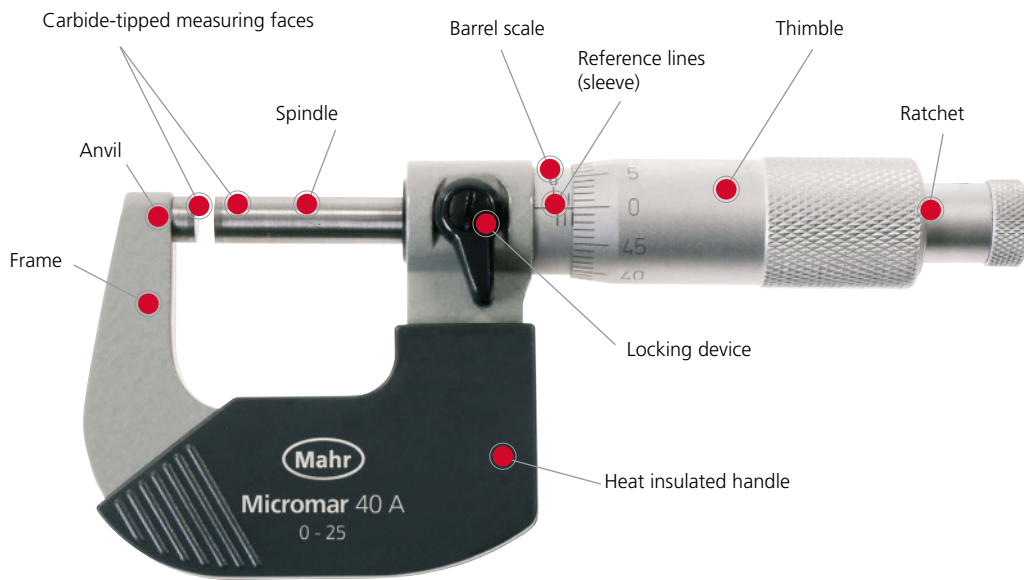

Reading example:

Micrometer with 0.01 mm divisions

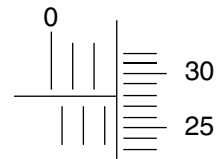

Sleeve	2.5
Thimble	0.28
Measuring result	2.78 mm

Micromar | Types of micrometers

Mahr micrometers are available in the following display variants:

a) Digital micrometer with digital display



b) Mechanical micrometer with scale and dial



c) Mechanical micrometer with scale



Error limits G according to DIN 863-1

Measuring range	Error limit		Measuring force
	G		
mm	μm	N	
0 – 25	4	5 – 10	
25 – 50	4	5 – 10	
50 – 75	5	5 – 10	
75 – 100	5	5 – 10	
100 – 125	6	5 – 10	
125 – 150	6	5 – 10	
150 – 175	7	5 – 10	
175 – 200	7	5 – 10	
200 – 225	8	5 – 10	
225 – 250	8	5 – 10	
250 – 275	9	5 – 10	
275 – 300	9	5 – 10	
300 – 325	10	5 – 10	
325 – 350	10	5 – 10	
350 – 375	11	5 – 10	
375 – 400	11	5 – 10	
400 – 425	12	5 – 10	
425 – 450	12	5 – 10	
450 – 475	13	5 – 10	
475 – 500	13	5 – 10	

Micromar 40 EWRI

Digital outside micrometers



FUNCTIONS

- RESET (set display to zero)
- ABS (display can be set to zero without losing reference to ORIGIN)
- mm/inch
- ORIGIN (for entering a numerical value)
- LOCK function (key lock)
- TOL (Tolerance and Warning Limits Input)
- HOLD (storage of measured values)
- DATA (data transmission)
- Bidirectional data interface (external output and input option of characteristic values as well as setting of individual lock functions by MarCom Software)

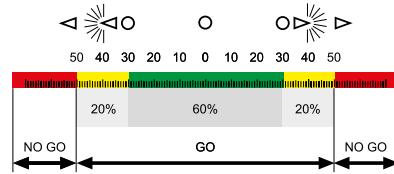

FEATURES

- High contrast digital display
- Stainless spindle is hardened throughout and ground
- Spindle and anvil are carbide-tipped
- Rapid drive
- Ratchet is integrated in the thimble
- Lacquered steel frame, heat insulated
- **Software:** MarCom Professional free download: www.mahr.com/marcom (only for Mahr data cables and wireless systems with USB and RS-232 interface)
- **Digit height:** 10 mm
- **Data interface:** Integrated Wireless
- **Energy supply:** Battery life approx. 3 years (approx. 0.5 in wireless mode)
- **Battery type:** CR 2032 (3V Lithium)
- **IP protection category:** IP 65
- **Package contains:** instruction manual, battery, setting values, case

TECHNICAL DATA

Order no.	Type	Measuring range		Measuring surface	Resolution	Error limit	Parallelism deviation	Flatness deviation
		mm	inch					
4157100	40 EWRI	0 – 25	0 – 1"	carbide	0.001 / .00005"	2	2	0.6
4157101	40 EWRI	25 – 50	1 – 2"	carbide	0.001 / .00005"	2	2	0.6
4157102	40 EWRI	50 – 75	2 – 3"	carbide	0.001 / .00005"	3	3	0.6
4157103	40 EWRI	75 – 100	3 – 4"	carbide	0.001 / .00005"	3	3	0.6
4157104	40 EWRI	100 – 125	4 – 5"	carbide	0.001 / .00005"	6	3	0.6
4157105	40 EWRI	125 – 150	5 – 6"	carbide	0.001 / .00005"	6	3	0.6
4157106	40 EWRI	150 – 175	6 – 7"	carbide	0.001 / .00005"	7	4	0.6
4157107	40 EWRI	175 – 200	7 – 8"	carbide	0.001 / .00005"	7	4	0.6
4157115	40 EWRI	0 – 100	0 – 4"	carbide	0.001 / .00005"			

Order no.	Spindle thread pitch	Measuring force	Standard	Number of micrometers	Model contact surface	a	b	c
						mm	mm	mm
4157100	0.5	5 – 10	Factory standard		flat	24	9.5	32
4157101	0.5	5 – 10	Factory standard		flat	36	11	57
4157102	0.5	5 – 10	Factory standard		flat	45	13	82
4157103	0.5	5 – 10	Factory standard		flat	57	13	107
4157104	0.5	5 – 10	DIN 863-1		flat	73	13	132
4157105	0.5	5 – 10	DIN 863-1		flat	82	13	157
4157106	0.5	5 – 10	DIN 863-1		flat	95	13	182
4157107	0.5	5 – 10	DIN 863-1		flat	106	13	207
4157115	0.5	5 – 10	Factory standard	4	flat			

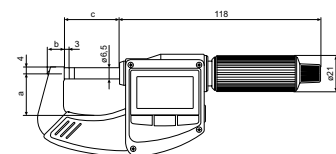

ACCESSORIES

Order no.	Description	Type
4102220	Receiver for instruments with Integrated Wireless	i-Stick
4102520	Battery 3 V, CR 2032	
4158000	Stand for holding outside micrometers	41 H



41 H



i-Stick

Micromar 40 EWR

Digital micrometer



FUNCTIONS

- RESET (set display to zero)
- ABS (display can be set to zero without losing reference to ORIGIN)
- mm/inch
- ORIGIN (for entering a numerical value)
- LOCK function (key lock)
- TOL (Tolerance and Warning Limits Input)
- HOLD (storage of measured values)
- DATA (data transmission via connection cable)
- Bidirectional data interface (external output and input option of characteristic values as well as setting of individual lock functions by MarCom Software)

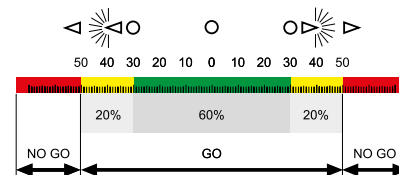

FEATURES

- High contrast digital display
- Stainless spindle is hardened throughout and ground
- Spindle and anvil are carbide-tipped
- Rapid drive
- Ratchet is integrated in the thimble
- Lacquered steel frame, heat insulated
- **Software:** MarCom Professional free download: www.mahr.com/marcom (only for Mahr data cables and wireless systems with USB and RS-232 interface)
- **Digit height:** 10 mm
- **Data interface:** MarConnect (bidirectional), USB, Digimatic
- **Energy supply:** Battery life approx. 2 years
- **Battery type:** CR 2032 (3V Lithium)
- **IP protection category:** IP 65
- **Package contains:** instruction manual, battery, setting standard (measuring range of 25–50 mm), case

TECHNICAL DATA

Order no.	Type	Measuring range		Measuring surface	Resolution	Error limit	Parallelism deviation	Flatness deviation
		mm	inch					
4157000	40 EWR	0–25	0–1"	carbide	0.001 / .00005"	2	2	0.6
4157001	40 EWR	25–50	1–2"	carbide	0.001 / .00005"	2	2	0.6
4157002	40 EWR	50–75	2–3"	carbide	0.001 / .00005"	3	3	0.6
4157003	40 EWR	75–100	3–4"	carbide	0.001 / .00005"	3	3	0.6
4157004	40 EWR	100–125	4–5"	carbide	0.001 / .00005"	6	3	0.6
4157005	40 EWR	125–150	5–6"	carbide	0.001 / .00005"	6	3	0.6
4157006	40 EWR	150–175	6–7"	carbide	0.001 / .00005"	7	4	0.6
4157007	40 EWR	175–200	7–8"	carbide	0.001 / .00005"	7	4	0.6
4157015	40 EWR	0–100	0–4"	carbide	0.001 / .00005"			

Order no.	Spindle thread pitch	Measuring force	Standard	Number of micrometers	Model contact surface	a	b	c
						mm	mm	mm
4157000	0.5	5–10	Factory standard		flat	24	9.5	32
4157001	0.5	5–10	Factory standard		flat	36	11	57
4157002	0.5	5–10	Factory standard		flat	45	13	82
4157003	0.5	5–10	Factory standard		flat	57	13	107
4157004	0.5	5–10	DIN 863–1		flat	73	13	132
4157005	0.5	5–10	DIN 863–1		flat	82	13	157
4157006	0.5	5–10	DIN 863–1		flat	95	13	182
4157007	0.5	5–10	DIN 863–1		flat	106	13	207
4157015	0.5	5–10	Factory standard	4	flat			

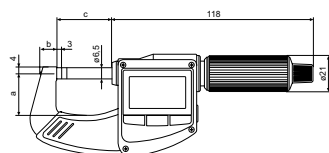

ACCESSORIES

Order no.	Description	Type
4102603	Data cable USB bidirectional (2 m)	DK-U1
4102606	Interface adapter with data cable Digimatic (2 m)	DK-D1
4158000	Stand for holding outside micrometers	41 H



41 H

Micromar 40 ER

Digital micrometer



FUNCTIONS

- RESET (set display to zero)
- mm/inch
- HOLD (storage of measured values)
- LOCK function (key lock)

FEATURES

- High contrast digital display
- Stainless spindle is hardened throughout and ground
- Spindle and anvil are carbide-tipped
- Rapid drive
- Ratchet is integrated in the thimble
- **Digit height:** 10 mm
- **Battery type:** CR 2032 (3V Lithium)
- **IP protection category:** IP 40
- **Package contains:** instruction manual, battery, case



TECHNICAL DATA

Order no.	Type	Measuring range	Measuring range inch	Measuring surface	Resolution	Error limit	Spindle thread pitch	Measuring force	Standard	Model contact surface
4157010	40 ER	mm 0–25	inch 0–1"	carbide	mm/inch 0.001 / .00005"	µm 2	mm 0.5	N 5–10	Factory standard	flat

Order no.	a	b	c
4157010	mm 24	mm 9.5	mm 32

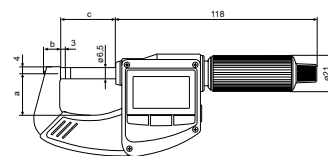

ACCESSORIES

Order no.	Description	Type
4102520	Battery 3 V, CR 2032	
4158000	Stand for holding outside micrometers	41 H



41 H

Micromar 40 EWR

Digital micrometer



ABS



REF system

FUNCTIONS

- RESET (set display to zero)
- ABS (display can be set to zero without losing reference to preset)
- mm/inch
- PRESET (for entering a numerical value)
- LOCK function (key lock)
- HOLD (storage of measured values)



FEATURES

- High contrast digital display
- Stainless spindle is hardened throughout and ground
- Spindle and anvil are carbide-tipped
- Rapid drive
- Ratchet is integrated in the thimble
- Lacquered steel frame, heat insulated
- **Digit height:** 10 mm
- **Energy supply:** Battery life approx. 2 years
- **Battery type:** CR 2032 (3V Lithium)
- **IP protection category:** IP 65
- **Package contains:** instruction manual, battery, setting standard (measuring range of 25–50 mm), case

TECHNICAL DATA

Order no.	Type	Measuring range	Measuring range	Measuring surface	Resolution	Error limit	Spindle thread pitch	Measuring force	Standard	Model contact surface
		mm	inch		mm/inch	µm	mm	N		
4157011	40 EWR	0–25	0–1"	carbide	0.001 / .00005"	2	0.5	5–10	Factory standard	flat
4157012	40 EWR	25–50	1–2"	carbide	0.001 / .00005"	2	0.5	5–10	Factory standard	flat
4157013	40 EWR	50–75	2–3"	carbide	0.001 / .00005"	3	0.5	5–10	Factory standard	flat
4157014	40 EWR	75–100	3–4"	carbide	0.001 / .00005"	3	0.5	5–10	Factory standard	flat

Order no.	a	b	c
	mm	mm	mm
4157011	24	9.5	32
4157012	36	11	57
4157013	45	13	82
4157014	57	13	107

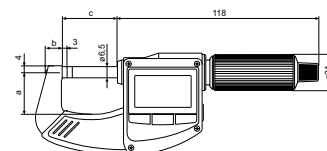

ACCESSORIES

Order no.	Description	Type
4158000	Stand for holding outside micrometers	41 H



41 H

Micromar 40 EWRI-L

Digital micrometer



FUNCTIONS

- RESET (set display to zero)
- ABS (display can be set to zero without losing reference to ORIGIN)
- mm/inch
- ORIGIN (for entering a numerical value)
- LOCK function (key lock)
- TOL (Tolerance and Warning Limits Input)
- HOLD (storage of measured values)
- DATA (data transmission)
- Bidirectional data interface (external output and input option of characteristic values as well as setting of individual lock functions by MarCom Software)



Applications:

- Avoiding workpiece damage: The non-rotating spindle contacts the surface without any friction, which prevents scratch marks on sensitive and finely machined surfaces.
- Ideal for measuring thin metal foils without twisting and bending them.
- Thread flank measurement by using thread wires: Both wire holders always remain in the engaged position with the non-rotating spindle.

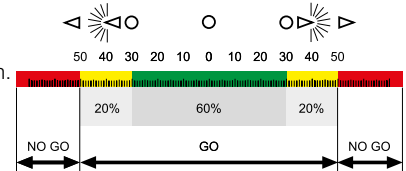

FEATURES

- High contrast digital display
- Stainless spindle is hardened throughout and ground
- Spindle and anvil are carbide-tipped
- Quick drive
- Sliding spindle
- Ratchet is integrated in the thimble
- Lacquered steel frame, heat insulated
- **Software:** MarCom Professional free download: www.mahr.com/marcom (only for Mahr data cables and wireless systems with USB and RS-232 interface)
- **Digit height:** 10 mm
- **Data interface:** Integrated Wireless
- **Energy supply:** Battery life approx. 2 years (approx. 0.5 in wireless mode)
- **Battery type:** CR 2032 (3V Lithium)
- **IP protection category:** IP 65
- **Package contains:** instruction manual, battery, setting standard (measuring range of 25–50 mm), case

TECHNICAL DATA

Order no.	Type	Measuring range		Measuring surface	Resolution	Error limit	Parallelism deviation	Flatness deviation
		mm	inch					
4157120	40 EWRI-L	0–25	0–1"	carbide	0.001 / .00005"	2	2	0.6
4157121	40 EWRI-L	25–50	1–2"	carbide	0.001 / .00005"	2	2	0.6
4157122	40 EWRI-L	50–75	2–3"	carbide	0.001 / .00005"	3	3	0.6
4157123	40 EWRI-L	75–100	3–4"	carbide	0.001 / .00005"	3	3	0.6
4157410	40 EWRI-L	0–100	0–4"	carbide	0.001 / .00005"			

Order no.	Spindle thread pitch	Measuring force	Standard	Number of micrometers	Model contact surface	a	b	c
	mm	N						
4157120	5	5–10	Factory standard		flat	24	9.5	32
4157121	5	5–10	Factory standard		flat	36	11	57
4157122	5	5–10	Factory standard		flat	45	13	82
4157123	5	5–10	Factory standard		flat	57	13	107
4157410	5	5–10	Factory standard	4	flat			

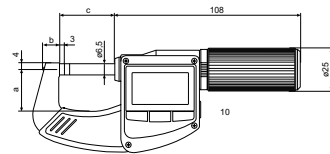

ACCESSORIES

Order no.	Description	Type
4102220	Receiver for instruments with Integrated Wireless	i-Stick
4158000	Stand for holding outside micrometers	41 H



41 H



i-Stick

Micromar 40 EWR-L

Digital micrometers



FUNCTIONS

- RESET (set display to zero)
- ABS (display can be set to zero without losing reference to ORIGIN)
- mm/inch
- ORIGIN (for entering a numerical value)
- LOCK function (key lock)
- TOL (Tolerance and Warning Limits Input)
- HOLD (storage of measured values)
- DATA (data transmission via connection cable)
- Bidirectional data interface (external output and input option of characteristic values as well as setting of individual lock functions by MarCom Software)



Applications:

- Avoiding workpiece damage: The non-rotating spindle contacts the surface without any friction, which prevents scratch marks on sensitive and finely machined surfaces.
- Ideal for measuring thin metal foils without twisting and bending them.
- Thread flank measurement by using thread wires: Both wire holders always remain in the engaged position with the non-rotating spindle.

FEATURES

- High contrast digital display
- Stainless spindle is hardened throughout and ground
- Spindle and anvil are carbide-tipped
- Quick drive
- Sliding spindle
- Ratchet is integrated in the thimble
- Lacquered steel frame, heat insulated
- **Software:** MarCom Professional free download: www.mahr.com/marcom (only for Mahr data cables and wireless systems with USB and RS-232 interface)
- **Digit height:** 10 mm
- **Data interface:** MarConnect (bidirectional), USB, Digimatic
- **Energy supply:** Battery life approx. 2 years
- **Battery type:** CR 2032 (3V Lithium)
- **IP protection category:** IP 65
- **Package contains:** battery, instruction manual, setting standard (measuring range of 25–50 mm), case

TECHNICAL DATA

Order no.	Type	Measuring range	Measuring range	Measuring surface	Resolution	Error limit	Parallelism deviation	Flatness deviation
		mm	inch		mm/inch	µm	µm	µm
4157020	40 EWR-L	0–25	0–1"	carbide	0.001 / .00005"	2	2	0.6
4157021	40 EWR-L	25–50	1–2"	carbide	0.001 / .00005"	2	2	0.6
4157022	40 EWR-L	50–75	2–3"	carbide	0.001 / .00005"	3	3	0.6
4157023	40 EWR-L	75–100	3–4"	carbide	0.001 / .00005"	3	3	0.6
4157400	40 EWR-L	0–100	0–4"	carbide	0.001 / .00005"			

Order no.	Spindle thread pitch	Measuring force	Standard	Number of micrometers	Model contact surface	a	b	c
	mm	N				mm	mm	mm
4157020	5	5–10	Factory standard		flat	24	9.5	32
4157021	5	5–10	Factory standard		flat	36	11	57
4157022	5	5–10	Factory standard		flat	45	13	82
4157023	5	5–10	Factory standard		flat	57	13	107
4157400	5	5–10	Factory standard	4	flat			

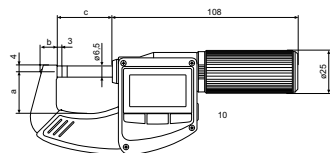

ACCESSORIES

Order no.	Description	Type
4102603	Data cable USB bidirectional (2 m)	DK-U1
4102606	Interface adapter with data cable Digimatic (2 m)	DK-D1
4158000	Stand for holding outside micrometers	41 H



41 H

Micromar 40 A / 40 SA

Micrometer

FEATURES

- Operating and display units with satin chrome finish
- Hard lacquered steel frame
- Spindle and anvil made of hardened steel, carbide-tipped
- Heat insulators
- Rapid drive with integrated ratchet
- Locking device
- **Package contains:** setting standard (measuring range of 25–50 mm), instruction manual, case



TECHNICAL DATA

Order no.	Type	Measuring range		Readings	Readings	Error limit	Error limit	Spindle pitch	Spindle thread pitch
		mm	inch						
4134000	40 A	0–25		0.01		4			0.5
4134001	40 A	25–50		0.01		4			0.5
4134002	40 A	50–75		0.01		5			0.5
4134003	40 A	75–100		0.01		5			0.5
4134004	40 A	100–125		0.01		6			0.5
4134005	40 A	125–150		0.01		6			0.5
4134006	40 A	150–175		0.01		7			0.5
4134007	40 A	175–200		0.01		7			0.5
4134050	40 SA	0–100		0.01					0.5
4134051	40 SA	100–200		0.01					0.5
4134900	40 A		0–1"		0.0001		0.00016	0.025	
4134901	40 A		1–2"		0.0001		0.00016	0.025	
4134902	40 A		2–3"		0.0001		0.0002	0.025	
4134903	40 A		3–4"		0.0001		0.0002	0.025	
4134904	40 A		4–5"		0.0001		0.00024	0.025	
4134905	40 A		5–6"		0.0001		0.00024	0.025	
4134906	40 A		6–7"		0.0001		0.00028	0.025	
4134907	40 A		7–8"		0.0001		0.00028	0.025	
4134960	40 SA		0–4"		0.0001			0.025	
4134961	40 SA		4–8"		0.0001			0.025	

Order no.	Standard	Number of micrometers	Model contact surface	a	b	c
				mm	mm	mm
4134000	DIN 863–1		flat	31	25.5	7
4134001	DIN 863–1		flat	56	34.5	12
4134002	DIN 863–1		flat	81	47.5	12
4134003	DIN 863–1		flat	106	58.5	13
4134004	DIN 863–1		flat	131	71.5	13
4134005	DIN 863–1		flat	156	83.5	13
4134006	DIN 863–1		flat	182	95.5	13
4134007	DIN 863–1		flat	207	108.5	13
4134050	DIN 863–1	4	flat			
4134051	DIN 863–1	4	flat			
4134900	Factory standard		flat	31	25.5	7
4134901	Factory standard		flat	56	34.5	12
4134902	Factory standard		flat	81	47.5	12
4134903	Factory standard		flat	106	58.5	13
4134904	Factory standard		flat	131	71.5	13
4134905	Factory standard		flat	156	83.5	13
4134906	Factory standard		flat	182	95.5	13
4134907	Factory standard		flat	207	108.5	13
4134960	Factory standard		flat			
4134961	Factory standard		flat			

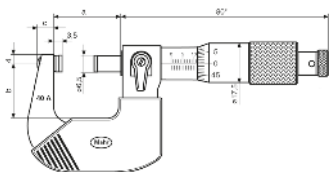

ACCESSORIES

Order no.	Description	Type
4158000	Stand for holding outside micrometers	41 H



41 H

Micromar 40 F / 40 FC

Micrometer with integrated dial comparator

FEATURES

- Operating and display units with satin chrome finish
- Dial comparator is integrated in frame
- Adjustable tolerance markers
- Chrome plated steel frame, heat insulated
- Retraction of the movable anvil ensures maximum wear resistance
- Spindle and anvil are carbide-tipped
- Stainless spindle is hardened throughout and ground
- Locking device
- Constant measuring force
- **Package contains:** instruction manual, case



Application:

- Quick check of diameter of cylindrical parts (shafts, bolts, shanks)
- Thickness and length measurements
- Particularly suitable for exact series components

TECHNICAL DATA

Order no.		4150000	4150001	4150200	4150201
Type		40 F		40 FC	
Measuring range	mm	0 –25	25 –50	0 –25	25 –50
Measuring surface		carbide		ceramic	
Readings				0.01	
Error limit	µm			2	
Parallelism deviation	µm			1	
Flatness deviation	µm			0.2	
Spindle thread pitch	mm			0.5	
Measuring force	N			9	
Standard				Factory standard	
Model contact surface				flat	
Measuring range, dial comparator (measuring screw)	µm			± 65	
Scale graduation value	µm			1	
Error limit G _e	µm			1	

Order no.		4150900	4150901
Type		40 F	
Measuring range	inch	0 –1"	1 –2"
Readings	inch		0.0001
Error limit	inch		0.00008
Parallelism deviation	µm		1
Flatness deviation	µm		0.2
Spindle pitch	inch		0.025
Measuring force	N		9
Standard			Factory standard
Model contact surface			flat
Measuring range dial comparator (Micrometer screw)	inch		± .0025"
Scale graduation value	inch		0.00005
Error limit G _e	inch		0.00005

Order no.	a	b	c	d	e
	mm	mm	mm	mm	mm
4150000	149	100	16	71	32
4150001	174	125	30	85	56
4150200	149	100	16	71	32
4150201	174	125	30	85	56
4150900	149	100	16	71	32
4150901	174	125	30	85	56

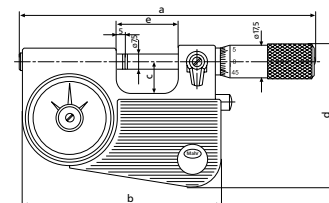

ACCESSORIES

Order no.	Description	Type
4158000	Stand for holding outside micrometers	41 H
4159400	Setting gage, flat (25 mm)	43 A



41 H

Micromar 40 T

Micrometer with integrated dial comparator

DIN
863-3

FEATURES

- Operating and display units with satin chrome finish
- Retraction of the movable anvil ensures maximum wear resistance
- Constant measuring force
- Stainless spindle is hardened throughout and ground
- Spindle and anvil are carbide-tipped
- Locking device
- **Package contains:** instruction manual, case



Application:

- Quick check of diameter of cylindrical parts (shafts, bolts, shanks)
- Thickness and length measurements
- Particularly suitable for exact series components

TECHNICAL DATA

Order no.		4154000	4154001	4154002	4154003	4154004
Type						40 T
Measuring range	mm	0 – 25	25 – 50	50 – 100	100 – 150	150 – 200
Readings						0.01
Error limit	µm					2
Parallelism deviation	µm					2
Flatness deviation	µm					0.2
Spindle thread pitch	mm					0.5
Measuring force	N	6.5			7.5	
Standard						DIN 863-3
Indicating instrument (included in package)						Millimess 1003
Model contact surface						flat
Measuring range, dial comparator (measuring screw)	µm					± 50
Scale graduation value	µm					1
Error limit G _e	µm					1

Order no.	a	b	c	d	e
	mm	mm	mm	mm	mm
4154000	27	28	4	11	8
4154001	52	40	4	11	8
4154002	76	65	5.5	30	8
4154003	127	87	5.5	30	8
4154004	177	112	5.5	30	8

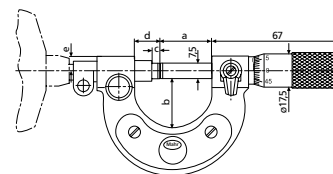

ACCESSORIES

Order no.	Description	Type
4158000	Stand for holding outside micrometers	41 H
4159400	Setting gage, flat (25 mm)	43 A
4159401	Setting gage, flat (50 mm)	43 A
4159402	Setting gage, flat (75 mm)	43 A
4159403	Setting gage, flat (100 mm)	43 A
4159404	Setting gage, flat (125 mm)	43 A
4159405	Setting gage, flat (150 mm)	43 A
4159406	Setting gage, flat (175 mm)	43 A



41 H

Micromar 40 TS

Precision bench micrometer

DIN
863-3

FEATURES

- Operating and display units with satin chrome finish
- Rugged steel frame, can be inclined up to 45° from the sturdy base
- Retraction of the movable anvil ensures maximum wear resistance
- Height adjustable stop
- Constant measuring force
- Stainless spindle is hardened throughout and ground
- Spindle and anvil are carbide-tipped
- Locking device
- **Package contains:** dial comparator 1003 Z, instruction manual

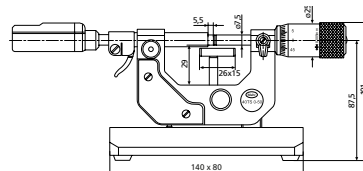

Application:

- Quick check of diameter of cylindrical parts (shafts, bolts, shanks)
- Thickness and length measurements
- Particularly suitable for exact series components

TECHNICAL DATA

Order no.	4154030	4154031
Type		40 TS
Measuring range	mm	0 –50
Readings		0.005
Error limit	µm	2
Parallelism deviation	µm	2
Flatness deviation	µm	0.2
Spindle thread pitch	mm	0.5
Measuring force	N	6.5
Standard		DIN 863–3
Indicating instrument (included in package)	Millimess 1003	Without readout
Model contact surface		flat
Measuring range, dial comparator (measuring screw)	µm	± 50
Scale graduation value	µm	1
Error limit G _e	µm	1

Order no.	4154930	4154931
Type		40 TS
Measuring range	inch	0 –2"
Readings	inch	0.00025
Error limit	inch	0.00008
Spindle pitch	inch	0.025
Measuring force	N	6.5
Indicating instrument (included in package)	Millimess 1003 Z	Without readout
Model contact surface		flat
Measuring range dial comparator (Micrometer screw)	inch	± .0025"
Scale graduation value	inch	0.00005
Error limit G _e	inch	0.00005

ACCESSORIES

Order no.	Description	Type
4335000	Millimess 0.5 µm, ± 25 µm	1002
4334000	Millimess 1 µm, ± 50 µm	1003
4333000	Millimess 5 µm, ± 130 µm	1004
4337624	Digital indicator, 0.0005 mm, 12.5 mm	1086 Ri
4337620	Digital indicator, 0.0005 mm, 12.5 mm	1086 R
4337663	Digital indicator, 0.0005 mm, 12.5 mm	1087 Ri
4337660	Digital indicator, 0.0005 mm, 12.5 mm	1087 R
4154035	Wooden case	
4159400	Setting gage, flat (25 mm)	43 A



1003



1086 Ri



1087 Ri



1087 R

Micromar 40 EWri-V

Digital micrometer



FUNCTIONS

- RESET (set display to zero)
- ABS (display can be set to zero without losing reference to ORIGIN)
- mm/inch
- ORIGIN (for entering a numerical value)
- LOCK function (key lock)
- TOL (Tolerance and Warning Limits Input)
- HOLD (storage of measured values)
- DATA (data transmission)
- Bidirectional data interface (external output and input option of characteristic values as well as setting of individual lock functions by MarCom Software)

FEATURES

- High contrast digital display
- Stainless spindle is hardened throughout and ground
- With mounting bores for measuring anvils with a shaft \varnothing 3.5 mm
- Quick drive
- Sliding spindle
- Ratchet is integrated in the thimble
- Lacquered steel frame, heat insulated
- **Software:** MarCom Professional free download: www.mahr.com/marcom (only for Mahr data cables and wireless systems with USB and RS-232 interface)
- **Digit height:** 10 mm
- **Data interface:** Integrated Wireless
- **Energy supply:** Battery life approx. 3 years (approx. 0.5 in wireless mode)
- **Battery type:** CR 2032 (3V Lithium)
- **IP protection category:** IP 65
- **Package contents:** 1 pair each of the following measuring anvils
 - 40 Ef flat \varnothing 6.5 mm
 - 40 Ea offset \varnothing 2 x 4 mm
 - 40 Et plate \varnothing 11.3 mm
 - 40 Eb spherical R=5 mm
 - 40 Ep tapered 60° \varnothing 0.3 – 5.5 mm
 - 40 Es blade 0.75 x 4 mm
- **Package contains:** instruction manual, battery, case



Applications:

- Universal adjustment to different workpiece and measurement situations using individual interchangeable measuring anvils.
- Thread flanks and spherical measuring anvils (optional accessories) can also be used.

TECHNICAL DATA

Order no.	Type	Measuring range	Measuring range	Resolution	Error limit	Spindle thread pitch	Measuring force	Standard	Model contact surface	Accessories
4157150	40 EWri-V	0–25	0–1"	mm/inch 0.001 / .00005"	μ m 4	mm 5	N 5–10	DIN 863–3	3.5 mm bore	•

Order no.	a	b	c	Mounting hole
4157150	mm 32	mm 11.5	mm 57	For measuring anvils with a shaft diameter 3.5 x 15.5 mm

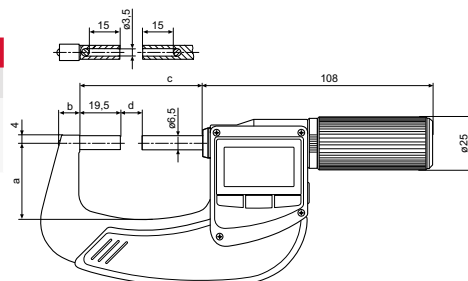

ACCESSORIES

Order no.	Description	Type
4102220	Receiver for instruments with Integrated Wireless	i-Stick
4151794	Plane measuring anvil (6.5 mm)	40 Ef
4151795	Measuring anvil with reduced measuring surface (2.3 x 2 mm)	40 Ea
4151796	Measuring anvil plate (11.3 mm)	40 Et
4151797	Measuring anvil with convex measuring surface (6.5 mm)	40 Er
4151798	Measuring anvil with tip (60°)	40 Ep
4151799	Measuring anvil with blade (0.45 mm x 4)	40 Es
4158000	Stand for holding outside micrometers	41 H
4173210	Anvil flat, hardened steel, \varnothing 7.5 mm	40 Za
4511190	Anvil flat, carbide tipped, \varnothing 7.5 mm	40 Za

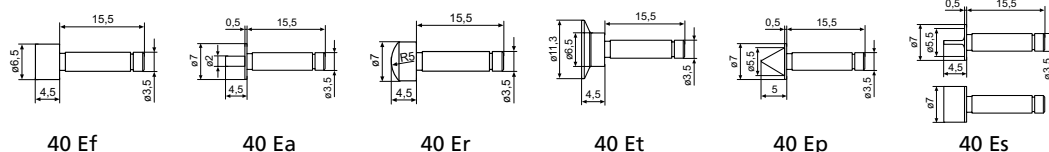

41 H

i-Stick

Micromar | Micrometers

Micromar 40 EWR-V

Digital micrometer



FUNCTIONS

- RESET (set display to zero)
- ABS (display can be set to zero without losing reference to ORIGIN)
- mm/inch
- ORIGIN (for entering a numerical value)
- LOCK function (key lock)
- TOL (Tolerance and Warning Limits Input)
- HOLD (storage of measured values)
- DATA (data transmission)
- Bidirectional data interface (external output and input option of characteristic values as well as setting of individual lock functions by MarCom Software)

FEATURES

- High contrast digital display
- Stainless spindle is hardened throughout and ground
- With mounting bores for measuring anvils with a shaft \varnothing 3.5 mm
- Quick drive
- Sliding spindle
- Ratchet is integrated in the thimble
- Lacquered steel frame, heat insulated
- **Software:** MarCom Professional free download: www.mahr.com/marcom (only for Mahr data cables and wireless systems with USB and RS-232 interface)
- **Digit height:** 10 mm
- **Data interface:** MarConnect (bidirectional), USB, Digimatic
- **Energy supply:** Battery life approx. 3 years
- **Battery type:** CR 2032 (3V Lithium)
- **IP protection category:** IP 65
- **Package contents:** 1 pair each of the following measuring anvils:
 - 40 Ef flat \varnothing 6.5 mm
 - 40 Ea offset 2×4 mm
 - 40 Et plate \varnothing 11.3 mm
 - 40 Eb spherical $R=5$ mm
 - 40 Ep tapered $60^\circ \varnothing 0.3 - 5.5$ mm
 - 40 Es blade 0.75×4 mm
- **Package contains:** instruction manual, battery, case



Applications:

- Universal adjustment to different workpiece and measurement situations using individual interchangeable measuring anvils.
- Thread flanks and spherical measuring anvils (optional accessories) can also be used.

TECHNICAL DATA

Order no.	Type	Measuring range	Measuring range	Resolution	Error limit	Spindle thread pitch	Measuring force	Standard	Model contact surface	Accessories
		mm	inch	mm/inch	μ m	mm	N			
4157050	40 EWR-V	0-25	0-1"	0.001 / .00005"	4	5	5-10	DIN 863-3	3.5 mm bore	•

Order no.	a	b	c	Mounting hole
	mm	mm	mm	
4157050	32	11.5	57	For measuring anvils with a shaft diameter 3.5 x 15.5 mm

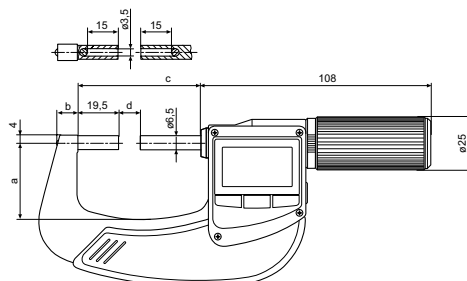

ACCESSORIES

Order no.	Description	Type
4102603	Data cable USB bidirectional (2 m)	DK-U1
4102606	Interface adapter with data cable Digimatic (2 m)	DK-D1
4151794	Plane measuring anvil (6.5 mm)	40 Ef
4151795	Measuring anvil with reduced measuring surface (2.3 x 2 mm)	40 Ea
4151796	Measuring anvil plate (11.3 mm)	40 Et
4151797	Measuring anvil with convex measuring surface (6.5 mm)	40 Er
4151798	Measuring anvil with tip (60°)	40 Ep
4151799	Measuring anvil with blade (0.45 mm x 4)	40 Es
4158000	Stand for holding outside micrometers	41 H
4173210	Anvil flat, hardened steel, \varnothing 7.5 mm	40 Za
4511190	Anvil flat, carbide tipped, \varnothing 7.5 mm	40 Za

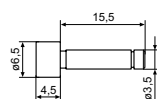

40 Ef

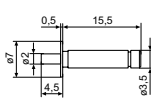

40 Ea

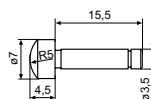

40 Er

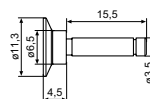

40 Et

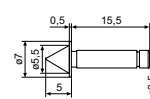

40 Ep

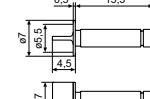

40 Es



41 H



i-Stick

Micromar 40 EWri-V

Digital micrometer



FUNCTIONS

- RESET (set display to zero)
- ABS (display can be set to zero without losing reference to ORIGIN)
- mm/inch
- ORIGIN (for entering a numerical value)
- LOCK function (key lock)
- TOL (Tolerance and Warning Limits Input)
- HOLD (storage of measured values)
- DATA (data transmission)
- Bidirectional data interface (external output and input option of characteristic values as well as setting of individual lock functions by MarCom Software)



Application:

- For measuring thread flanks and gear diameters using quick-change measuring anvils.



FEATURES

- With mounting bores for measuring anvils with a shaft \varnothing 3.5 mm
- High contrast digital display
- Stainless spindle is hardened throughout and ground
- Quick drive
- Sliding spindle
- Ratchet is integrated in the thimble
- Lacquered steel frame, heat insulated
- **Software:** MarCom Professional free download: www.mahr.com/marcom (only for Mahr data cables and wireless systems with USB and RS-232 interface)
- **Digit height:** 10 mm
- **Data interface:** Integrated Wireless
- **Energy supply:** Battery life approx. 2 years
- **Battery type:** CR 2032 (3V Lithium)
- **IP protection category:** IP 65
- **Package contains:** instruction manual, battery, case

TECHNICAL DATA

Order no.	Type	Measuring range	Measuring range	Resolution	Error limit	Spindle thread pitch	Measuring force	Standard	Model contact surface
		mm	inch	mm/inch	μ m	mm	N		
4157145	40 EWri-V	0 – 25	0 – 1"	0.001 / .00005"	4	5	5 – 10	DIN 863–3	3.5 mm bore
4157146	40 EWri-V	25 – 50	1 – 2"	0.001 / .00005"	4	5	5 – 10	DIN 863–3	3.5 mm bore
4157147	40 EWri-V	50 – 75	2 – 3"	0.001 / .00005"	5	5	5 – 10	DIN 863–3	3.5 mm bore
4157148	40 EWri-V	75 – 100	3 – 4"	0.001 / .00005"	5	5	5 – 10	DIN 863–3	3.5 mm bore

Order no.	a	b	c	Mounting hole
	mm	mm	mm	
4157145	32	11.5	57	For measuring anvils with a shaft diameter 3.5 x 15.5 mm
4157146	44	13.5	82	For measuring anvils with a shaft diameter 3.5 x 15.5 mm
4157147	57	15.5	107	For measuring anvils with a shaft diameter 3.5 x 15.5 mm
4157148	73	17	132.5	For measuring anvils with a shaft diameter 3.5 x 15.5 mm

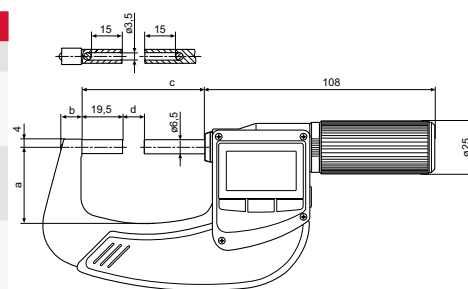

ACCESSORIES

Order no.	Description	Type
4102220	Receiver for instruments with Integrated Wireless	i-Stick
4158000	Stand for holding outside micrometers	41 H
4173210	Anvil flat, hardened steel, \varnothing 7.5 mm	40 Za
4511190	Anvil flat, carbide tipped, \varnothing 7.5 mm	40 Za



41 H



i-Stick

Micromar 40 EWR-V

Digital micrometer



FUNCTIONS

- RESET (set display to zero)
- ABS (display can be set to zero without losing reference to ORIGIN)
- mm/inch
- ORIGIN (for entering a numerical value)
- LOCK function (key lock)
- TOL (Tolerance and Warning Limits Input)
- HOLD (storage of measured values)
- DATA (data transmission)
- Bidirectional data interface (external output and input option of characteristic values as well as setting of individual lock functions by MarCom Software)



Application:

- For measuring thread flanks and gear diameters using quick-change measuring anvils.



FEATURES

- With mounting bores for measuring anvils with a shaft \varnothing 3.5 mm
- High contrast digital display
- Stainless spindle is hardened throughout and ground
- Quick drive
- Sliding spindle
- Ratchet is integrated in the thimble
- Lacquered steel frame, heat insulated
- **Software:** MarCom Professional free download: www.mahr.com/marcom (only for Mahr data cables and wireless systems with USB and RS-232 interface)
- **Digit height:** 10 mm
- **Data interface:** MarConnect (bidirectional), USB, Digimatic
- **Energy supply:** Battery life approx. 2 years
- **Battery type:** CR 2032 (3V Lithium)
- **IP protection category:** IP 65
- **Package contains:** instruction manual, battery, case

TECHNICAL DATA

Order no.	Type	Measuring range	Measuring range	Resolution	Error limit	Spindle thread pitch	Measuring force	Standard	Model contact surface
		mm	inch	mm/inch	μm	mm	N		
4157045	40 EWR-V	0–25	0–1"	0.001 / .00005"	4	5	5–10	DIN 863–3	3.5 mm bore
4157046	40 EWR-V	25–50	1–2"	0.001 / .00005"	4	5	5–10	DIN 863–3	3.5 mm bore
4157047	40 EWR-V	50–75	2–3"	0.001 / .00005"	5	5	5–10	DIN 863–3	3.5 mm bore
4157048	40 EWR-V	75–100	3–4"	0.001 / .00005"	5	5	5–10	DIN 863–3	3.5 mm bore

Order no.	a	b	c	Mounting hole
	mm	mm	mm	
4157045	32	11.5	57	For measuring anvils with a shaft diameter 3.5 x 15.5 mm
4157046	44	13.5	82	For measuring anvils with a shaft diameter 3.5 x 15.5 mm
4157047	57	15.5	107	For measuring anvils with a shaft diameter 3.5 x 15.5 mm
4157048	73	17	132.5	For measuring anvils with a shaft diameter 3.5 x 15.5 mm

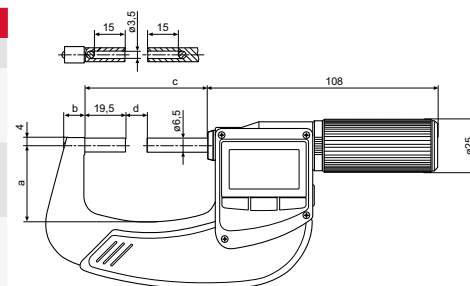

ACCESSORIES

Order no.	Description	Type
4102603	Data cable USB bidirectional (2 m)	DK-U1
4102606	Interface adapter with data cable Digimatic (2 m)	DK-D1
4158000	Stand for holding outside micrometers	41 H
4173210	Anvil flat, hardened steel, \varnothing 7.5 mm	40 Za
4511190	Anvil flat, carbide tipped, \varnothing 7.5 mm	40 Za



41 H

Micromar tfhread anvils

Digital micrometer

FEATURES

- Wear-resistant special steel, hardened. With cylindrical mounting shank and retainer ring for rotatable mounting in the bore of the measuring spindle and anvil.
- Pair comprises V-anvil and cone.
- With a pitch of 0.2 – 0.45 mm, the V-anvil bridges 3 turns. It should therefore be set with 715 E thread adjustment pins, otherwise with 43 Z setting standards.

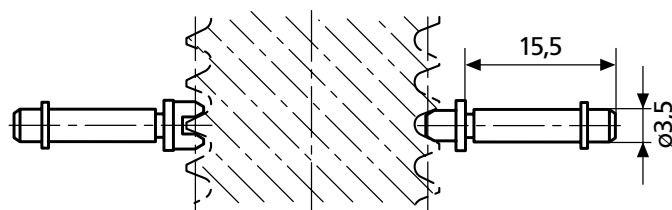

Thread pitch	Taper Order no.	V-anvil Order no.
Pitch diameter, external thread Metric 60°		
0.2	4173407	4173007
0.25	4173408	4173008
0,3	4173409	4173009
0.35	4173410	4173010
0.4	4173411	4173011
0.45	4173412	4173012
0.5 – 0.7	4173400	4173000
0.7 – 1	4173401	4173001
1.25 – 2	4173402	4173002
2 – 3.5	4173403	4173003
3.5 – 5	4173404	4173004
5 – 7	4173405	4173005
7 – 9	4173406	4173006
Trapezoid 30°		
1	4173650	4173250
1.5	4173651	4173251
2	4173652	4173252
3	4173653	4173253
4	4173654	4173254
5	4173655	4173255
6	4173656	4173256
7	4173657	4173257
8	4173658	4173258
9	4173659	4173259
10	4173660	4173260
12	4173661	4173261
14	4173662	4173262
16	4173663	4173263
18	4173664	4173264
20	4173665	4173265

Thread pitch in TPI	Taper Order no.	V-anvil Order no.
Pitch diameter, external thread UST 60°		
60 – 48	4173513	4173113
48 – 40	4173514	4173114
40 – 32	4173515	4173115
32 – 24	4173516	4173116
24 – 18	4173517	4173117
18 – 14	4173518	4173118
14 – 10	4173519	4173119
10 – 7	4173520	4173120
7 – 4.5	4173521	4173121
4.5 – 3	4173522	4173122
Whitworth 55°		
40 – 32	4173443	4173043
32 – 24	4173444	4173044
24 – 18	4173445	4173045
18 – 14	4173446	4173046
14 – 10	4173447	4173047
10 – 7	4173448	4173048
7 – 4.5	4173449	4173049
4.5 – 3	4173450	4173050
3 – 2.5	4179409	4179408

Micromar

Ball contact

FEATURES

- For gear measurement and for special tasks
- Carbide measuring balls
- Cylindrical mounting shank with circlip for mounting in the mounting bore of the micrometer or indicating snap gage

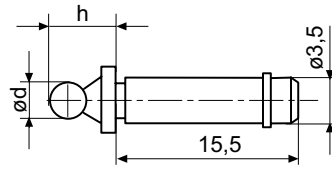

Order no.	d mm	h mm	Order no.	d mm	h mm	Order no.	d mm	h mm
4179150	0.5	5	4179169	1.7	6.2	4170570	3.2	7.7
4179151	0.551	5.1	4170553	1.75	6.3	4170566	3.25	7.8
4179152	0.62	5.1	4179170	1.782	6.3	4179183	3.4	7.9
4179153	0.623	5.1	4179171	1.8	6.3	4170558	3.5	8
4179154	0.63	5.1	4179172	1.829	6.3	4179184	3.658	8.2
4179155	0.722	5.2	4179173	1.9	6.4	4170571	3.7	8.2
4179156	0.862	5.4	4170554	2	6.5	4170559	4	8.5
4179157	0.895	5.4	4170568	2.032	6.5	4170560	4.5	9
4179158	0.965	5.5	4170569	2.2	6.7	4179185	4.835	9.3
4170550	1	5.5	4170564	2.25	6.8	4170561	5	9.5
4179159	1.1	5.6	4179174	2.284	6.8	4179186	5.25	9.8
4179160	1.118	5.6	4179175	2.386	6.9	4179187	5.486	10
4170551	1.25	5.8	4179176	2.438	6.9	4170562	5.5	10
4179161	1.125	5.6	4170556	2.5	7	4170563	6	10.5
4179162	1.35	5.9	4179177	2.667	7.2	4179188	6.096	10.6
4179163	1.372	5.9	4179178	2.704	7.2	4179189	6.35	10.9
4179164	1.385	5.9	4179179	2.713	7.2	4170567	6.5	11
4170552	1.5	6	4179180	2.721	7.2	4170572	7	11.5
4179165	1.524	6	4179181	2.743	7.2	4170573	8	12.5
4179166	1.54	6	4170565	2.75	7.3	4170574	9	13.5
4179167	1.6	6.1	4170557	3	7.5	4170575	10	14.5
4179168	1.65	6.2	4179182	3.048	7.5			

Micromar

Carbide roller blades

FEATURES

- For gear measurement and for special tasks
- Carbide contact roller
- Cylindrical mounting shank with circlip for mounting in the mounting bore of the micrometer or indicating snap gage

Order no.	b mm	d mm	h mm
4510200	5	1	5.5
4510201	5	1.25	5.8
4510202	5	1.5	6
4510203	5	1.75	6.3
4510204	5	2	6.5
4510206	5.5	2.5	7
4510207	5.5	3	7.5
4510208	5.5	3.5	8
4510209	5.5	4	8.5
4510210	5.5	4.5	9
4510211	6	5	9.5
4510212	6	5.5	10
4510213	6	6	10.5

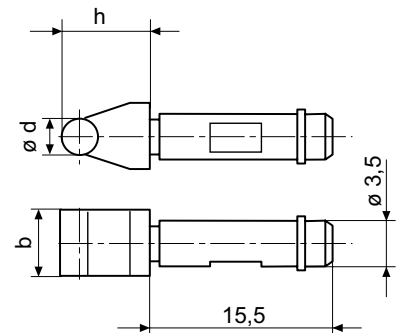

Micromar 40 EWRI-S

Digital micrometer



FUNCTIONS

- RESET (set display to zero)
- ABS (display can be set to zero without losing reference to ORIGIN)
- mm/inch
- ORIGIN (for entering a numerical value)
- LOCK function (key lock)
- TOL (Tolerance and Warning Limits Input)
- HOLD (storage of measured values)
- DATA (data transmission)
- Bidirectional data interface (external output and input option of characteristic values as well as setting of individual lock functions by MarCom Software)

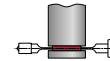
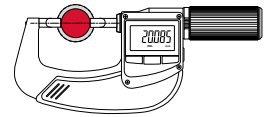

Application:

- For measuring recesses, grooves, etc.

FEATURES

- With blade-type measuring surfaces
- High contrast digital display
- Stainless spindle is hardened throughout and ground
- Quick drive
- Sliding spindle
- Ratchet is integrated in the thimble
- Lacquered steel frame, heat insulated
- **Software:** MarCom Professional free download: www.mahr.com/marcom (only for Mahr data cables and wireless systems with USB and RS-232 interface)
- **Digit height:** 10 mm
- **Data interface:** Integrated Wireless
- **Energy supply:** Battery life approx. 2 years
- **Battery type:** CR 2032 (3V Lithium)
- **IP protection category:** IP 65
- **Package contains:** instruction manual, battery, setting standard (measuring range of 25–50 mm), case

TECHNICAL DATA

Order no.	Type	Measuring range		Measuring surface	Resolution	Error limit	Spindle thread pitch	Measuring force	Standard	Model contact surface
		mm	inch							
4157141	40 EWRI-S	0–25	0–1"	hardened steel	0.001 / .00005"	4	5	5–10	DIN 863–3	Blade
4157142	40 EWRI-S	25–50	1–2"	hardened steel	0.001 / .00005"	4	5	5–10	DIN 863–3	Blade
4157143	40 EWRI-S	50–75	2–3"	hardened steel	0.001 / .00005"	5	5	5–10	DIN 863–3	Blade
4157144	40 EWRI-S	75–100	3–4"	hardened steel	0.001 / .00005"	5	5	5–10	DIN 863–3	Blade

Order no.	a	b	c
	mm	mm	mm
4157141	32	11.5	57
4157142	44	13.5	82
4157143	57	15.5	107
4157144	73	17	132.5

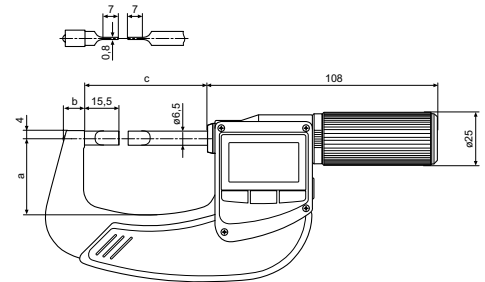

ACCESSORIES

Order no.	Description	Type
4102220	Receiver for instruments with Integrated Wireless	i-Stick
4158000	Stand for holding outside micrometers	41 H



41 H



i-Stick

Micromar 40 EWR-S

Digital micrometer



FUNCTIONS

- RESET (set display to zero)
- ABS (display can be set to zero without losing reference to ORIGIN)
- mm/inch
- ORIGIN (for entering a numerical value)
- LOCK function (key lock)
- TOL (Tolerance and Warning Limits Input)
- HOLD (storage of measured values)
- DATA (data transmission)
- Bidirectional data interface (external output and input option of characteristic values as well as setting of individual lock functions by MarCom Software)

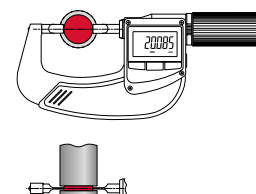

Application:

- For measuring recesses, grooves, etc.

FEATURES

- With blade-type measuring surfaces
- High contrast digital display
- Stainless spindle is hardened throughout and ground
- Quick drive
- Sliding spindle
- Ratchet is integrated in the thimble
- Lacquered steel frame, heat insulated
- **Software:** MarCom Professional free download: www.mahr.com/marcom (only for Mahr data cables and wireless systems with USB and RS-232 interface)
- **Digit height:** 10 mm
- **Data interface:** MarConnect (bidirectional), USB, Digimatic
- **Energy supply:** Battery life approx. 2 years
- **Battery type:** CR 2032 (3V Lithium)
- **IP protection category:** IP 65
- **Package contains:** instruction manual, battery, setting standard (measuring range of 25–50 mm), case

TECHNICAL DATA

Order no.	Type	Measuring range		Measuring surface	Resolution	Error limit	Spindle thread pitch	Measuring force	Standard	Model contact surface
		mm	inch							
4157041	40 EWR-S	0–25	0–1"	hardened steel	0.001 / .00005"	4	5	5–10	DIN 863–3	Blade
4157042	40 EWR-S	25–50	1–2"	hardened steel	0.001 / .00005"	4	5	5–10	DIN 863–3	Blade
4157043	40 EWR-S	50–75	2–3"	hardened steel	0.001 / .00005"	5	5	5–10	DIN 863–3	Blade
4157044	40 EWR-S	75–100	3–4"	hardened steel	0.001 / .00005"	5	5	5–10	DIN 863–3	Blade

Order no.	a	b	c
	mm	mm	mm
4157041	32	11.5	57
4157042	44	13.5	82
4157043	57	15.5	107
4157044	73	17	132.5

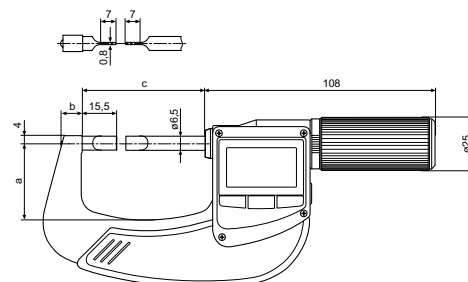

ACCESSORIES

Order no.	Description	Type
4102603	Data cable USB bidirectional (2 m)	DK-U1
4102606	Interface adapter with data cable Digimatic (2 m)	DK-D1
4158000	Stand for holding outside micrometers	41 H



41 H

Micromar 40 EWRI-B

Digital micrometer



FUNCTIONS

- RESET (set display to zero)
- ABS (display can be set to zero without losing reference to ORIGIN)
- mm/inch
- ORIGIN (for entering a numerical value)
- LOCK function (key lock)
- TOL (Tolerance and Warning Limits Input)
- HOLD (storage of measured values)
- DATA (data transmission)
- Bidirectional data interface (external output and input option of characteristic values as well as setting of individual lock functions by MarCom Software)



Application:

- For measuring grooves, spline shafts, recesses, etc.

FEATURES

- Reduced measuring surfaces \varnothing 3 mm
- High contrast digital display
- Stainless spindle is hardened throughout and ground
- Spindle and anvil are carbide-tipped
- Rapid drive
- Ratchet is integrated in the thimble
- Lacquered steel frame, heat insulated
- **Software:** MarCom Professional free download: www.mahr.com/marcom (only for Mahr data cables and wireless systems with USB and RS-232 interface)
- **Digit height:** 10 mm
- **Data interface:** Integrated Wireless
- **Energy supply:** Battery life approx. 2 years
- **Battery type:** CR 2032 (3V Lithium)
- **IP protection category:** IP 65
- **Package contains:** instruction manual, battery, setting standard (measuring range of 25–50 mm), case

TECHNICAL DATA

Order no.	Type	Measuring range	Measuring range	Measuring surface	Resolution	Error limit	Spindle thread pitch	Measuring force	Standard	Model contact surface
		mm	inch		mm/inch	μm	mm	N		
4157132	40 EWRI-B	0–25	0–1"	carbide	0.001 / .00005"	4	0.5	5–10	DIN 863–3	flat, reduced
4157133	40 EWRI-B	25–50	1–2"	carbide	0.001 / .00005"	4	0.5	5–10	DIN 863–3	flat, reduced

Order no.	a	b	c
	mm	mm	mm
4157132	32	11.5	57
4157133	44	13.5	82

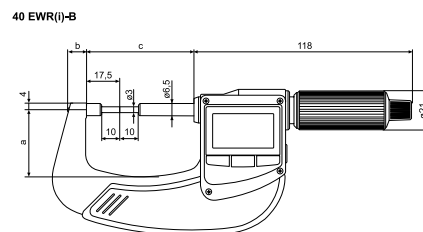

ACCESSORIES

Order no.	Description	Type
4102220	Receiver for instruments with Integrated Wireless	i-Stick
4158000	Stand for holding outside micrometers	41 H



41 H



i-Stick

Micromar 40 EWR-B

Digital micrometer



FUNCTIONS

- RESET (set display to zero)
- ABS (display can be set to zero without losing reference to ORIGIN)
- mm/inch
- ORIGIN (for entering a numerical value)
- LOCK function (key lock)
- TOL (Tolerance and Warning Limits Input)
- HOLD (storage of measured values)
- DATA (data transmission)
- Bidirectional data interface (external output and input option of characteristic values as well as setting of individual lock functions by MarCom Software)

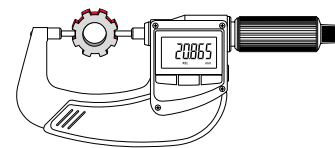

Application:

- For measuring grooves, spline shafts, recesses, etc.

FEATURES

- **Reduced measuring surfaces** Ø 3 mm
- High contrast digital display
- Stainless spindle is hardened throughout and ground
- Spindle and anvil are carbide-tipped
- Rapid drive
- Ratchet is integrated in the thimble
- Lacquered steel frame, heat insulated
- **Software:** MarCom Professional free download: www.mahr.com/marcom (only for Mahr data cables and wireless systems with USB and RS-232 interface)
- **Digit height:** 10 mm
- **Data interface:** MarConnect (bidirectional), USB, Digimatic
- **Energy supply:** Battery life approx. 2 years
- **Battery type:** CR 2032 (3V Lithium)
- **IP protection category:** IP 65
- **Package contains:** instruction manual, battery, setting standard (measuring range of 25–50 mm), case

TECHNICAL DATA

Order no.	Type	Measuring range	Measuring range	Measuring surface	Resolution	Error limit	Spindle thread pitch	Measuring force	Standard	Model contact surface
		mm	inch		mm/inch	µm	mm	N		
4157032	40 EWR-B	0–25	0–1"	carbide	0.001 / .00005"	4	0.5	5–10	DIN 863–3	flat, reduced
4157033	40 EWR-B	25–50	1–2"	carbide	0.001 / .00005"	4	0.5	5–10	DIN 863–3	flat, reduced

Order no.	a	b	c
	mm	mm	mm
4157032	32	11.5	57
4157033	44	13.5	82

40 EWR(i)-B

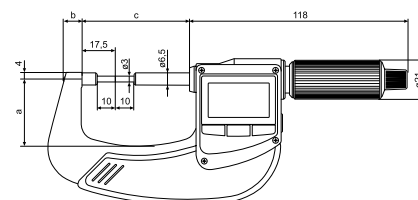

ACCESSORIES

Order no.	Description	Type
4102603	Data cable USB bidirectional (2 m)	DK-U1
4102606	Interface adapter with data cable Digimatic (2 m)	DK-D1
4158000	Stand for holding outside micrometers	41 H



41 H

Micromar 40 EWRI-R

Digital micrometer



FUNCTIONS

- RESET (set display to zero)
- ABS (display can be set to zero without losing reference to ORIGIN)
- mm/inch
- ORIGIN (for entering a numerical value)
- LOCK function (key lock)
- TOL (Tolerance and Warning Limits Input)
- HOLD (storage of measured values)
- DATA (data transmission)
- Bidirectional data interface (external output and input option of characteristic values as well as setting of individual lock functions by MarCom Software)



Application:

- For measuring the thickness of pipe walls

FEATURES

- Measuring surfaces: spherical anvil, planar spindle
- High contrast digital display
- Stainless spindle is hardened throughout and ground
- Spindle and anvil are carbide-tipped
- Rapid drive
- Ratchet is integrated in the thimble
- Lacquered steel frame, heat insulated
- **Software:** MarCom Professional free download: www.mahr.com/marcom (only for Mahr data cables and wireless systems with USB and RS-232 interface)
- **Digit height:** 10 mm
- **Data interface:** Integrated Wireless
- **Energy supply:** Battery life approx. 2 years
- **Battery type:** CR 2032 (3V Lithium)
- **IP protection category:** IP 65
- **Package contains:** instruction manual, battery, setting standard (measuring range of 25–50 mm), case

TECHNICAL DATA

Order no.	Type	Measuring range	Measuring range	Measuring surface	Resolution	Error limit	Spindle thread pitch	Measuring force	Standard	Model contact surface
		mm	inch		mm/inch	µm	mm	N		
4157130	40 EWRI-R	0–25	0–1"	carbide	0.001 / .00005"	4	0.5	5–10	DIN 863–3	flat, spherical
4157131	40 EWRI-R	25–50	1–2"	carbide	0.001 / .00005"	4	0.5	5–10	DIN 863–3	flat, spherical

Order no.	a	b	c
	mm	mm	mm
4157130	23	9.5	31.5
4157131	32	11.5	57

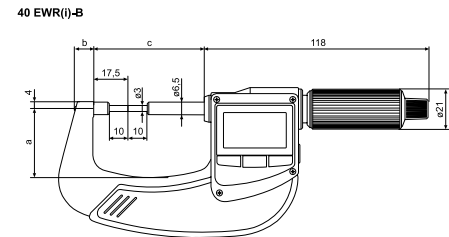

ACCESSORIES

Order no.	Description	Type
4102220	Receiver for instruments with Integrated Wireless	i-Stick
4158000	Stand for holding outside micrometers	41 H



41 H



i-Stick

Micromar 40 EWR-R

Digital micrometer



FUNCTIONS

- RESET (set display to zero)
- ABS (display can be set to zero without losing reference to ORIGIN)
- mm/inch
- ORIGIN (for entering a numerical value)
- LOCK function (key lock)
- TOL (Tolerance and Warning Limits Input)
- HOLD (storage of measured values)
- DATA (data transmission)
- Bidirectional data interface (external output and input option of characteristic values as well as setting of individual lock functions by MarCom Software)

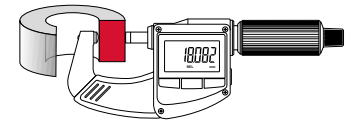

Application:

- For measuring the thickness of pipe walls

FEATURES

- Measuring surfaces: spherical anvil, planar spindle
- High contrast digital display
- Stainless spindle is hardened throughout and ground
- Spindle and anvil are carbide-tipped
- Rapid drive
- Ratchet is integrated in the thimble
- Lacquered steel frame, heat insulated
- **Software:** MarCom Professional free download: www.mahr.com/marcom (only for Mahr data cables and wireless systems with USB and RS-232 interface)
- **Digit height:** 10 mm
- **Data interface:** MarConnect (bidirectional), USB, Digimatic
- **Energy supply:** Battery life approx. 2 years
- **Battery type:** CR 2032 (3V Lithium)
- **IP protection category:** IP 65
- **Package contains:** instruction manual, battery, setting standard (measuring range of 25–50 mm), case

TECHNICAL DATA

Order no.	Type	Measuring range	Measuring range	Measuring surface	Resolution	Error limit	Spindle thread pitch	Measuring force	Standard	Model contact surface
4157030	40 EWR-R	0–25	0–1"	carbide	0.001 / .00005"	4	0.5	5–10	DIN 863–3	flat, spherical
4157031	40 EWR-R	25–50	1–2"	carbide	0.001 / .00005"	4	0.5	5–10	DIN 863–3	flat, spherical

Order no.	a	b	c
	mm	mm	mm
4157030	23	9.5	31.5
4157031	32	11.5	57

40 EWR(i)-B

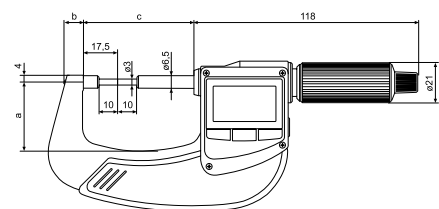

ACCESSORIES

Order no.	Description	Type
4102603	Data cable USB bidirectional (2 m)	DK-U1
4102606	Interface adapter with data cable Digimatic (2 m)	DK-D1
4158000	Stand for holding outside micrometers	41 H



41 H

Micromar 40 EWRI-K

Digital micrometer



FUNCTIONS

- RESET (set display to zero)
- ABS (display can be set to zero without losing reference to ORIGIN)
- mm/inch
- ORIGIN (for entering a numerical value)
- LOCK function (key lock)
- TOL (Tolerance and Warning Limits Input)
- HOLD (storage of measured values)
- DATA (data transmission)
- Bidirectional data interface (external output and input option of characteristic values as well as setting of individual lock functions by MarCom Software)

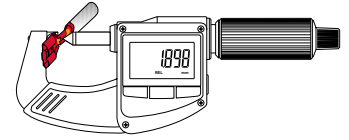

Application:

- For measuring crimp heights

FEATURES

- Measuring surfaces: anvil with narrow web, pointed spindle
- High contrast digital display
- Stainless spindle is hardened throughout and ground
- Spindle and anvil are carbide-tipped
- Rapid drive
- Ratchet is integrated in the thimble
- Lacquered steel frame, heat insulated
- **Software:** MarCom Professional free download: www.mahr.com/marcom (only for Mahr data cables and wireless systems with USB and RS-232 interface)
- **Digit height:** 10 mm
- **Data interface:** Integrated Wireless
- **Energy supply:** Battery life approx. 2 years
- **Battery type:** CR 2032 (3V Lithium)
- **IP protection category:** IP 65
- **Package contains:** instruction manual, battery, case

TECHNICAL DATA

Order no.	Type	Measuring range	Measuring range	Measuring surface	Resolution	Error limit	Spindle thread pitch	Measuring force	Standard	Model contact surface
4157140	40 EWRI-K	0–20	0–0.8"	carbide	mm/inch 0.001 / .00005"	μm 4	mm 0.5	N 5–10	Factory standard	Blade, taper

Order no.	a	b	c
4157140	mm 23	mm 9.5	mm 31.5

40 EWR(i)-K

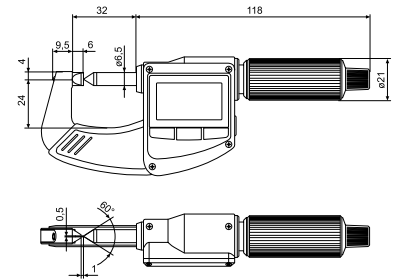

ACCESSORIES

Order no.	Description	Type
4102220	Receiver for instruments with Integrated Wireless	i-Stick
4158000	Stand for holding outside micrometers	41 H



41 H



i-Stick

Micromar 40 EWR-K

Digital micrometer



FUNCTIONS

- RESET (set display to zero)
- ABS (display can be set to zero without losing reference to ORIGIN)
- mm/inch
- ORIGIN (for entering a numerical value)
- LOCK function (key lock)
- TOL (Tolerance and Warning Limits Input)
- HOLD (storage of measured values)
- DATA (data transmission)
- Bidirectional data interface (external output and input option of characteristic values as well as setting of individual lock functions by MarCom Software)

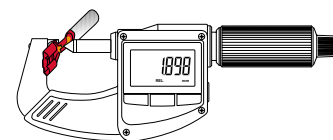

Application:

- For measuring crimp heights on crimp contacts and end splices

FEATURES

- Measuring surfaces: anvil with narrow web, pointed spindle
- High contrast digital display
- Stainless spindle is hardened throughout and ground
- Spindle and anvil are carbide-tipped
- Rapid drive
- Ratchet is integrated in the thimble
- Lacquered steel frame, heat insulated
- **Software:** MarCom Professional free download: www.mahr.com/marcom (only for Mahr data cables and wireless systems with USB and RS-232 interface)
- **Digit height:** 10 mm
- **Data interface:** MarConnect (bidirectional), USB, Digimatic
- **Energy supply:** Battery life approx. 2 years
- **Battery type:** CR 2032 (3V Lithium)
- **IP protection category:** IP 65
- **Package contains:** instruction manual, battery, case

TECHNICAL DATA

Order no.	Type	Measuring range	Measuring range	Measuring surface	Resolution	Error limit	Spindle thread pitch	Measuring force	Standard	Model contact surface
		mm	inch		mm/inch	μm	mm	N		
4157040	40 EWR-K	0–20	0–0.8"	carbide	0.001 / .00005"	4	0.5	5–10	Factory standard	Blade, taper

Order no.	a	b	c
	mm	mm	mm
4157040	23	9.5	31.5

40 EWR(i)-K

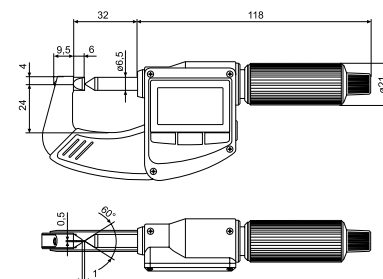

ACCESSORIES

Order no.	Description	Type
4102603	Data cable USB bidirectional (2 m)	DK-U1
4102606	Interface adapter with data cable Digimatic (2 m)	DK-D1
4158000	Stand for holding outside micrometers	41 H



41 H

FEATURES

- Operating and display units with satin chrome finish
- Rigid, lightweight tubular construction
- Stainless spindle is hardened throughout and ground
- Measuring faces spherically lapped, one measuring face adjustable
- Measuring range of 100–125 mm with heat insulators and a locking device
- Package contains: case



TECHNICAL DATA

Order no.	Type	Measuring range	Readings	Error limit	Spindle thread pitch	Standard
		mm		µm	mm	
4163000	44 F	30–40	0.01	4	0.5	DIN 863-4
4163001	44 F	40–50	0.01	4	0.5	DIN 863-4
4163002	44 F	50–70	0.01	5	0.5	DIN 863-4
4163003	44 F	70–100	0.01	5	0.5	DIN 863-4
4163004	44 F	100–125	0.01	6	0.5	DIN 863-4
4163005	44 F	125–150	0.01	6	0.5	DIN 863-4
4163006	44 F	150–175	0.01	7	0.5	DIN 863-4
4163007	44 F	175–200	0.01	7	0.5	DIN 863-4

Order no.	a	b	c	d	e
	mm	mm	mm	mm	mm
4163000	7	12.5	2	4	12.6
4163001	7	12.5	2.5	4.5	12.6
4163002	7	13.5	2.5	4.5	13.6
4163003	7	13.5	4.5	4.5	14
4163004	8	20	4.5	4.5	20
4163005	8	20	8	8	20
4163006	8	20	8	8	20
4163007	8	20	8	8	20

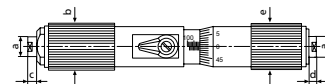

ACCESSORIES

Order no.	Description	Type
4710050	Ring gage DIN 2250 C, Ø 30 mm	355 E
4710060	Ring gage DIN 2250 C, Ø 40 mm	355 E
4710070	Ring gage DIN 2250 C, Ø 50 mm	355 E
4710090	Ring gage DIN 2250 C, Ø 70 mm	355 E
4710120	Ring gage DIN 2250 C, Ø 100 mm	355 E
4710121	Ring gage DIN 2250 C, Ø 125 mm	355 E
4710122	Ring gage DIN 2250 C, Ø 175 mm	355 E



355 E

Measuring head

FEATURES

- Operating and display units with satin chrome finish
- Rigid, lightweight tubular construction
- Stainless spindle is hardened throughout and ground
- Locking device
- Carbide tipped spherical measuring faces
- Interchangeable extension 44 Cv contains cylindrical gage rods that are spring mounted in protective sleeves for the extension of the measuring range
- Protection sleeves have a satin chrome finish
- **Package contents:** Measuring head 44 Cm, measuring range of 100–150 mm with extensions 44 Cv, case

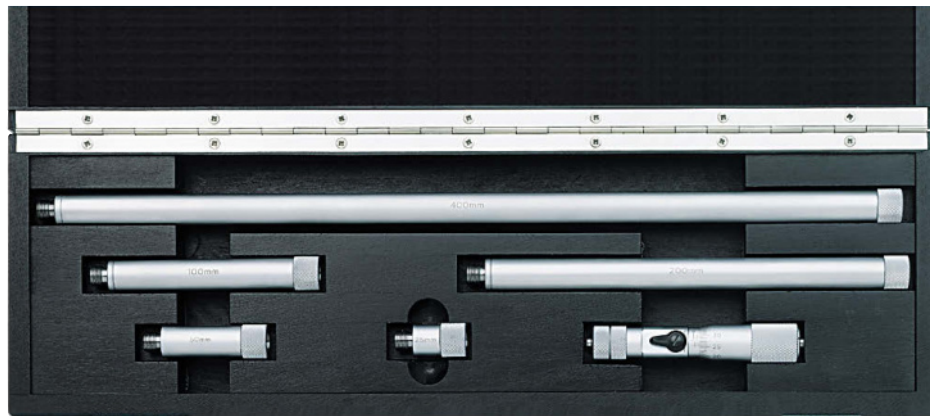

Application:

- For measuring large inside diameters

TECHNICAL DATA

Order no.	Type	Measuring range	Readings	Extensions 44 Cv	Error limit	Error limit	Spindle thread pitch	Standard
		mm			µm	µm	mm	
4168001	44 Cm	100–125	0.01		6	Manufacturing tolerance of extensions 44 CV: ISO 286 js2	0.5	DIN 863–4
4168020	44 Cms 1	100–150	0.01	25 mm			0.5	DIN 863–4
4168021	44 Cms 2	100–300	0.01	25 mm			0.5	DIN 863–4
4168022	44 Cms 3	100–500	0.01	50 / 100 mm 25 / 50 mm 100 / 200 mm			0.5	DIN 863–4
4168023	44 Cms 4	100–900	0.01	25 / 50 mm 100 / 200 mm 400 mm			0.5	DIN 863–4

Order no.	a	b	c	d	e
	mm	mm	mm	mm	mm
4168001	5	16	2	2	18
4168020	5	16	2	2	18
4168021	5	16	2	2	18
4168022	5	16	2	2	18
4168023	5	16	2	2	18

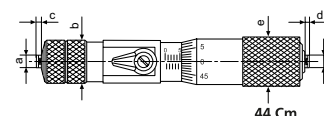

ACCESSORIES

Order no.	Description	Type
4167030	Individual extension (25 mm)	44 Cv
4167031	Individual extension (50 mm)	44 Cv
4167032	Individual extension (100 mm)	44 Cv
4167033	Individual extension (200 mm)	44 Cv
4167034	Individual extension (400 mm)	44 Cv
4167035	Individual extension (800 mm)	44 Cv
4168016	Wood case for two extensions 44Cv 800mm	
4168160	Case for 44 Cms	

FEATURES

- Operating and display units with satin chrome finish
- Stainless spindle is hardened throughout and ground
- Rapid drive with integrated ratchet
- Self-centering measuring head consists of 3 laterally positioned anvils, each are offset at intervals of 120°
- Anvils from 12 mm are carbide tipped
- From 12 mm the anvils can be used to measure the bottom of a bore
- From 40 mm all measuring heads are made from aluminium to reduce weight
- **Package contains:** instruction manual, allen key, key for replacing measuring heads (from 30 mm), case



TECHNICAL DATA

Order no.	Type	Measuring range	Readings	Error limit	Spindle thread pitch	Standard	Measuring depth	Measuring depth with extension
		mm	mm	µm	mm		mm	mm
4190310	44 A	6–8	0.001	4	0.5	DIN 863–4	58	133
4190311	44 A	8–10	0.001	4	0.5	DIN 863–4	58	133
4190312	44 A	10–12	0.001	4	0.5	DIN 863–4	58	133
4190313	44 A	12–16	0.001	4	0.5	DIN 863–4	64	139
4190314	44 A	16–20	0.001	4	0.5	DIN 863–4	64	139
4190315	44 A	20–25	0.005	4	0.5	DIN 863–4	68	218
4190316	44 A	25–30	0.005	4	0.5	DIN 863–4	68	218
4190317	44 A	30–40	0.005	4	0.5	DIN 863–4	76	226
4190319	44 A	40–50	0.005	4	0.5	DIN 863–4	76	226
4190320	44 A	50–60	0.005	5	0.5	DIN 863–4	79	229
4190321	44 A	60–70	0.005	5	0.5	DIN 863–4	79	229
4190012	44 A	70–85	0.005	5	0.5	DIN 863–4	97	247
4190013	44 A	85–100	0.005	5	0.5	DIN 863–4	97	247
4190014	44 A	100–125	0.005	6	0.5	DIN 863–4	132	282
4190015	44 A	125–150	0.005	6	0.5	DIN 863–4	132	282
4190016	44 A	150–175	0.005	7	0.5	DIN 863–4	132	282
4190017	44 A	175–200	0.005	7	0.5	DIN 863–4	132	282

Order no.	a	b	c	d	Order no.	a	b	c	d
	mm	mm	mm	mm		mm	mm	mm	mm
4190310	1.5	4	1.5	58	4190320		18	5	79
4190311	1.8	4.3	1.5	58	4190321		18	5	79
4190312	1.8	4.3	1.5	58	4190012		23	7	97
4190313		6.5	4	64	4190013		23	7	97
4190314		6.5	4	64	4190014		27	7	132
4190315		9	4	68	4190015		27	7	132
4190316		9	4	68	4190016		27	7	132
4190317		15	5	76	4190017		27	7	132
4190319		15	5	76					

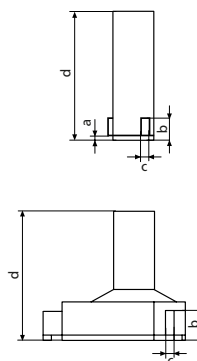

ACCESSORIES

Order no.	Description	Type
4710026	Ring gage DIN 2250 C, Ø 8 mm	355 E
4710030	Ring gage DIN 2250 C, Ø 10 mm	355 E
4710032	Ring gage DIN 2250 C, Ø 12 mm	355 E
4710036	Ring gage DIN 2250 C, Ø 16 mm	355 E
4710040	Ring gage DIN 2250 C, Ø 20 mm	355 E
4710045	Ring gage DIN 2250 C, Ø 25 mm	355 E
4710050	Ring gage DIN 2250 C, Ø 30 mm	355 E
4710060	Ring gage DIN 2250 C, Ø 40 mm	355 E
4710070	Ring gage DIN 2250 C, Ø 50 mm	355 E
4710080	Ring gage DIN 2250 C, Ø 60 mm	355 E
4710105	Ring gage DIN 2250 C, Ø 85 mm	355 E
4710121	Ring gage DIN 2250 C, Ø 125 mm	355 E
4710122	Ring gage DIN 2250 C, Ø 175 mm	355 E
4190090	Depth extension 75 mm, (6–12 mm)	44 Av
4190091	Depth extension 75 mm, (12–20 mm)	44 Av
4190092	Depth extension 150 mm, (20–30 mm)	44 Av
4190093	Depth extension 150 mm, (30–200 mm)	44 Av

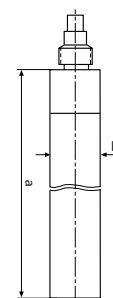

44 Av

FEATURES

- Operating and display units with satin chrome finish
- Stainless spindle is hardened throughout and ground
- Rapid drive with integrated ratchet
- Self-centering measuring head consists of 3 laterally positioned anvils, each are offset at intervals of 120°
- Anvils from 12 mm are carbide tipped
- From 12 mm the anvils can be used to measure the bottom of a bore
- From 40 mm all measuring heads are made from aluminium to reduce weight
- **Package contains:** instruction manual, setting rings, key for replacing measuring heads (from 30 mm), allen key, case

Applications:

For measuring

- Through holes
- Blind holes
- Centering shoulders



TECHNICAL DATA

Order no.	Type	Measuring range	Readings	Error limit	Standard	Number of micrometers	Setting rings
		mm		µm			
4190350	44 AS	6 – 12	0.001	4	DIN 863-4	3	8 mm, 10 mm
4190351	44 AS	12 – 20	0.001	4	DIN 863-4	2	16 mm
4190352	44 AS	20 – 50	0.005	4	DIN 863-4	4	25 mm, 40 mm
4190353	44 AS	50 – 100	0.005	5	DIN 863-4	4	60 mm, 85 mm

ACCESSORIES

Order no.	Description	Type
4190090	Depth extension 75 mm, (6 – 12 mm)	44 Av
4190091	Depth extension 75 mm, (12 – 20 mm)	44 Av
4190092	Depth extension 150 mm, (20 – 30 mm)	44 Av
4190093	Depth extension 150 mm, (30 – 200 mm)	44 Av

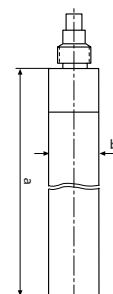

44 Av

Micromar 44 EWR

Digital inside micrometer



FUNCTIONS

- RESET (set display to zero)
- ABS (display can be set to zero without losing reference to preset)
- mm/inch
- PRESET (for entering a numerical value)
- DATA (data transmission via connection cable)
- LOCK function (key lock)

FEATURES

- Threaded connection for changing the measuring head
- Self-centering measuring head consists of 3 laterally positioned anvils, each are offset at intervals of 120°
- Anvils from 12 mm are carbide tipped
- From 12 mm the anvils can be used to measure the bottom of a bore
- From 40 mm all measuring heads are made from aluminium to reduce weight
- **Software:** MarCom Professional free download: www.mahr.com/marcom (only for Mahr data cables and wireless systems with USB and RS-232 interface)
- **Digit height:** 8,5 mm
- **Data interface:** Digimatic, Opto RS-232C, USB
- **Energy supply:** Battery life approx. 2 years
- **Battery type:** CR 2032 (3V Lithium)
- **IP protection category:** IP 52
- **Package contains:** basic units 44 EWg, measuring head 44 Ak, instruction manual, battery, case



Applications:
For measuring

- Through holes
- Blind holes
- Centering shoulders

TECHNICAL DATA

Order no.	Type	Measuring range		Resolution	Error limit	Standard	Measuring depth	
		mm	inch				mm	mm with extension
4191120	44 EWR	6 – 8	.25 – .3125"	0.001 / .00005"	4	DIN 863-4	58	133
4191121	44 EWR	8 – 10	.3125 – .4"	0.001 / .00005"	4	DIN 863-4	58	133
4191122	44 EWR	10 – 12	.4 – .4725"	0.001 / .00005"	4	DIN 863-4	58	133
4191123	44 EWR	12 – 16	.4725 – .625"	0.001 / .00005"	4	DIN 863-4	64	139
4191124	44 EWR	16 – 20	.625 – .775"	0.001 / .00005"	4	DIN 863-4	64	139
4191125	44 EWR	20 – 25	.775 – 1"	0.001 / .00005"	4	DIN 863-4	68	218
4191126	44 EWR	25 – 30	1 – 1.2"	0.001 / .00005"	4	DIN 863-4	68	218
4191127	44 EWR	30 – 40	1.2 – 1.6"	0.001 / .00005"	4	DIN 863-4	76	226
4191129	44 EWR	40 – 50	1.6 – 2"	0.001 / .00005"	4	DIN 863-4	76	226
4191130	44 EWR	50 – 60	2 – 2.35"	0.001 / .00005"	5	DIN 863-4	79	229
4191131	44 EWR	60 – 70	2.35 – 2.75"	0.001 / .00005"	5	DIN 863-4	79	229
4191032	44 EWR	70 – 85	2.75 – 3.35"	0.001 / .00005"	5	DIN 863-4	97	247
4191033	44 EWR	85 – 100	3.35 – 4"	0.001 / .00005"	5	DIN 863-4	97	247
4191034	44 EWR	100 – 125	4 – 4.9"	0.001 / .00005"	6	DIN 863-4	132	282
4191035	44 EWR	125 – 150	4.9 – 5.9"	0.001 / .00005"	6	DIN 863-4	132	282
4191036	44 EWR	150 – 175	5.9 – 6.9"	0.001 / .00005"	7	DIN 863-4	132	282
4191037	44 EWR	175 – 200	6.9 – 7.9"	0.001 / .00005"	7	DIN 863-4	132	282

Micromar 44 EWR

Digital inside micrometer

Order no.	a	b	c	d
	mm	mm	mm	mm
4191120	1.5	4	1.5	58
4191121	1.8	4.3	1.5	58
4191122	1.8	4.3	1.5	58
4191123		6.5	4	64
4191124		6.5	4	64
4191125		9	4	68
4191126		9	4	68
4191127		15	5	76
4191129		15	5	76
4191130		18	5	79
4191131		18	5	79
4191032		23	7	97
4191033		23	7	97
4191034		27	7	132
4191035		27	7	132
4191036		27	7	132
4191037		27	7	132

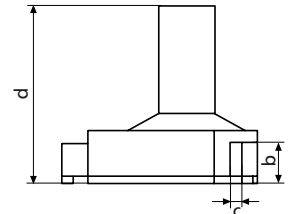
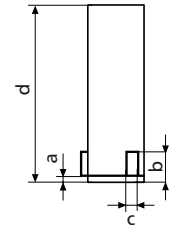

ACCESSORIES

Order no.	Description	Type
4102915	Interface adapter with data cable Digimatic (2 m)	16 EWd
4102231	16 EWe transmitter for e-Stick	16 EWe
4102410	Data connection cable RS232C (2 m)	16 EXr
4102357	16 EXu data connection cable USB (2 m)	16 EXu
4710026	Ring gage DIN 2250 C, Ø 8 mm	355 E
4710030	Ring gage DIN 2250 C, Ø 10 mm	355 E
4710032	Ring gage DIN 2250 C, Ø 12 mm	355 E
4710036	Ring gage DIN 2250 C, Ø 16 mm	355 E
4710040	Ring gage DIN 2250 C, Ø 20 mm	355 E
4710045	Ring gage DIN 2250 C, Ø 25 mm	355 E
4710050	Ring gage DIN 2250 C, Ø 30 mm	355 E
4710060	Ring gage DIN 2250 C, Ø 40 mm	355 E
4710070	Ring gage DIN 2250 C, Ø 50 mm	355 E
4710080	Ring gage DIN 2250 C, Ø 60 mm	355 E
4710105	Ring gage DIN 2250 C, Ø 85 mm	355 E
4710121	Ring gage DIN 2250 C, Ø 125 mm	355 E
4710122	Ring gage DIN 2250 C, Ø 175 mm	355 E
4190090	Depth extension 75 mm, (6 –12 mm)	44 Av
4190091	Depth extension 75 mm, (12 –20 mm)	44 Av
4190092	Depth extension 150 mm, (20 –30 mm)	44 Av
4190093	Depth extension 150 mm, (30 –200 mm)	44 Av
4102230	e-Stick receiver	e-Stick



16 EWe



e-Stick

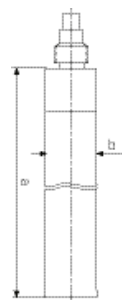

44 Av

Micromar 44 EWR

Digital inside micrometer in set



FUNCTIONS

- RESET (set display to zero)
- ABS (display can be set to zero without losing reference to preset)
- PRESET (for entering a numerical value)
- mm/inch
- LOCK function (key lock)
- DATA (data transmission via connection cable)

FEATURES

- Threaded connection for changing the measuring head
- Self-centering measuring head consists of 3 laterally positioned anvils, each are offset at intervals of 120°
- Anvils from 12 mm are carbide tipped
- From 12 mm the anvils can be used to measure the bottom of a bore
- From 40 mm all measuring heads are made from aluminium to reduce weight
- **Software:** MarCom Professional free download: www.mahr.com/marcom (only for Mahr data cables and wireless systems with USB and RS-232 interface)
- **Digit height:** 8,5 mm
- **Data interface:** Digimatic, Opto RS-232C, USB
- **Energy supply:** Battery life approx. 2 years
- **Battery type:** CR 2032 (3V Lithium)
- **IP protection category:** IP 52
- **Package contains:** basic units 44 EWg, measuring heads 44 Ak, setting rings, battery, instruction manual, case

Applications:

- Through holes
- Blind holes
- Centering shoulders



TECHNICAL DATA

Order no.	Type	Measuring range		Resolution	Error limit	Standard	Number of measuring heads 44 Ak	Setting rings
		mm	inch					
4191160	44 EWR	6 – 12	.25 – .4725"	0.001 / .00005"	4	DIN 863-4	3	8 mm, 10 mm
4191161	44 EWR	12 – 20	.4725 – .775"	0.001 / .00005"	4	DIN 863-4	2	16 mm
4191162	44 EWR	20 – 50	.775 – 2"	0.001 / .00005"	4	DIN 863-4	4	25 mm, 40 mm
4191163	44 EWR	50 – 100	2 – 4"	0.001 / .00005"	5	DIN 863-4	4	60 mm, 85 mm

ACCESSORIES

Order no.	Description	Type
4102915	Interface adapter with data cable Digimatic (2 m)	16 EWd
4102357	16 EXu data connection cable USB (2 m)	16 EXu
4102410	Data connection cable RS232C (2 m)	16 EXr
4102231	16 EWe transmitter for e-Stick	16 EWe
4102230	e-Stick receiver	e-Stick
4190090	Depth extension 75 mm, (6 – 12 mm)	44 Av
4190091	Depth extension 75 mm, (12 – 20 mm)	44 Av
4190092	Depth extension 150 mm, (20 – 30 mm)	44 Av
4190093	Depth extension 150 mm, (30 – 200 mm)	44 Av



16 EWe



e-Stick

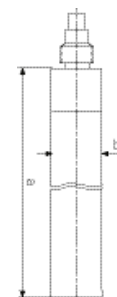

44 Av

Micromar 844 A

Measuring pistol

FEATURES

- Threaded connection for changing the measuring head
- Self-centering measuring head consists of 3 laterally positioned anvils, each are offset at intervals of 120°
- Anvils from 12 mm are carbide tipped
- From 12 mm the anvils can be used to measure the bottom of a bore
- From 40 mm all measuring heads are made from aluminium to reduce weight
- Measuring value indication is always easy to read when using an electronic dial indicator with a rotatable display
- **Package contains:** excludes indicator, basic units 844 Ag, measuring head 44 Ak, instruction manual, case



Applications: For measuring

- Through holes
- Blind holes
- Centering shoulders

TECHNICAL DATA

Order no.	Type	Measuring range		Error limit	Standard	Measuring depth	
		mm	inch			mm	mm with extension
4487700	844 A	6-8	.25-.3125"	3	Factory standard	58	133
4487701	844 A	8-10	.3125-.4"	3	Factory standard	58	133
4487702	844 A	10-12	.4-.4725"	3	Factory standard	58	133
4487703	844 A	12-16	.4725-.625"	3	Factory standard	64	139
4487704	844 A	16-20	.625-.775"	3	Factory standard	64	139
4487705	844 A	20-25	.775-1"	3	Factory standard	68	218
4487706	844 A	25-30	1-1.2"	3	Factory standard	68	218
4487707	844 A	30-40	1.2-1.6"	3	Factory standard	76	226
4487709	844 A	40-50	1.6-2"	3	Factory standard	76	226
4487710	844 A	50-60	2-2.35"	4	Factory standard	79	229
4487711	844 A	60-70	2.35-2.75"	4	Factory standard	79	229
4487612	844 A	70-85	2.75-3.35"	4	Factory standard	97	247
4487613	844 A	85-100	3.35-4"	4	Factory standard	97	247
4487614	844 A	100-125	4-4.9"	5	Factory standard	132	282
4487615	844 A	125-150	4.9-5.9"	5	Factory standard	132	282
4487616	844 A	150-175	5.9-6.9"	6	Factory standard	132	282
4487617	844 A	175-200	6.9-7.9"	6	Factory standard	132	282

Micromar 844 A

Measuring pistol

Order no.	a	b	c	d
	mm	mm	mm	mm
4487700	1.5	4	1.5	58
4487701	1.8	4.3	1.5	58
4487702	1.8	4.3	1.5	58
4487703		6.5	4	64
4487704		6.5	4	64
4487705		9	4	68
4487706		9	4	68
4487707		15	5	76
4487709		15	5	76
4487710		18	5	79
4487711		18	5	79
4487612		23	7	97
4487613		23	7	97
4487614		27	7	132
4487615		27	7	132
4487616		27	7	132
4487617		27	7	132

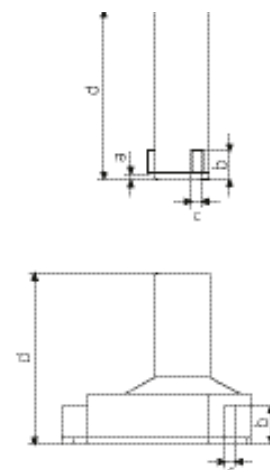

ACCESSORIES

Order no.	Connection thread	Description	Type
4337621		Digital indicator, 0.0005 mm, 25 mm	1086 R
4337625		Digital indicator, 0.0005 mm, 25 mm	1086 Ri
4102915		Interface adapter with data cable Digimatic (2 m)	16 EWd
4102410		Data connection cable RS232C (2 m)	16 EXr
4102357		16 EXu data connection cable USB (2 m)	16 EXu
4710026		Ring gage DIN 2250 C, Ø 8 mm	355 E
4710030		Ring gage DIN 2250 C, Ø 10 mm	355 E
4710036		Ring gage DIN 2250 C, Ø 16 mm	355 E
4710040		Ring gage DIN 2250 C, Ø 20 mm	355 E
4710050		Ring gage DIN 2250 C, Ø 30 mm	355 E
4710060		Ring gage DIN 2250 C, Ø 40 mm	355 E
4710080		Ring gage DIN 2250 C, Ø 60 mm	355 E
4710105		Ring gage DIN 2250 C, Ø 85 mm	355 E
4710121		Ring gage DIN 2250 C, Ø 125 mm	355 E
4710122		Ring gage DIN 2250 C, Ø 175 mm	355 E
4190090	M5x0.5	Depth extension 75 mm, (6 –12 mm)	44 Av
4190091	M5x0.5	Depth extension 75 mm, (12 –20 mm)	44 Av
4190092	M12x1	Depth extension 150 mm, (20 –30 mm)	44 Av
4190093	M12x1	Depth extension 150 mm, (30 –200 mm)	44 Av
4102220		Receiver for instruments with Integrated Wireless	i-Stick

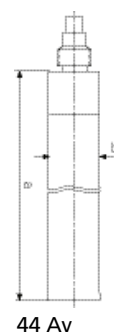

Micromar 844 AS

Measuring pistol in set

FEATURES

- Threaded connection for changing the measuring head
- Self-centering measuring head consists of 3 laterally positioned anvils, each are offset at intervals of 120°
- Anvils from 12 mm are carbide tipped
- From 12 mm the anvils can be used to measure the bottom of a bore
- From 40 mm all measuring heads are made from aluminium to reduce weight
- Measuring value indication is always easy to read when using an electronic dial indicator with a rotatable display
- **Package contains:** instruction manual, setting rings, key for replacing measuring heads (from 30 mm), case

Application:
For measuring

- Through holes
- Blind holes
- Centering shoulders



TECHNICAL DATA

Order no.	Type	Measuring range	Measuring range	Resolution	Error limit	Standard	Number of measuring heads 44 Ak	Indicating instrument (included in package)	Setting rings
		mm	inch	mm/inch	µm				
4487750	844 AS	6 – 12	.25 – .4725"		4	Factory standard	3	Without	8 mm, 10 mm
4487751	844 AS	12 – 20	.4725 – .775"		4	Factory standard	2	Without	16 mm
4487752	844 AS	20 – 50	.775 – 2"		4	Factory standard	4	Without	25 mm, 40 mm
4487753	844 AS	50 – 100	2 – 4"		5	Factory standard	4	Without	60 mm, 85 mm
4487760	844 AS	6 – 12	.25 – .4725"	0.0005 / .00002"	4	Factory standard	3	MarCator 1086 R	8 mm, 10 mm
4487761	844 AS	12 – 20	.4725 – .775"	0.0005 / .00002"	4	Factory standard	2	MarCator 1086 R	16 mm
4487762	844 AS	20 – 50	.775 – 2"	0.0005 / .00002"	4	Factory standard	4	MarCator 1086 R	25 mm, 40 mm
4487763	844 AS	50 – 100	2 – 4"	0.0005 / .00002"	5	Factory standard	4	MarCator 1086 R	60 mm, 85 mm

ACCESSORIES

Order no.	Description	Type
4102357	16 EXu data connection cable USB (2 m)	16 EXu
4102410	Data connection cable RS232C (2 m)	16 EXr
4102915	Interface adapter with data cable Digimatic (2 m)	16 EWd
4102231	16 EWe transmitter for e-Stick	16 EWe
4102230	e-Stick receiver	e-Stick
4190090	Depth extension 75 mm, (6 – 12 mm)	44 Av
4190091	Depth extension 75 mm, (12 – 20 mm)	44 Av
4190092	Depth extension 150 mm, (20 – 30 mm)	44 Av
4190093	Depth extension 150 mm, (30 – 200 mm)	44 Av

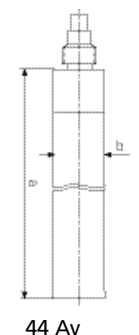

Micromar 44 EWg

Basic unit



FUNCTIONS

- RESET (set display to zero)
- ABS (display can be set to zero without losing reference to preset)
- PRESET (for entering a numerical value)
- mm/inch
- LOCK function (key lock)
- DATA (data transmission via connection cable)



FEATURES

- Threaded connection for changing the measuring head
- **Software:** MarCom Professional free download: www.mahr.com/marcom (only for Mahr data cables and wireless systems with USB and RS-232 interface)
- **Data interface:** Digimatic, Opto RS-232C, USB
- **Energy supply:** Battery life approx. 2 years
- **Battery type:** CR 2032 (3V Lithium)
- **IP protection category:** IP 52
- **Package contains:** instruction manual, battery, case

TECHNICAL DATA

Order no.	Type	Measuring range		Resolution
		mm	inch	
4190106	44 EWg	6 –20	.25 –.775"	0.001 / .00005"
4190107	44 EWg	20 –100	.775 –4.0"	0.001 / .00005"
4190108	44 EWg	100 –200	4.0 –7.9"	0.001 / .00005"

ACCESSORIES

Order no.	Description	Type
4102520	Battery 3 V, CR 2032	
4102357	16 EXu data connection cable USB (2 m)	16 EXu
4102915	Interface adapter with data cable Digimatic (2 m)	16 EWd
4102410	Data connection cable RS232C (2 m)	16 EXr
4190330	Measuring head, 6 –8 mm	44 Ak
4190331	Measuring head, 8 –10 mm	44 Ak
4190332	Measuring head, 10 –12 mm	44 Ak
4190333	Measuring head, 12 –16 mm	44 Ak
4190334	Measuring head, 16 –20 mm	44 Ak
4190335	Measuring head, 20 –25 mm	44 Ak
4190336	Measuring head, 25 –30 mm	44 Ak
4190337	Measuring head, 30 –40 mm	44 Ak
4190339	Measuring head, 40 –50 mm	44 Ak
4190340	Measuring head, 50 –60 mm	44 Ak
4190341	Measuring head, 60 –70 mm	44 Ak
4190042	Measuring head, 70 –85 mm	44 Ak
4190043	Measuring head, 85 –100 mm	44 Ak
4190044	Measuring head, 100 –125 mm	44 Ak
4190045	Measuring head, 125 –150 mm	44 Ak
4190046	Measuring head, 150 –175 mm	44 Ak
4190047	Measuring head, 175 –200 mm	44 Ak

Micromar 844 Ag

Basic instrument measuring pistol

FEATURES

- Threaded connection for changing the measuring head
- Any indicating instrument with an 8 mm mounting shank can be used
- **Package contents:** Model 6–100 mm: includes adapter for 6–20 mm, instruction manual, case



TECHNICAL DATA

Order no.	Type	Measuring range	
		mm	inch
4487635	844 Ag	6 –100	.25 –4.0"
4487633	844 Ag	20 –100	.775 –4.0"
4487634	844 Ag	100 –200	4.0 –7.9"

ACCESSORIES

Order no.	Description	Type
4190330	Measuring head, 6 –8 mm	44 Ak
4190331	Measuring head, 8 –10 mm	44 Ak
4190332	Measuring head, 10 –12 mm	44 Ak
4190333	Measuring head, 12 –16 mm	44 Ak
4190334	Measuring head, 16 –20 mm	44 Ak
4190335	Measuring head, 20 –25 mm	44 Ak
4190336	Measuring head, 25 –30 mm	44 Ak
4190337	Measuring head, 30 –40 mm	44 Ak
4190339	Measuring head, 40 –50 mm	44 Ak
4190340	Measuring head, 50 –60 mm	44 Ak
4190341	Measuring head, 60 –70 mm	44 Ak
4190042	Measuring head, 70 –85 mm	44 Ak
4190043	Measuring head, 85 –100 mm	44 Ak
4190044	Measuring head, 100 –125 mm	44 Ak
4190045	Measuring head, 125 –150 mm	44 Ak
4190046	Measuring head, 150 –175 mm	44 Ak
4190047	Measuring head, 175 –200 mm	44 Ak
4487410	Adapter for 844 Ag for use with measuring heads 44 Ak 6–20 mm	844 Aga

Micromar 44 Ak

Measuring head

FEATURES

- Self-centering measuring head consists of 3 laterally positioned anvils, each are offset at intervals of 120°
- Anvils from 12 mm are carbide tipped
- From 12 mm the anvils can be used to measure the bottom of a bore
- From 40 mm all measuring heads are made from aluminium to reduce weight

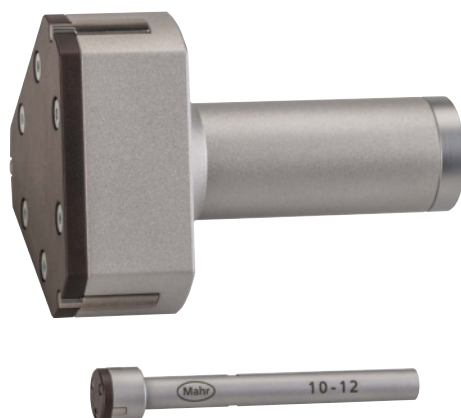

TECHNICAL DATA

Order no.	Type	Measuring range	
		mm	inch
4190330	44 Ak	6 – 8	.25 – .3125"
4190331	44 Ak	8 – 10	.3125 – .4"
4190332	44 Ak	10 – 12	.4 – .4725"
4190333	44 Ak	12 – 16	.4725 – .625"
4190334	44 Ak	16 – 20	.625 – .775"
4190335	44 Ak	20 – 25	.775 – 1"
4190336	44 Ak	25 – 30	1 – 1.2"
4190337	44 Ak	30 – 40	1.2 – 1.6"
4190339	44 Ak	40 – 50	1.6 – 2"
4190340	44 Ak	50 – 60	2 – 2.35"
4190341	44 Ak	60 – 70	2.35 – 2.75"
4190042	44 Ak	70 – 85	2.75 – 3.35"
4190043	44 Ak	85 – 100	3.35 – 4"
4190044	44 Ak	100 – 125	4 – 4.9"
4190045	44 Ak	125 – 150	4.9 – 5.9"
4190046	44 Ak	150 – 175	5.9 – 6.9"
4190047	44 Ak	175 – 200	6.9 – 7.9"

Order no.	a	b	c	d
	mm	mm	mm	mm
4190330	1.5	4	1.5	58
4190331	1.8	4.3	1.5	58
4190332	1.8	4.3	1.5	58
4190333		6.5	4	64
4190334		6.5	4	64
4190335		9	4	68
4190336		9	4	68
4190337		15	5	76
4190339		15	5	76
4190340		18	5	79
4190341		18	5	79
4190042		23	7	97
4190043		23	7	97
4190044		27	7	132
4190045		27	7	132
4190046		27	7	132
4190047		27	7	132

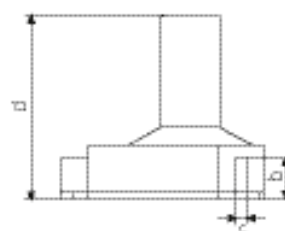
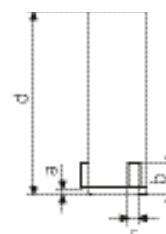

Micromar 45 T

Depth micrometer

FEATURES

- Operating and display units with satin chrome finish
- Stainless spindle is hardened throughout and ground
- Rapid drive with integrated ratchet
- **Package contains:** extensions 25 mm and 50 mm, case



TECHNICAL DATA

Order no.	Type	Measuring range	Readings	Error limit	Spindle thread pitch	Standard
4180000	45 T	mm 0 – 100	mm 0.01	µm 5	mm 0.5	Factory standard

Order no.	a	b	c
4180000	mm 100	mm 16	mm 13

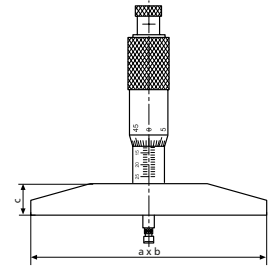

ACCESSORIES

Order no.	Description	Type
4180001	Extension (25 mm)	45 Tv
4180002	Extension (50 mm)	45 Tv
4180003	Extension (100 mm)	45 T
4180011	Disc anvil (9 x 1 mm)	45 Tm

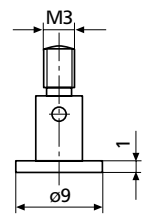

45 Tm

MarTest | Dial test indicators and touch probes

Mahr dial test indicators are ideal for delicate measuring tasks. Their sensitive measuring mechanism ensures maximum security and precision. The display has a hardened mineral glass panel and seal to protect it in harsh workshop conditions.



Overview of dial test indicators	104
Dial test indicators with scale display	
MarTest 800 S / 800 SG / 800 SR / 800 SA / 800 SGA Standard model	106
MarTest 800 SGB / 800 SL / 800 SGL Dial test indicator measuring device	107
MarTest 800 SM / 800 SGM / 800 SRM / 800 SGE With long measuring anvil	108
MarTest 801 SM / 801 SGM / 801 SRM / 801 SGE With long measuring anvil	110
MarTest 801 S / 801 S1 / 801 SG / 801 SR / 801 SGI With long measuring anvil	111
MarTest 801 SL / 801 SGL With long measuring anvil	112
MarTest 800 V / 800 VGM Vertical model	114
MarTest 801 VGM / 800 V Vertical model	116
MarTest 800 H Horizontal model	118
Digital dial test indicators	
MarTest 800 EW / 800 EWL Digital dial test indicators	119
Accessories: holder, measuring and centering arm, measuring stand	120
3D touch probes	
MarTest 802 EW Digital 3D touch probes	126
MarTest 802 NW Mechanical 3D touch probe	127

MarTest | Terms

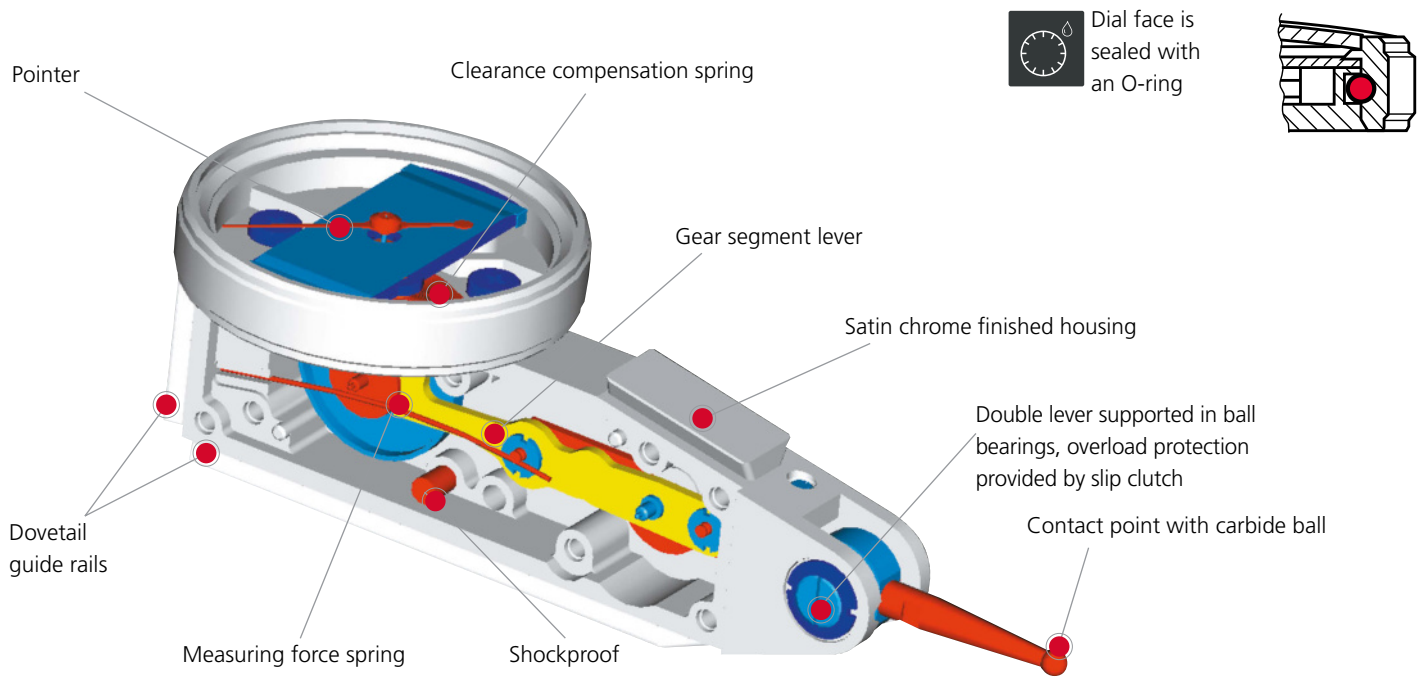

Dial face is sealed with an O-ring

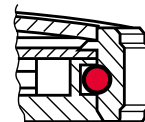

SHOCK PROOF

Mechanism

- Shockproof
- Anti-magnetic
- Movement bearings are jeweled with 8 precious stones

Styli with carbide contact points



Styli with ruby contact points



MarTest | Applications

Concentricity of a shaft



Concentricity of a sleeve



Centering of a bore



Aligning a surface



Testing parallelism



MarTest | Avoiding measuring errors

For accurate measurements the axis of the contact point must be perpendicular to the measuring direction (fig. 1). If this is not possible, it is necessary to multiply the reading on the dial with a correction factor, which depends on angle α (fig. 2). The correction factor is negligible for angles below 15°.

Angle α	15°	30°	45°	60°
Corr. factor	0.96	0.87	0.70	0.50

Example:

Angle α : 30° (estimated)

Reading on dial: 0.38 mm

Meas. values: $0.38 \times 0.87 = 0.33$ mm

Please use only the provided measuring insert length for the type of device (e.g. 800 S)

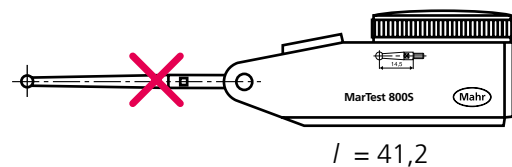
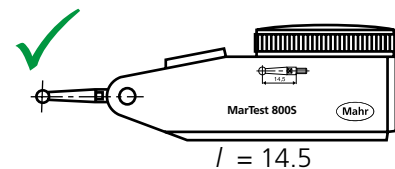
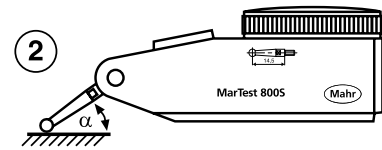
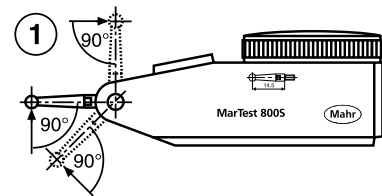

MarTest | Automatic switch of measuring direction

Measurement in both directions is possible without switch. The pointer moves clockwise. This guarantees clear and errorless reading.

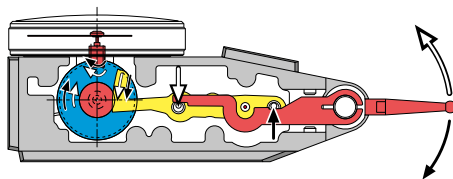

Functional depiction

MarTest | Metrological characteristics

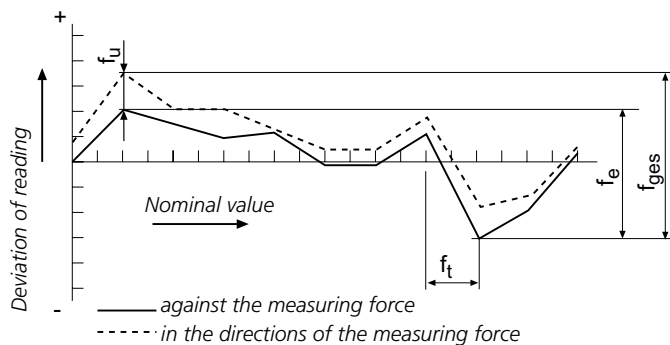

MarTest | Versions

Standard model
800 S

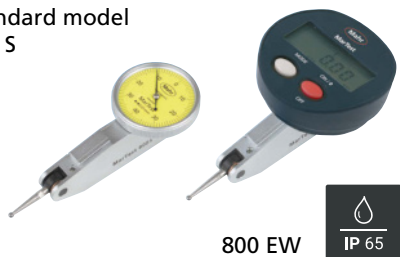

800 EW



Extra long styli
800 SL



800 EWL



Higher resolution
800 SM



Larger measuring range
800 SR



Horizontal model
800 H



Vertical model
800 V



FEATURES

Standard model

- High-contrast dial face, sealed with O-ring
- Mineral glass viewing panel for best protection:
 - against cracking, scratching or damage caused by hot shavings
 - optimum resistance to solvents
- Matt chrome-plated protective casing with three integrated dovetail guide rails
- Shockproof measuring mechanism
- Anti-magnetic model
- Automatic adjustment to the contacting direction ensuring infallible readings
- Ball bearing mounted double lever
- Friction clutch overload protection
- **Package contains:** case, instruction manual, Spanner for changing the styli, stylus diameter $\varnothing 2$ mm, mounting shaft 800a8



Applications:

- Measurement of concentricity, alignment, parallelism and flatness
- Centering of bores and shafts
- Parallel or perpendicular alignment of workpieces

TECHNICAL DATA

Order no.	4305200	4307200	4307250	4301200	4301250
Standard	DIN 2270		Factory standard		
Type	800 S	800 SG	800 SR	800 SA	800 SGA
Measuring range	mm ± 0.4		± 0.8	± 0.25	
Readings	mm		0.01		
Measuring surface	carbide				
Scale diameter	mm 28	38		28	38
Type of dial face	40–0–40			25–0–25	
Dial color	Yellow				
Measuring force	N	0.15		0.1	
Range per rev.	mm	0.8		0.5	
Deviation range f_e	μm	10		5	
Total deviation range f_{ges}	μm	13	14	8	
Measuring value hysteresis f_u	μm	3	4	3	
Partial measuring span f_t	μm			5	
Repeatability f_w	μm			3	

Order no.	a	b	c	d	e	f	Measuring anvil length
	mm	mm	mm	mm	mm	mm	mm
4305200		30	13.6	17.8	75	99	14.5
4307200	40.5		13.6	17.8	75	99	14.5
4307250	40.5		13.6	17.8	75	99	14.5
4301200		30	13.6	17.8	75	99	14.5
4301250	40.5		13.6	17.8	75	99	14.5

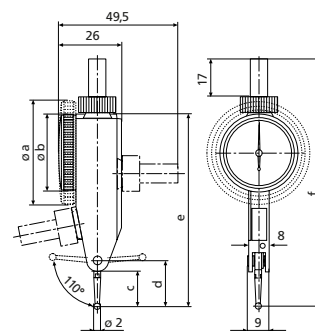

ACCESSORIES

Order no.	Description	Type
4305870	Stylus $\varnothing 1.0$ mm, carbide, $l = 14.5$ mm	800 ts
4305850	Stylus $\varnothing 2.0$ mm, carbide, $l = 14.5$ mm	800 ts
4305871	Stylus $\varnothing 3.0$ mm, carbide, $l = 14.5$ mm	800 ts
4309051	Stylus $\varnothing 2.0$ mm, ruby, $l = 14.5$ mm	800 tsr
4305868	Spanner	

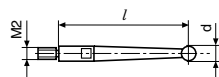

FEATURES

With long stylus, for measurements at poorly accessible measuring points

- High-contrast dial face, sealed with O-ring
- Mineral glass viewing panel for best protection:
 - against cracking, scratching or damage caused by hot shavings
 - optimum resistance to solvents
- Matt chrome-plated protective casing with three integrated dovetail guide rails
- Shockproof measuring mechanism
- Anti-magnetic model
- Automatic adjustment to the contacting direction ensuring infallible readings
- Ball bearing mounted double lever
- Friction clutch overload protection
- **Package contains:** case, instruction manual, Spanner for changing the styli, stylus diameter $\varnothing 2$ mm, mounting shaft 800a6 (800 SA/SGA/SGB), mounting shaft 800a8



Applications:

- Measurement of concentricity, alignment, parallelism and flatness
- Centering of bores and shafts
- Parallel or perpendicular alignment of workpieces

TECHNICAL DATA

Order no.		4301300	4306200	4306250
Standard			Factory standard	
Type		800 SGB	800 SL	800 SGL
Measuring range	mm	± 0.5	± 0.25	
Readings	mm	0.01		
Measuring surface		carbide		
Scale diameter	mm	38	28	38
Type of dial face		50–0–50		25–0–25
Dial color		Yellow		
Measuring force	N	0.07		
Range per rev.	mm	1	0.5	
Deviation range f_e	μm	10		
Total deviation range f_{ges}	μm	13		
Measuring value hysteresis f_u	μm	4	5	
Partial measuring span f_t	μm	5		
Repeatability f_w	μm	3		

Order no.	a	b	c	d	e	f	Measuring anvil length
	mm	mm	mm	mm	mm	mm	mm
4301300	40.5		31.4	35.7	93	117	32.3
4306200		30	40.3	44.6	102	126	41.24
4306250	40.5		40.3	44.6	102	126	41.24

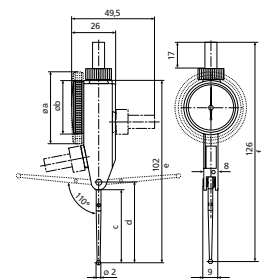

ACCESSORIES

Order no.	Description	Type
4301851	Stylus $\varnothing 1.0$ mm, carbide, $l = 32.3$ mm	800 tb
4301850	Stylus $\varnothing 2.0$ mm, carbide, $l = 32.3$ mm	800 tb
4301852	Stylus $\varnothing 3.0$ mm, carbide, $l = 32.3$ mm	800 tb
4309052	Stylus $\varnothing 2.0$ mm, ruby, $l = 32.3$ mm	800 tbr
4305868	Spanner	
4306851	Stylus $\varnothing 1.0$ mm, carbide, $l = 41.24$ mm	800 tl
4306850	Stylus $\varnothing 2.0$ mm, carbide, $l = 41.24$ mm	800 tl
4306853	Stylus $\varnothing 3.0$ mm, carbide, $l = 41.24$ mm	800 tl
4309053	Stylus $\varnothing 2.0$ mm, ruby, $l = 41.24$ mm	800 tlr

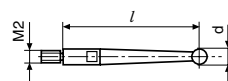

FEATURES

For high-precision measurements

- High-contrast dial face, sealed with O-ring
- Mineral glass viewing panel for best protection:
 - against cracking, scratching or damage caused by hot shavings
 - optimum resistance to solvents
- Matt chrome-plated protective casing with three integrated dovetail guide rails
- Shockproof measuring mechanism
- Anti-magnetic model
- Automatic adjustment to the contacting direction ensuring infallible readings
- Ball bearing mounted double lever
- Friction clutch overload protection
- **Package contains:** case, instruction manual, Spanner for changing the styli, stylus diameter \varnothing 2 mm, mounting shaft 800a8



Applications:

- Measurement of concentricity, alignment, parallelism and flatness
- Centering of bores and shafts
- Parallel or perpendicular alignment of workpieces

TECHNICAL DATA

Order no.	4308150	4308200	4308250
Standard	DIN 2270		Factory standard
Type	800 SM	800 SGM	800 SRM
Measuring range	mm	± 0.1	± 0.2
Readings	mm	0.002	
Measuring surface	carbide		
Scale diameter	mm	28	38
Type of dial face	100–0–100		
Dial color	Yellow		
Measuring force	N	0.15	
Range per rev.	mm	0.2	
Deviation range f_e	μm	3	
Total deviation range f_{ges}	μm	4	5
Measuring value hysteresis f_u	μm	2	3
Partial measuring span f_t	μm	2	
Repeatability f_w	μm	1.5	

Order no.	a	b	c	d	e	f	Measuring anvil length
	mm	mm	mm	mm	mm	mm	mm
4308150		30	13.6	17.8	75	99	14.5
4308200	40.5		13.6	17.8	75	99	14.5
4308250	40.5		13.6	17.8	75	99	14.5

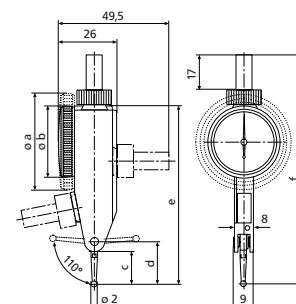

ACCESSORIES

Order no.	Description	Type
4305870	Stylus \varnothing 1.0 mm, carbide, $l = 14.5$ mm	800 ts
4305850	Stylus \varnothing 2.0 mm, carbide, $l = 14.5$ mm	800 ts
4305871	Stylus \varnothing 3.0 mm, carbide, $l = 14.5$ mm	800 ts
4309051	Stylus \varnothing 2.0 mm, ruby, $l = 14.5$ mm	800 tsr
4305868	Spanner	

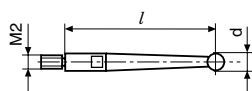

FEATURES

For high-precision measurements

- High-contrast dial face, sealed with O-ring
- Mineral glass viewing panel for best protection:
 - against cracking, scratching or damage caused by hot shavings
 - optimum resistance to solvents
- Matt chrome-plated protective casing with three integrated dovetail guide rails
- Shockproof measuring mechanism
- Anti-magnetic model
- Automatic adjustment to the contacting direction ensuring infallible readings
- Ball bearing mounted double lever
- Friction clutch overload protection
- **Package contains:** case, instruction manual, Spanner for changing the styli, stylus diameter \varnothing 2 mm, mounting shaft 800a8



Applications:

- Measurement of concentricity, alignment, parallelism and flatness
- Centering of bores and shafts
- Parallel or perpendicular alignment of workpieces

TECHNICAL DATA

Order no.	4308220				
Standard	Factory standard				
Type	800 SGE				
Measuring range	mm	± 0.07			
Readings	mm	0.001			
Measuring surface	carbide				
Scale diameter	mm	38			
Type of dial face	70–0–70				
Dial color	Yellow				
Measuring force	N	0.2			
Range per rev.	mm	0.14			
Deviation range f_e	μm	3			
Total deviation range f_{ges}	μm	4			
Measuring value hysteresis f_u	μm	2			
Partial measuring span f_t	μm	2			
Repeatability f_w	μm	1.5			

Order no.	a	c	d	e	f	Measuring anvil length
	mm	mm	mm	mm	mm	mm
4308220	40.5	8.3	12.5	70	94	9.15

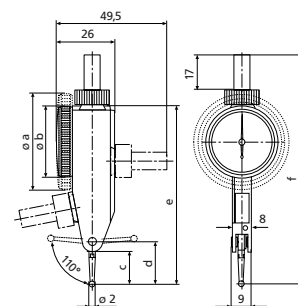

ACCESSORIES

Order no.	Description	Type
4308851	Stylus \varnothing 1.0 mm, carbide, $l = 9.1$ mm	800 te
4308850	Stylus \varnothing 2.0 mm, carbide, $l = 9.1$ mm	800 te
4308852	Stylus \varnothing 3.0 mm, carbide, $l = 9.1$ mm	800 te
4309050	Stylus \varnothing 2.0 mm, ruby, $l = 9.1$ mm	800 ter
4305868	Spanner	

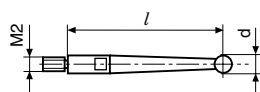

FEATURES

For high-precision measurements

- High-contrast dial face, sealed with O-ring
- Mineral glass viewing panel for best protection:
 - against cracking, scratching or damage caused by hot shavings
 - optimum resistance to solvents
- Matt chrome-plated protective casing with three integrated dovetail guide rails
- Shockproof measuring mechanism
- Anti-magnetic model
- Automatic adjustment to the contacting direction ensuring infallible readings
- Ball bearing mounted double lever
- Friction clutch overload protection
- **Package contains:** case, instruction manual, spanner for changing the styli, stylus diameter \varnothing 2 mm, mounting shaft 800a3/8



Applications:

- Measurement of concentricity, alignment, parallelism and flatness
- Centering of bores and shafts
- Parallel or perpendicular alignment of workpieces

TECHNICAL DATA

Order no.		4308960	4308970	4308980	4308985
Standard		Factory standard			
Type		801 SM	801 SGM	801 SRM	801 SGE
Measuring range	inch	$\pm .004''$		$\pm .008''$	$\pm .004''$
Readings	inch	0,0001			0,00005
Measuring surface		carbide			
Scale diameter	inch	1.1		1.5	
Type of dial face		4-0-4			
Dial color		Green			
Measuring force	N	0.15			
Range per turn	inch	0.0080			
Deviation range f_e	inch	0.00012			0.0004
Total deviation range f_{ges}	inch	0.00016		0.0002	0.0005
Measuring value hysteresis f_u	inch	0.00008			0.00012
Partial measuring span f_t	inch	0.00008			0.0002
Repeatability f_w	inch	0.0001			

Order no.	a	b	c	d	e	f	Measuring anvil length
	mm	mm	mm	mm	mm	mm	mm
4308960		30	13.6	17.8	75	99	14.5
4308970	40.5		13.6	17.8	75	99	14.5
4308980	40.5		13.6	17.8	75	99	14.5
4308985	40.5		13.6	17.8	75	99	14.5

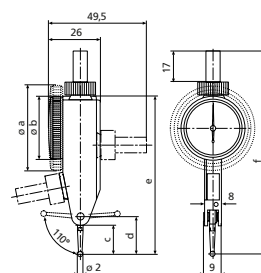

ACCESSORIES

Order no.	Description	Type
4305850	Stylus \varnothing 2.0 mm, carbide, l = 14.5 mm	800 ts
4305870	Stylus \varnothing 1.0 mm, carbide, l = 14.5 mm	800 ts
4305871	Stylus \varnothing 3.0 mm, carbide, l = 14.5 mm	800 ts
4309051	Stylus \varnothing 2.0 mm, ruby, l = 14.5 mm	800 tsr
4305868	Spanner	

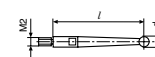

FEATURES

Standard model

- High-contrast dial face, sealed with O-ring
- Mineral glass viewing panel for best protection:
 - against cracking, scratching or damage caused by hot shavings
 - optimum resistance to solvents
- Matt chrome-plated protective casing with three integrated dovetail guide rails
- Shockproof measuring mechanism
- Anti-magnetic model
- Automatic adjustment to the contacting direction ensuring infallible readings
- Ball bearing mounted double lever
- Friction clutch overload protection
- **Package contains:** case, instruction manual, spanner for changing the styli, stylus diameter $\varnothing 2$ mm, mounting shaft 800a3/8



Applications:

- Measurement of concentricity, alignment, parallelism and flatness
- Centering of bores and shafts
- Parallel or perpendicular alignment of workpieces

TECHNICAL DATA

Order no.		4305950	4305960	4307950	4307960	4307970
Standard		Factory standard				
Type		801 S	801 S1	801 SG	801 SR	801 SGI
Measuring range	mm					$\pm 0,3$
Measuring range	inch		$\pm .015''$		$\pm .030''$	$\pm .015''$
Readings	inch			0.0005		
Readings						0.01
Measuring surface				carbide		
Scale diameter	inch	1.1	1.5	1.1	1.5	
Type of dial face				15–0–15		
Dial color				Green		
Measuring force	N			0.15		
Range per turn	mm					0.6
Range per turn	inch			0.0300		
Deviation range f_e	inch			0.0004		
Total deviation range f_{ges}	inch			0.0005		
Measuring value hysteresis f_u	inch		0.00012		0.00016	0.00012
Partial measuring span f_t	inch			0.0002		
Repeatability f_w	inch			0.0001		

Order no.	a	b	c	d	e	f	Measuring anvil length
	mm	mm	mm	mm	mm	mm	mm
4305950		30	13.6	17.8	75	99	14.5
4305960		30	13.6	17.8	75	99	14.5
4307950	40.5		13.6	17.8	75	99	14.5
4307960	40.5		13.6	17.8	75	99	14.5
4307970	40.5		13.6	17.8	75	99	14.5

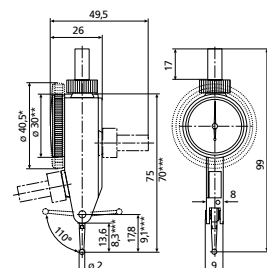

ACCESSORIES

Order no.	Description	Type
4305870	Stylus $\varnothing 1.0$ mm, carbide, $l = 14.5$ mm	800 ts
4305850	Stylus $\varnothing 2.0$ mm, carbide, $l = 14.5$ mm	800 ts
4305871	Stylus $\varnothing 3.0$ mm, carbide, $l = 14.5$ mm	800 ts
4309051	Stylus $\varnothing 2.0$ mm, ruby, $l = 14.5$ mm	800 tsr
4305868	Spanner	

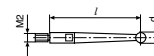

FEATURES

With long stylus, for measurements at poorly accessible measuring points

- High-contrast dial face, sealed with O-ring
- Mineral glass viewing panel for best protection:
 - against cracking, scratching or damage caused by hot shavings
 - optimum resistance to solvents
- Matt chrome-plated protective casing with three integrated dovetail guide rails
- Shockproof measuring mechanism
- Anti-magnetic model
- Automatic adjustment to the contacting direction ensuring infallible readings
- Ball bearing mounted double lever
- Friction clutch overload protection
- **Package contains:** case, instruction manual, spanner for changing the styli, stylus diameter \varnothing 2 mm, mounting shaft 800a3/8



Applications:

- Measurement of concentricity, alignment, parallelism and flatness
- Centering of bores and shafts
- Parallel or perpendicular alignment of workpieces

TECHNICAL DATA

Order no.	4306950		4306960	
Standard		Factory standard		
Type		801 SL		801 SGL
Measuring range	inch		$\pm .010''$	
Readings	inch		0,0005	
Measuring surface			carbide	
Scale diameter	inch	1.1		1.5
Type of dial face			10–0–10	
Dial color			Green	
Measuring force	N		0.07	
Range per turn	inch		0.0200	
Deviation range f_e	inch		0.0004	
Total deviation range f_{ges}	inch		0.0005	
Measuring value hysteresis f_u	inch		0.0002	
Partial measuring span f_t	inch		0.0002	
Repeatability f_w	inch		0.0001	

TECHNICAL DATA

Order no.	a	b	c	d	e	f	Measuring anvil length
	mm	mm	mm	mm	mm	mm	mm
4306950		30	40.3	44.6	102	126	41.24
4306960	40.5		40.3	44.6	102	126	41.24

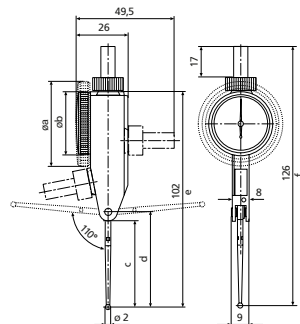

ACCESSORIES

Order no.	Description	Type
4306851	Stylus \varnothing 1.0 mm, carbide, $l = 41.24$ mm	800 tl
4306850	Stylus \varnothing 2.0 mm, carbide, $l = 41.24$ mm	800 tl
4306853	Stylus \varnothing 3.0 mm, carbide, $l = 41.24$ mm	800 tl
4309053	Stylus \varnothing 2.0 mm, ruby, $l = 41.24$ mm	800 tlr
4305868	Spanner	

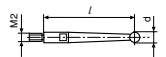

FEATURES

Vertical model

- High-contrast dial face, sealed with O-ring
- Mineral glass viewing panel for best protection:
 - against cracking, scratching or damage caused by hot shavings
 - optimum resistance to solvents
- Matt chrome-plated protective casing with three integrated dovetail guide rails
- Shockproof measuring mechanism
- Anti-magnetic model
- Automatic adjustment to the contacting direction ensuring infallible readings
- Ball bearing mounted double lever
- Friction clutch overload protection
- **Package contains:** case, instruction manual, Spanner for changing the styli, stylus diameter \varnothing 2 mm, mounting shaft 800a8



Applications:

- Measurement of concentricity, alignment, parallelism and flatness
- Centering of bores and shafts
- Parallel or perpendicular alignment of workpieces

TECHNICAL DATA

Order no.	4302200	
Standard	DIN 2270	
Type	800 V	
Measuring range	mm	± 0.4
Readings	mm	0.01
Measuring surface	carbide	
Scale diameter	mm	28
Type of dial face	40–0–40	
Dial color	Yellow	
Measuring force	N	0.2
Range per rev.	mm	0.8
Deviation range f_e	μm	10
Total deviation range f_{ges}	μm	13
Measuring value hysteresis f_u	μm	3
Partial measuring span f_t	μm	5
Repeatability f_w	μm	3

Order no.	b	Measuring anvil length
	mm	mm
4302200	30	14.5

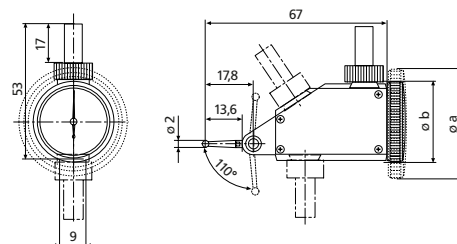

ACCESSORIES

Order no.	Description	Type
4305870	Stylus \varnothing 1.0 mm, carbide, $l = 14.5$ mm	800 ts
4305850	Stylus \varnothing 2.0 mm, carbide, $l = 14.5$ mm	800 ts
4305871	Stylus \varnothing 3.0 mm, carbide, $l = 14.5$ mm	800 ts
4309051	Stylus \varnothing 2.0 mm, ruby, $l = 14.5$ mm	800 tsr
4305868	Spanner	

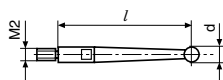

FEATURES

Vertical model

- High-contrast dial face, sealed with O-ring
- Mineral glass viewing panel for best protection:
 - against cracking, scratching or damage caused by hot shavings
 - optimum resistance to solvents
- Matt chrome-plated protective casing with three integrated dovetail guide rails
- Shockproof measuring mechanism
- Anti-magnetic model
- Automatic adjustment to the contacting direction ensuring infallible readings
- Ball bearing mounted double lever
- Friction clutch overload protection
- **Package contains:** case, instruction manual, Spanner for changing the styli, stylus diameter $\varnothing 2$ mm, mounting shaft 800a8



Applications:

- Measurement of concentricity, alignment, parallelism and flatness
- Centering of bores and shafts
- Parallel or perpendicular alignment of workpieces

TECHNICAL DATA

Order no.			4302250
Standard			DIN 2270
Type			800 VGM
Measuring range	mm		± 0.1
Readings	mm		0.002
Measuring surface			carbide
Scale diameter	mm		38
Type of dial face			100–0–100
Dial color			Yellow
Measuring force	N		0.25
Range per rev.	mm		0.2
Deviation range f_e	μm		3
Total deviation range f_{ges}	μm		4
Measuring value hysteresis f_u	μm		2
Partial measuring span f_t	μm		2
Repeatability f_w	μm		1.5

Order no.	a	Measuring anvil length
	mm	mm
4302250	40.5	14.5

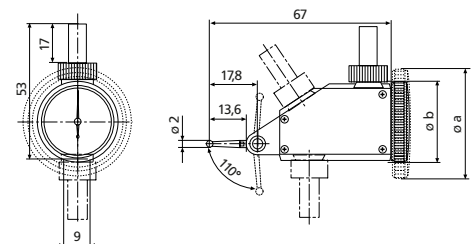

ACCESSORIES

Order no.	Description	Type
4305870	Stylus $\varnothing 1.0$ mm, carbide, $l = 14.5$ mm	800 ts
4305850	Stylus $\varnothing 2.0$ mm, carbide, $l = 14.5$ mm	800 ts
4305871	Stylus $\varnothing 3.0$ mm, carbide, $l = 14.5$ mm	800 ts
4309051	Stylus $\varnothing 2.0$ mm, ruby, $l = 14.5$ mm	800 tsr
4305868	Spanner	

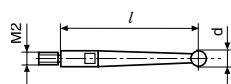

FEATURES

Vertical model

- High-contrast dial face, sealed with O-ring
- Mineral glass viewing panel for best protection:
 - against cracking, scratching or damage caused by hot shavings
 - optimum resistance to solvents
- Matt chrome-plated protective casing with three integrated dovetail guide rails
- Shockproof measuring mechanism
- Anti-magnetic model
- Automatic adjustment to the contacting direction ensuring infallible readings
- Ball bearing mounted double lever
- Friction clutch overload protection
- **Package contains:** case, instruction manual, spanner for changing the styli, stylus diameter $\varnothing 2$ mm, mounting shaft 800a3/8



Applications:

- Measurement of concentricity, alignment, parallelism and flatness
- Centering of bores and shafts
- Parallel or perpendicular alignment of workpieces

TECHNICAL DATA

Order no.	4302960	
Standard		Factory standard
Type		801 VGM
Measuring range	inch	$\pm .004''$
Readings	inch	0,0001
Measuring surface		carbide
Scale diameter	inch	1.5
Type of dial face		4-0-4
Dial color		Green
Measuring force	N	0.25
Range per turn	inch	0.0080
Deviation range f_e	inch	0.00012
Total deviation range f_{ges}	inch	0.00016
Measuring value hysteresis f_u	inch	0.00008
Partial measuring span f_t	inch	0.00008
Repeatability f_w	inch	0.0001

Order no.	a	Measuring anvil length
	mm	mm
4302960	40.5	14.5

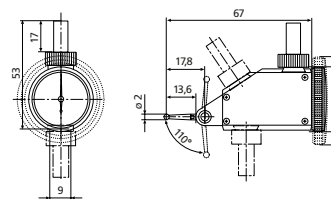

ACCESSORIES

Order no.	Description	Type
4305870	Stylus $\varnothing 1.0$ mm, carbide, $l = 14.5$ mm	800 ts
4305850	Stylus $\varnothing 2.0$ mm, carbide, $l = 14.5$ mm	800 ts
4305871	Stylus $\varnothing 3.0$ mm, carbide, $l = 14.5$ mm	800 ts
4309051	Stylus $\varnothing 2.0$ mm, ruby, $l = 14.5$ mm	800 tsr
4305868	Spanner	

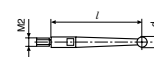

FEATURES

Vertical model

- High-contrast dial face, sealed with O-ring
- Mineral glass viewing panel for best protection:
 - against cracking, scratching or damage caused by hot shavings
 - optimum resistance to solvents
- Matt chrome-plated protective casing with three integrated dovetail guide rails
- Shockproof measuring mechanism
- Anti-magnetic model
- Automatic adjustment to the contacting direction ensuring infallible readings
- Ball bearing mounted double lever
- Friction clutch overload protection
- **Package contains:** case, instruction manual, spanner for changing the styli, stylus diameter \varnothing 2 mm, mounting shaft 800a3/8



Applications:

- Measurement of concentricity, alignment, parallelism and flatness
- Centering of bores and shafts
- Parallel or perpendicular alignment of workpieces

TECHNICAL DATA

Order no.	4302950	
Standard		Factory standard
Type		801 V
Measuring range	inch	$\pm .015''$
Readings	inch	0,0005
Measuring surface		carbide
Scale diameter	inch	1.1
Type of dial face		15–0–15
Dial color		Green
Measuring force	N	0.2
Range per turn	inch	0.0300
Deviation range f_e	inch	0.0004
Total deviation range f_{ges}	inch	0.0005
Measuring value hysteresis f_u	inch	0.00012
Partial measuring span f_t	inch	0.0002
Repeatability f_w	inch	0.0001

Order no.	b	Measuring anvil length
	mm	mm
4302950	30	14.5

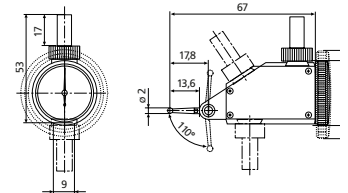

ACCESSORIES

Order no.	Description	Type
4305870	Stylus \varnothing 1.0 mm, carbide, $l = 14.5$ mm	800 ts
4305850	Stylus \varnothing 2.0 mm, carbide, $l = 14.5$ mm	800 ts
4305871	Stylus \varnothing 3.0 mm, carbide, $l = 14.5$ mm	800 ts
4309051	Stylus \varnothing 2.0 mm, ruby, $l = 14.5$ mm	800 tsr
4305868	Spanner	

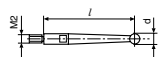

FEATURES

Horizontal model

- High-contrast dial face, sealed with O-ring
- Mineral glass viewing panel for best protection:
 - against cracking, scratching or damage caused by hot shavings
 - optimum resistance to solvents
- Matt chrome-plated protective casing with three integrated dovetail guide rails
- Shockproof measuring mechanism
- Anti-magnetic model
- Automatic adjustment to the contacting direction ensuring infallible readings
- Ball bearing mounted double lever
- Friction clutch overload protection
- **Package contains:** case, instruction manual, Spanner for changing the styli, stylus diameter \varnothing 2 mm, mounting shaft 800a8



Applications:

- Measurement of concentricity, alignment, parallelism and flatness
- Centering of bores and shafts
- Parallel or perpendicular alignment of workpieces

TECHNICAL DATA

Order no.			4303200
Standard			DIN 2270
Type			800 H
Measuring range	mm		\pm 0.4
Readings	mm		0.01
Measuring surface			carbide
Scale diameter	mm		28
Type of dial face			40–0–40
Dial color			Yellow
Measuring force	N		0.25
Range per rev.	mm		0.8
Deviation range f_e	μ m		10
Total deviation range f_{ges}	μ m		13
Measuring value hysteresis f_u	μ m		3
Partial measuring span f_t	μ m		5
Repeatability f_w	μ m		3

Order no.	Measuring anvil length
	mm
4303200	14.5

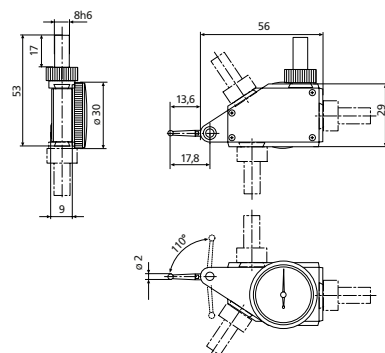

ACCESSORIES

Order no.	Description	Type
4305870	Stylus \varnothing 1.0 mm, carbide, l = 14.5 mm	800 ts
4305850	Stylus \varnothing 2.0 mm, carbide, l = 14.5 mm	800 ts
4305871	Stylus \varnothing 3.0 mm, carbide, l = 14.5 mm	800 ts
4309051	Stylus \varnothing 2.0 mm, ruby, l = 14.5 mm	800 tsr
4305868	Spanner	

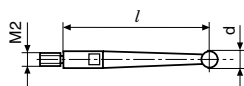

MarTest 800 EW / 800 EWL

Digital test indicator



FUNCTIONS

- ON/OFF
- RESET (set display to zero)
- mm/inch
- MAX/MIN memory for searching the reversal point
- (MAX-MIN) for testing flatness and concentricity

FEATURES

- Inductive measuring system
- Battery life approx. 2 years
- Operating unit is protected against coolants and lubricants, protection class IP65
- Combined analog and digital display
- Operating and display unit (bezel) can be rotated through 360°
- Satin chrome finished housing with 3 dovetail guideways
- Shockproof
- Movement bearings are jeweled
- Automatic matching to sensing direction
- Anti-magnetic
- Double lever supported in ball bearings
- Overload protection provided by slip clutch
- **Software:** MarCom Professional free download: www.mahr.com/marcom (only for Mahr data cables and wireless systems with USB and RS-232 interface)
- **Data interface:** Opto RS-232C, USB
- **Energy supply:** Battery life approx. 3 years
- **Battery type:** CR 2032 (3V Lithium)
- **IP protection category:** IP 65
- **Package contains:** mounting shaft 800a8, Spanner for changing the styli, stylus diameter $\varnothing 2$ mm, case



Applications:

- Measurement of concentricity, alignment, parallelism and flatness
- Centering of bores and shafts
- Parallel or perpendicular alignment of workpieces

TECHNICAL DATA

Order no.	4305120	4306120
Standard		Factory standard
Type	800 EW	800 EWL
Measuring range	mm ± 0.4	± 0.25
Measuring range	inch $\pm .015''$	$\pm .010''$
Resolution	mm / inch	0.001 / .00005"
Measuring surface		carbide
Measuring force	N	0.13
Deviation range f_e	μm	10
Total deviation range f_{ges}	μm	13
Measuring value hysteresis f_u	μm	5
Partial measuring span f_t	μm	5
Repeatability f_w	μm	3

Order no.	c	d	e	f	Mounting shaft	Measuring anvil length
	mm	mm	mm	mm	mm	mm
4305120	13.6	17.8	75	99	8	14.5
4306120	40.3	44.6	102	126	8	41.24

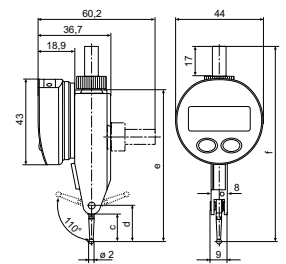

ACCESSORIES

Order no.	Description	Type
4305870	Stylus $\varnothing 1.0$ mm, carbide, $l = 14.5$ mm	800 ts
4305850	Stylus $\varnothing 2.0$ mm, carbide, $l = 14.5$ mm	800 ts
4305871	Stylus $\varnothing 3.0$ mm, carbide, $l = 14.5$ mm	800 ts
4102520	Battery 3 V, CR 2032	
4305122	Data connection cable RS232C (2 m)	800 EWr
4305121	800 EWu data connection cable USB (2 m)	800 EWu
4309051	Stylus $\varnothing 2.0$ mm, ruby, $l = 14.5$ mm	800 tsr
4306850	Stylus $\varnothing 2.0$ mm, carbide, $l = 41.24$ mm	800 tl
4306851	Stylus $\varnothing 1.0$ mm, carbide, $l = 41.24$ mm	800 tl
4306853	Stylus $\varnothing 3.0$ mm, carbide, $l = 41.24$ mm	800 tl
4309053	Stylus $\varnothing 2.0$ mm, ruby, $l = 41.24$ mm	800 tlr

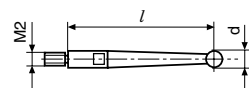

MarTest 800 a4 / 800 a6 / 800 a8 / 800 a3/8 / 800 a1/4"

Mounting shaft

FEATURES

- Clamping shafts on the housing can be moved on dovetail guide rails
- Clamping in any position with milled nut (no tools required)



TECHNICAL DATA

Order no.	Type
4305885	800 a4
4301865	800 a6
4305865	800 a8
4305875	800 a3/8
4305895	800 a1/4"

Order no.	Mounting shaft	Mounting shaft
	inch	mm
4305885		4
4301865		6
4305865		8
4305875	0.375	
4305895	0.25	

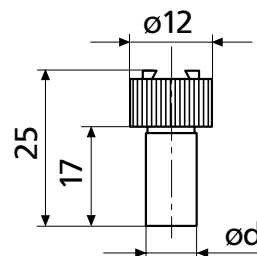

MarTest 800 h1

Holder

FEATURES

- Used for holding dial test indicator measuring devices on machine tools in conjunction with the 800k universal clamp



TECHNICAL DATA

Order no.	Type
4305888	800 h1

Order no.	a	b	Cross-section
	mm	mm	mm
4305888	9	100	9x9

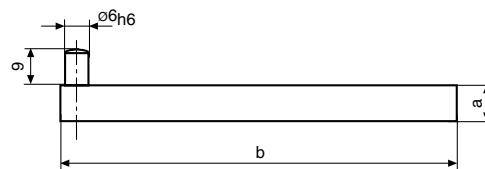

ACCESSORIES

Order no.	Description	Type
4305891	Universal clamp, $\varnothing d1 = 4$ mm, $\varnothing d2 = 8$ mm, dovetail clamp	800 k8

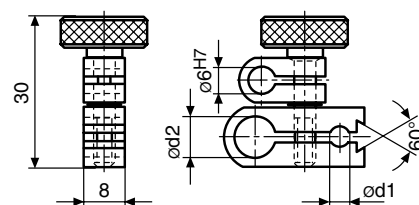

800 k8; 800 k3/8"

MarTest 800 hs8

Universal holder with dovetail clamp

FEATURES

- For aligning and centering workpieces on machine tools
- Pivoting holding clamp for dovetail



TECHNICAL DATA

Order no.	Type
4305886	800 hs8

Order no.	a	b	c
4305886	mm 100	mm 124	mm 8

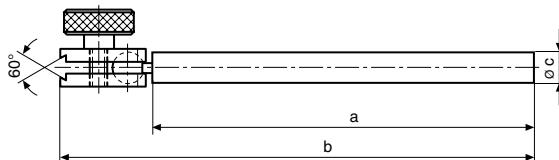

MarTest 801 v

Measuring and centering arm

FEATURES

- For aligning and centering workpieces on machine tools
- Pivoting holding clamp with integrated precision adjustment
- Stainless steel struts



TECHNICAL DATA

Order no.	Type
4309070	801 v

Order no.	Mounting hole	Swivel range of mounting clamp
4309070	8 mm	180

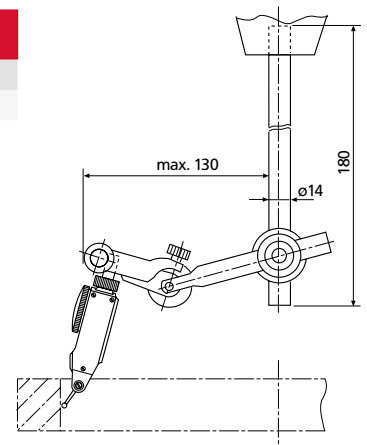

ACCESSORIES

Order no.	Description	Type
4305865	Mounting shaft \varnothing 8 mm	800 a8

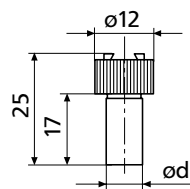

800 a8; 800 a1/4";
800 a4; 800 a3/8; 800 a6

MarTest 801 p

Measuring stand

FEATURES

Perfect for measurements with small dial indicators and dial test indicator measuring devices.

- Pivoting holder with \varnothing 8 and \varnothing 4 mm mount and dovetail profile for dial test indicator measuring devices
- Stainless steel column
- Base with V-groove



TECHNICAL DATA

Order no.	Type				
4309090	801 p				

Order no.	Mounting hole	Base surface	Height	V-angle	Column \varnothing
4309090	4 and 8 mm	65 x 40 mm	mm	$^{\circ}$	mm
			150	140	8

MarTest 800 b

Universal centering support frame

FEATURES

- For aligning and centering workpieces on machine tools
- Pivoting holding clamp



TECHNICAL DATA

Order no.	Type
4305893	800 b

Order no.	Mounting hole
4305893	4 mm

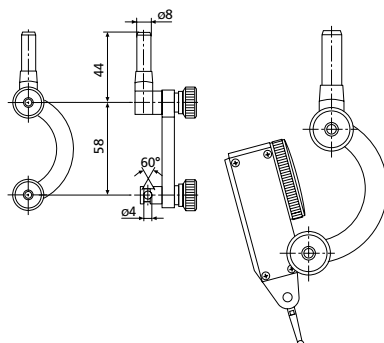

ACCESSORIES

Order no.	Description	Type
4305885	Mounting shaft ϕ 4 mm	800 a4

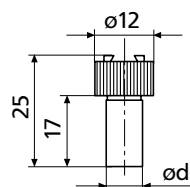

FUNCTIONS

- ON/OFF
- Auto OFF after 2 hours

FEATURES

- Excellent readability thanks to combined display:
 - bar graph for dynamic path information
 - digital display for exact readings
- Can be controlled independently of a machine tool
- Large working range in all axes (X, Y, Z) prevents damage to the stylus by contacting errors
- Compact metal housing and long probe arm
- Shockproof movement
- **Energy supply:** Battery life approx. 3 years
- **Battery type:** CR 2032 (3V Lithium)
- **IP protection category:** IP 65
- **Package contains:** battery, instruction manual, stylus 802 EWt

Applications:

Can be used on milling and CNC machines to

- Determine the zero position on workpieces
- Determine the center of bores
- Determine and correct the alignment of a workpiece and for the measurement of:
 - Lengths
 - Depths



TECHNICAL DATA

Order no.	4304300	
Standard		Factory standard
Type		802 EW
Measuring surface		carbide
Working areas, X-, Y-, Z-axis		-2 to 4 mm
Repeatability at zero point, unidirectional	inch	± 0.005 mm

Order no.	Mounting shaft
	mm
4304300	16

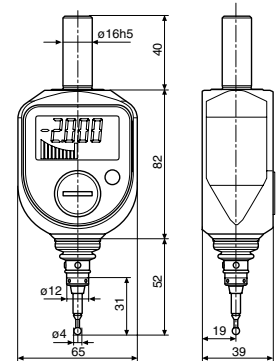

ACCESSORIES

Order no.	Description	Type
4304320	Stylus \varnothing 4.0 mm, l = 31 mm	802 EWt
4102520	Battery 3 V, CR 2032	

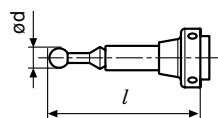

FEATURES

- Large, high contrast dial face
- Can be controlled independently of a machine tool
- Large working range in all axes (X, Y, Z) prevents damage to the stylus by contacting errors
- Compact metal housing and long probe arm
- High accuracy and linearity
- Shockproof and waterproof, ideal for the use on a machine with a tool changer
- **IP protection category:** IP 67
- **Package contains:** battery, instruction manual, stylus 802 EWt

Applications:

Can be used on milling and CNC machines to:

- Determine the zero position on workpieces
- Determine the center of bores
- Determine and correct the alignment of a workpiece and for the measurement of:
 - Lengths
 - Depths



TECHNICAL DATA

Order no.	4304311	
Standard	Factory standard	
Type	802 NW	
Readings	0.01	
Measuring surface	carbide	
Working areas, X-, Y-, Z-axis	6.6 mm	
Repeatability at zero point, unidirectional	inch	± 0.01 mm

Order no.	Mounting shaft
	mm
4304311	16

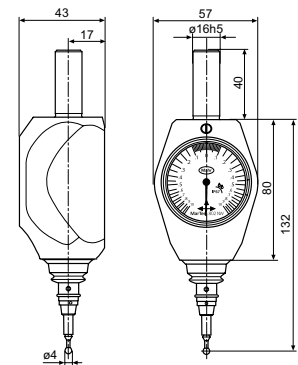

ACCESSORIES

Order no.	Description	Type
4304320	Stylus \varnothing 4.0 mm, l = 31 mm	802 EWt
4304321	Stylus \varnothing 6 mm, l = 56.6 mm	802 NWt

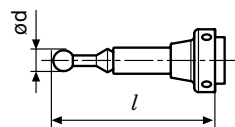

MarCator | Dial digital indicators

Whether mechanical or digital, dial indicators rank as some of the most commonly used measuring probes. MarCator dial indicators offer accurate measuring results, simple controls and a rugged construction for use on the shop floor.



Overview MarCator dial indicators	130
Digital dial indicators	
MarCator 1075 R Standard versions with numerical display	132
MarCator 1086 Ri / 1086 WRi / 1086 R / 1086 WR / 1086 R-HR With dynamic measuring functions and tolerance display	133
MarCator 1087 Ri / 1087 R / 1087 R-HR With combined numerical and digital display	140
MarCator 1087 BRi / 1087 BR For 2-point comparative measuring equipment	143
Dial indicators with scale display	
MarCator 803 S / 803 A / 805 A Small dial indicators	145
MarCator 810 S / 810 A / 810 AT / 810 SV / 810 AU Standard versions	146
MarCator 810 SM / 810 SRM / 810 AX Safety dial indicator with scale graduation 0.001 mm / 0.1 mm	147
MarCator 810 SW / 803 SW Waterproof version (IP54)	149
MarCator 810 AZ / 803 AZ Dial indicator	150
MarCator 810 SB / 803 SB Version with limited measuring range	151
MarCator 810 AG Large dial indicator	152
Measuring anvils and accessories for dial indicators and dial comparators	153
MarCator 841 G Straight holder	158
MarCator 841 W Angular holder	159
MarCator 943 Sensor level	160
MarCator 837 Dial indicator depth measuring bridge	161
Dial indicators	162
MarCator 400B-3 / 400B-4 Mobile dial calibrator	181

MarCator | Digital and dial indicators

Digital dial indicators with Reference System and Integrated Wireless

With MarCator 1086 Ri and 1087 Ri, Mahr sets standards in the dial gage product segment:

With the Reference System, MarCator indicators are immediately ready for measurement, as the zero position once set remains stored for all further measurements. And if you need to document your data, Integrated Wireless, the integrated energy-efficient radio system, offers you the optimal solution for transferring the measured values to the PC.

Clear display

Tolerance display with measured value display. Display of the current value and the indicated tolerance.

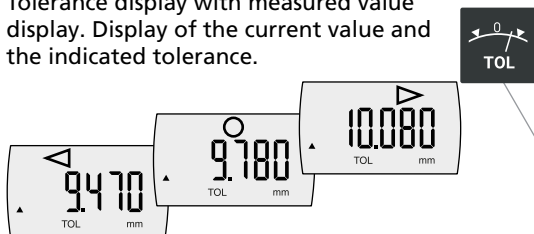

Tolerance display without measured value display. Tolerance overrange or underrange is indicated exclusively by symbols.

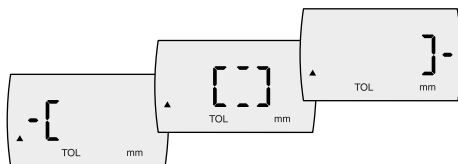

High operating reliability



Lock function prevents unintentional key operation. All keys or individual functions can be locked. If a locked key is pressed, "LOC" appears in the numeric display.

IP protection class IP54 (optional)



- Protective cap at the end of the measuring pin
- Rubber bellows on measuring pin
- Sealed battery compartment

Code Letters	IP	International Protection
First numeral	5	Dust protection (from harmful dust deposits)
Second numeral	4	Protection against water splash in all directions

Universal SPC interface



• Integrated Wireless

Radio interface at the price of a cable



• USB

No interface box necessary! Simple and cost-effective installation of multipoint measuring systems via USB hubs



• Digimatic

For connection to a digimatic compatible evaluation unit



• Mahr Opto RS232C

For direct connection to a COM port on the PC



Absolute-function:



Dial gage can be set to 0.000 in any position without losing reference to the preset value

3-year battery life

The Reference System is particularly energy-efficient. Since almost no energy is required when the system is idle, battery life is increased to 3 years*.

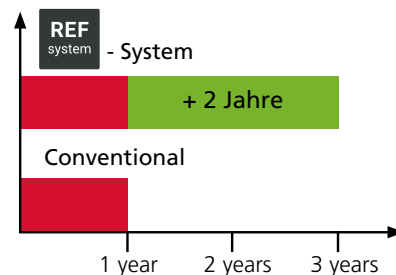

*When wireless transmission is deactivated

One-time zeroing



The digital indicators 1075 R, 1086 R(i) and 1087 R(i) are equipped with the innovative Reference System. Once the zero position has been set, it remains stored for all further measurements. This means that the instrument is immediately ready for measurement after pressing the ON button or simply by moving the measuring bolt. The need to reset the instrument to zero again after switching it on is no longer necessary like it is with conventional dial gages.

MarConnect Integrated Wireless – wireless transmission at the price of a cable



With Integrated Wireless, you get wireless data transmission for the price of a cable. Data acquisition with indicators is now even easier: Transfer your measurement data simply and without annoying cables directly into Microsoft® Office Excel® or via keyboard code into any Windows® program.

MarCator | Terms

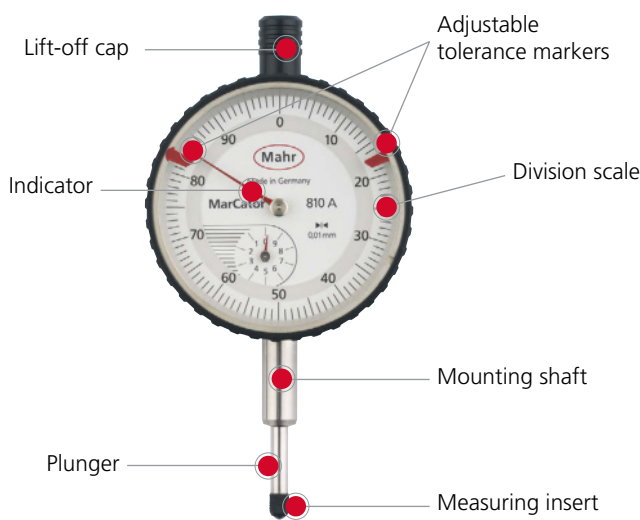

Metrological characteristics

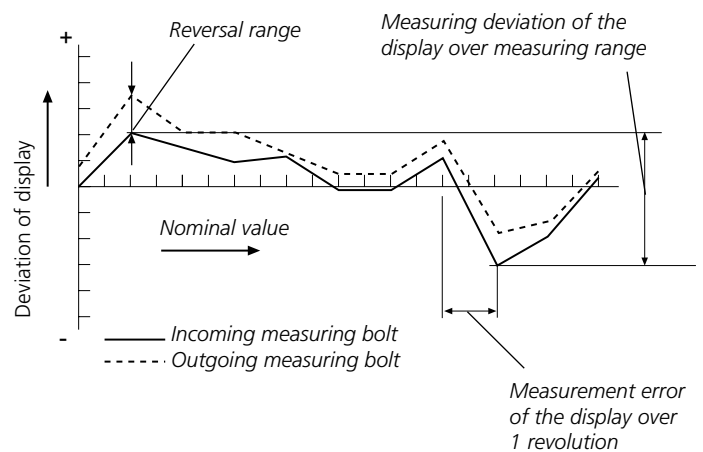

MarCator | Models

Small dial indicator 803 S

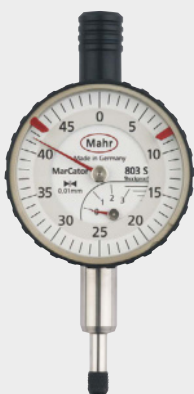

Dial indicator 810 S

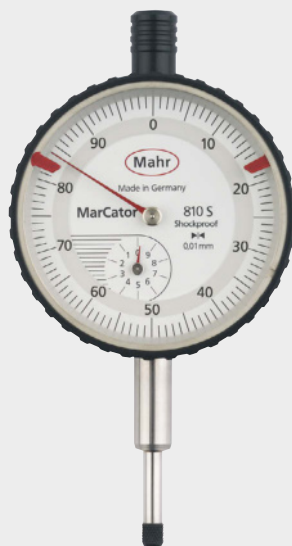

Digital indicator 1075 R



Digital indicator 1087 Ri



MarCator 1075 R

Digital indicator



FUNCTIONS

- ON/OFF
- RESET (set display to zero)
- mm/inch
- Reversal of counting direction
- PRESET (for entering a numerical value)
- DATA (data transmission via connection cable)
- LOCK function (key lock)
- AUTO-ON / OFF



FEATURES

- High contrast LCD display
- Hermetically sealed protective measuring spindle cap
- Mounting shank and measuring spindle are both made of hardened stainless steel
- **Software:** MarCom Professional free download: www.mahr.com/marcom (only for Mahr data cables and wireless systems with USB and RS-232 interface)
- **Digit height:** 12 mm
- **Data interface:** Digimatic, Opto RS-232C, USB
- **Energy supply:** Battery life approx. 3 years
- **Battery type:** CR 2032 (3V Lithium)
- **IP protection category:** IP 52
- **Package contains:** battery, instruction manual

Application:

- Simple measuring function for static measurements such as lengths, distances and length differences

TECHNICAL DATA

Order no.	4336010	4336020	4336030	
Type	1075 R			
Measuring span	mm	12.5		
Measuring span	inch	.5"		
Resolution	mm	0.01	0.005	0.001
Resolution	inch	.0005"	.0001"	.00005"
Error limit	mm	0.02	0.015	0.005
Measuring force	N	0.5 – 1		
Standard	Factory standard			
Protective measuring spindle cap	•			

Order no.	Mounting shaft
	mm
4336010	8
4336020	8
4336030	8

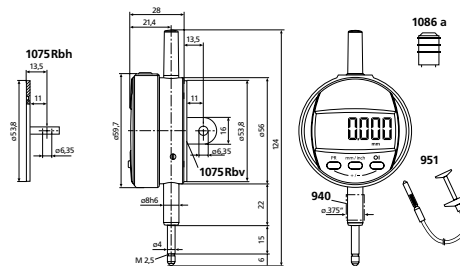

ACCESSORIES

Order no.	Description	Type
4102357	16 EXu data connection cable USB (2 m)	16 EXu
4102915	Interface adapter with data cable Digimatic (2 m)	16 EWd
4102410	Data connection cable RS232C (2 m)	16 EXr
4310103	Adapter bushing (.375" / 8 mm)	940
4372000	Cable release (250 mm)	951
4375004	Protective cap for 1075 R / 1086 R / 1087 R	1086 s
4337320	Lift-off cap, complete 12.5 / 25 mm	
4336041	Lug back, horizontal	1075 Rbh
4336042	Lug back, vertical	1075 Rbv

MarCator 1086 Ri

Digital indicator



FUNCTIONS

- ON/OFF
- RESET (set display to zero)
- mm/inch
- Reversal of counting direction
- PRESET (for entering a numerical value)
- TOL (enter tolerance limit values)
- <0> (tolerance GO / NO GO display mode)
- ABS (display can be set to zero without losing reference to preset)
- DATA (data transmission)
- Factor (adjustable)
- LOCK (individual key lock)

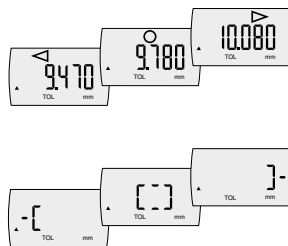

Application:

- Comprehensive measuring function for static measurements such as lengths, distances and length differences

FEATURES

- Integrated wireless transmitter
- High contrast LCD
- Operating and display unit (bezel) can be rotated through 280°
- Mounting shank and measuring spindle are both made of hardened stainless steel
- Immediate measurements due to the Reference System
- **Software:** MarCom Professional free download: www.mahr.com/marcom (only for Mahr data cables and wireless systems with USB and RS-232 interface)
- **Digit height:** 11 mm
- **Data interface:** Integrated wireless, USB, Digimatic, Opto RS-232C
- **Battery type:** CR 2450N (3V Lithium)
- **IP protection category:** IP 42
- **Package contains:** instruction manual, battery

TECHNICAL DATA

Order no.		4337624	4337625	4337626	4337627	4337628
Type		1086 Ri				
Measuring span	mm	12.5	25	50	100	25
Measuring span	inch	.5"	1"	2"	4"	1"
Resolution	mm	0.0005, 0.001, 0.002, 0.005, 0.01				
Resolution	inch	.00002", .00005", .0001", .0002", .0005"				
Error limit	mm	0.004				
Error limit over 50 graduations	mm	0.002				
Measuring force	N	0.65 - 0.9	0.65 - 1.15	1.25 - 2.7	1.8 - 3.5	0 - 0
Standard		Factory standard				
Lifting protection cap		•				

Order no.	a	b	c	Mounting shaft
	mm	mm	mm	mm
4337624	126.3	23	13.5	8
4337625	153.4	26.8	26.5	8
4337626	267.3	40	52	8
4337627	420.3	91	103	8
4337628	153.4	26.8	26.5	8

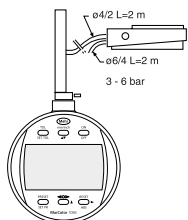
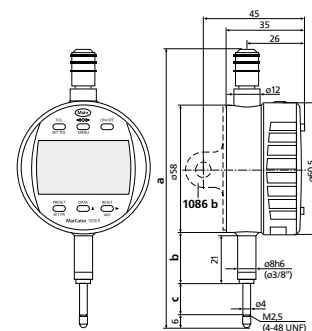

1082 p

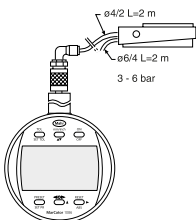

1082 p

ACCESSORIES

Order no.	Description	Type
4102220	Receiver for instruments with Integrated Wireless	i-Stick
4102357	16 EXu data connection cable USB (2 m)	16 EXu
4102915	Interface adapter with data cable Digimatic (2 m)	16 EWd
4102410	Data connection cable RS232C (2 m)	16 EXr
4375004	Protective cap for 1075 R / 1086 R / 1087 R	1086 s
4337421	Lug back	1086 b
4336311	Cable release (12.5 + 25 mm)	1085 a
4336237	Pneumatic lifting (12.5 + 25 mm)	1082 p
4310103	Adapter bushing (.375" / 8 mm)	940
4336230	Pneumatic lifting (50 + 100 mm)	1082 p

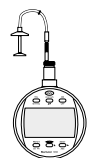

1085 a



i-Stick

MarCator 1086 Ri

Digital indicator



FUNCTIONS

- ON/OFF
- RESET (set display to zero)
- mm/inch
- Reversal of counting direction
- PRESET (for entering a numerical value)
- TOL (enter tolerance limit values)
- <0> (tolerance GO / NO GO display mode)
- ABS (display can be set to zero without losing reference to preset)
- DATA (data transmission)
- Factor (adjustable)
- LOCK (individual key lock)

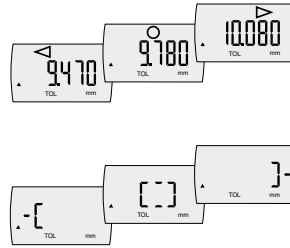

Application:

- Comprehensive measuring function for static measurements such as lengths, distances and length differences

FEATURES

- Integrated Wireless transmitter
- High contrast LCD display
- Operating and display unit (bezel) can be rotated through 280°
- Mounting shank and measuring spindle are both made of hardened stainless steel
- Immediate measurements due to the Reference System
- **Software:** MarCom Professional free download: www.mahr.com/marcom (only for Mahr data cables and wireless systems with USB and RS-232C interface)
- **Digit height:** 11 mm
- **Data interface:** Integrated Wireless, USB, Digimatic, Opto RS-232C
- **Battery type:** CR 2450N (3V Lithium)
- **IP protection category:** IP 42
- **Package contains:** instruction manual, battery

TECHNICAL DATA

Order no.	4337134	4337135
Type	1086 Ri	
Measuring span	mm 12.5	25
Measuring span	inch .5"	1"
Resolution	mm 0.01	
Resolution	inch .0005"	
Error limit	mm 0.02	
Error limit over 50 graduations	mm 0.02	
Measuring force	N 0.65 – 0.9	0.65 – 1.15
Standard	Factory standard	
Lifting protection cap	•	

Order no.	a	b	c	Mounting shaft
	mm	mm	mm	mm
4337134	126.3	23	13.5	8
4337135	153.4	26.8	26.5	8

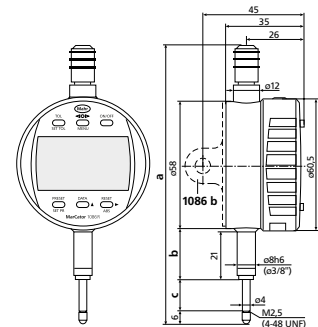

ACCESSORIES

Order no.	Description	Type
4102220	Receiver for instruments with Integrated Wireless	i-Stick
4102357	16 EXu data connection cable USB (2 m)	16 EXu
4102915	Interface adapter with data cable Digimatic (2 m)	16 EWd
4102410	Data connection cable RS232C (2 m)	16 EXr
4375004	Protective cap for 1075 R / 1086 R / 1087 R	1086 s
4337421	Lug back	1086 b
4310103	Adapter bushing (.375" / 8 mm)	940
4336311	Cable release (12.5 + 25 mm)	1085 a
4336237	Pneumatic lifting (12.5 + 25 mm)	1082 p

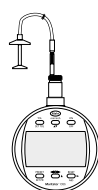

1085 a

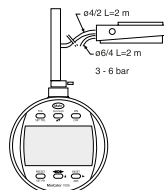

1082 p



i-Stick

MarCator 1086 WRi

Digital indicator



FUNCTIONS

- ON/OFF
- RESET (set display to zero)
- mm/inch
- Reversal of counting direction
- PRESET (for entering a numerical value)
- TOL (enter tolerance limit values)
- <0> (tolerance GO / NO GO display mode)
- ABS (display can be set to zero without losing reference to preset)
- DATA (data transmission)
- Factor (adjustable)
- LOCK (individual key lock)

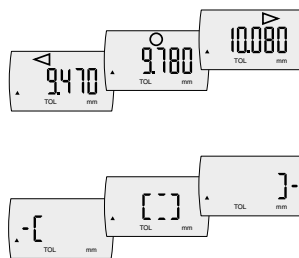

Application:

- Comprehensive measuring function for static measurements such as lengths, distances and length differences

FEATURES

- Integrated Wireless transmitter
- High contrast LCD display
- Operating and display unit (bezel) can be rotated through 280°
- Mounting shank and measuring spindle are both made of hardened stainless steel
- Immediate measurements due to the Reference System
- **Software:** MarCom Professional free download: www.mahr.com/marcom (only for Mahr data cables and wireless systems with USB and RS-232 interface)
- **Digit height:** 11 mm
- **Data interface:** Integrated Wireless, USB, Digimatic, Opto RS-232C
- **Battery type:** CR 2450N (3V Lithium)
- **IP protection category:** IP 54
- **Package contains:** instruction manual, battery

TECHNICAL DATA

Order no.	4337142	4337143
Type	1086 WRi	
Measuring span	mm 12.5	25
Measuring span	inch .5"	1"
Resolution	mm 0.0005, 0.001, 0.002, 0.005, 0.01	
Resolution	inch .00002", .00005", .0001", .0002", .0005"	
Error limit	mm 0.004	
Error limit over 50 graduations	mm 0.002	
Measuring force	N 0.65 – 1.4	1 – 2.25
Standard	Factory standard	
Protective measuring spindle cap	•	

Order no.	a	b	c	Mounting shaft
	mm	mm	mm	mm
4337142	144.3	21	28.5	8
4337143	193.2	24.8	50	8

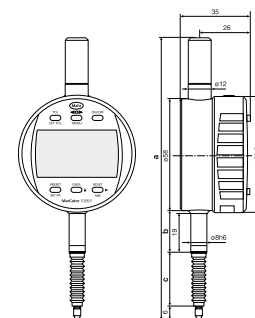

ACCESSORIES

Order no.	Description	Type
4102220	Receiver for instruments with Integrated Wireless	i-Stick
4102357	16 EXu data connection cable USB (2 m)	16 EXu
4102915	Interface adapter with data cable Digimatic (2 m)	16 EWd
4102410	Data connection cable RS232C (2 m)	16 EXr
4375004	Protective cap for 1075 R / 1086 R / 1087 R	1086 s
4337421	Lug back	1086 b
4336311	Cable release (12.5 + 25 mm)	1085 a
4310103	Adapter bushing (.375" / 8 mm)	940
4336237	Pneumatic lifting (12.5 + 25 mm)	1082 p
4337472-E	Rubber bellows (12.5 mm)	
4337474-E	Rubber bellows (25 mm)	

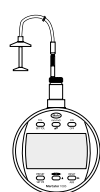

1085 a

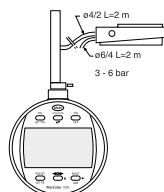

1082 p



i-Stick

MarCator 1086 R / 1086 ZR

Digital indicator



FUNCTIONS

- ON/OFF
- RESET (set display to zero)
- mm/inch
- Reversal of counting direction
- PRESET (for entering a numerical value)
- TOL (enter tolerance limit values)
- <0> (tolerance GO / NO GO display mode)
- ABS (display can be set to zero without losing reference to preset)
- DATA (data transmission via connection cable)
- Factor (adjustable)
- LOCK (individual key lock)

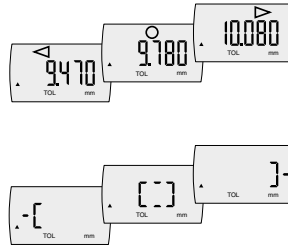

Application:

- Comprehensive measuring function for static measurements such as lengths, distances and length differences

FEATURES

- High contrast LCD display
- Operating and display unit (bezel) can be rotated through 280°
- Lifter protection cap on the measuring spindle
- Mounting shank and measuring spindle are both made of hardened stainless steel
- Immediate measurements due to the Reference System
- **Software:** MarCom Professional free download: www.mahr.com/marcom (only for Mahr data cables and wireless systems with USB and RS-232 interface)
- **Digit height:** 11 mm
- **Data interface:** Digimatic, Opto RS-232C, USB
- **Energy supply:** Battery life approx. 3 years
- **Battery type:** CR 2450N (3V Lithium)
- **IP protection category:** IP 42
- **Package contains:** instruction manual, battery

TECHNICAL DATA

Order no.	4337620	4337621	4337622	4337623	4337650	4337651
Type	1086 R			1086 ZR		
Measuring span	mm	12.5	25	50	100	12.5 25
Measuring span	inch	.5"	1"	2"	4"	.5" 1"
Resolution	mm	0.0005, 0.001, 0.002, 0.005, 0.01				
Resolution	inch	.00002", .00005", .0001", .0002", .0005"				
Error limit	mm	0.004	0.007	0.008	0.004	
Error limit over 50 graduations	mm	0.002				
Measuring force	N	0.65 - 0.9	0.65 - 1.15	1.25 - 2.7	1.8 - 3.5	0.65 - 0.9 0.9 - 1.15
Standard	Factory standard					

Order no.	a	b	c	Mounting shaft	Mounting shaft
	mm	mm	mm	inch	mm
4337620	126.3	23	13.5		8
4337621	153.4	26.8	26.5		8
4337622	267.3	40	52		8
4337623	420.3	91	103		8
4337650	126.3	23	13.5	0.375	
4337651	153.4	26.8	26.5	0.375	

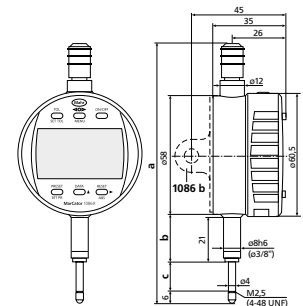

ACCESSORIES

Order no.	Description	Type
4102357	16 EXu data connection cable USB (2 m)	16 EXu
4102915	Interface adapter with data cable digimatic (2 m)	16 EWd
4102410	Data connection cable RS232C (2 m)	16 EXr
4375004	Protective cap for 1075 R / 1086 R / 1087 R	1086 s
4337421	Lug back	1086 b
4336311	Cable release (12.5 + 25 mm)	1085 a
4336237	Pneumatic lifting (12.5 + 25 mm)	1082 p
4310103	Adapter bushing (.375" / 8 mm)	940
4336230	Pneumatic lifting (50 + 100 mm)	1082 p

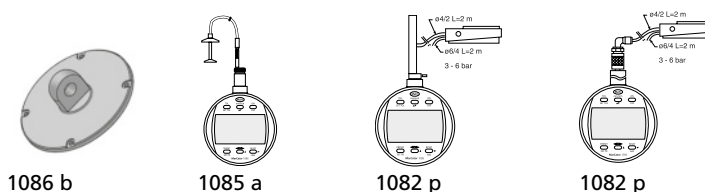

MarCator 1086 R

Digital indicator



FUNCTIONS

- ON/OFF
- RESET (set display to zero)
- mm/inch
- Reversal of counting direction
- PRESET (for entering a numerical value)
- TOL (enter tolerance limit values)
- <0> (tolerance GO / NO GO display mode)
- ABS (display can be set to zero without losing reference to preset)
- DATA (data transmission via connection cable)
- Factor (adjustable)
- LOCK (individual key lock)

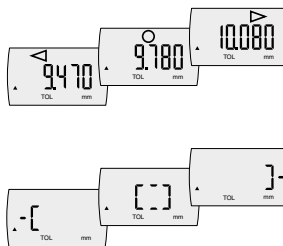

Application:

- Comprehensive measuring function for static measurements such as lengths, distances and length differences

FEATURES

- High contrast LCD display
- Operating and display unit (bezel) can be rotated through 280°
- Lifter protection cap on the measuring spindle
- Mounting shank and measuring spindle are both made of hardened stainless steel
- Immediate measurements due to the Reference System
- **Software:** MarCom Professional free download: www.mahr.com/marcom (only for Mahr data cables and wireless systems with USB and RS-232 interface)
- **Digit height:** 11 mm
- **Data interface:** Digimatic, Opto RS-232C, USB
- **Energy supply:** Battery life approx. 3 years
- **Battery type:** CR 2450N (3V Lithium)
- **IP protection category:** IP 24
- **Package contains:** instruction manual, battery

TECHNICAL DATA

Order no.	4337130	4337131	4337132	4337133	
Type	1086 R				
Measuring span	mm	12.5	25	50	100
Measuring span	inch	.5"	1"	2"	4"
Resolution	mm	0.01			
Resolution	inch	.0005"			
Error limit	mm	0.02			
Error limit over 50 graduations	mm	0.02			
Measuring force	N	0.65 – 0.9	0.65 – 1.15	1.25 – 2.7	1.6 – 3.5
Standard	Factory standard				
Lifting protection cap	•				

Order no.	a	b	c	Mounting shaft
	mm	mm	mm	mm
4337130	126.3	23	13.5	8
4337131	153.4	26.8	26.5	8
4337132	267.3	40	52	8
4337133	420.3	91	103	8

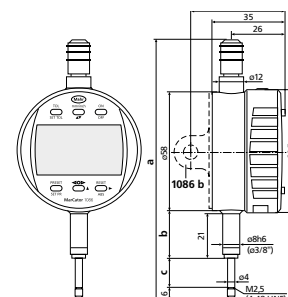

ACCESSORIES

Order no.	Description	Type
4102357	16 EXu data connection cable USB (2 m)	16 EXu
4102915	Interface adapter with data cable Digimatic (2 m)	16 EWD
4102410	Data connection cable RS232C (2 m)	16 EXr
4375004	Protective cap for 1075 R / 1086 R / 1087 R	1086 s
4337421	Lug back	1086 b
4336311	Cable release (12.5 + 25 mm)	1085 a
4336237	Pneumatic lifting (12.5 + 25 mm)	1082 p
4310103	Adapter bushing (.375" / 8 mm)	940
4336230	Pneumatic lifting (50 + 100 mm)	1082 p

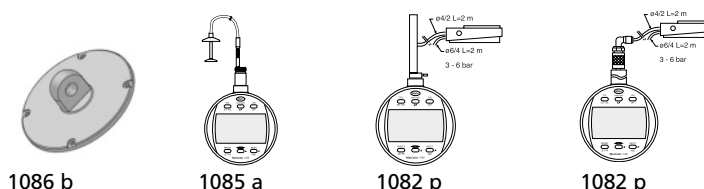

MarCator 1086 WR

Digital indicator



FUNCTIONS

- ON/OFF
- RESET (set display to zero)
- mm/inch
- Reversal of counting direction
- PRESET (for entering a numerical value)
- TOL (enter tolerance limit values)
- <0> (tolerance GO / NO GO display mode)
- ABS (display can be set to zero without losing reference to preset)
- DATA (data transmission via connection cable)
- Factor (adjustable)
- LOCK (individual key lock)

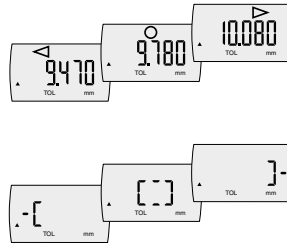

Application:

- Comprehensive measuring function for static measurements such as lengths, distances and length differences

FEATURES

- High contrast LCD display
- Operating and display unit (bezel) can be rotated through 280°
- Protection cap on the end of measuring spindle
- Mounting shank and measuring spindle are both made of hardened stainless steel
- Immediate measurements due to the Reference System
- **Software:** MarCom Professional free download: www.mahr.com/marcom (only for Mahr data cables and wireless systems with USB and RS-232 interface)
- **Digit height:** 11 mm
- **Data interface:** Digimatic, Opto RS-232C, USB
- **Energy supply:** Battery life approx. 3 years
- **Battery type:** CR 2450N (3V Lithium)
- **IP protection category:** IP 54
- **Package contains:** instruction manual, battery

TECHNICAL DATA

Order no.	4337640	4337641
Type	1086 WR	
Measuring span	mm 12.5	25
Measuring span	inch .5"	1"
Resolution	0.0005, 0.001, 0.002, 0.005, 0.01	
Resolution	.00002", .00005", .0001", .0002", .0005"	
Error limit	mm 0.004	
Error limit over 50 graduations	mm 0.002	
Measuring force	N 0.65 – 1.4	1 – 2.25
Standard	Factory standard	
Protective measuring spindle cap	•	

Order no.	a	b	c	Mounting shaft
	mm	mm	mm	mm
4337640	144.3	21	28.5	8
4337641	193.2	24.8	50	8

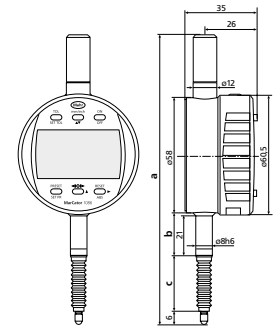

ACCESSORIES

Order no.	Description	Type
4102357	16 EXu data connection cable USB (2 m)	16 EXu
4102915	Interface adapter with data cable Digimatic (2 m)	16 EWd
4102410	Data connection cable RS232C (2 m)	16 EXr
4375004	Protective cap for 1075 R / 1086 R / 1087 R	1086 s
4337421	Lug back	1086 b
4336311	Cable release (12.5 + 25 mm)	1085 a
4336237	Pneumatic lifting (12.5 + 25 mm)	1082 p
4337472-E	Rubber bellows (12.5 mm)	
4310103	Adapter bushing (.375" / 8 mm)	940
4884464	Battery 3 V, CR 2450, Type CR 2450	
4337474-E	Rubber bellows (25 mm)	

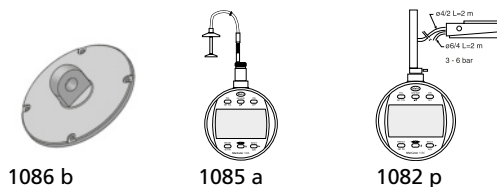

MarCator 1086 R-HR

Digital indicator



FUNCTIONS

- ON/OFF
- RESET (set display to zero)
- mm/inch
- Reversal of counting direction
- PRESET (for entering a numerical value)
- TOL (enter tolerance limit values)
- <0> (tolerance GO / NO GO display mode)
- ABS (display can be set to zero without losing reference to preset)
- DATA (data transmission via connection cable)
- Factor (adjustable)
- LOCK (individual key lock)



Applications:

- High-resolution measuring system with 0.1 μm resolution
- Extensive measuring functions for static measurements e.g. lengths, distances and length differences

FEATURES

- High contrast LCD display
- Operating and display unit (bezel) can be rotated through 280°
- Lifter protection cap on the measuring spindle
- Mounting shank and measuring spindle are both made of hardened stainless steel
- Immediate measurements due to the Reference System
- **Software:** MarCom Professional free download: www.mahr.com/marcom (only for Mahr data cables and wireless systems with USB and RS-232 interface)
- **Digit height:** 11 mm
- **Data interface:** Digimatic, Opto RS-232C, USB
- **Energy supply:** Battery life approx. 3 years
- **Battery type:** CR 2450N (3V Lithium)
- **IP protection category:** IP 42
- **Package contains:** instruction manual, battery

TECHNICAL DATA

Order no.	4337697	4337698
Type	1086 R-HR	
Measuring span	mm	12.5
Measuring span	inch	.5"
Resolution	mm	0.0001, 0.0005, 0.001, 0.002, 0.005, 0.01
Resolution	inch	.00001", .00002", .00005", .0001", .0002", .0005"
Error limit	mm	0.0018
Error limit over 50 graduations	mm	0.0005
Measuring force	N	0.65 – 0.9
Standard	Factory standard	
Lifting protection cap	•	

Order no.	a	b	c	Mounting shaft
	mm	mm	mm	mm
4337697	126.3	23	13.5	8
4337698	153.4	26.8	26.5	8

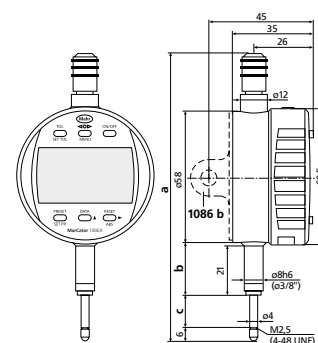

ACCESSORIES

Order no.	Description	Type
4102357	16 EXu data connection cable USB (2 m)	16 EXu
4102915	Interface adapter with data cable Digimatic (2 m)	16 EWd
4102410	Data connection cable RS232C (2 m)	16 EXr
4375004	Protective cap for 1075 R / 1086 R / 1087 R	1086 s
4337421	Lug back	1086 b
4336311	Cable release (12.5 + 25 mm)	1085 a
4336237	Pneumatic lifting (12.5 + 25 mm)	1082 p
4310103	Adapter bushing (.375" / 8 mm)	940

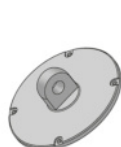

1086 b

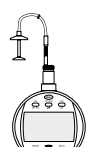

1085 a

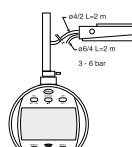

1082 p

MarCator 1087 Ri

Digital indicator



FUNCTIONS

- 0 (set the analog scale display to zero)
- ABS (display can be set to zero without losing reference to preset)
- AUTO-ON / OFF
- DATA (data transmission)
- Factor (adjustable)
- LOCK (individual key lock)
- MAX/MIN memory for searching the reversal point
- ON/OFF
- PRESET (for entering a numerical value)
- RANGE (switch the measuring range and resolution)
- RESET (set display to zero)
- (MAX-MIN) for testing flatness and concentricity
- TOL (enter tolerance limit values)
- Reversal of counting direction
- mm/inch



Applications:

Comprehensive measuring functions for

- Static measurements such as lengths, distances and length differences
- Dynamic measurements such as radial runout, straightness and flatness via MAX / MIN / MAX-MIN functions

FEATURES

- Integrated Wireless transmitter
- High contrast LCD display
- Operating and display unit (bezel) can be rotated through 280°
- Lifter protection cap on the measuring spindle
- Clamping shaft and measuring pin made of hardened stainless steel
- Immediate measurements due to the Reference System
- **Software:** MarCom Professional free download: www.mahr.com/marcom (only for Mahr data cables and wireless systems with USB and RS-232 interface)
- **Digit height:** 8,5 mm
- **Data interface:** Integrated Wireless, USB, Digimatic, Opto RS-232C
- **Energy supply:** battery operation
- **Battery type:** CR 2450N (3V Lithium)
- **IP protection category:** IP 42
- **Package contains:** instruction manual, battery

TECHNICAL DATA

Order no.	4337663	4337665	4337667
Type	1087 Ri		
Measuring span	mm	12.5	25
Measuring span	inch	.5"	1"
Resolution	mm	0.0005, 0.001, 0.002, 0.005, 0.01	
Resolution	inch	.00002", .00005", .0001", .0002", .0005"	
Scale graduation values	mm	0.0005, 0.001, 0.002, 0.005, 0.01	
Graduation values	inch	.000002", .00005", .0001", .0002", .0005"	
Range of analog display	mm	± 0.01, ± 0.02, ± 0.04, ± 0.1, ± 0.2	
Range of analog display	inch	± .0004", ± .001", ± .002", ± .004", ± .01"	
Error limit	mm	0.004	
Error limit over 50 graduations	mm	0.002	
Measuring force	N	0.65 – 0.85	0.65 – 0.9
Standard	Factory standard		
Lifting protection cap	•		

Order no.	a	b	c	Mounting shaft
	mm	mm	mm	mm
4337663	126.3	23	13.5	8
4337665	153.4	26.8	26.5	8
4337667	267.3	40	52	8

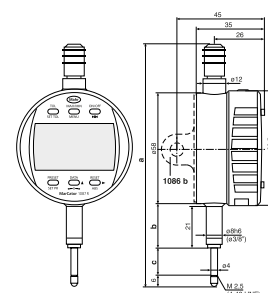

ACCESSORIES

Order no.	Description	Type
4102220	Receiver for instruments with Integrated Wireless	i-Stick
4102357	16 EXu data connection cable USB (2 m)	16 EXu
4102915	Interface adapter with data cable Digimatic (2 m)	16 EWd
4102410	Data connection cable RS232C (2 m)	16 EXr
4375004	Protective cap for 1075 R / 1086 R / 1087 R	1086 s
4337421	Lug back	1086 b
4336237	Pneumatic lifting (12.5 + 25 mm)	1082 p
4336311	Cable release (12.5 + 25 mm)	1085 a
4310103	Adapter bushing (.375" / 8 mm)	940
4336230	Pneumatic lifting (50 + 100 mm)	1082 p

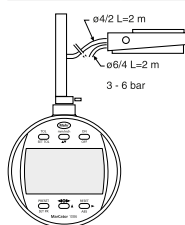

1082 p

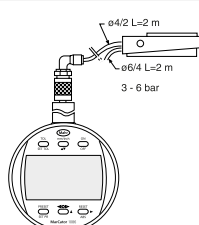

1082 p

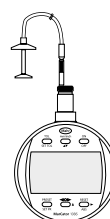

1085 a



i-Stick



1086 b

MarCator 1087 R / 1087 ZR

Digital indicator



FUNCTIONS

- ON/OFF
- RESET (set display to zero)
- mm/inch
- Reversal of counting direction
- PRESET (for entering a numerical value)
- TOL (enter tolerance limit values)
- MAX/MIN memory for searching the reversal point
- (MAX-MIN) for testing flatness and concentricity
- ABS (display can be set to zero without losing reference to preset)
- DATA (data transmission via connection cable)
- Factor (adjustable)
- LOCK (individual key lock)



Applications:

- Comprehensive measuring functions for
- Static measurements such as lengths, distances and length differences
 - Dynamic measurements such as radial runout, straightness and flatness via MAX / MIN / MAX-MIN functions

FEATURES

- High contrast LCD display, thus very clear and safe to read
- Operating and display unit (bezel) can be rotated through 280°
- Immediate measurements due to the Reference System
- Lifter protection cap on the measuring spindle
- Mounting shank and measuring spindle are both made of hardened stainless steel
- **Software:** MarCom Professional free download: www.mahr.com/marcom (only for Mahr data cables and wireless systems with USB and RS-232 interface)
- **Digit height:** 8,5 mm
- **Data interface:** Opto RS-232C, Digimatic, USB
- **Energy supply:** Battery life approx. 3 years
- **Battery type:** CR 2450N (3V Lithium)
- **IP protection category:** IP 42
- **Package contains:** instruction manual, battery

TECHNICAL DATA

Order no.		4337660	4337661	4337666	4337670	4337671
Type		1087 R			1087 ZR	
Measuring span	mm	12.5	25	50	12.5	25
Measuring span	inch	.5"	1"	2"	.5"	1"
Resolution	mm	0.0005, 0.001, 0.002, 0.005, 0.01				
Resolution	inch	.00002", .00005", .0001", .0002", .0005"				
Scale graduation values	mm	0.0005, 0.001, 0.002, 0.005, 0.01				
Graduation values	inch	.000002", .00005", .0001", .0002", .0005"				
Range of analog display	mm	± 0.01, ± 0.02, ± 0.04, ± 0.1, ± 0.2				
Range of analog display	inch	± .0004", ± .001", ± .002", ± .004", ± .01"				
Error limit	mm	0.004			0.007	
Error limit over 50 graduations	mm	0.002				
Measuring force	N	0.65 – 0.9	0.65 – 1.15	1.25 – 2.7	0.65 – 0.9	0.65 – 1.15
Standard		Factory standard				
Lifting protection cap		•				

Order no.	a	b	c	Mounting shaft	Mounting shaft
	mm	mm	mm	inch	mm
4337660	126.3	23	13.5		8
4337661	153.4	26.8	26.5		8
4337666	267.3	40	52		8
4337670	126.3	23	13.5	0.375	
4337671	153.4	26.8	26.5	0.375	

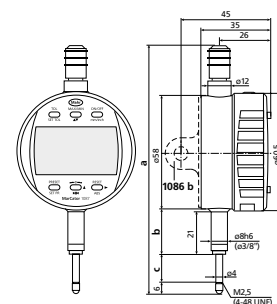

ACCESSORIES

Order no.	Description	Type
4102357	16 EXu Data connection cable USB (2 m)	16 EXu
4102915	Interface adapter with data cable Digimatic (2 m)	16 EWd
4102410	Data connection cable RS232C (2 m)	16 EXr
4375004	Protective cap for 1075 R / 1086 R / 1087 R	1086 s
4337421	Lug back	1086 b
4336237	Pneumatic lifting (12.5 + 25 mm)	1082 p
4336311	Cable release (12.5 + 25 mm)	1085 a
4310103	Adapter bushing (.375" / 8 mm)	940
4336230	Pneumatic lifting (50 + 100 mm)	1082 p

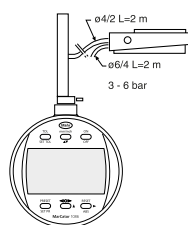

1082 p

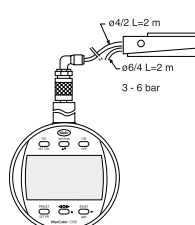

1082 p

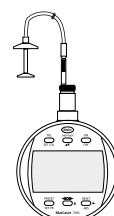

1085 a

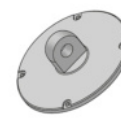

1086 b

MarCator 1087 R-HR

Digital indicator



FUNCTIONS

- ON/OFF
- RESET (set display to zero)
- mm/inch
- Reversal of counting direction
- PRESET (for entering a numerical value)
- TOL (enter tolerance limit values)
- MAX/MIN memory for searching the reversal point
- (MAX-MIN) for testing flatness and concentricity
- ABS (display can be set to zero without losing reference to preset)
- DATA (data transmission via connection cable)
- Factor (adjustable)
- LOCK (individual key lock)



Applications:

High-resolution model: Resolution 0.1 μm

- Extensive measuring functions for:
 - Static measurements e.g. lengths, distances and length differences
 - Dynamic measurements e.g. radial runout, straightness and flatness, by means of MAX / MIN / MAX-MIN functions

FEATURES

- High contrast LCD display
- Operating and display unit (bezel) can be rotated through 280°
- Immediate measurements due to the Reference System
- Lifter protection cap on the measuring spindle
- Mounting shank and measuring spindle are both made of hardened stainless steel
- **Software:** MarCom Professional free download: www.mahr.com/marcom (only for Mahr data cables and wireless systems with USB and RS-232 interface)
- **Digit height:** 8,5 mm
- **Data interface:** Opto RS-232C, Digimatic, USB
- **Energy supply:** Battery life approx. 3 years
- **Battery type:** CR 2450N (3V Lithium)
- **IP protection category:** IP 24
- **Package contains:** instruction manual, battery

TECHNICAL DATA

Order no.	4337695	4337696
Type	1087 R-HR	
Measuring span	mm	12.5
Measuring span	inch	.5"
Resolution	mm	0.0001, 0.0005, 0.001, 0.002, 0.005, 0.01
Resolution	inch	.00001", .00002", .00005", .0001", .0002", .0005"
Range of analog display	mm	± 0.002, ± 0.01, ± 0.02, ± 0.04, ± 0.1, ± 0.2
Range of analog display	inch	± .0002", ± .0004", ± .001", ± .002", ± .004", ± .01"
Error limit	mm	0.0018
Error limit over 50 graduations	mm	0.0005
Measuring force	N	0.65 – 0.9
Standard	Factory standard	
Lifting protection cap	•	

Order no.	a	b	c	Mounting shaft
	mm	mm	mm	mm
4337695	126.3	23	13.5	8
4337696	153.4	26.8	26.5	8

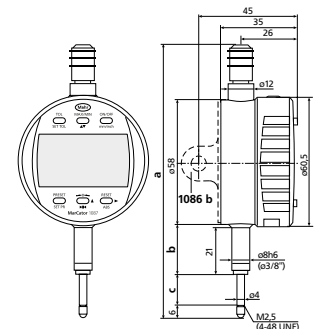

ACCESSORIES

Order no.	Description	Type
4102357	16 EXu data connection cable USB (2 m)	16 EXu
4102915	Interface adapter with data cable Digimatic (2 m)	16 EWd
4102410	Data connection cable RS232C (2 m)	16 EXr
4375004	Protective cap for 1075 R / 1086 R / 1087 R	1086 s
4337421	Lug back	1086 b
4336311	Cable release (12.5 + 25 mm)	1085 a
4336237	Pneumatic lifting (12.5 + 25 mm)	1082 p
4310103	Adapter bushing (.375" / 8 mm)	940

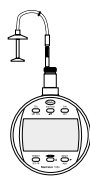

1085 a

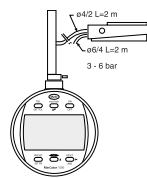

1082 p

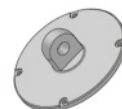

1086 b

MarCator 1087 BRi

Digital indicator



FUNCTIONS

- ON/OFF
- RESET (set display to zero)
- mm/inch
- PRESET (for entering a numerical value)
- Reversal of counting direction
- TOL (enter tolerance limit values)
- START/STOP search for reversal point
- MAX/MIN memory for searching the reversal point
- ABS (display can be set to zero without losing reference to preset)
- 0 (set the analog scale display to zero)
- DATA (data transmission)
- Factor (adjustable)
- LOCK (individual key lock)

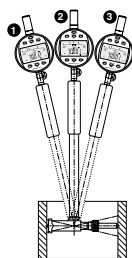

Applications:

- In measurements with a 2-point bore gage the reversing point can be calculated automatically during oscillation. Then a PRESET value can be assigned.
- The ACTUAL value measured is saved by the MIN or MAX function and is shown on the display.
- The 1087 BRi model can process 64 measured values per second, for fast measuring movements combined with measuring certainty.

FEATURES

- Integrated wireless transmitter
- High contrast LCD display
- Operating and display unit (bezel) can be rotated through 280°
- Lifter protection cap on the measuring spindle
- Clamping shaft and measuring pin made of hardened stainless steel
- Immediate measurements due to the Reference System
- **Software:** MarCom Professional free download: www.mahr.com/marcom (only for Mahr data cables and wireless systems with USB and RS-232 interface)
- **Digit height:** 8,5 mm
- **Data interface:** Integrated Wireless, USB, Digimatic, Opto RS-232C
- **Energy supply:** Battery life approx. 3 years
- **Battery type:** CR 2450N (3V Lithium)
- **IP protection category:** IP 42
- **Package contains:** instruction manual, battery

TECHNICAL DATA

Order no.	4337664		
Type	1087 BRi		
Measuring span	mm	12.5	
Measuring span	inch	.5"	
Resolution	mm	0.0005, 0.001, 0.002, 0.005, 0.01	
Resolution	inch	.00002", .00005", .0001", .0002", .0005"	
Scale graduation values	mm	0.0005, 0.001, 0.002, 0.005, 0.01	
Graduation values	inch	.000002", .00005", .0001", .0002", .0005"	
Range of analog display	mm	± 0.01, ± 0.02, ± 0.04, ± 0.1, ± 0.2	
Range of analog display	inch	± .0004", ± .001", ± .002", ± .004", ± .01"	
Error limit	mm	0.004	
Error limit over 50 graduations	mm	0.002	
Measuring force	N	0.65 – 0.9	
Standard	Factory standard		
Protective measuring spindle cap	•		

Order no.	a	b	c	Mounting shaft
	mm	mm	mm	mm
4337664	126.3	23	13.5	8

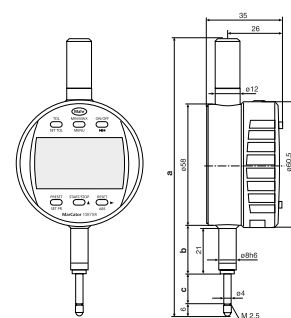

ACCESSORIES

Order no.	Description	Type
4102220	Receiver for instruments with Integrated Wireless	i-Stick
4102357	16 EXu data connection cable USB (2 m)	16 EXu
4102915	Interface adapter with data cable Digimatic (2 m)	16 EWd
4102410	Data connection cable RS232C (2 m)	16 EXr
4375004	Protective cap for 1075 R / 1086 R / 1087 R	1086 s
4310103	Adapter bushing (.375" / 8 mm)	940



i-Stick

MarCator 1087 BR

Digital indicator



FUNCTIONS

- ON/OFF
- RESET (set display to zero)
- mm/inch
- PRESET (for entering a numerical value)
- Reversal of counting direction
- TOL (enter tolerance limit values)
- START/STOP search for reversal point
- MAX/MIN memory for searching the reversal point
- ABS (display can be set to zero without losing reference to preset)
- 0 (set the analog scale display to zero)
- DATA (data transmission via connection cable)
- Factor (adjustable)

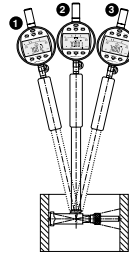

Applications:

- In measurements with a 2-point bore gage the reversing point can be calculated automatically during oscillation. Then a PRESET value can be assigned.
- The ACTUAL value measured is saved by the MIN or MAX function and is shown on the display.
- The 1087 BR model can process 64 measured values per second, for fast measuring movements combined with measuring certainty.

FEATURES

- High contrast LCD display
- Operating and display unit (bezel) can be rotated through 280°
- Immediate measurements due to the Reference System
- Mounting shank and measuring spindle are both made of hardened stainless steel
- Protection cap on the end of measuring spindle
- **Software:** MarCom Professional free download: www.mahr.com/marcom (only for Mahr data cables and wireless systems with USB and RS-232 interface)
- **Digit height:** 8,5 mm
- **Data interface:** Opto RS-232C, Digimatic, USB
- **Energy supply:** Battery life approx. 3 years
- **Battery type:** CR 2450N (3V Lithium)
- **IP protection category:** IP 42
- **Package contains:** instruction manual, battery

TECHNICAL DATA

Order no.	4337662		
Type	1087 BR		
Measuring span	mm	12.5	
Measuring span	inch	.5"	
Resolution	mm	0.0005, 0.001, 0.002, 0.005, 0.01	
Resolution	inch	.00002", .00005", .0001", .0002", .0005"	
Scale graduation values	mm	0.0005, 0.001, 0.002, 0.005, 0.01	
Graduation values	inch	.000002", .000005", .0001", .0002", .0005"	
Range of analog display	mm	± 0.01, ± 0.02, ± 0.04, ± 0.1, ± 0.2	
Range of analog display	inch	± .0004", ± .001", ± .002", ± .004", ± .01"	
Error limit	mm	0.004	
Error limit over 50 graduations	mm	0.002	
Measuring force	N	0.65 – 0.9	
Standard	Factory standard		
Protective measuring spindle cap	•		

Order no.	a	b	c	Mounting shaft
	mm	mm	mm	mm
4337662	126.3	23	13.5	8

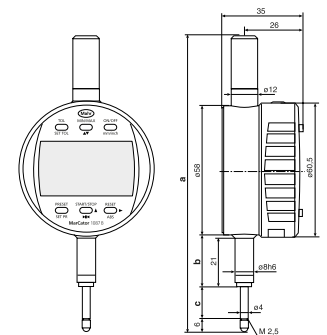

ACCESSORIES

Order no.	Description	Type
4102357	16 EXu Data connection cable USB (2 m)	16 EXu
4102915	Interface adapter with data cable Digimatic (2 m)	16 EWd
4102410	Data connection cable RS232C (2 m)	16 EXr
4375004	Protective cap for 1075 R / 1086 R / 1087 R	1086 s
4310103	Adapter bushing (.375" / 8 mm)	940

Small dial indicators

FEATURES

- High contrast dial face
- Adjustable tolerance markers
- Chrome plated housing
- Lifter protection cap on the measuring spindle
- Precision gears and pinions
- Package contains: case

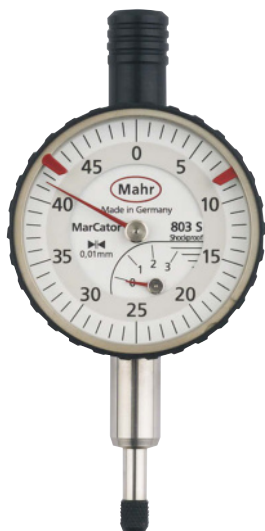

Application:

- To be used on all smaller indicating measuring instruments, or due to a confined space a smaller indicating instrument is required

TECHNICAL DATA

Order no.	4324000	4324050	4324060
Type	803 S	803 A	805 A
Measuring span	mm	3	5
Readings	mm	0.01	
Type of dial face		0 – 50	0 – 100
Error limit, measuring range	µm	10	12
Error limit, 1 revolution	µm	9	10
Error limit, 1/2 revolution	µm	8	9
Error limit, 1/10 revolution	µm		5
Repeatability f_w	µm		3
Measuring value hysteresis f_u	µm		3
Free stroke	mm		0.1
Measuring force incoming measuring pin	N		0.7 – 1.1
Standard		DIN 878	
Shockproof movement		•	
Lifting protection cap			•
Scale diameter	mm	34	
Range per turn	mm	0.5	1
Dial color		White	

Order no.	a	b	c	d	e	f	g	Mounting shaft
	mm	mm	mm	mm	mm	mm	mm	mm
4324000	40	20.6	6.8	37	80	15.5	5.5	8
4324050	40	20.6	6.8	37	83	15	8	8
4324060	40	20.6	6.8	37	83	15	8	8

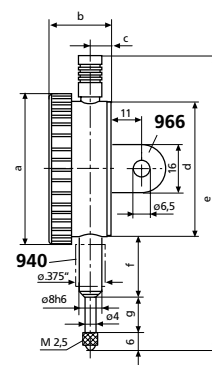

ACCESSORIES

Order no.	Description	Type
4310103	Adapter bushing (.375" / 8 mm)	940
4375020	Lug back, vertical, for 803	966
4375021	Lug back, horizontal, for 803	967

Dial indicator

FEATURES

- High contrast dial face
- Adjustable tolerance markers
- Chrome plated housing
- Lifter protection cap on the measuring spindle
- Precision gears and pinions
- Package contains: case

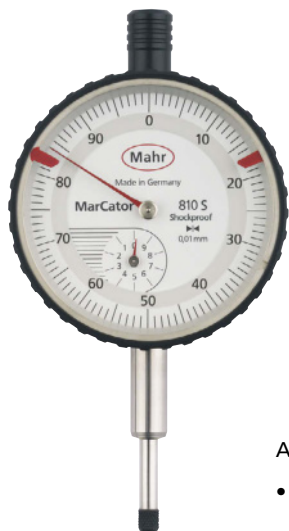

Application:

- 810 AU: The measuring pin is retracted by spring, contacting and the measuring force are triggered manually by pressing on the upper sleeve

TECHNICAL DATA

Order no.		4311000	4311050	4311060	4321000	4329050
Type		810 S	810 A	810 AT	810 SV	810 AU
Measuring span	mm		10		40	10
Readings	mm			0.01		
Type of dial face		0–100		100–0	0–100	100–0
Error limit, measuring range	µm		15		25	15
Error limit, 1 revolution	µm		10		15	10
Error limit, 1/2 revolution	µm		9		10	9
Error limit, 1/10 revolution	µm			5		
Repeatability f_w	µm		3			5
Measuring value hysteresis f_u	µm		3		6	
Free stroke	mm	0.1		0.8		0.1
Generation of measuring force						manual
Measuring force incoming measuring pin	N		0.7–1.3		0.8–1.8	-
Standard			DIN 878			Factory standard
Shockproof movement		•			•	
Lifting protection cap				•		
Reverse measuring force direction						•
Scale diameter	mm			50		
Range per turn	mm			1		
Dial color				White		

Order no.	a	b	c	d	e	f	g	Mounting shaft
	mm	mm	mm	mm	mm	mm	mm	mm
4311000	58	23	7.5	52	112	21	16	8
4311050	58	23	7.5	52	112	22	15	8
4311060	58	23	7.5	52	112	22	15	8
4321000	58	24.2	8.7	52	169	22	45	8
4329050	58	23	7.5	52	112	22	4.5	8

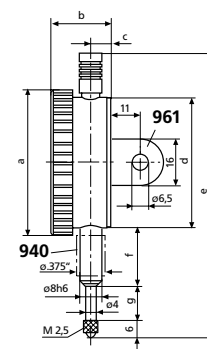

ACCESSORIES

Order no.	Description	Type
4310103	Adapter bushing (.375" / 8 mm)	940
4373020	Splash proof cap (58 mm)	955
4375010	Lug back, vertical, for 810	961
4375011	Lug back, horizontal, for 810	962

MarCator 810 SM / 810 SRM

Dial indicator

FEATURES

- High contrast dial face
- Adjustable tolerance markers
- Chrome plated housing
- Lifter protection cap on the measuring spindle
- Precise mechanism with a combined gear lever transmission
- High accuracy with a minimum span of error
- **Package contains:** case



TECHNICAL DATA

Order no.		4311070	4311080
Type		810 SM	810 SRM
Measuring span	mm	1	5
Readings	mm	0.001	
Type of dial face		0–100	0–100–0
Error limit, measuring range	µm	4	10
Error limit, 1 revolution	µm	3	5
Error limit, 1/2 revolution	µm	2	4
Error limit, 1/10 revolution	µm	1	3
Repeatability f_w	µm	1.5	3
Measuring value hysteresis f_u	µm	1.5	3
Free stroke	mm	4	0.1
Measuring force incoming measuring pin	N	1.3–1.8	1.2–1.7
Standard		Factory standard	
Shockproof movement		•	
Lifting protection cap		•	
Scale diameter	mm	50	
Range per turn	mm	0.1	0.2

Order no.	a	b	c	d	e	f	g	Mounting shaft
	mm	mm	mm	mm	mm	mm	mm	mm
4311070	58	23	8.5	52	111.5	22	15	8
4311080	58	23	7.5	52	111.5	22	15	8

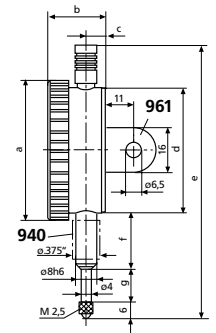

ACCESSORIES

Order no.	Description	Type
4310103	Adapter bushing (.375" / 8 mm)	940
4373020	Splash proof cap (58 mm)	955
4375010	Lug back, vertical, for 810	961
4375011	Lug back, horizontal, for 810	962

MarCator 810 AX

Dial indicator

FEATURES

- High contrast dial face
- Adjustable tolerance markers
- Chrome plated housing
- Lifter protection cap on the measuring spindle
- Precision gears and pinions
- Package contains: case



TECHNICAL DATA

Order no.	4331000	
Type	810 AX	
Measuring span	mm	10
Readings	mm	0.1
Type of dial face	0–10	
Error limit, measuring range	μm	50
Error limit, 1 revolution	μm	50
Error limit, 1/2 revolution	μm	40
Error limit, 1/10 revolution	μm	30
Repeatability f_w	μm	15
Measuring value hysteresis f_u	μm	15
Free stroke	mm	0.5
Measuring force incoming measuring pin	N	0.7–1.3
Standard	Factory standard	
Lifting protection cap	•	
Scale diameter	mm	50
Range per turn	mm	10
Dial color	White	

Order no.	Mounting shaft
	mm
4331000	8

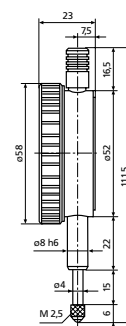

ACCESSORIES

Order no.	Description	Type
4310103	Adapter bushing (.375" / 8 mm)	940
4373020	Splash proof cap (58 mm)	955
4375010	Lug back, vertical, for 810	961
4375011	Lug back, horizontal, for 810	962

MarCator 810 SW / 803 SW

Dial indicator with IP protection



FEATURES

- High contrast dial face
- Adjustable tolerance markers
- Chrome plated housing
- Precision gears and pinions
- Hermetically sealed upper protective measuring spindle cap, bezel and transparent dial cover; sealed with O-rings
- Measuring spindle sealed with rubber sleeve, thus preventing contamination by liquids and impurities
- IP protection category: IP 54
- Package contains: case

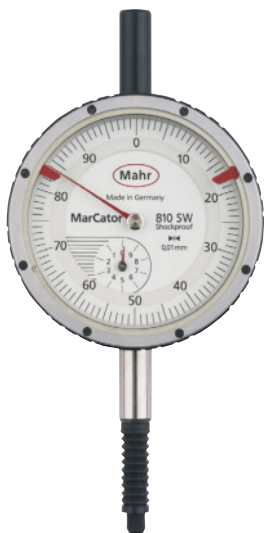

Application:

- Special design with IP protection against liquids and dust
- Ideal for use in particularly challenging environments where the dial gage is highly contaminated or exposed to splash water

TECHNICAL DATA

Order no.	4315000		4326000	
Type	810 SW		803 SW	
Measuring span	mm	10	3	
Readings	mm	0.01		
Type of dial face	0 – 100		0 – 50	
Error limit, measuring range	µm	15	10	
Error limit, 1 revolution	µm	10	9	
Error limit, 1/2 revolution	µm	9	8	
Error limit, 1/10 revolution	µm	5		
Repeatability f_w	µm	3		
Measuring value hysteresis f_u	µm	3		
Free stroke	mm	0.1		
Measuring force incoming measuring pin	N	0.7 – 1.6		0.7 – 1.7
Standard	DIN 878			
Shockproof movement	•			
Protective measuring spindle cap	•			
Range per turn	mm	1	0.5	
Dial color	White			

Order no.	a	b	c	d	e	f	g	Mounting shaft
4315000	61	24.2	7.9	52	127.6	22	22.1	8
4326000	44	21.6	7.1	37	86	15	11	8

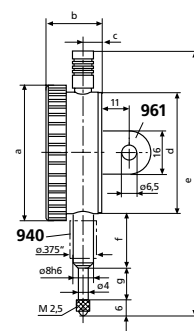

ACCESSORIES

Order no.	Description	Type
4310103	Adapter bushing (.375" / 8 mm)	940
4375010	Lug back, vertical, for 810	961
4375011	Lug back, horizontal, for 810	962
4375020	Lug back, vertical, for 803	966
4375021	Lug back, horizontal, for 803	967

MarCator 810 AZ / 803 AZ

Dial indicator

FEATURES

- High contrast dial face
- Adjustable tolerance markers
- Chrome plated housing
- Lifter protection cap on the measuring spindle
- Precision gears and pinions
- **Package contains:** adapter bush 940, 8 mm to 3/8", case

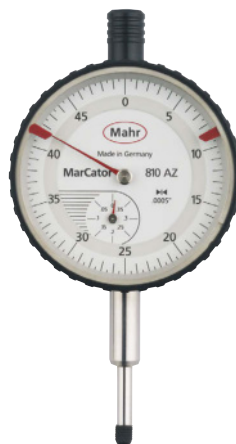

TECHNICAL DATA

Order no.		4311900	4324900
Type		810 AZ	803 AZ
Measuring span	inch	.400"	.120"
Scale graduation value	inch		.0005"
Type of dial face		0–50	0–20
Range per turn	inch	.05"	.02"
Error limit	inch	.0005"	.0004"
Error limit, 1/10 revolution	inch		.0002"
Repeatability f_w	inch		.00012"
Repeatability f_w	inch		0.0001
Measuring value hysteresis f_u	inch		.00012"
Free stroke	inch		.008"
Measuring force incoming measuring pin	N	0.9–1.5	0.7–1.1
Standard		Factory standard	
Lifting protection cap		•	
Scale diameter	inch	1.97	1.4
Range per turn	inch		.02"
Dial color		White	

Order no.	a	b	c	d	e	f	g	Mounting shaft	Mounting shaft
	mm	mm	mm	mm	mm	mm	mm	inch	mm
4311900	58	23	7.5	52	111.5	22	15	0.375	8
4324900	40	20.6	6.8	37	83	15.5	8	0.375	8

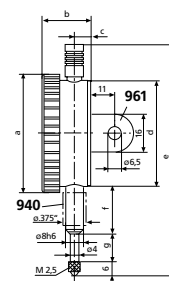

ACCESSORIES

Order no.	Description	Type
4310103	Adapter bushing (.375" / 8 mm)	940
4373020	Splash proof cap (58 mm)	955
4375010	Lug back, vertical, for 810	961
4375011	Lug back, horizontal, for 810	962
4375020	Lug back, vertical, for 803	966
4375021	Lug back, horizontal, for 803	967

Safety dial indicator

FEATURES

- High contrast dial face
- Adjustable tolerance markers
- Chrome plated housing
- Hermetically sealed protective measuring spindle cap
- Limited measuring range for error free readings
- Large overtravel (ca. 9 mm) for easier insertion of test items in measuring devices
- Precision gears and pinions
- Package contains: case

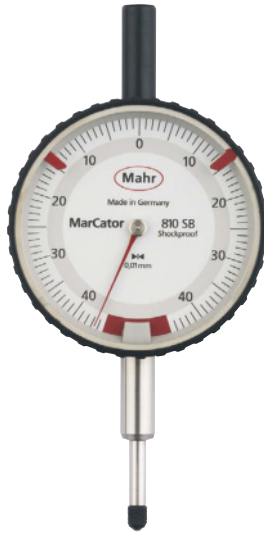

Applications:

- For safety reasons, the indication range of these dial indicators is limited to just under one pointer rotation.
- This prevents the risk of measuring errors arising from possible additional pointer rotations.

TECHNICAL DATA

Order no.		4317000	4324250
Type		810 SB	803 SB
Measuring span	mm	0.8	0,4
Readings	mm		0.01
Type of dial face		40 –0 –40	20 –0–20
Error limit, measuring range	µm		7
Error limit, 1/2 revolution	µm		6
Error limit, 1/10 revolution	µm		5
Repeatability f_w	µm		3
Measuring value hysteresis f_u	µm		3
Free stroke	mm	9	4.5
Measuring force incoming measuring pin	N	0.9 –1.1	0.7 –1.1
Standard			DIN 878
Shockproof movement			•
Protective measuring spindle cap			•
Range per turn	mm	0.8	
Dial color			White

Order no.	a	b	c	d	e	f	g	Mounting shaft
	mm	mm	mm	mm	mm	mm	mm	mm
4317000	58	23	7.5	52	120	22	15	8
4324250	44	21.6	6.8	37	83	15.5	8	8

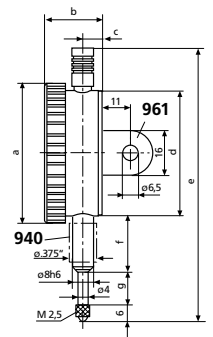

ACCESSORIES

Order no.	Description	Type
4310103	Adapter bushing (.375" / 8 mm)	940
4375010	Lug back, vertical, for 810	961
4375011	Lug back, horizontal, for 810	962
4375020	Lug back, vertical, for 803	966
4375021	Lug back, horizontal, for 803	967

MarCator 810 AG

Large dial indicator

FEATURES

- Large, high contrast dial face
- Adjustable tolerance markers
- Chrome plated housing
- Lifter protection cap on the measuring spindle
- Precision gears and pinions

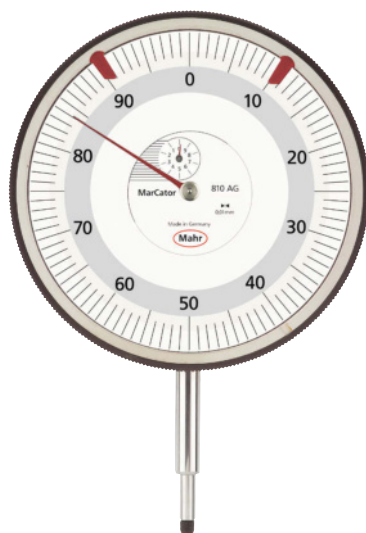

Application:

- Ideal for long reading distance and in poorly lit conditions

TECHNICAL DATA

Order no.		4322000
Type		810 AG
Measuring span	mm	10
Readings	mm	0.01
Type of dial face		0–100
Error limit, measuring range	µm	17
Error limit, 1 revolution	µm	15
Error limit, 1/2 revolution	µm	10
Error limit, 1/10 revolution	µm	5
Repeatability f_w	µm	3
Measuring value hysteresis f_u	µm	5
Free stroke	mm	0.1
Measuring force incoming measuring pin	N	1.3–2.2
Standard		Factory standard
Lifting protection cap		•
Scale diameter	mm	112
Range per turn	mm	1
Dial color		White

Order no.	Mounting shaft
	mm
4322000	8

ACCESSORIES

Order no.	Description	Type
4310103	Adapter bushing (.375" / 8 mm)	940

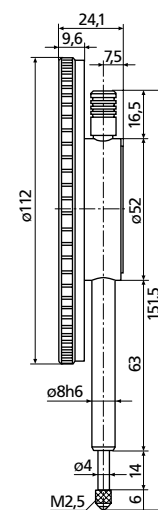

MarCator 901 / 901 H / 901 R

Standard contact point

Order no.	Product type	l	Measurement surface radius	Measuring surface
		mm	mm	
4360001	901	6	1.5	steel
4360002	901 H	6	1.5	carbide
4360003	901 R	6	1.5	ruby

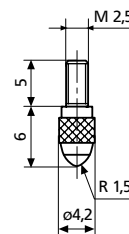

MarCator 902

Spherical contact point

Order no.	Product type	l	Measuring surface ϕ	Measurement surface radius	Measuring surface
		mm	mm	mm	
4360007	902	4	4	6	steel
4360009	902	6	4	6	steel
4360010	902	8	4	6	steel
4360011	902	10	4	6	steel
4360012	902	12	4	6	steel
4360013	902	15	4	6	steel
4360014	902	20	4	6	steel
4360015	902	25	4	6	steel
4360018	902	50	4	6	steel

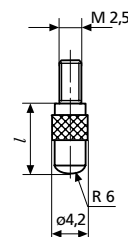

MarCator 902 H

Spherical contact point

Order no.	Product type	l	Measuring surface ϕ	Measurement surface radius	Measuring surface
		mm	mm	mm	
4360040	902 H	8	4	6	carbide
4360041	902 H	10	4	6	carbide
4360042	902 H	12	4	6	carbide
4360043	902 H	15	4	6	carbide
4360044	902 H	20	4	6	carbide
4360045	902 H	25	4	6	carbide
4360048	902 H	50	4	6	carbide

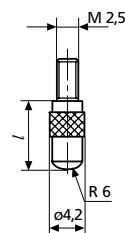

MarCator 903 / 903 H

Flat contact point

Order no.	Product type	l	Measuring surface ϕ	Measuring surface
		mm	mm	
4360070	903	4	4	steel
4360071	903	6	4	steel
4360072	903	8	4	steel
4360073	903	10	4	steel
4360074	903	12	4	steel
4360075	903	15	4	steel
4360076	903	20	4	steel
4360077	903	25	4	steel
4360300	903	30	4	steel
4360078	903	35	4	steel
4360079	903	50	4	steel
4360101	903 H	6	4	carbide
4360102	903 H	8	4	carbide
4360103	903 H	10	4	carbide
4360104	903 H	12	4	carbide
4360105	903 H	15	4	carbide
4360106	903 H	20	4	carbide
4360107	903 H	25	4	carbide
4360110	903 H	30	4	carbide
4360108	903 H	35	4	carbide
4360111	903 H	40	4	carbide
4360310	903	40	4	steel
4360109	903 H	50	4	carbide

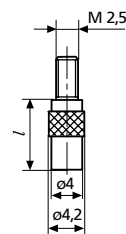

MarCator 904 / 904 H

Conical contact point

Order no.	Product type	l	Measurement surface radius	Angle α	Measuring surface
		mm	mm	°	
4360130	904	10	0.3	30	steel
4360131	904 H	10	0.3	30	carbide

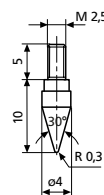

MarCator 905 / 905 H

Wedge shaped contact points

Order no.	Product type	l	Measuring surface ϕ	Measurement surface radius	Measuring surface
		mm	mm	mm	
4360140	905	10	4	0.3	steel
4360141	905 H	10	4	0.3	carbide

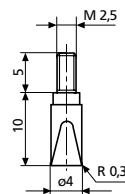

MarCator 906 H

Ball contact points

Order no.	Product type	d	l	Measuring surface
		mm	mm	
4360150	906 H	1	8.5	carbide
4360151	906 H	1.25	8.5	carbide
4360152	906 H	1.5	8.5	carbide
4360153	906 H	1.75	8.5	carbide
4360154	906 H	2	8.5	carbide
4360155	906 H	2.5	8.5	carbide
4360156	906 H	3	8.5	carbide
4360157	906 H	3.5	8.5	carbide
4360158	906 H	4	8.5	carbide
4360159	906 H	4.5	8.5	carbide
4360160	906 H	5	9	carbide
4360161	906 H	5.5	9	carbide
4360162	906 H	6	9	carbide
4360163	906 H	6.35	9	carbide
4360164	906 H	6.5	10	carbide
4360165	906 H	7	10	carbide
4360166	906 H	7.5	11	carbide
4360167	906 H	8	11	carbide
4360168	906 H	8.5	12	carbide
4360169	906 H	9	12	carbide
4360170	906 H	10	13	carbide

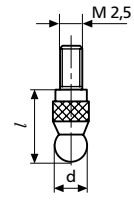

MarCator 907 / 907 H

Flat contact plates

Order no.	Product type	l	Measuring surface	Measuring surface ϕ	Measuring surface
		mm	cm ²	mm	
4360200	907	5	1	11.3	steel
4360201	907 H	5		7	carbide

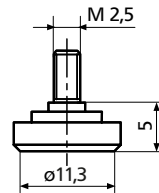

MarCator 908 / 908 H

Spherical contact plates, steel

Order no.	Product type	l	Measuring surface ϕ	Measurement surface radius	Measuring surface
		mm	mm	mm	
4360210	908	5	12	30	steel
4360211	908 H	5	12	30	carbide

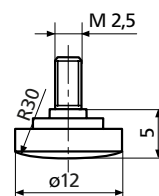

MarCator 909 A / 909 B

Measuring rollers

Order no.	Product type	l	Measurement surface radius	Radial run-out deviation	Measuring surface
		mm	mm	μm	
4360220	909 A	18		3	steel
4360221	909 B	18	5	3	steel

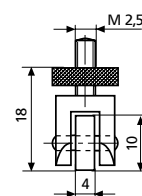

MarCator 910 H

Measuring attachment

Order no.	Product type	l	Measuring surface
		mm	
4360230	910 H	22	carbide

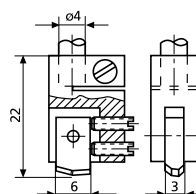

MarCator 911 H1 / 911 H2 / 911

Pin contact point

Order no.	Product type	l	Measuring surface ϕ	Measuring surface
		mm	mm	
4360240	911 H1	2	1	carbide
4360241	911 H2	11	1.5	carbide
4360280	911	15	1.5	steel
4360281	911	20	1.5	steel
4360282	911	25	1.5	steel
4360283	911	30	1.5	steel
4360284	911	35	1.5	steel
4360285	911	40	1.5	steel
4360286	911	50	1.5	steel

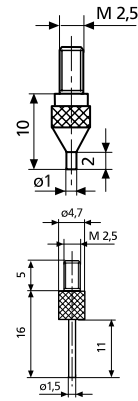

MarCator 912

Measuring spindle extension

Order no.	Product type	d	l
		mm	mm
4360250	912	4	10
4360251	912	4	15
4360252	912	4	20
4360253	912	4	25
4360254	912	4	35
4360255	912	4	50
4360256	912	4	75
4360257	912	4	100

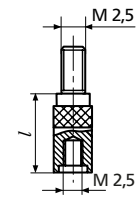

MarCator 913

Flat contact point

Order no.	Product type	Measuring surface ϕ
		mm
4360400	913	7.5

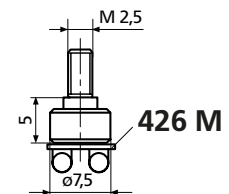

MarCator 941 G

Straight holder

FEATURES

- For measuring devices and in combination with standard measuring instruments, where the measuring instrument has to be moved away.
- **Package contains:**
contact point 901



Applications:

- For all types of measuring devices
- To be used in conjunction with a dial indicator or an inductive probe
- To position the measuring instrument at a certain angle

TECHNICAL DATA

Order no.	Length l1	Transmission	Type
	mm		
4365000	25	3 mm	941 G
4365001	50	3 mm	941 G
4365002	75	3 mm	941 G

Order no.	Length l1
	mm
4365000	25
4365001	50
4365002	75

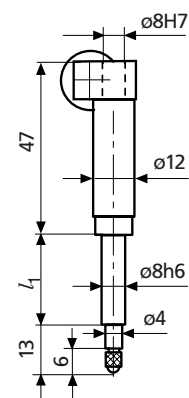

MarCator 941 W

Angular holder

FEATURES

- For measuring devices and in combination with standard measuring instruments, where tilting of the measuring instrument is required.
- **Package contains:** contact point 901, contact point 903 (l = 10 mm)



Applications:

- For all types of measuring devices
- To be used in conjunction with a dial indicator or an inductive probe
- To be positioned (tilted) at the measurement direction and also at a certain distance or angle

TECHNICAL DATA

Order no.	Length I1	Length I2	Transmission	Type
	mm	mm		
4365010	25	53.7	3 mm	941 W
4365011	50	53.7	3 mm	941 W
4365012	75	53.7	3 mm	941 W
4365020	25	49.3	3 mm	941 W
4365021	50	49.3	3 mm	941 W
4365022	75	49.3	3 mm	941 W
4365030	25	34.5	3 mm	941 W
4365031	50	34.5	3 mm	941 W
4365032	75	34.5	3 mm	941 W

Order no.	Angle α	Length I1	Length I2
	°	mm	mm
4365010	45	25	53.7
4365011	45	50	53.7
4365012	45	75	53.7
4365020	60	25	49.3
4365021	60	50	49.3
4365022	60	75	49.3
4365030	90	25	34.5
4365031	90	50	34.5
4365032	90	75	34.5

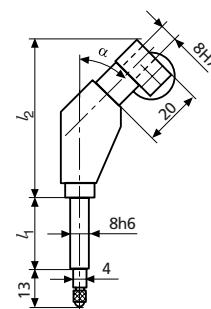

MarCator 943

Sensor level

FEATURES

- Integrated lifting device
- Interchangeable measuring anvil
- Package contains: contact point 901

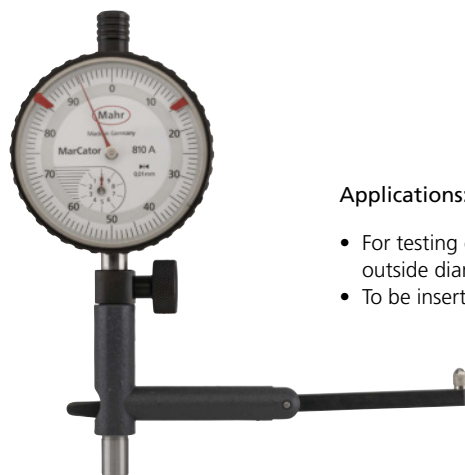

Applications:

- For testing concentricity in bore holes as well as difficult-to-reach outside diameters
- To be inserted in a measuring stand with a lifting device

TECHNICAL DATA

Order no.	Error limit	Transmission	Type
4367000	1% of measuring path	+/- 1mm	943

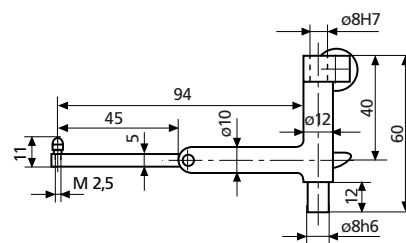

1086 R; 1086 ZR

MarCator 837

Dial indicator depth measuring bridge

FEATURES

- Measuring surface plane and precision lapped
- Holder for dial indicators with shaft diameter 8 mm
- Made of hardened steel, hard chrome plated
- **Package contains:** depth measuring bridge, contact point 902 (l = 12 mm), excludes indicator



Application:

- For precise depth measurement using dial indicator

TECHNICAL DATA

Order no.	4494010	4494011	4494012
Type		837	

ACCESSORIES

Order no.	Description	Type
4311060	Dial indicator, 0.01, 10 mm	810 AT
4336010	Digital indicator, 0.01 mm, 12.5 mm	1075 R
4337131	Digital indicator, 0.01 mm, 25 mm	1086 R
4360015	Spherical contact point, hardened steel, l = 25 mm, r = 6 mm	902
4360017	Spherical contact point, hardened steel, l = 35 mm, r = 6 mm	902
4360026	Spherical contact point, hardened steel, l = 45 mm, r = 6 mm	902
4360031	Spherical contact point, hardened steel, l = 55 mm, r = 6 mm	902
4360035	Spherical contact point, hardened steel, l = 65 mm, r = 6 mm	902
4360020	Spherical contact point, hardened steel, l = 75 mm, r = 6 mm	902
4360036	Spherical contact point, hardened steel, l = 85 mm, r = 6 mm	902
4360029	Spherical contact point, hardened steel, l = 95 mm, r = 6 mm	902



810 AT



1075 R



1086 R, 1086 ZR

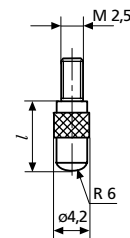

902, 902 H

MarCator A1/2Q / A3Q / A6Q

Dial indicator

FEATURES

- Unit construction and removable movement save repair/cleaning time and maintenance
- Hardened gears and stainless steel racks provide lasting protection against indicator failure due to shock or wear
- Jeweled bearings resist friction, add to longer indicator life
- Skeletonized, hobbled gears for more sensitive response, superior indicator accuracy with minimal hysteresis error
- Soft tinted dials (green - inch / yellow - metric) minimize eye strain
- Special steel alloy
- Balanced dial hand affords no shift, precise reading
- Controlled rack and pinion mesh eliminates slope for precise response and reading
- Smooth adjusting bezels for easy setup
- Positive pressure pullback spring requires less maintenance
- Compliance with ANSI/AGD dimensional and accuracy specifications
- Normally furnished: balanced dial with + on right; centered vertical lug back; regular contact point PT-43, .09" radiused, .093" long
- Optional dials: balanced with + on left; continuous clockwise; continuous counterclockwise
- Order by part number and specify dial style desired - for other dial styles or special requirements, call Mahr



Application:

- Where available space prohibits the use of longer dial indicators

TECHNICAL DATA

Order no.	Type	Measuring span	Scale graduation value	Figure on dial face	Range per turn	Error limit, measuring range	Error limit	Standard	ANSI/AGD group
2011089	A1/2Q	.010"	.0001"	0-2-0	.004"	0.0002	± .0001"	ANSI	0
2011093	A3Q	.050"	.0005"	0-10-0	.020"	0.001	± .0005"	ANSI	0
2011095	A6Q	.100"	.001"	0-20-0	.040"	0.001	± .001"	ANSI	0

Order no.	Scale diameter	Range per turn	Dial color	Mounting shaft
	inch	inch		inch
2011089	1.25	0.0040	Green	0.22
2011093	1.25	0.0200	Green	0.22
2011095	1.25	0.0400	Green	0.22

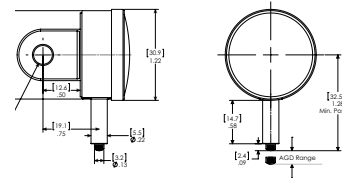

ACCESSORIES

Order no.	Description	Type
2202329	Contact point, flat	AL-61
2204777	Flat back	BK-32
2204778	Lug back	BK-37
2204779	Post back 7/32"	BK-38
2204785	Adjustable back	BK-45
2204809	Screw type back 1/4-28	BK-88
2205082	Split bushing .218" x .374" x .5"	BU-112
2225757	Contact point, spherical	PT-118
2225758	Contact point, taper	PT-119
2225801	Contact point, spherical, A = 1/4"	PT-204
2225802	Contact point, spherical, A = 3/8"	PT-205
2225804	Contact point, spherical, A = 1/2"	PT-207
2225805	Contact point, spherical, A = 5/8"	PT-208
2225806	Contact point, spherical, A = 3/4"	PT-209
2225808	Contact point, spherical, A = 7/8"	PT-210
2225809	Contact point, spherical, A = 1"	PT-211
2225925	Contact point, spherical, A = 3/32" (normally furnished)	PT-43

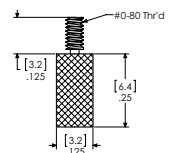

AL-61

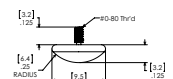

PT-118

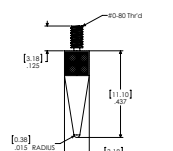

PT-119

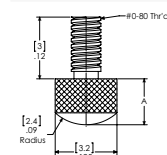

PT-204;PT-205;
PT-207;PT-208;
PT-209;PT-210;
PT-211;PT-43

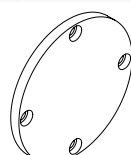

BK-32;
BK-470;
BK-473;
BK-5

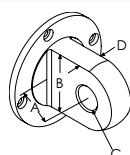

BK-37

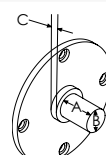

BK-38

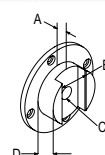

BK-45

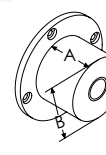

BK-88

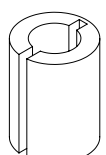

BU-112

MarCator N1/2O / N3I / N6I

Dial indicator

FEATURES

- Unit construction and removable movement save repair/cleaning time and maintenance
- Hardened gears and stainless steel racks provide lasting protection against indicator failure due to shock or wear
- Jeweled bearings resist friction, add to longer indicator life
- Skeletonized, hobbed gears for more sensitive response, superior indicator accuracy with minimal hysteresis error
- Soft tinted dials (green - inch / yellow - metric) minimize eye strain
- Special steel alloy
- Balanced dial hand affords no shift, precise reading
- Controlled rack and pinion mesh eliminates slope for precise response and reading
- Smooth adjusting bezels for easy setup
- Positive pressure pullback spring requires less maintenance
- Compliance with ANSI/AGD dimensional and accuracy specifications
- Normally furnished: balanced dial with + on right; centered vertical lug back; regular contact point PT-43, .09" radiused, .093" long
- Optional dials: balanced with + on left; continuous clockwise; continuous counterclockwise
- Order by part number and specify dial style desired - for other dial styles or special requirements, call Mahr



Application:

- Where available space prohibits the use of longer dial indicators

TECHNICAL DATA

Order no.	Type	Measuring span	Readings	Figure on dial face	Error limit, measuring range	Error limit	Standard
		mm	mm		µm	mm	
2011743	N1/2O	0.25	0.002	0-5-0	4	± 0.002	ANSI
2011745	N3I	1.25	0.005	0-25-0	10	± 0.005	ANSI
2011759	N6I	2.5	0.01	0-50-0	20	± 0.01	ANSI

Order no.	ANSI/AGD group	Range per turn	Dial color	Mounting shaft
		mm		inch
2011743	0	0.1	Yellow	0.22
2011745	0	0.5	Yellow	0.22
2011759	0	1	Yellow	0.22

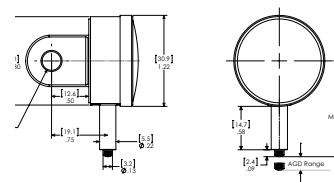

ACCESSORIES

Order no.	Description	Type
2202329	Contact point, flat	AL-61
2204777	Flat back	BK-32
2204778	Lug back	BK-37
2204779	Post back 7/32"	BK-38
2204785	Adjustable back	BK-45
2204809	Screw type back 1/4-28	BK-88
2205082	Split bushing .218" x .374" x .5"	BU-112
2225757	Contact point, spherical	PT-118
2225758	Contact point, taper	PT-119
2225801	Contact point, spherical, A = 1/4"	PT-204
2225802	Contact point, spherical, A = 3/8"	PT-205
2225804	Contact point, spherical, A = 1/2"	PT-207
2225805	Contact point, spherical, A = 5/8"	PT-208
2225806	Contact point, spherical, A = 3/4"	PT-209
2225808	Contact point, spherical, A = 7/8"	PT-210
2225809	Contact point, spherical, A = 1"	PT-211
2225925	Contact point, spherical, A = 3/32" (normally furnished)	PT-43

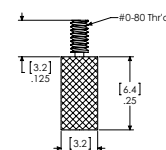

AL-61

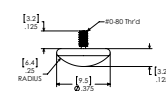

PT-118

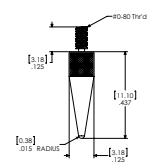

PT-119

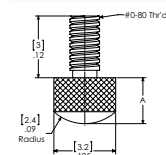

PT-204;PT-205;
PT-207;PT-208;
PT-209;PT-210;
PT-211;PT-43

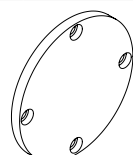

BK-32;
BK-470;
BK-473;
BK-5

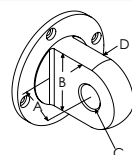

BK-37

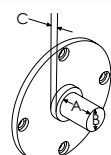

BK-38

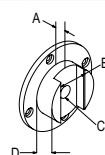

BK-45

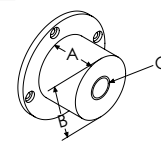

BK-88

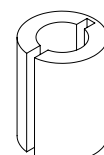

BU-112

MarCator

Dial indicator

FEATURES

- Unit construction and removable movement save repair/cleaning time and maintenance
- Hardened gears and stainless steel racks provide lasting protection against indicator failure due to shock or wear
- Jeweled bearings resist friction, add to longer indicator life
- Skeletonized, hobbled gears for more sensitive response, superior indicator accuracy with minimal hysteresis error
- Soft tinted dials (green - inch / yellow - metric) minimize eye strain
- Special steel alloy
- Balanced dial hand affords no shift, precise reading
- Controlled rack and pinion mesh eliminates slope for precise response and reading
- Smooth adjusting bezels for easy setup
- Positive pressure pull back spring requires less maintenance
- Compliance with ANSI/AGD dimensional and accuracy specifications
- These indicators are normally furnished with continuous dial (with R.C.) or + on right balance dial (w/o R.C.), lug back and .18" by .250" long contact
- Optional Dials: balanced dial with + on left; continuous clockwise; continuous counterclockwise (Order by part number and specify dial style desired)
- For other dial styles or special requirements - call Mahr



TECHNICAL DATA

Order no.	Type	Measuring span	Scale graduation value	Figure on dial face	Rev. counter	Range per turn	Error limit, measuring range	Error limit	Standard
		inch	inch			inch	inch	inch	
2011000	12I	.025"	.0001"	0-5-0		.010"	0.0002	±.0001"	ANSI
2011001	12I-RC	.025"	.0001"	0-10	•	.010"	0.0002	±.0001"	ANSI
2011004	12Q	.025"	.00025"	0-5-0		.010"	0.0005	±.00025"	ANSI
2011005	12Q-RC	.025"	.00025"	0-10	•	.010"	0.0005	±.00025"	ANSI
2011106	B3K	.050"	.00025"	0-10-0		.020"	0.0005	±.00025"	ANSI
2011107	B3K-RC	.050"	.00025"	0-20	•	.020"	0.0005	±.00025"	ANSI
2011110	B3Q	.050"	.0005"	0-10-0		.020"	0.001	±.0005"	ANSI
2011111	B3Q-RC	.050"	.0005"	0-20	•	.020"	0.001	±.0005"	ANSI
2011114	B3W	.050"	.001"	0-10-0		.020"	0.002	±.001"	ANSI
2011115	B3W-RC	.050"	.001"	0-20	•	.020"	0.002	±.001"	ANSI
2011118	B5M	.075"	.0005"	0-15-0		.030"	0.001	±.0005"	ANSI
2011119	B5M-RC	.075"	.0005"	0-30	•	.030"	0.001	±.0005"	ANSI
2011123	B6K	.100"	.0005"	0-20-0		.040"	0.001	±.0005"	ANSI
2011124	B6K-RC	.100"	.0005"	0-40	•	.040"	0.001	±.0005"	ANSI
2011128	B6Q	.100"	.001"	0-20-0		.040"	0.002	±.001"	ANSI
2011129	B6Q-RC	.100"	.001"	0-40	•	.040"	0.002	±.001"	ANSI
2011133	B7I	.125"	.0005"	0-25-0		.050"	0.001	±.0005"	ANSI
2011134	B7I-RC	.125"	.0005"	0-50	•	.050"	0.001	±.0005"	ANSI
2011137	B7O	.125"	.001"	0-25-0		.050"	0.002	±.001"	ANSI
2011138	B7O-RC	.125"	.001"	0-50	•	.050"	0.002	±.001"	ANSI
2011141	B8I	.250"	.001"	0-50-0		.100"	0.002	±.001"	ANSI
2011142	B8I-RC	.250"	.001"	0-100	•	.100"	0.002	±.001"	ANSI

Order no.	ANSI/AGD group	Scale diameter	Range per turn	Dial color	Mounting shaft
		inch	inch		inch
2011000	1	1.75	0.0100	Green	0.375
2011001	1	1.75	0.0100	Green	0.375
2011004	1	1.75	0.0100	Green	0.375
2011005	1	1.75	0.0100	Green	0.375
2011106	1	1.75	0.0200	Green	0.375
2011107	1	1.75	0.0200	Green	0.375
2011110	1	1.75	0.0200	Green	0.375
2011111	1	1.75	0.0200	Green	0.375
2011114	1	1.75	0.0200	Green	0.375
2011115	1	1.75	0.0200	Green	0.375
2011118	1	1.75	0.0300	Green	0.375
2011119	1	1.75	0.0300	Green	0.375
2011123	1	1.75	0.0400	Green	0.375
2011124	1	1.75	0.0400	Green	0.375
2011128	1	1.75	0.0400	Green	0.375
2011129	1	1.75	0.0400	Green	0.375
2011133	1	1.75	0.0500	Green	0.375
2011134	1	1.75	0.0500	Green	0.375
2011137	1	1.75	0.0500	Green	0.375
2011138	1	1.75	0.0500	Green	0.375
2011141	1	1.75	0.1000	Green	0.375
2011142	1	1.75	0.1000	Green	0.375

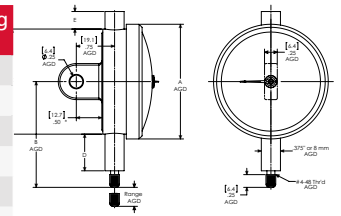

ACCESSORIES

Order no.	Description	Type
2203132	Mounting bracket with adjusting knob	AT-115
2203155	Mounting bracket with hex socket adjust	AT-27
2204756	Vertical lug back, centered, 1/4" hole	BK-1600
2204757	Vertical lug back, offset, 1/4" hole	BK-1601
2204758	Adjustable back 1/4"-20 thread	BK-1633
2204759	Post back 1/2"	BK-1634
2204760	Flat back	BK-1660
2204761	Screw type back 1/4-28	BK-1661
2204771	Horizontal lug back 1/4" hole	BK-19
2204811	Rack back used on AT-27 and AT-115	BK-92
2220156	Tolerance hands with screw on bezel (option)	HD-59
2220542	Lifting lever, left hand	LR-46
2220543	Lifting lever, right hand	LR-47
2220539	OX-bow lifting lever	LR-40
2203183	Brake attachment (option)	AT-A-7-W1
2219994	Rubber bellows for shank Ø .375"	GU-2
2206230	Range limiting caps, adjustable up to 9.52 mm / .375"	CS-123
2203163	Brake attachment, dust cap mount (option), range limited to 6.35 mm / .250" for group 1 and to 12 mm / .500" for group 2-4 indicators	AT-81
2201801	Adaptor for inductive probes for use on dial indicators (AGD)	AD-138
2201846	Threaded bushing .625" long .500" OD with 5/16-32 internal thread	AD-62
2201854	Split collet OD is 17.45 mm / .687"; requires 1/2-32 threaded hole	AD-87
2235806	Tap 1/2 -32	V-892
2205081	Split bushing, for use with protective housing .375" stem hole X .687" OD	BU-111
2205127	Split bushing with shoulder 8 mm stem hole X .375" OD	BU-197
2205195	Split bushing, with counterbore, .375" stem hole x .500" OD	BU-80
2205200	Split bushing without counterbore, .375" stem hole x .50" OD	BU-94
2204603	Base for indicators with lug back	BA-1051



BU-80

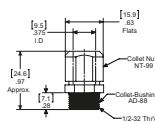

AD-87



AD-138



LR-48;LR-46;
LR-47;LR-50;
LR-68

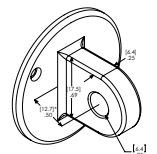

BK-1600;
BK-383;
BK-431;
BK-3

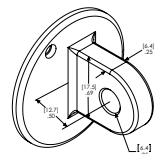

BK-1601;
BK-2168;
BK-545;
BK-4

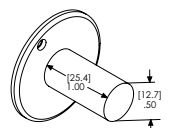

BK-1634

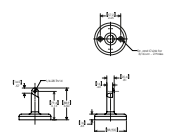

BA-1051

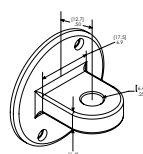

BK-19;
BK-400;
BK-109

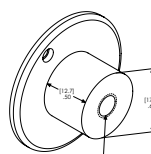

BK-1661;
BK-692;
BK-177;
BK-16

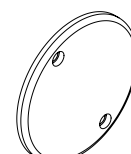

BK-1660

MarCator O1I / O3I / O6I / O8I

Dial indicator

ACCESSORIES



BU-80

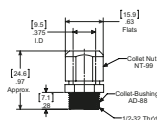

AD-87



AD-138



LR-48;LR-46;
LR-47;LR-50;
LR-68

Order no.	Description	Type
2203132	Mounting bracket with adjusting knob	AT-115
2203155	Mounting bracket with hex socket adjust	AT-27
2204756	Vertical lug back, centered, 1/4" hole	BK-1600
2204757	Vertical lug back, offset, 1/4" hole	BK-1601
2204758	Adjustable back 1/4"-20 thread	BK-1633
2204759	Post back 1/2"	BK-1634
2204760	Flat back	BK-1660
2204761	Screw type back 1/4-28	BK-1661
2204771	Horizontal lug back 1/4" hole	BK-19
2204811	Rack back used on AT-27 and AT-115	BK-92
2220156	Tolerance hands with screw on bezel (option)	HD-59
2220542	Lifting lever, left hand	LR-46
2220543	Lifting lever, right hand	LR-47
2220539	OX-bow lifting lever	LR-40
2203183	Brake attachment (option)	AT-A-7-W1
2219994	Rubber bellows for shank Ø .375"	GU-2
2206230	Range limiting caps, adjustable up to 9.52 mm / .375"	CS-123
2203163	Brake attachment, dust cap mount (option), range limited to 6.35 mm / .250" for group 1 and to 12 mm / .500" for group 2-4 indicators	AT-81
2201801	Adaptor for inductive probes for use on dial indicators (AGD)	AD-138
2201846	Threaded bushing .625" long .500" OD with 5/16-32 internal thread	AD-62
2201854	Split collet OD is 17.45 mm / .687"; requires 1/2-32 threaded hole	AD-87
2235806	Tap 1/2 -32	V-892
2205081	Split bushing, for use with protective housing .375" stem hole X .687" OD	BU-111
2205127	Split bushing with shoulder 8 mm stem hole X .375" OD	BU-197
2205195	Split bushing, with counterbore, .375" stem hole x .500" OD	BU-80
2205200	Split bushing without counterbore, .375" stem hole x .50" OD	BU-94
2204603	Base for indicators with lug back	BA-1051

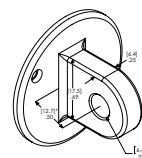

BK-1600;
BK-383;
BK-431;
BK-3

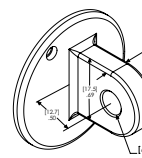

BK-1601;
BK-2168;
BK-545;
BK-4

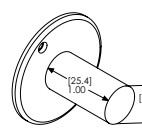

BK-1634

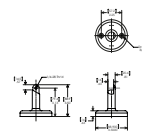

BA-1051

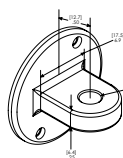

BK-19;
BK-400;
BK-109

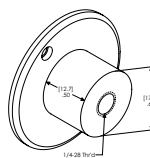

BK-1661;
BK-692;
BK-177;
BK-16

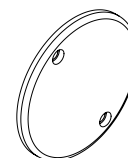

BK-1660

FEATURES

- Unit construction and removable movement save repair/cleaning time and maintenance
- Hardened gears and stainless steel racks provide lasting protection against indicator failure due to shock or wear
- Jeweled bearings resist friction, add to longer indicator life
- Skeletonized, hobbled gears for more sensitive response, superior indicator accuracy with minimal hysteresis error
- Soft tinted dials (green - inch / yellow - metric) minimize eye strain
- Special steel alloy
- Balanced dial hand affords no shift, precise reading
- Controlled rack and pinion mesh eliminates slope for precise response and reading
- Smooth adjusting bezels for easy setup
- Positive pressure pull back spring requires less maintenance
- Compliance with ANSI/AGD dimensional and accuracy specifications
- These indicators are normally furnished with continuous dial (with R.C.) or + on right balance dial (w/o R.C.), lug back and .18" by .250" long contact
- **Optional dials:** balanced dial with + on left; continuous clockwise; continuous counterclockwise. (Order by part number and specify dial style desired)
- For other dial styles or special requirements - call Mahr



TECHNICAL DATA

Order no.	Type	Measuring span	Scale graduation value	Figure on dial face	Rev. counter	Range per turn	Error limit, measuring range	Error limit	Standard	ANSI/AGD Group
2011049	28IN-RC	.250"	.001"	0-100	•	.100"	0.002	±.001"	ANSI	2
2011157	C1/2K	.010"	.00005"	0-2-0		.004"	0.0002	±.0001"	ANSI	2
2011158	C1/2K-RC	.010"	.00005"	0-4	•	.004"	0.0002	±.0001"	ANSI	2
2011161	C1K	.020"	.0001"	0-4-0		.008"	0.0002	±.0001"	ANSI	2
2011162	C1K-RC	.020"	.0001"	0-8	•	.008"	0.0002	±.0001"	ANSI	2
2014761	22IN-RC	.025"	.0001"	0-10	•	.010"	0.0002	±.0001"	ANSI	2
2014791	22QN-RC	.025"	.00025"	0-10	•	.010"	0.0005	±.00025"	ANSI	2
2014808	23K-RC	.050"	.00025"	0-20	•	.020"	0.0005	±.00025"	ANSI	2
2014809	23W-RC	.050"	.001"	0-20	•	.020"	0.002	±.001"	ANSI	2
2014810	23Q-RC	.050"	.0005"	0-20	•	.020"	0.001	±.0005"	ANSI	2
2014811	25M-RC	.075"	.0005"	0-30	•	.030"	0.001	±.0005"	ANSI	2
2014812	26K-RC	.100"	.0005"	0-40	•	.040"	0.001	±.0005"	ANSI	2
2014813	26Q-RC	.100"	.001"	0-40	•	.040"	0.002	±.001"	ANSI	2
2014814	27I-RC	.125"	.0005"	0-50	•	.050"	0.001	±.0005"	ANSI	2
2014815	27O-RC	.125"	.001"	0-50	•	.050"	0.002	±.001"	ANSI	2
2015781	22I	.025"	.0001"	0-5-0		.010"	0.0002	±.0001"	ANSI	2
2015782	22QN	.025"	.00025"	0-5-0		.010"	0.0005	±.00025"	ANSI	2
2015783	23K	.050"	.00025"	0-10-0		.020"	0.0005	±.00025"	ANSI	2
2015784	23Q	.050"	.0005"	0-10-0		.020"	0.001	±.0005"	ANSI	2
2015785	23W	.050"	.001"	0-10-0		.020"	0.002	±.001"	ANSI	2
2015786	25M	.075"	.0005"	0-15-0		.030"	0.001	±.0005"	ANSI	2
2015787	26K	.100"	.0005"	0-20-0		.040"	0.001	±.0005"	ANSI	2
2015789	26Q	.100"	.001"	0-20-0		.040"	0.002	±.001"	ANSI	2
2015790	27I	.125"	.0005"	0-25-0		.050"	0.001	±.0005"	ANSI	2
2015791	27O	.125"	.001"	0-25-0		.050"	0.002	±.001"	ANSI	2
2015792	28IN	.250"	.001"	0-50-0		.100"	0.002	±.001"	ANSI	2

Order no.	Scale diameter	Range per turn	Dial color	Mounting shaft	Order no.	Scale diameter	Range per turn	Dial color	Mounting shaft
	inch	inch		inch		inch	inch		inch
2011049	2.25	0.1000	Green	0.375	2014814	2.25	0.0500	Green	0.375
2011157	2.25	0.0040	Green	0.375	2014815	2.25	0.0500	Green	0.375
2011158	2.25	0.0040	Green	0.375	2015781	2.25	0.0100	Green	0.375
2011161	2.25	0.0080	Green	0.375	2015782	2.25	0.0100	Green	0.375
2011162	2.25	0.0080	Green	0.375	2015783	2.25	0.0200	Green	0.375
2014761	2.25	0.0100	Green	0.375	2015784	2.25	0.0200	Green	0.375
2014791	2.25	0.0100	Green	0.375	2015785	2.25	0.0200	Green	0.375
2014808	2.25	0.0200	Green	0.375	2015786	2.25	0.0300	Green	0.375
2014809	2.25	0.0200	Green	0.375	2015787	2.25	0.0400	Green	0.375
2014810	2.25	0.0200	Green	0.375	2015789	2.25	0.0400	Green	0.375
2014811	2.25	0.0300	Green	0.375	2015790	2.25	0.0500	Green	0.375
2014812	2.25	0.0400	Green	0.375	2015791	2.25	0.0500	Green	0.375
2014813	2.25	0.0400	Green	0.375	2015792	2.25	0.1000	Green	0.375

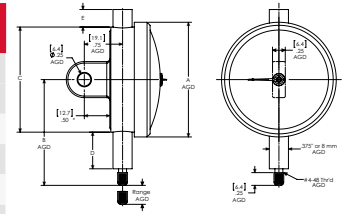

ACCESSORIES

Order no.	Description	Type
2014804	Magnetic maximum hand with snap-on bezel (option)	2014804
2203133	Mounting bracket with adjusting knob for AGD 2	AT-116
2204772	Post back 1/2" Ø	BK-2093
2204773	Vertical lug, offset 1/4" hole	BK-2168
2204780	Vertical lug back, centered 1/4" hole	BK-383
2204782	Horizontal lug back, centered, 1/4" hole	BK-400
2204786	Flat back for AGD 2	BK-470
2204790	Adjustable back 1/4-20 thread	BK-531
2204802	Screw type back 1/4-28	BK-692
2204812	Rack back used on AT-116 and AT-28	BK-93
2205222	Tolerance hands with snap-on bezel (option)	BZ-2503
2220154	Tolerance hands with screw-on bezel (option)	HD-57
2220177	Protective housing for AGD 2 models with ranges up to 6.35 mm/ .250"	HG-100
2220178	Protective housing for AGD 2 models with ranges up to 25 mm/ 1"	HG-101
2220544	Lifting lever to lift probe manually (left)	LR-48
2220545	Lifting lever to lift probe manually (right)	LR-49
2220539	OX-bow lifting lever	LR-40
2203184	Brake attachment (option)	AT-A-7-W2
2203163	Brake attachment, dust cap mount (option), range limited to 6.35 mm/ .250" for group 1 and to 12 mm/ .500" for group 2-4 indicators	AT-81
2219994	Rubber bellows for shank Ø .375"	GU-2
2201801	Adaptor for inductive probes for use on dial indicators (AGD)	AD-138
2201843	Adaptor bushing 0.275" ID to 0.375" OD	AD-58
2201846	Threaded bushing .625" long .500" OD with 5/16-32 internal thread	AD-62
2201854	Split collet OD is 17.45 mm/ .687"; requires 1/2-32 threaded hole	AD-87
2235806	Tap 1/2 -32	V-892
2205081	Split bushing, for use with protective housing .375" stem hole X .687" OD	BU-111
2205195	Split bushing, with counterbore, .375" stem hole x .500" OD	BU-80
2205200	Split bushing without counterbore, .375" stem hole x .50" OD	BU-94
2204603	Base for indicators with lug back	BA-1051
2206230	Range limiting caps, adjustable up to 9.52 mm / .375"	CS-123

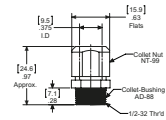

AD-87



AD-138



LR-48; LR-46;
LR-47; LR-50; LR-68



HD-57; HD-53

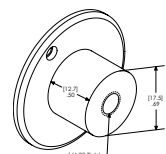

BK-1661; BK-692;
BK-177; BK-16



2011341; 2014804

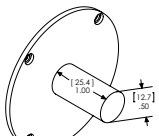

BK-2093; BK-664;
BK-17

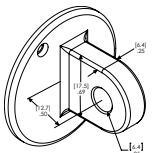

BK-1601; BK-2168;
BK-545; BK-4



HG-100; HG-101

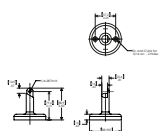

BA-1051



BU-80

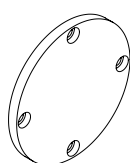

BK-32; BK-470;
BK-473; BK-5

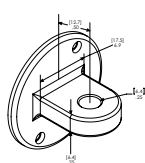

BK-19; BK-400;
BK-109

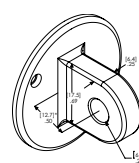

BK-1600; BK-383;
BK-431; BK-3

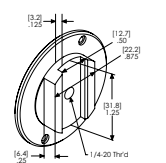

BK-531; BK-10;
BK-18

MarCator

Dial indicator

FEATURES

- Unit construction and removable movement save repair/cleaning time and maintenance
- Hardened gears and stainless steel racks provide lasting protection against indicator failure due to shock or wear
- Jeweled bearings resist friction, add to longer indicator life
- Skeletonized, hobbled gears for more sensitive response, superior indicator accuracy with minimal hysteresis error
- Soft tinted dials (green - inch / yellow - metric) minimize eye strain
- Special steel alloy
- Balanced dial hand affords no shift, precise reading
- Controlled rack and pinion mesh eliminates slope for precise response and reading
- Smooth adjusting bezels for easy setup
- Positive pressure pullback spring requires less maintenance
- Compliance with ANSI/AGD dimensional and accuracy specifications
- These indicators are normally furnished with continuous dial (with R.C.) or + on right balance dial (w/o R.C.), lug back and .18" by .250" long contact
- **Optional dials:** balanced dial with + on left; continuous clockwise; continuous counterclockwise. (Order by part number and specify dial style desired)
- For other dial styles or special requirements - call Mahr



TECHNICAL DATA

Order no.	Type	Measuring span	Readings	Figure on dial face	Rev. counter	Error limit, measuring range	Error limit	Standard	Scale diameter
		mm	mm			µm	mm		mm
2011810	P1/2I	0.25	0.001	0-5-0		4	± 0.002	ANSI	57
2011812	P1/2I-RC	0.25	0.001	0-10	•	4	± 0.002	ANSI	57
2011815	P1I	0.5	0.002	0-10-0		8	± 0.004	ANSI	57
2011817	P1I-RC	0.5	0.002	0-20	•	8	± 0.004	ANSI	57
2014817	23IM-RC	1.25	0.005	0-50	•	10	± 0.005	ANSI	57
2014818	26IM-RC	2.5	0.01	0-100	•	20	± 0.010	ANSI	57
2014819	28IM-RC	5	0.02	0-200	•	40	± 0.020	ANSI	57
2015793	23I	1.25	0.005	0-25-0		10	± 0.005	ANSI	57
2015794	26I	2.5	0.01	0-50-0		20	± 0.010	ANSI	57
2015795	28IM	5	0.02	0-100-0		40	± 0.020	ANSI	57

Order no.	ANSI/AGD group	Range per turn	Dial color	Mounting shaft
		mm		inch
2011810	2	0.1	Yellow	0.375
2011812	2	0.1	Yellow	0.375
2011815	2	0.2	Yellow	0.375
2011817	2	0.2	Yellow	0.375
2014817	2	0.5	Yellow	0.375
2014818	2	1	Yellow	0.375
2014819	2	2	Yellow	0.375
2015793	2	0.5	Yellow	0.375
2015794	2	1	Yellow	0.375
2015795	2	2	Yellow	0.375

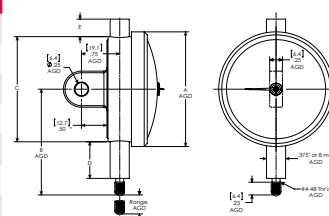

ACCESSORIES

Order no.	Description	Type
2014804	Magnetic maximum hand with snap-on bezel (option)	2014804
2203133	Mounting bracket with adjusting knob for AGD 2	AT-116
2204772	Post back 1/2" Ø	BK-2093
2204773	Vertical lug, offset 1/4" hole	BK-2168
2204780	Vertical lug back, centered 1/4" hole	BK-383
2204782	Horizontal lug back, centered, 1/4" hole	BK-400
2204786	Flat back for AGD 2	BK-470
2204790	Adjustable back 1/4-20 thread	BK-531
2204802	Screw type back 1/4-28	BK-692
2204812	Rack back used on AT-116 and AT-28	BK-93
2205222	Tolerance hands with snap-on bezel (option)	BZ-2503
2220154	Tolerance hands with screw-on bezel (option)	HD-57
2220177	Protective housing for AGD 2 models with ranges up to 6.35 mm/ .250"	HG-100
2220178	Protective housing for AGD 2 models with ranges up to 25 mm/ 1"	HG-101
2220544	Lifting lever to lift probe manually (left)	LR-48
2220545	Lifting lever to lift probe manually (right)	LR-49
2220539	OX-bow lifting lever	LR-40
2203184	Brake attachment (option)	AT-A-7-W2
2203163	Brake attachment, dust cap mount (option), range limited to 6.35 mm/ .250" for group 1 and to 12 mm/ .500" for group 2-4 indicators	AT-81
2219994	Rubber bellows for shank Ø .375"	GU-2
2201801	Adaptor for inductive probes for use on dial indicators (AGD)	AD-138
2201843	Adaptor bushing 0.275" ID to 0.375" OD	AD-58
2201846	Threaded bushing .625" long .500" OD with 5/16-32 internal thread	AD-62
2201854	Split collet OD is 17.45 mm/ .687"; requires 1/2-32 threaded hole	AD-87
2235806	Tap 1/2 -32	V-892
2205081	Split bushing, for use with protective housing .375" stem hole X .687" OD	BU-111
2205195	Split bushing, with counterbore, .375" stem hole x .500" OD	BU-80
2205200	Split bushing without counterbore, .375" stem hole x .50" OD	BU-94
2204603	Base for indicators with lug back	BA-1051
2206230	Range limiting caps, adjustable up to 9.52 mm / .375"	CS-123



2011341; 2014804

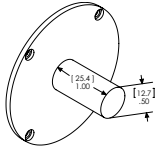

BK-2093; BK-664; BK-17

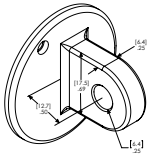

BK-1601; BK-2168; BK-545; BK-4



HG-100; HG-101

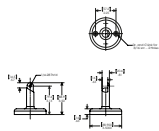

BA-1051



BU-80

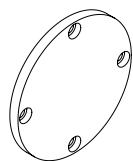

BK-32; BK-470; BK-473; BK-5

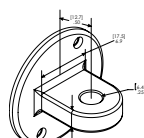

BK-19; BK-400; BK-109

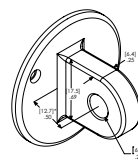

BK-1600; BK-383; BK-431; BK-3

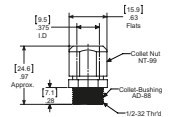

AD-87



AD-138



LR-48; LR-46; LR-47; LR-50; LR-68



HD-57; HD-53

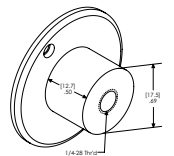

BK-1661; BK-692; BK-177; BK-16

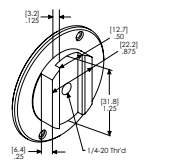

BK-531; BK-10; BK-18

MarCator

Dial indicator

FEATURES

- Unit construction and removable movement save repair/cleaning time and maintenance
- Hardened gears and stainless steel racks provide lasting protection against indicator failure due to shock or wear
- Jeweled bearings resist friction, add to longer indicator life
- Skeletonized, hobbled gears for more sensitive response, superior indicator accuracy with minimal hysteresis error
- Soft tinted dials (green - inch / yellow - metric) minimize eye strain
- Special steel alloy
- Balanced dial hand affords no shift, precise reading
- Controlled rack and pinion mesh eliminates slope for precise response and reading
- Smooth adjusting bezels for easy setup
- Positive pressure pull back spring requires less maintenance
- Compliance with ANSI/AGD dimensional and accuracy specifications
- These indicators are normally furnished with continuous dial (with R.C.) or + on right balance dial (w/o R.C.), lug back and .18" by .250" long contact
- **Optional Dials:** balanced dial with + on left; continuous clockwise; continuous counterclockwise. (Order by part number and specify dial style desired)
- For other dial styles or special requirements - call Mahr



TECHNICAL DATA

Order no.	Type	Measuring span	Scale graduation value	Figure on dial face	Rev. counter	Range per turn	Error limit, measuring range	Error limit	Standard	ANSI/AGD group
		inch	inch			inch	inch	inch		
2011050	32I	.025"	.0001"	0-5-0		.010"	0.0002	±.0001"	ANSI	3
2011051	32I-RC	.025"	.0001"	0-10	•	.010"	0.0002	±.0001"	ANSI	3
2011054	32Q	.025"	.00025"	0-5-0		.010"	0.0005	±.00025"	ANSI	3
2011055	32Q-RC	.025"	.00025"	0-10	•	.010"	0.0005	±.00025"	ANSI	3
2011226	D1K	.020"	.0001"	0-4-0		.008"	0.0002	±.0001"	ANSI	3
2011227	D1K-RC	.020"	.0001"	0-8	•	.008"	0.0002	±.0001"	ANSI	3
2011230	D3K	.050"	.00025"	0-10-0		.020"	0.0005	±.00025"	ANSI	3
2011231	D3K-RC	.050"	.00025"	0-20	•	.020"	0.0005	±.00025"	ANSI	3
2011234	D3Q	.050"	.0005"	0-10-0		.020"	0.001	±.0005"	ANSI	3
2011235	D3Q-RC	.050"	.0005"	0-20	•	.020"	0.001	±.0005"	ANSI	3
2011238	D3W	.050"	.001"	0-10-0		.020"	0.002	±.001"	ANSI	3
2011239	D3W-RC	.050"	.001"	0-20	•	.020"	0.002	±.001"	ANSI	3
2011242	D5G	.075"	.00025"	0-15-0		.030"	0.0005	±.00025"	ANSI	3
2011243	D5G-RC	.075"	.00025"	0-30	•	.030"	0.0005	±.00025"	ANSI	3
2011246	D5M	.075"	.0005"	0-15-0		.030"	0.001	±.0005"	ANSI	3
2011247	D5M-RC	.075"	.0005"	0-30	•	.030"	0.001	±.0005"	ANSI	3
2011250	D6K	.100"	.0005"	0-20-0		.040"	0.001	±.0005"	ANSI	3
2011251	D6K-RC	.100"	.0005"	0-40	•	.040"	0.001	±.0005"	ANSI	3
2011254	D6Q	.100"	.001"	0-20-0		.040"	0.002	±.001"	ANSI	3
2011255	D6Q-RC	.100"	.001"	0-40	•	.040"	0.002	±.001"	ANSI	3
2011258	D7I	.125"	.0005"	0-25-0		.050"	0.001	±.0005"	ANSI	3
2011259	D7I-RC	.125"	.0005"	0-50	•	.050"	0.001	±.0005"	ANSI	3
2011262	D7O	.125"	.001"	0-25-0		.050"	0.002	±.001"	ANSI	3
2011263	D7O-RC	.125"	.001"	0-50	•	.050"	0.002	±.001"	ANSI	3
2011266	D8I	.250"	.001"	0-50-0		.100"	0.002	±.001"	ANSI	3
2011267	D8I-RC	.250"	.001"	0-100	•	.100"	0.002	±.001"	ANSI	3

MarCator

Dial indicator

Order no.	Scale diameter	Range per turn	Dial color	Mounting shaft
	inch	inch		inch
2011050	2.75	0.0100	Green	0.375
2011051	2.75	0.0100	Green	0.375
2011054	2.75	0.0100	Green	0.375
2011055	2.75	0.0100	Green	0.375
2011226	2.75	0.0080	Green	0.375
2011227	2.75	0.0080	Green	0.375
2011230	2.75	0.0200	Green	0.375
2011231	2.75	0.0200	Green	0.375
2011234	2.75	0.0200	Green	0.375
2011235	2.75	0.0200	Green	0.375
2011238	2.75	0.0200	Green	0.375
2011239	2.75	0.0200	Green	0.375
2011242	2.75	0.0300	Green	0.375

Order no.	Scale diameter	Range per turn	Dial color	Mounting shaft
	inch	inch		inch
2011243	2.75	0.0300	Green	0.375
2011246	2.75	0.0300	Green	0.375
2011247	2.75	0.0300	Green	0.375
2011250	2.75	0.0400	Green	0.375
2011251	2.75	0.0400	Green	0.375
2011254	2.75	0.0400	Green	0.375
2011255	2.75	0.0400	Green	0.375
2011258	2.75	0.0500	Green	0.375
2011259	2.75	0.0500	Green	0.375
2011262	2.75	0.0500	Green	0.375
2011263	2.75	0.0500	Green	0.375
2011266	2.75	0.1000	Green	0.375
2011267	2.75	0.1000	Green	0.375

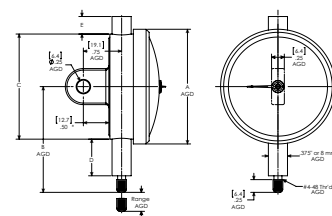

ACCESSORIES

Order no.	Description	Type
2011341	Magnetic maximum hand (option)	2011341
2204730	Adjustable back with 1/4–20 thread	BK–10
2204734	Horizontal lug back, centered	BK–109
2204763	Screw type back 1/4–28	BK–177
2204784	Vertical lug back, centered	BK–431
2204787	Flat back	BK–473
2204791	Vertical lug back, offset	BK–545
2204799	Post back 1/2" Ø	BK–664
2220546	Lifting lever to lift probe manually (left)	LR–50
2220547	Lifting lever to lift probe manually (right)	LR–51
2220539	OX-bow lifting lever	LR–40
2203185	Brake attachment (option)	AT-A–7-W3
2203163	Brake attachment, dust cap mount (option), range limited to 6.35 mm/ .250" for group 1 and to 12 mm/ .500" for group 2–4 indicators	AT–81
2219994	Rubber bellows for shank Ø .375"	GU–2
2206230	Range limiting caps, adjustable up to 9.52 mm / .375"	CS–123
2201801	Adaptor for inductive probes for use on dial indicators (AGD)	AD–138
2201846	Threaded bushing .625" long .500" OD with 5/16–32 internal thread	AD–62
2201854	Split collet OD is 17.45 mm/ .687"; requires 1/2–32 threaded hole	AD–87
2235806	Tap 1/2 –32	V–892
2205081	Split bushing, for use with protective housing .375" stem hole X .687" OD	BU–111
2205127	Split bushing with shoulder 8 mm stem hole X .375" OD	BU–197
2205195	Split bushing, with counterbore, .375" stem hole x .500" OD	BU–80
2205200	Split bushing without counterbore, .375" stem hole x .50" OD	BU–94
2204603	Base for indicators with lug back	BA–1051



2011341; 2014804

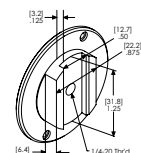

BK–531; BK–10; BK–18

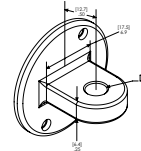

BK–19; BK–400; BK–109



AD–138

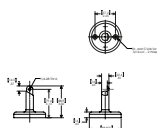

BA–1051



BU–80

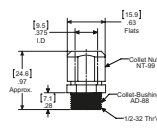

AD–87



LR–48; LR–46; LR–47; LR–50; LR–68

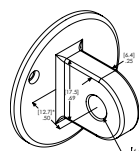

BK–1600; BK–383; BK–431; BK–3

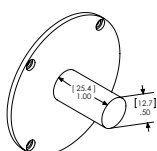

BK–2093; BK–664; BK–17

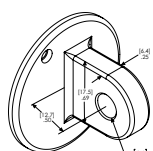

BK–1601; BK–2168; BK–545; BK–4

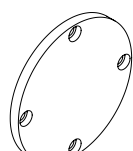

BK–32; BK–470; BK–473; BK–5

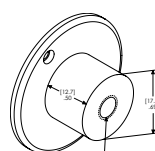

BK–1661; BK–692; BK–177; BK–16

MarCator Q1I / Q3I / Q6I / Q8I

Dial indicator

ACCESSORIES

Order no.	Description	Type
2011341	Magnetic maximum hand (option)	2011341
2204730	Adjustable back with 1/4-20 thread	BK-10
2204734	Horizontal lug back, Centered	BK-109
2204763	Screw type back 1/4-28	BK-177
2204784	Vertical lug back, centered	BK-431
2204787	Flat back	BK-473
2204791	Vertical lug back, offset	BK-545
2204799	Post back 1/2" Ø	BK-664
2220546	Lifting lever to lift probe manually (left)	LR-50
2220547	Lifting lever to lift probe manually (right)	LR-51
2220539	OX-bow lifting lever	LR-40
2203185	Brake attachment (option)	AT-A-7-W3
2203163	Brake attachment, dust cap mount (option), range limited to 6.35 mm / .250" for group 1 and to 12 mm / .500" for group 2-4 indicators	AT-81
2219994	Rubber bellows for shank Ø .375"	GU-2
2206230	Range limiting caps, adjustable up to 9.52 mm / .375"	CS-123
2201801	Adaptor for inductive probes for use on dial indicators (AGD)	AD-138
2201846	Threaded bushing .625" long .500" OD with 5/16-32 internal thread	AD-62
2201854	Split collet OD is 17.45 mm / .687"; requires 1/2-32 threaded hole	AD-87
2235806	Tap 1/2 -32	V-892
2205081	Split bushing, for use with protective housing .375" stem hole X .687" OD	BU-111
2205127	Split bushing with shoulder 8 mm stem hole X .375" OD	BU-197
2205195	Split bushing, with counterbore, .375" stem hole x .500" OD	BU-80
2205200	Split bushing without counterbore, .375" stem hole x .50" OD	BU-94
2204603	Base for indicators with lug back	BA-1051



2011341; 2014804

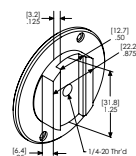

BK-531; BK-10; BK-18

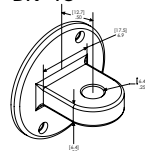

BK-19; BK-40; BK-109



AD-138

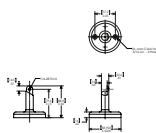

BA-1051



BU-80

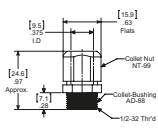

AD-87



LR-48; LR-46; LR-47; LR-50; LR-68

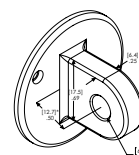

BK-1600; BK-383; BK-431; BK-3

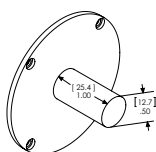

BK-2093; BK-664; BK-17

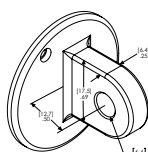

BK-1601; BK-2168; BK-545; BK-4

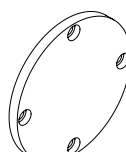

BK-32; BK-470; BK-473; BK-5

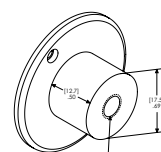

BK-1661; BK-692; BK-177; BK-16

MarCator D8IS / D8IT / 28ISN / 28IQN / 29I

Dial indicator

FEATURES

- Unit construction and removable movement save repair/cleaning time and maintenance
- Hardened gears and stainless steel racks provide lasting protection against indicator failure due to shock or wear
- Jeweled bearings resist friction, add to longer indicator life
- Skeletonized, hobbled gears for more sensitive response, superior indicator accuracy with minimal hysteresis error
- Soft tinted dials (green - inch / yellow - metric) minimize eye strain
- Special steel alloy
- Balanced dial hand affords no shift, precise reading
- Controlled rack and pinion mesh eliminates slope for precise response and reading
- Smooth adjusting bezels for easy setup
- Positive pressure pullback spring requires less maintenance
- Normally furnished: continuous clockwise dial; centered vertical lug back; regular contact point, .18" radiused, .250" long
- **Long range models:** include (1) revolution counter (except C9I without revolution counter).
- **Extra long range models:** include (2) revolution counters
- For other dial styles or special requirements - call Mahr



TECHNICAL DATA

Order no.	Type	Measuring span	Scale graduation value	Figure on dial face	Rev. counter	Range per turn	Error limit, measuring range	Error limit	Standard
		inch	inch			inch	inch	inch	
2011270	D8IS	1.000"	.001"	0-100	•	.100"	0.002	± .001"	ANSI
2011272	D8IT	2.000"	.001"	0-100	•	.100"	0.002	± .001" for first 1" of travel	ANSI
2014698	28ISN	1.000"	.001"	0-100	•	.100"	0.002	± .001"	ANSI
2014699	28IQN	.500"	.001"	0-100	•	.100"	0.002	± .001"	ANSI
2014816	29I	1.000"	.01"	0-1000		1.000"	0.02	± .010"	ANSI

Order no.	ANSI/AGD group	Scale diameter	Range per turn	Dial color	Mounting shaft
		inch	inch		inch
2011270	3	2.75	0.1000	Green	0.375
2011272	3	2.75	0.1000	Green	0.375
2014698	2	2.25	0.1000	Green	0.375
2014699	2	2.25	0.1000	Green	0.375
2014816	2	2.25	1,0000	Green	0.375

MarCator D8IS / D8IT / 28ISN / 28IQN / 29I

Dial indicator

ACCESSORIES

Order no.	Description	Type
2011341	Magnetic maximum hand (option)	2011341
2204730	Adjustable back with 1/4-20 thread	BK-10
2204734	Horizontal lug back, centered	BK-109
2204763	Screw type back 1/4-28	BK-177
2204784	Vertical lug back, centered	BK-431
2204787	Flat back	BK-473
2204791	Vertical lug back, offset	BK-545
2204799	Post back 1/2" Ø	BK-664
2220546	Lifting lever to lift probe manually (left)	LR-50
2220547	Lifting lever to lift probe manually (right)	LR-51
2220539	OX-bow lifting lever	LR-40
2203185	Brake attachment (option)	AT-A-7-W3
2203163	Brake attachment, dust cap mount (option), range limited to 6.35 mm/ .250" for group 1 and to 12 mm/ .500" for group 2-4 indicators	AT-81
2219994	Rubber bellows for shank Ø .375"	GU-2
2206230	Range limiting caps, adjustable up to 9.52 mm / .375"	CS-123
2201801	Adaptor for inductive probes for use on dial indicators (AGD)	AD-138
2201846	Threaded bushing .625" long .500" OD with 5/16-32 internal thread	AD-62
2201854	Split collet OD is 17.45 mm/ .687"; requires 1/2-32 threaded hole	AD-87
2235806	Tap 1/2 -32	V-892
2205081	Split bushing, for use with protective housing .375" stem hole X .687" OD	BU-111
2205127	Split bushing with shoulder 8 mm stem hole X .375" OD	BU-197
2205195	Split bushing, with counterbore, .375" stem hole x .500" OD	BU-80
2205200	Split bushing without counterbore, .375" stem hole x .50" OD	BU-94
2204603	Base for indicators with lug back	BA-1051
2014804	Magnetic maximum hand with snap-on bezel (option)	2014804
2203133	Mounting bracket with adjusting knob for AGD 2	AT-116
2203156	Mounting bracket with hex socket adjustable	AT-28
2204772	Post back 1/2" Ø	BK-2093
2204773	Vertical lug, offset 1/4" hole	BK-2168
2204780	Vertical lug back, centered 1/4" hole	BK-383
2204782	Horizontal lug back, centered, 1/4" hole	BK-400
2204786	Flat back for AGD 2	BK-470
2204790	Adjustable back 1/4-20 Thread	BK-531
2204802	Screw type back 1/4-28	BK-692
2204812	Rack back used on AT-116 and AT-28	BK-93
2205222	Tolerance hands with snap-on bezel (option)	BZ-2503
2220154	Tolerance hands with screw-on bezel (option)	HD-57
2220177	Protective housing for AGD 2 models with ranges up to 6.35 mm/ .250"	HG-100
2220178	Protective housing for AGD 2 models with ranges up to 25 mm/ 1"	HG-101
2220544	Lifting lever to lift probe manually (left)	LR-48
2220545	Lifting lever to lift probe manually (right)	LR-49
2203184	Brake attachment (option)	AT-A-7-W2

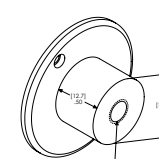
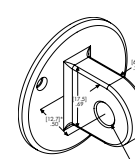
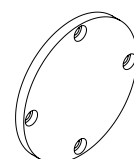
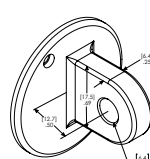
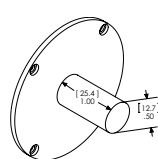
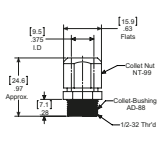
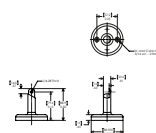
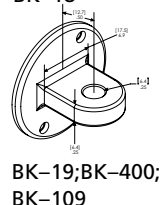
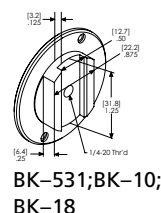

MarCator Q8IT / SP6IS / SQ6IS

Dial indicator

FEATURES

- Unit construction and removable movement save repair/cleaning time and maintenance
- Hardened gears and stainless steel racks provide lasting protection against indicator failure due to shock or wear
- Jeweled bearings resist friction, add to longer indicator life
- Skeletonized, hobbed gears for more sensitive response, superior indicator accuracy with minimal hysteresis error
- Soft tinted dials (green - inch / yellow - metric) minimize eye strain
- Special steel alloy
- Balanced dial hand affords no shift, precise reading
- Controlled rack and pinion mesh eliminates slope for precise response and reading
- Smooth adjusting bezels for easy setup
- Positive pressure pullback spring requires less maintenance
- Normally furnished: continuous clockwise dial; centered vertical lug back; regular contact point, .18" radiused, .250" long
- **Long range models:** include (1) revolution counter (except C9I without revolution counter).
- **Extra long range models:** include (2) revolution counters
- For other dial styles or special requirements - call Mahr



TECHNICAL DATA

Order no.	Type	Measuring span	Readings	Figure on dial face	Rev. counter	Error limit, measuring range	Error limit	Standard	Scale diameter
		mm	mm			µm	mm		mm
2011883	Q8IT	50	0.025	0-25	•	50	± 0.025 for first 25 mm of travel	ANSI	70
2012381	SP6IS	25	0.01	0-100	•	40	± 0.02	ANSI	57
2012384	SQ6IS	25	0.01	0-100	•	40	± 0.02	ANSI	70

Order no.	ANSI/AGD group	Scale diameter	Range per turn	Dial color	Order no.	Mounting shaft
		inch	mm			inch
2011883	3	2.75	2.5	Yellow	2011883	0.375
2012381	2	2.25	1	Yellow	2012381	0.375
2012384	3	2.75	1	Yellow	2012384	0.375

ACCESSORIES

Order no.	Description	Type
2011341	Magnetic maximum hand (option)	2011341
2204730	Adjustable back with 1/4-20 thread	BK-10
2204734	Horizontal lug back, centered	BK-109
2204763	Screw type back 1/4-28	BK-177
2204784	Vertical lug back, centered	BK-431
2204787	Flat back	BK-473
2204791	Vertical lug back, offset	BK-545
2204799	Post back 1/2" Ø	BK-664
2220546	Lifting lever to lift probe manually (left)	LR-50
2220547	Lifting lever to lift probe manually (right)	LR-51
2220539	OX-bow lifting lever	LR-40
2203185	Brake attachment (option)	AT-A-7-W3
2203163	Brake attachment, dust cap mount (option), range limited to 6.35 mm/ .250" for group 1 and to 12 mm/ .500" for group 2-4 indicators	AT-81
2219994	Rubber bellows for shank Ø .375"	GU-2
2206230	Range limiting caps, adjustable up to 9.52 mm / .375"	CS-123
2201801	Adaptor for inductive probes for use on dial indicators (AGD)	AD-138
2201846	Threaded bushing .625" long .500" OD with 5/16-32 internal thread	AD-62
2201854	Split collet OD is 17.45 mm/ .687"; requires 1/2-32 threaded hole	AD-87
2235806	Tap 1/2 -32	V-892
2205081	Split bushing, for use with protective housing .375" stem hole X .687" OD	BU-111
2205127	Split bushing with shoulder 8 mm stem hole X .375" OD	BU-197
2205195	Split bushing, with counterbore, .375" stem hole x .500" OD	BU-80
2205200	Split bushing without counterbore, .375" stem hole x .50" OD	BU-94
2204603	Base for indicators with lug back	BA-1051
2014804	Magnetic maximum hand with snap-on bezel (option)	2014804
2203133	Mounting bracket with adjusting knob for AGD 2	AT-116
2203156	Mounting bracket with hex socket adjustable	AT-28
2204772	Post back 1/2" Ø	BK-2093
2204773	Vertical lug, offset 1/4" hole	BK-2168
2204780	Vertical lug back, centered 1/4" hole	BK-383
2204782	Horizontal lug back, centered, 1/4" hole	BK-400
2204786	Flat back for AGD 2	BK-470
2204790	Adjustable back 1/4-20 Thread	BK-531
2204802	Screw type back 1/4-28	BK-692
2204812	Rack back used on AT-116 and AT-28	BK-93
2205222	Tolerance hands with snap-on bezel (option)	BZ-2503
2220154	Tolerance hands with screw-on bezel (option)	HD-57
2220177	Protective housing for AGD 2 models with ranges up to 6.35 mm/ .250"	HG-100
2220178	Protective housing for AGD 2 models with ranges up to 25 mm/ 1"	HG-101
2220544	Lifting lever to lift probe manually (left)	LR-48
2220545	Lifting lever to lift probe manually (right)	LR-49
2203184	Brake attachment (option)	AT-A-7-W2



2011341; 2014804

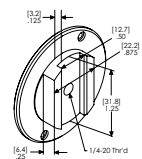

BK-531; BK-10; BK-18

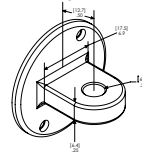

BK-19; BK-400; BK-109



AD-138



HG-100; HG-101



HD-57; HD-53

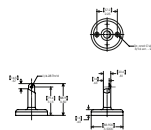

BA-1051



BU-80

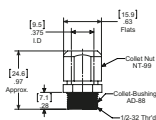

AD-87



LR-48; LR-46;
LR-47; LR-50;
LR-68

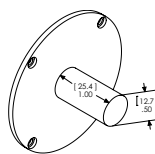

BK-2093;
BK-664;
BK-17

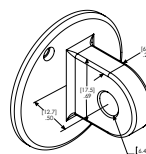

BK-1601;
BK-2168;
BK-545; BK-4

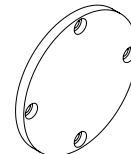

BK-32;
BK-470;
BK-473;
BK-5

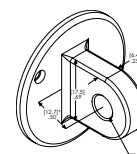

BK-1600;
BK-383;
BK-431;
BK-3

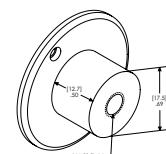

BK-1661;
BK-692;
BK-177;
BK-16

MarCator

Dial indicator

FEATURES

- Outstanding quality due to a well thought out design, use of high quality materials, and the precision engineered mechanism's guarantee
- The concentric "Speed Read" pointer (on 1.0" and .500" models) allows easy and safe reading of this dial indicator
- Spindle and stem are made of resistant stainless steel
- **Supplied with:** lug back and tolerance hands



TECHNICAL DATA

Order no.	Measuring span	Scale graduation value	Figure on dial face	Rev. counter	Range per turn	Error limit, measuring range	Error limit	Standard	ANSI/AGD group
	inch	inch			inch	inch	inch		
2016002	1.000"	.001"	0-100	•	.100"	0.002	±.001"	ANSI	2
2016004	.500"	.001"	0-100	•	.100"	0.002	±.001"	ANSI	2
2016005	.250"	.001"	0-100	•	.100"	0.002	±.001"	ANSI	2

Order no.	Scale diameter	Range per turn	Dial color	Mounting shaft
	inch	inch		inch
2016002	2.25	0.1000	Green	0.375
2016004	2.25	0.1000	Green	0.375
2016005	2.25	0.1000	Green	0.375

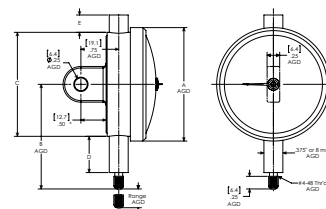

ACCESSORIES

Order no.	Description
2247145	Flat back
2016010	Adjustable back
2016007	Lug back
2016009	Post back
2016008	Screw back

MarCator 400B-3 / 400B-4

Mobile dial calibrator

FEATURES

- For checking and calibrating dial indicators, test indicators, digital indicators, and LVDT inductive probes
- Large micrometer style wheel has widely spaced graduations for easy setting and viewing
- Adjustable crosshair provides exact on-the-mark setting
- Anvil uses tungsten carbide for maximum wear resistance
- Indicator clamped in line with micrometer spindle for direct contact measurement
- **Data interface:** none
- **Package contains:** adapter bushing AD-58, split bushing BU-112, split bushing BU-197



Application:

- Portable dial calibrator

TECHNICAL DATA

Order no.	Type	Measuring span		Readings	Scale graduation value	Error limit	Error limit	Range per turn	Range per turn
		mm	inch						
2050665	400B-3		1.000"		.0001"		.00005"		0.0025
2050666	400B-4	25		0.002		0.001		0.05	

ACCESSORIES

Order no.	Description	Type
4305893	Universal centering support frame	800 b
2201843	Adaptor bushing 0.275" ID to 0.375" OD	AD-58
2205127	Split bushing with shoulder 8 mm stem hole X .375" OD	BU-197
2205082	Split bushing .218" x .374" x .5"	BU-112

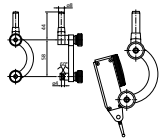

800 b

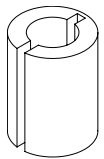

BU-112

Millimess | Digital and dial comparators

Millimess dial comparators differ from conventional dial indicators through more precise components, greater accuracy and improved hysteresis. Millimess dial comparators are especially suitable for radial runout, straightness and flatness measurements as well for comparative measurements. Other outstanding advantages include its easy handling, reliable readability and absolute shock resistance of the measuring mechanism.



Millimes overview	184
Dial comparator	
Millimes 2000 W / 2000 Wi	188
Inductive dial comparator	
Millimes 2001 W / 2001 Wi	190
Inductive dial comparator	
Millimes μMaxμm II	194
Inductive dial comparator	
Millimes μMaxμm III	197
Inductive digital comparator	
Mechanical dial comparator	
Millimes 1002 / 1002 T / 1003 / 1003 T	206
Mechanical dial comparator	
Millimes 1004 / 1004 T / 1003 XL / 1003 XLT	207
Mechanical dial comparator	
Millimes 1003	208
Mechanical dial comparator with special measuring force	
Millimes 1000 A / 1000 B	209
Mechanical dial comparator	
Millimes 1010 / 1010 T	210
Mechanical dial comparator	
Millimes 1010 Z	211
Mechanical dial comparator	

Millimess 2001 Wi: Everything under control! A digital comparator – highest level of precision due to inductive measuring system



Integrated Wireless

- Integrated Wireless interface
- Sending and receiving measuring data and various parameters



Lock individual keys and functions

Remote-controlled settings can be configured easily using MarCom Professional Software



Can be configured and controlled remotely using MarCom Professional Software



First digital comparator indicator with touch operation



Unique touch operation – even works with gloves

Extensive advantages:

- Keys react even with the slightest touch
- This prevents a measuring device from being adjusted or deformed
- **Maximum measuring certainty**

Hardened glass front

- Scratch and impact-resistant surface
- Excellent protection against scratches and penetrating liquids
- Wear-free keys react to the slightest touch



Protection rating IP 64

Excellent protection against dust and splash water from all directions ensures optimum workshop compatibility at all times



High-precision ball-bearing guide

Maximum sensitivity of the measuring system, long service life, and high loading capacity

Bidirectional data interface via USB

- Sending and receiving measuring data and various parameters
- Permanent power supply via data cable
- Possible to retrieve the device ID

#ID

Data interface via Digimatic

- To send measuring data



Convenient tolerance functions

- Clear tolerance symbols
- Colorful LED signals (red, green, yellow) to classify the measuring values
 - No go/Go/warning limit
 - No go/Go/rework

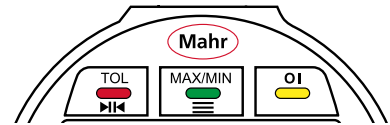

High precision inductive measuring system

Lowest measuring deviations thanks to linearization

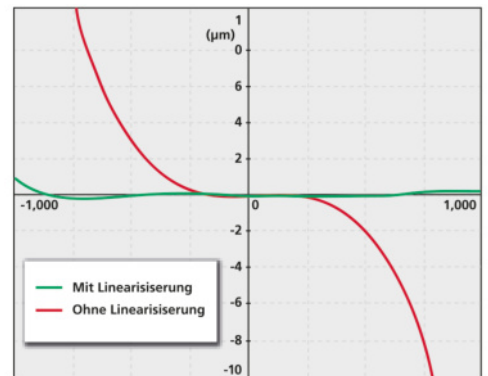

ABS system

Absolute measuring system

The reference to the electric zero point is not lost when the device is switched off



Millimes | Digital and dial comparators – design

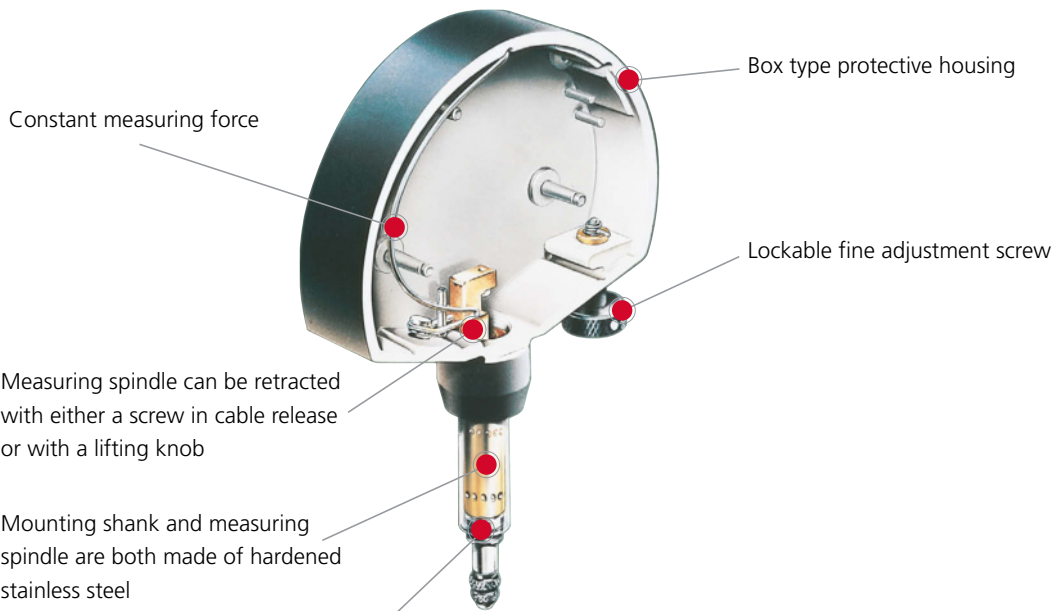

Measuring spindle is mounted in a high precision ball guide (Types 1000 / 1002 / 1003 / 1004) for minimal hysteresis



Resistant to lateral forces (side play) acting on the measuring spindle

Self contained movement, which is quick and easy to remove and replace

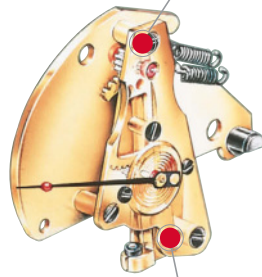

Maximum sensitivity and accuracy are ensured by the jeweled movement in conjunction with the precision gears and pinions

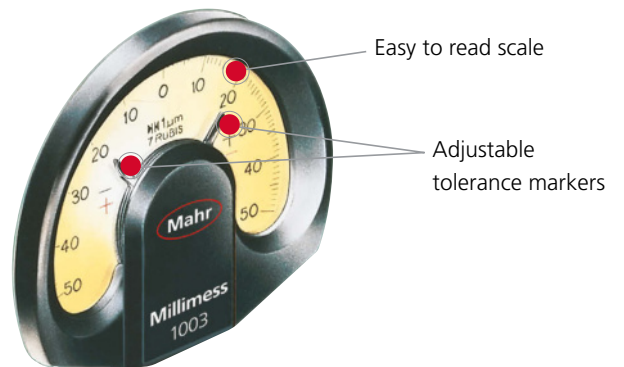

Millimes | Shockproof mechanism

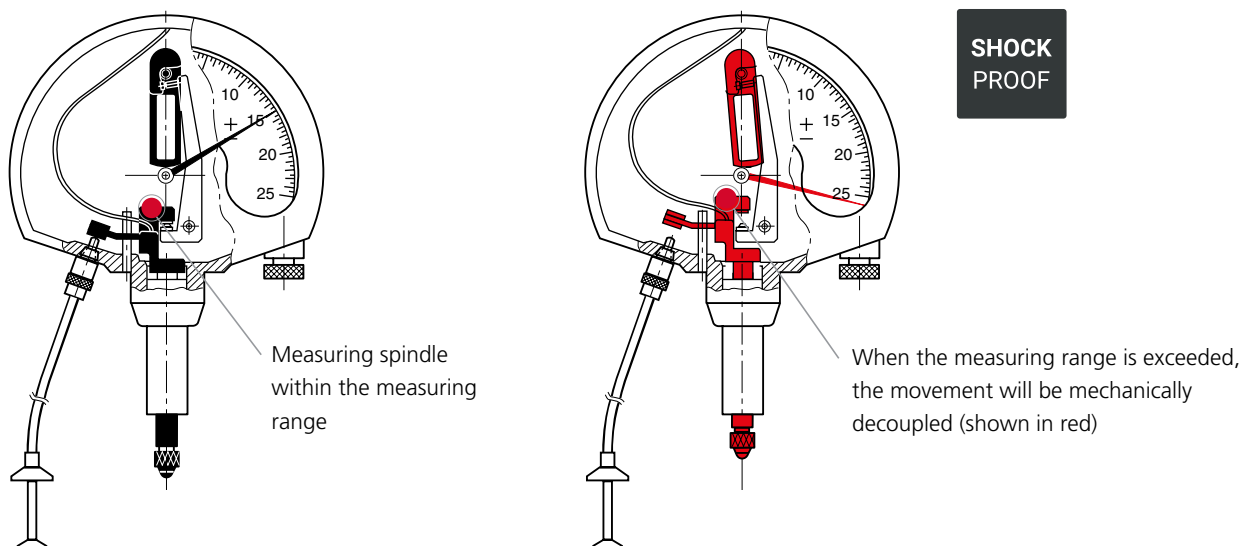

Millimes | Metrological characteristics

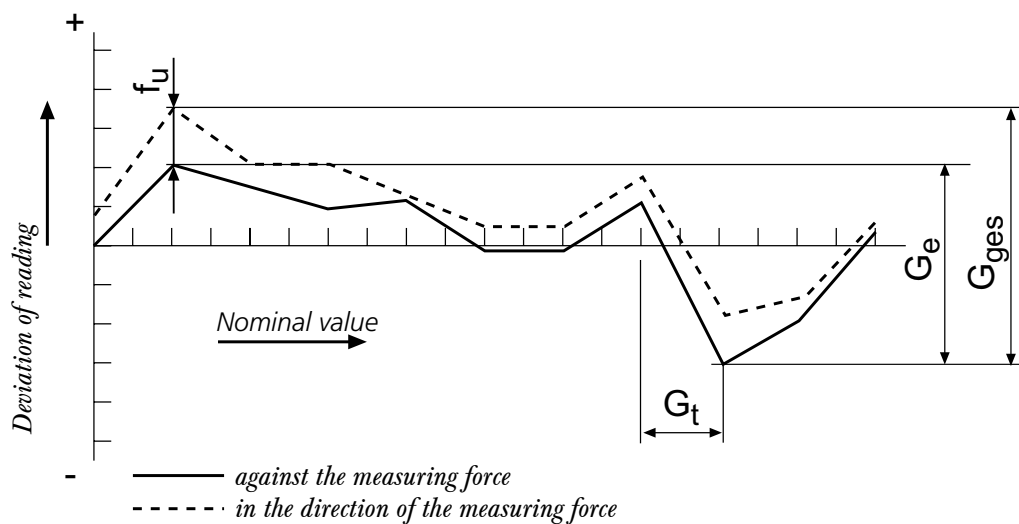

Millimes | Versions



Inductive digital comparator



Mechanical digital comparator



Mechanical digital comparator with protection class IP 54

Millimes 2000 W / 2000 Wi

Inductive dial comparator



FUNCTIONS

- ON/OFF
- mm/inch
- RESET (set display to zero)
- PRESET (for entering a numerical value)
- ABS (reference to the electrical zero point)
- Selectable resolution
- TOL (tolerance and warning limits input)
- Factor (adjustable)
- Reversal of counting direction
- HOLD (storage of measured values)
- LOCK function (key lock)
- DATA (data transmission)
- Bidirectional data interface (external output and input option of characteristic values as well as setting of individual lock functions by MarCom Software)

FEATURES

- Advantages of tempered glass front with touch control panels:
 - Scratch and impact resistant surface
 - Excellent protection against dust, coolants and lubricants
 - Wear-free touch operating keys
 - Improved safety of measurement values in measuring stands, as only a light touch of the key
 - No keystroke - is required, thus no adjustment or deformation of the measuring device
- High contrast LCD display
- Clear tolerance symbols and colored LED signals (red, green, yellow) for measured value classification
 - **with** warning limit input: No Go / Go / Warning Limit
 - **without** warning limit input: No Go / Go / Rework
- Operating and display unit (bezel) can be rotated through 280°
- Mounting shank and measuring spindle are both made of hardened stainless steel
- Measuring spindle is mounted in a high precision ball guide for minimal hysteresis
- Linearized inductive absolute measuring system
- Measuring force spring is interchangeable
- Lower stop is adjustable
- **Software:** MarCom Professional free download: www.mahr.com/marcom (only for Mahr data cables and wireless systems with USB and RS-232 interface)
- **Digit height:** 11.5 mm
- **Energy supply:** Integrated



Application:

- For static measuring tasks

TECHNICAL DATA

Order no.	4346700	4346701
Type	2000 W	2000 Wi
Measuring range	mm	± 1
Measuring range	inch	± .04"
Resolution	mm	0.0001, 0.0002, 0.0005, 0.001, 0.002, 0.005, 0.01
Resolution	inch	.000005", .00001", .00002", .00005", .0001", .0002", .0005"
Error limit	µm	± (0.2 + L/2) L in mm
Measuring value hysteresis f_v	µm	0.3
Repeatability f_w	µm	0.1
Standard		Factory standard
Free stroke	mm	2.5
Measuring force	N	0.9 ± 0.1 (at the electrical zero point)
IP protection category		IP 64
Data interface	USB, Digimatic	Integrated Wireless, USB, Digimatic
Supply voltage		100–240 V

Order no.	Mounting shaft
	mm
4346700	8
4346701	8

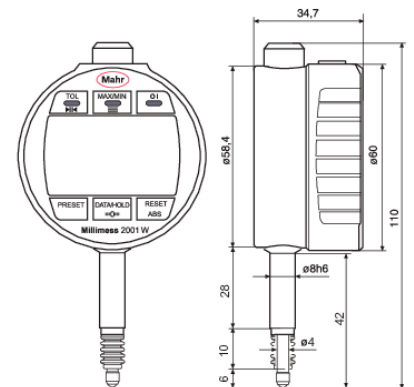

rechargeable accumulator (up to 4 weeks) or powered by USB data cable

- **Battery type:** Lithium Polymer Accu 3.7 V
- **Package contains:** instruction manual, USB data and charging cable type DK-U1, plug-in power supply (with 4 interchangeable adapters) for USB, rubber bellows, screwdriver for pre-stroke adjustment (hexagon socket 0.9 mm), case

Millimess 2000 W / 2000 Wi

Inductive dial comparator

ACCESSORIES

Order no.	Description	Type
4102603	Data cable USB bidirectional (2 m)	DK-U1
4102606	Interface adapter with data cable Digimatic (2 m)	DK-D1
4310103	Adapter bushing (.375" / 8 mm)	940
4346010	Manual lifer with cable release	2000 h
4346011	Pneumatic lifter	2000 p
4346012	Measuring force adjuster	2000 m
4337421	Lug back	1086 b
4346050	Measuring force spring 0.25 N	
4346051	Measuring force spring 0.50 N	
4882284	Measuring force spring 0.75 N	
4346052	Measuring force spring 1.00 N	
4346053	Measuring force spring 1.50 N	
4346054	Measuring force spring 2.00 N	
4346055	Measuring force spring 2.50 N	
4337900	Display protection film, anti reflective frosted, made of extra hard hybrid glass, to protect against scratches and reflections	1086 sf
4346606	Shock protection ring made of hard rubber for Millimess 2000 W(i) / 2001 W(i)	1086 sr
4102220	Receiver for instruments with Integrated Wireless	i-Stick

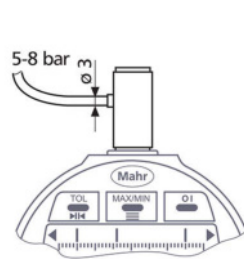

2000 p

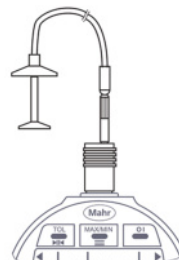

2000 h



2000 m



1086 sf



1086 sr



i-stick

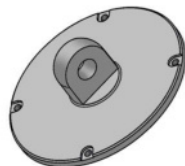

1086 b

Millimes 2001 W / 2001 Wi

Inductive dial comparator



FUNCTIONS

- ON/OFF
- mm/inch
- RESET (set display to zero)
- PRESET (for entering a numerical value)
- ABS (reference to the electrical zero point)
- Selectable resolution
- TOL (tolerance and warning limits input)
- RANGE (switch the measuring range and resolution)
- MAX/MIN (memory for searching the reversal point)
- MAX-MIN (for testing flatness and concentricity)
- 0 (set the analog scale display to zero)
- Factor (adjustable)
- Reversal of counting direction
- HOLD (storage of measured values)
- LOCK function (key lock)
- DATA (data transmission)
- Bidirectional data interface (external output and input option of characteristic values as well as setting of individual lock functions by MarCom Software)

FEATURES

- Advantages of tempered glass front with touch control panels:
 - Scratch and impact resistant surface
 - Excellent protection against dust, coolants and lubricants
 - Wear-free touch operating keys
 - Improved safety of measurement values in measuring stands, as only a light touch of the key
 - No keystroke - is required, thus no adjustment or deformation of the measuring device
- Clear tolerance limits in the scale display and colored LED signals (red, green, yellow) for measured value classification
 - **with** warning limit input: No Go / Go / Warning Limit
 - **without** warning limit input: No Go / Go / Rework
- LED signals (red, green, yellow) in mode:
 - Powered by accumulator: flashing signal (1 sec.)
 - Powered by data cable DK-U1: permanent
- High contrast LCD display
- Analog scale display for visual recognition of the measuring movement during dynamic measurement tasks such as checking of concentricity or flatness as well as for reversal point search during bore measurements
- Operating and display unit (bezel) can be rotated through 280°



Application:

- For static and dynamic measuring tasks

TECHNICAL DATA

Order no.	4346800	4346801
Type	2001 W	2001 Wi
Measuring range	mm	± 1
Measuring range	inch	± .04"
Resolution	mm	0.0001, 0.0002, 0.0005, 0.001, 0.002, 0.005, 0.01
Resolution	inch	.000005", .00001", .00002", .00005", .0001", .0002", .0005"
Error limit	µm	± (0.2 + L/2) L in mm
Measuring value hysteresis f_v	µm	0.3
Repeatability f_w	µm	0.1
Standard	Factory standard	
Free stroke	mm	2.5
Measuring force	N	0.9 ± 0.1 (at the electrical zero point)
Range of analog display	mm	± 0.002, ± 0.004, ± 0.01, ± 0.02, ± 0.04, ± 0.1, ± 0.2
IP protection category	IP 64	
Data interface	USB, Digimatic	Integrated Wireless, USB, Digimatic
Supply voltage	100–240 V	

Order no.	Mounting shaft
	mm
4346800	8
4346801	8
4346811	8

- Mounting shank and measuring spindle are both made of hardened stainless steel
- Measuring spindle is mounted in a high precision ball guide for minimal hysteresis
- Linearized inductive absolute measuring system
- Measuring force spring is interchangeable
- Lower stop is adjustable
- **Software:** MarCom Professional free download: www.mahr.com/marcom (only for Mahr data cables and wireless systems with USB and RS-232 interface)
- **Digit height:** 9 mm

- **Energy supply:** Integrated rechargeable accumulator (up to 4 weeks) or powered by USB data cable
- **Battery type:** Lithium Polymer Accu 3.7 V
- **Package contains:** instruction manual, USB data and charging cable type DK-U1, plug-in power supply (with 4 interchangeable adapters) for USB, rubber bellows, screwdriver for pre-stroke adjustment (hexagon socket 0.9 mm), case

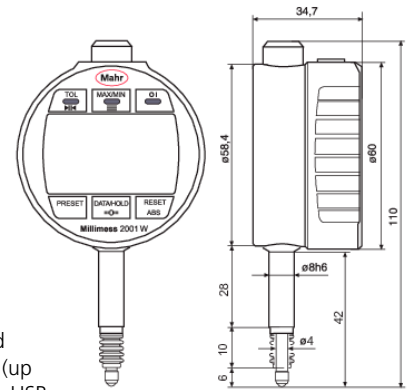

Millimess 2001 W / 2001 Wi

Inductive dial comparator

ACCESSORIES

Order no.	Description	Type
4102603	Data cable USB bidirectional (2 m)	DK-U1
4102606	Interface dapter with data cable Digimatic (2 m)	DK-D1
4310103	Adapter bushing (.375" / 8 mm)	940
4346010	Manual lifer with cable release	2000 h
4346011	Pneumatic lifter	2000 p
4346012	Measuring force adjuster	2000 m
4337421	Lug back	1086 b
4346050	Measuring force spring 0.25 N	
4346051	Measuring force spring 0.50 N	
4882284	Measuring force spring 0.75 N	
4346052	Measuring force spring 1.00 N	
4346053	Measuring force spring 1.50 N	
4346054	Measuring force spring 2.00 N	
4346055	Measuring force spring 2.50 N	
4337900	Display protection film, anti reflective frosted, made of extra hard hybrid glass, to protect against scratches and reflections	1086 sf
4346606	Shock protection ring made of hard rubber for Millimess 2000 W(i) / 2001 W(i)	1086 sr
4102220	Receiver for instruments with Integrated Wireless	i-Stick

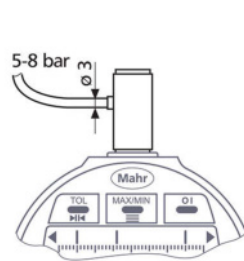

2000 p

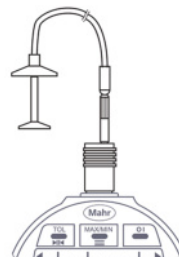

2000 h

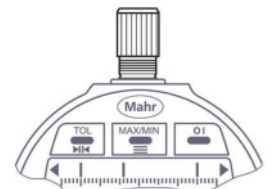

2000 m



1086 sf



1086 sr



i-stick

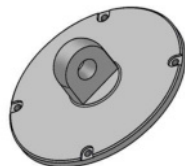

1086 b

Millimess 2001 Wi

Inductive dial comparator



FUNCTIONS

- ON/OFF
- RESET (set display to zero)
- PRESET (for entering a numerical value)
- ABS (reference to the electrical zero point)
- Selectable resolution
- TOL (tolerance and warning limits input)
- RANGE (switch the measuring range and resolution)
- MAX/MIN (memory for searching the reversal point)
- MAX-MIN (for testing flatness and concentricity)
- 0 (set the analog scale display to zero)
- Factor (adjustable)
- Reversal of counting direction
- HOLD (storage of measured values)
- LOCK function (key lock)
- DATA (data transmission)
- Bidirectional data interface (external output and input option of characteristic values as well as setting of individual lock functions by MarCom Software)

FEATURES

- Advantages of tempered glass front with touch control panels:
 - Scratch and impact resistant surface
 - Excellent protection against dust, coolants and lubricants
 - Wear-free touch operating keys
 - Improved safety of measurement values in measuring stands, as only a light touch of the key
 - No keystroke - is required, thus no adjustment or deformation of the measuring device
- Clear tolerance limits in the scale display and colored LED signals (red, green, yellow) for measured value classification
 - **with** warning limit input: No Go / Go / Warning Limit
 - **without** warning limit input: No Go / Go / Rework
- LED signals (red, green, yellow) in mode:
 - Powered by accumulator: flashing signal (1 sec.)
 - Powered by data cable DK-U1: permanent
- High contrast LCD display
- Analog scale display for visual recognition of the measuring movement during dynamic measurement tasks such as checking of concentricity or flatness as well as for reversal point search during bore measurements
- Operating and display unit (bezel)



Applications:

- For static and dynamic measuring tasks
- **Version:** Unit of measurement only METRIC (without INCH)

TECHNICAL DATA

Order no.		4346811
Type		2001 Wi
Measuring range	mm	± 1
Resolution	mm	0.0001, 0.0002, 0.0005, 0.001, 0.002, 0.005, 0.01
Error limit	µm	± (0.2 + L/2) L in mm
Measuring value hysteresis f_u	µm	0.3
Repeatability f_w	µm	0.1
Standard		Factory standard
Free stroke	mm	2.5
Measuring force	N	0.9 ± 0.1 (at the electrical zero point)
Range of analog display	mm	± 0.002, ± 0.004, ± 0.01, ± 0.02, ± 0.04, ± 0.1, ± 0.2
IP protection category		IP 64
Data interface		Integrated Wireless, USB, Digimatic
Supply voltage		100–240 V

Order no.	Mounting shaft
	mm
4346811	8

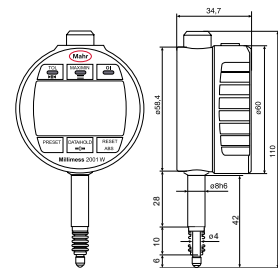

- can be rotated through 280°
- Mounting shank and measuring spindle are both made of hardened stainless steel
- Measuring spindle is mounted in a high precision ball guide for minimal hysteresis
- Linearized inductive absolute measuring system
- Measuring force spring is interchangeable
- Lower stop is adjustable
- **Software:** MarCom Professional free download: www.mahr.com/marcom (only for Mahr data cables and wireless systems with USB and RS-232 interface)
- **Digit height:** 9 mm

- **Energy supply:** Integrated rechargeable accumulator (up to 4 weeks) or powered by USB data cable
- **Battery type:** Lithium Polymer Accu 3.7 V
- **Package contains:** instruction manual, USB data and charging cable type DK-U1, plug-in power supply (with 4 interchangeable adapters) for USB, rubber bellows, screwdriver for pre-stroke adjustment (hexagon socket 0.9 mm), case

ACCESSORIES

Order no.	Description	Type
4102220	Receiver for instruments with Integrated Wireless	i-Stick
4102603	Data cable USB bidirectional (2 m)	DK-U1
4102606	Interface adapter with data cable Digimatic (2 m)	DK-D1
4310103	Adapter bushing (.375" / 8 mm)	940
4346010	Manual lifer with cable release	2000 h
4346011	Pneumatic lifter	2000 p
4346012	Measuring force adjuster	2000 m
4337421	Lug back	1086 b
4346050	Measuring force spring 0.25 N	
4346051	Measuring force spring 0.50 N	
4882284	Measuring force spring 0.75 N	
4346052	Measuring force spring 1.00 N	
4346053	Measuring force spring 1.50 N	
4346054	Measuring force spring 2.00 N	
4346055	Measuring force spring 2.50 N	
4337900	Display protection film, anti reflective frosted, made of extra hard hybrid glass, to protect against scratches and reflections	1086 sf
4346606	Shock protection ring made of hard rubber for Millimes 2000 W(i) / 2001 W(i)	1086 sr



i-Stick

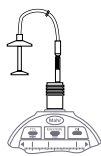

2000 h

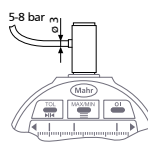

2000 p

Millimes μMaxμm II

Inductive digital comparator



FUNCTIONS

- ON/OFF
- RESET (set display to zero)
- mm/inch
- Reversal of counting direction
- ABS (display can be set to zero without losing reference to preset)
- MAX/MIN (memory for searching the reversal point)
- MAX-MIN (for testing flatness and concentricity)
- Factor (adjustable)
- HOLD (storage of measured values)



FEATURES

- Inductive absolute measuring system
- Large, high contrast display with numerical and scale display
- Control and display unit rotatable through 270°
- Zero point setting is retained even after switching off the dial indicator

Optional Factory Configured Features:

- Locked multiplier factor for ratio measurements
- Disabled sleep mode (manual ON/OFF)
- Locked inch or mm display unit
- Power up in inch or mm unit on battery change
- Calibration mode lockout (with password entry)
- Setup mode lockout (with password entry)
- **Software:** MarCom Professional free download: www.mahr.com/marcom (only for Mahr data cables and wireless systems with USB and RS-232 interface)
- **Digit height:** 8 mm
- **Energy supply:** battery operation
- **Battery type:** CR 2450N (3V Lithium)
- **Package contains:** instruction manual, battery

TECHNICAL DATA

Order no.	2034201	2034203	2034205	2034207
Type	μMaxμm II			
Measuring range	mm	±1		
Measuring range	inch	±.040"		
Resolution	mm	0.0002, 0.0005, 0.001, 0.002, 0.005, 0.01, 0.02		
Resolution	inch	.00001", .00002", .00005", .0001", .0002", .0005", .001"		
Error limit	μm	± 5		
Error limit in partial measuring range	μm	± 1.25		
Partial measuring range	mm	± 0.5		
Standard	Factory standard			
Measuring force	N	0.8 – 1.1		
IP protection category	IP 54			
Data interface	Digimatic, Opto RS-232C, USB			

Order no.	a	b	c	Mounting shaft	Mounting shaft
	mm	mm	mm	inch	mm
2034201	11.7	24.1	53.6	0.375	
2034203	38	57.2	86.6	0.375	
2034205	11.7	24.1	53.6		8
2034207	38	57.2	86.6		8

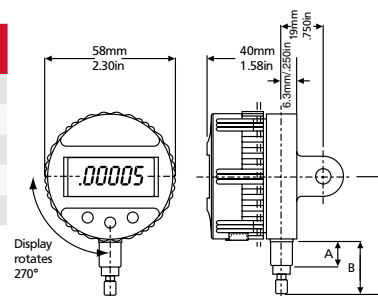

ACCESSORIES

Order no.	Description	Type
2210555	Lug back	EBK-1010
2212878	Splash guard cover	ECV-1307-W2
4310103	Adapter bushing (.375" / 8 mm)	940
4346023	2000 USB data connection cable USB (2 m)	2000 USB
4346021	Interface adapter with data cable Digimatic (2 m)	2000 d
4346020	Data connection cable RS232C (2 m)	2000 r
4102232	2000 e Transmitter for e-Stick	2000 e
4102230	e-Stick receiver	e-Stick
2210556	Back panel with cylindrical holder, Ø = .5", l = 1"	EBK-1012
2210557	Back panel with threaded bore 1/4-28, Ø = 11/16", l = .5"	EBK-1013
2210561	Flat back panel	EBK-1018
2210559	Back panel with adjustable holder	EBK-1016
2210558	Back panel with rack	EBK-1014
2232570	Measuring force springs 0.35N	SP-351

Millimes μMaxμm II

Inductive digital comparator



FUNCTIONS

- ON/OFF
- RESET (set display to zero)
- mm/inch
- Reversal of counting direction
- ABS (display can be set to zero without losing reference to preset)
- MAX/MIN (memory for searching the reversal point)
- MAX-MIN (for testing flatness and concentricity)
- Factor (adjustable)
- HOLD (storage of measured values)

FEATURES

- Inductive absolute measuring system
- Large, high contrast display with numerical and scale display
- Control and display unit rotatable through 270°
- Zero point setting is retained even after switching off the dial indicator

Optional Factory Configured Features:

- Locked multiplier factor for ratio measurements
- Disabled sleep mode (manual ON/OFF)
- Locked inch or mm display unit
- Power up in inch or mm unit on battery change
- Calibration mode lockout (with password entry)
- Setup mode lockout (with password entry)
- **Software:** MarCom Professional free download: www.mahr.com/marcom (only for Mahr data cables and wireless systems with USB and RS-232 interface)
- **Digit height:** 8 mm
- **Energy supply:** battery operation
- **Battery type:** CR 2450N (3V Lithium)
- **Package contains:** instruction manual, battery



Applications:

- Vertical design with perpendicular measuring spindle
- For static and dynamic measurements

TECHNICAL DATA

Order no.	2034401		
Type	μMaxμm II		
Measuring range	mm	±1	
Measuring range	inch	± .040"	
Resolution	mm	0.0002, 0.0005, 0.001, 0.002, 0.005, 0.01, 0.02	
Resolution	inch	.00001", .00002", .00005", .0001", .0002", .0005", .001"	
Error limit	μm	± 5	
Error limit in partial measuring range	μm	± 1.25	
Partial measuring range	mm	± 0.5	
Standard	Factory standard		
Measuring force	N	0.8 – 1.1	
IP protection category	IP 54		
Data interface	Digimatic, Opto RS-232C, USB		

Order no.	a	b	Mounting shaft
	mm	mm	inch
2034401	11.7	24.1	0.375

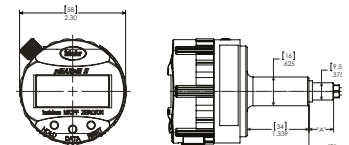

ACCESSORIES

Order no.	Description	Type
2212878	Splash guard cover	ECV-1307-W2
2232570	Measuring force springs 0.35N	SP-351
2201833	Thread adapter, M2.5 male to #4-48 female threads	AD-185
4310103	Adapter bushing (.375" / 8 mm)	940
4346023	2000 USB data connection cable USB (2 m)	2000 USB
4346021	Interface adapter with data cable Digimatic (2 m)	2000 d
4346020	Data connection cable RS232C (2 m)	2000 r

Millimes µMaxµm II

Inductive digital comparator



FUNCTIONS

- ON/OFF
- PRESET (for entering a numerical value)
- RESET (set display to zero)
- Selectable resolution
- Reversal of counting direction
- <0> (tolerance GO / NO GO display mode)
- mm/inch

FEATURES

- Inductive absolute measuring system
- Large, high contrast display with numerical and scale display
- Control and display unit rotatable through 270°
- Zero point setting is retained even after switching off the dial indicator

Optional Factory ConFigureed Features:

- Locked multiplier factor for ratio measurements
- Disabled sleep mode (manual ON/OFF)
- Locked inch or mm display unit
- Power up in inch or mm unit on battery change
- Calibration mode lockout (with password entry)
- Setup mode lockout (with password entry)
- **Software:** MarCom Professional free download: www.mahr.com/marcom (only for Mahr data cables and wireless systems with USB and RS-232 interface)
- **Digit height:** 8 mm
- **Energy supply:** battery operation
- **Battery type:** CR 2450N (3V Lithium)
- **Package contains:** instruction manual, battery

Application:

- For static measurements

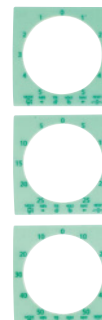

TECHNICAL DATA

Order no.	2034101	2034103	2034105	2034107
Type	µMaxµm II			
Measuring range	mm	±1		
Measuring range	inch	±.040"		
Resolution	mm	0.0002, 0.0005, 0.001, 0.002, 0.005, 0.01, 0.02		
Resolution	inch	.00001", .00002", .00005", .0001", .0002", .0005", .001"		
Error limit	µm	± 5		
Error limit in partial measuring range	µm	± 1.25		
Partial measuring range	mm	± 0.5		
Standard	Factory standard			
Measuring force	N	0.8 – 1.1		
IP protection category	IP 54			
Data interface	Digimatic, Opto RS–232C, USB			

Order no.	a	b	c	Mounting shaft	Mounting shaft
	mm	mm	mm	inch	mm
2034101	11.7	24.1	53.6	0.375	
2034103	38	57.2	86.6	0.375	
2034105	11.7	24.1	53.6		8
2034107	38	57.2	86.6		8

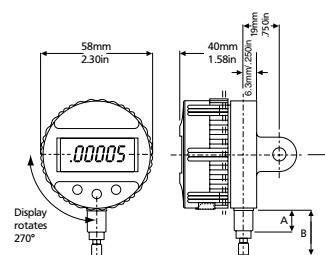

ACCESSORIES

Order no.	Description	Type
2210555	Lug back	EBK–1010
2210556	Back panel with cylindrical holder, Ø = .5", l = 1"	EBK–1012
2210557	Back panel with threaded bore 1/4–28, Ø = 11/16", l = .5"	EBK–1013
2210558	Back panel with rack	EBK–1014
2210559	Back panel with adjustable holder	EBK–1016
2210561	Flat back panel	EBK–1018
2212878	Splash guard cover	ECV–1307-W2
2232570	Measuring force springs 0.35N	SP–351
2201833	Thread adapter, M2.5 male to #4–48 female threads	AD–185
4310103	Adapter bushing (.375" / 8 mm)	940
4346023	2000 USB data connection cable USB (2 m)	2000 USB
4346021	Interface adapter with data cable Digimatic (2 m)	2000 d
4346020	Data connection cable RS232C (2 m)	2000 r
4102230	e-Stick receiver	e-Stick
4102232	Transmitter for e-Stick	2000 e



e-Stick



2000 e

Millimes Maxµm III

Display unit



FUNCTIONS

- RESET (set display to zero)
- mm/inch
- Reversal of counting direction
- RANGE (switch the measuring range and resolution)
- ABS (reference to the electrical zero point)
- TOL (enter tolerance limit values)
- MAX/MIN (memory for searching the reversal point)
- MAX-MIN (for testing flatness and concentricity)
- HOLD (storage of measured values)

FEATURES

- Large, high contrast digital, analog and fan display for better readability while testing flatness and concentricity as well as for searching the reversal point in bores
- Interchangeable dials
- Inductive absolute measuring system
- Metal cast housing with robust buttons
- **Software:** MarCom Professional free download: www.mahr.com/marcom (only for Mahr data cables and wireless systems with USB and RS-232 interface)
- **Energy supply:** battery operation, battery life approx. 4000 hrs.
- **Package contains:** interchangeable dials, battery, instruction manual

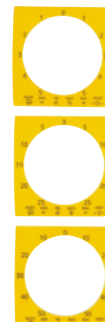

TECHNICAL DATA

Order no.	2033001	2033011	2033021
Type	Maxµm III		
Measuring range	mm	Dependent on probe type	
Standard	Factory standard		
Measuring force	N	-	
IP protection category	IP 54		
Data interface	None	RS-232C, Digimatic	Digimatic, RS-232C

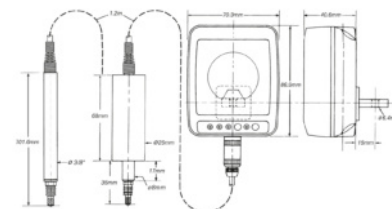

ACCESSORIES

Order no.	Description	Type
2239138	Battery for Maxµm III type CR 123A	
2212877	Dust cover	ECV-1307-W1
2239040	Set of 3 inch and 3 metric scale overlay	
2217907	Spare screws for back panels	ESW-1252
2240545	Maxµm III, unlock setup and unlock calibration key, (D, E1)	
2239035	Interface adapter with data cable Digimatic (2 m) (D, E1)	
2239036	Data cable RS232C (2 m) (D, E1)	
2240547	Maxµm III, unlock setup and unlock calibration key, remove (E2)	
2239037	Interface adapter with data cable Digimatic (2 m) (E2)	
2239038	Data connection cable RS232C (2 m) (E2)	
2121428	USB data cable for Maxµm III (2 m) (E1)	

Millimes Maxµm III

Digital probe

FEATURES

- Maxµm transducers are available as replacement parts - refer to part price list for part numbers and pricing
- Maxµm III remote indicating units are sold without digital transducer
- Any digital transducer may be used with a Maxµm III remote indicating unit
- For alternate cable lengths, extension cables or special indicator options - call Mahr's Technical Assistance Group
- **Software:** MarCom Professional free download: www.mahr.com/marcom (only for Mahr data cables and wireless systems with USB and RS-232 interface)



TECHNICAL DATA

Order no.		2033091	2033092	2033093	2033094	2033095	2033096	2033097	2033098
Type		Maxµm III							
Measuring range	mm	± 1.00	± 1.99	± 1.00	± 1.99	± 1.00	± 1.99	± 1.00	± 1.99
Measuring range	inch	± .040"	± .100"	± .040"	± .100"	± .040"	± .100"	± .040"	± .100"
Resolution	mm	0.0005, 0.001, 0.005	0.001, 0.005	0.0005, 0.001, 0.005	0.001, 0.005	0.0005, 0.001, 0.005	0.001, 0.005	0.0005, 0.001, 0.005	0.001, 0.005
Resolution	inch	.00002", .00005", .0001", .0005"	.0001", .0005"	.00002", .00005", .0001", .0005"	.0001", .0005"	.00002", .00005", .0001", .0005"	.0001", .0005"	.00002", .00005", .0001", .0005"	.0001", .0005"
Error limit	µm	± 10	± 14	± 10	± 14	± 10	± 14	± 10	± 14
Error limit in partial measuring range	µm	± 1		± 1		± 1		± 1	
Partial measuring range	mm	± 0.199		± 0.199		± 0.199		± 0.199	
Standard		Factory standard							
Measuring force	N	0.8 – 1.1							

Order no.	a	Mounting shaft	Mounting shaft
	mm	inch	mm
2033091	17	0.375	
2033092	17	0.375	
2033093	38	0.375	
2033094	38	0.375	
2033095	17		8
2033096	17		8
2033097	38		8
2033098	38		8

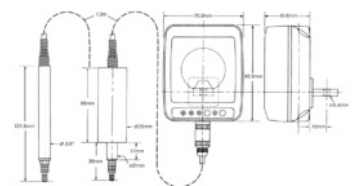

ACCESSORIES

Order no.	Description	Type
2201628	Adapter - T-bracket, d = .375"	AAD-91
2208615	Adapter - rack bracket, for Maxµm III transducer probes, d = .375"	EAD-1007-W1
2208616	Adapter - rack bracket, for Maxµm III transducer probes, d = 8 mm	EAD-1007-W2
2236895	Mounting block for back panel with rack	

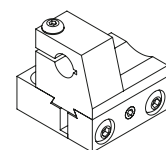

EAD-1007-W1;
EAD-1007-W2

Millimes Maxµm III

Digital probe

FEATURES

- Maxµm transducers are available as replacement parts - refer to part price list for part numbers and pricing
- Maxµm III remote indicating units are sold without digital transducer
- Any digital transducer may be used with a Maxµm III remote indicating unit
- For alternate cable lengths, extension cables or special indicator options - call Mahr's Technical Assistance Group
- **Software:** MarCom Professional free download: www.mahr.com/marcom (only for Mahr data cables and wireless systems with USB and RS-232 interface)



TECHNICAL DATA

Order no.	2033099	
Type	Maxµm III	
Measuring range	mm	± 1.00
Measuring range	inch	± .040"
Resolution	mm	0.0005, 0.001, 0.005
Resolution	inch	.00002", .00005", .0001", .0005"
Error limit	µm	± 10
Error limit in partial measuring range	µm	± 1
Partial measuring range	mm	± 0.199
Standard	Factory standard	
Measuring force	N	0.8 - 1.1

Order no.	a	Mounting shaft
	mm	inch
2033099	82.5	0.375

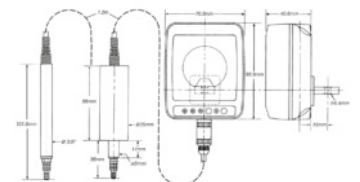

ACCESSORIES

Order no.	Description	Type
2201628	Adapter - T-bracket, d = .375"	AAD-91
2208615	Adapter - rack bracket, for Maxµm III transducer probes, d = .375"	EAD-1007-W1
2208616	Adapter - rack bracket, for Maxµm III transducer probes, d = 8 mm	EAD-1007-W2
2236895	Mounting block for back panel with rack	

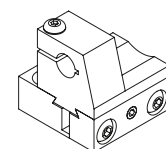

EAD-1007-W1;
EAD-1007-W2

Millimes Maxµm III

Inductive digital comparator



FUNCTIONS

- RESET (set display to zero)
- mm/inch
- Reversal of counting direction
- RANGE (switch the measuring range and resolution)
- ABS (reference to the electrical zero point)
- TOL (enter tolerance limit values)
- MAX/MIN (memory for searching the reversal point)
- MAX-MIN (for testing flatness and concentricity)
- HOLD (storage of measured values)

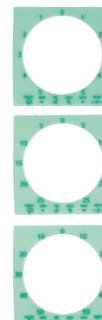

FEATURES

- Large, high contrast digital, analog and fan display for better readability while testing flatness and concentricity as well as for searching the reversal point in bores
- Interchangeable dials
- Inductive absolute measuring system
- Metal cast housing with robust buttons
- **Software:** MarCom Professional free download: www.mahr.com/marcom (only for Mahr data cables and wireless systems with USB and RS-232 interface)
- **Energy supply:** battery life approx. 4000 hrs.
- **Package contains:** interchangeable dials, battery, instruction manual

TECHNICAL DATA

Order no.	2033121	2033122	2033123	2033124	2033125	2033126	2033127	2033128		
Type	Maxµm III									
Measuring range	mm	±1	±1.99	±1	±1.99	±1	±1.99	±1	±1.99	
Measuring range	inch	±.040"	±.100"	±.040"	±.100"	±.040"	±.100"	±.040"	±.100"	
Resolution	mm	0.0005, 0.001, 0.005	0.001, 0.005	0.0005, 0.001, 0.005	0.001, 0.005	0.0005, 0.001, 0.005	0.001, 0.005	0.0005, 0.001, 0.005	0.001, 0.005	
Resolution	inch	.00002", .00005", .0001", .0005"	.0001", .0005"	.00002", .00005", .0001", .0005"	.0001", .0005"	.00002", .00005", .0001", .0005"	.0001", .0005"	.00002", .00005", .0001", .0005"	.0001", .0005"	
Error limit	µm	± 10	± 14	± 10	± 14	± 10	± 14	± 10	± 14	
Error limit in partial measuring range	µm	± 1		± 1		± 1		± 1		
Partial measuring range	mm	± 0.199		± 0.199		± 0.199		± 0.199		
Standard	Factory standard									
Free stroke	mm	0.8	1.3	0.8	1.3	0.8	1.3	0.8	1.3	
Measuring force	N	0.8 – 1.1								
Range of analog display	mm	± 5, ± 25, ± 50	± 25, ± 50	± 5, ± 25, ± 50	± 25, ± 50	± 5, ± 25, ± 50	± 25, ± 50	± 5, ± 25, ± 50	± 25, ± 50	
IP protection category	IP 54									
Data interface	RS-232C, USB									

Order no.	a	b	c	Mounting shaft
	mm	mm	mm	mm
2033121	17	36	63.5	
2033122	22	47	73	
2033123	38	57	84.6	
2033124	38	57	84.6	
2033125	17	36	63.5	8
2033126	22	47	73	8
2033127	38	57	84.6	8
2033128	38	57	84.6	8

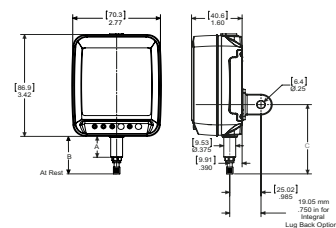

Millimes Maxum III

Inductive digital comparator

ACCESSORIES

Order no.	Description	Type
2239138	Battery for Maxum III type CR 123A	
2209094	Lifting lever, left	EAS-1903
2210406	Right angle attachment - spring type ($\pm .187''$ range)	EAT-1034-W1
2210407	Right angle attachment - spring type ($\pm .060''$ range)	EAT-1035-W1
2210551	Back panel with rack	EBK-1005
2236895	Mounting block for back panel with rack	
2210552	Back panel with eyelets	EBK-1006
2210553	Back panel with adjustable holder	EBK-1007
2212877	Dust cover	ECV-1307-W1
2217907	Spare screws for back panels	ESW-1252
2239037	Interface adapter with data cable Digimatic (2 m) (E2)	
2239038	Data connection cable RS232C (2 m) (E2)	
2200362	Foot switch for send data (Maxum) or dynamic reset/zeroing (832), 1.5 m / 5 ft cable	300-50
2239040	Set of 3 inch and 3 metric scale overlay	
2240547	Maxum III, unlock setup and unlock calibration key, remove (E2)	
2209924	Hand switch for Hold/Reset	EAS-2867
2209925	Foot switch for Hold/Reset	EAS-2868
2212428	USB data cable for Maxum III (2 m) (E1)	

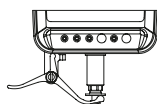

EAS-1903

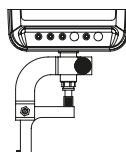

EAT-1034-W1;
EAT-1035-W1

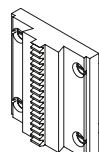

EBK-1005

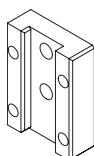

EBK-1007

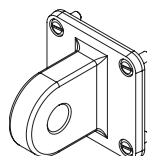

EBK-1006

Millimes Maxµm III

Inductive digital comparator



FUNCTIONS

- RESET (set display to zero)
- mm/inch
- Reversal of counting direction
- RANGE (switch the measuring range and resolution)
- ABS (reference to the electrical zero point)
- TOL (enter tolerance limit values)
- MAX/MIN (memory for searching the reversal point)
- MAX-MIN (for testing flatness and concentricity)
- HOLD (storage of measured values)

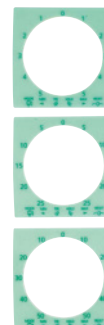

FEATURES

- Large, high contrast digital, analog and fan display for better readability while testing flatness and concentricity as well as for searching the reversal point in bores
- Interchangeable dials
- Inductive absolute measuring system
- Metal cast housing with robust buttons
- **Software:** MarCom Professional free download: www.mahr.com/marcom (only for Mahr data cables and wireless systems with USB and RS-232 interface)
- **Energy supply:** battery life approx. 4000 hrs.
- **Package contains:** interchangeable dials, battery, instruction manual

TECHNICAL DATA

Order no.	2033111	2033112	2033113	2033114	2033115	2033116	2033117	2033118		
Type	Maxµm III									
Measuring range	mm	±1	±1.99	±1	±1.99	±1	±1.99	±1	±1.99	
Measuring range	inch	±.040"	±.100"	±.040"	±.100"	±.040"	±.100"	±.040"	±.100"	
Resolution	mm	0.0005, 0.001, 0.005	0.001, 0.005	0.0005, 0.001, 0.005	0.001, 0.005	0.0005, 0.001, 0.005	0.001, 0.005	0.0005, 0.001, 0.005	0.001, 0.005	
Resolution	inch	.00002", .00005", .0001", .0005"	.0001", .0005"	.00002", .00005", .0001", .0005"	.0001", .0005"	.00002", .00005", .0001", .0005"	.0001", .0005"	.00002", .00005", .0001", .0005"	.0001", .0005"	
Error limit	µm	± 10	± 14	± 10	± 14	± 10	± 14	± 10	± 14	
Error limit in partial measuring range	µm	± 1		± 1		± 1		± 1		
Partial measuring range	mm	± 0.199		± 0.199		± 0.199		± 0.199		
Standard	Factory standard									
Free stroke	mm	0.8	1.3	0.8	1.3	0.8	1.3	0.8	1.3	
Measuring force	N	0.8 – 1.1								
Range of analog display	mm	± 5, ± 25, ± 50	± 25, ± 50	± 5, ± 25, ± 50	± 25, ± 50	± 5, ± 25, ± 50	± 25, ± 50	± 5, ± 25, ± 50	± 25, ± 50	
IP protection category	IP 54									
Data interface	RS-232C, Digimatic, USB									

Order no.	a	b	c	Mounting shaft
	mm	mm	mm	mm
2033111	17	36	63.5	
2033112	22	47	73	
2033113	38	57	84.6	
2033114	38	57	84.6	
2033115	17	36	63.5	8
2033116	22	47	73	8
2033117	38	57	84.6	8
2033118	38	57	84.6	8

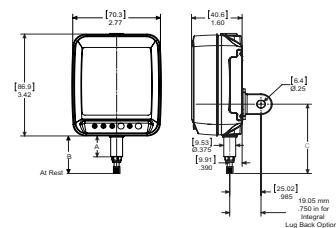

Millimes Maxµm III

Inductive digital comparator

ACCESSORIES

Order no.	Description	Type
2239138	Battery for Maxµm III type CR 123A	
2209094	Lifting lever, left	EAS-1903
2210406	Right angle attachment - spring type (\pm .187" range)	EAT-1034-W1
2210407	Right angle attachment - spring type (\pm .060" range)	EAT-1035-W1
2210551	Back panel with rack	EBK-1005
2236895	Mounting block for back panel with rack	
2210552	Back panel with eyelets	EBK-1006
2210553	Back panel with adjustable holder	EBK-1007
2212877	Dust cover	ECV-1307-W1
2217907	Spare screws for back panels	ESW-1252
2239035	Interface adapter with data cable Digimatic (2 m) (D, E1)	
2239036	Data cable RS232C (2 m) (D, E1)	
2121428	USB data cable for Maxµm III (2 m) (E1)	
2200362	Foot switch for send data (Maxµm) or dynamic reset/zeroing (832), 1.5 m / 5 ft cable	300-50
2240545	Maxµm III, unlock setup and unlock calibration key, (D, E1)	
2239040	Set of 3 inch and 3 metric scale overlay	

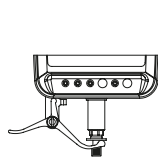

EAS-1903

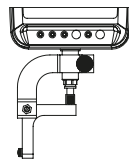

EAT-1034-W1;
EAT-1035-W1

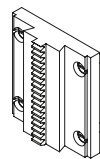

EBK-1005

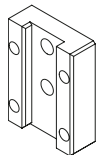

EBK-1007

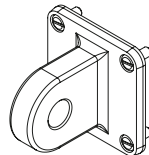

EBK-1006

Millimes Maxµm III

Inductive digital comparator



FUNCTIONS

- RESET (set display to zero)
- mm/inch
- Reversal of counting direction
- RANGE (switch the measuring range and resolution)
- ABS (reference to the electrical zero point)
- TOL (enter tolerance limit values)
- MAX/MIN (memory for searching the reversal point)
- MAX-MIN (for testing flatness and concentricity)
- HOLD (storage of measured values)

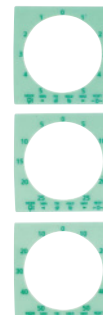

FEATURES

- Large, high contrast digital, analog and fan display for better readability while testing flatness and concentricity as well as for searching the reversal point in bores
- Interchangeable dials
- Inductive absolute measuring system
- Metal cast housing with robust buttons
- **Software:** MarCom Professional free download: www.mahr.com/marcom (only for Mahr data cables and wireless systems with USB and RS-232 interface)
- **Energy supply:** Battery life approx. 4000 hrs.
- **Package contains:** interchangeable dials, battery, instruction manual

TECHNICAL DATA

Order no.	2033101	2033102	2033103	2033104	2033105	2033106	2033107	2033108		
Type	Maxµm III									
Measuring range	mm	±1	±1.99	±1	±1.99	±1	±1.99	±1	±1.99	
Measuring range	inch	±.040"	±.100"	±.040"	±.100"	±.040"	±.100"	±.040"	±.100"	
Resolution	mm	0.0005, 0.001, 0.005	0.001, 0.005	0.0005, 0.001, 0.005	0.001, 0.005	0.0005, 0.001, 0.005	0.001, 0.005	0.0005, 0.001, 0.005	0.001, 0.005	
Resolution	inch	.00002", .00005", .0001", .0005"	.0001", .0005"	.00002", .00005", .0001", .0005"	.0001", .0005"	.00002", .00005", .0001", .0005"	.0001", .0005"	.00002", .00005", .0001", .0005"	.0001", .0005"	
Error limit	µm	±10	±14	±10	±14	±10	±14	±10	±14	
Error limit in partial measuring range	µm	±1		±1		±1		±1		
Partial measuring range	mm	±0.199		±0.199		±0.199		±0.199		
Standard	Factory standard									
Free stroke	mm	0.8	1.3	0.8	1.3	0.8	1.3	0.8	1.3	
Measuring force	N	0.8 – 1.1								
Range of analog display	mm	±5, ±25, ±50	±25, ±50	±5, ±25, ±50	±25, ±50	±5, ±25, ±50	±25, ±50	±5, ±25, ±50	±25, ±50	
IP protection category	IP 54									

Order no.	a	b	c	Mounting shaft
	mm	mm	mm	mm
2033101	17	36	63.5	
2033102	22	47	73	
2033103	38	57	84.6	
2033104	38	57	84.6	
2033105	17	36	63.5	8
2033106	22	47	73	8
2033107	38	57	84.6	8
2033108	38	57	84.6	8

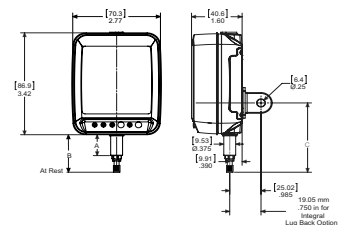

Millimes Maxµm III

Inductive digital comparator

ACCESSORIES

Order no.	Description	Type
2239138	Battery for Maxµm III type CR 123A	
2209094	Lifting lever, left	EAS-1903
2210406	Right angle attachment - spring type ($\pm .187''$ range)	EAT-1034-W1
2210407	Right angle attachment - spring type ($\pm .060''$ range)	EAT-1035-W1
2210551	Back panel with rack	EBK-1005
2236895	Mounting block for back panel with rack	
2210552	Back panel with eyelets	EBK-1006
2210553	Back panel with adjustable holder	EBK-1007
2212877	Dust cover	ECV-1307-W1
2239040	Set of 3 inch and 3 metric scale overlay	
2217907	Spare screws for back panels	ESW-1252

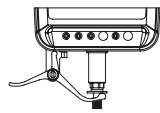

EAS-1903

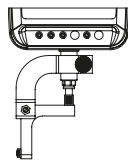

EAT-1034-W1;
EAT-1035-W1

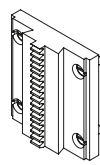

EBK-1005

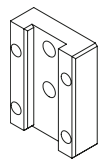

EBK-1007

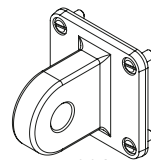

EBK-1006

FEATURES

- Large, high contrast dial face
- Adjustable tolerance markers
- Lockable fine adjustment screw
- Shockproof movement
- Mounting shank and measuring spindle are both made of hardened stainless steel
- Measuring spindle is mounted in a high precision ball guide for minimal hysteresis
- Resistant to lateral forces (side play) acting on the measuring spindle
- Maximum sensitivity and accuracy are ensured by the jeweled movement in conjunction with the precision gears and pinions
- Box type protective housing
- Constant measuring force
- Measuring spindle can be retracted with either a screw in cable release or with a lifting knob
- Package contains: case



TECHNICAL DATA

Order no.		4334000	4334005	4334102	4334103	4335000	4335005
Type		1003	1003 T	1002	1003	1002	1002 T
Measuring range	mm	± 0.05		± 0.03	± 0.05		± 0.03
Scale graduation value	µm	1		0.5	1		0.5
Figure on dial face		50-0-50		25-0-25	50-0-50		25-0-25
Error limit G_e	µm	1		0.5	1		0.5
Error limit G_{ges}	µm	1.2		0.6	1.2		0.6
Error limit G_t	µm	0.7		0.4	0.7		0.4
Measuring value hysteresis f_u	µm	0.5		0.3	0.5		0.3
Repeatability f_w	µm	0.5		0.3	0.5		0.3
Standard		DIN 879-1		Factory standard	DIN 879-1		Factory standard
Free stroke	mm	2.8					
Measuring force	N	1					
Scale diameter	mm	50					
Dial color		Yellow		White		Yellow	
IP protection category		IP 54				IP 54	

Order no.	Mounting shaft
	mm
4334000	8
4334005	8
4334102	8
4334103	8
4335000	8
4335005	8

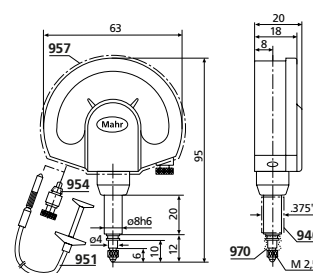

ACCESSORIES

Order no.	Description	Type
4310103	Adapter bushing (.375" / 8 mm)	940
4372000	Cable release (250 mm)	951
4372030	Lifting knob	954
4373030	Splash guard cover	957
4334786	Rubber bellows	970
4375002	Lug back to mount on mounting shank 8h6 mm	963

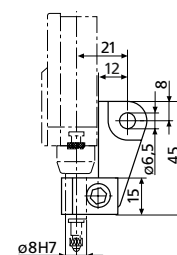

963

Millimess 1004 / 1004 T / 1003 XL / 1003 XLT

Dial comparator



FEATURES

- Large, high contrast dial face
- Adjustable tolerance markers
- Lockable fine adjustment screw
- Shockproof movement
- Mounting shank and measuring spindle are both made of hardened stainless steel
- Measuring spindle is mounted in a high precision ball guide for minimal hysteresis
- Resistant to lateral forces (side play) acting on the measuring spindle
- Maximum sensitivity and accuracy are ensured by the jeweled movement in conjunction with the precision gears and pinions
- Box type protective housing
- Constant measuring force
- Measuring spindle can be retracted with either a screw in cable release or with a lifting knob
- Package contains: case



TECHNICAL DATA

Order no.		4333000	4333005	4334001	4334006
Type		1004	1004 T	1003 XL	1003 XLT
Measuring range	mm	± 0.13			
Scale graduation value	µm	5		2	
Figure on dial face		130–0–130			
Error limit G_e	µm	3.5		2	
Error limit G_{ges}	µm	4		2.4	
Error limit G_t	µm	3		1.4	
Measuring value hysteresis f_u	µm	1			
Repeatability f_w	µm	1			
Standard		Factory standard			
Free stroke	mm	2.5			
Measuring force	N	1			
Scale diameter	mm	50			
Dial color		White		Yellow	
IP protection category		IP 54		IP 54	

Order no.	Mounting shaft
	mm
4333000	8
4333005	8
4334001	8
4334006	8

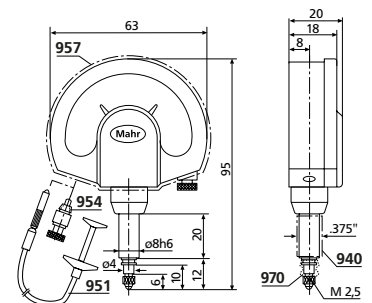

ACCESSORIES

Order no.	Description	Type
4310103	Adapter bushing (.375" / 8 mm)	940
4372000	Cable release (250 mm)	951
4372030	Lifting knob	954
4373030	Splash guard cover	957
4334786	Rubber bellows	970
4375002	Lug back to mount on mounting shank 8h6 mm	963

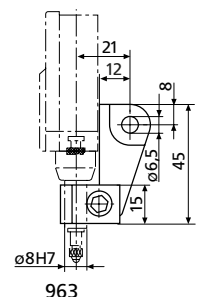

FEATURES

- Large, high contrast dial face
- Adjustable tolerance markers
- Lockable fine adjustment screw
- Shockproof movement
- Mounting shank and measuring spindle are both made of hardened stainless steel
- Measuring spindle is mounted in a high precision ball guide for minimal hysteresis
- Resistant to lateral forces (side play) acting on the measuring spindle
- Maximum sensitivity and accuracy are ensured by the jeweled movement in conjunction with the precision gears and pinions
- Box type protective housing
- Constant measuring force
- Measuring spindle can be retracted with either a screw in cable release or with a lifting knob
- Package contains: case

Applications:

- Models with reduced or increased measuring force
- Lower measuring force is required e.g. for measurements on thin-walled or soft materials or sensitive surfaces
- Increased measuring force is required to e.g. improve the repeatability of extended
- to improve the repeatability of comparative measuring devices



TECHNICAL DATA

Order no.	4334075 4334070 4334050 4334076 4334071 4334010 4334011							
Type	1003							
Measuring range	mm	± 0.05						
Scale graduation value	µm	1						
Figure on dial face	50–0–50							
Error limit G_e	µm	1						
Error limit G_{ges}	µm	1.2						
Error limit G_t	µm	0.7						
Measuring value hysteresis f_u	µm	0.5						
Repeatability f_w	µm	0.5						
Standard	DIN 879-1						Factory standard	
Free stroke	mm	2.8						
Measuring force	N	0.3	0,4	0.5	0.6	0.7	2	3
Scale diameter	mm	50						
Dial color	Yellow							

Order no.	Mounting shaft
	mm
4334075	8
4334070	8
4334050	8
4334076	8
4334071	8
4334010	8
4334011	8

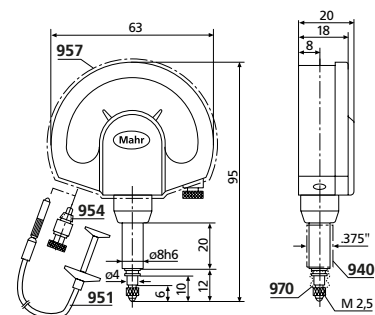

ACCESSORIES

Order no.	Description	Type
4310103	Adapter bushing (.375" / 8 mm)	940
4372000	Cable release (250 mm)	951
4372030	Lifting knob	954
4373030	Splash guard cover	957
4334786	Rubber bellows	970
4375002	Lug back to mount on mounting shank 8h6 mm	963

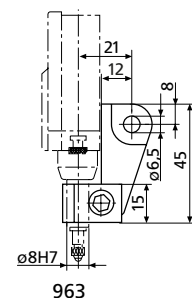

Millimess 1000 A / 1000 B

Dial comparator

FEATURES

- Large, high contrast dial face
- Adjustable tolerance markers
- Lockable fine adjustment screw
- Shockproof movement
- Mounting shank and measuring spindle are both made of hardened stainless steel
- Measuring spindle is mounted in a high precision ball guide for minimal hysteresis
- Resistant to lateral forces (side play) acting on the measuring spindle
- Maximum sensitivity and accuracy are ensured by the jeweled movement in conjunction with the precision gears and pinions
- Box type protective housing
- Constant measuring force
- Measuring spindle can be retracted with either a screw in cable release or with a lifting knob
- **Package contains:** cable release, case

Applications:

- Very clear, reliable and fatigue-free readings due to extra-large display
- Ideal for test stations at which high volume production parts are measured or where the display can only be read from a distance
- For use in a stable measuring table. We recommend: MarStand 824 GT measuring table
- M2.5 thread on end of measuring pin for optional standard anvils



TECHNICAL DATA

Order no.	4338100	4339100
Type	1000 A	1000 B
Measuring range	mm ± 0.12	± 0.05
Scale graduation value	µm	1
Figure on dial face	120–0–120	50–0–50
Error limit G_e	µm	1.5
Error limit G_{ges}	µm	2
Error limit G_t	µm	0.7
Measuring value hysteresis f_u	µm	1
Repeatability f_w	µm	0.5
Standard	Factory standard	
Free stroke	mm	4
Measuring force	N	3.5
Scale diameter	mm	110
Dial color	Yellow	

Order no.	Mounting shaft
	mm
4338100	28
4339100	28

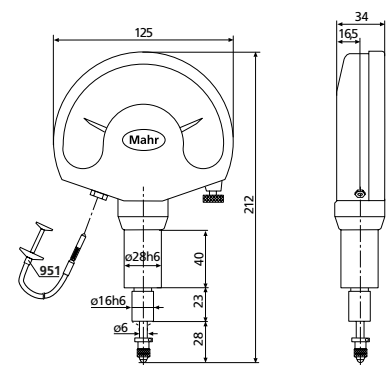

ACCESSORIES

Order no.	Description	Type
4362001	Contact point, steel ball	921
4362002	Contact point, ruby ball	921 R
4372000	Cable release (250 mm)	951
4338008	Rubber bellows for 1000 A/B	

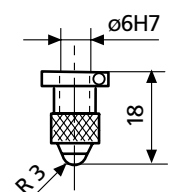

921/921R

Millimar | Electrical and pneumatic length measuring instruments

The requirements for electrical length measuring instruments are just as varied as their applications. Excellent reliability, precision and simple operation are necessary. Millimar measuring instruments fulfill all these requirements. These products are rugged, versatile and attractively priced.



Overview - Millimar product family	214
Millimar C 1200 T / C 1200 M / C 1202 Compact length measuring device	218
Millimar S 1840 M / S 1840 F / S 1840 PE/F Compact length measuring device	220
Millimar C 1750 PC Measuring computer	222
Millimar Cockpit 13 Measuring software	223
Millimar N 1700 modules Evaluating measuring sensors	224
Millimar μDimensionair II® Mobile pneumatic length measuring device	231
Overview - Millimar inductive measuring probes	232
Millimar P2000 series Inductive probes	234
Millimar P1300 series Inductive probes	244
Millimar P 1512 V / P 1530 V Incremental probes	252
Overview - Millimar air gage metrology	253
Millimar DP50 / DP20 / DP60 Air plug gages	255
Millimar DR50 / DR20 2-jet air ring gages	260
Millimar DR50-3 / DR20-3 3-jet air ring gages	261
Millimar AAT-19 / AAT-20 Single jet probe	262
Millimar 6105 N Setting rings	263
Millimar 6107 S Highly accurate setting rings	264
Millimar 6400 Setting plugs	265
Overview - Millimar standard elements	266

Flexible measurement in production

with the new generation of the Millimar family

The components of the Millimar series are optimized to make measuring processes in production as simple and precise as possible. This is achieved primarily through the individual composition of the measuring devices – because every production environment brings with it different focal points, spatial characteristics or measurement-related requirements.

Millimar products are specially developed for these kinds of requirements of modern quality assurance. Here, the focus is primarily on simplifying handling, accelerating processes and, at the same time, integrating fully into complex working environments.

- Flexible and modular product combinations for solving customer-specific measurement tasks
- Different modules for different measurement requirements
- Wide selection of measurement sensors enables the performance of diverse measurement tasks
- Use in a wide range of applications
- Realization of highly dynamic measurements due to extremely high data transmission rate

Millimar | Evaluation units



C 1200



N1700 modules



Cockpit Software

Millimar | Inductive probes



P1300 M



P2004 M

Single measurement with one probe

- Indicating instrument instantly displays the measured value.
- Used for all kinds of direct measurements on cylindrical and flat workpieces.
- Applied in the same way as with digital / dial indicators, digital / dial comparators or test indicators.

Thickness measurement

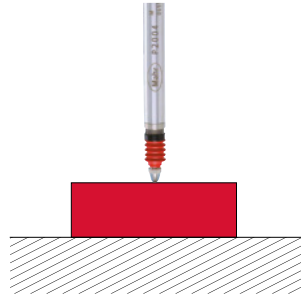

Sum measurement with 2 probes

Indicates the sum of deviation (total composite error) acquired from 2 probes irrespective of the form, support and concentricity deviation.

Thickness measurement

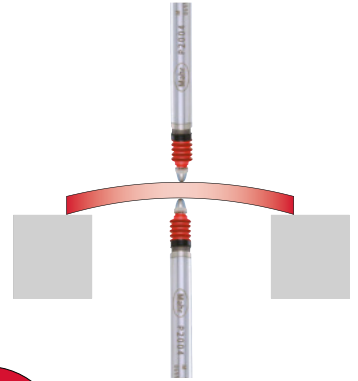

Radial runout

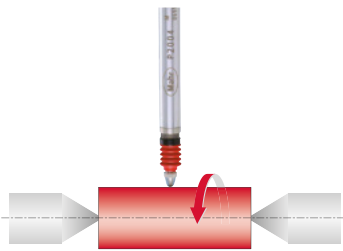

Axial runout

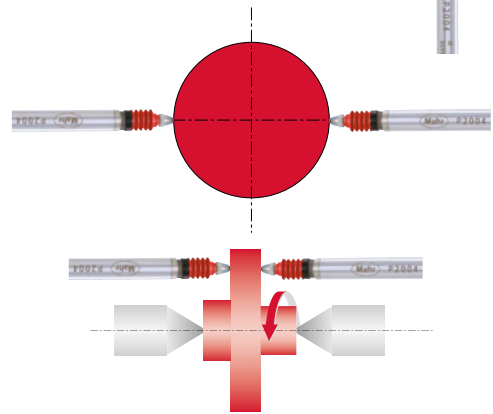
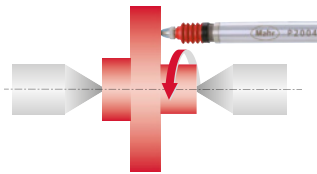

Difference measurement with 2 probes

Shows the difference between the measured values acquired by 2 probes irrespective of the absolute dimension of the test piece. This is particularly suitable for dimensional comparison of two test points.

Form measurement of wedges, cones

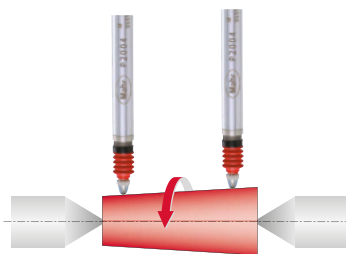

Height difference between 2 steps

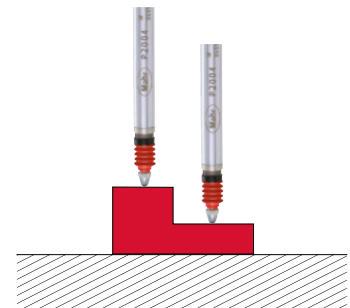

Perpendicularity measurement

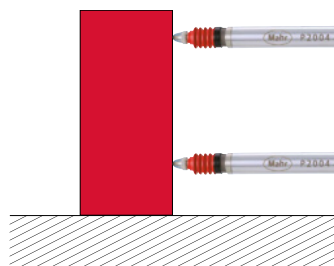

Concentricity measurement on 2 shaft diameters

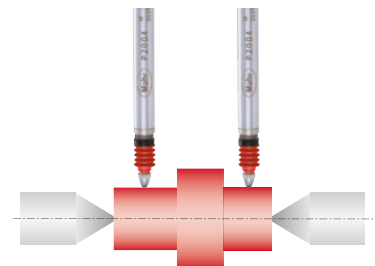

Millimar C 1202

Flexible evaluation and display anywhere

The Millimar C 1202 compact instrument is versatile and suitable for use with a variety of sensors.

The Millimar C 1202 represents the next generation of multichannel compact instruments for length metrology. Due to its sophisticated features such as the tilting easy-to-read display, clear menu navigation and flexible representation of measuring values, it offers maximum ergonomics and user-friendliness. Combine with an easy to change module from the N 1700 series to create just the right measuring instrument for your measuring task. Thanks to its wide range of functions, the Millimar C 1202 is extremely versatile. It can be used to tackle a multitude of measuring tasks, e.g. static and dynamic measurements as well as cone calculations. Moreover, depending on the module, measuring probes by other manufacturers may also be compatible, which will reduce your costs.

Tilting display

Measuring values can be read clearly and effortlessly from all viewing angles. The display also features a backlight.

Sturdy plastic housing

As the Millimar C 1202 is impervious to external influences, it is ideal for use in production.

Interchangeable modules

The Millimar C 1202 can be easily converted to handle different measuring tasks.

Configuring C 1202 Possible combinations with N 1700 modules

N 1702 M/M-HR/T/U



N 1702 VPP



N 1701 PF/PM



End plate included in delivery of Millimar C 1202



1x N 170x module or
2x N 1701 PF/PM



Extension rail,
2x N 1701 PF/PM



C 1202

Millimar C 1202

9

Different N 1700 modules can be combined with Millimar C 1202



Interpret measuring results with ease

The high contrast color display provides a clear presentation of the measuring results.

Large keys

The Millimar C 1202 can also be reliably operated with gloves. Even dirt does not impede its function.



Advantages

- Three features can be displayed at the same time – for even more static and dynamic measuring tasks
- Two independent inputs via N 1700 module for the optional connection of measuring probes and pneumatic transducers
- Interchangeable modules for flexibility and compatibility
- Digimatic and USB ports for easy connection to data collection systems and evaluation software
- Programmable measuring sequences for greater productivity and reliability

Flexible setup options

Users can position the instrument on the table or fix it to the wall.

Millimar C 1200 T / C 1200 M

Compact amplifier



FUNCTIONS

- ON/OFF
- mm/inch
- Reversal of counting direction
- Selectable measuring range
- MAX/MIN memory for searching the reversal point
- MAX-MIN for testing flatness and concentricity
- TOL (enter tolerance limit values)
- PRESET (for entering a numerical value)
- Selectable resolution
- Factor (adjustable)
- DATA (data transmission)
- Menu interlock

FEATURES

- High-resolution, high-contrast color display
- Fully adjustable display for ideal viewing angle
- Extremely easy to operate
- Suitable for power source or battery operation
- Suitable for mobile use with battery operation
- Compact housing
- Suitable for wall mounting
- **Battery type:** 5 x LR6 (1.5V Mignon AA) possible
- **Package contains:** power source, instruction manual
- **Software:** MarCom Professional free download: www.mahr.com/marcom (only for Mahr data cables and wireless systems with USB and RS-232 interface)



Millimar C 1200, now in 2 versions

- M for inductive probes with the compatibility M
- T for inductive probes with the compatibility T



TECHNICAL DATA

Order no.	5312011	5312012
Type	C 1200 T	C 1200 M
Display	TFT color display, 110 mm (4.3"), 480 x 272 pixels	
Range of digital display	μm	± 5000
Range of digital display	inch	± .19"
Range of analog display	μm	± 5000, ± 2000, ± 1000, ± 300, ± 100, ± 30, ± 10, ± 3
Range of analog display	inch	± .19", ± .07", ± .03", ± .01", ± .003", ± .001", ± .0003", ± .0001"
Resolution	μm	0.1
Resolution	inch	.000005"
Scale graduation value	μm	500, 200, 100, 20, 10, 2, 1, 0.2
Scale graduation value	inch	.019", .007", .002", .001", .0002", .0001", .00002", .00001"
Probe inputs	1	
Compatibility	Tesa	Mahr
Measuring combination	+A, -A	
Features	1	
Dynamic functions	Max, Min, Max-Min	
Configuration	Keyboard	
Data transmission rate	Hz	30
Refresh rate	fps	40
Error limit, digital display	0.3% (min. 0.2 μm)	
Error limit, analog display	0.25% of the end scale value / 0.3% of the displayed value	
Data interface	Opto RS-232C, USB, Digimatic, wireless	
Energy supply	Power source, 230 V/115 V; 50/60 Hz, battery operation	
IP protection category	IP 42	

Order no.	Width	Height	Depth
	mm	mm	mm
5312011	130	170	150
5312012	130	170	150

ACCESSORIES

Order no.	Description	Type
4346023	2000 USB data connection cable USB (2 m)	2000 USB
4346021	Interface adapter with data cable Digimatic (2 m)	2000 d
4346020	Data connection cable RS232C (2 m)	2000 r
4102232	2000 e transmitter for e-Stick	2000 e
4102230	e-Stick receiver	e-Stick



Millimar C 1202

Compact amplifier



FUNCTIONS

- mm/inch
- TOL (Tolerance and Warning Limits Input)
- PRESET (for entering a numerical value)
- Mastering 1 and 2 point
- MAX/MIN memory for searching the reversal point
- MAX-MIN for testing flatness and concentricity
- HOLD (storage of measured values)
- Selectable resolution
- Factor (adjustable)
- Reversal of counting direction
- Control input programmable
- Measuring sequence with time control
- DATA (data transmission)
- Menu interlock

FEATURES

- Versatility for a wide range of measuring tasks
- N 1700 modules as measuring channels for inductive and incremental probes or for pneumatic measuring equipment
- High-resolution, high-contrast color display
- Fully adjustable display for ideal viewing angle
- Measurement values can be displayed in three ways: as a number, pointer or bar
- 1 –3 features can be displayed at once
- Extremely easy to operate
- Several measuring tasks can be stored on the memory card
- Compact housing
- Suitable for wall-mounting
- **Package contains:** power source, micro SD memory card, instruction manual, without N 1700 module (necessary optional accessory)
- **Software:** MarCom Professional free download: www.mahr.com/marcom (only for Mahr data cables and wireless systems with USB and RS-232 interface)



Applications:

Indicating instrument for precise length measurements

- For connecting different sensors by way of N1700 measuring modules
- For connecting up to 2 measuring sensors

Please note:

N1700 measuring modules are necessary additional accessories

TECHNICAL DATA

Order no.	5312025	
Type	C 1202	
Display	TFT color display, 110 mm (4.3"), 480 x 272 pixels	
Range of digital display	µm	± 999 999.9
Range of digital display	inch	± 39"
Range of analog display	µm	± 5000, ± 2000, ± 1000, ± 300, ± 100, ± 30, ± 10, ± 3
Range of analog display	inch	± .19", ± .07", ± .03", ± .01", ± .003", ± .001", ± .0004", ± .0001"
Resolution	µm	0.01, 0.1, 1
Resolution	inch	.000005"
Scale graduation value	µm	500, 200, 100, 20, 10, 2, 1, 0.2
Scale graduation value	inch	.019", .007", .002", .001", .0002", .0001", .00002", .00001"
Angle units	degrees, radians	
Measuring combination	+A, -A, +B, -B, A+B, +A-B, -A+B, -A-B	
Features	3	
Dynamic functions	Max, Min, TIR (Max-Min), (Max+Min)/2, Average	
Statistical functions	Length, Angle	
Configuration	Keyboard	
Data transmission rate	Hz	30
Refresh rate	fps	30
Error limit, digital display	0.3% (min. 0.2 µm); 0.3% (min. 0.04 µm)* * (with N 1702 M-HR)	
Error limit, analog display	0.25% of the end scale value / 0.3% of the displayed value	
Data interface	USB	
Control inputs	Control input programmable (functions and function sequences)	
Energy supply	Power source, 230 V/115 V; 50/60 Hz	
IP protection category	IP 42	

ACCESSORIES

Order no.	Description	Type
5331120	Module for inductive probes	N 1702 M
5331125	Module for inductive probes	N 1702 M-HR
5331121	Module for inductive probes	N 1702 T
5331122	Module for inductive probes	N 1702 U
5331161	Module for incremental sensors	N 1702 VPP
5331155	Module for pneumatic gages	N 1701 PF-2500/5000
5331157	Module for pneumatic gages	N 1701 PF-10000
5312950	Extension rail for Millimar C 1202 to fit two N 1701 PF/PM modules	
4102603	Data cable USB bidirectional (2 m)	DK-U1
4102606	Interface adapter with data cable Digimatic (2 m)	DK-D1
4102058	Foot switch to trigger data transmission	16 Esf
2258471	Air filter/precision pressure regulator kit for measuring module N 1701 PF	



Millimar S 1840 M / S 1840 F

Compact column amplifier



FEATURES

- Easy-to-read 3-color analog display
- Measurement in conjunction with inductive probes (e. g. Mahr P2004) or electronic plug gages, etc.
- 2 inputs for inductive probes (compatible with probes from Mahr, Federal)
- Extensive calculation of input signals; $\pm A$, $\pm B$ and all combinations
- Dynamic measurements; Max, Min, Max-Min, Average
- Programmable either via the integrated keypad or the RS-232 interface by means of MS - Windows® configuration software
- Programmable warning and tolerance limits (exceeding the limit causes the color to change from yellow to red)
- Backlit, two-line LCD for displaying measured values, help texts and units of measurement
- 1 analog output
- 3 digital inputs (e.g. measurement start, master measurement)
- 3 digital outputs for good – reject – rework, measuring time
- **Package contains:** instruction manual, power source
- **Software:** MarCom Professional free download: www.mahr.com/marcom (only for Mahr data cables and wireless systems with USB and RS-232 interface)



TECHNICAL DATA

Order no.	5318400		5318402	
Type	S 1840 M		S 1840 F	
Display	101 LED elements, 3 colors			
Range of digital display	μm	$\pm 2000, \pm 10000$		
Range of analog display	μm	$\pm 10, \pm 30, \pm 100, \pm 300, \pm 1000, \pm 3000, \pm 10000$, tolerance related		
Range of analog display	inch	$\pm .0003", \pm .001", \pm .003", \pm .01", \pm .03", \pm .1", \pm .3"$, tolerance related		
Resolution	μm	0.01, 0.1		
Resolution	inch	.000001", .000005"		
Tolerance display	Via color changes in the analog display			
Measuring range, inductive probe	μm	$\pm 200, \pm 2000$		
Probe inputs	2			
Compatibility	Mahr		Federal	
Measuring combination	+A, -A, +B, -B, A+B, +A-B, -A+B, -A-B			
Features	2			
Dynamic functions	Max, Min, Max-Min, (Max+Min)/2, Mean			
Configuration	PC, keyboard			
Data transmission rate	Hz	40		
Error limit, digital display	0.3% (min. 0.2 μm)			
Error limit, analog display	1% (101 LEDs)			
Data interface	RS-232C, wireless			
Control inputs	3 optocoupler inputs, 24 V, 10 mA			
Control outputs	3 optocoupler outputs, 24 V, 100 mA			
Analog output	Max. ± 5 V, sensitivity adjustable		Max. ± 5 V, sensitivity adjustable	
Energy supply	Power source, 230 V/115 V; 50/60 Hz			
IP protection category	IP 42			

Order no.	Width	Height	Depth
	mm	mm	mm
5318400	47	487	144
5318402	47	487	144

ACCESSORIES

Order no.	Description	Type
5330901	Base plate for up to 3 columns	
5318430	Control unit with 3 push buttons	
5330955	Foot switch for input 1	
5330956	Foot switch for input 2	
5330957	Foot switch for input 3	
7032401	25 pin connector, non-wired for I/O port	
7024634	Data connection cable RS232C (3 m)	
4102331	Millimar - USB adapter cable RS-232-USB (0.2 m)	Millimar - USB
4102233	RS-232 e transmitter for e-Stick	RS-232 e
4102230	e-Stick receiver	e-Stick

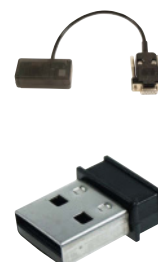

Millimar S 1840 PE/F

Compact column measuring instrument



FEATURES

- Measuring results can be determined and addressed at a glance
- Suitable for measurements with pneumatic measuring equipment
- Offers a wide range of functions for the combined evaluation of signals from static and dynamic measurements
- Measuring results are displayed with 101 three color LEDs if programmable warning and tolerance limits are exceeded, LED segments on display change color accordingly from green to yellow or red
- When using pneumatic compact amplifiers, it is recommended at all times to use both a pressure regulator and a supply filter (see accessories)
- Clear, three color analog light bar display of warning and tolerance limits
- Backlit, two line LCD for displaying measured values, help texts and units of measurement
- 1 channel
- RS-232 interface
- Analog output
- 3 digital inputs for measurement start, master measurement, etc.
- 3 digital outputs for good, reject, rework classification, measuring time, etc.
- **Dynamic measurements:** Max, Min, Max-Min, Max+Min, Average
- Can either be programmed via the integrated membrane keypad using the menu driven interface or via the configuration software for MS Windows®
- 1-point or 2-point master measurement
- Password block in setup mode
- **Package contains:** instruction manual, power source
- **Software:** MarCom Professional free download: www.mahr.com/marcom (only for Mahr data cables and wireless systems with USB and RS-232 interface)



TECHNICAL DATA

Order no.	5318455	5318457
Type	S 1840 PE/F	
Display	101 LED elements, 3 color	
Range of analog display	µm	± 3, ± 10, ± 30, ± 100, ± 300, ± 1000, ± 3000, ± 10000, tolerance related
Range of analog display	inch	± .0001", ± .0003", ± .001", ± .003", ± .01", ± .03", ± .1", ± .3", tolerance related
Resolution	µm	0.1
Resolution	inch	.000005"
Tolerance display	Via color change of the analog display	
Inputs for pneumatic measuring equipment	1	
Compatibility	Federal	
Magnification	2500:1	10000:1
Measuring combination	+A, -A	
Features	1	
Dynamic functions	Max, Min, Max-Min, (Max+Min)/2, Average	
Configuration	PC, keyboard	
Zero setter	Electrical	
Error limit	0.5 –1%	
Error limit, digital display	+/-1 place	
Error limit, analog display	1% (101 LEDs)	
Air supply connection	Ø 8mm	
Air pressure	2.1 bar ± 5%	
Air consumption m³/h	Approx. 1–2 m³	
Data interface	RS-232C, wireless	
Control inputs	3 optocoupler inputs, 24 V, 10 mA	
Control outputs	3 optocoupler outputs, 24 V, 100 mA	
Analog output	1 V/mm	
Energy supply	Power source, 230 V/115 V; 50/60 Hz	
IP protection category	IP 43	

Order no.	Width	Height	Depth
	mm	mm	mm
5318455	47	487	144
5318456	47	487	144
5318457	47	487	144

ACCESSORIES

Order no.	Description	Type
5330914	Base foot with 1 pressure regulator	
5330915	Base foot with 2 pressure regulators	
5330916	Base foot with 3 pressure regulators	
2121236	Supply filter with adapter kit	
5318430	Control unit with 3 push buttons	
5330955	Foot switch for input 1	
5330956	Foot switch for input 2	
5330957	Foot switch for input 3	
7024634	Data connection cable RS232C (3 m)	
4102331	Millimar - USB adapter cable RS-232-USB (0.2 m)	Millimar - USB
4102233	RS-232 e transmitter for e-Stick	RS-232 e
4102230	e-Stick receiver	e-Stick

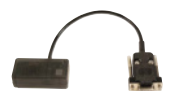

Millimar C 1750 PC

Measuring computer

FEATURES

- Robust 10.1" touch PC with i5 processor
- 8GB memory, industrial 256GB SSD
- IP65 front housing
- Interactive, touch-sensitive software
- Very simple and intuitive to use
- User-friendly creation of measuring tasks
- Access to predefined wizards for maximum ease of use
- Management of measuring tasks (save and load function)
- Measuring task linked to images or drawings
- Static and dynamic recording of measuring values
- Supported by graphical operating elements
- Live visualization of measuring values
- Simultaneous display of 128 digital or analog measurement values
- The Millimar N 1700 modules support a wide range of inductive measuring probes as well as Mahr instruments with a data interface
- Connection of Mahr measuring technologies via Integrated Wireless
- Data export to MS Excel or in qs-Stat format (dfq or dfx/dfd format)
- Password-protected user levels (3 levels)
- Online help (operating instructions) can be accessed directly from the software
- **Battery type:** CR 2032 (3V Lithium)
- **Package contains:** Millimar Cockpit software incl. 10.1" Touch-PC, preinstalled Windows 10 IoT "Value", Mahr license key, Recovery-Stick 16 GB, operating instructions (online help), power source, VESA 100 standard stand



Application:

- Convenient measuring computer with smart and universal software for complex measuring tasks in the manufacturing sector

TECHNICAL DATA

Order no.	5312870		
Type	C 1750 PC		
Display	Vertical bar graph, horizontal bar graph, analog display or circular scale, digital display, any combination of display types can be chosen for each feature		
Range of analog display	µm	± 10000, ± 5000, ± 2000, ± 1000, ± 500, ± 200, ± 100, ± 50, ± 20, ± 10, tolerance related	
Range of analog display	inch	± .5", ± .2", ± .1", ± .05", ± .02", ± .01", ± .005", ± .002", ± .001", ± .0005", tolerance related	
Resolution	µm	0.01	
Resolution	inch	.000001"	
Tolerance display	Upper and lower tolerance limit (per feature) Upper and lower warning limit (per feature)		
Measuring range	mm	Dependent on measuring instrument	
Angle units	Degrees, radians		
Compatibility	USB, Integrated Wireless, Millimar N 1700		
Measuring combination	Predefined formula templates for standard features Links entered via comprehensive formula editor		
Features	128		
Dynamic functions	Max, Min, Max-Min, Max+Min		
Classification	Max. 20 classes		
Control inputs	Via N 1704 I/O		
Control outputs	Via N 1704 I/O		
Energy supply	100–240V ACDC active switching; 12V DC-Out		
IP protection category	IP 65 (front panel)		

Order no.	Width	Height	Depth
5312870	mm 278	mm 203	mm 49

ACCESSORIES

Order no.	Description	Type
5312802	Software option: measure history	
5331130	USB connecting module	N 1701 USB
5331120	Module for inductive probes	N 1702 M
5331125	Module for inductive probes	N 1702 M-HR
5331140	Module for inductive probes	N 1704 M
5331121	Module for inductive probes	N 1702 T
5331141	Module for inductive probes	N 1704 T
5331122	Module for inductive probes	N 1702 U
5331142	Module for inductive probes	N 1704 U
5331155	Module for pneumatic gages	N 1701 PF–2500/5000
5331133	Power supply module	N 1701 PS
5331134	I/O module	N 1704 I/O
4102220	Receiver for instruments with Integrated Wireless	i-Stick
4102357	16 EXu data connection cable USB (2 m)	16 EXu
4346023	2000 USB data connection cable USB (2 m)	2000 USB
4102331	Millimar - USB adapter cable RS–232-USB (0.2 m)	Millimar - USB



Millimar Cockpit 13

Measuring software

FEATURES

- Interactive, touch-enabled software
- Easy and intuitive operation
- User-friendly creation of measurement tasks
- Easiest operation through access to predefined formula templates
- Management of measurement tasks (storage and loading function)
- Linking the measurement task with images or drawings
- Static and dynamic measurement value acquisition
- Supported by graphical control elements
- Live visualization of measured values
- Digit and scale displays of up to 128 features simultaneously
- Connection of Millimar N 1700 modules in conjunction with inductive probes as well as Mahr measuring instruments with data interface
- Connection of Mahr measuring instruments with Integrated Wireless
- Data paging in MS-Excel or as qs-Stat data format (dfq or dfx resp. dfd format)
- Password-protected operator levels (3 levels)
- Online help (operating instructions) directly accessible from the software
- **Package contains:** Mahr license key, installation disk, operating instructions (online help)



Application:

- Smart and universally applicable software for complex measurement tasks in the manufacturing sector

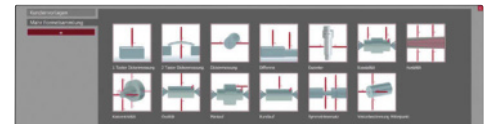

TECHNICAL DATA

Order no.	5312865		
Type	Cockpit 13		
Display	Vertical bar display Horizontal bar display Analog display or round scale		
Range of analog display	μm	$\pm 10000, \pm 5000, \pm 2000, \pm 1000, \pm 500, \pm 200, \pm 100, \pm 50, \pm 20, \pm 10$, tolerance related	
Range of analog display	inch	$\pm .5", \pm .2", \pm .1", \pm .05", \pm .02", \pm .01", \pm .005", \pm .002", \pm .001", \pm .0005"$, tolerance related	
Resolution	μm	0.01	
Resolution	inch	.0000001"	
Tolerance display	Upper and lower tolerance limit (per characteristic) Upper and lower warning limit (per characteristic)		
Measuring range	mm	Depending on the measuring device	
Compatibility	USB, Integrated Wireless, Millimar N 1700		
Measuring combination	Predefined formula templates for standard characteristics Input of links via extensive formula editor		
Features	128		
Classification	Max. 20 classes		
Control inputs	Via N 1704 I/O module (5331134)		
Control outputs	Via N 1704 I/O module (5331134)		

ACCESSORIES

Order no.	Description	Type
5312802	Software option: measure history	
5331130	USB connecting module	N 1701 USB
5331120	Module for inductive probes	N 1702 M
5331125	Module for inductive probes	N 1702 M-HR
5331140	Module for inductive probes	N 1704 M
5331121	Module for inductive probes	N 1702 T
5331141	Module for inductive probes	N 1704 T
5331122	Module for inductive probes	N 1702 U
5331142	Module for inductive probes	N 1704 U
5331155	Module for pneumatic gages	N 1701 PF-2500/5000
5331133	Power supply module	N 1701 PS
5331134	I/O module	N 1704 I/O
4102220	Receiver for instruments with Integrated Wireless	i-Stick
4102357	16 EXu data connection cable USB (2 m)	16 EXu
4346023	2000 USB data connection cable USB (2 m)	2000 USB
4102331	Millimar - USB adapter cable RS-232-USB (0.2 m)	Millimar - USB



Millimar N 1702 M / N 1702 T / N 1702 U / N 1702 M-HR / N 1704 M / N 1704 T / N 1704 U

Module for inductive probes

FEATURES

- Flexibly configurable RS-485 bus modules
- Powerful connection modules for evaluating measuring sensors (inductive/pneumatic)
- Synchronous data retrieval from multiple connected measuring probes
- Ability to connect the N 1700 modules to the smart and universally applicable Millimar Cockpit Software
- Connects all compatible probe types using one module
- Flexible and modular product combinations to tackle customer-specific measuring tasks
- Maximum theoretical bus data rate of 4189 values/s (depending on the number of connected channels)
- Package contains: instruction manual



Application:

- Smart and flexible combination of measuring modules and software for solving customer-specific measuring tasks.



TECHNICAL DATA

Order no.	5331120	5331121	5331122	5331125	5331140	5331141	5331142	
Type	N 1702 M	N 1702 T	N 1702 U	N 1702 M-HR	N 1704 M	N 1704 T	N 1704 U	
Resolution	0.1		0.01		0.1			
Measuring range, inductive probe	± 5000, ± 2000, ± 1000, ± 500		± 200		± 5000, ± 2000, ± 1000, ± 500			
Probe inputs	2			4				
Compatibility	Mahr, Mahr 1340, Mahr half-bridge, Mahr LVDT, Mahr VLDT	Tesa	Marposs	Mahr, Mahr 1340, Mahr half-bridge, Mahr LVDT, Mahr VLDT	Mahr, Mahr half-bridge, Mahr LVDT, Mahr VLDT	Tesa	Marposs	
Configuration	Millimar Cockpit Software							
Data transmission rate	Hz		4189					
Error limit	0.3 % (min. 0.2 µm)			0.3 % (min. 0.04 µm)		0.3 % (min. 0.2 µm)		
Data interface	RS-485							
Current consumption	mA		115	95	115	180	150	180
Energy supply	+ 5V from N 1700 Bus							
IP protection category	IP 42							

Order no.	Width	Height	Depth
	mm	mm	mm
5331120	77	54.8	66
5331121	77	54.8	66
5331122	77	54.8	66
5331125	77	54.8	66
5331140	116.5	54.8	66
5331141	116.5	54.8	66
5331142	116.5	54.8	66

Millimar N 1702 M / N 1702 T / N 1702 U / N 1702 M-HR / N 1704 M / N 1704 T / N 1704 U

Module for inductive probes

ACCESSORIES

Order no.	Description	Type
5313010	Inductive probe, ± 1 mm	1301
5313030	Inductive probe, ± 1 mm	1303
5313049	Inductive probe, ± 1 mm	1304 K
5313180	Inductive probe, $-0.3 \dots 1$ mm	1318
5313400	Inductive probe, ± 2 mm	1340
4400180	Inductive probe, ± 2 mm	P1300 MA
4400182	Inductive probe, ± 2 mm	P1300 MA without cable
4400181	Inductive probe, ± 2 mm	P1300 MB
4400183	Inductive probe, ± 2 mm	P1300 MB without cable
5323040	Inductive probe, ± 0.5 mm	P2001 M
5323010	Inductive probe, ± 2 mm	P2004 M
5323020	Inductive probe, ± 2 mm	P2004 MA
5323030	Inductive probe, ± 2 mm	P2004 MB
5324010	Inductive probe, ± 5 mm	P2010 M
5324020	Inductive probe, ± 5 mm	P2010 MA
5324030	Inductive probe, ± 5 mm	P2010 MB
5324070	Inductive probe, ± 2 mm	P2104 MA
5324080	Inductive probe, ± 2 mm	P2104 MB
4400190	Inductive probe, ± 2 mm	P1300 TA
4400191	Inductive probe, ± 2 mm	P1300 TB
5323011	Inductive probe, ± 2 mm	P2004 T
5323021	Inductive probe, ± 2 mm	P2004 TA
5323031	Inductive probe, ± 2 mm	P2004 TB
5324021	Inductive probe, ± 5 mm	P2010 TA
5324031	Inductive probe, ± 5 mm	P2010 TB
5324071	Inductive probe, ± 2 mm	P2104 TA
5324081	Inductive probe, ± 2 mm	P2104 TB
5323013	Inductive probe, ± 2 mm	P2004 U
5323023	Inductive probe, ± 2 mm	P2004 UA
5323033	Inductive probe, ± 2 mm	P2004 UB
5324023	Inductive probe, ± 5 mm	P2010 UA
5324033	Inductive probe, ± 5 mm	P2010 UB
5324073	Inductive probe, ± 2 mm	P2104 UA
5324083	Inductive probe, ± 2 mm	P2104 UB
4400192	Inductive probe, ± 2 mm	P1300 TA without cable
4400193	Inductive probe, ± 2 mm	P1300 TB without cable



Millimar N 1702 VPP

Module for incremental sensors

FEATURES

- Flexibly combinable RS-485 bus modules
- Powerful connection modules for evaluating incremental measuring sensors or encoders
- Reference point evaluation
- Synchronous data retrieval from multiple connected measuring probes
- Can be used as a measuring module on the Millimar C 1202 as of firmware version 1.1.0.0
- Ability to connect the N 1700 modules to the smart and universally applicable Millimar Cockpit Software
- Connects all compatible measuring probe types using one module
- Flexible and modular product combinations to tackle customer-specific measuring tasks
- Maximum theoretical bus data rate of 4189 values/s (depending on the number of connected channels)
- **Package contains:** instruction manual



Application:

- Smart and flexible combination of measuring modules and software for solving customer-specific measuring tasks.

TECHNICAL DATA

Order no.	5331161	
Type	N 1702 VPP	
Resolution	μm	0.01, 0.1
Measuring range	mm	30 bit counter Dependent on the signal period of the sensor and set interpolation Adjustable interpolation factors 256, 128, 64 or 32
Probe inputs	2	
Compatibility	Incremental 1 Vss	
Configuration	Millimar C 1202	
Data transmission rate	Hz	4189
Data interface	RS-485	
Current consumption	mA	350
Energy supply	+ 5V from N 1700 Bus	
IP protection category	IP 42	

Order no.	Width	Height	Depth
	mm	mm	mm
5331161	77	53	66

ACCESSORIES

Order no.	Description	Type
5315081	Incremental measuring probe P 1512 V	P 1512 V
5315311	Incremental measuring probe P 1530 V	P 1530 V

Millimar N 1701 PM-2500 / N 1701 PM-5000 / N 1701 PM-10000 / N 1701 PF-2500/5000 / N 1701 PF-2500/5000-4 / N 1701 PF-10000

Module for pneumatic gages

FEATURES

- Flexibly configurable RS-485 bus modules
- Powerful connection modules for evaluating measuring sensors (inductive/pneumatic)
- Synchronous data retrieval from multiple connected measuring sensors
- Ability to connect the N 1700 modules to the smart and universally applicable Millimar Cockpit Software
- Flexible and modular product combinations to tackle customer-specific measuring tasks
- Maximum theoretical bus data rate of 4189 values/s (depending on the number of connected channels)
- **Package contains:** instruction manual



Application:

- Smart and flexible combination of measuring modules and software for solving customer-specific measuring tasks.

TECHNICAL DATA

Order no.	5331150	5331151	5331152	5331155	5331156	5331157
Type	N 1701 PM-2500	N 1701 PM-5000	N 1701 PM-10000	N 1701 PF-2500/5000	N 1701 PF-2500/5000-4	N 1701 PF-10000
Resolution	0.1					
Resolution	.000005"					
Measuring span	100	50	25			
Measuring range	± 50 µm (±0.00196 inch)	± 25 µm (±0.00098 inch)	± 12.5 µm (±0.00049 inch)	± 40 µm (±0.0015 inch) / ± 20 µm (±0.00075 inch), tooling dependent		± 8 µm (±0.0003 inch)
Inputs for pneumatic measuring equipment	1					
Compatibility	Mahr			Mahr-Federal		
Measuring principle	Differential pressure					
Magnification	2500:1	5000:1	10000:1	2500:1, 5000:1		10000:1
Configuration	Millimar Cockpit Software					
Zero setter	Electrical					
Data transmission rate	4189 Hz					
Error limit	± 0.8 µm in the range ± 38 µm and ± 0.5 µm in the range ± 25 µm					
Number of jets	2		1-3		4	1-3
Air supply connection				3/8-32 Male		9/32-40 Male
Compressed air setting duration	≤ 0.3 seconds (with 1m / 3.3 ft hose) ≤ 0.5 seconds (with 2 m / 6.6 ft hose)		≤ 0.5 seconds (with 1m / 3.3 ft hose) ≤ 0.7 seconds (with 2 m / 6.6 ft hose)		≤ 0.3 seconds (with 1m / 3.3 ft hose) ≤ 0.5 seconds (with 2 m / 6.6 ft hose)	
Air pressure	2.0 bar / 29 psi ± 5 %			2.1 bar / 30.4 psi ± 5 %		
Air consumption	1-2					
Data interface	RS-485					
Current consumption	32 mA					
Energy supply	+ 5V from N 1700 Bus					

Order no.	Width	Height	Depth
	mm	mm	mm
5331150	90	50	66
5331151	90	50	66
5331152	90	50	66
5331155	90	50	66
5331156	90	50	66
5331157	90	50	66

ACCESSORIES

Order no.	Description
2258476	Air filter/precision pressure regulator kit for measuring module N 1701 PM
2258471	Air filter/precision pressure regulator kit for measuring module N 1701 PF

Millimar N 1704 I/O

I/O module

FEATURES

- Flexible combination of RS485 bus modules
- Capable modules for the evaluation of measuring sensors
- Synchronous data enquiry of multiple connected sensors
- Ability to connect the N 1700 modules to the smart and universally applicable Millimar Cockpit Software
- Connection of all types of measuring sensors within the same compatibility
- Modular and customizable selection of product combinations for solving each customer specific measuring tasks
- Theoretical bus data rate of max. 4189 values per second (depending on the number of connected channels)
- **Package contains:** plug connectors, instruction manual



Application:

- Smart and flexible combination of measuring modules and software for solving customer-specific measuring tasks.

TECHNICAL DATA

Order no.	5331134		
Type	N 1704 I/O		
Configuration	Millimar Cockpit Software		
Data interface	RS-485		
Current consumption	mA	70	
Control inputs	4 inputs, 10 –30 V		
Control outputs	4 outputs, 10 –30 V ESD protected, short-circuit proof		

Order no.	Width	Height	Depth
	mm	mm	mm
5331134	77	54	66

ACCESSORIES

Order no.	Description	Type
5331139	Extension cable, length 1 m	N 1700 RS485

Millimar N 1701 USB

USB connecting module

FEATURES

- Flexible combination of RS-485-bus-modules
- Capable modules for the evaluation of measuring sensors
- Synchronous data enquiry of multiple connected sensors
- Ability to connect the N 1700 modules to the smart and universally applicable Millimar Cockpit Software
- Connection of all types of measuring sensors within the same compatibility
- Modular and customizable selection of product combinations for solving each customer specific measuring tasks
- Theoretical bus data rate of max. 4189 values per second (depending on the number of connected channels)
- **Package contains:** end module, instruction manual, USB cable

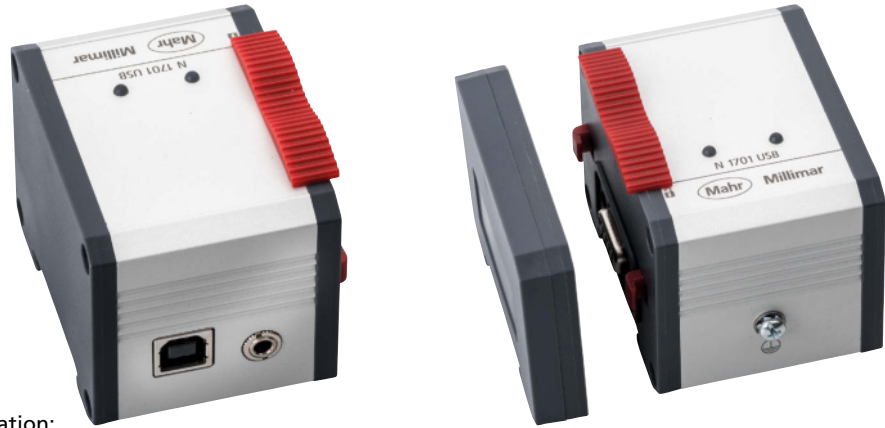

Application:

- Smart and flexible combination of measuring modules and software for solving customer-specific measuring tasks.

TECHNICAL DATA

Order no.	5331130		
Type	N 1701 USB		
Configuration	Millimar Cockpit Software		
Data interface	USB, RS-485		
Current supply	mA	430	

Order no.	Width	Height	Depth
	mm	mm	mm
5331130	54	54	66

ACCESSORIES

Order no.	Description	Type
4102058	Foot switch to trigger data transmission	16 ESf
5331139	Extension cable, length 1 m	N 1700 RS485

Millimar N 1701 PS

Power supply module

FEATURES

- Flexible combination of RS485 bus modules
- Capable modules for the evaluation of measuring sensors
- Synchronous data enquiry of multiple connected sensors
- Ability to connect the N 1700 modules to the smart and universally applicable Millimar Cockpit Software
- Connection of all types of measuring sensors within the same compatibility
- Modular and customizable selection of product combinations for solving each customer specific measuring tasks
- Theoretical bus data rate of max. 4189 values per second (depending on the number of connected channels)
- **Package contains:** power source, instruction manual



Application:

- Smart and flexible combination of measuring modules and software for solving customer-specific measuring tasks.

TECHNICAL DATA

Order no.	5331133		
Type	N 1701 PS		
Configuration	Millimar Cockpit Software		
Data interface	RS-485		
Current supply	mA	2000	
Energy supply	230 V/115 V; 50/60 Hz		

Order no.	Width	Height	Depth
	mm	mm	mm
5331133	57	55	66

ACCESSORIES

Order no.	Description	Type
5331139	Extension cable, length 1 m	N 1700 RS485

Millimar μ Dimensionair® II

Mobile pneumatic length measuring instrument



FEATURES

- Value for money
- Versatile
- Innovative
- Robust
- Can be used as a handheld device, a stationary table-top device or even directly on the machine tool
- 54 protection rating - suitable for use in harsh workshop environments
- The compressed air flowing out of the measuring equipment removes any contaminations from the testpiece to ensure reliable measuring results
- Directly and clearly readable measuring results
- With its fixed ratio and controlled compressed air supply, this sturdy, reliable measuring instrument is ideal for use manufacturing environments

The μ Dimensionair II offers:

- Choice of setup with one standard or with Min/Max standards
- All other functions of the μ Max μ II digital dial comparator:
 - Dynamic measurement: Min, Max, measuring span
 - Multiplication factor and hold function ("freeze")
 - Choice of data transfer with serial number
- MarConnect data output: USB, Opto RS-232C, and Digimatic
- Versatility
- Interchangeable handle can be mounted on the base of the instrument (pistol grip) or as a regular bar handle flush with the measuring attachment, allowing the measuring equipment to be used on the workpiece in any situation
- If large, heavy measuring attachments are used, the handle can be mounted between the measuring attachment and the display (dumbbell grip), to provide a balanced, ergonomic measuring system
- Can be operated in a static position on a workbench using the optional measuring stand
- **Package contains:** instruction manual, supply hose AHO-2
- **Software:** MarCom Professional free download: www.mahr.com/marcom (only for Mahr data cables and wireless systems with USB and RS-232 interface)

Application:

- Applications with pneumatic measuring equipment requiring mobile measurement and evaluation.



TECHNICAL DATA

Order no.	2103200	
Type	μ Dimensionair II	
Display	Analog display with one line digital display	
Digital display	Rotates through 270°	
Scale graduation value	μ m	0.5, 1, 2
Scale graduation value	inch	.00002", .00005", .0001"
Tolerance display	Two - over / under (3 class)	
Measuring range	mm	± 0.020 mm, ± 0.040 mm, ± 0.080 mm
Inputs for pneumatic measuring equipment	1	
Compatibility	Federal	
Magnification	5000:1, 2500:1, 1260:1	
Features	1	
Dynamic functions	MAX, MIN, MAX-MIN	
Statistical functions	Difference, Nominal Average	
Error limit	$\pm 1\%$ of the total range	
Compressed air setting duration	Approximately 1 s	
Air pressure	2.10 \pm .01 bar	
Repeatability [μ m]	± 1 numerical increment	
Data interface	Digimatic, Opto RS-232C, USB, wireless	
Energy supply	Battery operation, approximately 3000 h	
IP protection category	IP 54	

Order no.	Width	Height	Length	Depth
	mm	mm	mm	mm
2103200	70	3	100	60

ACCESSORIES

Order no.	Description	Type
2238020	Pressure regulator with filter	
2095924	Pressure meter	
2239307	Universal bench mount	
2237666	Standard plastic handle	
2240993	Shut off slide valve	
2241109	Table stand for μ Dimensionair	
2240594	Swivel coupling adapter for rotating tooling	
2201994	Oil and water separator trap	AFL-24
2237713	Connecting hose, 6 m	
2202076	Supply hose, 1.5 m	AHO-2
4102520	Battery 3 V, CR 2032	
4346023	2000 USB data connection cable USB (2 m)	2000 USB
4346021	Interface adapter with data cable Digimatic (2 m)	2000 d
4346020	Data connection cable RS232C (2 m)	2000 r



Millimar | Electrical length measuring instruments inductive probe program

Millimar – P2000 Series

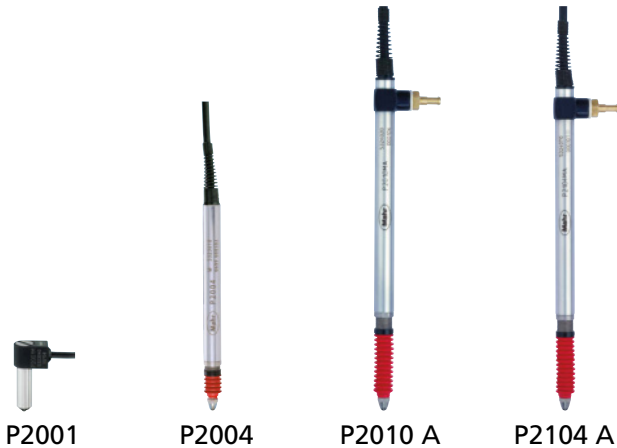

- Available in all prominent compatibilities (available in various type compatibilities)
- Wide product spectrum measuring ranges from 1 to 10 mm plus models with a compressed air (pneumatic) lifter or vacuum retraction
- With rotary stroke bearings (except P2001)
- High linearity over the total measuring range
- Excellent electromagnetic shielding (EMC)
- All probes (except P2001) can be easily converted from axial to radial by mounting a slip-on cap (included)

Millimar – P1300 Series (Mahr half-bridge)

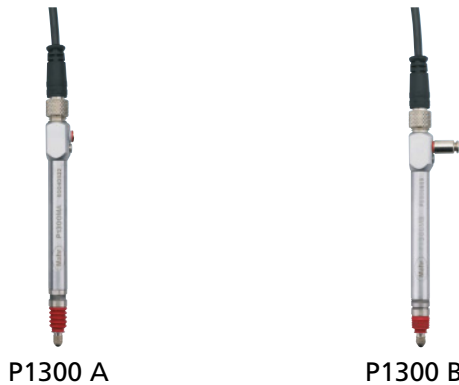

- Available in Mahr and Tesa compatibilities
- Well-proven and established Mahr half-bridge technology
- Easy to service: cable and probe can be separated via the plug-in connector
- Simple to change to pneumatic lifting
- Measuring spindle runs in rotary stroke bearings

Millimar – 1301 / 1303 / 1304 K / 1318 (Mahr-LVDT)



- Extremely robust in all operating conditions; measuring system is offset to guide and mounting shank
- Excellent clamping characteristics
- Measuring spindle runs in rotary stroke bearings (except 1318)
- Measuring spindle can be lifted with a cable release (1301/1303)

Millimar – 1340 Mahr high precision probe



- Can be used with Millimar C 1202 + N 1702 M-HR compact length gage
- Probe protected against dirt and moisture, therefore use in production-related areas possible
- Unprecedented measuring accuracy and minimum linearity error < 0.01 %, i.e. 0.4 µm over the total measuring range

General technical data of inductive probes

The measuring principle of inductive probes is based on the change of position of the magnet's conductive core moving within a coil system. Generally, this is distinguished between a half-bridge and LVDT's.

The Mahr P2000 series of probes applies a high linear, patented VLDT transducer which is similar to an LVDT transducer. This also operates according to a differential transformer principle.

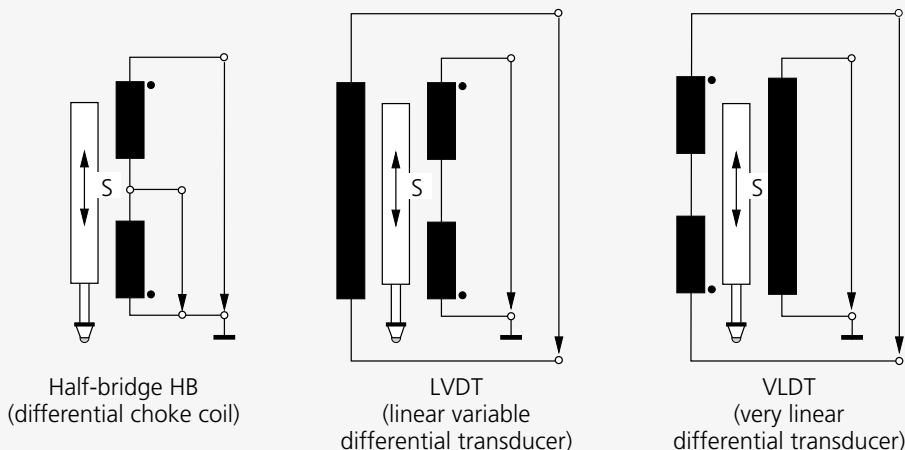

Electrical specification of various compatibilities

	Type	Mahr	Tesa	Marposs	Mahr-Federal
Carrier frequency	KHz	19.4	13	7.5	5
Sensitivity	P2001 P2004 P2104	192	73.75	115	78.74
	P1300	192	73.75	—	—
	1301 1303 1304 K 1318	192	—	—	—
	P2010	19.2	29.5	11.5	7.874
	Amplitude	V_{eff}	5	3	3.5

Schematic drawings of Mahr input amplifiers according to the various compatibilities

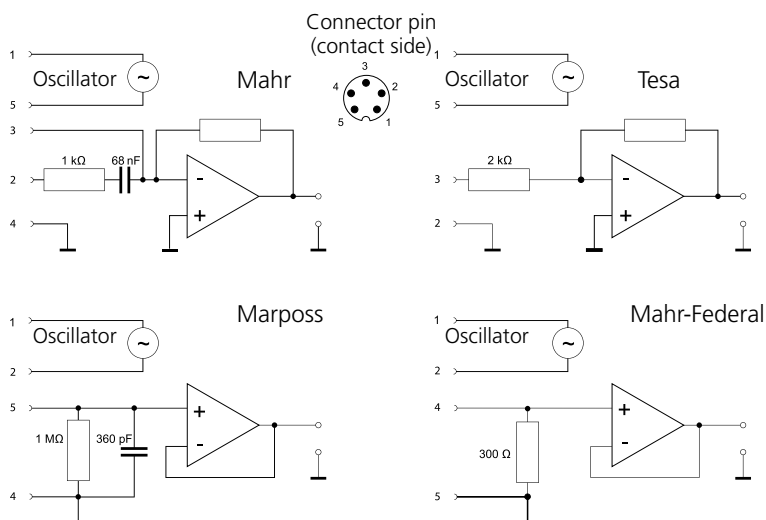

FEATURES

- Compact design
- Plain bearing guide
- High linearity over the entire measuring range
- Excellent electromagnetic shielding (EMC)
- Chemical resistance data:
 - Resistant to oil, gasoline, water and aliphatic compounds
 - Moderately resistant to acids, bases, solvents and ozone

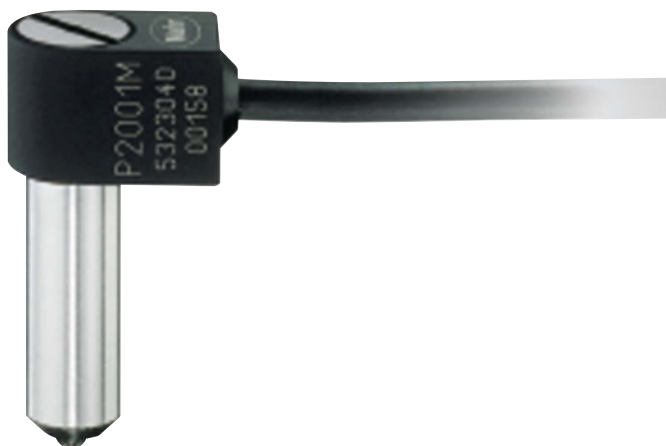

TECHNICAL DATA

Order no.		5323040
Type		P2001 M
Measuring range	mm	± 0.5
Measuring range	inch	± .020"
Measuring force	N	0.75 N +/-0.15 N
Increase in measuring force	N/mm	0.1 N/mm
Sensitivity deviation	%	0.3
Repeatability f_w	μm	0.15
Measuring value hysteresis f_u	μm	0.2
Linearity deviation within +/-0.1 mm	μm	0.6
Linearity deviation within +/-0.0039"	inch	24 μm
Linearity deviation within +/-0.5 mm	μm	1.5
Linearity deviation within +/-0.020"	inch	60 μm
IP protection category		IP 40
Cable length	m	2.5
Temperature coefficient	$\mu\text{m}/^\circ\text{C}$	0.15
Compatibility		Mahr VLDT

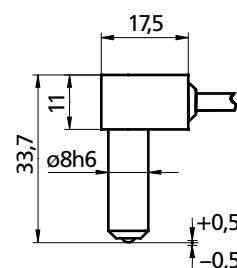

ACCESSORIES

Order no.	Description	Type
5323130	Extension cable 2.5 m (Mahr VLDT)	C2025 M
5323140	Extension cable 5 m (Mahr VLDT)	C2050 M
5323150	Extension cable 7.5 m (Mahr VLDT)	C2075 M
5323160	Extension cable 10 m (Mahr VLDT)	C2100 M

Inductive probe

FEATURES

- Models with or without pneumatic lifter or load
- Measuring pin mounted in rotary stroke bearing
- High linearity over the entire measuring range
- Excellent electromagnetic shielding (EMC)
- All probes can be easily converted from axial to radial by mounting a slip on cap (included)
- Chemical resistance data:
 - Resistant to oil, gasoline, water and aliphatic compounds
 - Moderately resistant to acids, bases, solvents and ozone
- **Package contains:** instruction manual, cap for radial cable output, spanner for preliminary stroke setting



TECHNICAL DATA

Order no.		5323010	5323011	5323013
Type		P2004 M	P2004 T	P2004 U
Measuring range	mm	± 2		
Measuring range	inch	± .079"		
Distance to upper stop	mm...mm	+2.2 ... 4.4		
Distance to lower stop	mm...mm	-2.2 ... 0		
Distance to upper stop	inch...inch	+ .09173"		
Distance to lower stop	inch...inch	-.09 ... 0"		
Lifter / retraction		Standard model		
Measuring force	N	0.75 N +/-0.15 N		
Increase in measuring force	N/mm	0.2 N/mm		
Sensitivity deviation	%	0.3		
Repeatability f_w	μm	0.1		
Measuring value hysteresis f_u	μm	0.5		
Linearity deviation within +/-0.5 mm	μm	0.4		
Linearity deviation within +/- .020"	inch	16 μm		
Linearity deviation within +/-1.0 mm	μm	1.5		
Linearity deviation within +/- .039"	inch	60 μm		
Linearity deviation within +/-2.0 mm	μm	3		
Linearity deviation within +/- .079"	inch	120 μm		
IP protection category		IP 64		
Cable length	m	2.5		
Temperature coefficient	$\mu\text{m}/^\circ\text{C}$	0.15		
Compatibility		Mahr VLDT	Tesa	Marposs

Order no.	a	b	c	d	e	f	f	h	Connection thread
5323010	mm	mm	mm	mm	mm	inch	mm	mm	M 2.5
5323011	88.7	28	21.3	6	9.2	0.315	8	14	M 2.5
5323013	88.7	28	21.3	6	9.2	0.315	8	14	M 2.5

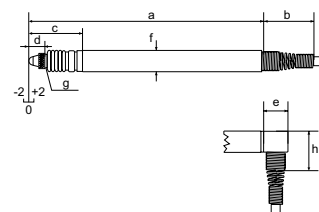

Inductive probe

FEATURES

- Models with or without pneumatic lifter or load
- Measuring pin mounted in rotary stroke bearing
- High linearity over the entire measuring range
- Excellent electromagnetic shielding (EMC)
- All probes can be easily converted from axial to radial by mounting a slip on cap (included)
- Chemical resistance data:
 - Resistant to oil, gasoline, water and aliphatic compounds
 - Moderately resistant to acids, bases, solvents and ozone
- **Package contains:** instruction manual, cap for radial cable output, spanner for preliminary stroke setting



TECHNICAL DATA

	Order no.	5323020	5323021	5323023
Type		P2004 MA	P2004 TA	P2004 UA
Measuring range	mm		± 2	
Measuring range	inch		± .079"	
Distance to upper stop	mm...mm		+2.2 ... 4.4	
Distance to lower stop	mm...mm		-2.2 ... 0	
Distance to upper stop	inch...inch		+ .09173"	
Distance to lower stop	inch...inch		-.09 ... 0"	
Lifter / retraction			Vacuum lifter	
Measuring force	N		0.75 N +/-0.15 N	
Increase in measuring force	N/mm		0.2 N/mm	
Sensitivity deviation	%		0.3	
Repeatability f_w	μm		0.1	
Measuring value hysteresis f_u	μm		0.5	
Linearity deviation within +/-0.5 mm	μm		0.4	
Linearity deviation within +/- .020"	inch		16 μm	
Linearity deviation within +/-1.0 mm	μm		1.5	
Linearity deviation within +/- .039"	inch		60 μm	
Linearity deviation within +/-2.0 mm	μm		3	
Linearity deviation within +/- .079"	inch		120 μm	
IP protection category			IP 64	
Cable length	m		2.5	
Temperature coefficient	$\mu\text{m}/^\circ\text{C}$		0.15	
Compatibility		Mahr VLDT	Tesa	Marposs

Order no.	a	b	c	d	e	f	h	i	j	k	l	m	Connection thread
5323020	mm	mm	mm	mm	mm	mm	mm	mm	mm	mm	mm	mm	M 2.5
5323021	88.7	28	21.3	6	9.2	8	14	26.5	3.6	9	8.3	12.5	M 2.5
5323023	88.7	28	21.3	6	9.2	8	14	26.5	3.6	9	8.3	12.5	M 2.5

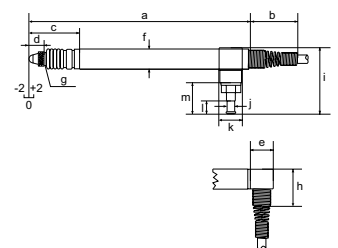

Inductive probe

FEATURES

- Models with or without pneumatic lifter or load
- Measuring pin mounted in rotary stroke bearing
- High linearity over the entire measuring range
- Excellent electromagnetic shielding (EMC)
- All probes can be easily converted from axial to radial by mounting a slip on cap, (included)
- Chemical resistance data:
 - Resistant to oil, gasoline, water and aliphatic compounds
 - Moderately resistant to acids, bases, solvents and ozone
- **Package contains:** instruction manual, cap for radial cable output, spanner for preliminary stroke setting



TECHNICAL DATA

Order no.	5323030	5323031	5323033
Type	P2004 MB	P2004 TB	P2004 UB
Measuring range	mm	± 2	
Measuring range	inch	± .079"	
Distance to upper stop	mm...mm	+2.2 ... 4.4	
Distance to lower stop	mm...mm	-2.2 ... 0	
Distance to upper stop	inch...inch	+.09173"	
Distance to lower stop	inch...inch	-.09 ... 0"	
Lifter / retraction		Compressed air retraction (max. 1 bar)	
Measuring force	N	Depending upon air pressure	
Sensitivity deviation	%	0.3	
Repeatability f_w	μm	0.1	
Measuring value hysteresis f_u	μm	0.5	
Linearity deviation within ± 0.5 mm	μm	0.4	
Linearity deviation within $\pm .020$ "	inch	16 μm	
Linearity deviation within ± 1.0 mm	μm	1.5	
Linearity deviation within $\pm .039$ "	inch	60 μm	
Linearity deviation within ± 2.0 mm	μm	3	
Linearity deviation within $\pm .079$ "	inch	120 μm	
IP protection category		IP 64	
Cable length	m	2.5	
Temperature coefficient	$\mu\text{m}/^\circ\text{C}$	0.15	
Compatibility		Mahr VLDT	Tesa Marposs

Order no.	a	b	c	d	e	f	h	i	j	k	l	m	Connection thread
5323030	mm	mm	mm	mm	mm	mm	mm	mm	mm	mm	mm	mm	M 2.5
5323031	88.7	28	21.3	6	9.2	8	14	26.5	3.6	9	8.3	12.5	M 2.5
5323033	88.7	28	21.3	6	9.2	8	14	26.5	3.6	9	8.3	12.5	M 2.5

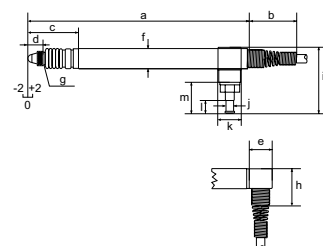

FEATURES

- Models with or without pneumatic lifter or load
- Measuring pin mounted in rotary stroke bearing
- High linearity over the entire measuring range
- Excellent electromagnetic shielding (EMC)
- All probes can be easily converted from axial to radial by mounting a slip on cap (included)
- Chemical resistance data:
 - Resistant to oil, gasoline, water and aliphatic compounds
 - Moderately resistant to acids, bases, solvents and ozone
- **Package contains:** instruction manual, cap for radial cable output, spanner for preliminary stroke setting



TECHNICAL DATA

Order no.		5324010
Type		P2010 M
Measuring range	mm	± 5
Measuring range	inch	± .197"
Distance to upper stop	mm...mm	+5.3
Distance to lower stop	mm...mm	-5.3
Distance to upper stop	inch...inch	+ .20"
Distance to lower stop	inch...inch	-.20"
Lifter / retraction		Standard model
Measuring force	N	0.75 N +/-0.15N
Increase in measuring force	N/mm	0.1 N/mm
Sensitivity deviation	%	0.3
Repeatability f_w	μm	0.2
Measuring value hysteresis f_u	μm	1
Linearity deviation within +/-2.0 mm	μm	4
Linearity deviation within +/- .079"	inch	160 μm
Linearity deviation within +/-5,0 mm	μm	20
Linearity deviation within +/- .197"	inch	780 μm
IP protection category		IP 64
Cable length	m	2.5
Temperature coefficient	$\mu\text{m}/^\circ\text{C}$	0.15
Compatibility		Mahr

Order no.	a	b	c	d	e	f	h	Connection thread
	mm	mm	mm	mm	mm	mm	mm	
5324010	125.7	28	34	6	9.2	8	14	

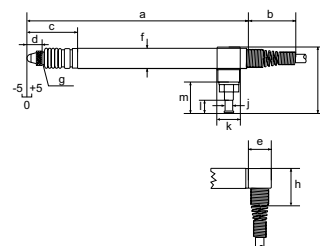

Inductive probe

FEATURES

- Models with or without pneumatic lifter or load
- Measuring pin mounted in rotary stroke bearing
- High linearity over the entire measuring range
- Excellent electromagnetic shielding (EMC)
- All probes can be easily converted from axial to radial by mounting a slip on cap (included)
- Chemical resistance data:
 - Resistant to oil, gasoline, water and aliphatic compounds
 - Moderately resistant to acids, bases, solvents and ozone
- **Package contains:** instruction manual, cap for radial cable output, spanner for preliminary stroke setting



TECHNICAL DATA

Order no.		5324020	5324021	5324023
Type		P2010 MA	P2010 TA	P2010 UA
Measuring range	mm		± 5	
Measuring range	inch		± .197"	
Distance to upper stop	mm...mm		+5.3	
Distance to lower stop	mm...mm		-5.3	
Distance to upper stop	inch...inch		+ .20"	
Distance to lower stop	inch...inch		- .20"	
Lifter / retraction			Vacuum lifter	
Measuring force	N		0.75 N +/- 0.15 N	
Increase in measuring force	N/mm		0.1 N/mm	
Sensitivity deviation	%		0.3	
Repeatability f_w	μm		0.2	
Measuring value hysteresis f_u	μm		1	
Linearity deviation within +/- 2.0 mm	μm		4	
Linearity deviation within +/- .079"	inch		160 μm	
Linearity deviation within +/- 5.0 mm	μm		20	
Linearity deviation within +/- .197"	inch		780 μm	
IP protection category			IP 64	
Cable length	m		2.5	
Temperature coefficient	$\mu\text{m}/^\circ\text{C}$		0.15	
Compatibility		Mahr VLDT	Tesa	Marpos

Order no.	a	b	c	d	e	f	h	i	j	k	l	m	Connection thread
	mm	mm	mm	mm	mm	mm	mm	mm	mm	mm	mm	mm	
5324020	125.7	28	34	6	9.2	8	14	26.5	3.6	9	8.3	12.5	M 2.5
5324021	125.7	28	34	6	9.2	8	14	26.5	3.6	9	8.3	12.5	M 2.5
5324023	125.7	28	34	6	9.2	8	14	26.5	3.6	9	8.3	12.5	M 2.5

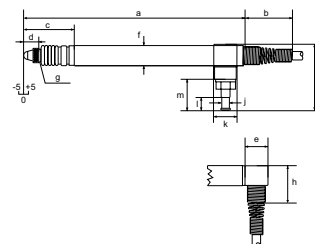

FEATURES

- Models with or without pneumatic lifter or load
- Measuring pin mounted in rotary stroke bearing
- High linearity over the entire measuring range
- Excellent electromagnetic shielding (EMC)
- All probes can be easily converted from axial to radial by mounting a slip on cap (included)
- Chemical resistance data:
 - Resistant to oil, gasoline, water and aliphatic compounds
 - Moderately resistant to acids, bases, solvents and ozone
- **Package contains:** instruction manual, cap for radial cable output, spanner for preliminary stroke setting



TECHNICAL DATA

Order no.	5324030	5324031	5324033
Type	P2010 MB	P2010 TB	P2010 UB
Measuring range	mm	± 5	
Measuring range	inch	± .197"	
Distance to upper stop	mm...mm	+5.3	
Distance to lower stop	mm...mm	-5.3	
Distance to upper stop	inch...inch	+ .20"	
Distance to lower stop	inch...inch	-.20"	
Lifter / retraction		Compressed air retraction (max. 1 bar)	
Measuring force	N	Depending upon air pressure	
Sensitivity deviation	%	0.3	
Repeatability f_w	µm	0.2	
Measuring value hysteresis f_u	µm	1	
Linearity deviation within +/-2.0 mm	µm	4	
Linearity deviation within +/- .079"	inch	160 µ"	
Linearity deviation within +/-5,0 mm	µm	20	
Linearity deviation within +/- .197"	inch	780 µ"	
IP protection category		IP 64	
Cable length	m	2.5	
Temperature coefficient	µm/°C	0.15	
Compatibility		Mahr VLDT	Tesa Marposs

Order no.	a	b	c	d	e	f	h	i	j	k	l	m	Connection thread
	mm	mm	mm	mm	mm	mm	mm	mm	mm	mm	mm	mm	
5324030	125.7	28	34	6	9.2	8	14	26.5	3.6	9	8.3	12.5	M 2.5
5324031	125.7	28	34	6	9.2	8	14	26.5	3.6	9	8.3	12.5	M 2.5
5324033	125.7	28	34	6	9.2	8	14	26.5	3.6	9	8.3	12.5	M 2.5

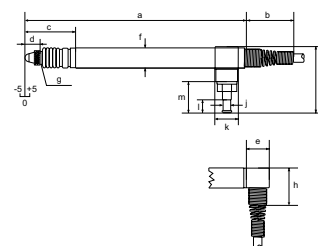

Inductive probe

FEATURES

- Models with pneumatic lifter or vacuum retraction
- Measuring pin mounted in rotary stroke bearing
- High linearity over the entire measuring range
- Excellent electromagnetic shielding (EMC)
- All probes can be easily converted from axial to radial by mounting a slip on cap (included)
- Chemical resistance data:
 - Resistant to oil, gasoline, water and aliphatic compounds
 - Moderately resistant to acids, bases, solvents and ozone
- **Package contains:** instruction manual, cap for radial cable output, spanner for preliminary stroke setting



TECHNICAL DATA

	Order no.	5324070	5324071	5324073
Type		P2104 MA	P2104 TA	P2104 UA
Measuring range	mm		± 2	
Measuring range	inch		± .079"	
Distance to upper stop	mm...mm		+8.4 ... 10.4	
Distance to lower stop	mm...mm		-2.2 ... 0	
Distance to upper stop	inch...inch		.3341"	
Distance to lower stop	inch...inch		-.09 ... 0"	
Lifter / retraction			Vacuum lifter	
Measuring force	N		0.75 N +/-0.15 N	
Increase in measuring force	N/mm		0.1 N/mm	
Sensitivity deviation	%		0.3	
Repeatability f_w	μm		0.2	
Measuring value hysteresis f_u	μm		1	
Linearity deviation within +/-0.5 mm	μm		0.5	
Linearity deviation within +/- .020"	inch		20 μm	
Linearity deviation within +/-1.0 mm	μm		2	
Linearity deviation within +/- .039"	inch		80 μm	
Linearity deviation within +/-2.0 mm	μm		4	
Linearity deviation within +/- .079"	inch		160 μm	
IP protection category			IP 64	
Cable length	m		2.5	
Temperature coefficient	$\mu\text{m}/^\circ\text{C}$		0.15	
Compatibility		Mahr VLDT	Tesa	Marposs

Order no.	a	b	c	d	e	f	h	i	j	k	l	m	Connection thread
	mm	mm	mm	mm	mm	mm	mm	mm	mm	mm	mm	mm	
5324070	128.7	28	37	6	9.2	8	14	26.5	3.6	9	8.3	12.5	M 2.5
5324071	128.7	28	37	6	9.2	8	14	26.5	3.6	9	8.3	12.5	M 2.5
5324073	128.7	28	37	6	9.2	8	14	26.5	3.6	9	8.3	12.5	M 2.5

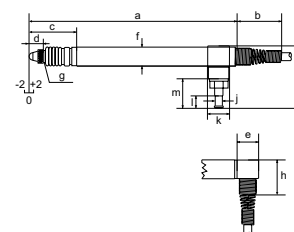

Inductive probe

FEATURES

- Models with pneumatic lifter or vacuum retraction
- Measuring pin mounted in rotary stroke bearing
- High linearity over the entire measuring range
- Excellent electromagnetic shielding (EMC)
- All probes can be easily converted from axial to radial by mounting a slip on cap (included)
- Chemical resistance data:
 - Resistant to oil, gasoline, water and aliphatic compounds
 - Moderately resistant to acids, bases, solvents and ozone
- **Package contains:** instruction manual, cap for radial cable output, spanner for preliminary stroke setting



TECHNICAL DATA

	Order no.	5324080	5324081	5324083
Type		P2104 MB	P2104 TB	P2104 UB
Measuring range	mm		± 2	
Measuring range	inch		± .079"	
Distance to upper stop	mm...mm		+8.4 ... 10.4	
Distance to lower stop	mm...mm		-2.2 ... 0	
Distance to upper stop	inch...inch		.3341"	
Distance to lower stop	inch...inch		-.09 ... 0"	
Lifter / retraction		Compressed air retraction (max. 1 bar)		
Measuring force	N	Depending upon air pressure		
Sensitivity deviation	%	0.3		
Repeatability f_w	μm	0.2		
Measuring value hysteresis f_u	μm	1		
Linearity deviation within ± 0.5 mm	μm	0.5		
Linearity deviation within $\pm .020$ "	inch	20 μm		
Linearity deviation within ± 1.0 mm	μm	2		
Linearity deviation within $\pm .039$ "	inch	80 μm		
Linearity deviation within ± 2.0 mm	μm	4		
Linearity deviation within $\pm .079$ "	inch	160 μm		
IP protection category		IP 64		
Cable length	m	2.5		
Temperature coefficient	$\mu\text{m}/^\circ\text{C}$	0.15		
Compatibility		Mahr VLDT	Tesa	Marposs

Order no.	a	b	c	d	e	f	h	i	j	k	l	m	Connection thread
	mm	mm	mm	mm	mm	mm	mm	mm	mm	mm	mm	mm	
5324080	128.7	28	37	6	9.2	8	14	26.5	3.6	9	8.3	12.5	M 2.5
5324081	128.7	28	37	6	9.2	8	14	26.5	3.6	9	8.3	12.5	M 2.5
5324083	128.7	28	37	6	9.2	8	14	26.5	3.6	9	8.3	12.5	M 2.5

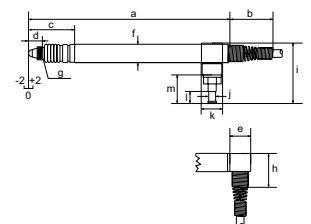

Millimar P2000 series

Inductive probe

ACCESSORIES

Order no.	For measuring instrument	Description	Type
5313419	P2004 MA, P2004 TA, P2004 UA, P2010 UA, P2010 TA, P2010 MA, P2104 UA, P2104 TA, P2104 MA	Pneumatic foot switch for maximum 4 probes	1340/1F
5313420	P2004 MA, P2004 TA, P2004 UA, P2010 UA, P2010 TA, P2010 MA, P2104 UA, P2104 TA, P2104 MA	Pneumatic hand lifter for 1 probe	1340/1
5323130	P2104 MB, P2004 MA, P2004 M, P2004 MB, P2010 M, P2010 MA, P2104 MA, P2010 MB	Extension cable 2.5 m (Mahr VLDT)	C2025 M
5323131	P2104 TB, P2004 T, P2004 TA, P2004 TB, P2010 TA, P2104 TA, P2010 TB	Extension cable 2.5 m (Tesa)	C2025 T
5323140	P2104 MB, P2004 MA, P2004 M, P2004 MB, P2010 M, P2010 MA, P2104 MA, P2010 MB	Extension cable 5 m (Mahr VLDT)	C2050 M
5323141	P2104 TB, P2004 T, P2004 TA, P2004 TB, P2010 TA, P2104 TA, P2010 TB	Extension cable 5 m (Tesa)	C2050 T
5323150	P2104 MB, P2004 MA, P2004 M, P2004 MB, P2010 M, P2010 MA, P2104 MA, P2010 MB	Extension cable 7.5 m (Mahr VLDT)	C2075 M
5323151	P2104 TB, P2004 T, P2004 TA, P2004 TB, P2010 TA, P2104 TA, P2010 TB	Extension cable 7.5 m (Tesa)	C2075 T
5323160	P2104 MB, P2004 MA, P2004 M, P2004 MB, P2010 M, P2010 MA, P2104 MA, P2010 MB	Extension cable 10 m (Mahr VLDT)	C2100 M
5323161	P2104 TB, P2004 T, P2004 TA, P2004 TB, P2010 TA, P2104 TA, P2010 TB	Extension cable 10 m (Tesa)	C2100 T
7021546	P2004 U, P2004 MA, P2004 T, P2004 M, P2004 TA, P2004 UA	Sealing bellows for probes with measuring spring	
7025505	P2004 U, P2004 MA, P2004 T, P2004 M, P2004 TA, P2004 UA	Measuring spring 1.25 N	
7025579	P2004 U, P2004 MA, P2004 T, P2004 M, P2004 TA, P2004 UA	Measuring spring 1.0 N	
7026827	P2004 U, P2004 MA, P2004 T, P2004 M, P2004 TA, P2004 UA	Measuring spring 0.25 N	
7026828	P2004 U, P2004 MA, P2004 T, P2004 M, P2004 TA, P2004 UA	Measuring spring 0.5 N	
7026849	P2004 U, P2004 MA, P2004 T, P2004 M, P2004 TA, P2004 UA	Measuring spring 0.75 N	
7027758	P2010 UA, P2010 M, P2010 TA, P2010 MA, P2104 UA, P2104 TA, P2104 MA	Sealing bellows long for probes with measuring spring	
7028220	P2004 MB, P2004 TB, P2004 UB	Sealing bellows for probes with air retraction	
7028221	P2104 MB, P2104 UB, P2104 TB, P2010 MB, P2010 TB, P2010 UB	Sealing bellows long for probes with air retraction	

Inductive probe

FEATURES

- Mahr compatibility
- Proven Mahr half-bridge technology
- Very easy to service: cables and probes can be separated via the plug-in connector
- Easy to convert to pneumatic lifting
- Measuring pin mounted in rotary stroke bearing
- Chemical resistance data:
 - Resistant to oil, gasoline, water and aliphatic compounds
 - Moderately resistant to acids, bases, solvents and ozone
- **Package contains:** instruction manual, spanner for preliminary stroke setting, hose connector for compressed air



TECHNICAL DATA

Order no.		4400180	4400182
Type		P1300 MA	P1300 MA without cable
Measuring range	mm	± 2	
Measuring range	inch	± .079"	
Distance to upper stop	mm...mm	+2.2 ... 4.4	
Distance to lower stop	mm...mm	-2.2 ... 0	
Distance to upper stop	inch...inch	+ .09173"	
Distance to lower stop	inch...inch	-.09 ... 0"	
Lifter / retraction		Vacuum lifter (standard option)	
Measuring force	N	0.75 N +/- 0.15 N	
Increase in measuring force	N/mm	0.3 N/mm	
Sensitivity deviation	%	0.3	
Repeatability f_w	μm	0.1	
Measuring value hysteresis f_u	μm	0.5	
Linearity deviation within +/- 0.5 mm	μm	0.4	
Linearity deviation within +/- .020"	inch	16 μm	
Linearity deviation within +/- 1.0 mm	μm	1.5	
Linearity deviation within +/- .039"	inch	60 μm	
Linearity deviation within +/- 2.0 mm	μm	3	
Linearity deviation within +/- .079"	inch	120 μm	
IP protection category		IP 64	
Cable length	m	2.5	
Temperature coefficient	$\mu\text{m}/^\circ\text{C}$	0.15	
Compatibility		Mahr half-bridge	

Order no.	a	b	c	d
	mm	mm	mm	mm
4400180	85.6	53.3	98.6	125
4400182	85.6	53.3	98.6	125

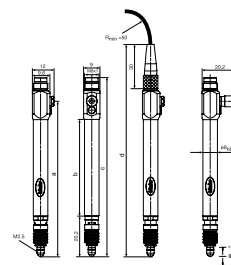

ACCESSORIES

Order no.	Description
4885220	Cable 2.5 m
4885259	Cable 5 m
4885260	Cable 10 m
4885334	Cable 2.5 m, 90° offset
4885335	Cable 5 m, 90° offset
4885336	Cable 10 m, 90° offset
4400238	Hose connector 90° offset
7021546	Sealing bellows for probes with measuring spring
7026827	Measuring spring 0.25 N
7026828	Measuring spring 0.5 N
7026849	Measuring spring 0.75 N
7025579	Measuring spring 1.0 N
7025505	Measuring spring 1.25 N

Millimar P1300 MB / P1300 MB without cable



Inductive probe

FEATURES

- Mahr compatibility
- Proven Mahr half-bridge technology
- With compressed-air push
- Very easy to service: cables and probes can be separated via the plug-in connector
- Measuring pin mounted in rotary stroke bearing
- Chemical resistance data:
 - Resistant to oil, gasoline, water and aliphatic compounds
 - Moderately resistant to acids, bases, solvents and ozone
- **Package contains:** instruction manual, spanner for preliminary stroke setting, hose connector for compressed air



TECHNICAL DATA

Order no.		4400181	4400183
Type		P1300 MB	P1300 MB without cable
Measuring range	mm		± 2
Measuring range	inch		± .079"
Distance to upper stop	mm...mm		+2.2 ... 4.4
Distance to lower stop	mm...mm		-2.2 ... 0
Distance to upper stop	inch...inch		+ .09173"
Distance to lower stop	inch...inch		-.09 ... 0"
Lifter / retraction		Pneumatic jacking (max. 1 bar)	
Measuring force	N	Depending upon air pressure	
Sensitivity deviation	%	0.3	
Repeatability f_w	μm	0.1	
Measuring value hysteresis f_u	μm	0.5	
Linearity deviation within ± 0.5 mm	μm	0.4	
Linearity deviation within ± 0.020 "	inch	16 μm	
Linearity deviation within ± 1.0 mm	μm	1.5	
Linearity deviation within ± 0.039 "	inch	60 μm	
Linearity deviation within ± 2.0 mm	μm	3	
Linearity deviation within ± 0.079 "	inch	120 μm	
IP protection category		IP 64	
Cable length	m	2.5	
Temperature coefficient	$\mu\text{m}/^\circ\text{C}$	0.15	
Compatibility		Mahr half-bridge	

Order no.	a	b	c	d
	mm	mm	mm	mm
4400181	85.6	53.3	98.6	125
4400183	85.6	53.3	98.6	125

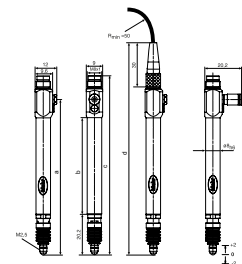

ACCESSORIES

Order no.	Description
4885220	Cable 2.5 m
4885259	Cable 5 m
4885260	Cable 10 m
4885334	Cable 2.5 m, 90° offset
4885335	Cable 5 m, 90° offset
4885336	Cable 10 m, 90° offset
4400238	Hose connector 90° offset
7028220	Sealing bellows for probes with air retraction

Millimar P1300 TA / P1300 TA without cable

IP 64

Inductive probe

FEATURES

- Tesa compatibility
- Tesa half-bridge technology
- Very easy to service: cables and probes can be separated via the plug-in connector
- Easy to convert to pneumatic lifting
- Measuring pin mounted in rotary stroke bearing
- Chemical resistance data:
 - Resistant to oil, gasoline, water and aliphatic compounds
 - Moderately resistant to acids, bases, solvents and ozone
- **Package contains:** instruction manual, spanner for preliminary stroke setting, hose connector for compressed air



TECHNICAL DATA

Order no.		4400190	4400192
Type		P1300 TA	P1300 TA without cable
Measuring range	mm		± 2
Measuring range	inch		± .079"
Distance to upper stop	mm...mm		+2.2 ... 4.4
Distance to lower stop	mm...mm		-2.2 ... 0
Distance to upper stop	inch...inch		+ .09173"
Distance to lower stop	inch...inch		- .09 ... 0"
Lifter / retraction		Vacuum lifter (standard option)	
Measuring force	N	0.75 N +/-0.15 N	
Increase in measuring force	N/mm	0.3 N/mm	
Sensitivity deviation	%	0.3	
Repeatability f_w	μm	0.1	
Measuring value hysteresis f_u	μm	0.5	
Linearity deviation within +/-0.5 mm	μm	1	
Linearity deviation within +/-0.020"	inch	40 μm	
Linearity deviation within +/-1.0 mm	μm	3	
Linearity deviation within +/-0.039"	inch	120 μm	
IP protection category		IP 64	
Cable length	m	2.5	
Temperature coefficient	$\mu\text{m}/^\circ\text{C}$	0.15	
Compatibility		Tesa	

Order no.	a	b	c	d
	mm	mm	mm	mm
4400190	94.2	61.9	107.2	133.6
4400192	94.2	61.9	107.2	133.6

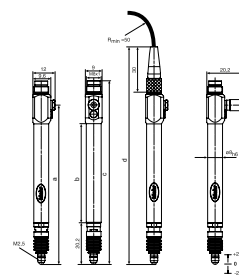

ACCESSORIES

Order no.	Description
4885220	Cable 2.5 m
4885259	Cable 5 m
4885260	Cable 10 m
4885334	Cable 2.5 m, 90° offset
4885335	Cable 5 m, 90° offset
4885336	Cable 10 m, 90° offset
4400238	Hose connector, 90° offset
7021546	Sealing bellows for probes with measuring spring
7026827	Measuring spring 0.25 N
7026828	Measuring spring 0.5 N
7026849	Measuring spring 0.75 N
7025579	Measuring spring 1.0 N
7025505	Measuring spring 1.25 N

Millimar P1300 TB / P1300 TB without cable



Inductive probe

FEATURES

- Tesa compatibility
- Tesa half-bridge technology
- With compressed-air push
- Very easy to service: cables and probes can be separated via the plug-in connector
- Measuring pin mounted in rotary stroke bearing
- Chemical resistance data:
 - Resistant to oil, gasoline, water and aliphatic compounds
 - Moderately resistant to acids, bases, solvents and ozone
- **Package contains:** instruction manual, spanner for preliminary stroke setting, hose connector for compressed air



TECHNICAL DATA

Order no.		4400191	4400193
Type		P1300 TB	P1300 TB without cable
Measuring range	mm		± 2
Measuring range	inch		± .079"
Distance to upper stop	mm...mm		+2.2 ... 4.4
Distance to lower stop	mm...mm		-2.2 ... 0
Distance to upper stop	inch...inch		+ .09173"
Distance to lower stop	inch...inch		-.09 ... 0"
Lifter / retraction		Compressed air retraction (max. 1 bar)	
Measuring force	N	Depending upon air pressure	
Sensitivity deviation	%	0.3	
Repeatability f_w	μm	0.1	
Measuring value hysteresis f_u	μm	0.5	
Linearity deviation within ± 0.5 mm	μm	1	
Linearity deviation within ± 0.020 "	inch	40 μm	
Linearity deviation within ± 1.0 mm	μm	3	
Linearity deviation within ± 0.039 "	inch	120 μm	
IP protection category		IP 64	
Cable length	m	2.5	
Temperature coefficient	$\mu\text{m}/^\circ\text{C}$	0.15	
Compatibility		Tesa	

Order no.	a	b	c	d
	mm	mm	mm	mm
4400191	94.2	61.9	107.2	133.6
4400193	94.2	61.9	107.2	133.6

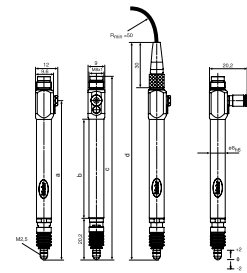

ACCESSORIES

Order no.	Description
4885220	Cable 2.5 m
4885259	Cable 5 m
4885260	Cable 10 m
4885334	Cable 2.5 m, 90° offset
4885335	Cable 5 m, 90° offset
4885336	Cable 10 m, 90° offset
4400238	Hose connector 90° offset
7028220	Sealing bellows for probes with air retraction

FEATURES

- Highly robust as the measuring system is recessed from the guide and mounting shaft
- Outstanding clamping properties
- Measuring pin mounted in rotary stroke bearing
- Measuring pin can be lifted using wire lifter
- Chemical resistance data:
 - Resistant to oil, gasoline, water and aliphatic compounds
 - Moderately resistant to acids, bases, solvents and ozone
- **Package contains:** spanner for preliminary stroke setting



TECHNICAL DATA

Order no.	5313010		5313030	
Type	1301		1303	
Measuring range	mm	± 1		
Measuring range	inch	± .039"		
Distance to upper stop	mm	+2,7		
Distance to lower stop	mm	-1.1 ... 0		
Distance to upper stop	inch	+ .106"		
Distance to lower stop	inch	-.043 ... 0"		
Lifter / retraction	Cable release			
Measuring force	N	0.75 N +/-0.15 N		
Increase in measuring force	N/mm	0.4 N/mm		
Sensitivity deviation	%	0.3		
Repeatability f_w	μm	0.1		
Measuring value hysteresis f_u	μm	0.2		
Linearity deviation within +/-0.5 mm	μm	0.5		
Linearity deviation within +/-0.020"	inch	20 μm		
Linearity deviation within +/-1.0 mm	μm	2		
Linearity deviation within +/-0.039"	inch	80 μm		
IP protection category	IP 64			
Cable length	m	2.5		
Temperature coefficient	$\mu\text{m}/^\circ\text{C}$	0.09		
Compatibility	Mahr LVDT			

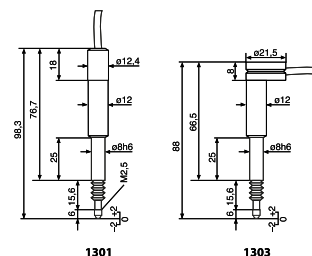

ACCESSORIES

Order no.	Description	Type
5312881	Extension cable 1 m (Mahr LVDT)	1288/1
5312882	Extension cable 2.5 m (Mahr LVDT)	1288/2.5
5312885	Extension cable 5 m (Mahr LVDT)	1288/5
5312887	Extension cable 7.5 m (Mahr LVDT)	1288/7.5
5312889	Extension cable 10 m (Mahr LVDT)	1288/10
5313990	Cable release with clamp for 1301 / 1303	1399

Millimar 1304 K

Inductive probe



FEATURES

- Highly robust as the measuring system is recessed from the guide and mounting shaft
- Outstanding clamping properties
- Measuring pin mounted in rotary stroke bearing
- Chemical resistance data:
 - Resistant to oil, gasoline, water and aliphatic compounds
 - Moderately resistant to acids, bases, solvents and ozone

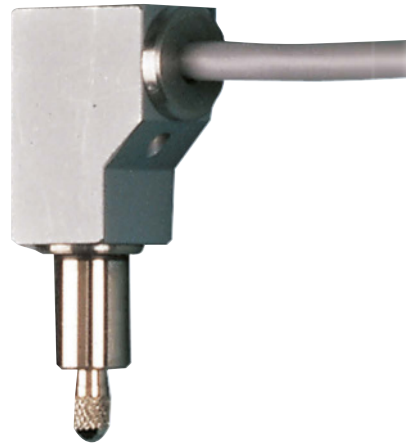

TECHNICAL DATA

Order no.		5313049
Type		1304 K
Measuring range	mm	± 1
Measuring range	inch	± .039"
Distance to upper stop	mm	+1.1
Distance to lower stop	mm	1.1
Distance to upper stop	inch	+ .043"
Distance to lower stop	inch	-.043"
Measuring force	N	0.75 N +/-0.15 N
Increase in measuring force	N/mm	0.15 N/mm
Sensitivity deviation	%	1
Repeatability f_w	μm	0.15
Measuring value hysteresis f_u	μm	0.2
Linearity deviation within +/-0.5 mm	μm	1
Linearity deviation within +/-0.020"	inch	40 μm
Linearity deviation within +/-1.0 mm	μm	4
Linearity deviation within +/-0.039"	inch	160 μm
IP protection category		IP 62
Cable length	m	2.5
Temperature coefficient	$\mu\text{m}/^\circ\text{C}$	0.15
Compatibility		Mahr LVDT

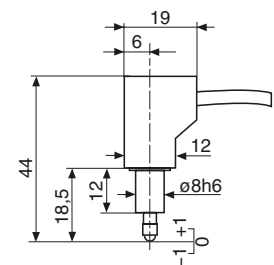

ACCESSORIES

Order no.	Description	Type
5312881	Extension cable 1 m (Mahr LVDT)	1288/1
5312882	Extension cable 2.5 m (Mahr LVDT)	1288/2.5
5312885	Extension cable 5 m (Mahr LVDT)	1288/5
5312887	Extension cable 7.5 m (Mahr LVDT)	1288/7.5
5312889	Extension cable 10 m (Mahr LVDT)	1288/10

Millimar 1318

Inductive probe

FEATURES

- Dial test indicator inductive probe
- Flexible probe adjustment to contact surface
- Highly robust as the measuring system is recessed from the guide and mounting shaft
- Outstanding clamping properties
- Chemical resistance data:
 - Resistant to oil, gasoline, water and aliphatic compounds
 - Moderately resistant to acids, bases, solvents and ozone



TECHNICAL DATA

Order no.	5313180	
Type	1318	
Measuring range	mm	-0.3 ... 1
Measuring range	inch	- .012 ... + .039"
Distance to upper stop	mm	+1.6
Distance to lower stop	mm	-0.37
Distance to upper stop	inch	+ .063"
Distance to lower stop	inch	- .0146"
Measuring force	N	0.25 N +/-0.05 N
Increase in measuring force	N/mm	0.04 N/mm
Sensitivity deviation	%	0.5
Repeatability f_w	μm	0.03
Measuring value hysteresis f_u	μm	0.5
Linearity deviation within +/-0.3 mm	μm	0.9
Linearity deviation within +/-0.012"	inch	36 μm
IP protection category	IP 50	
Cable length	m	1.5
Compatibility	Mahr LVDT	

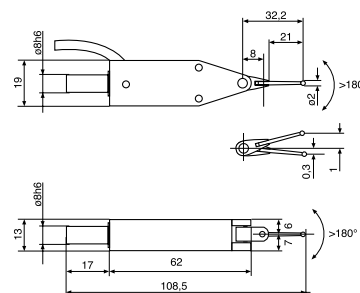

ACCESSORIES

Order no.	Description	Type
5312881	Extension cable 1 m (Mahr LVDT)	1288/1
5312882	Extension cable 2.5 m (Mahr LVDT)	1288/2.5
5312885	Extension cable 5 m (Mahr LVDT)	1288/5
5312887	Extension cable 7.5 m (Mahr LVDT)	1288/7.5
5312889	Extension cable 10 m (Mahr LVDT)	1288/10
7003901	Stylus \varnothing 0.5 mm, carbide, l = 21 mm	
7003902	Stylus \varnothing 1.0 mm, carbide, l = 21 mm	
3005223	Stylus \varnothing 2.0 mm, carbide, l = 21 mm	
7003903	Stylus \varnothing 3.0 mm, carbide, l = 21 mm	
8004231	Stylus \varnothing 2.0 mm, ruby, l = 21 mm	

Millimar 1340

Inductive probe



FEATURES

- Only for use in conjunction with the Millimar C 1240 M compact length measuring instrument, Millimar C 1202 + N 1702 M-HR or Millimar C 1202 + N 1702 M
- Maximum measuring accuracy and minimum linearity deviation <math><0.01\%</math>, i.e. - Probe protected against dirt and moisture, can therefore be used close to production
- Chemical resistance data:
 - Resistant to oil, gasoline, water and aliphatic compounds
 - Moderately resistant to acids, bases, solvents and ozone



TECHNICAL DATA

Order no.	5313400	
Type	1340	
Measuring range	mm	± 2
Measuring range	inch	$\pm .079''$
Distance to upper stop	mm	+3
Distance to lower stop	mm	-2.2
Distance to upper stop	inch	+ .118''
Distance to lower stop	inch	-.09''
Lifter / retraction	Vacuum lifter	
Measuring force	N	0.75 N
Increase in measuring force	N/mm	0.08 N/mm
Sensitivity deviation	%	0.3
Repeatability f_w	μm	0.08
Measuring value hysteresis f_u	μm	0.08
Linearity deviation within $\pm 1.0\ \text{mm}$	μm	0.15
Linearity deviation within $\pm .039''$	inch	$6\ \mu''$
Linearity deviation within $\pm 2.0\ \text{mm}$	μm	0.4
Linearity deviation within $\pm .079''$	inch	$16\ \mu''$
IP protection category	IP 64	
Cable length	m	1.5
Temperature coefficient	$\mu\text{m}/^\circ\text{C}$	0.6
Compatibility	Mahr 1340	

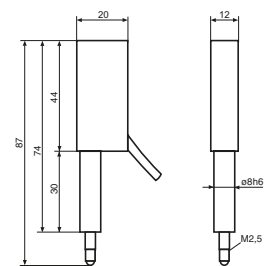

ACCESSORIES

Order no.	Description	Type
5313420	Pneumatic hand lifter for 1 probe	1340/1
5313419	Pneumatic foot switch for maximum 4 probes	1340/1F

Millimar P 1512 V / P 1530 V

Incremental probe

FEATURES

- Maximum measuring accuracy for long measuring length
- Compact dimensions
- Particularly durable ball bearing guide
- Reference mark for position determination
- 8 mm clamping shaft
- **Package contains:** instruction manual, test certificate



TECHNICAL DATA

Order no.		5315081	5315311
Type		P 1512 V	P 1530 V
Measuring span	mm	12	30
Measuring span	inch	0.47	1.18
Measuring force	N	0.6 – 1.2 N	0.4 – 1 N
Maximum shear force	N	0,8	
Measuring system		DIADUR-glass scale with incremental graduation	
System accuracy	µm	1.0	
Resolution		20 µm	
Output signal		1 Vpp	
Max measuring speed		0.5 m/s	
IP protection category		IP 67	IP 64
Cable length	m	1.5	
Working temperature	°C	20	

Millimar | Air gage metrology

Metrological characteristics

Millimar evaluation devices work according to the principle of differential pressure measurement. The pressure difference between two pressure chambers is measured. While one of the two chambers supplies a constant reference pressure, the pressure of the other chamber (measuring chamber) is determined by the distance of the measuring nozzles of a pneumatic transducer to the test specimen. Millimar evaluation units have two connection points, each of which is directly connected to one of the two pressure chambers. As a result, the measured value is measured directly via a piezo pressure sensor without conversion and then digitized.

Ratios from 2500:1 to 10000:1 are realized by exchangeable unit nozzles.

Millimar gages must be supplied with constant air pressure via a fine pressure reducer. Gages with a fine pressure reducer can be connected to all compressed air lines with operating pressures from 3.5 bar to 10 bar gage pressure, whereby an air filter should be interposed.

The compressed air must be dry and oil-free.

- Universal, reliable, proven, particularly powerful
- High measuring accuracy and reproducibility of measuring results: 0.5 μm to 2 μm depending on transmission ratio
- Non-contact measurement with measuring nozzles, no damage to workpieces
- Reliable measurement even of uncleaned, oiled, greased or lapped workpieces. Cleaning of the measuring points by the measuring air
- Robust design for workshop use
- Wide range of models for all applications
- Special designs for special applications



Millimar | Air gaging equipment



N 1701 PF-xxx



Jet air ring gage

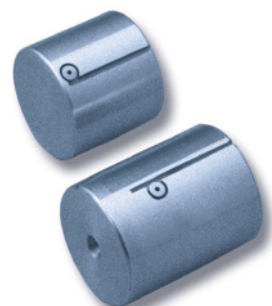

Jet air plug gages

Millimar | Air gages

Precision begins at the start of the measuring process

Air gages use the measuring effect of the change in pressure when a workpiece approaches a measuring jet. As the distance between jets and work surface decreases, the pressure increases while the velocity of flow and the respective volume flow decrease. The air measuring procedure has a relatively short but very linear measuring range.

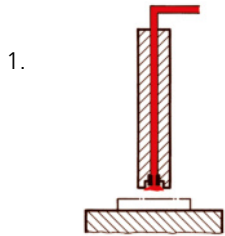

1. Thickness or wall thickness measurements with jet air gage.

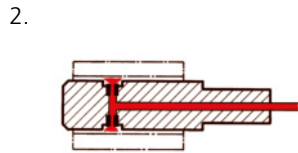

2. Diameter measurement of cylindrical through bores with jet air plug gage.

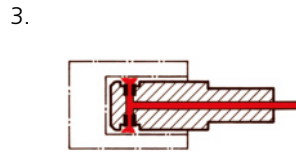

3. Diameter measurement of cylindrical blind bores with jet air plug gage.

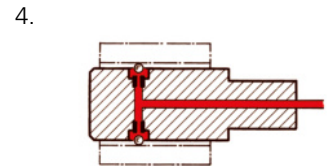

4. Diameter measurement of cylindrical through bores with ball contact plug gage.

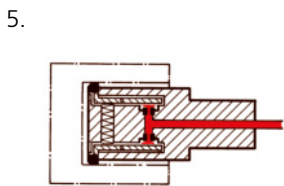

5. Diameter measurement of cylindrical blind bores with lever contact plug gage.

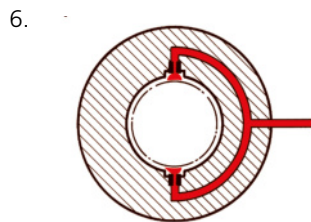

6. Diameter measurement of cylindrical shafts with jet air ring gage.

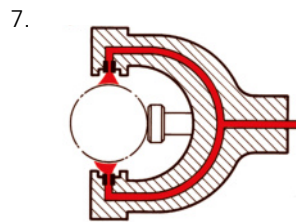

7. Diameter or thickness measurement with adjustable jet air caliper gage.

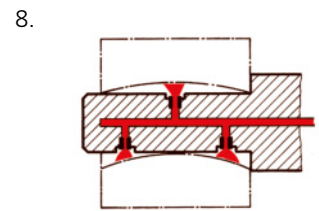

8. Straightness measurement of a cylindrical bore with special jet air plug gage.

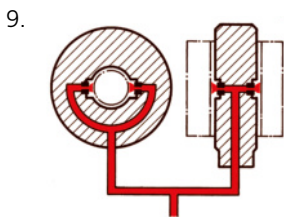

9. Mating measurement between bore and shaft with jet air plug gage and jet air ring gage.

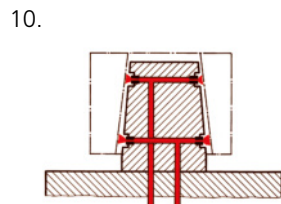

10. Taper pitch measurement of an inside taper with taper jet air plug gage measurement as per the differential measuring method.

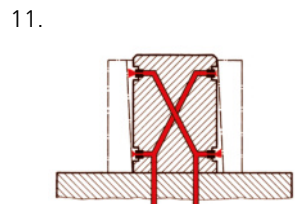

11. Measurement of a perpendicular position of a cylindrical bore to the front face with a special jet air plug gage measurement as per the differential measuring method.

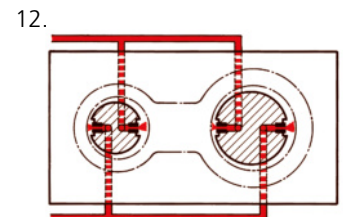

12. Measurement of hole distances of separated cylindrical bores with jet air plug gage measurement as per the differential measuring method.

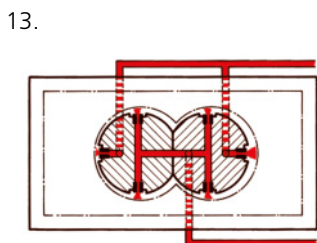

13. Measurement of hole distances of truncated cylindrical bores with jet air plug gages measurement as per the differential measuring method.

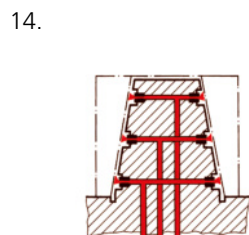

14. Taper pitch measurement as well as form and diameter measurement of an inside taper with taper jet air plug gage.

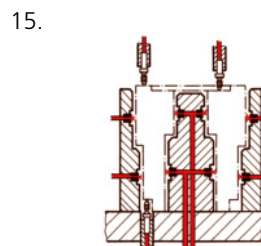

15. Multiple inside and outside measurements with measuring jet air gages and contact probes in connection with a seven-column unit.

Millimar DP20 / DP50 / DP60

2-jet through-hole air plug gage

FEATURES

- Calibrated ID tooling for the Dimensionair® air gaging systems
- Tooling is interchangeable without adjusting system magnification
- Federal air plugs have large clearance (see table below), allowing easy entrance into the hole being measured and a greater measuring range
- Long life - wide clearance and PVD coated (optional) body extends life of the air plug
- Air jets are recessed into the plug body, protecting them from damage
- Large jet size eliminates clogging from dirt and oils.
- Other lengths for air plug body (L2) and position of measuring jets (B) on request

Application:

- Measurement of through holes

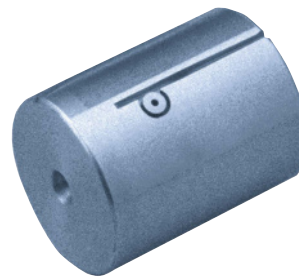

Please always state when ordering:

- Transmission ratio of the display unit (e.g. DP50 / 2500:1)
- The nominal size to be measured
- The specified workpiece tolerance
- Whether the air plug body is to be finished without or with PVD coating

TECHNICAL DATA

Order no.	Type	Nominal size	Nominal size	Model	Magnification	Measuring span	Compatibility	Connection thread	Minimum bore length	Including handle
		mm	inch						mm	
2115000	DP20	3.000	.118-.236"	hardened steel	5000:1, 2500:1, 1260:1	13-25 (DP20) 25-51 (DP50) 51-102 (DP60) depending on diameter	Federal	3/8"-32	4.75	
	DP50	-6.000								
	DP60									
2115000PVD	DP20	3.000	.118-.236"	PVD coated based on AlCrN	5000:1, 2500:1, 1260:1	13-25 (DP20) 25-51 (DP50) 51-102 (DP60) depending on diameter	Federal	3/8"-32	4.75	
	DP50	-6.000								
	DP60									
2115001	DP20	6.000	.236-.394"	hardened steel	5000:1, 2500:1, 1260:1	38 (DP20) 76 (DP50) 152 (DP60)	Federal	3/8"-32	6.35	
	DP50	-10.000								
	DP60									
2115001PVD	DP20	6.000	.236-.394"	PVD coated based on AlCrN	5000:1, 2500:1, 1260:1	38 (DP20) 76 (DP50) 152 (DP60)	Federal	3/8"-32	6.35	
	DP50	-10.000								
	DP60									
2115002	DP20	10.000	.394-.512"	hardened steel	5000:1, 2500:1, 1260:1	38 (DP20) 76 (DP50) 152 (DP60)	Federal	3/8"-32	6.35	
	DP50	-13.000								
	DP60									
2115002PVD	DP20	10.000	.394-.512"	PVD coated based on AlCrN	5000:1, 2500:1, 1260:1	38 (DP20) 76 (DP50) 152 (DP60)	Federal	3/8"-32	6.35	
	DP50	-13.000								
	DP60									
2115003	DP20	13.000	.512-.590"	hardened steel	5000:1, 2500:1, 1260:1	38 (DP20) 76 (DP50) 152 (DP60)	Federal	3/8"-32	6.35	
	DP50	-15.000								
	DP60									
2115003PVD	DP20	13.000	.512-.590"	PVD coated based on AlCrN	5000:1, 2500:1, 1260:1	38 (DP20) 76 (DP50) 152 (DP60)	Federal	3/8"-32	6.35	
	DP50	-15.000								
	DP60									
2115004	DP20	15.000	.590-1.575"	hardened steel	5000:1, 2500:1, 1260:1	38 (DP20) 76 (DP50) 152 (DP60)	Federal	3/8"-32	6.35	
	DP50	-40.000								
	DP60									
2115004PVD	DP20	15.000	.590-1.575"	PVD coated based on AlCrN	5000:1, 2500:1, 1260:1	38 (DP20) 76 (DP50) 152 (DP60)	Federal	3/8"-32	6.35	
	DP50	-40.000								
	DP60									
2115005	DP20	40.000	1.575-2.362"	hardened steel	5000:1, 2500:1, 1260:1	38 (DP20) 76 (DP50) 152 (DP60)	Federal	3/8"-32	6.35	
	DP50	-60.000								
	DP60									
2115005PVD	DP20	40.000	1.575-2.362"	PVD coated based on AlCrN	5000:1, 2500:1, 1260:1	38 (DP20) 76 (DP50) 152 (DP60)	Federal	3/8"-32	6.35	
	DP50	-60.000								
	DP60									

Millimar DP20 / DP50 / DP60

2-jet through-hole air plug gage

Order no.	Type	Nominal size	Nominal size	Model	Magnification	Measuring span	Compatibility	Connection thread	Minimum bore length	Including handle
		mm	inch			µm			mm	
2115006	DP20 DP50 DP60	60.000 -75.000	2.362-2.953"	hardened steel	5000:1, 2500:1, 1260:1	38 (DP20) 76 (DP50) 152 (DP60)	Mahr	3/8"-32	6.35	
2115006PVD	DP20 DP50 DP60	60.000 -75.000	2.362-2.953"	PVD coated based on AlCrN	5000:1, 2500:1, 1260:1	38 (DP20) 76 (DP50) 152 (DP60)	Mahr	3/8"-32	6.35	
2115027	DP20 DP50 DP60	75.000 -90.000	2.953-3.543"	hardened steel	5000:1, 2500:1, 1260:1	38 (DP20) 76 (DP50) 152 (DP60)	Mahr	3/8"-32	6.35	•
2115027PVD	DP20 DP50 DP60	75.000 -90.000	2.953-3.543"	PVD coated based on AlCrN	5000:1, 2500:1, 1260:1	38 (DP20) 76 (DP50) 152 (DP60)	Mahr	3/8"-32	6.35	•
2115028	DP20 DP50 DP60	90.000 -100.000	3.543-3.937"	hardened steel	5000:1, 2500:1, 1260:1	38 (DP20) 76 (DP50) 152 (DP60)	Mahr	3/8"-32	6.35	•
2115028PVD	DP20 DP50 DP60	90.000 -100.000	3.543-3.937"	PVD coated based on AlCrN	5000:1, 2500:1, 1260:1	38 (DP20) 76 (DP50) 152 (DP60)	Mahr	3/8"-32	6.35	•
2115029	DP20 DP50 DP60	100.000 -115.000	3.937-4.528"	hardened steel	5000:1, 2500:1, 1260:1	38 (DP20) 76 (DP50) 152 (DP60)	Mahr	3/8"-32	6.35	•
2115029PVD	DP20 DP50 DP60	100.000 -115.000	3.937-4.528"	PVD coated based on AlCrN	5000:1, 2500:1, 1260:1	38 (DP20) 76 (DP50) 152 (DP60)	Mahr	3/8"-32	6.35	•

Millimar DP20 / DP50 / DP60

2-jet through-hole air plug gage

Order no.	A	B	L ₂	Nominal size	Nominal size	Connection thread
	mm	mm	mm	mm	inch	
2115000	38.1	12.70	25.4	3.000 – 6.000	.118 – .236"	3/8"–32
2115000PVD	38.1	12.70	25.4	3.000 – 6.000	.118 – .236"	3/8"–32
2115001	38.1	12.70	25.4	6.000 – 10.000	.236–.394"	3/8"–32
2115001PVD	38.1	12.70	25.4	6.000 – 10.000	.236–.394"	3/8"–32
2115002	38.1	12.70	25.4	10.000 – 13.000	.394–.512"	3/8"–32
2115002PVD	38.1	12.70	25.4	10.000 – 13.000	.394–.512"	3/8"–32
2115003	44.5	19.10	25.4	13.000 – 15.000	.512–.590"	3/8"–32
2115003PVD	44.5	19.10	25.4	13.000 – 15.000	.512–.590"	3/8"–32
2115004	44.5	19.10	25.4	15.000 – 40.000	.590–1.575"	3/8"–32
2115004PVD	44.5	19.10	25.4	15.000 – 40.000	.590–1.575"	3/8"–32
2115005	44.5	19.10	25.4	40.000 – 60.000	1.575–2.362"	3/8"–32
2115005PVD	44.5	19.10	25.4	40.000 – 60.000	1.575–2.362"	3/8"–32
2115006	44.5	19.10	25.4	60.000 – 75.000	2.362–2.953"	3/8"–32
2115006PVD	44.5	19.10	25.4	60.000 – 75.000	2.362–2.953"	3/8"–32
2115027	44.5	19.10	25.4	75.000 – 90.000	2.953–3.543"	3/8"–32
2115027PVD	44.5	19.10	25.4	75.000 – 90.000	2.953–3.543"	3/8"–32
2115028	44.5	19.10	25.4	90.000 – 100.000	3.543–3.937"	3/8"–32
2115028PVD	44.5	19.10	25.4	90.000 – 100.000	3.543–3.937"	3/8"–32
2115029	44.5	19.10	25.4	100.000 – 115.000	3.937–4.528"	3/8"–32
2115029PVD	44.5	19.10	25.4	100.000 – 115.000	3.937–4.528"	3/8"–32

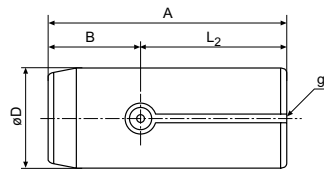

ACCESSORIES

Order no.	Description	Type	Connection thread
2260835	Connecting hose set, complete, 2 m		3/8"–32
2261280	Connecting hose set, complete, 4 m		3/8"–32
2202010	Extension for nominal sizes up to 76.3 mm, D = 12 mm, L = 102 mm	AHA-4	3/8"–32
2202011	Extension for nominal sizes up to 76.3 mm, D = 12 mm, L = 51 mm	AHA-5	3/8"–32
2237666	Standard plastic handle		3/8"–32
2237873	Depth stop ring for Mahr nozzle plug gage		
2239307	Universal bench mount		3/8"–32
2240993	Shut off slide valve		3/8"–32



Millimar DP20 / DP50 / DP60

2-jet blind-hole air plug gage

FEATURES

- Calibrated ID tooling for the Dimensionair® air gaging systems
- Tooling is interchangeable without adjusting system magnification
- Federal air plugs have large clearance (see table below), allowing easy entrance into the hole being measured and a greater measuring range
- Long life - wide clearance and PVD coated (optional) body extends life of the air plug
- Air jets are recessed into the plug body, protecting them from damage
- Large jet size eliminates clogging from dirt and oils
- Other lengths for air plug body (L2) and position of measuring jets (B) on request

Please always state when ordering:

- Transmission ratio of the display unit (e.g. DP50 / 2500:1)
- The nominal size to be measured
The specified workpiece tolerance
- Whether the air plug body is to be finished without or with PVD coating

Application:

- Measurement of blind holes

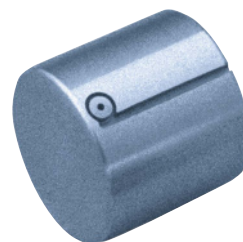

TECHNICAL DATA

Order no.	Type	Nominal size	Nominal size	Model	Magnification	Measuring span	Compatibility	Con-nection thread	Minimum bore length	Including handle
		mm	inch			µm			mm	
2115007	DP20	3.000	.118	hardened steel	5000:1, 2500:1, 1260:1	13 –25 (DP20) 25 –51 (DP50) 51 –102 (DP60) depending on diameter	Federal	3/8"–32	6.35	
	DP50	–6.000	–.236"							
	DP60									
2115007PVD	DP20	3.000	.118	PVD coated based on AlCrN	5000:1, 2500:1, 1260:1	13 –25 (DP20) 25 –51 (DP50) 51 –102 (DP60) depending on diameter	Federal	3/8"–32	6.35	
	DP50	–6.000	–.236"							
	DP60									
2115008	DP20	6.000	.236	hardened steel	5000:1, 2500:1, 1260:1	38 (DP20) 76 (DP50) 152 (DP60)	Federal	3/8"–32	6.35	
	DP50	–10.000	–.394"							
	DP60									
2115008PVD	DP20	6.000	.236	PVD coated based on AlCrN	5000:1, 2500:1, 1260:1	38 (DP20) 76 (DP50) 152 (DP60)	Federal	3/8"–32	6.35	
	DP50	–10.000	–.394"							
	DP60									
2115009	DP20	10.000	.394	hardened steel	5000:1, 2500:1, 1260:1	38 (DP20) 76 (DP50) 152 (DP60)	Federal	3/8"–32	6.35	
	DP50	–13.000	–.512"							
	DP60									
2115009PVD	DP20	10.000	.394	PVD coated based on AlCrN	5000:1, 2500:1, 1260:1	38 (DP20) 76 (DP50) 152 (DP60)	Federal	3/8"–32	6.35	
	DP50	–13.000	–.512"							
	DP60									
2115010	DP20	13.000	.512	hardened steel	5000:1, 2500:1, 1260:1	38 (DP20) 76 (DP50) 152 (DP60)	Federal	3/8"–32	6.35	
	DP50	–15.000	–.590"							
	DP60									
2115010PVD	DP20	13.000	.512	PVD coated based on AlCrN	5000:1, 2500:1, 1260:1	38 (DP20) 76 (DP50) 152 (DP60)	Federal	3/8"–32	6.35	
	DP50	–15.000	–.590"							
	DP60									
2115011	DP20	15.000	.590	hardened steel	5000:1, 2500:1, 1260:1	38 (DP20) 76 (DP50) 152 (DP60)	Federal	3/8"–32	6.35	
	DP50	–40.000	–1.575"							
	DP60									
2115011PVD	DP20	15.000	.590	PVD coated based on AlCrN	5000:1, 2500:1, 1260:1	38 (DP20) 76 (DP50) 152 (DP60)	Federal	3/8"–32	6.35	
	DP50	–40.000	–1.575"							
	DP60									
2115012	DP20	40.000	1.575	hardened steel	5000:1, 2500:1, 1260:1	38 (DP20) 76 (DP50) 152 (DP60)	Federal	3/8"–32	6.35	
	DP50	–60.000	–2.362"							
	DP60									
2115012PVD	DP20	40.000	1.575	PVD coated based on AlCrN	5000:1, 2500:1, 1260:1	38 (DP20) 76 (DP50) 152 (DP60)	Federal	3/8"–32	6.35	
	DP50	–60.000	–2.362"							
	DP60									
2115013	DP20	60.000	2.362	hardened steel	5000:1, 2500:1, 1260:1	38 (DP20) 76 (DP50) 152 (DP60)	Federal	3/8"–32	6.35	
	DP50	–75.000	–2.953"							
	DP60									
2115013PVD	DP20	60.000	2.362	PVD coated based on AlCrN	5000:1, 2500:1, 1260:1	38 (DP20) 76 (DP50) 152 (DP60)	Federal	3/8"–32	6.35	
	DP50	–75.000	–2.953"							
	DP60									
2115030	DP20	75.000	2.953	hardened steel	5000:1, 2500:1, 1260:1	38 (DP20) 76 (DP50) 152 (DP60)	Federal	3/8"–32	6.35	•
	DP50	–90.000	–3.543"							
	DP60									
2115030PVD	DP20	75.000	2.953	PVD coated based on AlCrN	5000:1, 2500:1, 1260:1	38 (DP20) 76 (DP50) 152 (DP60)	Federal	3/8"–32	6.35	•
	DP50	–90.000	–3.543"							
	DP60									

Millimar DP20 / DP50 /DP60

2-jet blind-hole air plug gage

Order no.	Type	Nominal size		Model	Magnification	Measuring span	Compatibility	Connection thread	Minimum bore length	Including handle
		mm	inch							
2115031	DP20	90.000	3.543	hardened steel	5000:1, 2500:1, 1260:1	38 (DP20) 76 (DP50) 152 (DP60)	Federal	3/8"-32	6.35	•
	DP50	-100.000	-3.937"							
	DP60									
2115031PVD	DP20	90.000	3.543	PVD coated based on AlCrN	5000:1, 2500:1, 1260:1	38 (DP20) 76 (DP50) 152 (DP60)	Federal	3/8"-32	6.35	•
	DP50	-100.000	-3.937"							
	DP60									
2115032	DP20	100.000	3.937	hardened steel	5000:1, 2500:1, 1260:1	38 (DP20) 76 (DP50) 152 (DP60)	Federal	3/8"-32	6.35	•
	DP50	-115.000	-4.528"							
	DP60									
2115032PVD	DP20	100.000	3.937	PVD coated based on AlCrN	5000:1, 2500:1, 1260:1	38 (DP20) 76 (DP50) 152 (DP60)	Federal	3/8"-32	6.35	•
	DP50	-115.000	-4.528"							
	DP60									

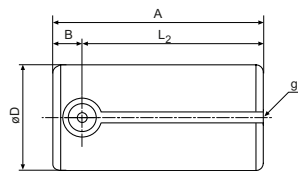

Order no.	A	B	L ₂	Nominal size	Nominal size	Connection thread
	mm	mm	mm	mm	inch	
2115007	29.4	4.00	25.4	3.000-6.000	.118-.236"	3/8"-32
2115007PVD	29.4	4.00	25.4	3.000-6.000	.118-.236"	3/8"-32
2115008	29.4	4.00	25.4	6.000-10.000	.236-.394"	3/8"-32
2115008PVD	29.4	4.00	25.4	6.000-10.000	.236-.394"	3/8"-32
2115009	29.4	4.00	25.4	10.000-13.000	.394-.512"	3/8"-32
2115009PVD	29.4	4.00	25.4	10.000-13.000	.394-.512"	3/8"-32
2115010	29.4	4.00	25.4	13.000-15.000	.512-.590"	3/8"-32
2115010PVD	29.4	4.00	25.4	13.000-15.000	.512-.590"	3/8"-32
2115011	29.4	4.00	25.4	15.000-40.000	.590-1.575"	3/8"-32
2115011PVD	29.4	4.00	25.4	15.000-40.000	.590-1.575"	3/8"-32
2115012	29.4	4.00	25.4	40.000-60.000	1.575-2.362"	3/8"-32
2115012PVD	29.4	4.00	25.4	40.000-60.000	1.575-2.362"	3/8"-32
2115013	29.4	4.00	25.4	60.000-75.000	2.362-2.953"	3/8"-32
2115013PVD	29.4	4.00	25.4	60.000-75.000	2.362-2.953"	3/8"-32
2115030	29.4	4.00	25.4	75.000-90.000	2.953-3.543"	3/8"-32
2115030PVD	29.4	4.00	25.4	75.000-90.000	2.953-3.543"	3/8"-32
2115031	29.4	4.00	25.4	90.000-100.000	3.543-3.937"	3/8"-32
2115031PVD	29.4	4.00	25.4	90.000-100.000	3.543-3.937"	3/8"-32
2115032	29.4	4.00	25.4	100.000-115.000	3.937-4.528"	3/8"-32
2115032PVD	29.4	4.00	25.4	100.000-115.000	3.937-4.528"	3/8"-32

ACCESSORIES

Order no.	Description	Type	Connection thread
2260835	Connecting hose set, complete, 2 m		3/8"-32
2261280	Connecting hose set, complete, 4 m		3/8"-32
2202010	Extension for nominal sizes up to 76.3 mm, D = 12 mm, L = 102 mm	AHA-4	3/8"-32
2202011	Extension for nominal sizes up to 76.3 mm, D = 12 mm, L = 51 mm	AHA-5	3/8"-32
2237666	Standard plastic handle		3/8"-32
2237873	Depth stop ring for Mahr nozzle plug gage		
2239307	Universal bench mount		3/8"-32
2240993	Shut off slide valve		3/8"-32

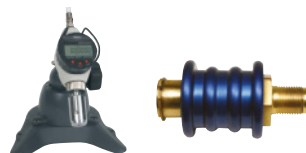

Millimar DR50 / DR20

2-jet air ring gage

FEATURES

- Mahr / Mahr Federal nozzle ring gages have a large clearance tolerance. This allows larger measuring ranges and the workpiece can be inserted more easily into the nozzle ring for measuring.
- Due to a larger plug gage spacing and (optional) hard chrome-plated finish to the body, the nozzle ring gage has a long service life
- The recessed measuring nozzles are located deep in the body of the ring gage, protecting them from damage
- Large nozzle dimensions prevent clogging with dirt and oil
- **When ordering always specify:** Magnification of the display unit (e.g. 2500:1), nominal dimension to be measured and the specified workpiece tolerance



TECHNICAL DATA

Order no.	Type	Nominal size		Model	Magnification	Measuring span	Compati- bility
		mm	inch				
2093005	DR50	6.299 –7.592	.2480 –.3000	hardened steel	2500:1	76	Federal
2093006	DR50	7.595 –9.294	.3001 –.3650	hardened steel	2500:1	76	Federal
2093007	DR50	9.296 –13.002	.3651 –.5100	hardened steel	2500:1	76	Federal
2093008	DR50	13.005 –21.003	.5101 –.8250	hardened steel	2500:1	76	Federal
2093009	DR50	21.006 –25.400	.8251 –1.0000	hardened steel	2500:1	76	Federal
2093010	DR50	25.403 –38.351	1.0001 –1.5100	hardened steel	2500:1	76	Federal
2093011	DR50	38.354 –44.450	1.5101 –1.7500	hardened steel	2500:1	76	Federal
2093012	DR50	44.453 –50.797	1.75001 –2.0000	hardened steel	2500:1	76	Federal
2093013	DR50	50.800 –63.500	2.0001 –2.5000	hardened steel	2500:1	76	Federal
2093025	DR20	6.299 –7.592	.2480 –.3000	hardened steel	5000:1	38	Federal
2093026	DR20	7.595 –9.294	.3001 –.3650	hardened steel	5000:1	38	Federal
2093027	DR20	9.296 –13.002	.3651 –.5100	hardened steel	5000:1	38	Federal
2093028	DR20	13.005 –21.003	.5101 –.8250	hardened steel	5000:1	38	Federal
2093029	DR20	21.006 –25.400	.8251 –1.0000	hardened steel	5000:1	38	Federal
2093030	DR20	25.403 –38.351	1.0001 –1.5100	hardened steel	5000:1	38	Federal
2093031	DR20	38.354 –44.450	1.5101 –1.7500	hardened steel	5000:1	38	Federal
2093032	DR20	44.453 –50.797	1.75001 –2.0000	hardened steel	5000:1	38	Federal
2093033	DR20	50.800 –63.500	2.0001 –2.5000	hardened steel	5000:1	38	Federal

Order no.	B	D	Nominal size	
	mm	mm	mm	inch
2093005	25.40	76,2	6.299 –7.592	.2480 –.3000
2093006	25.40	76,2	7.595 –9.294	.3001 –.3650
2093007	25.40	76,2	9.296 –13.002	.3651 –.5100
2093008	25.40	76,2	13.005 –21.003	.5101 –.8250
2093009	25.40	76,2	21.006 –25.400	.8251 –1.0000
2093010	25.40	101.6	25.403 –38.351	1.0001 –1.5100
2093011	25.40	101.6	38.354 –44.450	1.5101 –1.7500
2093012	25.40	127	44.453 –50.797	1.75001 –2.0000
2093013	25.40	127	50.800 –63.500	2.0001 –2.5000
2093025	25.40	76,2	6.299 –7.592	.2480 –.3000
2093026	25.40	76,2	7.595 –9.294	.3001 –.3650
2093027	25.40	76,2	9.296 –13.002	.3651 –.5100
2093028	25.40	76,2	13.005 –21.003	.5101 –.8250
2093029	25.40	76,2	21.006 –25.400	.8251 –1.0000
2093030	25.40	101.6	25.403 –38.351	1.0001 –1.5100
2093031	25.40	101.6	38.354 –44.450	1.5101 –1.7500
2093032	25.40	127	44.453 –50.797	1.75001 –2.0000
2093033	25.40	127	50.800 –63.500	2.0001 –2.5000

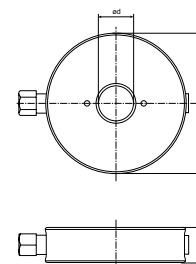

ACCESSORIES

Order no.	Description	Connection thread
2260835	Connecting hose set, complete, 2 m	3/8"–32
2237666	Standard plastic handle	3/8"–32
2240993	Shut off slide valve	3/8"–32
2239307	Universal bench mount	3/8"–32



Millimar DR50-3 / DR20-3

3-jet air ring gage

FEATURES

- Mahr / Mahr Federal nozzle ring gages have a large clearance tolerance. This allows larger measuring ranges and the workpiece can be inserted more easily into the nozzle ring for measuring.
- Due to a larger plug gage spacing and (optional) hard chrome-plated finish to the body, the nozzle ring gage has a long service life
- The recessed measuring nozzles are located deep in the body of the ring gage, protecting them from damage
- Large nozzle dimensions prevent clogging with dirt and oil
- **When ordering always specify:** Magnification of the display unit (e.g. 2500:1), nominal dimension to be measured and the specified workpiece tolerance



TECHNICAL DATA

Order no.	Type	Nominal size		Model	Magnification	Measuring span	Compatibility
		mm	inch				
2093015	DR50-3	6.299 - 7.592	.2480 - .3000	hardened steel	2500:1	76	Federal
2093016	DR50-3	7.595 - 9.294	.3001 - .3650	hardened steel	2500:1	76	Federal
2093017	DR50-3	9.296 - 13.002	.3651 - .5100	hardened steel	2500:1	76	Federal
2093018	DR50-3	13.005 - 21.003	.5101 - .8250	hardened steel	2500:1	76	Federal
2093019	DR50-3	21.006 - 25.400	.8251 - 1.0000	hardened steel	2500:1	76	Federal
2093020	DR50-3	25.403 - 38.351	1.0001 - 1.5100	hardened steel	2500:1	76	Federal
2093021	DR50-3	38.354 - 44.450	1.5101 - 1.7500	hardened steel	2500:1	76	Federal
2093022	DR50-3	44.453 - 50.797	1.75001 - 2.0000	hardened steel	2500:1	76	Federal
2093023	DR50-3	50.800 - 63.500	2.0001 - 2.5000	hardened steel	2500:1	76	Federal
2093035	DR20-3	6.299 - 7.592	.2480 - .3000	hardened steel	5000:1	38	Federal
2093036	DR20-3	7.595 - 9.294	.3001 - .3650	hardened steel	5000:1	38	Federal
2093037	DR20-3	9.296 - 13.002	.3651 - .5100	hardened steel	5000:1	38	Federal
2093038	DR20-3	13.005 - 21.003	.5101 - .8250	hardened steel	5000:1	38	Federal
2093039	DR20-3	21.006 - 25.400	.8251 - 1.0000	hardened steel	5000:1	38	Federal
2093040	DR20-3	25.403 - 38.351	1.0001 - 1.5100	hardened steel	5000:1	38	Federal
2093041	DR20-3	38.354 - 44.450	1.5101 - 1.7500	hardened steel	5000:1	38	Federal
2093042	DR20-3	44.453 - 50.797	1.75001 - 2.0000	hardened steel	5000:1	38	Federal
2093043	DR20-3	50.800 - 63.500	2.0001 - 2.5000	hardened steel	5000:1	38	Federal

Order no.	B		D		Nominal size	
	mm	mm	mm	mm	inch	mm
2093015	25.40	76.2	6.299	7.592	.2480 - .3000	6.299 - 7.592
2093016	25.40	76.2	7.595	9.294	.3001 - .3650	7.595 - 9.294
2093017	25.40	76.2	9.296	13.002	.3651 - .5100	9.296 - 13.002
2093018	25.40	76.2	13.005	21.003	.5101 - .8250	13.005 - 21.003
2093019	25.40	76.2	21.006	25.400	.8251 - 1.0000	21.006 - 25.400
2093020	25.40	101.6	25.403	38.351	1.0001 - 1.5100	25.403 - 38.351
2093021	25.40	101.6	38.354	44.450	1.5101 - 1.7500	38.354 - 44.450
2093022	25.40	127	44.453	50.797	1.75001 - 2.0000	44.453 - 50.797
2093023	25.40	127	50.800	63.500	2.0001 - 2.5000	50.800 - 63.500
2093035	25.40	76.2	6.299	7.592	.2480 - .3000	6.299 - 7.592
2093036	25.40	76.2	7.595	9.294	.3001 - .3650	7.595 - 9.294
2093037	25.40	76.2	9.296	13.002	.3651 - .5100	9.296 - 13.002
2093038	25.40	76.2	13.005	21.003	.5101 - .8250	13.005 - 21.003
2093039	25.40	76.2	21.006	25.400	.8251 - 1.0000	21.006 - 25.400
2093040	25.40	101.6	25.403	38.351	1.0001 - 1.5100	25.403 - 38.351
2093041	25.40	101.6	38.354	44.450	1.5101 - 1.7500	38.354 - 44.450
2093042	25.40	127	44.453	50.797	1.75001 - 2.0000	44.453 - 50.797
2093043	25.40	127	50.800	63.500	2.0001 - 2.5000	50.800 - 63.500

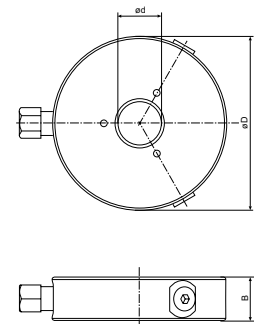

ACCESSORIES

Order no.	Description	Connection thread
2237666	Standard plastic handle	3/8"-32
2239307	Universal bench mount	3/8"-32
2240993	Shut off slide valve	3/8"-32
2260835	Connecting hose set, complete, 2 m	3/8"-32



Millimar AAT-19 / AAT-20

Single jet probe

FEATURES

- Jet probes provide convenient modular gageheads for use in handheld gages and for designing gage fixtures
- 9.5 mm / .375" bodies provide standardized mounting configurations
- Compact size allows easy access to hard-to-reach dimensions
- Jet probes are calibrated for instant use with Dimensionair® systems - just set zero and measure!
- Available in single-probe and matched-probe configurations
- Jet probes are similar to air probes, except they have an open jet at the end instead of a contacting spindle
- Ideal for measuring flatness of surfaces which cannot be touched, or for building into fixture designs where air gaging is called for
- Can be used with 2500:1, 5000:1 Dimensionair® (supplied singly or in matched pairs)
- Supplied with AHO-1 air hose, a zero setting valve, and hardware for mounting to the Dimensionair



TECHNICAL DATA

Order no.	2086612	2086613
Type	AAT-19	AAT-20
Magnification	2500:1	
Design	Single jet probe	Matched jet probe pair

Millimar 6105 N

Master setting rings

FEATURES

- Meticulously hardened, aged, ground and lapped
- Manufacturing tolerance JS3
- Uncertainty of the labeled actual size: 0.5 x IT1
- Setting of pneumatic measuring instruments (nozzle plug gages)
- **Order information:** It is recommended you use the average tolerance of the specified workpiece tolerance as the nominal diameter of the master setting ring



TECHNICAL DATA

Order no.	Ø	Cylindricity tolerance
2105300	2 -3	0.1 x IT4
2105301	3.001 -4	0.1 x IT4
2105302	4.001 -6	0.1 x IT4
2105303	6.001 -7	0.1 x IT4
2105304	7.001 -10	0.1 x IT4
2105305	10.001 -11	0.1 x IT4
2105306	11.001 -18	0.1 x IT4
2105307	18.001 -21	0.1 x IT4
2105308	21.001 -28	0.1 x IT4
2105309	28.001 -32	0.1 x IT4
2105310	32.001 -40	0.1 x IT4
2105311	40.001 -47	0.1 x IT4
2105312	47.001 -50	0.1 x IT4
2105313	50.001 -55	0.1 x IT4
2105314	55.001 -58	0.1 x IT4
2105315	58.001 -60	0.1 x IT4
2105316	60.001 -65	0.1 x IT4
2105317	65.001 -68	0.1 x IT4
2105318	68.001 -70	0.1 x IT4
2105319	70.001 -72	0.1 x IT4
2105320	72.001 -75	0.1 x IT4
2105321	75.001 -78	0.1 x IT4
2105322	78.001 -80	0.1 x IT4
2105323	80.001 -82	0.1 x IT4
2105324	82.001 -85	0.1 x IT4
2105325	85.001 -88	0.1 x IT4
2105326	88.001 -90	0.1 x IT4
2105327	90.001 -92	0.1 x IT4
2105328	92.001 -95	0.1 x IT4
2105329	95.001 -98	0.1 x IT4
2105330	98.001 -100	0.1 x IT4
2105331	100.001 -105	0.1 x IT4
2105332	105.001 -110	0.1 x IT4
2105333	110.001 -115	0.1 x IT4
2105334	115.001 -120	0.1 x IT4
2105335	120.001 -125	0.1 x IT4
2105336	125.001 -130	0.1 x IT4
2105337	130.001 -135	0.1 x IT4
2105338	135.001 -140	0.1 x IT4
2105339	140.001 -145	0.1 x IT4
2105340	145.001 -150	0.1 x IT4
2105341	150.001 -155	0.1 x IT4
2105342	155.001 -160	0.1 x IT4
2105343	160.001 -165	0.1 x IT4
2105344	165.001 -170	0.1 x IT4
2105345	170.001 -175	0.1 x IT4
2105346	175.001 -180	0.1 x IT4
2105347	180.001 -185	0.1 x IT4

Millimar 6107 S

Master setting rings

FEATURES

- Meticulously hardened, aged, ground and lapped
- Manufacturing tolerance JS3
- Uncertainty of the labeled actual size: 0.5 x IT1
- Setting of pneumatic measuring instruments (nozzle plug gages)
- **Order information:** It is recommended you use the average tolerance of the specified workpiece tolerance as the nominal diameter of the master setting ring



TECHNICAL DATA

Order no.	Ø	Cylindricity tolerance
2105400	3 -4	0.1 x IT3
2105401	4.001 -6	0.1 x IT3
2105402	6.001 -8	0.1 x IT3
2105403	8.001 -10	0.1 x IT3
2105404	10.001 -18	0.1 x IT3
2105405	18.001 -23	0.1 x IT3
2105406	23.001 -24	0.1 x IT3
2105407	24.001 -25	0.1 x IT3
2105408	25.001 -26	0.1 x IT3
2105409	26.001 -27	0.1 x IT3
2105410	27.001 -28	0.1 x IT3
2105411	28.001 -30	0.1 x IT3
2105412	30.001 -32	0.1 x IT3
2105413	32.001 -34	0.1 x IT3
2105414	34.001 -37	0.1 x IT3
2105415	37.001 -42	0.1 x IT3
2105416	42.001 -44	0.1 x IT3
2105417	44.001 -45	0.1 x IT3
2105418	45.001 -46	0.1 x IT3
2105419	46.001 -48	0.1 x IT3
2105420	48.001 -50	0.1 x IT3
2105421	50.001 -52	0.1 x IT3
2105422	52.001 -55	0.1 x IT3
2105423	55.001 -58	0.1 x IT3
2105424	58.001 -60	0.1 x IT3
2105425	60.001 -62	0.1 x IT3
2105426	62.001 -65	0.1 x IT3
2105427	65.001 -68	0.1 x IT3
2105428	68.001 -70	0.1 x IT3
2105429	70.001 -72	0.1 x IT3
2105430	72.001 -75	0.1 x IT3
2105431	75.001 -78	0.1 x IT3
2105432	78.001 -80	0.1 x IT3
2105433	80.001 -82	0.1 x IT3
2105434	82.001 -85	0.1 x IT3
2105435	85.001 -88	0.1 x IT3
2105436	88.001 -90	0.1 x IT3
2105437	90.001 -92	0.1 x IT3
2105438	92.001 -95	0.1 x IT3
2105439	95.001 -98	0.1 x IT3
2105440	98.001 -100	0.1 x IT3
2105441	100.001 -102	0.1 x IT3

Millimar 6400

Master setting plugs

FEATURES

- Meticulously hardened, aged, ground and lapped
- Manufacturing tolerance JS3
- Uncertainty of the labeled actual size: 0.5 x IT1
- Setting of pneumatic measuring instruments (nozzle ring gages)
- **Order information:** It is recommended you use the average tolerance of the specified workpiece tolerance as the nominal diameter of the master setting ring



TECHNICAL DATA

Order no.	∅	Cylindricity tolerance
5264001	6.001 –12	0.1 x IT3
5264002	12.001 –18	0.1 x IT3
5264003	18.001 –24	0.1 x IT3
5264004	24.001 –30	0.1 x IT3
5264005	30.001 –35	0.1 x IT3
5264006	35.001 –40	0.1 x IT3
5264007	40.001 –45	0.1 x IT3
5264008	45.001 –50	0.1 x IT3
5264009	50.001 –55	0.1 x IT3
5264010	55.001 –60	0.1 x IT3
5264011	60.001 –65	0.1 x IT3
5264012	65.001 –70	0.1 x IT3
5264013	70.001 –75	0.1 x IT3
5264014	75.001 –80	0.1 x IT3
5264015	80.001 –85	0.1 x IT3
5264016	85.001 –90	0.1 x IT3
5264017	90.001 –95	0.1 x IT3
5264018	95.001 –100	0.1 x IT3
5264020	2 –3	0.1 x IT3
5264021	3.001 –4	0.1 x IT3
5264022	4.001 –6	0.1 x IT3

Millimar | Standard elements

Modular

The use of Millimar standard elements allows multi-gage measuring devices to be designed and implemented for the widest possible range of workpieces, e.g. rotationally symmetrical and non-rotationally symmetrical parts.

Rotationally symmetrical workpieces can be mounted between centers or on prismatic supports, whereas non-rotationally symmetrical workpieces often require a special holder.

Versatile

The versatility of the Millimar standard elements means that the right solution can be provided, regardless of the measurement task at hand.

Whether it's a question of external, internal or length measurements, the Millimar standard elements will be able to meet your requirements, even in the case of complex workpiece geometries.

Thanks to the space saving design of the styli, a high number of measuring points can be inspected within a small area of the testpiece.

The pneumatic lifting mechanisms integrated into the measuring elements simplify the job of moving the testpiece into the measuring position and reduce the amount of wear on the stylus.

Flexible

The modular concept using Millimar standard elements is continued throughout the construction of the whole system. A generous amount of travel in the stylus (up to 20 mm / 0.79") allows a high degree of flexibility in terms of the variety of testpieces that can be accommodated.

Precise

The Millimar standard elements are specially designed for use in the workshop and are manufactured using a rigorous process. This guarantees that the measuring devices give stable and reliable measurements.

For example, using styli fitted with two ball-bearing guides for supporting the moving part, it is possible to achieve measurement accuracy at the μm scale, if this is required due to the tolerances of the feature being measured.

Reliable

All components are long lasting and low maintenance thanks to the use of rust proof materials, the selection of appropriate heat treatments, and the use of a lifting mechanism to minimize the effects of friction acting on the styli when the workpiece is inserted.

Economical

Our systems can either be constructed by the customer from standard elements obtained from the catalog, or alternatively we can provide ready-built devices as turn-key solutions. Whichever option you choose, you can be sure that you are purchasing a system that is tailored to your specific requirements on the most favorable of terms.

Below are just a few examples of the many factors that contribute to the cost effectiveness of the Millimar standard elements:

- Reusability of standard elements: Once manufacture of a particular type of workpiece has ceased, all standard elements used in the test equipment can be reused for a different type of workpiece.
- A choice of different mechanisms for guiding the moving part of the stylus, according to the accuracy requirements of the measuring task (optimal price-performance ratio).
- Reduction in development and implementation time.
- Availability of the equipment: Our standard elements are manufactured under standard production conditions and are always available off the shelf and ready to use.



Detailed information can be found in the catalog –
Components for Length Metrology

Millimar | Standard elements

Gage module

Travel distance: 5 - 10 - 20 mm

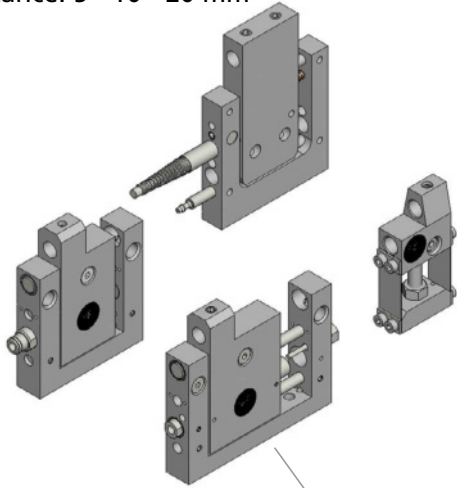

XY tables

Travel distance: 2.5 - 5 - 7 mm

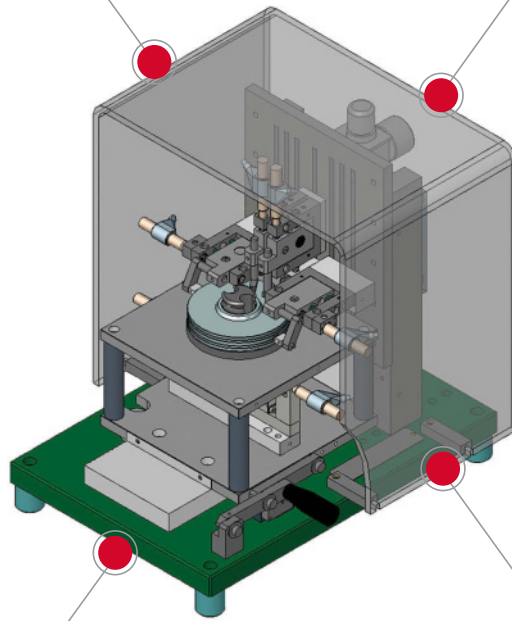
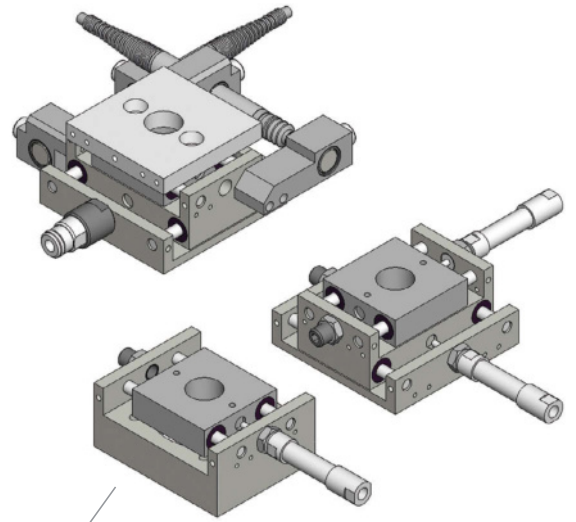

Angular adjustment
0 - 30 - 45 - 60 - 90°

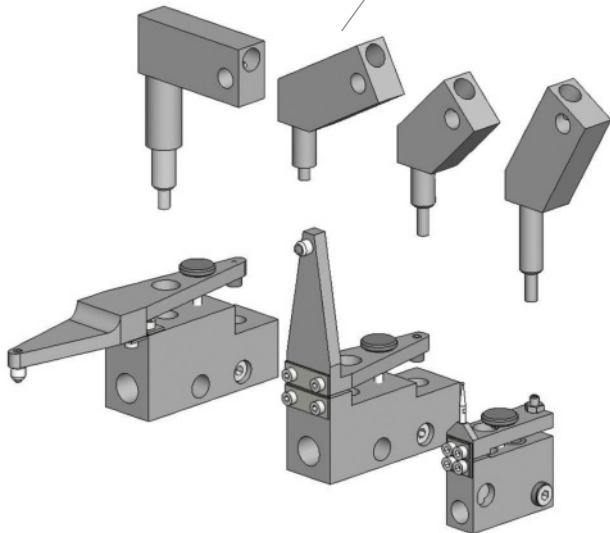

Styli

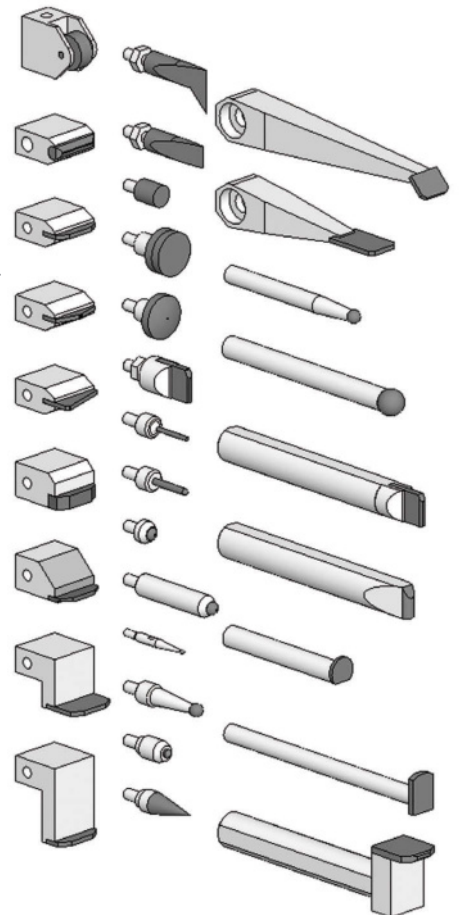

MarStand | Measuring tables, measuring tripods, radial runout gages

MarStand measuring stands, measuring tables and radial runout gages offer high stability, the basis for precise measuring results. They offer the necessary support for your dial indicators, dial comparators, dial test indicator measuring devices and measuring probes.



Measuring stands	
MarStand 815 GN	270
Measuring stand with triangular pedestal	
MarStand 815 MA / 815 MB / 815 P / 815 MG / 815 MF	271
Measuring tripod with magnetic base	
Indicator stand	
MarStand 815 XMA / 815 XMB / 815 XMS / 815 XN / 815 XP	276
With screw-in thread and/or t-slot nut	
Measuring tables	
MarStand 820 N	277
Small steel measuring table	
MarStand 820 NC / 820 FC	278
Small ceramic measuring table	
MarStand 820 NG / 820 FG	279
Small measuring table, granite measuring plate	
MarStand 821 NG / 821 FG	280
Large granite measuring table	
MarStand 824 FT / 824 GT	281
Heavy measuring table	
Measuring table systems	
MarStand 827	282
Heavy measuring table in the modular unit	
Test plates	
MarStand 107 G	284
Granite test plate	
Radial runout gages	
MarStand 818	287
Radial runout gage with center supports	
MarStand 818 P	288
Radial runout gage with vee supports	
MarStand 818 R	289
Radial runout gage with balancing supports	

MarStand 815 GN

Measuring tripod with triangular pedestal

FEATURES

- Sturdy base for stability and strength
- Convenient hand grip at the top of the base
- Structurally stable three-point support
- Stainless steel column and support arm
- Fine adjustment at support arm
- Display unit can be swiveled by $\pm 90^\circ$
- Easy to move without vibration
- Front of the base is ground to allow movement along edges and rulers
- Package excludes indicator



Application:

- For use on measuring and control plates

TECHNICAL DATA

Order no.		4413000	4413001	4413005	4413050	4413051	4413052
Type		815 GN					
Precision adjustment range	mm	2					
Total height	mm	300	500	750	300	500	750
Total height	inch	12"	20"	30"	12"	20"	30"
Projection (max.)	mm	185	200	230	185	200	230
Projection (max.)	inch	7.28"	7.87"	9.06"	7.28"	7.87"	9.06"
Mounting hole		8H7			.375"		
Product weight	kg	4.20	9.00	10.00	4.20	9.00	10.00

Order no.	Base surface	a	b	c	d
		mm	mm	mm	mm
4413000	150 x 150 mm	300	185	18	14
4413001	190 x 180 mm	500	200	25	18
4413005	190 x 180 mm	750	230	35	25
4413050	150 x 150 mm	300	185	18	14
4413051	190 x 180 mm	500	200	25	18
4413052	190 x 180 mm	750	230	35	25

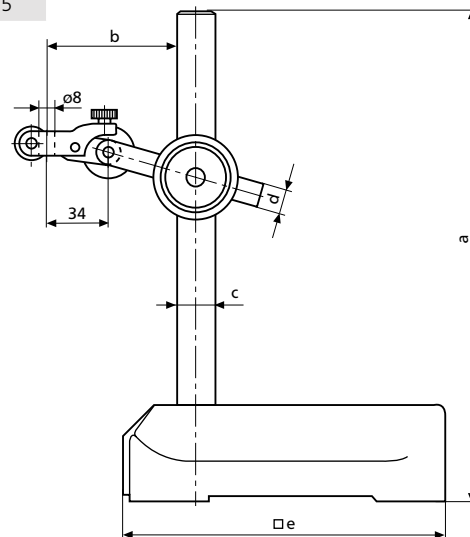

MarStand 815 MA

Measuring tripod with magnetic base

FEATURES

- Support arm with two joints
- Base has a powerful ON/OFF permanent magnet
- Magnetic force is active across:
 - Surfaces
 - V-shaped bottom
 - Front of base
- Post and support arm are made of stainless steel
- Support arm can be finely adjusted
- Package excludes indicator



TECHNICAL DATA

Order no.		4416000	4416050
Type			815 MA
Precision adjustment range	mm		2
Total height	mm		285
Total height	inch		11.2"
Projection (max.)	mm		230
Projection (max.)	inch		9.06"
Mounting hole		8H7	.375"
V-block for shaft diameter	mm		20 – 100
Adhesive force prism	N		450
Product weight	kg		2.50

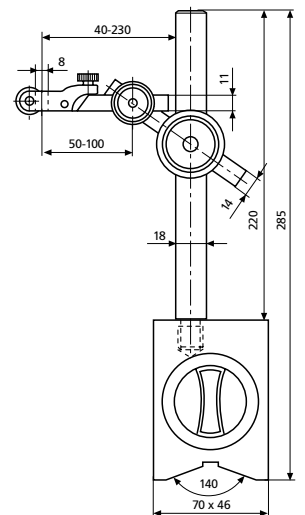

ACCESSORIES

Order no.	Description
4416001	Wooden case

MarStand 815 MB

Measuring tripod with magnetic base

FEATURES

- Support arm with one joint
- Base has a powerful ON/OFF permanent magnet
- Magnetic force is active across:
 - Surfaces
 - V-shaped bottom
 - Front of base
- Post and support arm are made of stainless steel
- Support arm can be finely adjusted
- Indicating instrument can be rotated through $\pm 90^\circ$
- Package excludes indicator



TECHNICAL DATA

Order no.		4417000	4417050
Type			815 MB
Precision adjustment range	mm		2
Total height	mm		285
Total height	inch		11.2"
Projection (max.)	mm		190
Projection (max.)	inch		7.48"
Mounting hole		8H7	.375"
V-block for shaft diameter	mm		20 – 100
Adhesive force prism	N		450
Product weight	kg		2.20

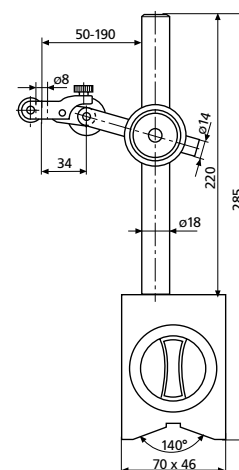

ACCESSORIES

Order no.	Description
4416001	Wooden case

MarStand 815 P

Measuring tripod with magnetic base

FEATURES

- Support arm has one joint
- Sturdy circular base with permanent magnet
- Post and support arm are made of stainless steel
- Support arm can be finely adjusted
- Indicating instrument can be rotated through $\pm 90^\circ$
- Package excludes indicator



TECHNICAL DATA

Order no.		4422000	4422050
Type			815 P
Precision adjustment range	mm		1.5
Total height	mm		205
Total height	inch		8"
Projection (max.)	mm		130
Projection (max.)	inch		5.12"
Mounting hole		8H7	.375"
Product weight	kg		0.70

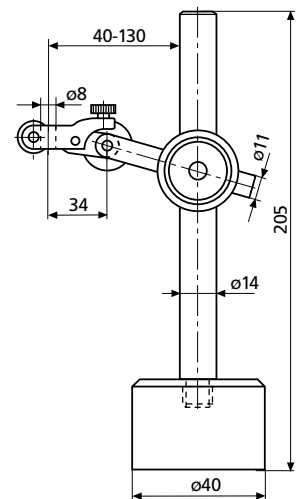

MarStand 815 MG

Measuring tripod with magnetic base

FEATURES

- 3D jointed arm, can reach any position within the operating range
- Easy positioning of all three joints with a securely fixed handle
- Maintenance-free mechanical clamping system
- Black anodized arm components made from high quality light alloy
- Dial indicator holder with 8 mm mounting bore and dovetail for dial test indicator measuring devices
- Fitted with zero-play micro-precision adjuster
- Very powerful switching magnet
- Package excludes indicator



TECHNICAL DATA

Order no.		4420350	4420360	4420370
Type			815 MG	
Precision adjustment range	mm	5		
Total height	mm	222	310	390
Total height	inch	8.74	12.2	15.35
Projection (max.)	mm	130	200	280
Projection (max.)	inch	5.12	7.87	11.02
Mounting hole		8H7		
V-block for shaft diameter	mm	6–120		
Adhesive force prism	N	300	800	

Order no.	Base surface	j	k	l	a	b	d
		mm	mm	mm	mm	mm	mm
4420350	36 x 30 x 35 mm	70	60	49	222	130	8
4420360	60 x 50 x 55 mm	120	80	49	310	200	8
4420370	60 x 50 x 55 mm	170	110	49	390	280	8

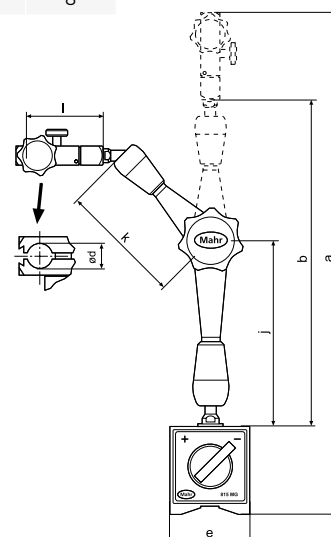

MarStand 815 MF

Measuring tripod with magnetic base

FEATURES

- 3D jointed arm, can reach any position within the operating range
- Easy positioning of all three joints with a securely fixed handle
- Very sturdy components, for excellent stability and accuracy
- Maintenance-free mechanical clamping system
- Black anodized arm components made from high quality light alloy
- Dial indicator holder with 8 mm mounting bore and dovetail for dial test indicator measuring devices
- Fitted with zero-play micro-precision adjuster
- Very easy to adjust, excellent repeatability
- Ideal for measuring instruments with μm resolution
- Very powerful switching magnet
- Package excludes indicator

Application:

- Special made for indicators and comparators with μm resolution

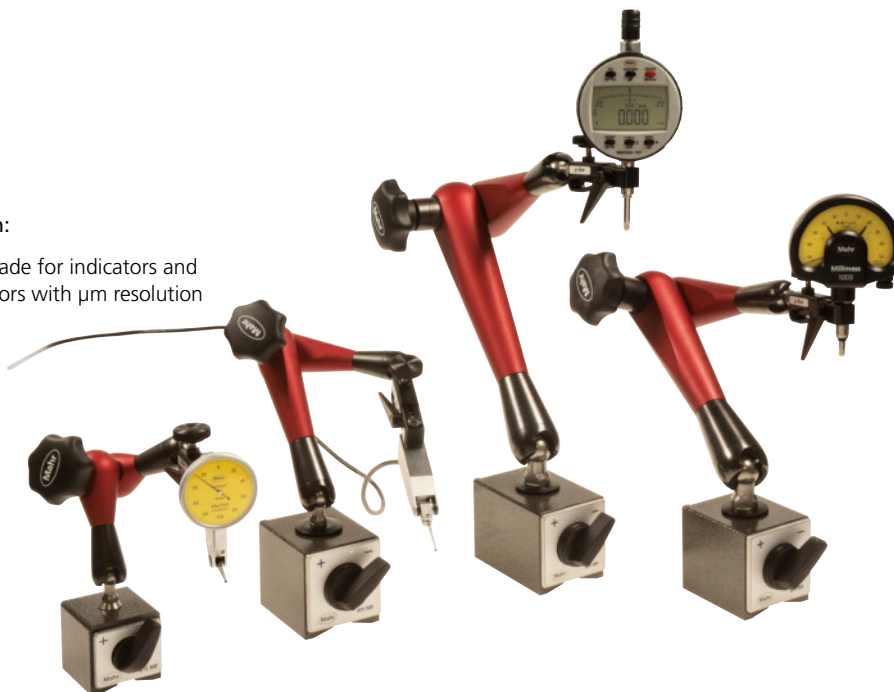

TECHNICAL DATA

Order no.		4420385	4420386	4420387	4420388
Type		815 MF			
Precision adjustment range	mm	2			
Total height	mm	228	317	399	444
Total height	inch	8.97	12.48	15.70	17.48
Projection (max.)	mm	130	204	287	330
Projection (max.)	inch	5.12	8.03	11.3	12.99
Mounting hole		8H7			
V-block for shaft diameter	mm	6 – 120			
Adhesive force prism	N	300	800		1000

Order no.	Base surface	j	k	l	a	b	d
		mm	mm	mm	mm	mm	mm
4420385	40 x 40 x 40 mm	71	59	49	228	130	8
4420386	60 x 50 x 55 mm	116	88	49	317	204	8
4420387	60 x 50 x 55 mm	172	115	49	399	287	8
4420388	73 x 50 x 55 mm	201	129	49	444	330	8

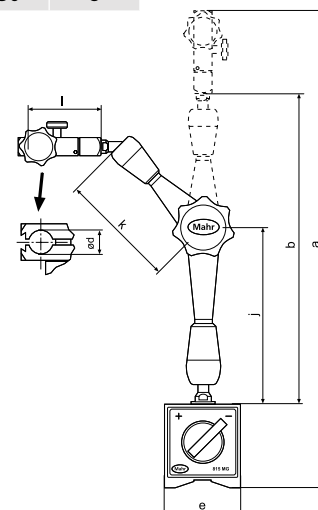

MarStand

Post and support assemblies

OVERVIEW

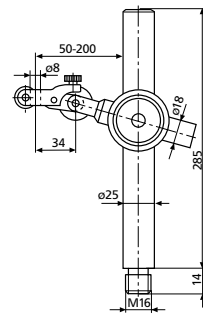
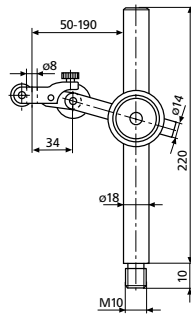
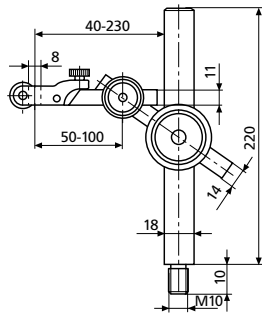

Type	815 XMA	815 XMB	815 XMS 285
Order no.	4424005	4424006	4435011
Product features	<ul style="list-style-type: none"> Sturdy design with mounting thread Two joints Post and support arm are made of stainless steel With fine adjustment 	<ul style="list-style-type: none"> Sturdy design with mounting thread One joint Post and support arm are made of stainless steel With fine adjustment 	<ul style="list-style-type: none"> Sturdy design with mounting thread One joint Post and support arm are made of stainless steel With fine adjustment

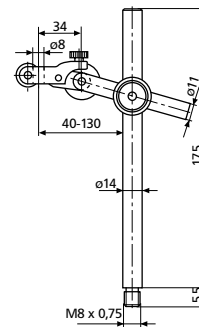
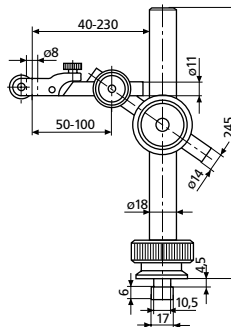
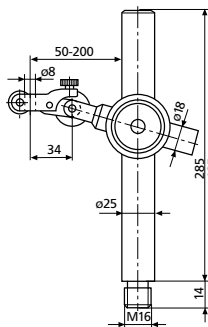

Type	815 XMS 485	815 XN	815 XP
Order no.	4435015	4424000	4424015
Product features	<ul style="list-style-type: none"> Exceptionally sturdy design with screw-in thread One joint Stainless steel column and cantilever arms Precision adjuster 	<ul style="list-style-type: none"> Sturdy design for mounting in a T-slot Two joints Knurled nut for clamping Post and support arm are made of stainless steel With fine adjustment 	<ul style="list-style-type: none"> Sturdy design with mounting thread One joint Post and support arm are made of stainless steel With fine adjustment

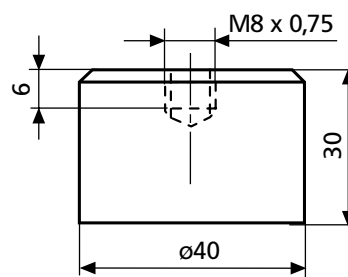
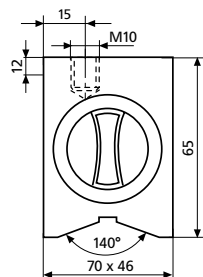

Type	815 YM	815 YP
Order no.	4425000	4425002
Product features	<p>Standard model</p> <ul style="list-style-type: none"> Powerful permanent magnet can be switched on and off Screw-in thread Bottom with V-groove End face is flat Magnetic force 450N 	<p>Round version</p> <ul style="list-style-type: none"> Permanent magnet plus threaded mounting hole Underside of the base is flat Magnetic force 250N

MarStand 820 N

Small steel comparator stand

FEATURES

- Stable design
- Table plate made of hardened steel
- Rugged, ground stainless steel column
- Adjustable support arm for indicating instrument
- Package excludes indicator



TECHNICAL DATA

Order no.		4430000	4430018
Type			820 N
Working range a	mm		0 – 110
Working range a	inch		0 – 4.3"
Grade			DIN 876/00
Flatness tolerance			$t_1 = 2 (1 + L/1000) \mu\text{m}$, L in mm
Mounting hole		8H7	3/8"
Product weight	kg		2.60

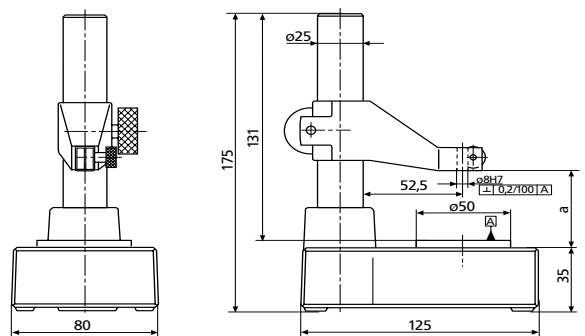

MarStand 820 NC / 820 FC

Small ceramic comparator stand

FEATURES

- Stable design
- Ceramic table plate (high hardness for lasting precision)
- Rugged, ground stainless steel column
- Adjustable support arm for indicating instrument
- Package excludes indicator



TECHNICAL DATA

Order no.		4432100	4432120	4433100	4433110
Type		820 NC		820 FC	
Working range a	mm	0 – 110			
Working range a	inch	0 – 4.3"			
Precision adjustment range	mm			0,4	
Grade		DIN 876/00			
Flatness tolerance		$t_f = 2 (1 + L/1000) \mu\text{m}$, L in mm			
Mounting hole		8H7	3/8"	8H7	3/8"
Product weight	kg	4.00			

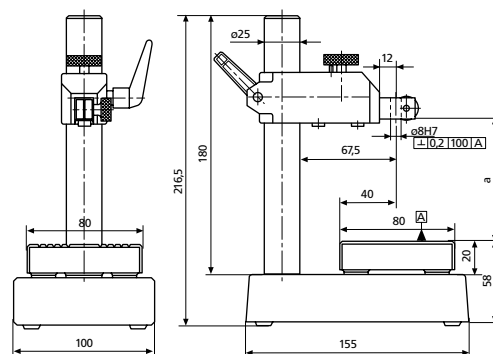

MarStand 820 NG / 820 FG

Small comparator stand, plate made of granite

FEATURES

- Stable design
- Table plate made of lapped black granite
- Rugged, ground stainless steel column
- Adjustable support arm for indicating instrument
- Package excludes indicator



TECHNICAL DATA

Order no.		4430100	4430110	4431100	4431110
Type		820 NG		820 FG	
Working range a	mm	0 – 130			
Working range a	inch	0 – 5.1"			
Precision adjustment range	mm			0,4	
Grade		DIN 876/0			
Flatness tolerance		$t_1 = 4 (1 + L/1000) \mu\text{m}$, L in mm			
Mounting hole		8H7	3/8"	8H7	3/8"
Product weight	kg	3.20			

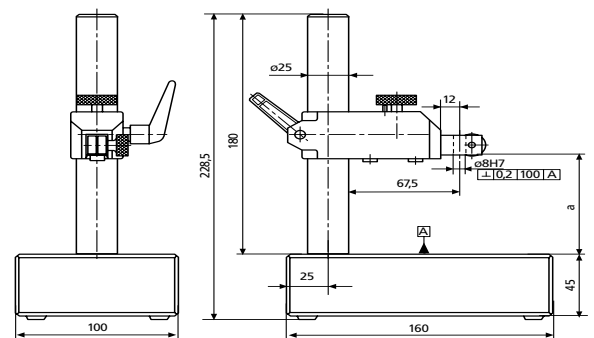

MarStand 821 NG / 821 FG

Large granite comparator stand

FEATURES

- Exceptionally stable design
- Table plate made of lapped black granite
- Heavy duty column and adjustable support arm for maximum stability
- Made of ground stainless steel
- Support arm fitted with fall brake
- Package excludes indicator



TECHNICAL DATA

Order no.	4435100	4435101	4435110	4435111	4435150	4435151	4435160	4435161
Type	821 NG	821 FG	821 NG	821 FG	821 NG	821 FG	821 NG	821 FG
Working range a	mm	0–250		0–430		0–250		0–430
Working range a	inch	0–10"		0–17"		0–10"		0–17"
Precision adjustment range	mm		0.4		0.4		0.4	
Grade		DIN 876/0						
Flatness tolerance		$t_1 = 4(1 + L/1000) \mu\text{m}$. L in mm						
Mounting hole		8H7			3/8"			
Product weight	kg	15.80		48.00		15.80		48.00

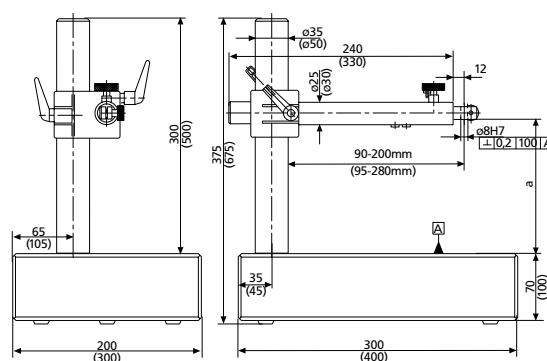

MarStand 824 FT / 824 GT

Heavy measuring table

FEATURES

- Sturdy, T-shaped base made from special cast iron
- Extremely stable
- Heavy duty column and support arm for maximum stability
- Support arm locked against rotation and height adjustable via rack
- **Models:**
 - 824 NT - without fine adjustment
 - 824 FT - with fine adjustment via parallel spring-loaded system
 - 824 GT - specially designed for the large Millimess dial comparator, with fine adjustment via the adapter bushing
- Package excludes indicator and plate



TECHNICAL DATA

Order no.		4443100	4443105	4444200
Type		824 FT		824 GT
Working range a	mm	0 – 210		0 – 200
Working range a	inch	0 – 8.2"		0 – 8.0"
Precision adjustment range	mm	0.4		3
Mounting hole		8H7	3/8"	28H7
Product weight	kg	19.00		18.00

ACCESSORIES

Order no.	Description	Type
4082731	Plate for single measurement (100 x 40 mm)	827 b 31
4082732	Plate for sum measurement (100 x 40 mm)	827 b 32
4082733	Plate for single measurement (130 x 130 mm)	827 b 33
4082734	Plate for sum measurement (130 x 130 mm)	827 b 34
4346111	941 G holder Ø 28mm, length 100mm, range 3 mm (with mount bore for indicators with shaft Ø 8 mm)	941 G / Ø 28 mm

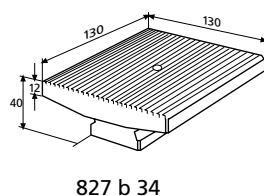
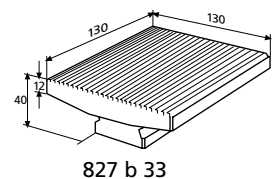
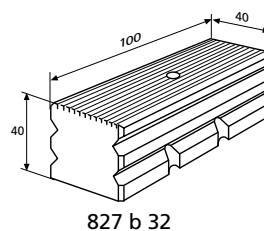
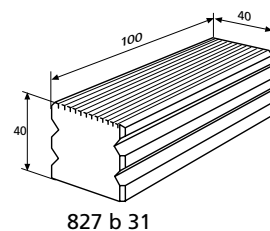

MarStand

Base with post

OVERVIEW

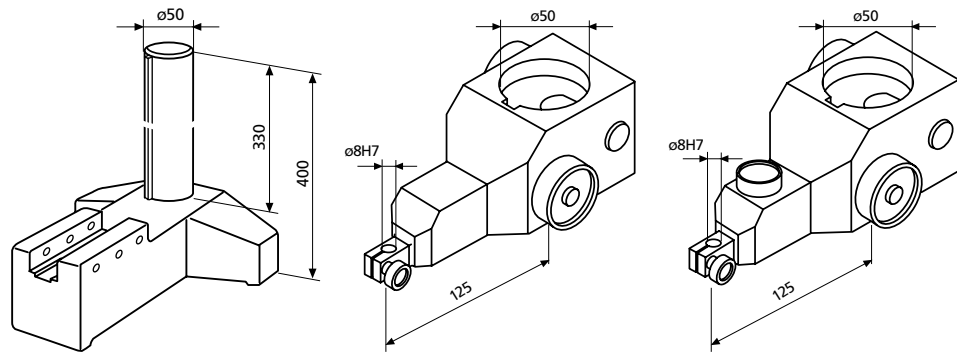

Type	827 b 5	827 b 16	827 b 17
Order no.	4082705	4082716	4082717
Product features	<ul style="list-style-type: none"> Measuring table base with column T-shaped base made from special cast iron Chrome-plated column 	<ul style="list-style-type: none"> Support arm without fine adjustment Rugged construction for exceptionally high bending resistance Locked against rotation and height adjustable via rack Mounting hole 8 mm 	<ul style="list-style-type: none"> Support arm with fine adjustment Rugged construction for exceptionally high bending resistance Locked against rotation and height adjustable via rack Mounting hole 8 mm
Projection (max.)	125 mm	125 mm	125 mm
Mounting hole		8H7	8H7

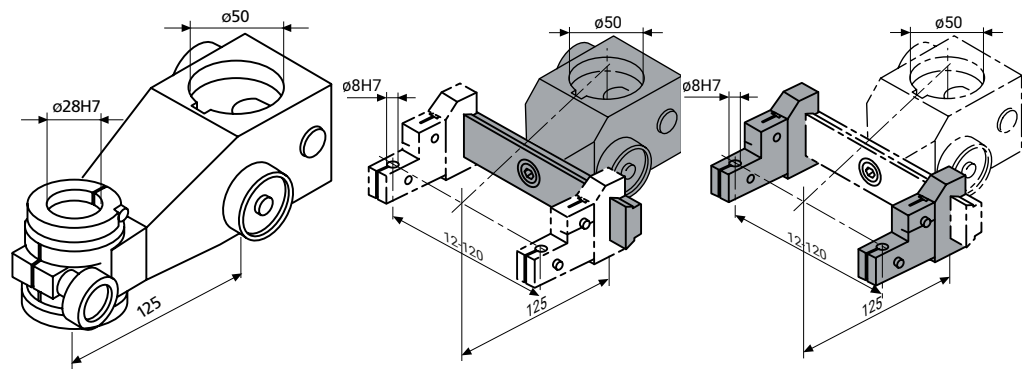

Type	827 b 18	827 b 19	827 b 14
Order no.	4082718	4082719	4082714
Product features	<ul style="list-style-type: none"> Support arm with fine adjustment Rugged construction for exceptionally high bending resistance Locked against rotation and height adjustable via rack Mounting hole for big comparators with stem diameter 28 mm, for example Millimes 1000 A 	<ul style="list-style-type: none"> Support arm with dovetail guide Rugged construction for exceptionally high bending resistance Locked against rotation and height adjustable via rack 	<ul style="list-style-type: none"> Probe holder For mounting on dovetail guide of support arm 827 b 19 Mounting hole 8 mm
Projection (max.)	125 mm	125 mm	125 mm
Mounting hole	28H7		8H7

MarStand

Plate for single measurement

OVERVIEW

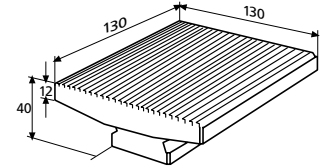
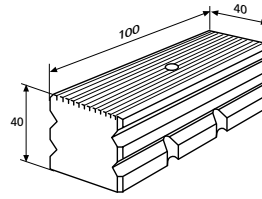
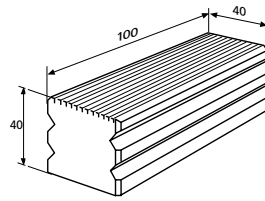

Type	827 b 31	827 b 32	827 b 33
Order no.	4082731	4082732	4082733
Product features	<ul style="list-style-type: none"> • Plate for single measurement • Hardened and lapped • Reversible • One measuring surface with longitudinal ribbing • Both sides face lapped 	<ul style="list-style-type: none"> • Plate for compound measurement • Hardened and lapped • With 8 mm mounting bore and clamping device for inductive probes • Measuring surface with longitudinal ribbing 	<ul style="list-style-type: none"> • Plate for single measurement • Hardened and lapped • Reversible • Large measuring surface with longitudinal ribbing • Both sides face lapped
Sum measurement		•	
Flatness deviation	1 µm	1 µm	1 µm
Mounting hole		8H7	

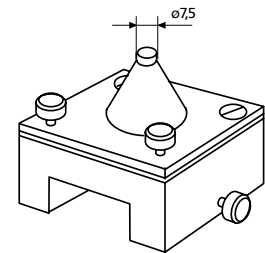
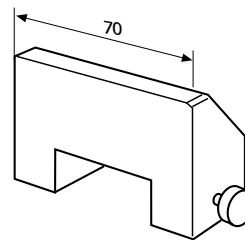
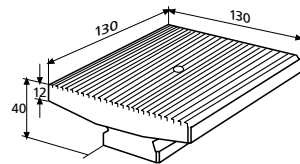

Type	827 b 34	827 b 35	827 b 36
Order no.	4082734	4082735	4082736
Product features	<ul style="list-style-type: none"> • Plate for compound measurement • Hardened and lapped • With 8 mm mounting bore and clamping device for inductive probes • Large measuring surface with longitudinal ribbing 	<ul style="list-style-type: none"> • Adjustable stop • Ensures that a workpiece is correctly positioned • To be attached to plates 827 b 31 and 827 b 32 	<ul style="list-style-type: none"> • Attachment stand • With adjustment screws for parallel alignment of 2 plan surfaces • Particularly suitable for mounting pin gages 426 M • To be attached to plates 827 b 31 and 827 b 32
Flatness deviation	1 µm		
Mounting hole	8H7		

MarStand 107 G

Surface plate made from granite

FEATURES

- Made of choice fine grain black granite (Diabase)
- High density structure is extremely homogeneous
- Hardness 6–7 on the Mohs hardness scale
- Surface plate is lapped and has a satin matt finish to prevent glare
- 100 % corrosion proof
- Non-magnetic and non-conductive
- Measuring instruments and test equipment easily slide over surface



Applications:

- For measuring tasks, layout work, touching up and lapping precision parts
- Recommended assembly (with optional accessories):
 - Up to 400 mm to be used on a workbench with adjustable plate supports 107 Asa
 - From 630 mm to be used with a stand 107 Us or cabinet 107 Ug

TECHNICAL DATA

Order no.	4221500	4221501	4221502	4221503	4221504	4221505	4221506	4221507	4221508		
Type	107 G										
Plate size	mm	400 x 250	400 x 400	630 x 400	630 x 630	800 x 500	1000 x 630	1200 x 800	1500 x 1000	2000 x 1000	
Plate thickness	mm	60		80		100		150		200	
Standard		DIN 876									
Tolerance class		00									
Flatness tolerance		$t_f = 2 (1 + L/1000) \mu\text{m}$, L in mm									
Weight	kg	18	29	60	95	120	190	432	675	1200	

ACCESSORIES

Order no.	Description	Type
4221560	Cabinet underframe with edge protection, 630 x 400 mm	107 Us
4221570	Open underframe with edge protection, 630 x 400 mm	107 Ug
4221069	Adjustable support element for test plates	107 Asa
4221561	Cabinet underframe with edge protection, 630 x 630 mm	107 Us
4221571	Open underframe with edge protection, 630 x 630 mm	107 Ug
4221562	Cabinet underframe with edge protection, 800 x 500 mm	107 Us
4221572	Open underframe with edge protection, 800 x 500 mm	107 Ug
4221563	Cabinet underframe with edge protection, 1000 x 630 mm	107 Us
4221573	Open underframe with edge protection, 1000 x 630 mm	107 Ug
4221564	Cabinet underframe with edge protection, 1200 x 800 mm	107 Us
4221574	Open underframe with edge protection, 1200 x 800 mm	107 Ug
4221565	Cabinet underframe with edge protection, 1500 x 1000 mm	107 Us
4221575	Open underframe with edge protection, 1500 x 1000 mm	107 Ug
4221566	Cabinet underframe with edge protection, 2000 x 1000 mm	107 Us
4221576	Open underframe with edge protection, 2000 x 1000 mm	107 Ug



107G + 107 US



107G + 107 UG

MarStand 107 G

Surface plate made from granite

FEATURES

- Made of choice fine grain black granite (Diabase)
- High density structure is extremely homogeneous
- Hardness 6–7 on the Mohs hardness scale
- Surface plate is lapped and has a satin matt finish to prevent glare
- 100 % corrosion proof
- Non-magnetic and non-conductive
- Measuring instruments and test equipment easily slide over surface



Applications:

- For measuring tasks, layout work, touching up and lapping precision parts
- Recommended assembly (with optional accessories):
 - Up to 400 mm to be used on a workbench with adjustable plate supports 107 Asa
 - From 630 mm to be used with a stand 107 Us or cabinet 107 Ug

TECHNICAL DATA

Order no.	4221520	4221521	4221522	4221523	4221524	4221525	4221526	4221527	4221528	
Type	107 G									
Plate size	mm	400 x 250	400 x 400	630 x 400	630 x 630	800 x 500	1000 x 630	1200 x 800	1500 x 1000	2000 x 1000
Plate thickness	mm	60		80		100		150		200
Standard	DIN 876									
Tolerance class	0									
Flatness tolerance	$t_1 = 4 (1 + L/1000) \mu\text{m}$, L in mm									
Weight	kg	18	29	60	95	120	190	432	675	1200

ACCESSORIES

Order no.	Description	Type
4221560	Cabinet underframe with edge protection, 630 x 400 mm	107 Us
4221570	Open underframe with edge protection, 630 x 400 mm	107 Ug
4221069	Adjustable support element for test plates	107 Asa
4221561	Cabinet underframe with edge protection, 630 x 630 mm	107 Us
4221571	Open underframe with edge protection, 630 x 630 mm	107 Ug
4221562	Cabinet underframe with edge protection, 800 x 500 mm	107 Us
4221572	Open underframe with edge protection, 800 x 500 mm	107 Ug
4221563	Cabinet underframe with edge protection, 1000 x 630 mm	107 Us
4221573	Open underframe with edge protection, 1000 x 630 mm	107 Ug
4221564	Cabinet underframe with edge protection, 1200 x 800 mm	107 Us
4221574	Open underframe with edge protection, 1200 x 800 mm	107 Ug
4221565	Cabinet underframe with edge protection, 1500 x 1000 mm	107 Us
4221575	Open underframe with edge protection, 1500 x 1000 mm	107 Ug
4221566	Cabinet underframe with edge protection, 2000 x 1000 mm	107 Us
4221576	Open underframe with edge protection, 2000 x 1000 mm	107 Ug



107G + 107 US



107G + 107 UG

MarStand 107 G

Surface plate made from granite

FEATURES

- Made of choice fine grain black granite (Diabase)
- High density structure is extremely homogeneous
- Hardness 6–7 on the Mohs hardness scale
- Surface plate is lapped and has a satin matt finish to prevent glare
- 100 % corrosion proof
- Non-magnetic and non-conductive
- Measuring instruments and test equipment easily slide over surface



Applications:

- For measuring tasks, layout work, touching up and lapping precision parts
- Recommended assembly (with optional accessories):
 - Up to 400 mm to be used on a workbench with adjustable plate supports 107 Asa
 - From 630 mm to be used with a stand 107 Us or cabinet 107 Ug

TECHNICAL DATA

Order no.	4221540	4221541	4221542	4221543	4221544	4221545	4221546	4221547	4221548	
Type	107 G									
Plate size	mm	400 x 250	400 x 400	630 x 400	630 x 630	800 x 500	1000 x 630	1200 x 800	1500 x 1000	2000 x 1000
Plate thickness	mm	60		80		100		150		200
Standard	DIN 876									
Tolerance class	1									
Flatness tolerance	$t_1 = 10 (1 + L/1000) \mu\text{m}$, L in mm									
Weight	kg	18	29	60	95	120	190	432	675	1200

ACCESSORIES

Order no.	Description	Type
4221560	Cabinet underframe with edge protection, 630 x 400 mm	107 Us
4221570	Open underframe with edge protection, 630 x 400 mm	107 Ug
4221069	Adjustable support element for test plates	107 Asa
4221561	Cabinet underframe with edge protection, 630 x 630 mm	107 Us
4221571	Open underframe with edge protection, 630 x 630 mm	107 Ug
4221562	Cabinet underframe with edge protection, 800 x 500 mm	107 Us
4221572	Open underframe with edge protection, 800 x 500 mm	107 Ug
4221563	Cabinet underframe with edge protection, 1000 x 630 mm	107 Us
4221573	Open underframe with edge protection, 1000 x 630 mm	107 Ug
4221564	Cabinet underframe with edge protection, 1200 x 800 mm	107 Us
4221574	Open underframe with edge protection, 1200 x 800 mm	107 Ug
4221565	Cabinet underframe with edge protection, 1500 x 1000 mm	107 Us
4221575	Open underframe with edge protection, 1500 x 1000 mm	107 Ug
4221566	Cabinet underframe with edge protection, 2000 x 1000 mm	107 Us
4221576	Open underframe with edge protection, 2000 x 1000 mm	107 Ug



107G + 107 US



107G + 107 UG

MarStand 818

Radial runout gage with center supports

FEATURES

Unit composed of:

Bench gage:

- Flatness of the surface is in accordance to DIN 876-2
- Two T-slots for tailstock and / or support arm

Support arm 818 XNB:

- Support arm with one joint
- With fine adjustment

Tailstocks:

- Both tailstocks can be relocated (slide into position)
- The tailstock on the right side has a retractable (spring actuated) precision aligned center
- The tailstocks have a peak of height of 75 mm with a 90° prism
- For workpieces without a center, utilizing support arms, the maximum diameter is 20 mm (0.79")
- **Package contains:** measuring bench, measuring arm 818 XNB, center supports, excludes indicator



Applications:

- Fast and easy radial runout testing between tips
- When measuring a shaft between tips, the reference axis for the radial runout measurement is usually identical to the rotational axis during production. A minimal radial runout deviation can therefore be expected during this test procedure.

TECHNICAL DATA

Order no.	4622200	4622201	4622202	4622203
Type	818			
Distance between centers	mm	0 – 200	0 – 350	0 – 450
Height of centers	mm	50	75	100
T-groove width	mm	10H7		12H7
Mounting hole		8H7		
Permitted height difference	mm	0.05		
Permitted lateral difference	mm	0.05		
Max. workpiece load per tailstock	kg	5		20
Product weight	kg	8.00	12.00	35.00

Order no.	A	L	d	Structural dimensions (L x W) mm	Column Ø	Column height
	mm	mm	mm	mm	mm	mm
4622200	200	350	16	350 x 110	18	205
4622201	350	500	16	500 x 110	18	205
4622202	450	700	22	700 x 180	18	260
4622203	450	700	22	700 x 180	18	360

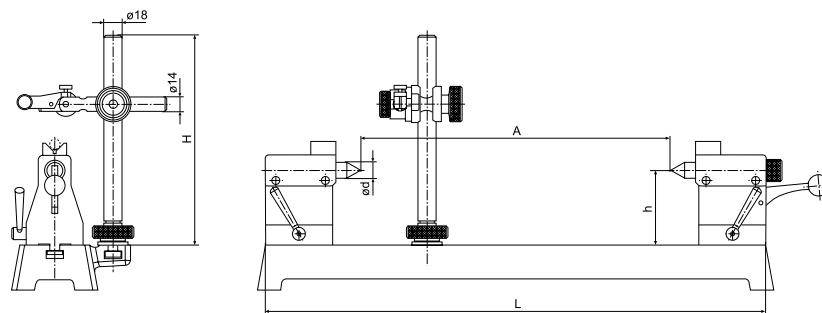

ACCESSORIES

Order no.	Description	Type
4622210	V-support anvils in pairs, diameter range 3 – 15 mm, suitable for peak height 50 / 75 mm	818 pe
4622275	Support arm, column height 205 mm, T-groove width 10 mm	818 XNB
4622220	Roller supports in pairs, diameter range 3 – 30 mm, T-groove width 10 mm	818 ab
4622215	V-support in pairs, diameter range 5 – 20 mm, T-groove width 10 mm	818 pb
4622276	Support arm, column height 260 mm, T-groove width 12 mm	818 XNB
4622211	V-support anvils in pairs, diameter range 8 – 45 mm, suitable for peak height 100 mm	818 pe
4622277	Support arm, column height 360 mm, T-groove width 12 mm	818 XNB
4622221	Roller supports in pairs, diameter range 4 – 60 mm, T-groove width 12 mm	818 ab
4622216	V-support in pairs, diameter range 5 – 45 mm, T-groove width 12 mm	818 pb



MarStand 818 P

Center bench with V-support

FEATURES

Unit composed of:

Bench gage:

- Flatness of the surface is in accordance to DIN 876/1
- Two T-slots for tailstock and / or support arm

Support arm 818 XNB:

- Support arm with one joint
- With fine adjustment

V-supports:

- Both V-supports can be relocated (slide into position)
- **Package contains:** measuring bench, measuring arm 818 XNB, V-supports, excludes indicator



Applications:

- Fast and easy radial runout testing of V-blocks
- Perfect for parts without a central bore
- During this test procedure, the reference axis is formed by the cylindricity (circumferential surface) of an actual bearing point, e.g. at a transmission shaft. Possible roundness deviations of the cylindrical surface are included in the radial runout measurement result in accordance with the V-angle.
- This test is thus more functional than measuring between the tips.

TECHNICAL DATA

Order no.	4622260	4622261	4622262	
Type	818 P			
Height of V-supports	mm	70	120	
Diameter range	mm	5 –20	5 –45	
T-groove width	mm	10H7	12H7	
Mounting hole	8H7			
Permitted height difference	mm	0.05		
Permitted lateral difference	mm	0.05		
Product weight	kg	6.50	9.50	30.00

Order no.	A	D	L	b	d	Structural dimensions (L x W) mm	Column Ø	Column height
	mm	mm	mm	mm	mm	mm	mm	mm
4622260	315	25	350	9,6	5	350 x 110	18	205
4622261	465	25	500	9,6	5	500 x 110	18	205
4622262	650	50	700	13,6	5	700 x 180	18	260

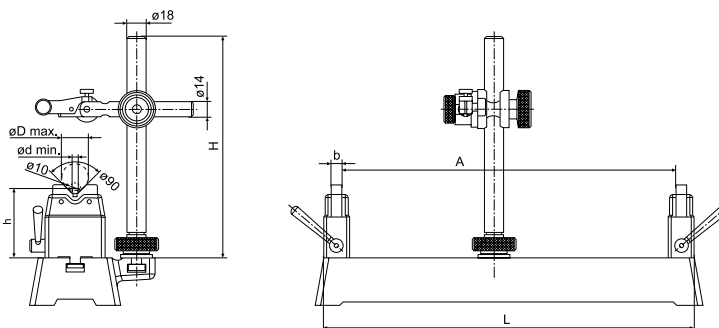

ACCESSORIES

Order no.	Description	Type
4622275	Support arm, column height 205 mm, T-groove width 10 mm	818 XNB
4622276	Support arm, column height 260 mm, T-groove width 12 mm	818 XNB
4622277	Support arm, column height 360 mm, T-groove width 12 mm	818 XNB

MarStand 818 R

Center bench with roller support

FEATURES

Unit composed of:

Bench gage:

- Flatness of the surface is in accordance to DIN 876/1
- Two T-slots for tailstock and / or support arm

Support arm 818 XNB:

- Support arm with one joint
- With fine adjustment

Roller supports:

- Both roller supports can be relocated (slide into position)
- **Package contains:** measuring bench, measuring arm 818 XNB, balancing supports, excludes indicator



Applications:

- Fast and easy radial runout testing of anti-friction bearing mounted rollers
- Perfect for smooth-running and seamless rotation of the workpiece, especially heavy parts without a central bore
- During this test procedure, the reference axis is formed by the cylindricity (circumferential surface) of an actual bearing point, e.g. at a transmission shaft. Possible roundness deviations of this cylindrical surface can be included in the radial runout measurement result in accordance with the surface angle.
- This test is thus more functional than measuring between the tips.

TECHNICAL DATA

Order no.	4622250	4622251	4622252	
Type	818 R			
Height of roller supports	mm	65	100	
Diameter range	mm	3 – 30	4 – 60	
T-groove width	mm	10H7	12H7	
Mounting hole	8H7			
Permissible radial runout deviation	µm	3	4	
Permitted height difference	mm	0.05		
Permitted lateral difference	mm	0.05		
Product weight	kg	6.50	9.50	30.00

Order no.	A	D	L	b	d	Structural dimensions (L x W) mm	Column Ø		Column height	
							mm	mm	mm	mm
4622250	315	25	350	8	3	350 x 110	18	18	205	205
4622251	465	25	500	8	3	500 x 110	18	18	205	205
4622252	650	50	700	12	5	700 x 180	18	18	260	260

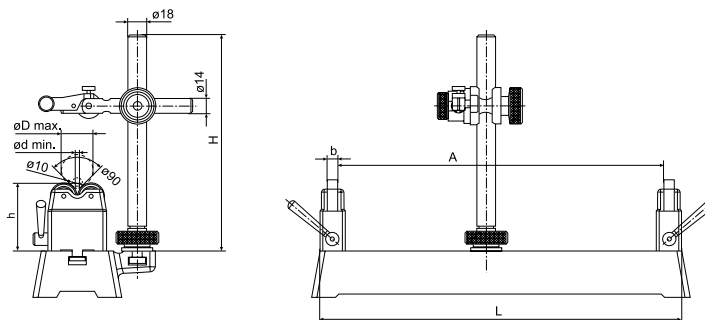

ACCESSORIES

Order no.	Description	Type
4622275	Support arm, column height 205 mm, T-groove width 10 mm	818 XNB
4622276	Support arm, column height 260 mm, T-groove width 12 mm	818 XNB
4622277	Support arm, column height 360 mm, T-groove width 12 mm	818 XNB

Marameter | Indicating measuring instruments

Marameter is the ideal instrument series for high-precision measurements of inside and outside diameters on individual and serial parts. These indicating measuring instruments obtain the best results due to their constant measuring force, accurate transmission mechanisms and the high parallelism of their measuring surfaces. Marameter also offers compelling solutions for special measuring tasks.



Indicating measuring instruments	
External dimensions, precision point snap gage overview	292
Marameter 840 F / 840 FC / 840 FH / 840 FG / 840 FM Indicating snap gages	294
Marameter 840 FS For precise measurements of large dimensions	301
Marameter E series For highly accurate workpieces	302
Marameter 300P / M-300P / OMI-300P / EDI-301P / EMD-301P / OMI-301P / 301P-series Indicating snap gage	305
Marameter 852 TS / 852 TZ / 852 / 853 For threads, thread tools, gears	314
Marameter portable thickness gages	320
Caliper gages	
Marameter 838 TAZ / 838 TA / 838 EA / 838 TI / 838 EI Outer and inner probe with digital and scale display	332
Comparative measuring instruments for inside dimensions	
Marameter 844 D Bore plug gages and accessories	338
Marameter Dimentron® plug gages	370
Marameter 844 K Self-centering inner measuring devices, sets and modular system	380
844 NB / 844 N / 844 NH Self-centering inner measuring devices	403

Marameter | Indicating snap gages 840 F / 840 FC

The Marameter 840 F / 840 FC indicating snap gages are ideal for highly accurate and reliable results on cylindrical workpieces with a narrow tolerance.

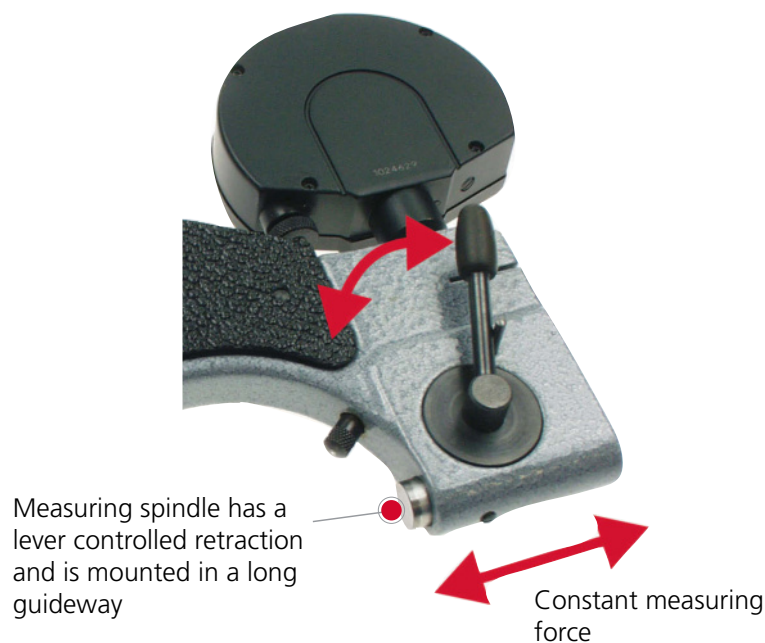
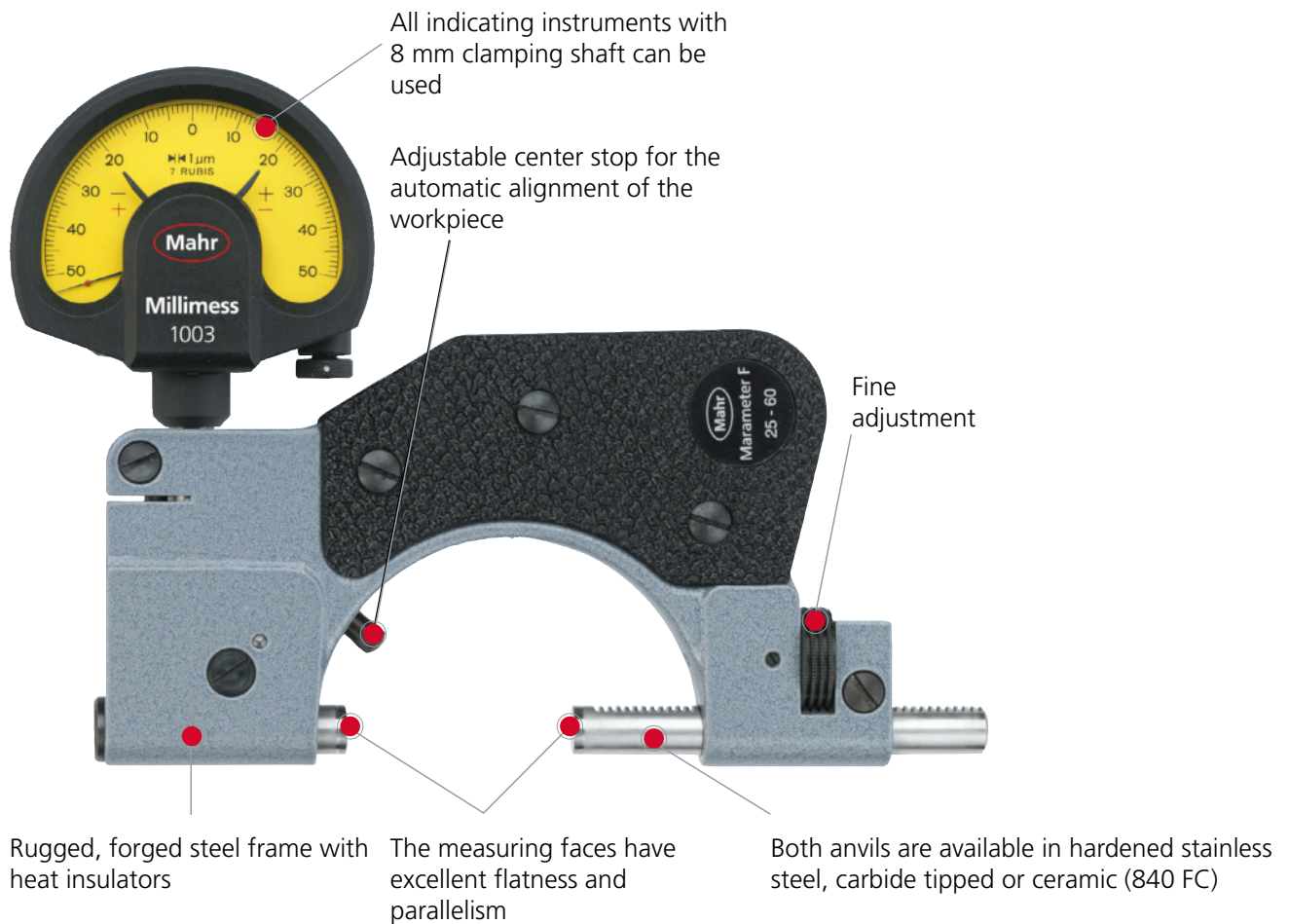

Marameter | Advantages of the 840 F snap gage compared to a micrometer

- Reduced measuring uncertainty

The Marameter indicating snap gages have a notably reduced measuring uncertainty in comparison to a micrometer.

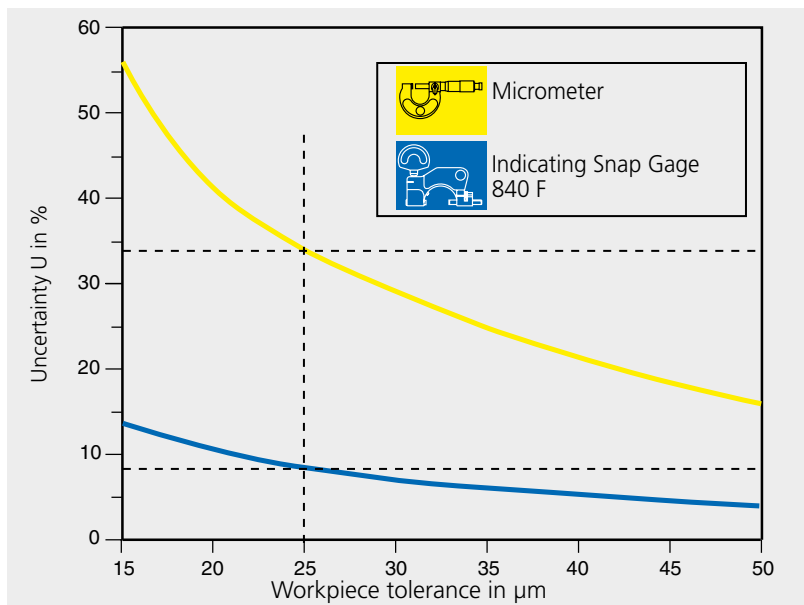

Measuring Uncertainty U is dependent upon the tolerance of the workpiece

- Better utilization of the tolerance zone

Example: Workpiece tolerance 25 µm

The measured value in the uncertainty range can lie outside of the tolerance range, therefore the utilized tolerance of the micrometer is reduced to only 32% (8 µm). With a Marameter 840 F indicating snap gage, 83% (20.8 µm) of the workpiece tolerance can be utilized.

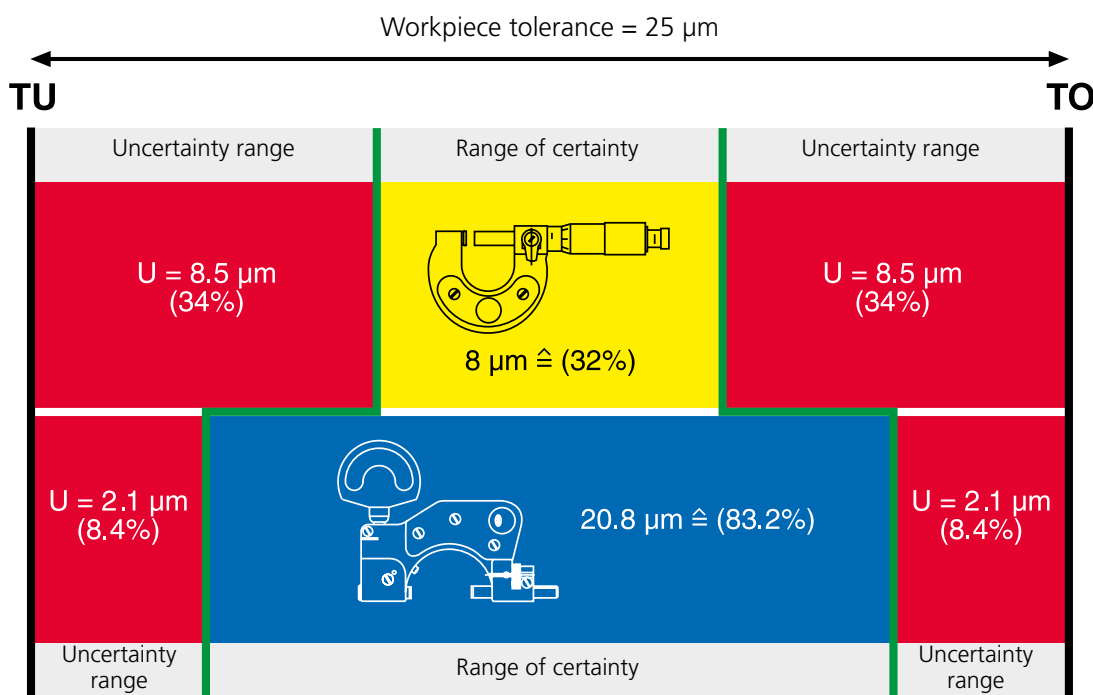

Advantage:

With the indicating snap gage the tolerance zone can be used to a far greater extent, thus reducing production costs.

Marameter 840 F

Indicating snap gage

FEATURES

- Rugged, forged steel frame with heat insulators
- Measuring spindle is mounted in long guideway with lever controlled retraction
- Measuring spindle and anvil are made of hardened stainless steel with carbide tipped measuring faces
- Adjustable centering stop for surface centering
- Anvil spindle can easily be fine adjusted
- Constant measuring force as a result of built-in spring, eliminating user influence
- Maximum wear resistance due to noncontact positioning in conjunction with carbide tipped measuring faces
- **Package contains:** flat contact point 903 (steel), instruction manual, wooden case, excludes indicator



Applications:

- For cylindrical parts such as shafts, bolts and spindles
- For thickness and length measurements
- Universally applicable and extremely versatile
 - Each instrument spans a broad measuring range
 - Any dimension and fit can be very quickly and easily adjusted

TECHNICAL DATA

Order no.	Type	Applica- tion range		Measuring span	Parallelism	Flatness	Repeata- bility f_w	Measuring force	Frame size
		mm	inch		deviation	deviation			
4450000	840 F	0 – 25	0 – 1"	2	1	0.2	0.5	7.5	1
4450001	840 F	25 – 60	1 – 2.36"	2	2	0.2	0.5	7.5	2
4450002	840 F	50 – 100	2 – 4"	2.5	2	0.2	1	7.5	3
4450003	840 F	100 – 150	4 – 6"	2.5	2	0.2	1	9	4
4450004	840 F	150 – 200	6 – 8"	2.5	2	0.2	1	9	5

Order no.	a	b	c	d	e	f	g	h	k	l
	mm	mm	mm	mm	mm	mm	mm	mm	mm	mm
4450000	5	97	34	8	54	65	12	13	23	14
4450001	5	140	68	9	60	77	13	13	25	30
4450002	6.5	193	110	10	60	103	14	13	28	54
4450003	6.5	258	162	12	70	141	16	12	31	81
4450004	6.5	316	212	12	75	171	16	12	31	106

ACCESSORIES

Order no.	Description	Type
4333000	Millimess 5 μm , $\pm 130 \mu\text{m}$	1004
4334000	Millimess 1 μm , $\pm 50 \mu\text{m}$	1003
4334001	Millimess 2 μm , $\pm 130 \mu\text{m}$	1003 XL
4335000	Millimess 0.5 μm , $\pm 25 \mu\text{m}$	1002
4337620	Digital indicator, 0.0005 mm, 12.5 mm	1086 R
4337624	Digital indicator, 0.0005 mm, 12.5 mm	1086 Ri
4450020	Base for stationary application	840 Ff
4450050	Holder, frame size 1	840 Fk/1
4450051	Holder, frame size 2	840 Fk/2
4450052	Holder, frame size 3	840 Fk/3
4450053	Holder, frame size 4 + 5	840 Fk/4



1086 R



840 Fk/2



1004



1003



1002

Marameter 840 FC

Indicating snap gage

FEATURES

- Rugged, forged steel frame with heat insulators
- Measuring spindle is mounted in long guideway with lever controlled retraction
- Measuring spindle and anvil spindle are both made of hardened stainless steel, ceramic measuring faces
- Adjustable centering stop for surface centering
- Anvil spindle can easily be fine adjusted
- Constant measuring force as a result of built-in spring, eliminating user influence
- Maximum wear resistance due to noncontact positioning in conjunction with carbide tipped measuring faces in connection with ceramic measuring faces
- **Package contains:** flat contact point 903 (steel), instruction manual, wooden case, excludes indicator



Applications:

- For cylindrical parts such as shafts, bolts and spindles
- For thickness and length measurements
- Universally applicable and extremely versatile
 - Each instrument spans a broad measuring range
 - Any dimension and fit can be very quickly and easily adjusted

TECHNICAL DATA

Order no.	Type	Applica- tion range	Applica- tion range	Measuring span	Parallelism deviation	Flatness deviation	Repeata- bility f _w	Measuring force	Frame size
		mm	inch	mm	µm	µm	µm	N	
4450100	840 FC	0–25	0–1"	2	1	0.2	1	7.5	1
4450101	840 FC	25–60	1–2.36"	2	2	0.2	1	7.5	2

Order no.	a	b	c	d	e	f	g	h	k	l
	mm	mm	mm	mm	mm	mm	mm	mm	mm	mm
4450100	5	97	34	8	54	65	12	13	23	14
4450101	5	140	68	9	60	77	13	13	25	30

ACCESSORIES

Order no.	Description	Type
4333000	Millimess 5 µm, ± 130 µm	1004
4334000	Millimess 1 µm, ± 50 µm	1003
4334001	Millimess 2 µm, ± 130 µm	1003 XL
4335000	Millimess 0.5 µm, ± 25 µm	1002
4337620	Digital indicator, 0.0005 mm, 12.5 mm	1086 R
4337624	Digital indicator, 0.0005 mm, 12.5 mm	1086 Ri
4450020	Base for stationary application	840 Ff
4450050	Holder, frame size 1	840 Fk/1
4450051	Holder, frame size 2	840 Fk/2



Marameter 840 FH

Indicating snap gage

FEATURES

- Rugged, forged steel frame with heat insulators
- Measuring spindle is mounted in long guideway with lever controlled retraction
- Measuring and anvil spindle have precision tapered bores for mounting interchangeable anvils (with accessory 40 He)
- Anvil spindle can easily be fine adjusted
- Constant measuring force as a result of built-in spring, eliminating user influence
- Maximum wear resistance due to noncontact positioning in conjunction with carbide tipped measuring faces
- **Package contains:** flat contact point 903 (steel), spanner DIN 902–3.5, wooden case, excludes indicator

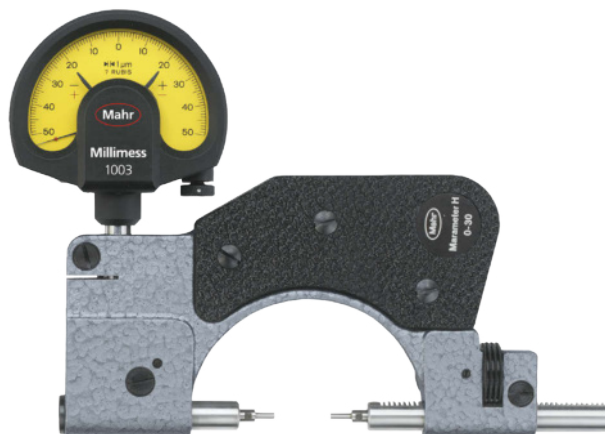

Applications:

- For cylindrical parts such as shafts, bolts and spindles
- Universally applicable
- A wide variety of measurement problems can be solved with the broad range of interchangeable anvils

TECHNICAL DATA

Order no.	Type	Application range	Application range	Measuring span	Repeatability f_w	Measuring force	Frame size
		mm	inch	mm	μm	N	
4451000	840 FH	0–30	0–1.18"	2	1	7.5	2
4451005	840 FH	30–80	1.18–3"	2.5	1	7.5	3

Order no.	a	b	c	d	e	f	g	h	k	l	n
	mm	mm	mm	mm	mm	mm	mm	mm	mm	mm	mm
4451000	12.5	140	68	9	60	77	13	13	25	34	2
4451005	7.5	193	110	10	60	103	13	13	28	59	2.5

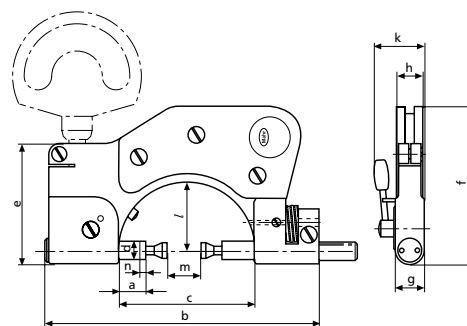

Marameter 840 FH

Indicating snap gage

ACCESSORIES

Order no.	Description	Type
4333000	Millimess 5 μm , $\pm 130 \mu\text{m}$	1004
4334000	Millimess 1 μm , $\pm 50 \mu\text{m}$	1003
4334001	Millimess 2 μm , $\pm 130 \mu\text{m}$	1003 XL
4335000	Millimess 0.5 μm , $\pm 25 \mu\text{m}$	1002
4337620	Digital indicator, 0.0005 mm, 12.5 mm	1086 R
4337624	Digital indicator, 0.0005 mm, 12.5 mm	1086 Ri
4880210	Spanner for 840 FH, to loosen anvils	
4450051	Holder, frame size 2	840 Fk/2
4450020	Base for stationary application	840 Ff
4152036	Measuring anvils, end faces, carbide design	40 He 0H
4152011	Measuring anvils, recessed plane surfaces	40 He 1
4152033	Measuring anvils, recessed end faces, carbide	40 He 1H
4152012	Measuring anvils, recessed plane surfaces	40 He 2
4152031	Measuring anvils, recessed end faces, carbide	40 He 2H
4152013	Measuring anvils, disk-shaped measuring surfaces	40 He 3
4152014	Measuring anvils, disk-shaped measuring surfaces with V-shaped grooves	40 He 4
4152015	Measuring anvils, measuring blades	40 He 5
4152016	Measuring anvils, wing-shaped measuring surfaces	40 He 6
4152017	Measuring anvils, recessed measuring blades	40 He 7
4152018	Measuring anvils, recessed end faces with V-grooves on sleeve	40 He 8
4152019	Measuring anvils, recessed end faces with attachable support table	40 He 9
4152020	Measuring anvils, with centric bores	40 He 10
4152021	Measuring anvils, with tips	40 He 11
4450052	Holder, frame size 3	840 Fk/3



1004



1003



1002



1086 R



840 Fk/2

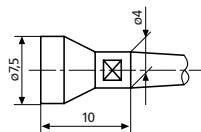

40 He 0H

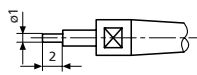

40 He 1; 40 He 1H

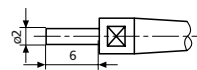

40 He 2; 40 He 2H

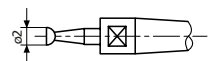

40 He 3

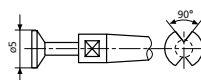

40 He 4

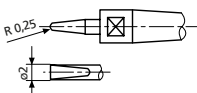

40 He 5

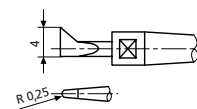

40 He 6

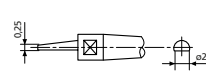

40 He 7

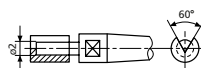

40 He 8

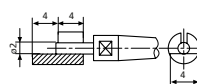

40 He 9

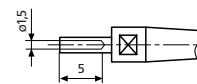

40 He 10

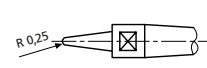

40 He 11

Marameter 840 FG

Indicating snap gage

FEATURES

- Rugged, forged steel frame with heat insulators
- Measuring spindle is mounted in long guideway with lever controlled retraction
- Measuring spindle and anvil spindle have an M 2.5 connection thread, thus enabling the use of interchangeable anvils that are also used in dial indicators and dial comparators
- Anvil spindle can easily be fine adjusted
- Constant measuring force as a result of built-in spring, eliminating user influence
- Maximum wear resistance due to noncontact positioning in conjunction with carbide tipped measuring faces
- Package contains: flat contact point 903 (steel), wooden case, excludes indicator



Applications:

- For cylindrical parts such as shafts, bolts and spindles
- Universally applicable
- A wide variety of measurement problems can be solved with the broad range of interchangeable anvils

TECHNICAL DATA

Order no.	Type	Application range	Application range	Measuring span	Repeatability f_w	Measuring force	Frame size
		mm	inch	mm	μm	N	
4454000	840 FG	0 –50	0 –2"	2	1	7.5	2
4454001	840 FG	40 –90	1.57 –3.57"	2.5	1	7.5	3

Order no.	a	b	c	d	e	f	g	h	k	l	n
	mm	mm	mm	mm	mm	mm	mm	mm	mm	mm	mm
4454000	5	140	68	9	60	77	13	13	25	34	2
4454001	6.5	193	110	10	60	103	14	13	28	59	2.5

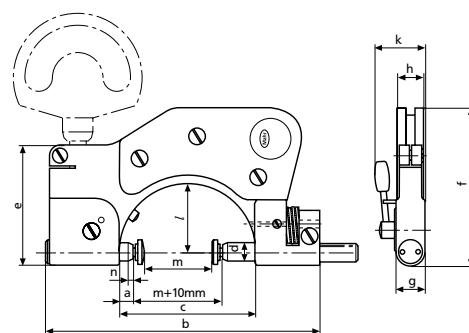

Marameter 840 FG

Indicating snap gage

ACCESSORIES

Order no.	Description	Type
4333000	Millimess 5 μm , $\pm 130 \mu\text{m}$	1004
4334000	Millimess 1 μm , $\pm 50 \mu\text{m}$	1003
4334001	Millimess 2 μm , $\pm 130 \mu\text{m}$	1003 XL
4335000	Millimess 0.5 μm , $\pm 25 \mu\text{m}$	1002
4337620	Digital indicator, 0.0005 mm, 12.5 mm	1086 R
4337624	Digital indicator, 0.0005 mm, 12.5 mm	1086 Ri
4450051	Holder, frame size 2	840 Fk/2
4450020	Base for stationary application	840 Ff
4360002	Standard contact point, carbide, $r = 1.5 \text{ mm}$	901 H
4360041	Spherical contact point, carbide, $l = 10 \text{ mm}$, $r = 6 \text{ mm}$	902 H
4360043	Spherical contact point, carbide, $l = 15 \text{ mm}$, $r = 6 \text{ mm}$	902 H
4360044	Spherical contact point, carbide, $l = 20 \text{ mm}$, $r = 6 \text{ mm}$	902 H
4360101	Flat contact point, carbide, $l = 6 \text{ mm}$	903 H
4360103	Flat contact point, carbide, $l = 10 \text{ mm}$	903 H
4360105	Flat contact point, carbide, $l = 15 \text{ mm}$	903 H
4360106	Flat contact point, carbide, $l = 20 \text{ mm}$	903 H
4360131	Conical contact point, carbide, $r = 0.3 \text{ mm}$	904 H
4360150	Ball contact points, carbide, $l = 8.5 \text{ mm}$, $d = 1.0 \text{ mm}$	906 H
4360151	Ball contact points, carbide, $l = 8.5 \text{ mm}$, $d = 1.25 \text{ mm}$	906 H
4360152	Ball contact points, carbide, $l = 8.5 \text{ mm}$, $d = 1.5 \text{ mm}$	906 H
4360153	Ball contact points, carbide, $l = 8.5 \text{ mm}$, $d = 1.75 \text{ mm}$	906 H
4360154	Ball contact points, carbide, $l = 8.5 \text{ mm}$, $d = 2.0 \text{ mm}$	906 H
4360155	Ball contact points, carbide, $l = 8.5 \text{ mm}$, $d = 2.5 \text{ mm}$	906 H
4360156	Ball contact points, carbide, $l = 8.5 \text{ mm}$, $d = 3.0 \text{ mm}$	906 H
4360157	Ball contact points, carbide, $l = 8.5 \text{ mm}$, $d = 3.5 \text{ mm}$	906 H
4360158	Ball contact points, carbide, $l = 8.5 \text{ mm}$, $d = 4.0 \text{ mm}$	906 H
4360159	Ball contact points, carbide, $l = 8.5 \text{ mm}$, $d = 4.5 \text{ mm}$	906 H
4360160	Ball contact points, carbide, $l = 9 \text{ mm}$, $d = 5.0 \text{ mm}$	906 H
4360161	Ball contact points, carbide, $l = 9 \text{ mm}$, $d = 5.5 \text{ mm}$	906 H
4360162	Ball contact points, carbide, $l = 9 \text{ mm}$, $d = 6 \text{ mm}$	906 H
4360163	Ball contact points, carbide, $l = 9 \text{ mm}$, $d = 6.35 \text{ mm}$	906 H
4360164	Ball contact points, carbide, $l = 10 \text{ mm}$, $d = 6.5 \text{ mm}$	906 H
4360165	Ball contact points, carbide, $l = 10 \text{ mm}$, $d = 7 \text{ mm}$	906 H
4360166	Ball contact points, carbide, $l = 11 \text{ mm}$, $d = 7.5 \text{ mm}$	906 H
4360167	Ball contact points, carbide, $l = 11 \text{ mm}$, $d = 8.0 \text{ mm}$	906 H
4360168	Ball contact points, carbide, $l = 12 \text{ mm}$, $d = 8.5 \text{ mm}$	906 H
4360169	Ball contact points, carbide, $l = 12 \text{ mm}$, $d = 9.0 \text{ mm}$	906 H
4360170	Ball contact points, carbide, $l = 13 \text{ mm}$, $d = 10.0 \text{ mm}$	906 H
4360200	Flat contact plates, steel, measuring surface $\varnothing 11.3 \text{ mm}$	907
4360201	Flat contact plates, carbide, measuring surface $\varnothing 7 \text{ mm}$	907 H
4360210	Spherical contact plates, steel, steel, measuring surface $\varnothing 12 \text{ mm}$	908
4360211	Spherical contact plates, steel, carbide, measuring surface $\varnothing 12 \text{ mm}$	908 H
4360240	Pin contact point, carbide, $l = 2 \text{ mm}$, measuring surface $\varnothing 1 \text{ mm}$	911 H1
4450052	Holder, frame size 3	840 Fk/3



1004



1003



1002



1086 R



840 Fk/2

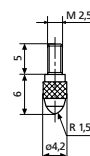

901 H;901;901 R

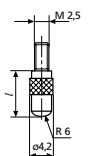

902;902 H

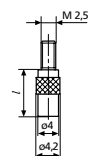

903 H;903

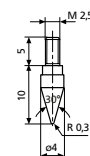

904;904 H

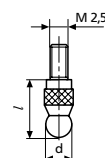

906 H

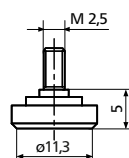

907

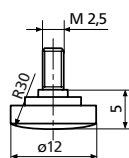

908;908 H

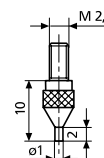

911 H1

Marameter 840 FM

Indicating snap gage

FEATURES

- Rugged, forged steel frame with heat insulators
- Measuring spindle is mounted in long guideway with lever controlled retraction
- Measuring spindle and anvil spindle made of hardened stainless steel; with extending carbide tipped measuring jaws
- Anvil spindle can easily be fine adjusted
- Constant measuring force as a result of built-in spring, eliminating user influence
- Maximum wear resistance due to noncontact positioning in conjunction with carbide tipped measuring faces in conjunction with carbide tipped measuring faces
- **Package contains:** flat contact point 903 (steel), instruction manual, wooden case, excludes indicator

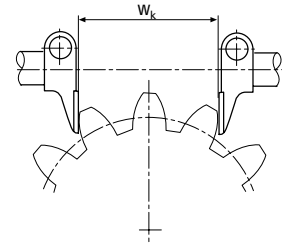
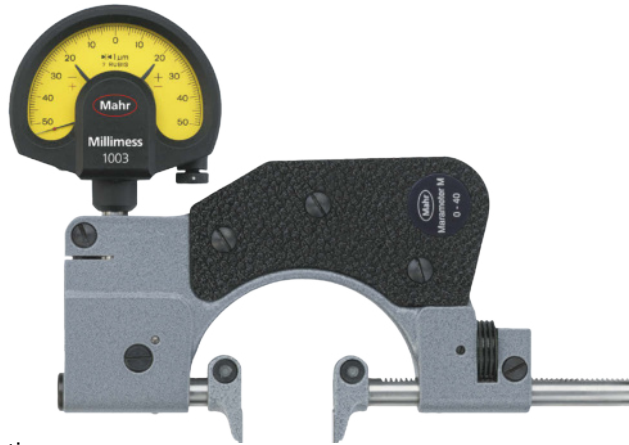

Applications:

- For inspection of diameters of small hubs, registers and shoulders on shafts
- Can be used to inspect tooth span W_k and reference-free tooth thickness on spur gears having straight and helical teeth
- Universally applicable and extremely versatile, each instrument offers long measuring range within its adjustable range

TECHNICAL DATA

Order no.		4452000	4452001	4452002	4452003
Type		840 FM			
Application range	mm	0 – 40	40 – 80	80 – 130	130 – 180
Application range	inch	0 – 1.57"	1.57 – 3"	3 – 5"	5 – 7"
Base tangent lengths starting from module m		0.5		1	
Size of measuring surface		12 x 12 mm		15 x 17 mm	
Measuring span	mm	2		2.5	
Parallelism deviation	μm	2		3	
Flatness deviation	μm			0.5	
Repeatability f_w	μm			1	
Measuring force	N		7.5		9
Frame size		2	3	4	5

Order no.	a	b	c	e	f	g	h	k	l	m	p	t
	mm	mm	mm	mm	mm	mm	mm	mm	mm	mm	mm	mm
4452000	14	140	68	60	77	13	13	25	34	12	12	11
4452001	14	193	110	60	103	14	13	28	59	12	12	11
4452002	19	258	162	70	141	16	20	31	87	17	15	17
4452003	15	316	212	75	171	16	20	31	112	17	15	17

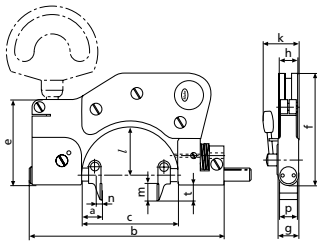

ACCESSORIES

Order no.	Description	Type
4333000	Millimess 5 μm , $\pm 130 \mu\text{m}$	1004
4334000	Millimess 1 μm , $\pm 50 \mu\text{m}$	1003
4334001	Millimess 2 μm , $\pm 130 \mu\text{m}$	1003 XL
4335000	Millimess 0.5 μm , $\pm 25 \mu\text{m}$	1002
4337620	Digital indicator, 0.0005 mm, 12.5 mm	1086 R
4337624	Digital indicator, 0.0005 mm, 12.5 mm	1086 Ri
4450051	Holder, Frame size 2	840 Fk/2
4450020	Base for stationary application	840 Ff
4450052	Holder, frame size 3	840 Fk/3
4450053	Holder, frame size 4 + 5	840 Fk/4



1004



1003



1002



1086 R



840 Fk/2

Marameter 840 FS

Indicating snap gage

FEATURES

- Rugged, forged steel frame with heat insulators
- Both spindles are made of hardened stainless steel and mounted in long guideways
- Carbide tipped measuring faces slightly chamfered at the front to facilitate positioning
- Projects over width of frame for measurement of narrow registers or when measuring directly at shoulders
- Adjustable centering stop for surface centering
- Straight transfer of spindle movement to indicator; ensures the weight of the gage rests on the anvil spindle
- Direct indication and evaluation of measurement results
- Constant measuring force as a result of built-in spring, eliminating user influence
- **Package contains:** wooden case, allen key, excludes indicator



Applications:

- For all kinds of cylindrical workpieces, whether directly on a machine tool or production control
- Universally applicable and extremely versatile
 - Each instrument spans a broad measuring range
 - Any dimension and fit can be very quickly and easily adjusted

TECHNICAL DATA

Order no.	Product weight	Type	Applica- tion range		Measuring span	Parallelism deviation	Flatness deviation	Repeata- bility f _w	Measuring force
			mm	inch					
4455000	0.60	840 FS	10 –30	.39 –1.18"	0.7	3	0.5	1	13.5
4455001	0.90	840 FS	30 –60	1.18 –2.36"	0.7	3	0.5	1	13.5
4455002	1.30	840 FS	60 –100	2.36 –4"	0.7	3	0.5	1	13.5
4455003	1.70	840 FS	100 –150	4 –6"	0.7	3	0.5	1	15
4455004	2.00	840 FS	150 –200	6 –8"	0.7	3	0.5	1	15
4455005	2.20	840 FS	200 –250	8 –10"	0.7	3	0.5	1	15
4455006	2.50	840 FS	250 –300	10 –12"	0.7	3	0.5	1	15
4455007	3.30	840 FS	300 –350	12 –14"	0.7	4	0.5	1	15
4455008	3.30	840 FS	350 –400	14 –16"	0.7	4	0.5	1	15
4455009	4.30	840 FS	400 –450	16 –18"	0.7	4	0.5	1	15
4455010	4.70	840 FS	450 –500	18 –20"	0.7	4	0.5	1	15

Order no.	a	b	c	d	e	f	g	h
4455000	37	46	154	18	87	161	17	15
4455001	45	51	199	18	122	196	17	15
4455002	56	62	260	22	154	228	20	18
4455003	71	62	335	22	189	263	20	18
4455004	71	62	385	22	214	288	20	18
4455005	71	62	436	22	248	322	20	18
4455006	71	62	487	22	280	354	20	18
4455007	71	62	537	22	310	384	20	18
4455008	71	62	587	22	350	424	20	18
4455009	71	62	637	22	380	454	20	18
4455010	71	62	687	22	410	484	20	18

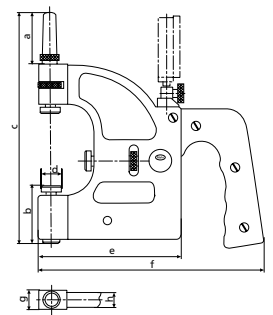

ACCESSORIES

Order no.	Description	Type
4335000	Millimess 0.5 μm, ± 25 μm	1002
4334000	Millimess 1 μm, ± 50 μm	1003
4334001	Millimess 2 μm, ± 130 μm	1003 XL
4333000	Millimess 5 μm, ± 130 μm	1004
4337620	Digital indicator, 0.0005 mm, 12.5 mm	1086 R
4337624	Digital indicator, 0.0005 mm, 12.5 mm	1086 Ri



1004



1003



1002



1086 R

Marameter 840 E

Indicating snap gage

FEATURES

- Extremely accurate due to the straight transfer of spindle movement to the inductive measuring system according to the Abbe principle
- **Universally applicable and extremely versatile:**
 - Each instrument spans a broad measuring range
 - Any dimension and fit can be very quickly and easily adjusted
- Constant measuring force as a result of built-in spring, eliminating user influence
- Maximum wear resistance due to noncontact positioning in conjunction with carbide tipped measuring faces
- **Package contains:** wooden case, excludes indicator



Application:

- For ultra-accurate measurements on precision components (diameter, thickness and length measurements)

TECHNICAL DATA

Order no.	Type	Application range	Readings/Selectable resolution down to	Measuring surface ϕ	Measuring span	Parallelism deviation	Repeatability f_w	Measuring force	Frame size 3
4453000	840 E	mm 0 – 25	μm 0.01	mm 7.5	mm 0.5	μm 0.3	μm 0.1	N 4.5	1

ACCESSORIES

Order no.	Description	Type
5312010	Compact amplifier	C 1200
5312025	Compact amplifier	C 1202
5331120	Module for inductive probes	N 1702 M
5331125	Module for inductive probes	N 1702 M-HR
4450020	Base for stationary application	840 Ff



C 1200



C 1202



N 1702 M

Marameter EDI-300P-1 ... EDI-300P-9

Indicating snap gage

FEATURES

- Patented "Channel Lock" design assures precise parallel anvil surfaces throughout the full 25 mm / 1" range of adjustment
- All 300P series snap gages are fully adjustable with positive position locking at any point within the range
- 0.50 mm / .020" movement of sensitive contact
- Snap gages available over a wide range of sizes, styles, and readout configurations
- Large 15.5 mm / .61" square tungsten carbide anvils provide flat, parallel, working surfaces ensuring precision that lasts
- Indicator can be rotated to read from front or rear of the gage
- All adjustments accomplished using a single hex wrench (included)
- **Package contains:** allen key

Applications:

- For rapid measurements of cylindrical parts such as shafts, bolts and spindles
- For thickness and length measurements



TECHNICAL DATA

Order no.	Type	Measuring range	Application range	Measuring span	Size of measuring surface	Measuring span	Parallelism deviation	Measuring force	Mounting hole for indicator	Lifting lever	Indicating instrument (included in package)
		inch	mm	inch	mm	mm	µm	N	inch		
2051658	EDI-300P-1	0 - 1"	0 - 25.4	0.02	15.5 x 15.5	0.5	4	18	.375"	-	2034201 µMaxµm-II
2051664	EDI-300P-2	1 - 2"	25.4 - 50.8	0.02	15.5 x 15.5	0.5	4	18	.375"	-	2034201 µMaxµm-II
2051666	EDI-300P-3	2 - 3"	50.8 - 76.2	0.02	15.5 x 15.5	0.5	4	18	.375"	-	2034201 µMaxµm-II
2051668	EDI-300P-4	3 - 4"	76.2 - 101.6	0.02	15.5 x 15.5	0.5	4	18	.375"	-	2034201 µMaxµm-II
2051669	EDI-300P-5	4 - 5"	101.6 - 127	0.02	15.5 x 15.5	0.5	4	18	.375"	-	2034201 µMaxµm-II
2051670	EDI-300P-6	5 - 6"	127 - 152.4	0.02	15.5 x 15.5	0.5	4	18	.375"	-	2034201 µMaxµm-II
2051671	EDI-300P-7	6 - 7"	152.4 - 177.8	0.02	15.5 x 15.5	0.5	4	18	.375"	-	2034201 µMaxµm-II
2051672	EDI-300P-8	7 - 8"	177.8 - 203.2	0.02	15.5 x 15.5	0.5	4	18	.375"	-	2034201 µMaxµm-II
2051673	EDI-300P-9	8 - 9"	203.2 - 228.6	0.02	15.5 x 15.5	0.5	4	18	.375"	-	2034201 µMaxµm-II

Order no.	a	b	c	d	e
	mm	mm	mm	mm	mm
2051658	25.4	150	29	145	158
2051664	50.8	175	29	141	154
2051666	76.2	200	29	155	167
2051668	101.6	226	29	167	180
2051669	127	251	29	180	193
2051670	152.4	278	30	203	215
2051671	177.8	303	30	213	226
2051672	203.2	329	30	231	244
2051673	228.6	335	30	248	261

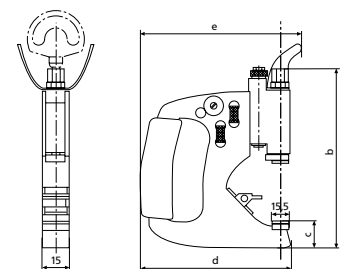

ACCESSORIES

Order no.	Description	Type
2003150	Base/bench stand for 300P or 1000P style snap gage	BA-26
2202272	Plain anvil (lower), left (option)	AL-1755
2202273	Plain anvil (upper), left (option)	AL-1756
2202274	Plain anvil (lower), right (option)	AL-1757
2202275	Plain anvil (lower), right (option)	AL-1758
2202276	Plain anvil (lower), middle (option)	AL-1759
2202277	Plain anvil (lower), middle (option)	AL-1760
2204644	Bench stand for AGD style 3 disc masters up to 127 mm / 5"	BA-71
2232441	Heavier force spring for EMD-30XP	SP-118
2232478	Lighter force spring for EMD-30XP	SP-192
2243295	Lighter force spring for EDI-30XP	2243295
2243297	Heavier force spring for EDI-30XP	2243297

Marameter EMD-300P-1D ... EMD-300P-9D

Indicating snap gage



FEATURES

- Patented "Channel Lock" design assures precise parallel anvil surfaces throughout the full 25 mm / 1" range of adjustment
- All 300P series snap gages are fully adjustable with positive position locking at any point within the range
- 0.50 mm / .020" movement of sensitive contact
- Snap gages available over a wide range of sizes, styles, and readout configurations
- Large 15.5 mm / .61" square tungsten carbide anvils provide flat, parallel, working surfaces ensuring precision that lasts
- Indicator can be rotated to read from front or rear of the gage
- All adjustments accomplished using a single hex wrench (included)
- **Data interface:** Digimatic, RS-232C, USB
- **Energy supply:** battery operation
- **Package contains:** allen key

Applications:

- For rapid measurements of cylindrical parts such as shafts, bolts and spindles
- For thickness and length measurements



TECHNICAL DATA

Order no.	Type	Measuring range	Application range	Measuring span	Size of measuring surface	Measuring span	Parallelism deviation	Measuring force	Mounting hole for indicator	Lifting lever	Indicating instrument (included in package)
2051730	EMD-300P-1D	0-1"	0-25.4	0.02	15.5 x 15.5	mm	μm	N	inch	-	2033119 Maxμm-III
2051734	EMD-300P-2D	1-2"	25.4-50.8	0.02	15.5 x 15.5	mm	μm	N	inch	-	2033119 Maxμm-III
2051758	EMD-300P-3D	2-3"	50.8-76.2	0.02	15.5 x 15.5	mm	μm	N	inch	-	2033119 Maxμm-III
2051762	EMD-300P-4D	3-4"	76.2-101.6	0.02	15.5 x 15.5	mm	μm	N	inch	-	2033119 Maxμm-III
2051766	EMD-300P-5D	4-5"	101.6-127	0.02	15.5 x 15.5	mm	μm	N	inch	-	2033119 Maxμm-III
2051770	EMD-300P-6D	5-6"	127-152.4	0.02	15.5 x 15.5	mm	μm	N	inch	-	2033119 Maxμm-III
2051774	EMD-300P-7D	6-7"	152.4-177.8	0.02	15.5 x 15.5	mm	μm	N	inch	-	2033119 Maxμm-III
2051778	EMD-300P-8D	7-8"	177.8-203.2	0.02	15.5 x 15.5	mm	μm	N	inch	-	2033119 Maxμm-III
2051782	EMD-300P-9D	8-9"	203.2-228.6	0.02	15.5 x 15.5	mm	μm	N	inch	-	2033119 Maxμm-III

Order no.	a	b	c	d	e
	mm	mm	mm	mm	mm
2051730	25.4	150	29	145	158
2051734	50.8	175	29	141	154
2051758	76.2	200	29	155	167
2051762	101.6	226	29	167	180
2051766	127	251	29	180	193
2051770	152.4	278	30	203	215
2051774	177.8	303	30	213	226
2051778	203.2	329	30	231	244
2051782	228.6	335	30	248	261

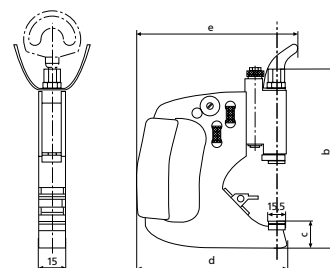

ACCESSORIES

Order no.	Description	Type
2003150	Base/bench stand for 300P or 1000P style snap gage	BA-26
2202272	Plain anvil (lower), left (option)	AL-1755
2202273	Plain anvil (upper), left (option)	AL-1756
2202274	Plain anvil (lower), right (option)	AL-1757
2202275	Plain anvil (lower), right (option)	AL-1758
2202276	Plain anvil (lower), middle (option)	AL-1759
2202277	Plain anvil (lower), middle (option)	AL-1760
2204644	Bench stand for AGD style 3 disc masters up to 127 mm / 5"	BA-71
2232441	Heavier force spring for EMD-30XP	SP-118
2232478	Lighter force spring for EMD-30XP	SP-192
2243295	Lighter force spring for EDI-30XP	2243295
2243297	Heavier force spring for EDI-30XP	2243297

Marameter 300P-1 ... 300P-9

Indicating snap gage

FEATURES

- Patented "Channel Lock" design assures precise parallel anvil surfaces throughout the full 25 mm / 1" range of adjustment
- All 300P series snap gages are fully adjustable with positive position locking at any point within the range
- 0.50 mm / .020" movement of sensitive contact
- Snap gages available over a wide range of sizes, styles, and readout configurations
- Large 15.5 mm / .61" square tungsten carbide anvils provide flat, parallel, working surfaces ensuring precision that lasts
- Indicator can be rotated to read from front or rear of the gage
- All adjustments accomplished using a single hex wrench (included)
- **Package contains:** allen key

Applications:

- For rapid measurements of cylindrical parts such as shafts, bolts and spindles
- For thickness and length measurements



TECHNICAL DATA

Order no.	Type	Measuring range	Applying range	Measuring span	Size of measuring surface	Measuring span	Parallelism deviation	Measuring force	Mounting hole for indicator	Lifting lever	Indicating instrument (included in package)
		inch	mm	inch	mm	mm	µm	N	inch		
2050485	300P-1	0-1"	0-25.4	0.02	15.5 x 15.5	0.5	4	18	.375"	-	IDT-102 Indicator (12I)
2050497	300P-2	1-2"	25.4-50.8	0.02	15.5 x 15.5	0.5	4	18	.375"	-	IDT-102 Indicator (12I)
2050499	300P-3	2-3"	50.8-76.2	0.02	15.5 x 15.5	0.5	4	18	.375"	-	IDT-102 Indicator (12I)
2050511	300P-4	3-4"	76.2-101.6	0.02	15.5 x 15.5	0.5	4	18	.375"	-	IDT-102 Indicator (12I)
2050514	300P-5	4-5"	101.6-127	0.02	15.5 x 15.5	0.5	4	18	.375"	-	IDT-102 Indicator (12I)
2050516	300P-6	5-6"	127-152.4	0.02	15.5 x 15.5	0.5	4	18	.375"	-	IDT-106 Indicator (22I)
2050518	300P-7	6-7"	152.4-177.8	0.02	15.5 x 15.5	0.5	4	18	.375"	-	IDT-106 Indicator (22I)
2050527	300P-8	7-8"	177.8-203.2	0.02	15.5 x 15.5	0.5	4	18	.375"	-	IDT-106 Indicator (22I)
2050529	300P-9	8-9"	203.2-228.6	0.02	15.5 x 15.5	0.5	4	18	.375"	-	IDT-106 Indicator (22I)

Order no.	a	b	c	d	e
	mm	mm	mm	mm	mm
2050485	25.4	150	29	145	158
2050497	50.8	175	29	141	154
2050499	76.2	200	29	155	167
2050511	101.6	226	29	167	180
2050514	127	251	29	180	193
2050516	152.4	278	30	203	215
2050518	177.8	303	30	213	226
2050527	203.2	329	30	231	244
2050529	228.6	335	30	248	261

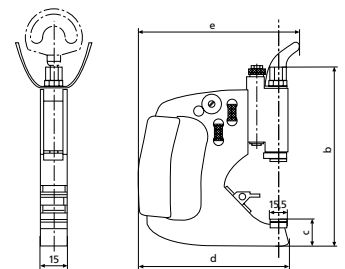

ACCESSORIES

Order no.	Description	Type
2003150	Base/bench stand for 300P or 1000P style snap gage	BA-26
2202272	Plain anvil (lower), left (option)	AL-1755
2202273	Plain anvil (upper), left (option)	AL-1756
2202274	Plain anvil (lower), right (option)	AL-1757
2202275	Plain anvil (lower), right (option)	AL-1758
2202276	Plain anvil (lower), middle (option)	AL-1759
2202277	Plain anvil (lower), middle (option)	AL-1760
2204644	Bench stand for AGD style 3 disc masters up to 127 mm / 5"	BA-71
2232441	Heavier force spring for EMD-30XP	SP-118
2232478	Lighter force spring for EMD-30XP	SP-192

Marameter 300P-1M ... 300P-7M

Indicating snap gage

FEATURES

- Patented "Channel Lock" design assures precise parallel anvil surfaces throughout the full 25 mm / 1" range of adjustment
- All 300P series snap gages are fully adjustable with positive position locking at any point within the range
- 0.50 mm / .020" movement of sensitive contact
- Snap gages available over a wide range of sizes, styles, and readout configurations
- Large 15.5 mm / .61" square tungsten carbide anvils provide flat, parallel, working surfaces ensuring precision that lasts
- Indicator can be rotated to read from front or rear of the gage
- All adjustments accomplished using a single hex wrench (included)
- **Package contains:** allen key

Applications:

- For rapid measurements of cylindrical parts such as shafts, bolts and spindles
- For thickness and length measurements



TECHNICAL DATA

Order no.	Type	Appli- cation range	Mea- suring span	Size of measuring surface	Mea- suring span	Paralle- lism de- viation	Mea- suring force	Mounting hole for indicator	Lifting lever	Indicating instrument (included in package)
		mm	inch	mm	mm	µm	N	inch		
2050496	300P-1M	0 -25.4	0.02	15.5 x 15.5	0.5	4	18	.375"	-	IDS-206
2050498	300P-2M	25.4 -50.8	0.02	15.5 x 15.5	0.5	4	18	.375"	-	IDS-206
2050510	300P-3M	50.8 -76.2	0.02	15.5 x 15.5	0.5	4	18	.375"	-	IDS-206
2050513	300P-4M	76.2 -101.6	0.02	15.5 x 15.5	0.5	4	18	.375"	-	IDS-206
2050515	300P-5M	101.6 -127	0.02	15.5 x 15.5	0.5	4	18	.375"	-	IDS-206
2050517	300P-6M	127 -152.4	0.02	15.5 x 15.5	0.5	4	18	.375"	-	IDS-206
2050526	300P-7M	152.4 -177.8	0.02	15.5 x 15.5	0.5	4	18	.375"	-	IDS-208

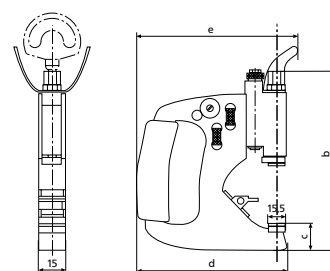

ACCESSORIES

Order no.	Description	Type
2003150	Base/bench stand for 300P or 1000P style snap gage	BA-26
2202272	Plain anvil (lower), left (option)	AL-1755
2202273	Plain anvil (upper), left (option)	AL-1756
2202274	Plain anvil (lower), right (option)	AL-1757
2202275	Plain anvil (lower), right (option)	AL-1758
2202276	Plain anvil (lower), middle (option)	AL-1759
2202277	Plain anvil (lower), middle (option)	AL-1760
2204644	Bench stand for AGD style 3 disc masters up to 127 mm / 5"	BA-71
2232441	Heavier force spring for EMD-30XP	SP-118
2232478	Lighter force spring for EMD-30XP	SP-192

Marameter M-300P-1 ... M-300P-9

Indicating snap gage

FEATURES

- Patented "Channel Lock" design assures precise parallel anvil surfaces throughout the full 25 mm / 1" range of adjustment
- All 300P series snap gages are fully adjustable with positive position locking at any point within the range
- 0.50 mm / .020" movement of sensitive contact
- Snap gages available over a wide range of sizes, styles, and readout configurations
- Large 15.5 mm / .61" square tungsten carbide anvils provide flat, parallel, working surfaces ensuring precision that lasts
- Indicator can be rotated to read from front or rear of the gage
- All adjustments accomplished using a single hex wrench (included)
- **Package contains:** allen key

Applications:

- For rapid measurements of cylindrical parts such as shafts, bolts and spindles
- For thickness and length measurements



TECHNICAL DATA

Order no.	Type	Measuring range	Application range	Measuring span	Size of measuring surface	Measuring span	Parallelism deviation	Measuring force	Lifting lever	Indicating instrument (included in package)
2003100	M-300P-1	0-1"	0-25.4	0.02	15.5 x 15.5	0.5	4	18	8	NONE
2003101	M-300P-2	1-2"	25.4-50.8	0.02	15.5 x 15.5	0.5	4	18	8	NONE
2003102	M-300P-3	2-3"	50.8-76.2	0.02	15.5 x 15.5	0.5	4	18	8	NONE
2003103	M-300P-4	3-4"	76.2-101.6	0.02	15.5 x 15.5	0.5	4	18	8	NONE
2003104	M-300P-5	4-5"	101.6-127	0.02	15.5 x 15.5	0.5	4	18	8	NONE
2003105	M-300P-6	5-6"	127-152.4	0.02	15.5 x 15.5	0.5	4	18	8	NONE
2003106	M-300P-7	6-7"	152.4-177.8	0.02	15.5 x 15.5	0.5	4	18	8	NONE
2003107	M-300P-8	7-8"	177.8-203.2	0.02	15.5 x 15.5	0.5	4	18	8	NONE
2003108	M-300P-9	8-9"	203.2-228.6	0.02	15.5 x 15.5	0.5	4	18	8	NONE

Order no.	b	c	d	e
	mm	mm	mm	mm
2003100	150	29	145	158
2003101	175	29	141	154
2003102	200	29	155	167
2003103	226	29	167	180
2003104	251	29	180	193
2003105	278	30	203	215
2003106	303	30	213	226
2003107	329	30	231	244
2003108	335	30	248	261

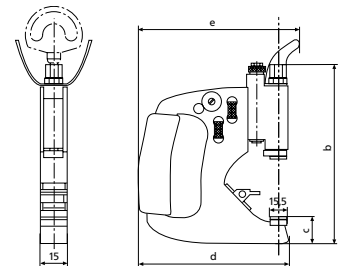

ACCESSORIES

Order no.	Description	Type
2003150	Base/bench stand for 300P or 1000P style snap gage	BA-26
2202272	Plain anvil (lower), left (option)	AL-1755
2202273	Plain anvil (upper), left (option)	AL-1756
2202274	Plain anvil (lower), right (option)	AL-1757
2202275	Plain anvil (lower), right (option)	AL-1758
2202276	Plain anvil (lower), middle (option)	AL-1759
2202277	Plain anvil (lower), middle (option)	AL-1760
2204644	Bench stand for AGD style 3 disc masters up to 127 mm / 5"	BA-71
2232441	Heavier force spring for EMD-30XP	SP-118
2232478	Lighter force spring for EMD-30XP	SP-192
4332000	Millimess 0.01, ± 0.25 mm	1010
4333000	Millimess 5 µm, ± 130 µm	1004
4337620	Digital indicator, 0.0005 mm, 12.5 mm	1086 R
4337624	Digital indicator, 0.0005 mm, 12.5 mm	1086 Ri



1004



1086
R-HR;1086
R;1086 ZR

Marameter OMI-300P-1 ... OMI-300P-9

Indicating snap gage

FEATURES

- Patented "Channel Lock" design assures precise parallel anvil surfaces throughout the full 25 mm / 1" range of adjustment
- All 300P series snap gages are fully adjustable with positive position locking at any point within the range
- 0.50 mm / .020" movement of sensitive contact
- Snap gages available over a wide range of sizes, styles, and readout configurations
- Large 15.5 mm / .61" square tungsten carbide anvils provide flat, parallel, working surfaces ensuring precision that lasts
- Indicator can be rotated to read from front or rear of the gage
- All adjustments accomplished using a single hex wrench (included)
- **Package contains:** allen key

Applications:

- For rapid measurements of cylindrical parts such as shafts, bolts and spindles
- For thickness and length measurements



TECHNICAL DATA

Order no.	Type	Measuring range	Application range	Measuring span	Size of measuring surface	Measuring span	Parallelism deviation	Measuring force	Mounting hole for indicator	Lifting lever	Indicating instrument (included in package)
2054281	OMI-300P-1	0 - 1"	0 - 25.4	0.02	15.5 x 15.5	mm	4	18	.375"	-	NONE
2054287	OMI-300P-2	1 - 2"	25.4 - 50.8	0.02	15.5 x 15.5	mm	4	18	.375"	-	NONE
2054288	OMI-300P-3	2 - 3"	50.8 - 76.2	0.02	15.5 x 15.5	mm	4	18	.375"	-	NONE
2054294	OMI-300P-4	3 - 4"	76.2 - 101.6	0.02	15.5 x 15.5	mm	4	18	.375"	-	NONE
2054295	OMI-300P-5	4 - 5"	101.6 - 127	0.02	15.5 x 15.5	mm	4	18	.375"	-	NONE
2054296	OMI-300P-6	5 - 6"	127 - 152.4	0.02	15.5 x 15.5	mm	4	18	.375"	-	NONE
2054297	OMI-300P-7	6 - 7"	152.4 - 177.8	0.02	15.5 x 15.5	mm	4	18	.375"	-	NONE
2054298	OMI-300P-8	7 - 8"	177.8 - 203.2	0.02	15.5 x 15.5	mm	4	18	.375"	-	NONE
2054299	OMI-300P-9	8 - 9"	203.2 - 228.6	0.02	15.5 x 15.5	mm	4	18	.375"	-	NONE

Order no.	a	b	c	d	e
	mm	mm	mm	mm	mm
2054281	25.4	150	29	145	158
2054287	50.8	175	29	141	154
2054288	76.2	200	29	155	167
2054294	101.6	226	29	167	180
2054295	127	251	29	180	193
2054296	152.4	278	30	203	215
2054297	177.8	303	30	213	226
2054298	203.2	329	30	231	244
2054299	228.6	335	30	248	261

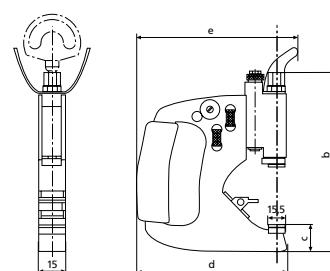

ACCESSORIES

Order no.	Description	Type
2003150	Base/bench stand for 300P or 1000P style snap gage	BA-26
2202272	Plain anvil (lower), left (option)	AL-1755
2202273	Plain anvil (upper), left (option)	AL-1756
2202274	Plain anvil (lower), right (option)	AL-1757
2202275	Plain anvil (lower), right (option)	AL-1758
2202276	Plain anvil (lower), middle (option)	AL-1759
2202277	Plain anvil (lower), middle (option)	AL-1760
2204644	Bench stand for AGD style 3 disc masters up to 127 mm / 5"	BA-71
2232441	Heavier force spring for EMD-30XP	SP-118
2232478	Lighter force spring for EMD-30XP	SP-192

Marameter EDI-301P-1 ... EDI-301P-9

Indicating snap gage

FEATURES

- Patented "Channel Lock" design assures precise parallel anvil surfaces throughout the full 25 mm / 1" range of adjustment
- All 300P series snap gages are fully adjustable with positive position locking at any point within the range
- 0.50 mm / .020" movement of sensitive contact
- Snap gages available over a wide range of sizes, styles, and readout configurations
- Large 15.5 mm / .61" square tungsten carbide anvils provide flat, parallel, working surfaces that ensure lasting precision that lasts
- Indicator can be rotated to read from front or rear of the gage
- All adjustments accomplished using a single hex wrench (included)
- **Package contains:** allen key

Applications:

- For rapid measurements of cylindrical parts such as shafts, bolts and spindles
- For thickness and length measurements



TECHNICAL DATA

Order no.	Type	Measuring range	Application range	Measuring span	Size of measuring surface	Measuring span	Parallelism deviation	Measuring force	Mounting hole for indicator	Lifting lever	Indicating instrument (included in package)
2051674	EDI-301P-1	0-1"	0-25.4	0.02	15.5 x 15.5	0.5	4	18	.375"	•	2034201 uMaxumll indicator
2051680	EDI-301P-2	1-2"	25.4-50.8	0.02	15.5 x 15.5	0.5	4	18	.375"	•	2034201 uMaxumll indicator
2051681	EDI-301P-3	2-3"	50.8-76.2	0.02	15.5 x 15.5	0.5	4	18	.375"	•	2034201 uMaxumll indicator
2051687	EDI-301P-4	3-4"	76.2-101.6	0.02	15.5 x 15.5	0.5	4	18	.375"	•	2034201 uMaxumll indicator
2051688	EDI-301P-5	4-5"	101.6-127	0.02	15.5 x 15.5	0.5	4	18	.375"	•	2034201 uMaxumll indicator
2051689	EDI-301P-6	5-6"	127-152.4	0.02	15.5 x 15.5	0.5	4	18	.375"	•	2034201 uMaxumll indicator
2051690	EDI-301P-7	6-7"	152.4-177.8	0.02	15.5 x 15.5	0.5	4	18	.375"	•	2034201 uMaxumll indicator
2051691	EDI-301P-8	7-8"	177.8-203.2	0.02	15.5 x 15.5	0.5	4	18	.375"	•	2034201 uMaxumll indicator
2051692	EDI-301P-9	8-9"	203.2-228.6	0.02	15.5 x 15.5	0.5	4	18	.375"	•	2034201 uMaxumll indicator

Order no.	a	b	c	d	e
	mm	mm	mm	mm	mm
2051674	25.4	150	29	145	158
2051680	50.8	175	29	141	154
2051681	76.2	200	29	155	167
2051687	101.6	226	29	167	180
2051688	127	251	29	180	193
2051689	152.4	278	30	203	215
2051690	177.8	303	30	213	226
2051691	203.2	329	30	231	244
2051692	228.6	335	30	248	261

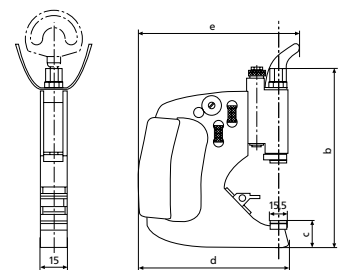

1004



1086 R-HR;
1086 R;1086 ZR

ACCESSORIES

Order no.	Description	Type
4332000	Millimess 0.01, ± 0.25 mm	1010
4333000	Millimess 5 µm, ± 130 µm	1004
4337620	Digital indicator, 0.0005 mm, 12.5 mm	1086 R
4337624	Digital indicator, 0.0005 mm, 12.5 mm	1086 Ri

Marameter EMD-301P-1D ... EMD-301P-9D

Indicating snap gage



FEATURES

- Patented "Channel Lock" design assures precise parallel anvil surfaces throughout the full 25 mm / 1" range of adjustment
- All 300P series snap gages are fully adjustable with positive position locking at any point within the range
- 0.50 mm / .020" movement of sensitive contact
- Snap gages available over a wide range of sizes, styles, and readout configurations
- Large 15.5 mm / .61" square tungsten carbide anvils provide flat, parallel, working surfaces that ensure lasting precision that lasts
- Indicator can be rotated to read from front or rear of the gage
- All adjustments accomplished using a single hex wrench (included)
- **Data interface:** Digimatic, RS-232C, USB
- **Energy supply:** battery operation
- **Package contains:** allen key

Applications:

- For rapid measurements of cylindrical parts such as shafts, bolts and spindles
- For thickness and length measurements



TECHNICAL DATA

Order no.	Type	Measuring range	Application range	Measuring span	Size of measuring surface	Measuring span	Parallelism deviation	Measuring force	Mounting hole for indicator	Lifting lever	Indicating instrument (included in package)
		inch	mm	inch	mm	mm	µm	N	inch		
2051806	EMD-301P-1D	0 - 1"	0 - 25.4	0.02	15.5 x 15.5	0.5	4	18	.375"	•	2033119 MaxumIII
2051810	EMD-301P-2D	1 - 2"	25.4 - 50.8	0.02	15.5 x 15.5	0.5	4	18	.375"	•	2033119 MaxumIII
2051834	EMD-301P-3D	2 - 3"	50.8 - 76.2	0.02	15.5 x 15.5	0.5	4	18	.375"	•	2033119 MaxumIII
2051838	EMD-301P-4D	3 - 4"	76.2 - 101.6	0.02	15.5 x 15.5	0.5	4	18	.375"	•	2033119 MaxumIII
2051842	EMD-301P-5D	4 - 5"	101.6 - 127	0.02	15.5 x 15.5	0.5	4	18	.375"	•	2033119 MaxumIII
2051846	EMD-301P-6D	5 - 6"	127 - 152.4	0.02	15.5 x 15.5	0.5	4	18	.375"	•	2033119 MaxumIII
2051850	EMD-301P-7D	6 - 7"	152.4 - 177.8	0.02	15.5 x 15.5	0.5	4	18	.375"	•	2033119 MaxumIII
2051854	EMD-301P-8D	7 - 8"	177.8 - 203.2	0.02	15.5 x 15.5	0.5	4	18	.375"	•	2033119 MaxumIII
2051858	EMD-301P-9D	8 - 9"	203.2 - 228.6	0.02	15.5 x 15.5	0.5	4	18	.375"	•	2033119 MaxumIII

Order no.	a	b	c	d	e
	mm	mm	mm	mm	mm
2051806	25.4	150	29	145	158
2051810	50.8	175	29	141	154
2051834	76.2	200	29	155	167
2051838	101.6	226	29	167	180
2051842	127	251	29	180	193
2051846	152.4	278	30	203	215
2051850	177.8	303	30	213	226
2051854	203.2	329	30	231	244
2051858	228.6	335	30	248	261

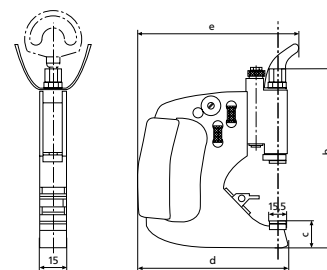

1004



1086 R-HR;
1086 R; 1086 ZR

ACCESSORIES

Order no.	Description	Type
4332000	Millimess 0.01, ± 0.25 mm	1010
4333000	Millimess 5 µm, ± 130 µm	1004
4337620	Digital indicator, 0.0005 mm, 12.5 mm	1086 R
4337624	Digital indicator, 0.0005 mm, 12.5 mm	1086 Ri

Marameter OMI-301P-1 ... OMI-301P-9

Indicating snap gage

FEATURES

- Patented "Channel Lock" design assures precise parallel anvil surfaces throughout the full 25 mm / 1" range of adjustment
- All 300P series snap gages are fully adjustable with positive position locking at any point within the range
- 0.50 mm / .020" movement of sensitive contact
- Snap gages available over a wide range of sizes, styles, and readout configurations
- Large 15.5 mm / .61" square tungsten carbide anvils provide flat, parallel, working surfaces that ensure lasting precision that lasts
- Indicator can be rotated to read from front or rear of the gage
- All adjustments accomplished using a single hex wrench (included)
- **Package contains:** allen key

Applications:

- For rapid measurements of cylindrical parts such as shafts, bolts and spindles
- For thickness and length measurements



TECHNICAL DATA

Order no.	Type	Measuring range	Appl. range	Measuring span	Size of measuring surface	Measuring span	Parallelism deviation	Measuring force	Mounting hole for indicator	Lifting lever	Indicating instrument (included in package)
2054300	OMI-301P-1	0 - 1" inch	0 -25.4 mm	0.02 inch	15.5 x 15.5 mm	0.5 mm	4 µm	18 N	.375" inch	•	NONE
2054306	OMI-301P-2	1 - 2" inch	25.4 -50.8 mm	0.02 inch	15.5 x 15.5 mm	0.5 mm	4 µm	18 N	.375" inch	•	NONE
2054307	OMI-301P-3	2 - 3" inch	50.8 -76.2 mm	0.02 inch	15.5 x 15.5 mm	0.5 mm	4 µm	18 N	.375" inch	•	NONE
2054313	OMI-301P-4	3 - 4" inch	76.2 -101.6 mm	0.02 inch	15.5 x 15.5 mm	0.5 mm	4 µm	18 N	.375" inch	•	NONE
2054314	OMI-301P-5	4 - 5" inch	101.6 -127 mm	0.02 inch	15.5 x 15.5 mm	0.5 mm	4 µm	18 N	.375" inch	•	NONE
2054315	OMI-301P-6	5 - 6" inch	127 -152.4 mm	0.02 inch	15.5 x 15.5 mm	0.5 mm	4 µm	18 N	.375" inch	•	NONE
2054316	OMI-301P-7	6 - 7" inch	152.4 -177.8 mm	0.02 inch	15.5 x 15.5 mm	0.5 mm	4 µm	18 N	.375" inch	•	NONE
2054317	OMI-301P-8	7 - 8" inch	177.8 -203.2 mm	0.02 inch	15.5 x 15.5 mm	0.5 mm	4 µm	18 N	.375" inch	•	NONE
2054318	OMI-301P-9	8 - 9" inch	203.2 -228.6 mm	0.02 inch	15.5 x 15.5 mm	0.5 mm	4 µm	18 N	.375" inch	•	NONE

Order no.	a	b	c	d	e
2054300	25.4 mm	150 mm	29 mm	145 mm	158 mm
2054306	50.8 mm	175 mm	29 mm	141 mm	154 mm
2054307	76.2 mm	200 mm	29 mm	155 mm	167 mm
2054313	101.6 mm	226 mm	29 mm	167 mm	180 mm
2054314	127 mm	251 mm	29 mm	180 mm	193 mm
2054315	152.4 mm	278 mm	30 mm	203 mm	215 mm
2054316	177.8 mm	303 mm	30 mm	213 mm	226 mm
2054317	203.2 mm	329 mm	30 mm	231 mm	244 mm
2054318	228.6 mm	335 mm	30 mm	248 mm	261 mm

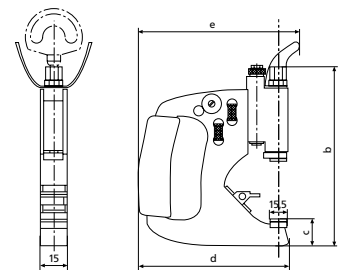

1004



1086 R-HR;
1086 R;1086 ZR

ACCESSORIES

Order no.	Description	Type
4332000	Millimess 0.01, ± 0.25 mm	1010
4333000	Millimess 5 µm, ± 130 µm	1004
4337620	Digital indicator, 0.0005 mm, 12.5 mm	1086 R
4337624	Digital indicator, 0.0005 mm, 12.5 mm	1086 Ri

Marameter 301P-1 ... 301P-9

Indicating snap gage

FEATURES

- Patented "Channel Lock" design assures precise parallel anvil surfaces throughout the full 25 mm / 1" range of adjustment
- All 300P series snap gages are fully adjustable with positive position locking at any point within the range
- 0.50 mm / .020" movement of sensitive contact
- Snap gages available over a wide range of sizes, styles, and readout configurations
- Large 15.5 mm / .61" square tungsten carbide anvils provide flat, parallel, working surfaces that ensure lasting precision that lasts
- Indicator can be rotated to read from front or rear of the gage
- All adjustments accomplished using a single hex wrench (included)
- Package contains: allen key

Applications:

- For rapid measurements of cylindrical parts such as shafts, bolts and spindles
- For thickness and length measurements



TECHNICAL DATA

Order no.	Type	Measuring range	Appl. range	Measuring span	Size of measuring surface	Measuring span	Parallelism deviation	Measuring force	Moun-ting hole for indicator	Lifting lever	Indicating instrument (included in package)
2050562	301P-1	0-1"	0-25.4	0.02	15.5 x 15.5	mm	4	18	.375"	•	IDT-102 Indicator (12I)
2050574	301P-2	1-2"	25.4-50.8	0.02	15.5 x 15.5	mm	4	18	.375"	•	IDT-102 Indicator (12I)
2050576	301P-3	2-3"	50.8-76.2	0.02	15.5 x 15.5	mm	4	18	.375"	•	IDT-102 Indicator (12I)
2050588	301P-4	3-4"	76.2-101.6	0.02	15.5 x 15.5	mm	4	18	.375"	•	IDT-102 Indicator (12I)
2050590	301P-5	4-5"	101.6-127	0.02	15.5 x 15.5	mm	4	18	.375"	•	IDT-102 Indicator (12I)
2050592	301P-6	5-6"	127-152.4	0.02	15.5 x 15.5	mm	4	18	.375"	•	IDT-102 Indicator (12I)
2050594	301P-7	6-7"	152.4-177.8	0.02	15.5 x 15.5	mm	4	18	.375"	•	IDT-102 Indicator (12I)
2050596	301P-8	7-8"	177.8-203.2	0.02	15.5 x 15.5	mm	4	18	.375"	•	IDT-102 Indicator (12I)
2050598	301P-9	8-9"	203.2-228.6	0.02	15.5 x 15.5	mm	4	18	.375"	•	IDT-102 Indicator (12I)

Order no.	a	b	c	d	e
	mm	mm	mm	mm	mm
2050562	25.4	150	29	145	158
2050574	50.8	175	29	141	154
2050576	76.2	200	29	155	167
2050588	101.6	226	29	167	180
2050590	127	251	29	180	193
2050592	152.4	278	30	203	215
2050594	177.8	303	30	213	226
2050596	203.2	329	30	231	244
2050598	228.6	335	30	248	261

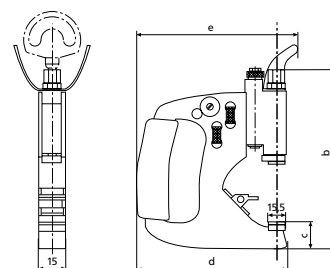

1004



1086 R-HR;
1086 R;1086 ZR

ACCESSORIES

Order no.	Description	Type
4332000	Millimess 0.01, ± 0.25 mm	1010
4333000	Millimess 5 µm, ± 130 µm	1004
4337620	Digital indicator, 0.0005 mm, 12.5 mm	1086 R
4337624	Digital indicator, 0.0005 mm, 12.5 mm	1086 Ri

Marameter 301 P

Indicating snap gage

FEATURES

- Patented "Channel Lock" design assures precise parallel anvil surfaces throughout the full 25 mm / 1" range of adjustment
- All 300P series snap gages are fully adjustable with positive position locking at any point within the range
- 0.50 mm / .020" movement of sensitive contact
- Snap gages available over a wide range of sizes, styles, and readout configurations
- Large 15.5 mm / .61" square tungsten carbide anvils provide flat, parallel, working surfaces that ensure lasting precision that lasts
- Indicator can be rotated to read from front or rear of the gage
- All adjustments accomplished using a single hex wrench (included)
- **Package contains:** allen key

Applications:

- For rapid measurements of cylindrical parts such as shafts, bolts and spindles
- For thickness and length measurements



TECHNICAL DATA

Order no.	Type	Appli- cation range	Size of measuring surface	Mea- suring span	Parallelism deviation	Mea- suring force	Mounting hole for indicator	Lifting lever	Indicating instrument (includ- ed in package)
		mm	mm	mm	µm	N	mm		
2003110	301 P	0–25.4	15.5 x 15.5	0.5	4	18	8	•	NONE
2003111	301 P	25.4 –50.8	15.5 x 15.5	0.5	4	18	8	•	NONE
2003112	301 P	50.8 –76.2	15.5 x 15.5	0.5	4	18	8	•	NONE
2003113	301 P	76.2 –101.6	15.5 x 15.5	0.5	4	18	8	•	NONE
2003114	301 P	101.6 –127	15.5 x 15.5	0.5	4	18	8	•	NONE
2003115	301 P	127 –152.4	15.5 x 15.5	0.5	4	18	8	•	NONE
2003116	301 P	152.4 –177.8	15.5 x 15.5	0.5	4	18	8	•	NONE
2003117	301 P	177.8 –203.2	15.5 x 15.5	0.5	4	18	8	•	NONE
2003118	301 P	203.2 –228.6	15.5 x 15.5	0.5	4	18	8	•	NONE

Order no.	b	c	d	e
	mm	mm	mm	mm
2003110	150	29	145	158
2003111	175	29	141	154
2003112	200	29	155	167
2003113	226	29	167	180
2003114	251	29	180	193
2003115	278	30	203	215
2003116	303	30	213	226
2003117	329	30	231	244
2003118	335	30	248	261

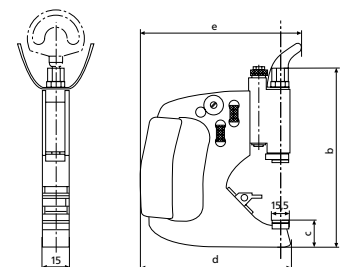

1004



1086 R-HR;
1086 R;1086 ZR

ACCESSORIES

Order no.	Description	Type
4332000	Millimess 0.01, ± 0.25 mm	1010
4333000	Millimess 5 µm, ± 130 µm	1004
4337620	Digital indicator, 0.0005 mm, 12.5 mm	1086 R
4337624	Digital indicator, 0.0005 mm, 12.5 mm	1086 Ri

Marameter 852 TS / 852 TSZ

Indicating bench snap gage

FEATURES

- Rugged steel frame can be inclined up to 45° from the sturdy base
- Measuring spindle and anvil are made of hardened stainless steel with mounting bore for insertion of interchangeable anvils
- Height adjustable stop
- Anvil spindle can easily be fine adjusted
- Constant measuring force as a result of built-in spring, eliminating user influence
- **Package contains:** plan carbide anvils diameter 3.5 mm



Applications:

- Perfect ergonomic design as base can be inclined ensuring it is easy to read and the operator has free hands
- For rapid measurements of cylindrical parts (shafts, bolts and shanks)
- Thickness and length measurements
- For determining the pitch diameter of external threads (optionally with thread flank measuring anvils)
- For gears (optionally with sphere or roller measuring anvils)
- Particularly suited for exact series measurements

TECHNICAL DATA

Order no.	4510030	4510031	4510035
Type	852 TS		852 TSZ
Application range	mm	0 – 80	
Application range	inch	0 – 3.15"	
Measuring span	mm	1.2	
Parallelism deviation	µm	2	
Flatness deviation	µm	0.3	
Measuring force	N	7.5	
Mounting hole for indicator	8 mm	8 mm	.375 inch
Indicating instrument (included in package)	Millimess 1003	Without	Without

ACCESSORIES

Order no.	Description	Type
4333000	Millimess 5 µm, ± 130 µm	1004
4334000	Millimess 1 µm, ± 50 µm	1003
4334001	Millimess 2 µm, ± 130 µm	1003 XL
4335000	Millimess 0.5 µm, ± 25 µm	1002
4337620	Digital indicator, 0.0005 mm, 12.5 mm	1086 R
4337624	Digital indicator, 0.0005 mm, 12.5 mm	1086 Ri



1004



1003



1002



1086 R

Marameter 852

Indicating thread snap gage

FEATURES

- Rugged, forged steel frame with heat insulators
- Measuring spindle is mounted in long guideway with lever controlled retraction
- Measuring spindle and anvil are made of hardened stainless steel with mounting bore for insertion of interchangeable anvils
- Adjustable center stop for automatic alignment
- Anvil spindle can easily be fine adjusted
- Constant measuring force as a result of built-in spring, eliminating user influence
- Maximum wear resistance due to noncontact positioning in conjunction with carbide tipped measuring faces
- **Package contains:** flat contact point 903 (steel), wooden case, excludes indicator



Applications:

- For measuring pitch, root and outside diameters of all kinds of external threads as well as serrations
- Universally applicable and extremely versatile; each instrument spans a broad measuring range

TECHNICAL DATA

Order no.		4510000	4510001	4510002	4510003
Type		852			
Application range	mm	0–45	45–85	85–140	140–190
Application range	inch	0–1.77"	1.77–3.34"	3.34–5.51"	5.51–7.48"
Measuring span	mm	2		2.5	
Repeatability f_w	μm		1		
Measuring force	N		7.5		9
Frame size		2	3	4	5

Order no.	a	b	c	e	f	g	h	k	l
	mm	mm	mm	mm	mm	mm	mm	mm	mm
4510000	13	140	68	60	77	13	13	25	34
4510001	8	193	11	60	103	14	13	28	59
4510002	10	258	162	70	141	16	12	31	87
4510003	6	316	212	75	171	16	12	31	112

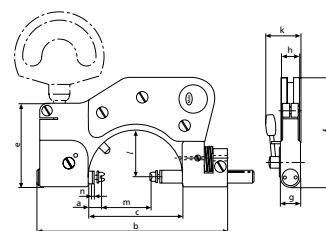

ACCESSORIES

Order no.	Description	Type
4333000	Millimess 5 μm , $\pm 130 \mu\text{m}$	1004
4334000	Millimess 1 μm , $\pm 50 \mu\text{m}$	1003
4334001	Millimess 2 μm , $\pm 130 \mu\text{m}$	1003 XL
4335000	Millimess 0.5 μm , $\pm 25 \mu\text{m}$	1002
4337620	Digital indicator, 0.0005 mm, 12.5 mm	1086 R
4337624	Digital indicator, 0.0005 mm, 12.5 mm	1086 Ri
4450051	Holder, frame size 2	840 Fk/2
4450020	Base for stationary application	840 Ff
4173210	Anvil flat, hardened steel, $\varnothing 7.5 \text{ mm}$	40 Za
4511190	Anvil flat, carbide tipped, $\varnothing 7.5 \text{ mm}$	40 Za
4450052	Holder, frame size 3	840 Fk/3
4450053	Holder, frame size 4 + 5	840 Fk/4



1004



1003



1002



1086 R



840 Fk/2

Marameter thread anvils

Indicating thread snap gage

FEATURES

- For pitch diameters
- Wear-resistant special steel, hardened
- With cylindrical mounting shank and retainer ring for rotatable mounting in the bore of the dial comparator snap gage
- Pair comprises V-anvil and cone
- With a pitch of 0.2 –0.45 mm, the V-anvil bridges 3 turns
- It should therefore be set with 715 E thread adjustment pins, otherwise with 43 Z setting standards

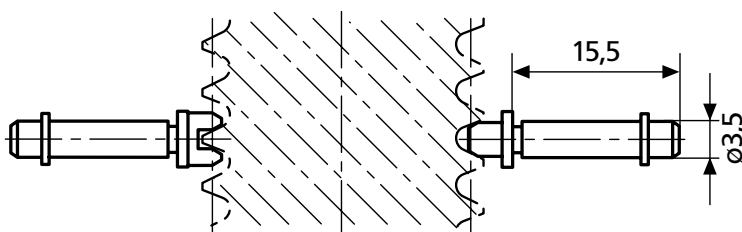

ACCESSORIES

Thread pitch	Blade Order no.	V-anvil Order no.
Pitch diameter, external thread		
Metric 60°		
0.2	4173007	4173707
0.25	4173008	4173708
0.3	4173009	4173709
0.35	4173010	4173710
0.4	4173011	4173711
0.45	4173012	4173712
0.5 –0.7	4173000	4173700
0.7 –1	4173001	4173701
1.25 –2	4173002	4173702
2 –3.5	4173003	4173703
3.5 –5	4173004	4173704
5 –7	4173005	4173705
7 –9	4173006	4173706

Thread pitch in TPI	Blade Order no.	V-anvil Order no.
UST 60°		
10 –7	4173120	4173820
14 –10	4173119	4173819
18 –14	4173118	4173818
24 –18	4173117	4173817
32 –24	4173116	4173816
4.5 –3	4173122	4173822
40 –32	4173115	4173815
48 –40	4173114	4173814
7 –4.5	4173121	4173821
Whitworth 55°		
10 –7	4173048	4173748
14 –10	4173047	4173747
18 –14	4173046	4173746
24 –18	4173045	4173745
3 –2.5	4179408	4179410
32 –24	4173044	4173744
4.5 –3	4173050	4173750
40 –32	4173043	4173743
7 –4.5	4173049	4173749

Marameter

Ball contact

FEATURES

- For gear measurement and for special tasks
- Carbide measuring balls
- Cylindrical mounting shank with circlip for mounting in the mounting bore of the micrometer or indicating snap gage

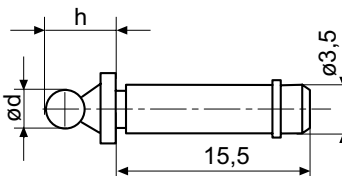

Order no.	d mm	h mm	Measuring surface
4179150	0.5	5	Carbide
4179151	0.551	5.1	Carbide
4179152	0.62	5.1	Carbide
4179153	0.623	5.1	Carbide
4179154	0.63	5.1	Carbide
4179155	0.722	5.2	Carbide
4179156	0.862	5.4	Carbide
4179157	0.895	5.4	Carbide
4179158	0.965	5.5	Carbide
4170550	1	5.5	Carbide
4179159	1.1	5.6	Carbide
4179160	1.118	5.6	Carbide
4170551	1.25	5.8	Carbide
4179161	1.125	5.6	Carbide
4179162	1.35	5.9	Carbide
4179163	1.372	5.9	Carbide
4179164	1.385	5.9	Carbide
4170552	1.5	6	Carbide
4179165	1.524	6	Carbide
4179166	1.54	6	Carbide
4179167	1.6	6.1	Carbide
4179168	1.65	6.2	Carbide
4179169	1.7	6.2	Carbide
4170553	1.75	6.3	Carbide
4179170	1.782	6.3	Carbide
4179171	1.8	6.3	Carbide
4179172	1.829	6.3	Carbide
4179173	1.9	6.4	Carbide
4170554	2	6.5	Carbide
4170568	2.032	6.5	Carbide
4170569	2.2	6.7	Carbide
4170564	2.25	6.8	Carbide
4179174	2.284	6.8	Carbide

Order no.	d mm	h mm	Measuring surface
4179175	2.386	6.9	Carbide
4179176	2.438	6.9	Carbide
4170556	2.5	7	Carbide
4179177	2.667	7.2	Carbide
4179178	2.704	7.2	Carbide
4179179	2.713	7.2	Carbide
4179180	2.721	7.2	Carbide
4179181	2.743	7.2	Carbide
4170565	2.75	7.3	Carbide
4170557	3	7.5	Carbide
4179182	3.048	7.5	Carbide
4170570	3.2	7.7	Carbide
4170566	3.25	7.8	Carbide
4179183	3.4	7.9	Carbide
4170558	3.5	8	Carbide
4179184	3.658	8.2	Carbide
4170571	3.7	8.2	Carbide
4170559	4	8.5	Carbide
4170560	4.5	9	Carbide
4179185	4.835	9.3	Carbide
4170561	5	9.5	Carbide
4179186	5.25	9.8	Carbide
4179187	5.486	10	Carbide
4170562	5.5	10	Carbide
4170563	6	10.5	Carbide
4179188	6.096	10.6	Carbide
4179189	6.35	10.9	Carbide
4170567	6.5	11	Carbide
4170572	7	11.5	Carbide
4170573	8	12.5	Carbide
4170574	9	13.5	Carbide
4170575	10	14.5	Carbide

Marameter

Carbide roller blades

FEATURES

- For gear measurement and for special tasks
- Carbide contact roller
- Cylindrical mounting shank with circlip for mounting in the mounting bore of the micrometer or indicating snap gage

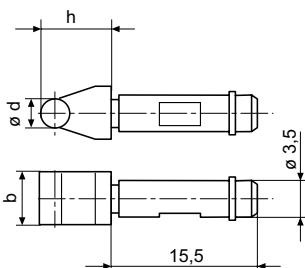

Order no.	B mm	b mm	d mm	h mm	Measuring surface
4510200	5.00	5	1	5.5	Carbide
4510201	5.00	5	1.25	5.8	Carbide
4510202	5.00	5	1.5	6	Carbide
4510203	5.00	5	1.75	6.3	Carbide
4510204	5.50	5	2	6.5	Carbide
4510206	5.50	5.5	2.5	7	Carbide
4510207	5.50	5.5	3	7.5	Carbide
4510208	5.50	5.5	3.5	8	Carbide
4510209	5.50	5.5	4	8.5	Carbide
4510210	5.50	5.5	4.5	9	Carbide
4510211	6.00	6	5	9.5	Carbide
4510212	6.00	6	5.5	10	Carbide
4510213	6.00	6	6	10.5	Carbide

Marameter 853

Indicating thread snap gage

FEATURES

- Rugged, forged steel frame with heat insulators
- Measuring spindle is mounted in long guideway with lever controlled retraction
- Anvil spindle adjustable with thumbscrew via worm and rack, for mounting interchangeable support yokes
- Measuring spindle and anvil are made of hardened stainless steel with mounting bore for insertion of interchangeable anvils
- Anvil spindle can easily be fine adjusted
- Constant measuring force as a result of built-in spring, eliminating user influence
- Maximum wear resistance due to noncontact positioning
- **Package contains:** flat contact point 903 (steel), wooden case, excludes indicator



Applications:

- For pitch, root and outside diameters on taps in conjunction with interchangeable anvils
- Universally applicable and extremely versatile; each instrument spans a broad measuring range

TECHNICAL DATA

Order no.	4511000		4511001	
Type			853	
Application range mm	mm	1.2 – 35	35 – 75	
Application range	inch	.04 – 1.37"	1.37 – 3"	
Measuring span	mm	8		
Repeatability f_w	μm	2		
Measuring force	N	7.5		

Order no.	a	b	c	e	f	g	h	n
	mm	mm	mm	mm	mm	mm	mm	mm
4511000	12	152	66	60	98	14	11.5	8
4511001	11.5	192	110	65	125	14	14	8

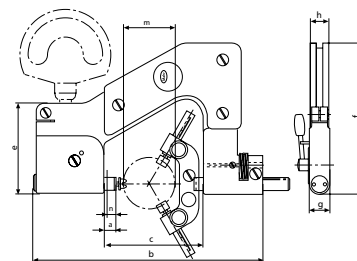

ACCESSORIES

Order no.	Description	Type
4334001	Millimess 2 μm , $\pm 130 \mu\text{m}$	1003 XL
4333000	Millimess 5 μm , $\pm 130 \mu\text{m}$	1004
4332000	Millimess 0.01 μm , $\pm 0.25 \text{ mm}$	1010
4337620	Digital indicator, 0.0005 mm, 12.5 mm	1086 R
4337624	Digital indicator, 0.0005 mm, 12.5 mm	1086 Ri
4511024	Interchangeable support yoke 3 flutes of taps for 1.2–35 mm range	853 qk 3
4511025	Interchangeable support yoke 3 flutes of taps for 35–75 mm range	853 qg 3
4511026	Interchangeable support yoke 5 flutes of taps for 1.2–35 mm range	853 qk 5
4511027	Interchangeable support yoke 5 flutes of taps for 35–75 mm range	853 qg 5
4511028	Interchangeable support yoke 7 flutes of taps for 1.2–35 mm range	853 qk 7
4511029	Interchangeable support yoke 7 flutes of taps for 35–75 mm range	853 qg 7
4511190	Anvil flat, carbide tipped, $\varnothing 7.5 \text{ mm}$	40 Za
4173210	Anvil flat, hardened steel, $\varnothing 7.5 \text{ mm}$	40 Za



1004



1086 R

Marameter thread anvils

Indicating thread snap gage

FEATURES

- For pitch diameters
- Wear-resistant special steel, hardened
- With cylindrical mounting shank and retainer ring for rotatable mounting in the bore of the dial comparator snap gage
- Adjustment with threaded setting plug 715 E

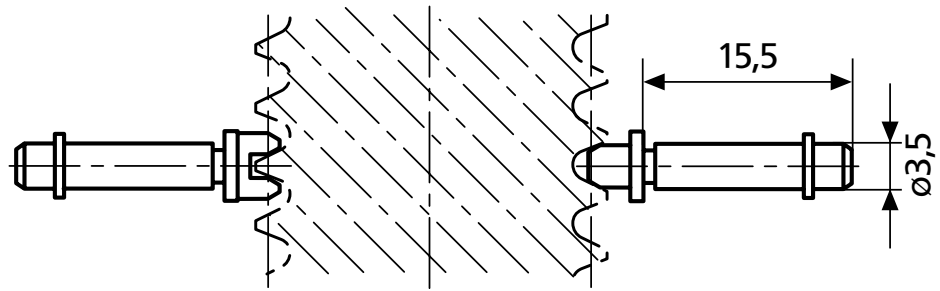

ACCESSORIES

Thread pitch	Blade Order no.	V-anvil Order no.
Pitch diameter, external thread		
Metric 60°		
0.2	4173051	4174007
0.25	4173052	4174008
0.3	4173053	4174009
0.35	4173054	4174010
0.4	4173055	4174011
0.45	4173056	4174012
0.5–0.7	4173000	4174000
0.7–1	4173001	4174001
1.25–2	4173002	4174002
2–3.5	4173003	4174003
3.5–5	4173004	4173704
5–7	4173005	4174005
7–9	4173006	4174006

Thread pitch in TPI	Blade Order no.	V-anvil Order no.
UST 60°		
60–48	4173124	4176113
48–40	4173125	4176114
40–32	4173115	4176115
32–24	4173116	4176116
24–18	4173117	4176117
18–14	4173118	4176118
14–10	4173119	4176119
10–7	4173120	4176120
7–4.5	4173121	4176121
4.5–3	4173122	4176122
Whitworth 55°		
40–32	4173043	4176043
32–24	4173044	4176044
24–18	4173045	4176045
18–14	4173046	4176046
14–10	4173047	4176047
10–7	4173048	4176048
7–4.5	4173049	4176049
4.5–3	4173050	4176050
3–2.5	4179408	4179411



FEATURES

- Indicator built into gage frame for maximum ruggedness
- Lift lever for one hand operation
- Continuous reading dials with revolution counter for absolute measurement of thin materials, plastic films and small parts
- 6.3 mm / .25" diameter, flat steel contacts
- **Data interface:** Digimatic, RS-232C, USB
- **Energy supply:** battery operation
- **Package contains:** includes indicator

Application:

- Thickness measurement of small parts from 0 to 1.0 inch



TECHNICAL DATA

Order no.	2057541	
Type	XLI-22P-20	
Measuring range	mm	0 – 25
Measuring range	inch	0 – 1"
Jaw depth	mm	50
Resolution	mm	0.0005, 0.001, 0.002, 0.005, 0.01
Resolution	inch	.00002", .00005", .0001", .0002", .0005"
Size of measuring surface	6.3 mm / 0.25" steel contacts	
Indicating instrument (included in package)	4337651 (1086 ZR)	

ACCESSORIES

Order no.	Description	Type
2003150	Base/bench stand for 300P or 1000P style snap gage	BA-26

Marameter 22P-11 / 22P-15 / 22P-20

Portable thickness gages

FEATURES

- Indicator built into gage frame for maximum ruggedness
- Lift lever for one hand operation
- Continuous reading dials with revolution counter for absolute measurement of thin materials, plastic films and small parts
- 6.3 mm / .25" diameter, flat steel contacts
- **Data interface:** none
- **Package contains:** includes indicator



Application:

- Thickness measurement of small parts from 0 to 1.0 inch, depending on model

TECHNICAL DATA

Order no.		2050446	2050447	2050449
Type		22P-11	22P-15	22P-20
Measuring range	inch	0 – .10"	0 – .50"	0 – 1"
Scale graduation value	inch	.0001"	.001"	
Size of measuring surface		6.3 mm / 0.25" steel contacts		
Indicating instrument (included in package)		Integral indicator (22IN-RC dial)	Integral indicator (28IQN dial)	Integral indicator (28ISN dial)

ACCESSORIES

Order no.	Description	Type
2003150	Base/bench stand for 300P or 1000P style snap gage	BA-26

Marameter 22P–10M / 22P–15M / 22P–20M

Portable thickness gages

FEATURES

- Indicator built into gage frame for maximum ruggedness
- Lift lever for one hand operation
- Continuous reading dials with revolution counter for absolute measurement of thin materials, plastic films and small parts
- 6.3 mm / .25" diameter, flat steel contacts
- **Data interface:** none
- **Package contains:** includes indicator



Application:

- Thickness measurement of small parts from 0 to 25.4mm

TECHNICAL DATA

Order no.	2050445	2050448	2050450
Type	22P–10M	22P–15M	22P–20M
Measuring range	mm 0 –2.54	0 –12.7	0 –25
Jaw depth	mm 28.6		50
Readings	inch 0.002		0.01
Size of measuring surface	6.3 mm / 0.25" steel contacts		
Indicating instrument (included in package)	Integral indicator (P11-RC dial)	Integral indicator (26I-RC dial)	

ACCESSORIES

Order no.	Description	Type
2003150	Base/bench stand for 300P or 1000P style snap gage	BA–26

Marameter XLI-57B-15

Portable thickness gages



FEATURES

- Solid casting with ribbed frame provides strength and rigidity for accurate measurements
- 0.003 mm / .0001" parallelism with tables up to 19 mm / .75" diameter
- 283 g / 10 oz. dead weight load for constant gaging pressure
- 10 mm / .407" diameter flat upper 54.0 mm / 2.125" lower contacts
- Indicator mounts with adjustable back for quick positioning for each gaging requirement
- Digital indicator includes Integrated Wireless transmitter
- With lift lever so work can be easily placed between the table and contact
- Four inch throat depth for part clearance
- **Data interface:** Digimatic, RS-232C, USB, Integrated Wireless
- **Energy supply:** battery operation
- **Package contains:** includes indicator



Application:

- Precision thickness measurement requiring dead weight load force

TECHNICAL DATA

Order no.		2057551
Type		XLI-57B-15
Measuring range	mm	0 -25
Measuring range	inch	0 -1"
Jaw depth	mm	102
Resolution	mm	0.0005, 0.001, 0.002, 0.005, 0.01
Resolution	inch	0.00002, 0.00005, 0.0001, 0.0002, 0.0005
Parallelism deviation	µm	3
Measuring force	N	2.78 N / 10 oz dead weight
Indicating instrument (included in package)		4337628 (1086Ri)

Marameter 57B–14 / 57B–15

Portable thickness gages

FEATURES

- Solid casting with ribbed frame provides strength and rigidity for accurate measurements
- 0.003 mm / .0001" parallelism with tables up to 19 mm / .75" diameter
- 283 g / 10 oz. dead weight load for constant gaging pressure
- 10 mm / .407" diameter flat upper 54.0 mm / 2.125" lower contacts
- Indicator mounts with adjustable back for quick positioning for each gaging requirement
- Digital indicator includes Integrated Wireless transmitter
- With lift lever so work can be easily placed between the table and contact
- Four inch throat depth for part clearance
- **Data interface:** none
- **Package contains:** includes indicator



Application:

- Precision thickness measurement requiring dead weight load force

TECHNICAL DATA

Order no.		2050982	2050984
Type		57B–14	57B–15
Measuring range	inch	0 – .10"	0 – 1"
Scale graduation value	inch	.0001"	.001"
Resolution	inch	0.0001	0.001
Measuring force	N	2.78 N (10oz dead weight)	
Indicating instrument (included in package)		IDT–340 Indicator (32I-RC)	IDS–341 Indicator (D8IS)

Marameter 57B–14M / 57B–15M

Portable thickness gages

FEATURES

- Solid casting with ribbed frame provides strength and rigidity for accurate measurements
- 0.003 mm / .0001" parallelism with tables up to 19 mm / .75" diameter
- 283 g / 10 oz. dead weight load for constant gaging pressure
- 10 mm / .407" diameter flat upper 54.0 mm / 2.125" lower contacts
- Indicator mounts with adjustable back for quick positioning for each gaging requirement
- Digital indicator includes Integrated Wireless transmitter
- With lift lever so work can be easily placed between the table and contact
- Four inch throat depth for part clearance
- **Data interface:** none
- **Package contains:** includes indicator



Application:

- Precision thickness measurement requiring dead weight load force

TECHNICAL DATA

Order no.	2050983		2050985	
Type		57B–14M		57B–15M
Measuring range	mm	0 –2.5		0 –25
Jaw depth	mm		102	
Readings		0.002		0.01
Measuring force	N	2.78 N (10 oz dead weight)		
Indicating instrument (included in package)		IDS–342 indicator (Q11-RC)		IDS–343 indicator (SQ6IS)



FEATURES

- Using the basic design of the Model 57B-13 gage, the lower contact is PT-103, 1.10 mm / .043" diameter rod, mounted horizontally
- Upper contact is a flat chisel contact in line with the rod
- By slipping tubular parts onto the lower contact, the gage can measure the wall thickness of the tube
- An auxiliary weight on the indicator provides a total dead weight load of 25 grams
- Digital indicator includes integrated wireless transmitter
- **Data interface:** Digimatic, Opto RS-232C, USB, Integrated Wireless
- **Energy supply:** battery operation
- **Package contains:** includes indicator



Application:

- For checking wall thickness of wire insulation and other small diameter tubular parts

TECHNICAL DATA

Order no.	2057550	
Type	XLI-57B-13	
Measuring range	mm	0 - 7.62
Measuring range	inch	0 - .30"
Jaw depth	mm	102
Resolution	mm	0.0005, 0.001, 0.002, 0.005, 0.01
Resolution	inch	0.00002, 0.00005, 0.0001, 0.0002, 0.0005
Measuring force	N	0.25
Indicating instrument (included in package)	4337628 (1086Ri)	

ACCESSORIES

Order no.	Description	Type
2225698	Replacement rod for PT-103 pin, 0.043" diameter 0.687" length	PS-43
2225741	Pin, Ø=1.10mm / .043", lower contact 1.10 mm / 0.043" diameter pin, lower contact assembly	PT-103
2225869	Pin, Ø=0.05mm / .02", lower contact 0.050 mm / 0.020 in diameter pin, lower contact assembly	PT-2245

Marameter 57B-13

Portable thickness gages

FEATURES

- Using the basic design of the Model 57B-13 gage, the lower contact is PT-103, 1.10 mm / .043" diameter rod, mounted horizontally
- Upper contact is a flat chisel contact in line with the rod
- By slipping tubular parts onto the lower contact, the gage can measure the wall thickness of the tube
- An auxiliary weight on the indicator provides a total dead weight load of 25 grams
- Digital indicator includes Integrated Wireless transmitter
- **Data interface:** none
- **Package contains:** includes indicator



Application:

- For checking wall thickness of wire insulation and other small diameter tubular parts

TECHNICAL DATA

Order no.	2050980	
Type		57B-13
Measuring range	inch	0 – .30"
Jaw depth	mm	102
Scale graduation value	inch	.0005"
Resolution	inch	0.0005
Measuring force	N	0.25
Indicating instrument (included in package)		IDS-116 indicator (25M-RC)

ACCESSORIES

Order no.	Description	Type
2225698	Replacement rod for PT-103 pin, 0.043" diameter 0.687" length	PS-43
2225741	Pin, Ø=1.10mm / .043", lower contact 1.10 mm / 0.043" diameter pin, lower contact assembly	PT-103
2225869	Pin, Ø=0.05mm / .02", lower contact 0.050 mm / 0.020 in diameter pin, lower contact assembly	PT-2245

Marameter 57B–13M

Portable thickness gages

FEATURES

- Using the basic design of the Model 57B–13 gage, the lower contact is PT–103, 1.10 mm / .043" diameter rod, mounted horizontally
- Upper contact is a flat chisel contact, in line with the rod
- By slipping tubular parts onto the lower contact, the gage can measure the wall thickness of the tube
- An auxiliary weight on the indicator provides a total dead weight load of 25 grams
- Digital indicator includes Integrated Wireless transmitter
- **Data interface:** none
- **Package contains:** includes indicator



Application:

- For checking wall thickness of wire insulation and other small diameter tubular parts

TECHNICAL DATA

Order no.	2050981	
Type		57B–13M
Measuring range	mm	0 –7.6
Jaw depth	mm	102
Readings		0.01
Measuring force	N	0.25
Indicating instrument (included in package)		IDS–287 indicator (26I-RC)

Marameter EMD-57B-11 / EMD-57B-11D

Portable thickness gages



FEATURES

- Solid casting with ribbed frame provides strength and rigidity for accurate measurements
- Furnished with a lift lever so work can be easily placed between the contacts
- Large 54 mm/ 2.125" diameter lower anvil provides convenient stage for small parts or flat materials
- 4.75 mm/ .187" diameter radiused upper contact normally provided
- 102 mm/ 4" throat depth for part clearance
- Indicator mounts with adjustable back for quick positioning for each gaging requirement
- Available with dial indicator or digital electronic indicator
- **Data interface:** none
- **Energy supply:** battery operation
- **Package contains:** includes indicator



Application:

- Precision thickness measurement

TECHNICAL DATA

Order no.		2051884	2051885	2057548	2057549
Type		EMD-57B-11	EMD-57B-11D		
Measuring range	mm	0 - 21.5		0 - 25	0 - 12.5
Measuring range	inch	0 - 1"			
Jaw depth	mm	102			
Resolution	mm	0.0005, 0.001, 0.005		0.0005, 0.001, 0.002, 0.005, 0.01	
Resolution	inch	0.00002, 0.00005, 0.0001, 0.0005		0.00002, 0.00005, 0.0001, 0.0002, 0.0005	
Indicating instrument (included in package)		2033101 Maxµm III	2033111 Maxµm III	4337651 (1086ZR)	4337650 (1086 ZR)

Marameter 57B–11 / 57B–12

Portable thickness gages

FEATURES

- Solid casting with ribbed frame provides strength and rigidity for accurate measurements
- Furnished with a lift lever so work can be easily placed between the contacts
- Large 54 mm/ 2.125" diameter lower anvil provides convenient stage for small parts or flat materials
- 4.75 mm/ .187" diameter radiused upper contact normally provided
- 102 mm/ 4" throat depth for part clearance
- Indicator mounts with adjustable back for quick positioning for each gaging requirement
- Available with dial indicator or digital electronic indicator
- **Data interface:** none
- **Package contains:** includes indicator



Application:

- Precision thickness measurement

TECHNICAL DATA

Order no.		2050976	2050978
Type		57B–11	57B–12
Measuring range	inch	0 –1"	0 –.50"
Jaw depth	mm		102
Scale graduation value	inch	.001"	.0005"
Resolution	inch	0.001	0.0005
Indicating instrument (included in package)		IDS–160 indicator (D8IS)	IDS–161 indicator (D7I-RC)

Marameter 57B–11M / 57B–12M

Portable thickness gages

FEATURES

- Solid casting with ribbed frame provides strength and rigidity for accurate measurements
- Furnished with a lift lever so work can be easily placed between the contacts
- Large 54 mm/ 2.125" diameter lower anvil provides convenient stage for small parts or flat materials
- 4.75 mm/ .187" diameter radiused upper contact normally provided
- 102 mm/ 4" throat depth for part clearance
- Indicator mounts with adjustable back for quick positioning for each gaging requirement
- Available with dial indicator or digital electronic indicator
- **Data interface:** none
- **Package contains:** includes indicator



Application:

- Precision thickness measurement

TECHNICAL DATA

Order no.	2050977	2050979
Type	57B–11M	57B–12M
Measuring range	mm 0–25	0–12.5
Jaw depth	mm 102	
Readings		0.01
Indicating instrument (included in package)	IDS–285 indicator (SQ6IS)	IDS–286 indicator (SQ6I)

Marameter 838 TAZ

Caliper gage for external measurement



FEATURES

- Contact points made of carbide
- Absolute measuring instrument
- Easy-to-read tolerance markers
- IP protection category: IP 65
- Package contains: test certificate
- Easy to operate, portable and user-friendly

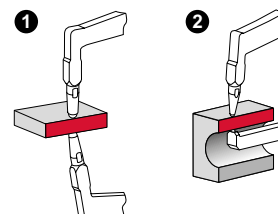

Application:

- For measuring thicknesses and wall thicknesses

TECHNICAL DATA

Order no.	Type	Measuring range	Scale graduation value	Measuring depth	Error limit G_e	Dimension L	Form of measuring contacts	Measuring force
		inch	inch	inch	inch	inch		N
4495950	838 TAZ	0 – .40"	.0002"	1.37"	0.0008	1.37"	1	0.8 – 1.2
4495951	838 TAZ	0 – .80"	.0005"	3.2"	0.0015	3.2"	1	1.1 – 1.6
4495952	838 TAZ	0 – .80"	.0005"	3.2"	0.0015	3.2"	2	1.1 – 1.6
4495955	838 TAZ	0 – 2.0"	.001"	6.6"	0.002	6.6"	1	0.8 – 1.7
4495956	838 TAZ	0 – 2.0"	.001"	6.7"	0.002	6.7"	2	0.8 – 1.7

Order no.	Dimension L
	inch
4495950	1.37"
4495951	3.2"
4495952	3.2"
4495955	6.6"
4495956	6.7"

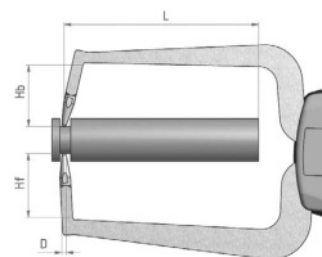

Marameter 838 TA

Caliper gage for external measurement

FEATURES

- Contact points made of carbide
- Absolute measuring instrument
- Easy-to-read tolerance markers
- IP protection category: IP 65
- Package contains:
test certificate
- Easy to operate, portable and user-friendly

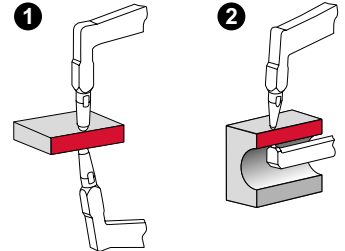

Application:

- For measuring thicknesses and wall thicknesses

TECHNICAL DATA

Order no.	Type	Appli- cation range	Measuring range	Rea- dings	Mea- suring depth	Error limit	Repea- tability	Dimen- sion L	Form of measuring contacts	Measuring contact ball diameter	Mea- suring force
		mm	mm	inch	mm	mm	mm	mm		mm	N
4495550	838 TA	0 – 10	0 – 10	0.005	35	0.015	0.005	35	1	1.5	0.8 – 1.2
4495551	838 TA	0 – 20	0 – 20	0.01	85	0.03	0.01	85	1	1.5	1.1 – 1.6
4495552	838 TA	0 – 20	0 – 20	0.01	85	0.03	0.01	85	2	1.5	1.1 – 1.6
4495555	838 TA	0 – 50	0 – 50	0.05	167	0.05	0.025	167	1	3	0.8 – 1.7
4495556	838 TA	0 – 50	0 – 50	0.05	169	0.05	0.025	169	2	3	0.8 – 1.7

Order no.	D	Hb	Hf	L
	mm	mm	mm	mm
4495550	1.5	19.1	18.6	35
4495551	1.5	24.6	24.6	85
4495552	1.5	24.6	2.5	85
4495555	3	30	30	167
4495556	3	30	4.3	169

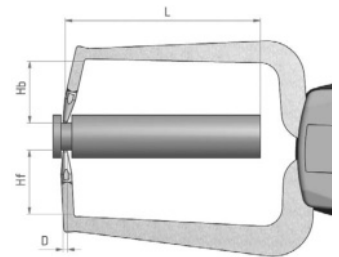

Marameter 838 EA

Digital outer quick probe



FUNCTIONS

- ON/OFF
- mm/inch
- TOL (enter tolerance limit values)
- ABS (display can be set to zero without losing reference to preset)
- DATA (in connection with data interface)

FEATURES

- High contrast analog and digital LCD
- Tolerance displayed via LED (red/green)
- **Data interface:** Digimatic, USB, Bluetooth (optional accessory)
- **Energy supply:** Battery operation (2x 1.5V AAA)
- **IP protection category:** IP 67
- **Package contains:** instruction manual, battery, test certificate

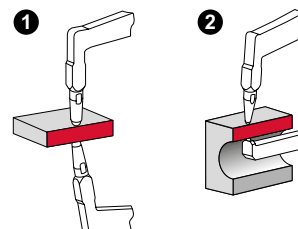

Application:

- Specified measuring programs according to application
- Absolute/relative measuring program

TECHNICAL DATA

Order no.	Type	Measuring range	Resolution	Measuring depth	Error limit	Repeatability	Form of measuring contacts	Measuring contact ball diameter	Measuring force	Bluetooth option
		mm	mm	mm	mm	mm		mm	N	
4495450	838 EA	0–10	0.001, 0.002, 0.005, 0.01, 0.02, 0.05	35	0.015	0.005	1	1.5	0.8–1.2	•
4495451	838 EA	0–20	0.001, 0.002, 0.005, 0.01, 0.02, 0.05	85	0.03	0.01	1	1.5	1.1–1.6	•
4495452	838 EA	0–20	0.001, 0.002, 0.005, 0.01, 0.02, 0.05	85	0.03	0.01	2	1.5	1.1–1.6	•
4495453	838 EA	0–30	0.001, 0.002, 0.005, 0.01, 0.02, 0.05	116	0.04	0.02	1	3	0.9–1.6	•
4495454	838 EA	0–50	0.001, 0.002, 0.005, 0.01, 0.02, 0.05	167	0.05	0.03	1	3	0.8–1.7	•
4495455	838 EA	0–30	0.001, 0.002, 0.005, 0.01, 0.02, 0.05	116	0.04	0.02	2	3	0.9–1.6	•
4495456	838 EA	0–50	0.001, 0.002, 0.005, 0.01, 0.02, 0.05	169	0.05	0.03	2	3	0.8–1.7	•

Order no.	D	Hb	Hf	L
	mm	mm	mm	mm
4495450	1.5	19.1	18.6	35
4495451	1.5	24.6	24.6	85
4495452	1.5	24.6	2.5	85
4495453	3	30	30	116
4495454	3	30	30	167
4495455	3	30	4	116
4495456	3	30	4.3	169

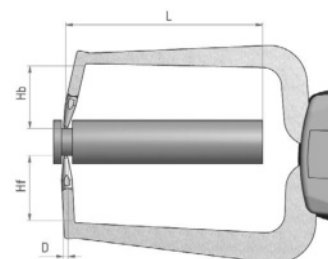

ACCESSORIES

Order no.	Description	Type
4495036	Bluetooth interface for 838 EI/EA, including USB dongle BT4.0	838 BT
4495079	838 USB interface adapter with data connection cable USB (1.5 m)	838 USB
4495083	Interface adapter with data cable digimatic (1.5 m)	838 di (A)



838 BT

Marameter 838 TIZ

Caliper gage for internal measurement



FEATURES

- Contact points made of carbide
- Absolute measuring instrument
- Easy-to-read tolerance markers
- IP protection category: IP 65
- Package contains: test certificate
- Easy to operate, portable and user-friendly



Application:

- For measuring bores and internal grooves

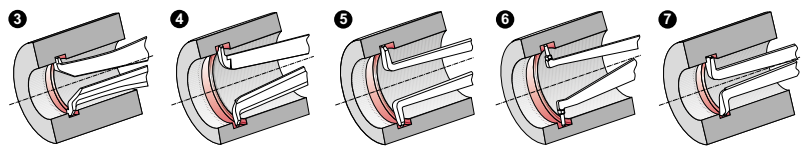

TECHNICAL DATA

Order no.	4495980	4495981	4495982	4495983	4495984	4495985	4495986	4495987	
Type	838 TIZ								
Measuring range	inch .20 – .60"	.40 – 1.20"	.80 – 1.60"	1.20 – 2.00"	1.60 – 2.40"	2.00 – 2.80"	.60 – 2.60"	1.60 – 3.60"	
Scale graduation value	inch .0002"	.0005"						.001"	
Measuring depth	inch 1.37"	3.2"				7.5"			7.6"
Error limit G_e	inch 0.0008	0.0015				0.002			
Form of measuring contacts	4		5		6		7	6	
Measuring force	N 0.8 – 1.2	1.1 – 1.6				0.9 – 1.9			

Order no.	Dimension L
	inch
4495980	1.37"
4495981	3.2"
4495982	3.2"
4495983	3.2"
4495984	3.2"
4495985	3.2"
4495986	7.5"
4495987	7.6"

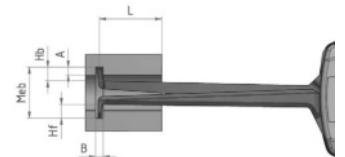

Marameter 838 TI

Caliper gage for internal measurement



FEATURES

- Contact points made of carbide
- Absolute measuring instrument
- Easy-to-read tolerance markers
- IP protection category: IP 65
- Package contains: test certificate
- Easy to operate, portable and user-friendly



Application:

- For measuring bores and internal grooves

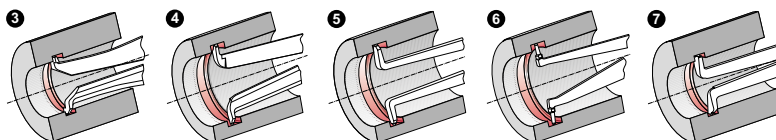

TECHNICAL DATA

Order no.		4495580	4495581	4495582	4495583	4495584	4495585	4495586	4495587
Type		838 TI							
Measuring range	mm	5 – 15	10 – 30	20 – 40	30 – 50	40 – 60	50 – 70	15 – 65	40 – 90
Readings	inch	0.005		0.01				0.05	
Measuring depth	mm	35		85				188	192
Error limit	mm	0.015		0.03				0.05	
Repeatability	mm	0.005		0.01				0.025	
Groove depth	mm	2.3	5.2	7		8.3		5.5	8.3
Groove width	mm	0.8		1.2				1.9	2.4
Form of measuring contacts		4		5		6		7	6
Measuring contact ball diameter	mm	0.6		1				1.5	2
Measuring force	N	0.8 – 1.2		1.1 – 1.6				0.9 – 1.9	

Order no.	A	B	D	Hb	Hf	L
	mm	mm	mm	mm	mm	mm
4495580	2.3	0.80	0.6	2.5	2.5	35
4495581	5.2	1.20	1	5.4	5.4	85
4495582	7	1.20	1	7.3	7.3	85
4495583	7	1.20	1	7.3	7.3	85
4495584	8.3	1.20	1	12.2	12.2	85
4495585	8.3	1.20	1	12.2	12.2	85
4495586	5.5	1.90	1.5	6	6	188
4495587	8.3	2.40	2	8.5	8.5	192

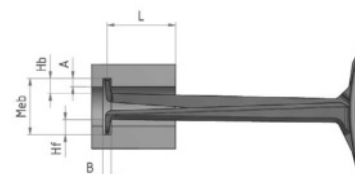

Marameter 838 EI

Digital inside quick probe



FUNCTIONS

- ON/OFF
- mm/inch
- TOL (enter tolerance limit values)
- ABS (display can be set to zero without losing reference to preset)
- DATA (in connection with data interface)

FEATURES

- High contrast analog and digital LCD
- Tolerance displayed via LED (red/green)
- **Data interface:** Digimatic, USB, Bluetooth (optional accessory)
- **Energy supply:** Battery operation (2x 1.5V AAA)
- **IP protection category:** IP 67
- **Package contains:** instruction manual, battery, test certificate

Applications:

- Specified measuring programs according to application
- Absolute/relative measuring program

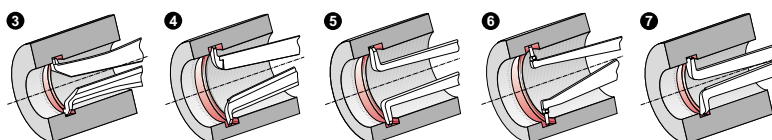

TECHNICAL DATA

Order no.	4495460	4495461	4495462	4495463	4495464	4495465	4495468	4495469	4495470
Type	838 EI								
Measuring range	mm 5 – 15	10 – 30	20 – 40	30 – 50	40 – 60	50 – 70	13 – 43	30 – 60	50 – 80
Resolution	mm 0.001, 0.002, 0.005, 0.01, 0.02, 0.05								
Measuring depth	mm 35			85			127		132
Error limit	mm 0.015			0.03				0.04	
Repeatability	mm 0.005			0.01				0.02	
Groove depth	mm 2.3	5.2		7		8.3	5.7	6.2	8.3
Groove width	mm 0.8			1.2			1.6	1.8	2.4
Form of measuring contacts		4		5		6	4		6
Measuring contact ball diameter	mm 0.6			1			1.3	1.5	2
Measuring force	N 0.8 – 1.2			1.1 – 1.6				1.2 – 1.7	
Bluetooth Option	•								

Order no.	A	B	D	Hb	Hf	L
	mm	mm	mm	mm	mm	mm
4495460	2.3	0.80	0.6	2.5	2.5	35
4495461	5.2	1.20	1	5.4	5.4	85
4495462	7	1.20	1	7.3	7.3	85
4495463	7	1.20	1	7.3	7.3	85
4495464	8.3	1.20	1	12.2	12.2	85
4495465	8.3	1.20	1	12.2	12.2	85
4495468	5.7	1.60	1.3	5.7	5.7	127
4495469	6.2	1.80	1.5	6.5	6.5	132
4495470	8.3	2.40	2	8.5	8.5	132

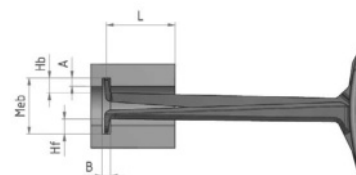

ACCESSORIES

Order no.	Description	Type
4495083	Interface adapter with data cable digimatic (1.5 m)	838 di (A)
4495079	838 USB interface adapter with data connection cable USB (1.5 m)	838 USB
4495036	Bluetooth interface for 838 EI/EA, including USB dongle BT4.0	838 BT



838 BT

Marameter | 844 D indicating plug gage system

Indicating measurement in highest precision

Plug gages of the 844 D family are 2-point indicating gages, combined with a precisely ground guide cylinder, which centers itself exactly in bores. This means that no reversal point needs to be determined by rocking. The measured value is displayed reliably, precisely and immediately.

The adjustment to a respective nominal dimension is achieved with setting rings.

Benefits:

- Fast and easy to use - best performance
- No operator influence
- Self-centering - no rocking required to determine the reversal point
- Especially suitable with use of digital indicators for processing the measured values

The following must be indicated with each order

- Order number
- Bore diameter
- Bore tolerance (ISO or numerical value spec.)

Examples

- | | |
|-------------|---|
| 1 x 4484016 | 844 D indicating plug gage
Nominal bore size \varnothing 34.5 mm
Bore tolerance H8 |
| 1 x 4484048 | 844 DR indicating plug gage
Nominal bore size \varnothing 74.55 mm
Bore tolerance +0.05 / -0.03 |

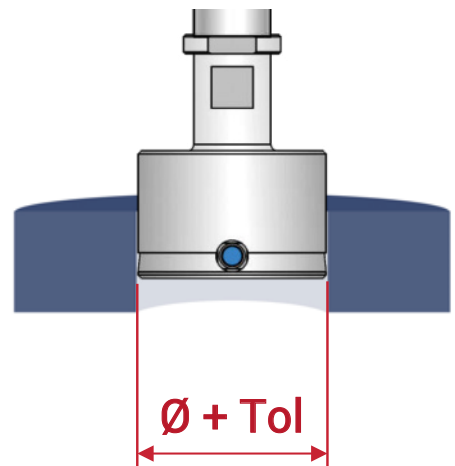

Modular system

By combining with a wide range of accessories (indicators, holders, extensions and right angle attachment), the indicating plug gage becomes a high precision measuring instrument, adapted to the measuring task.

Samples of application configurations



Standard configuration

- Comparator
- Holder 844 Dg
- Plug gage



Configuration for defined measuring depth

- Comparator
- Holder 844 Dg
- Extension 844 Dv
- Depth stop 844 Dt-3
- Plug gage

Configuration for sideways measuring in defined measuring depth

- Comparator
- Holder 844 Dg
- Angle attachment 844 Dw
- Plug gage
- Stop ring 844 Dt-R



Marameter | 844 D indicating plug gage system

3 basic types

Guide cylinder hard chrome-plated, measuring surfaces made of carbide

844 D

Standard version for general applications

- For quick inspection of precise bores

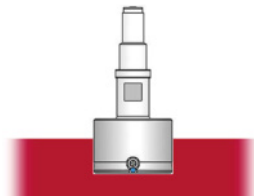
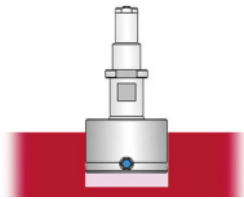

844 DS

Version for blind holes

- For measurements close to the base of the hole

844 DR

Version for through holes and thin-walled holes (metal sheet)

- With extended guide cylinder

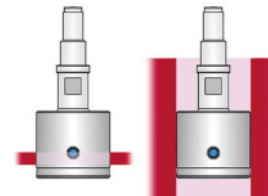

Variants

Variant C: 844 D-C / 844 DR-C / 844 DS-C

Measuring surfaces hard-chrome plated: For sensitive surfaces of non-ferrous metals and aluminum alloys



Variant R: 844 D-R / 844 DR-R / 844 DS-R

Measuring surfaces ruby-tipped: For very sensitive surfaces of non-ferrous metals and aluminum alloys



Variant D: 844 D-D / 844 DR-D

Measuring surfaces diamond-tipped: For very sensitive surfaces of soft non-ferrous metals and aluminum alloys



Variant FD: 844 D-FD / 844 DR-FD

Different front distance „e“: Reducing the guide cylinder to measure closer, or at a defined position, to the ground of the bore

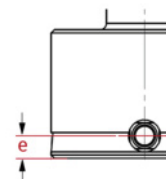

Variant M: 844 D-M / 844 DR-M / 844 DS-M

Extended measuring range: For measuring of larger tolerance fields



Variant HR: 844 D-HR / 844 DR-HR / 844 DS-HR

High resolution for very narrow bore tolerance zones <math>< 10 \mu\text{m}</math>. More precise manufacturing tolerance of the guide cylinder for tighter gap in the bore, thus reducing axial and radial measuring influences.



Variant F: 844 DS-F

Only with front chamfer (no centering groove): For measuring very short blind holes



Variant 3: 844 D-3 / 844 DR-3

3-Point contact (3 x 120°): For fast measurement of interrupted diameters and detection of shape defects in a polygon

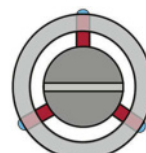

Marameter 844 D

Indicating plug gage

FEATURES

- Measuring head has a hard, stainless cylinder guide and carbide tipped anvils
- The carbide expanding pin transfers radial movement to indicating instrument
- Constant measuring force as a result of built-in spring, eliminating user influence
- Extensive modular system is composed of measuring head, holder, depth extension, right angle attachments and depth stops

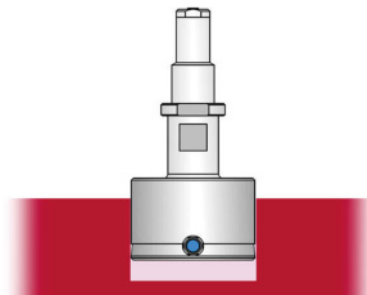

Application: Standard model

- For rapid testing of diameter, roundness and conicity of bores
- Especially suitable for testing batches with tight tolerance zones 10 µm and more
- Rocking in the bore is not required to determine diameter
- Ideal for use in conjunction with digital display units and for subsequent processing of measured values

TECHNICAL DATA

Order no.	Type	Measuring range	Measuring span	Manufacturing tolerance	Linearity deviation	Repeatability f_w	a	b	c	e	g	Connection thread
		mm	mm	mm / mm		µm	mm	mm	mm	mm	mm	
4484007	844 D	2- <3	0.15	-0.015 / -0.025	1 %, min. 1 µm	1		21.5	15	1.5	15	M6 x 0.75 / M3.5x0.35
4484008	844 D	3-4	0.2	-0.015 / -0.025	1 %, min. 1 µm	1		33.5	24	1.5	24	M6 x 0.75 / M3.5x0.35
4484009	844 D	>4-7	0.2	-0.015 / -0.025	1 %, min. 1 µm	1	4	33.5	10	1.5	27	M6 x 0.75 / M3.5x0.35
4484010	844 D	>7-9	0.2	-0.015 / -0.025	1 %, min. 1 µm	1	6.9	47	15	2.5	35	M6 x 0.75
4484011	844 D	>9-12	0.2	-0.015 / -0.025	1 %, min. 1 µm	1	7.9	47	15	2.5	47	M6 x 0.75
4484012	844 D	>12-13	0.2	-0.015 / -0.025	1 %, min. 1 µm	1	7.9	47	15	2.5	47	M6 x 0.75
4484013	844 D	>13-16	0.2	-0.015 / -0.025	1 %, min. 1 µm	1	11.9	47	15	2.5	47	M6 x 0.75
4484014	844 D	>16-20	0.2	-0.015 / -0.025	1 %, min. 1 µm	1	15	37.3	15	2.5		M10x1
4484015	844 D	>20-30	0.2	-0.02 / -0.03	1 %, min. 1 µm	1	15	38.2	20	3.5		M10x1
4484016	844 D	>30-40	0.2	-0.02 / -0.03	1 %, min. 1 µm	1	15	38.2	20	3.5		M10x1
4484017	844 D	>40-60	0.2	-0.02 / -0.03	1 %, min. 1 µm	1	15	38.2	28	3.5		M10x1
4484018	844 D	>60-80	0.2	-0.025 / -0.035	1 %, min. 1 µm	1	17.9	38.8	33	4		M10x1
4484019	844 D	>80-100	0.2	-0.025 / -0.035	1 %, min. 1 µm	1	17.9	38.8	33	4		M10x1
4484020	844 D	>100-110	0.2	-0.025 / -0.035	1 %, min. 1 µm	1	17.9	38.8	33	4		M10x1
4484021	844 D	>110-120	0.2	-0.025 / -0.035	1 %, min. 1 µm	1	17.9	38.8	33	4		M10x1
4484022	844 D	>120-130	0.2	-0.025 / -0.035	1 %, min. 1 µm	1	17.9	38.8	33	4		M10x1
4484023	844 D	>130-140	0.2	-0.035 / -0.045	1 %, min. 1 µm	1	17.9	38.8	33	4		M10x1
4484024	844 D	>140-150	0.2	-0.035 / -0.045	1 %, min. 1 µm	1	17.9	38.8	33	4		M10x1
4484025	844 D	>150-160	0.2	-0.035 / -0.045	1 %, min. 1 µm	1	17.9	38.8	33	4		M10x1
4484026	844 D	>160-170	0.2	-0.035 / -0.045	1 %, min. 1 µm	1	17.9	39	40	4		M10x1
4484027	844 D	>170-180	0.2	-0.035 / -0.045	1 %, min. 1 µm	1	17.9	39	40	4		M10x1
4484028	844 D	>180-190	0.2	-0.035 / -0.045	1 %, min. 1 µm	1	17.9	39	40	4		M10x1
4484029	844 D	>190-200	0.2	-0.035 / -0.045	1 %, min. 1 µm	1	17.9	39	40	4		M10x1

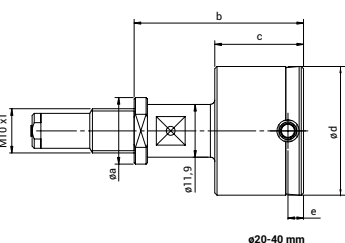
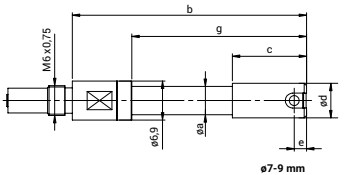
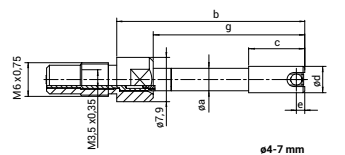

Marameter 844 DR

Indicating plug gage

FEATURES

- Measuring probe made of hardened, stainless guide cylinder and carbide tipped probes
- Carbide driving needle transfers radial measuring movement to the display unit
- Constant measuring force as a result of built-in spring, eliminating user influence
- Measuring head, measuring instrument holder, depth extensions, right angle attachments and depth stops form a comprehensive modular system

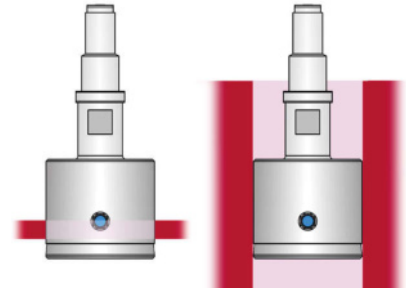

Application:

Model for through holes and narrow parts

- With extended guide cylinder for measuring through holes and bores of narrow parts e.g. sheets
- For the rapid testing of diameter, roundness and conicity of bores
- Especially suitable for testing batches with tight tolerance zones 10 µm and more
- Rocking in the bore is not required to determine diameter
- Ideal for use in conjunction with digital display units and for subsequent processing of measured values

TECHNICAL DATA

Order no.	Type	Measuring range	Measuring span	Manufacturing tolerance	Linearity deviation	Repeatability f_w	a	b	c	e	g	Connection thread
		mm	mm	mm / mm		µm	mm	mm	mm	mm	mm	
4484039	844 DR	4–7	0.2	–0.015 / –0.025	1 %, min. 1 µm	1	4	38	14.5	6	31.5	M6 x 0.75 / M3.5x0.35
4484040	844 DR	>7–9	0.2	–0.015 / –0.025	1 %, min. 1 µm	1	6.9	50.5	18.5	6	38.5	M6 x 0.75
4484041	844 DR	>9–12	0.2	–0.015 / –0.025	1 %, min. 1 µm	1	7.9	54.5	22.5	10	54.5	M6 x 0.75
4484042	844 DR	>12–13	0.2	–0.015 / –0.025	1 %, min. 1 µm	1	7.9	54.5	22.5	10	54.5	M6 x 0.75
4484043	844 DR	>13–16	0.2	–0.015 / –0.025	1 %, min. 1 µm	1	11.9	54.5	22.5	10	54.5	M6 x 0.75
4484044	844 DR	>16–20	0.2	–0.015 / –0.025	1 %, min. 1 µm	1	15	44.8	22.5	10		M10x1
4484045	844 DR	>20–30	0.2	–0.02 / –0.03	1 %, min. 1 µm	1	15	44.7	27	10		M10x1
4484046	844 DR	>30–40	0.2	–0.02 / –0.03	1 %, min. 1 µm	1	15	44.7	27	10		M10x1
4484047	844 DR	>40–60	0.2	–0.02 / –0.03	1 %, min. 1 µm	1	15	44.7	28	10		M10x1
4484048	844 DR	>60–80	0.2	–0.025 / –0.035	1 %, min. 1 µm	1	17.9	44.8	33	10		M10x1
4484049	844 DR	>80–100	0.2	–0.025 / –0.035	1 %, min. 1 µm	1	17.9	44.8	33	10		M10x1
4484050	844 DR	>100–110	0.2	–0.025 / –0.035	1 %, min. 1 µm	1	17.9	44.8	33	10		M10x1
4484051	844 DR	>110–120	0.2	–0.025 / –0.035	1 %, min. 1 µm	1	17.9	44.8	33	10		M10x1
4484052	844 DR	>120–130	0.2	–0.025 / –0.035	1 %, min. 1 µm	1	17.9	44.8	33	10		M10x1
4484053	844 DR	>130–140	0.2	–0.035 / –0.045	1 %, min. 1 µm	1	17.9	44.8	33	10		M10x1
4484054	844 DR	>140–150	0.2	–0.035 / –0.045	1 %, min. 1 µm	1	17.9	44.8	33	10		M10x1
4484055	844 DR	>150–160	0.2	–0.035 / –0.045	1 %, min. 1 µm	1	17.9	44.8	33	10		M10x1
4484056	844 DR	>160–170	0.2	–0.035 / –0.045	1 %, min. 1 µm	1	17.9	45	40	10		M10x1
4484057	844 DR	>170–180	0.2	–0.035 / –0.045	1 %, min. 1 µm	1	17.9	45	40	10		M10x1
4484058	844 DR	>180–190	0.2	–0.035 / –0.045	1 %, min. 1 µm	1	17.9	45	40	10		M10x1
4484059	844 DR	>190–200	0.2	–0.035 / –0.045	1 %, min. 1 µm	1	17.9	45	40	10		M10x1

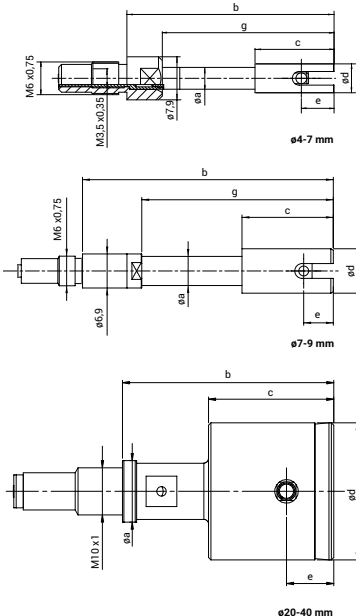

Marameter 844 DS

Indicating plug gage

FEATURES

- Measuring probe made of hardened, stainless guide cylinder and carbide tipped probes
- Carbide driving needle transfers radial measuring movement to the display unit
- Constant measuring force as a result of built-in spring, eliminating user influence
- Measuring head, measuring instrument holder, depth extensions, right angle attachments and depth stops form a comprehensive modular system

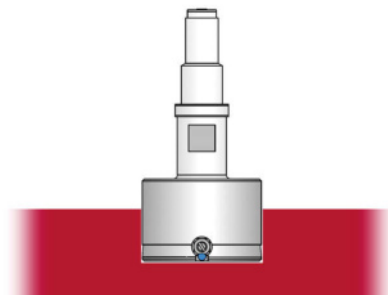

Application: Model for blind holes

- For measurements close to the base of the hole
- For the rapid testing of diameter, roundness and conicity of bores
- Especially suitable for testing batches with tight tolerance zones 10 µm and more
- Rocking in the bore is not required to determine diameter
- Ideal for use in conjunction with digital display units and for subsequent processing of measured values

TECHNICAL DATA

Order no.	Type	Measuring range	Measuring span	Manufacturing tolerance	Linearity deviation	Repeatability f_w	a	b	c	e	g	Connection thread
		mm	mm	mm / mm		µm	mm	mm	mm	mm	mm	
4484067	844 DS	2- <3	0.15	-0.015 / -0.025	1.5 %, min. 1 µm	1		20.7	14.2	0.7	14,2	M6 x 0.75 / M3.5x0.35
4484068	844 DS	3-4	0.2	-0.015 / -0.025	1.5 %, min. 1 µm	1		33	23.5	1	23.5	M6 x 0.75 / M3.5x0.35
4484069	844 DS	>4-7	0.2	-0.015 / -0.025	1.5 %, min. 1 µm	1	4	33	9.5	1	26.5	M6 x 0.75 / M3.5x0.35
4484070	844 DS	>7-9	0.2	-0.015 / -0.025	1.5 %, min. 1 µm	1	6.9	45.5	13.5	1	33.5	M6 x 0.75
4484071	844 DS	>9-12	0.2	-0.015 / -0.025	1.5 %, min. 1 µm	1	7.9	45.5	13.5	1	45.5	M6 x 0.75
4484072	844 DS	>12-13	0.2	-0.015 / -0.025	1.5 %, min. 1 µm	1	7.9	45.5	13.5	1	45.5	M6 x 0.75
4484073	844 DS	>13-16	0.2	-0.015 / -0.025	1.5 %, min. 1 µm	1	11.9	45.5	13.5	1	45.5	M6 x 0.75
4484074	844 DS	>16-20	0.2	-0.015 / -0.025	1.5 %, min. 1 µm	1	15	35.8	13.5	1		M10x1
4484075	844 DS	>20-30	0.2	-0.02 / -0.03	1.5 %, min. 1 µm	1	15	38.2	20	1.2		M10x1
4484076	844 DS	>30-40	0.2	-0.02 / -0.03	1.5 %, min. 1 µm	1	15	38.2	20	1.2		M10x1
4484077	844 DS	>40-60	0.2	-0.02 / -0.03	1.5 %, min. 1 µm	1	15	38.2	28	1.2		M10x1
4484078	844 DS	>60-80	0.2	-0.025 / -0.035	1.5 %, min. 1 µm	1	17.9	39	33	1.2		M10x1
4484079	844 DS	>80-100	0.2	-0.025 / -0.035	1.5 %, min. 1 µm	1	17.9	39	33	1.2		M10x1
4484080	844 DS	>100-110	0.2	-0.025 / -0.035	1.5 %, min. 1 µm	1	17.9	39	33	1.2		M10x1
4484081	844 DS	>110-120	0.2	-0.025 / -0.035	1.5 %, min. 1 µm	1	17.9	39	33	1.2		M10x1
4484082	844 DS	>120-130	0.2	-0.025 / -0.035	1.5 %, min. 1 µm	1	17.9	39	33	1.2		M10x1
4484083	844 DS	>130-140	0.2	-0.035 / -0.045	1.5 %, min. 1 µm	1	17.9	39	33	1.2		M10x1
4484084	844 DS	>140-150	0.2	-0.035 / -0.045	1.5 %, min. 1 µm	1	17.9	39	33	1.2		M10x1
4484085	844 DS	>150-160	0.2	-0.035 / -0.045	1.5 %, min. 1 µm	1	17.9	39	33	1.2		M10x1
4484086	844 DS	>160-170	0.2	-0.035 / -0.045	1.5 %, min. 1 µm	1	17.9	38.6	40	1.2		M10x1
4484087	844 DS	>170-180	0.2	-0.035 / -0.045	1.5 %, min. 1 µm	1	17.9	38.6	40	1.2		M10x1
4484088	844 DS	>180-190	0.2	-0.035 / -0.045	1.5 %, min. 1 µm	1	17.9	38.6	40	1.2		M10x1
4484089	844 DS	>190-200	0.2	-0.035 / -0.045	1.5 %, min. 1 µm	1	17.9	38.6	40	1.2		M10x1

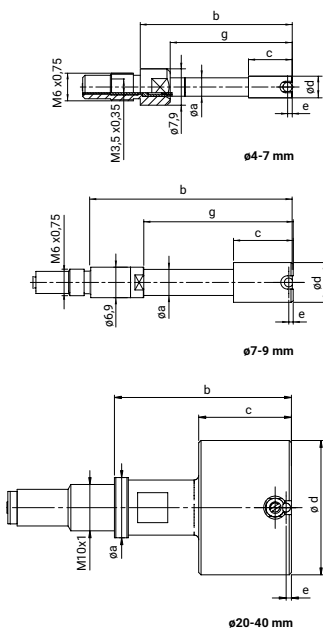

Marameter 844 D-C

Indicating plug gage

FEATURES

- Measuring probe made of hardened, stainless guide cylinder and carbide tipped probes
- Carbide driving needle transfers radial measuring movement to the display unit
- Constant measuring force as a result of built-in spring, eliminating user influence
- Measuring head, measuring instrument holder, depth extensions, right angle attachments and depth stops form a comprehensive modular system

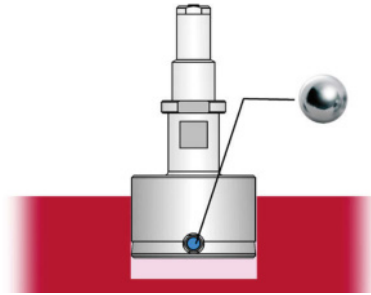

Application:

Standard model, measuring surfaces hard chrome-plated

- Preferred application on sensitive surfaces of non-ferrous metals and aluminium alloys
- For rapid testing of diameter, roundness and conicity of bores
- Especially suitable for testing batches with tight tolerance zones
- Rocking in the bore is unnecessary to determine the reversal point
- Ideal for use in conjunction with digital display units and for subsequent processing of measured values

TECHNICAL DATA

Order no.	Type	Measuring range	Measuring span	Manu- facturing tolerance	Linearity deviation	Repeata- bility f_w	a	b	c	e	g	Connection thread
		mm	mm	mm / mm		μm	mm	mm	mm	mm	mm	
4484100	844 D-C	8–9	0.2	-0.015 / -0.025	1 %, min. 1 μm	1	5.7	47	15	2.5	35	M6 x 0.75
4484101	844 D-C	>9–12	0.2	-0.015 / -0.025	1 %, min. 1 μm	1	7.9	47	15	2.5	47	M6 x 0.75
4484102	844 D-C	>12–13	0.2	-0.015 / -0.025	1 %, min. 1 μm	1	7.9	47	15	2.5	47	M6 x 0.75
4484103	844 D-C	>13–16	0.2	-0.015 / -0.025	1 %, min. 1 μm	1	11.9	47	15	2.5	47	M6 x 0.75
4484104	844 D-C	>16–20	0.2	-0.015 / -0.025	1 %, min. 1 μm	1	15	37.3	15	2.5		M10x1
4484105	844 D-C	>20–30	0.2	-0.02 / -0.03	1 %, min. 1 μm	1	15	38.2	20	3.5		M10x1
4484106	844 D-C	>30–40	0.2	-0.02 / -0.03	1 %, min. 1 μm	1	15	38.2	20	3.5		M10x1
4484107	844 D-C	>40–60	0.2	-0.02 / -0.03	1 %, min. 1 μm	1	15	38.2	28	3.5		M10x1
4484108	844 D-C	>60–80	0.2	-0.025 / -0.035	1 %, min. 1 μm	1	17.9	38.8	33	4		M10x1
4484109	844 D-C	>80–100	0.2	-0.025 / -0.035	1 %, min. 1 μm	1	17.9	38.8	33	4		M10x1
4484110	844 D-C	>100–110	0.2	-0.025 / -0.035	1 %, min. 1 μm	1	17.9	38.8	33	4		M10x1
4484111	844 D-C	>110–120	0.2	-0.025 / -0.035	1 %, min. 1 μm	1	17.9	38.8	33	4		M10x1
4484112	844 D-C	>120–130	0.2	-0.025 / -0.035	1 %, min. 1 μm	1	17.9	38.8	33	4		M10x1
4484113	844 D-C	>130–140	0.2	-0.035 / -0.045	1 %, min. 1 μm	1	17.9	38.8	33	4		M10x1
4484114	844 D-C	>140–150	0.2	-0.035 / -0.045	1 %, min. 1 μm	1	17.9	38.8	33	4		M10x1
4484115	844 D-C	>150–160	0.2	-0.035 / -0.045	1 %, min. 1 μm	1	17.9	38.8	33	4		M10x1
4484116	844 D-C	>160–170	0.2	-0.035 / -0.045	1 %, min. 1 μm	1	17.9	39	40	4		M10x1
4484117	844 D-C	>170–180	0.2	-0.035 / -0.045	1 %, min. 1 μm	1	17.9	39	40	4		M10x1
4484118	844 D-C	>180–190	0.2	-0.035 / -0.045	1 %, min. 1 μm	1	17.9	39	40	4		M10x1
4484119	844 D-C	>190–200	0.2	-0.035 / -0.045	1 %, min. 1 μm	1	17.9	39	40	4		M10x1

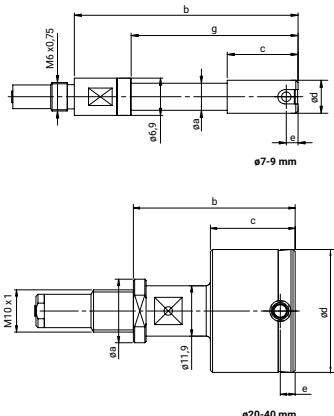

Marameter 844 DR-C

Indicating plug gage

FEATURES

- Measuring probe made of hardened, stainless guide cylinder and carbide tipped probes
- Carbide driving needle transfers radial measuring movement to the display unit
- Constant measuring force as a result of built-in spring, eliminating user influence
- Measuring head, measuring instrument holder, depth extensions, right angle attachments and depth stops form a comprehensive modular system

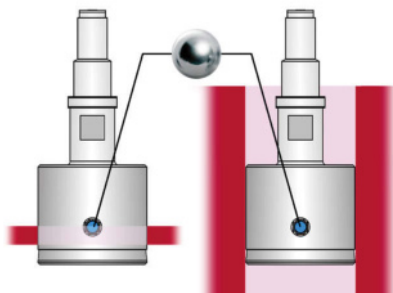

Application:

Design for through-holes, hard chrome plated measuring surfaces

- Preferred use on sensitive surfaces of non-ferrous metals and aluminum alloys
- With extended guide cylinder for measuring through holes from the edge of the hole
- For the rapid testing of diameter, roundness and conicity of bores
- Especially suitable for testing batches with tight tolerance fields
- No rocking in the bore is necessary to determine the reversal point
- Ideal for use in conjunction with digital display units and for subsequent processing of measured values

TECHNICAL DATA

Order no.	Type	Measuring range	Measuring span	Manufacturing tolerance	Linearity deviation	Repeatability f_w	a	b	c	e	g	Connection thread
		mm	mm	mm / mm		μm	mm	mm	mm	mm	mm	
4484130	844 DR-C	8–9	0.2	-0.015 / -0.025	1 %, min. 1 μm	1	5.7	50.5	18.5	6	38.5	M6 x 0.75
4484131	844 DR-C	>9–12	0.2	-0.015 / -0.025	1 %, min. 1 μm	1	7.9	54.5	22.5	10	54.5	M6 x 0.75
4484132	844 DR-C	>12–13	0.2	-0.015 / -0.025	1 %, min. 1 μm	1	7.9	54.5	22.5	10	54.5	M6 x 0.75
4484133	844 DR-C	>13–16	0.2	-0.015 / -0.025	1 %, min. 1 μm	1	11.9	54.5	22.5	10	54.5	M6 x 0.75
4484134	844 DR-C	>16–20	0.2	-0.015 / -0.025	1 %, min. 1 μm	1	15	44.8	22.5	10		M10x1
4484135	844 DR-C	>20–30	0.2	-0.02 / -0.03	1 %, min. 1 μm	1	15	44.7	27	10		M10x1
4484136	844 DR-C	>30–40	0.2	-0.02 / -0.03	1 %, min. 1 μm	1	15	44.7	27	10		M10x1
4484137	844 DR-C	>40–60	0.2	-0.02 / -0.03	1 %, min. 1 μm	1	15	44.7	28	10		M10x1
4484138	844 DR-C	>60–80	0.2	-0.025 / -0.035	1 %, min. 1 μm	1	17.9	44.8	33	10		M10x1
4484139	844 DR-C	>80–100	0.2	-0.025 / -0.035	1 %, min. 1 μm	1	17.9	44.8	33	10		M10x1
4484140	844 DR-C	>100–110	0.2	-0.025 / -0.035	1 %, min. 1 μm	1	17.9	44.8	33	10		M10x1
4484141	844 DR-C	>110–120	0.2	-0.025 / -0.035	1 %, min. 1 μm	1	17.9	44.8	33	10		M10x1
4484142	844 DR-C	>120–130	0.2	-0.025 / -0.035	1 %, min. 1 μm	1	17.9	44.8	33	10		M10x1
4484143	844 DR-C	>130–140	0.2	-0.035 / -0.045	1 %, min. 1 μm	1	17.9	44.8	33	10		M10x1
4484144	844 DR-C	>140–150	0.2	-0.035 / -0.045	1 %, min. 1 μm	1	17.9	44.8	33	10		M10x1
4484145	844 DR-C	>150–160	0.2	-0.035 / -0.045	1 %, min. 1 μm	1	17.9	44.8	33	10		M10x1
4484146	844 DR-C	>160–170	0.2	-0.035 / -0.045	1 %, min. 1 μm	1	17.9	45	40	10		M10x1
4484147	844 DR-C	>170–180	0.2	-0.035 / -0.045	1 %, min. 1 μm	1	17.9	45	40	10		M10x1
4484148	844 DR-C	>180–190	0.2	-0.035 / -0.045	1 %, min. 1 μm	1	17.9	45	40	10		M10x1
4484149	844 DR-C	>190–200	0.2	-0.035 / -0.045	1 %, min. 1 μm	1	17.9	45	40	10		M10x1

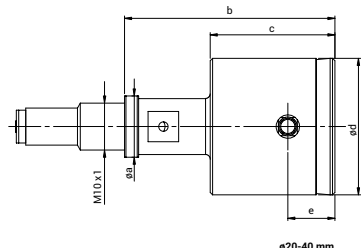
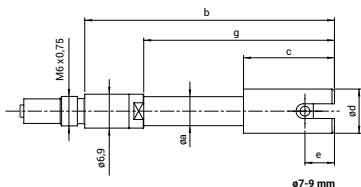

Marameter 844 DS-C

Indicating plug gage

FEATURES

- Measuring probe made of hardened, stainless guide cylinder and carbide tipped probes
- Carbide driving needle transfers radial measuring movement to the display unit
- Constant measuring force as a result of built-in spring, eliminating user influence
- Measuring head, measuring instrument holder, depth extensions, right angle attachments and depth stops form a comprehensive modular system

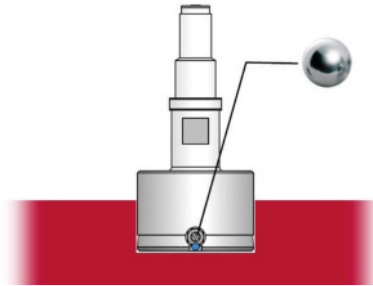

Application:

Model for blind holes, measuring surfaces hard chrome-plated

- Preferred application on sensitive surfaces of non-ferrous metals and aluminium alloys
- For measurements close to the base of the hole
- For rapid testing of diameter, roundness and conicity of bores
- Especially suitable for testing batches with tight tolerance zones
- Rocking in the bore is unnecessary to determine the reversal point
- Ideal for use in conjunction with digital display units and for subsequent processing of measured values

TECHNICAL DATA

Order no.	Type	Measuring range	Measuring span	Manufacturing tolerance	Linearity deviation	Repeatability f_w	a	b	c	e	g	Connection thread
		mm	mm	mm / mm		μm	mm	mm	mm	mm	mm	
4484160	844 DS-C	8–9	0.2	-0.015 / -0.025	1.5 %, min. 1 μm	1	5.7	45.5	13.5	1	33.5	M6 x 0.75
4484161	844 DS-C	>9–12	0.2	-0.015 / -0.025	1.5 %, min. 1 μm	1	7.9	45.5	13.5	1	45.5	M6 x 0.75
4484162	844 DS-C	>12–13	0.2	-0.015 / -0.025	1.5 %, min. 1 μm	1	7.9	45.5	13.5	1	45.5	M6 x 0.75
4484163	844 DS-C	>13–16	0.2	-0.015 / -0.025	1.5 %, min. 1 μm	1	11.9	45.5	13.5	1	45.5	M6 x 0.75
4484164	844 DS-C	>16–20	0.2	-0.015 / -0.025	1.5 %, min. 1 μm	1	15	35.8	13.5	1		M10x1
4484165	844 DS-C	>20–30	0.2	-0.02 / -0.03	1.5 %, min. 1 μm	1	15	38.2	20	1.2		M10x1
4484166	844 DS-C	>30–40	0.2	-0.02 / -0.03	1.5 %, min. 1 μm	1	15	38.2	20	1.2		M10x1
4484167	844 DS-C	>40–60	0.2	-0.02 / -0.03	1.5 %, min. 1 μm	1	15	38.2	28	1.2		M10x1
4484168	844 DS-C	>60–80	0.2	-0.025 / -0.035	1.5 %, min. 1 μm	1	17.9	39	33	1.2		M10x1
4484169	844 DS-C	>80–100	0.2	-0.025 / -0.035	1.5 %, min. 1 μm	1	17.9	39	33	1.2		M10x1
4484170	844 DS-C	>100–110	0.2	-0.025 / -0.035	1.5 %, min. 1 μm	1	17.9	39	33	1.2		M10x1
4484171	844 DS-C	>110–120	0.2	-0.025 / -0.035	1.5 %, min. 1 μm	1	17.9	39	33	1.2		M10x1
4484172	844 DS-C	>120–130	0.2	-0.025 / -0.035	1.5 %, min. 1 μm	1	17.9	39	33	1.2		M10x1
4484173	844 DS-C	>130–140	0.2	-0.035 / -0.045	1.5 %, min. 1 μm	1	17.9	39	33	1.2		M10x1
4484174	844 DS-C	>140–150	0.2	-0.035 / -0.045	1.5 %, min. 1 μm	1	17.9	39	33	1.2		M10x1
4484175	844 DS-C	>150–160	0.2	-0.035 / -0.045	1.5 %, min. 1 μm	1	17.9	39	33	1.2		M10x1
4484176	844 DS-C	>160–170	0.2	-0.035 / -0.045	1.5 %, min. 1 μm	1	17.9	38.6	40	1.2		M10x1
4484177	844 DS-C	>170–180	0.2	-0.035 / -0.045	1.5 %, min. 1 μm	1	17.9	38.6	40	1.2		M10x1
4484178	844 DS-C	>180–190	0.2	-0.035 / -0.045	1.5 %, min. 1 μm	1	17.9	38.6	40	1.2		M10x1
4484179	844 DS-C	>190–200	0.2	-0.035 / -0.045	1.5 %, min. 1 μm	1	17.9	38.6	40	1.2		M10x1

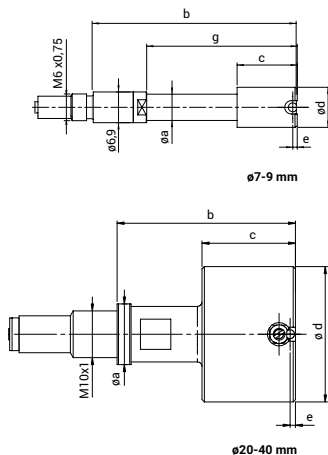

Marameter 844 D-R

Indicating plug gage

FEATURES

- Measuring probe made of hardened, stainless guide cylinder and ruby-tipped probes
- Carbide driving needle transfers radial measuring movement to the display unit
- Constant measuring force as a result of built-in spring, eliminating user influence
- Measuring head, measuring instrument holder, depth extensions, right angle attachments and depth stops form a comprehensive modular system

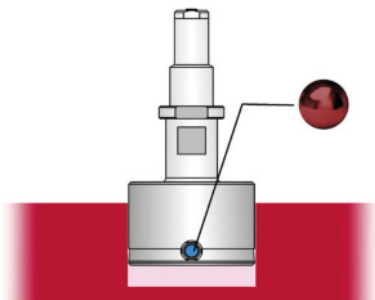

Application:
Standard model, measuring surfaces ruby-tipped

- Preferred application on sensitive surfaces of non-ferrous metals and aluminium alloys
- For rapid testing of diameter, roundness and conicity of bores
- Especially suitable for testing batches with tight tolerance zones
- Rocking in the bore is not required to determine diameter
- Ideal for use in conjunction with digital display units and for subsequent processing of measured values

TECHNICAL DATA

Order no.	Type	Measuring range	Measuring span	Manufacturing tolerance	Linearity deviation	Repeatability f_w	a	b	c	e	g	Connection thread
		mm	mm	mm / mm		μm	mm	mm	mm	mm	mm	
4484208	844 D-R	3–4	0.2	-0.015 / -0.025	1 %, min. 1 μm	1		33.5	24	1.5	24	M6 x 0.75 / M3.5x0.35
4484209	844 D-R	>4–7	0.2	-0.015 / -0.025	1 %, min. 1 μm	1	4	33.5	10	1.5	27	M6 x 0.75 / M3.5x0.35
4484210	844 D-R	>7–9	0.2	-0.015 / -0.025	1 %, min. 1 μm	1	6.9	47	15	2.5	35	M6 x 0.75
4484211	844 D-R	>9–12	0.2	-0.015 / -0.025	1 %, min. 1 μm	1	7.9	47	15	2.5	47	M6 x 0.75
4484212	844 D-R	>12–13	0.2	-0.015 / -0.025	1 %, min. 1 μm	1	7.9	47	15	2.5	47	M6 x 0.75
4484213	844 D-R	>13–16	0.2	-0.015 / -0.025	1 %, min. 1 μm	1	11.9	47	15	2.5	47	M6 x 0.75
4484214	844 D-R	>16–20	0.2	-0.015 / -0.025	1 %, min. 1 μm	1	15	37.3	15	2.5		M10x1
4484215	844 D-R	>20–30	0.2	-0.02 / -0.03	1 %, min. 1 μm	1	15	38.2	20	3.5		M10x1
4484216	844 D-R	>30–40	0.2	-0.02 / -0.03	1 %, min. 1 μm	1	15	38.2	20	3.5		M10x1
4484217	844 D-R	>40–60	0.2	-0.02 / -0.03	1 %, min. 1 μm	1	15	38.2	28	3.5		M10x1
4484218	844 D-R	>60–80	0.2	-0.025 / -0.035	1 %, min. 1 μm	1	17.9	38.8	33	4		M10x1
4484219	844 D-R	>80–100	0.2	-0.025 / -0.035	1 %, min. 1 μm	1	17.9	38.8	33	4		M10x1
4484220	844 D-R	>100–110	0.2	-0.025 / -0.035	1 %, min. 1 μm	1	17.9	38.8	33	4		M10x1
4484221	844 D-R	>110–120	0.2	-0.025 / -0.035	1 %, min. 1 μm	1	17.9	38.8	33	4		M10x1
4484222	844 D-R	>120–130	0.2	-0.025 / -0.035	1 %, min. 1 μm	1	17.9	38.8	33	4		M10x1
4484223	844 D-R	>130–140	0.2	-0.035 / -0.045	1 %, min. 1 μm	1	17.9	38.8	33	4		M10x1
4484224	844 D-R	>140–150	0.2	-0.035 / -0.045	1 %, min. 1 μm	1	17.9	38.8	33	4		M10x1
4484225	844 D-R	>150–160	0.2	-0.035 / -0.045	1 %, min. 1 μm	1	17.9	38.8	33	4		M10x1
4484226	844 D-R	>160–170	0.2	-0.035 / -0.045	1 %, min. 1 μm	1	17.9	39	40	4		M10x1
4484227	844 D-R	>170–180	0.2	-0.035 / -0.045	1 %, min. 1 μm	1	17.9	39	40	4		M10x1
4484228	844 D-R	>180–190	0.2	-0.035 / -0.045	1 %, min. 1 μm	1	17.9	39	40	4		M10x1
4484229	844 D-R	>190–200	0.2	-0.035 / -0.045	1 %, min. 1 μm	1	17.9	39	40	4		M10x1

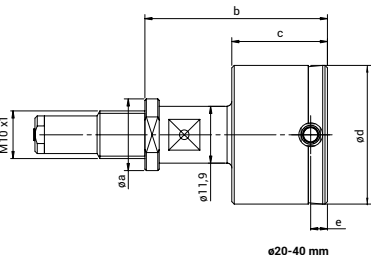
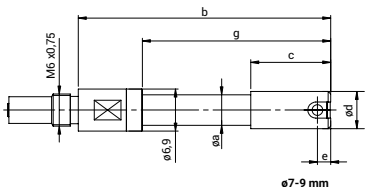
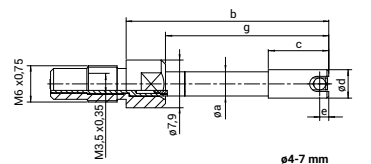

Marameter 844 DR-R

Indicating plug gage

FEATURES

- Measuring probe made of hardened, stainless guide cylinder and ruby-tipped probes
- Carbide driving needle transfers radial measuring movement to the display unit
- Constant measuring force as a result of built-in spring, eliminating user influence
- Measuring head, measuring instrument holder, depth extensions, right angle attachments and depth stops form a comprehensive modular system

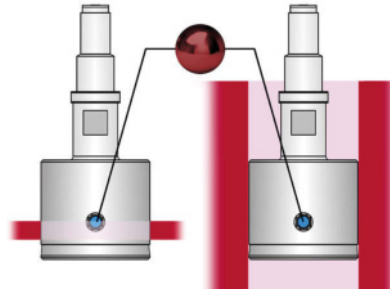

Application:

Design for through-holes, ruby-tipped measuring surfaces

- Preferred use on sensitive surfaces of non-ferrous metals and aluminum alloys
- With extended guide cylinder for measuring through holes from the edge of the hole
- For the rapid testing of diameter, roundness and conicity of bores
- Especially suitable for testing batches with tight tolerance fields
- Rocking in the bore is not required to determine diameter
- Ideal for use in conjunction with digital display units and for subsequent processing of measured values

TECHNICAL DATA

Order no.	Type	Measuring range	Measuring span	Manufacturing tolerance	Linearity deviation	Repeatability f_w	a	b	c	e	g	Connection thread
		mm	mm	mm / mm		μm	mm	mm	mm	mm	mm	
4484239	844 DR-R	4-7	0.2	-0.015 / -0.025	1 %, min. 1 μm	1	4	38	14.5	6	31.5	M6 x 0.75 / M3.5x0.35
4484240	844 DR-R	>7-9	0.2	-0.015 / -0.025	1 %, min. 1 μm	1	6.9	50.5	18.5	6	38.5	M6 x 0.75
4484241	844 DR-R	>9-12	0.2	-0.015 / -0.025	1 %, min. 1 μm	1	7.9	54.5	22.5	10	54.5	M6 x 0.75
4484242	844 DR-R	>12-13	0.2	-0.015 / -0.025	1 %, min. 1 μm	1	7.9	54.5	22.5	10	54.5	M6 x 0.75
4484243	844 DR-R	>13-16	0.2	-0.015 / -0.025	1 %, min. 1 μm	1	11.9	54.5	22.5	10	54.5	M6 x 0.75
4484244	844 DR-R	>16-20	0.2	-0.015 / -0.025	1 %, min. 1 μm	1	15	44.8	22.5	10		M10x1
4484245	844 DR-R	>20-30	0.2	-0.02 / -0.03	1 %, min. 1 μm	1	15	44.7	27	10		M10x1
4484246	844 DR-R	>30-40	0.2	-0.02 / -0.03	1 %, min. 1 μm	1	15	44.7	27	10		M10x1
4484247	844 DR-R	>40-60	0.2	-0.02 / -0.03	1 %, min. 1 μm	1	15	44.7	28	10		M10x1
4484248	844 DR-R	>60-80	0.2	-0.025 / -0.035	1 %, min. 1 μm	1	17.9	44.8	33	10		M10x1
4484249	844 DR-R	>80-100	0.2	-0.025 / -0.035	1 %, min. 1 μm	1	17.9	44.8	33	10		M10x1
4484250	844 DR-R	>100-110	0.2	-0.025 / -0.035	1 %, min. 1 μm	1	17.9	44.8	33	10		M10x1
4484251	844 DR-R	>110-120	0.2	-0.025 / -0.035	1 %, min. 1 μm	1	17.9	44.8	33	10		M10x1
4484252	844 DR-R	>120-130	0.2	-0.025 / -0.035	1 %, min. 1 μm	1	17.9	44.8	33	10		M10x1
4484253	844 DR-R	>130-140	0.2	-0.035 / -0.045	1 %, min. 1 μm	1	17.9	44.8	33	10		M10x1
4484254	844 DR-R	>140-150	0.2	-0.035 / -0.045	1 %, min. 1 μm	1	17.9	44.8	33	10		M10x1
4484255	844 DR-R	>150-160	0.2	-0.035 / -0.045	1 %, min. 1 μm	1	17.9	44.8	33	10		M10x1
4484256	844 DR-R	>160-170	0.2	-0.035 / -0.045	1 %, min. 1 μm	1	17.9	45	40	10		M10x1
4484257	844 DR-R	>170-180	0.2	-0.035 / -0.045	1 %, min. 1 μm	1	17.9	45	40	10		M10x1
4484258	844 DR-R	>180-190	0.2	-0.035 / -0.045	1 %, min. 1 μm	1	17.9	45	40	10		M10x1
4484259	844 DR-R	>190-200	0.2	-0.035 / -0.045	1 %, min. 1 μm	1	17.9	45	40	10		M10x1

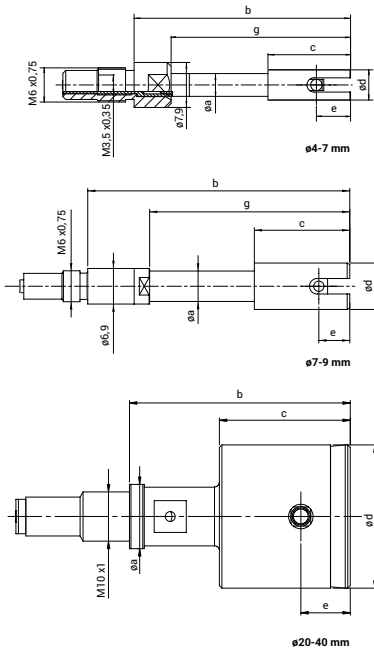

Marameter 844 DS-R

Indicating plug gage

FEATURES

- Measuring probe made of hardened, stainless guide cylinder and ruby-tipped probes
- Carbide driving needle transfers radial measuring movement to the display unit
- Constant measuring force as a result of built-in spring, eliminating user influence
- Measuring head, measuring instrument holder, depth extensions, right angle attachments and depth stops form a comprehensive modular system

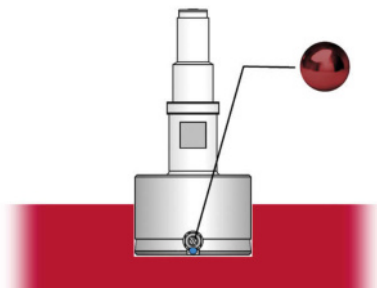

Application:

Model for blind holes, measuring surfaces ruby-tipped

- Preferred application on sensitive surfaces of non-ferrous metals and aluminium alloys
- For measurements close to the base of the hole
- For rapid testing of diameter, roundness and conicity of bores
- Especially suitable for testing batches with tight tolerance zones
- Rocking in the bore is not required to determine diameter
- Ideal for use in conjunction with digital display units and for subsequent processing of measured values

TECHNICAL DATA

Order no.	Type	Measuring range	Measuring span	Manufacturing tolerance	Linearity deviation	Repeatability f_w	a	b	c	e	g	Connection thread
		mm	mm	mm / mm		μm	mm	mm	mm	mm	mm	
4484268	844 DS-R	3-4	0.2	-0.015 / -0.025	1.5 %, min. 1 μm	1		33	23.5	1	23.5	M6 x 0.75 / M3.5x0.35
4484269	844 DS-R	>4-7	0.2	-0.015 / -0.025	1.5 %, min. 1 μm	1	4	33	9.5	1	26.5	M6 x 0.75 / M3.5x0.35
4484270	844 DS-R	>7-9	0.2	-0.015 / -0.025	1.5 %, min. 1 μm	1	6.9	45.5	13.5	1	33.5	M6 x 0.75
4484271	844 DS-R	>9-12	0.2	-0.015 / -0.025	1.5 %, min. 1 μm	1	7.9	45.5	13.5	1	45.5	M6 x 0.75
4484272	844 DS-R	>12-13	0.2	-0.015 / -0.025	1.5 %, min. 1 μm	1	7.9	45.5	13.5	1	45.5	M6 x 0.75
4484273	844 DS-R	>13-16	0.2	-0.015 / -0.025	1.5 %, min. 1 μm	1	11.9	45.5	13.5	1	45.5	M6 x 0.75
4484274	844 DS-R	>16-20	0.2	-0.015 / -0.025	1.5 %, min. 1 μm	1	15	35.8	13.5	1		M10x1
4484275	844 DS-R	>20-30	0.2	-0.02 / -0.03	1.5 %, min. 1 μm	1	15	38.2	20	1.2		M10x1
4484276	844 DS-R	>30-40	0.2	-0.02 / -0.03	1.5 %, min. 1 μm	1	15	38.2	20	1.2		M10x1
4484277	844 DS-R	>40-60	0.2	-0.02 / -0.03	1.5 %, min. 1 μm	1	15	38.2	28	1.2		M10x1
4484278	844 DS-R	>60-80	0.2	-0.025 / -0.035	1.5 %, min. 1 μm	1	17.9	39	33	1.2		M10x1
4484279	844 DS-R	>80-100	0.2	-0.025 / -0.035	1.5 %, min. 1 μm	1	17.9	39	33	1.2		M10x1
4484280	844 DS-R	>100-110	0.2	-0.025 / -0.035	1.5 %, min. 1 μm	1	17.9	39	33	1.2		M10x1
4484281	844 DS-R	>110-120	0.2	-0.025 / -0.035	1.5 %, min. 1 μm	1	17.9	39	33	1.2		M10x1
4484282	844 DS-R	>120-130	0.2	-0.025 / -0.035	1.5 %, min. 1 μm	1	17.9	39	33	1.2		M10x1
4484283	844 DS-R	>130-140	0.2	-0.035 / -0.045	1.5 %, min. 1 μm	1	17.9	39	33	1.2		M10x1
4484284	844 DS-R	>140-150	0.2	-0.035 / -0.045	1.5 %, min. 1 μm	1	17.9	39	33	1.2		M10x1
4484285	844 DS-R	>150-160	0.2	-0.035 / -0.045	1.5 %, min. 1 μm	1	17.9	39	33	1.2		M10x1
4484286	844 DS-R	>160-170	0.2	-0.035 / -0.045	1.5 %, min. 1 μm	1	17.9	38.6	40	1.2		M10x1
4484287	844 DS-R	>170-180	0.2	-0.035 / -0.045	1.5 %, min. 1 μm	1	17.9	38.6	40	1.2		M10x1
4484288	844 DS-R	>180-190	0.2	-0.035 / -0.045	1.5 %, min. 1 μm	1	17.9	38.6	40	1.2		M10x1
4484289	844 DS-R	>190-200	0.2	-0.035 / -0.045	1.5 %, min. 1 μm	1	17.9	38.6	40	1.2		M10x1

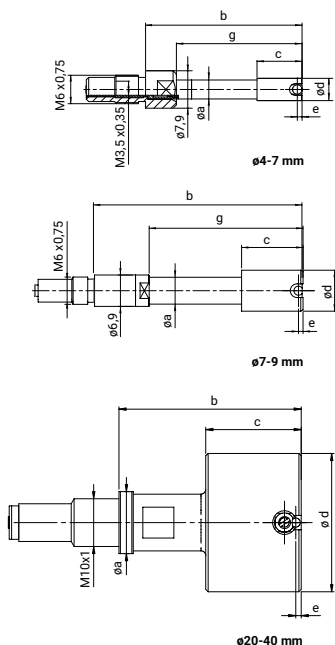

Marameter 844 D-D

Indicating plug gage

FEATURES

- Measuring probe made of hardened, stainless guide cylinder and diamond-tipped probes
- Carbide driving needle transfers radial measuring movement to the display unit
- Constant measuring force as a result of built-in spring, eliminating user influence
- Measuring head, measuring instrument holder, depth extensions, right angle attachments and depth stops form a comprehensive modular system

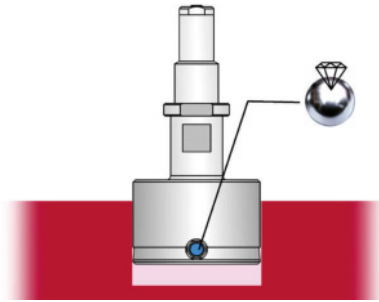

Application:

Standard model, measuring surfaces diamond-tipped

- Preferred application on very sensitive surfaces of soft non-ferrous metals and aluminium alloys
- For rapid testing of diameter, roundness and conicity of bores
- Especially suitable for testing batches with tight tolerance zones
- Rocking in the bore is not required to determine diameter
- Ideal for use in conjunction with digital display units and for subsequent processing of measured values

TECHNICAL DATA

Order no.	Type	Measuring range	Measuring span	Manu- facturing tolerance	Linearity deviation	Repeatability f_w	a	b	c	e	g	Connection thread
		mm	mm	mm / mm		μm	mm	mm	mm	mm	mm	
4484300	844 D-D	8–9	0.2	-0.015 / -0.025	1 %, min. 1 μm	1	5.7	47	15	2.5	35	M6 x 0.75
4484301	844 D-D	>9–12	0.2	-0.015 / -0.025	1 %, min. 1 μm	1	7.9	47	15	2.5	47	M6 x 0.75
4484302	844 D-D	>12–13	0.2	-0.015 / -0.025	1 %, min. 1 μm	1	7.9	47	15	2.5	47	M6 x 0.75
4484303	844 D-D	>13–16	0.2	-0.015 / -0.025	1 %, min. 1 μm	1	11.9	47	15	2.5	47	M6 x 0.75
4484304	844 D-D	>16–20	0.2	-0.015 / -0.025	1 %, min. 1 μm	1	15	37.3	15	2.5		M10x1
4484305	844 D-D	>20–30	0.2	-0.02 / -0.03	1 %, min. 1 μm	1	15	38.2	20	3.5		M10x1
4484306	844 D-D	>30–40	0.2	-0.02 / -0.03	1 %, min. 1 μm	1	15	38.2	20	3.5		M10x1
4484307	844 D-D	>40–60	0.2	-0.02 / -0.03	1 %, min. 1 μm	1	15	38.2	28	3.5		M10x1
4484308	844 D-D	>60–80	0.2	-0.025 / -0.035	1 %, min. 1 μm	1	17.9	38.8	33	4		M10x1
4484309	844 D-D	>80–100	0.2	-0.025 / -0.035	1 %, min. 1 μm	1	17.9	38.8	33	4		M10x1
4484310	844 D-D	>100–110	0.2	-0.025 / -0.035	1 %, min. 1 μm	1	17.9	38.8	33	4		M10x1
4484311	844 D-D	>110–120	0.2	-0.025 / -0.035	1 %, min. 1 μm	1	17.9	38.8	33	4		M10x1
4484312	844 D-D	>120–130	0.2	-0.025 / -0.035	1 %, min. 1 μm	1	17.9	38.8	33	4		M10x1
4484313	844 D-D	>130–140	0.2	-0.035 / -0.045	1 %, min. 1 μm	1	17.9	38.8	33	4		M10x1
4484314	844 D-D	>140–150	0.2	-0.035 / -0.045	1 %, min. 1 μm	1	17.9	38.8	33	4		M10x1
4484315	844 D-D	>150–160	0.2	-0.035 / -0.045	1 %, min. 1 μm	1	17.9	38.8	33	4		M10x1
4484316	844 D-D	>160–170	0.2	-0.035 / -0.045	1 %, min. 1 μm	1	17.9	39	40	4		M10x1
4484317	844 D-D	>170–180	0.2	-0.035 / -0.045	1 %, min. 1 μm	1	17.9	39	40	4		M10x1
4484318	844 D-D	>180–190	0.2	-0.035 / -0.045	1 %, min. 1 μm	1	17.9	39	40	4		M10x1
4484319	844 D-D	>190–200	0.2	-0.035 / -0.045	1 %, min. 1 μm	1	17.9	39	40	4		M10x1

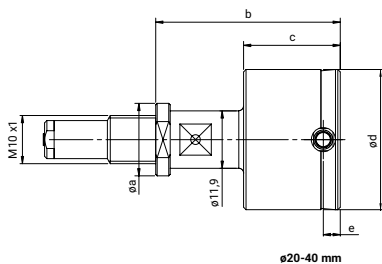
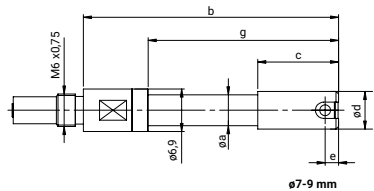

Marameter 844 DR-D

Indicating plug gage

FEATURES

- Measuring probe made of hardened, stainless guide cylinder and diamond-tipped probes
- Carbide driving needle transfers radial measuring movement to the display unit
- Constant measuring force as a result of built-in spring, eliminating user influence
- Measuring head, measuring instrument holder, depth extensions, right angle attachments and depth stops form a comprehensive modular system

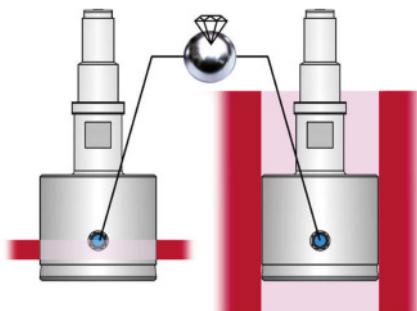

Application:

Model for through holes, measuring surfaces diamond-tipped

- Preferred application on very sensitive surfaces of soft non-ferrous metals and aluminium alloys
- With extended guide cylinder for measuring through holes from the edge of the hole
- For rapid testing of diameter, roundness and conicity of bores
- Especially suitable for testing batches with tight tolerance zones
- Rocking in the bore is not required to determine diameter
- Ideal for use in conjunction with digital display units and for subsequent processing of measured values

TECHNICAL DATA

Order no.	Type	Measuring range	Measuring span	Manufacturing tolerance	Linearity deviation	Repeatability f_w	a	b	c	e	g	Connection thread
4484330	844 DR-D	8–9	0.2	-0.015 / -0.025	1 %, min. 1 μ m	1	5.7	50.5	18.5	6	38.5	M6 x 0.75
4484331	844 DR-D	>9–12	0.2	-0.015 / -0.025	1 %, min. 1 μ m	1	7.9	54.5	22.5	10	54.5	M6 x 0.75
4484332	844 DR-D	>12–13	0.2	-0.015 / -0.025	1 %, min. 1 μ m	1	7.9	54.5	22.5	10	54.5	M6 x 0.75
4484333	844 DR-D	>13–16	0.2	-0.015 / -0.025	1 %, min. 1 μ m	1	11.9	54.5	22.5	10	54.5	M6 x 0.75
4484334	844 DR-D	>16–20	0.2	-0.015 / -0.025	1 %, min. 1 μ m	1	15	44.8	22.5	10		M10x1
4484335	844 DR-D	>20–30	0.2	-0.02 / -0.03	1 %, min. 1 μ m	1	15	44.7	27	10		M10x1
4484336	844 DR-D	>30–40	0.2	-0.02 / -0.03	1 %, min. 1 μ m	1	15	44.7	27	10		M10x1
4484337	844 DR-D	>40–60	0.2	-0.02 / -0.03	1 %, min. 1 μ m	1	15	44.7	28	10		M10x1
4484338	844 DR-D	>60–80	0.2	-0.025 / -0.035	1 %, min. 1 μ m	1	17.9	44.8	33	10		M10x1
4484339	844 DR-D	>80–100	0.2	-0.025 / -0.035	1 %, min. 1 μ m	1	17.9	44.8	33	10		M10x1
4484340	844 DR-D	>100–110	0.2	-0.025 / -0.035	1 %, min. 1 μ m	1	17.9	44.8	33	10		M10x1
4484341	844 DR-D	>110–120	0.2	-0.025 / -0.035	1 %, min. 1 μ m	1	17.9	44.8	33	10		M10x1
4484342	844 DR-D	>120–130	0.2	-0.025 / -0.035	1 %, min. 1 μ m	1	17.9	44.8	33	10		M10x1
4484343	844 DR-D	>130–140	0.2	-0.035 / -0.045	1 %, min. 1 μ m	1	17.9	44.8	33	10		M10x1
4484344	844 DR-D	>140–150	0.2	-0.035 / -0.045	1 %, min. 1 μ m	1	17.9	44.8	33	10		M10x1
4484345	844 DR-D	>150–160	0.2	-0.035 / -0.045	1 %, min. 1 μ m	1	17.9	44.8	33	10		M10x1
4484346	844 DR-D	>160–170	0.2	-0.035 / -0.045	1 %, min. 1 μ m	1	17.9	45	40	10		M10x1
4484347	844 DR-D	>170–180	0.2	-0.035 / -0.045	1 %, min. 1 μ m	1	17.9	45	40	10		M10x1
4484348	844 DR-D	>180–190	0.2	-0.035 / -0.045	1 %, min. 1 μ m	1	17.9	45	40	10		M10x1
4484349	844 DR-D	>190–200	0.2	-0.035 / -0.045	1 %, min. 1 μ m	1	17.9	45	40	10		M10x1

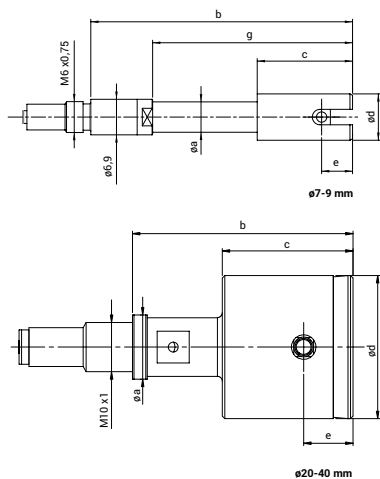

Marameter 844 D-FD

Indicating plug gage

FEATURES

- The face distance dimension "e" must be set between minimum dimension e and standard dimension - Please specify when placing an order!
- Measuring probe made of hardened, stainless guide cylinder and carbide tipped probes
- Carbide driving needle transfers radial measuring movement to the display unit
- Constant measuring force as a result of built-in spring, eliminating user influence
- Measuring head, measuring instrument holder, depth extensions, right angle attachments and depth stops form a comprehensive modular system

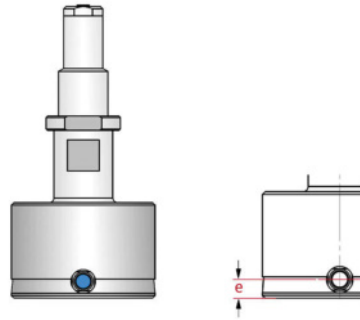

Application:

Standard version, measuring contacts with customer-specified location "e"

- Shorter guide cylinder for measuring closer to the bottom of the hole or at a defined spot
- For the rapid testing of diameter, roundness and conicity of holes
- Especially suitable for testing batches with tight tolerance fields
- Rocking in the bore is not required to determine diameter
- Ideal for use in conjunction with digital display units and for subsequent processing of measured values

TECHNICAL DATA

Order no.	Type	Measuring range	Measuring span	Manufacturing tolerance	Linearity deviation f_e	Repeatability f_w	a	b	c	e	g	Connection thread
		mm	mm	mm / mm		μm	mm	mm	mm	mm	mm	
4484387	844 D-FD	2–2,999	0.15	-0.015 / -0.025	1.5 %, min. 1 μm	1		20.7	14,2	0.8 -1.4	14,2	M6 x 0.75 / M3.5x0.35
4484388	844 D-FD	3–4	0.2	-0.015 / -0.025	1.5 %, min. 1 μm	1		33	23.5	1.1 -1.4	23.5	M6 x 0.75 / M3.5x0.35
4484389	844 D-FD	>4–7	0.2	-0.015 / -0.025	1.5 %, min. 1 μm	1	4	33	9.5	1.1 -1.4	26.5	M6 x 0.75 / M3.5x0.35
4484390	844 D-FD	>7–9	0.2	-0.015 / -0.025	1.5 %, min. 1 μm	1	6.9	45.5	13.5	1.1 -2.4	33.5	M6 x 0.75
4484391	844 D-FD	>9–12	0.2	-0.015 / -0.025	1.5 %, min. 1 μm	1	7.9	45.5	13.5	1.1 -2.4	45.5	M6 x 0.75
4484392	844 D-FD	>12–13	0.2	-0.015 / -0.025	1.5 %, min. 1 μm	1	7.9	45.5	13.5	1.1 -2.4	45.5	M6 x 0.75
4484393	844 D-FD	>13–16	0.2	-0.015 / -0.025	1.5 %, min. 1 μm	1	11.9	45.5	13.5	1.1 -2.4	45.5	M6 x 0.75
4484394	844 D-FD	>16–20	0.2	-0.015 / -0.025	1.5 %, min. 1 μm	1	15	35.8	13.5	1.1 -2.4		M10x1
4484395	844 D-FD	>20–30	0.2	-0.02 / -0.03	1.5 %, min. 1 μm	1	15	38.2	20	1.3 -3,4		M10x1
4484396	844 D-FD	>30–40	0.2	-0.02 / -0.03	1.5 %, min. 1 μm	1	15	38.2	20	1.3 -3,4		M10x1
4484397	844 D-FD	>40–60	0.2	-0.02 / -0.03	1.5 %, min. 1 μm	1	15	38.2	28	1.3 -3,4		M10x1
4484398	844 D-FD	>60–80	0.2	-0.025 / -0.035	1.5 %, min. 1 μm	1	17.9	39	33	1.3 -3,9		M10x1
4484399	844 D-FD	>80–100	0.2	-0.025 / -0.035	1.5 %, min. 1 μm	1	17.9	39	33	1.3 -3,9		M10x1
4484400	844 D-FD	>100–110	0.2	-0.025 / -0.035	1.5 %, min. 1 μm	1	17.9	39	33	1.3 -3,9		M10x1
4484401	844 D-FD	>110–120	0.2	-0.025 / -0.035	1.5 %, min. 1 μm	1	17.9	39	33	1.3 -3,9		M10x1
4484402	844 D-FD	>120–130	0.2	-0.025 / -0.035	1.5 %, min. 1 μm	1	17.9	39	33	1.3 -3,9		M10x1
4484403	844 D-FD	>130–140	0.2	-0.035 / -0.045	1.5 %, min. 1 μm	1	17.9	39	33	1.3 -3,9		M10x1
4484404	844 D-FD	>140–150	0.2	-0.035 / -0.045	1.5 %, min. 1 μm	1	17.9	39	33	1.3 -3,9		M10x1
4484405	844 D-FD	>150–160	0.2	-0.035 / -0.045	1.5 %, min. 1 μm	1	17.9	39	33	1.3 -3,9		M10x1
4484406	844 D-FD	>160–170	0.2	-0.035 / -0.045	1.5 %, min. 1 μm	1	17.9	38.6	40	1.3 -3,9		M10x1
4484407	844 D-FD	>170–180	0.2	-0.035 / -0.045	1.5 %, min. 1 μm	1	17.9	38.6	40	1.3 -3,9		M10x1
4484408	844 D-FD	>180–190	0.2	-0.035 / -0.045	1.5 %, min. 1 μm	1	17.9	38.6	40	1.3 -3,9		M10x1
4484409	844 D-FD	>190–200	0.2	-0.035 / -0.045	1.5 %, min. 1 μm	1	17.9	37	40	1.3 -3,9		M10x1

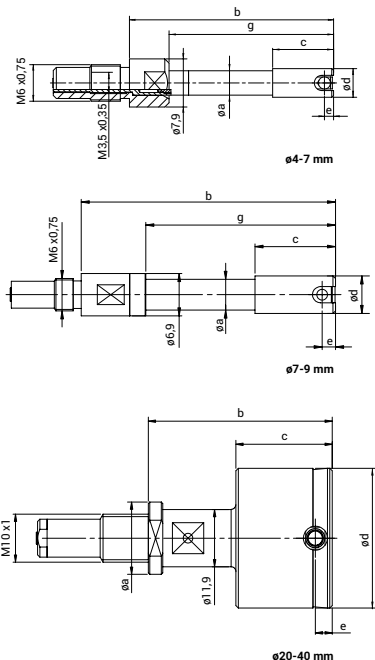

Marameter 844 DR-FD

Indicating plug gage

FEATURES

- The face distance dimension "e" must be set between minimum dimension e and standard dimension - Please specify when placing an order!
- Measuring probe made of hardened, stainless guide cylinder and carbide tipped probes
- Carbide driving needle transfers radial measuring movement to the display unit
- Constant measuring force as a result of built-in spring, eliminating user influence
- Measuring head, measuring instrument holder, depth extensions, right angle attachments and depth stops form a comprehensive modular system

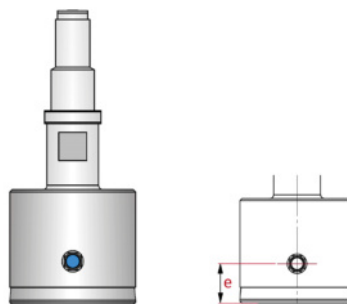

Application:

Model for through holes, anvils with customer-specified location "e"

- Reducing the guide cylinder to measure closer, or at a defined position, to the ground of the bore
- With extended guide cylinder for measuring through holes from the edge of the hole
- For rapid testing of diameter, roundness and conicity of bores
- Especially suitable for testing batches with tight tolerance zones
- Rocking in the bore is not required to determine diameter
- Ideal for use in conjunction with digital display units and for subsequent processing of measured values

TECHNICAL DATA

Order no.	Type	Measuring range	Measuring span	Manufacturing tolerance	Linearity deviation	Repeatability f_w	a	b	c	e	g	Connection thread
4484419	844 DR-FD	4-7	0.2	-0.015 / -0.025	1 %, min. 1 μ m	1	4	38	14.5	1.6	31.5	M6 x 0.75 / M3.5x0.35
4484420	844 DR-FD	>7-9	0.2	-0.015 / -0.025	1 %, min. 1 μ m	1	6.9	50.5	18.5	2.6	38.5	M6 x 0.75
4484421	844 DR-FD	>9-12	0.2	-0.015 / -0.025	1 %, min. 1 μ m	1	7.9	54.5	22.5	2.6	54.5	M6 x 0.75
4484422	844 DR-FD	>12-13	0.2	-0.015 / -0.025	1 %, min. 1 μ m	1	7.9	54.5	22.5	2.6	54.5	M6 x 0.75
4484423	844 DR-FD	>13-16	0.2	-0.015 / -0.025	1 %, min. 1 μ m	1	11.9	54.5	22.5	2.6	54.5	M6 x 0.75
4484424	844 DR-FD	>16-20	0.2	-0.015 / -0.025	1 %, min. 1 μ m	1	15	44.8	22.5	2.6		M10x1
4484425	844 DR-FD	>20-30	0.2	-0.02 / -0.03	1 %, min. 1 μ m	1	15	44.7	27	3.6		M10x1
4484426	844 DR-FD	>30-40	0.2	-0.02 / -0.03	1 %, min. 1 μ m	1	15	44.7	27	3.6		M10x1
4484427	844 DR-FD	>40-60	0.2	-0.02 / -0.03	1 %, min. 1 μ m	1	15	44.7	28	3.6		M10x1
4484428	844 DR-FD	>60-80	0.2	-0.025 / -0.035	1 %, min. 1 μ m	1	17.9	44.8	33	4.1		M10x1
4484429	844 DR-FD	>80-100	0.2	-0.025 / -0.035	1 %, min. 1 μ m	1	17.9	44.8	33	4.1		M10x1
4484430	844 DR-FD	>100-110	0.2	-0.025 / -0.035	1 %, min. 1 μ m	1	17.9	44.8	33	4.1		M10x1
4484431	844 DR-FD	>110-120	0.2	-0.025 / -0.035	1 %, min. 1 μ m	1	17.9	44.8	33	4.1		M10x1
4484432	844 DR-FD	>120-130	0.2	-0.025 / -0.035	1 %, min. 1 μ m	1	17.9	44.8	33	4.1		M10x1
4484433	844 DR-FD	>130-140	0.2	-0.035 / -0.045	1 %, min. 1 μ m	1	17.9	44.8	33	4.1		M10x1
4484434	844 DR-FD	>140-150	0.2	-0.035 / -0.045	1 %, min. 1 μ m	1	17.9	44.8	33	4.1		M10x1
4484435	844 DR-FD	>150-160	0.2	-0.035 / -0.045	1 %, min. 1 μ m	1	17.9	44.8	33	4.1		M10x1
4484436	844 DR-FD	>160-170	0.2	-0.035 / -0.045	1 %, min. 1 μ m	1	17.9	45	40	4.1		M10x1
4484437	844 DR-FD	>170-180	0.2	-0.035 / -0.045	1 %, min. 1 μ m	1	17.9	45	40	4.1		M10x1
4484438	844 DR-FD	>180-190	0.2	-0.035 / -0.045	1 %, min. 1 μ m	1	17.9	45	40	4.1		M10x1
4484439	844 DR-FD	>190-200	0.2	-0.035 / -0.045	1 %, min. 1 μ m	1	17.9	45	40	4.1		M10x1

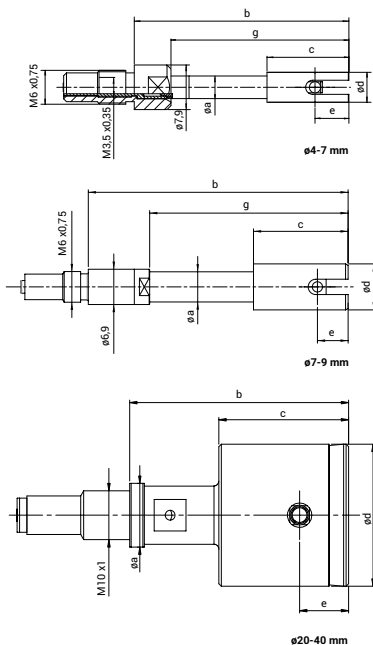

Marameter 844 D-M

Indicating plug gage

FEATURES

- Measuring probe made of hardened, stainless guide cylinder and carbide tipped probes
- Carbide driving needle transfers radial measuring movement to the display unit
- Constant measuring force as a result of built-in spring, eliminating user influence
- Measuring head, measuring instrument holder, depth extensions, right angle attachments and depth stops form a comprehensive modular system

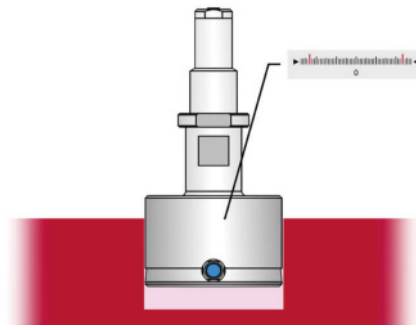

Application:

Standard model, with extended measuring range

- For rapid testing of diameter, roundness and conicity of bores
- Especially suitable for testing batches with wide tolerance zones
- Rocking in the bore is not required to determine diameter
- Ideal for use in conjunction with digital display units and for subsequent processing of measured values

TECHNICAL DATA

Order no.	Type	Measuring range	Measuring span	Manufacturing tolerance	Linearity deviation	Repeatability f_w	a	b	c	e	g	Connection thread
		mm	mm	mm / mm		μm	mm	mm	mm	mm	mm	
4484448	844 D-M	3–4	0.4	-0.015 / -0.025	1 %, min. 1 μm	1		33.5	24	1.5	24	M6 x 0.75 / M3.5x0.35
4484449	844 D-M	>4–7	0.4	-0.015 / -0.025	1 %, min. 1 μm	1	4	33.5	10	1.5	27	M6 x 0.75 / M3.5x0.35
4484450	844 D-M	>7–9	0.6	-0.015 / -0.025	1 %, min. 1 μm	1	6.9	47	15	2.5	35	M6 x 0.75
4484451	844 D-M	>9–12	0.6	-0.015 / -0.025	1 %, min. 1 μm	1	7.9	47	15	2.5	47	M6 x 0.75
4484452	844 D-M	>12–13	0.6	-0.015 / -0.025	1 %, min. 1 μm	1	7.9	47	15	2.5	47	M6 x 0.75
4484453	844 D-M	>13–16	0.6	-0.015 / -0.025	1 %, min. 1 μm	1	11.9	47	15	2.5	47	M6 x 0.75
4484454	844 D-M	>16–20	0.6	-0.015 / -0.025	1 %, min. 1 μm	1	15	37.3	15	2.5		M10x1
4484455	844 D-M	>20–30	0.6	-0.02 / -0.03	1 %, min. 1 μm	1	15	38.2	20	3.5		M10x1
4484456	844 D-M	>30–40	0.6	-0.02 / -0.03	1 %, min. 1 μm	1	15	38.2	20	3.5		M10x1
4484457	844 D-M	>40–60	0.6	-0.02 / -0.03	1 %, min. 1 μm	1	15	38.2	28	3.5		M10x1
4484458	844 D-M	>60–80	0.6	-0.025 / -0.035	1 %, min. 1 μm	1	17.9	38.8	33	4		M10x1
4484459	844 D-M	>80–100	0.6	-0.025 / -0.035	1 %, min. 1 μm	1	17.9	38.8	33	4		M10x1
4484460	844 D-M	>100–110	0.6	-0.025 / -0.035	1 %, min. 1 μm	1	17.9	38.8	33	4		M10x1
4484461	844 D-M	>110–120	0.6	-0.025 / -0.035	1 %, min. 1 μm	1	17.9	38.8	33	4		M10x1
4484462	844 D-M	>120–130	0.6	-0.025 / -0.035	1 %, min. 1 μm	1	17.9	38.8	33	4		M10x1
4484463	844 D-M	>130–140	0.6	-0.035 / -0.045	1 %, min. 1 μm	1	17.9	38.8	33	4		M10x1
4484464	844 D-M	>140–150	0.6	-0.035 / -0.045	1 %, min. 1 μm	1	17.9	38.8	33	4		M10x1
4484465	844 D-M	>150–160	0.6	-0.035 / -0.045	1 %, min. 1 μm	1	17.9	38.8	33	4		M10x1
4484466	844 D-M	>160–170	0.6	-0.035 / -0.045	1 %, min. 1 μm	1	17.9	39	40	4		M10x1
4484467	844 D-M	>170–180	0.6	-0.035 / -0.045	1 %, min. 1 μm	1	17.9	39	40	4		M10x1
4484468	844 D-M	>180–190	0.6	-0.035 / -0.045	1 %, min. 1 μm	1	17.9	39	40	4		M10x1
4484469	844 D-M	>190–200	0.6	-0.035 / -0.045	1 %, min. 1 μm	1	17.9	39	40	4		M10x1

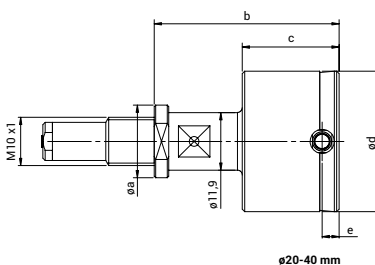
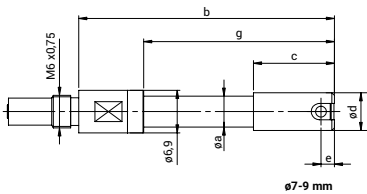
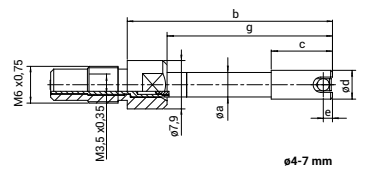

Marameter 844 DR-M

Indicating plug gage

FEATURES

- Measuring probe made of hardened, stainless guide cylinder and carbide tipped probes
- Carbide driving needle transfers radial measuring movement to the display unit
- Constant measuring force as a result of built-in spring, eliminating user influence
- Measuring head, measuring instrument holder, depth extensions, right angle attachments and depth stops form a comprehensive modular system

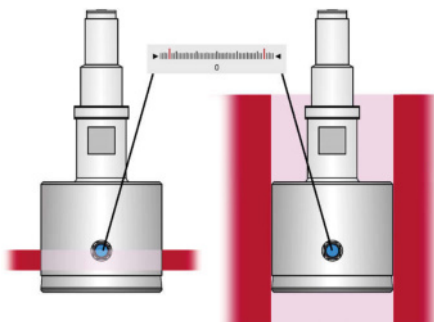

Application:

Model for through holes, with extended measuring range

- With extended guide cylinder for measuring through holes from the edge of the hole
- For the rapid testing of diameter, roundness and conicity of bores
- Especially suitable for testing batches with wide tolerance zones
- Rocking in the bore is not required to determine diameter
- Ideal for use in conjunction with digital display units and for subsequent processing of measured values

TECHNICAL DATA

Order no.	Type	Measuring range	Measuring span	Manufacturing tolerance	Linearity deviation	Repeatability f_w	a	b	c	e	g	Connection thread
		mm	mm	mm / mm		μm	mm	mm	mm	mm	mm	
4484479	844 DR-M	4–7	0.4	-0.015 / -0.025	1 %, min. 1 μm	1	4	38	14.5	6	31.5	M6 x 0.75 / M3.5x0.35
4484480	844 DR-M	>7–9	0.6	-0.015 / -0.025	1 %, min. 1 μm	1	6.9	50.5	18.5	6	38.5	M6 x 0.75
4484481	844 DR-M	>9–12	0.6	-0.015 / -0.025	1 %, min. 1 μm	1	7.9	54.5	22.5	10	54.5	M6 x 0.75
4484482	844 DR-M	>12–13	0.6	-0.015 / -0.025	1 %, min. 1 μm	1	7.9	54.5	22.5	10	54.5	M6 x 0.75
4484483	844 DR-M	>13–16	0.6	-0.015 / -0.025	1 %, min. 1 μm	1	11.9	54.5	22.5	10	54.5	M6 x 0.75
4484484	844 DR-M	>16–20	0.6	-0.015 / -0.025	1 %, min. 1 μm	1	15	44.8	22.5	10		M10x1
4484485	844 DR-M	>20–30	0.6	-0.02 / -0.03	1 %, min. 1 μm	1	15	44.7	27	10		M10x1
4484486	844 DR-M	>30–40	0.6	-0.02 / -0.03	1 %, min. 1 μm	1	15	44.7	27	10		M10x1
4484487	844 DR-M	>40–60	0.6	-0.02 / -0.03	1 %, min. 1 μm	1	15	44.7	28	10		M10x1
4484488	844 DR-M	>60–80	0.6	-0.025 / -0.035	1 %, min. 1 μm	1	17.9	44.8	33	10		M10x1
4484489	844 DR-M	>80–100	0.6	-0.025 / -0.035	1 %, min. 1 μm	1	17.9	44.8	33	10		M10x1
4484490	844 DR-M	>100–110	0.6	-0.025 / -0.035	1 %, min. 1 μm	1	17.9	44.8	33	10		M10x1
4484491	844 DR-M	>110–120	0.6	-0.025 / -0.035	1 %, min. 1 μm	1	17.9	44.8	33	10		M10x1
4484492	844 DR-M	>120–130	0.6	-0.025 / -0.035	1 %, min. 1 μm	1	17.9	44.8	33	10		M10x1
4484493	844 DR-M	>130–140	0.6	-0.035 / -0.045	1 %, min. 1 μm	1	17.9	44.8	33	10		M10x1
4484494	844 DR-M	>140–150	0.6	-0.035 / -0.045	1 %, min. 1 μm	1	17.9	44.8	33	10		M10x1
4484495	844 DR-M	>150–160	0.6	-0.035 / -0.045	1 %, min. 1 μm	1	17.9	44.8	33	10		M10x1
4484496	844 DR-M	>160–170	0.6	-0.035 / -0.045	1 %, min. 1 μm	1	17.9	45	40	10		M10x1
4484497	844 DR-M	>170–180	0.6	-0.035 / -0.045	1 %, min. 1 μm	1	17.9	45	40	10		M10x1
4484498	844 DR-M	>180–190	0.6	-0.035 / -0.045	1 %, min. 1 μm	1	17.9	45	40	10		M10x1
4484499	844 DR-M	>190–200	0.6	-0.035 / -0.045	1 %, min. 1 μm	1	17.9	45	40	10		M10x1

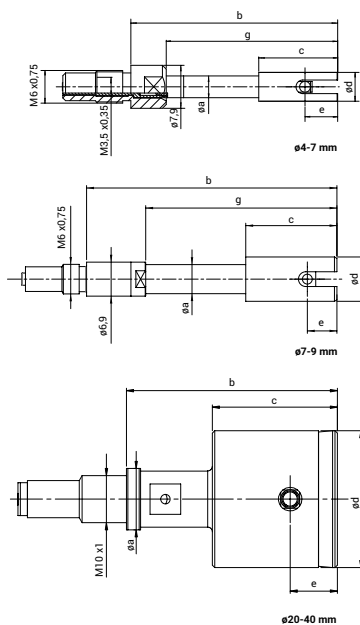

Marameter 844 DS-M

Indicating plug gage

FEATURES

- Measuring probe made of hardened, stainless steel guide cylinder and carbide tipped probes
- Carbide driving needle transfers radial measuring movement to the display unit
- Constant measuring force as a result of built-in spring, eliminating user influence
- Measuring head, measuring instrument holder, depth extensions, right angle attachments, and depth stops form a comprehensive modular system

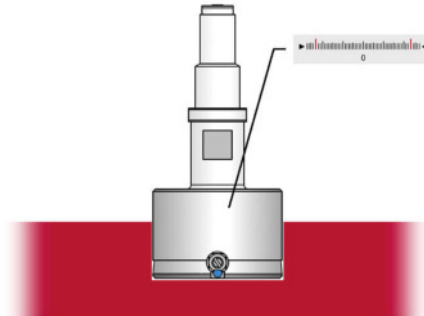

Application: Model for blind holes, with extended measuring range

Recommendation: To protect the measuring contacts when inserting them into the bore, the use of a holder with lifting device (844 Kga or 844 Dga) is recommended

- For measurements close to the base of the hole
- For the rapid testing of diameter, roundness and conicity of bores
- Especially suitable for testing batches with wide tolerance zones
- Rocking in the bore is not required to determine diameter
- Ideal for use in conjunction with digital display units and for subsequent processing of measured values

TECHNICAL DATA

Order no.	Type	Measuring range	Measuring span	Manufacturing tolerance	Linearity deviation	Repeatability f_w	a	b	c	e	g	Connection thread
		mm	mm	mm / mm		μm	mm	mm	mm	mm	mm	
4484508	844 DS-M	3–4	0.4	-0.015 / -0.025	1.5 %, min. 1 μm	1		33	23.5	1	23.5	M6 x 0.75 / M3.5x0.35
4484509	844 DS-M	>4–7	0.4	-0.015 / -0.025	1.5 %, min. 1 μm	1	4	33	9.5	1	26.5	M6 x 0.75 / M3.5x0.35
4484510	844 DS-M	>7–9	0.6	-0.015 / -0.025	1.5 %, min. 1 μm	1	6.9	45.5	13.5	1	33.5	M6 x 0.75
4484511	844 DS-M	>9–12	0.6	-0.015 / -0.025	1.5 %, min. 1 μm	1	7.9	45.5	13.5	1	45.5	M6 x 0.75
4484512	844 DS-M	>12–13	0.6	-0.015 / -0.025	1.5 %, min. 1 μm	1	7.9	45.5	13.5	1	45.5	M6 x 0.75
4484513	844 DS-M	>13–16	0.6	-0.015 / -0.025	1.5 %, min. 1 μm	1	11.9	45.5	13.5	1	45.5	M6 x 0.75
4484514	844 DS-M	>16–20	0.6	-0.015 / -0.025	1.5 %, min. 1 μm	1	15	35.8	13.5	1		M10x1
4484515	844 DS-M	>20–30	0.6	-0.02 / -0.03	1.5 %, min. 1 μm	1	15	38.2	20	1.2		M10x1
4484516	844 DS-M	>30–40	0.6	-0.02 / -0.03	1.5 %, min. 1 μm	1	15	38.2	20	1.2		M10x1
4484517	844 DS-M	>40–60	0.6	-0.02 / -0.03	1.5 %, min. 1 μm	1	15	38.2	28	1.2		M10x1
4484518	844 DS-M	>60–80	0.6	-0.025 / -0.035	1.5 %, min. 1 μm	1	17.9	39	33	1.2		M10x1
4484519	844 DS-M	>80–100	0.6	-0.025 / -0.035	1.5 %, min. 1 μm	1	17.9	39	33	1.2		M10x1
4484520	844 DS-M	>100–110	0.6	-0.025 / -0.035	1.5 %, min. 1 μm	1	17.9	39	33	1.2		M10x1
4484521	844 DS-M	>110–120	0.6	-0.025 / -0.035	1.5 %, min. 1 μm	1	17.9	39	33	1.2		M10x1
4484522	844 DS-M	>120–130	0.6	-0.025 / -0.035	1.5 %, min. 1 μm	1	17.9	39	33	1.2		M10x1
4484523	844 DS-M	>130–140	0.6	-0.035 / -0.045	1.5 %, min. 1 μm	1	17.9	39	33	1.2		M10x1
4484524	844 DS-M	>140–150	0.6	-0.035 / -0.045	1.5 %, min. 1 μm	1	17.9	39	33	1.2		M10x1
4484525	844 DS-M	>150–160	0.6	-0.035 / -0.045	1.5 %, min. 1 μm	1	17.9	39	33	1.2		M10x1
4484526	844 DS-M	>160–170	0.6	-0.035 / -0.045	1.5 %, min. 1 μm	1	17.9	38.6	40	1.2		M10x1
4484527	844 DS-M	>170–180	0.6	-0.035 / -0.045	1.5 %, min. 1 μm	1	17.9	38.6	40	1.2		M10x1
4484528	844 DS-M	>180–190	0.6	-0.035 / -0.045	1.5 %, min. 1 μm	1	17.9	38.6	40	1.2		M10x1
4484529	844 DS-M	>190–200	0.6	-0.035 / -0.045	1.5 %, min. 1 μm	1	17.9	38.6	40	1.2		M10x1

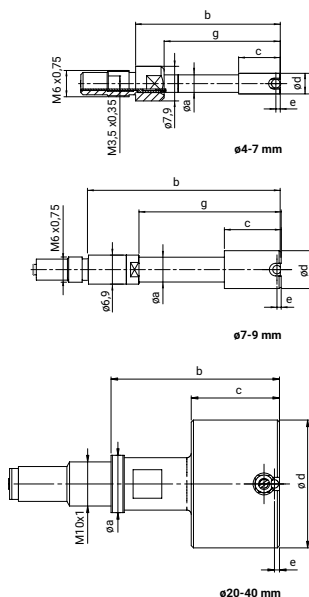

Marameter 844 D-HR

Indicating plug gage

FEATURES

- Measuring probe made of hardened, stainless guide cylinder and carbide tipped probes
- Carbide driving needle transfers radial measuring movement to the display unit
- Constant measuring force as a result of built-in spring, eliminating user influence
- Measuring head, measuring instrument holder, depth extensions, right angle attachments and depth stops form a comprehensive modular system

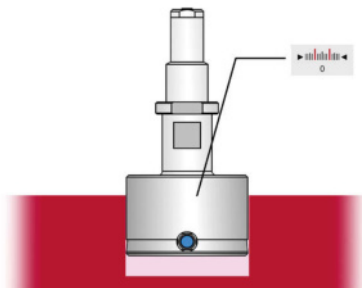

Application:

Standard version for very tight tolerance fields less than 10 µm

- Manufacturing tolerance of the guide cylinder reduced to 0.01 mm ($\pm 5 \mu\text{m}$) to reduce the axial and radial measuring influences
- For the rapid testing of diameter, roundness and conicity of bores
- Ideal for testing batches with very tight tolerance fields less than 10 µm
- Rocking in the bore is not required to determine diameter
- Ideal for use in conjunction with digital display units and for subsequent processing of measured values

TECHNICAL DATA

Order no.	Type	Measuring range	Measuring span	Manufacturing tolerance	Linearity deviation	Repeatability f_w	a	b	c	e	g	Connection thread
		mm	mm	mm / mm		μm	mm	mm	mm	mm	mm	
4484538	844 D-HR	3–4	0.2	-0.005 / -0.015	1 % , min. 1 µm	1		33.5	24	1.5	24	M6 x 0.75 / M3.5x0.35
4484539	844 D-HR	>4–7	0.2	-0.005 / -0.015	1 % , min. 1 µm	1	4	33.5	10	1.5	27	M6 x 0.75 / M3.5x0.35
4484540	844 D-HR	>7–9	0.2	-0.005 / -0.015	1 % , min. 1 µm	1	6.9	47	15	2.5	35	M6 x 0.75
4484541	844 D-HR	>9–12	0.2	-0.005 / -0.015	1 % , min. 1 µm	1	7.9	47	15	2.5	47	M6 x 0.75
4484542	844 D-HR	>12–13	0.2	-0.005 / -0.015	1 % , min. 1 µm	1	7.9	47	15	2.5	47	M6 x 0.75
4484543	844 D-HR	>13–16	0.2	-0.005 / -0.015	1 % , min. 1 µm	1	11.9	47	15	2.5	47	M6 x 0.75
4484544	844 D-HR	>16–20	0.2	-0.005 / -0.015	1 % , min. 1 µm	1	15	37.3	15	2.5		M10x1
4484545	844 D-HR	>20–30	0.2	-0.01 / -0.02	1 % , min. 1 µm	1	15	38.2	20	3.5		M10x1
4484546	844 D-HR	>30–40	0.2	-0.01 / -0.02	1 % , min. 1 µm	1	15	38.2	20	3.5		M10x1
4484547	844 D-HR	>40–60	0.2	-0.01 / -0.02	1 % , min. 1 µm	1	15	38.2	28	3.5		M10x1
4484548	844 D-HR	>60–80	0.2	-0.015 / -0.025	1 % , min. 1 µm	1	17.9	38.8	33	4		M10x1
4484549	844 D-HR	>80–100	0.2	-0.015 / -0.025	1 % , min. 1 µm	1	17.9	38.8	33	4		M10x1
4484550	844 D-HR	>100–110	0.2	-0.015 / -0.025	1 % , min. 1 µm	1	17.9	38.8	33	4		M10x1
4484551	844 D-HR	>110–120	0.2	-0.015 / -0.025	1 % , min. 1 µm	1	17.9	38.8	33	4		M10x1
4484552	844 D-HR	>120–130	0.2	-0.015 / -0.025	1 % , min. 1 µm	1	17.9	38.8	33	4		M10x1
4484553	844 D-HR	>130–140	0.2	-0.025 / -0.035	1 % , min. 1 µm	1	17.9	38.8	33	4		M10x1
4484554	844 D-HR	>140–150	0.2	-0.025 / -0.035	1 % , min. 1 µm	1	17.9	38.8	33	4		M10x1
4484555	844 D-HR	>150–160	0.2	-0.025 / -0.035	1 % , min. 1 µm	1	17.9	38.8	33	4		M10x1
4484556	844 D-HR	>160–170	0.2	-0.025 / -0.035	1 % , min. 1 µm	1	17.9	39	40	4		M10x1
4484557	844 D-HR	>170–180	0.2	-0.025 / -0.035	1 % , min. 1 µm	1	17.9	39	40	4		M10x1
4484558	844 D-HR	>180–190	0.2	-0.025 / -0.035	1 % , min. 1 µm	1	17.9	39	40	4		M10x1
4484559	844 D-HR	>190–200	0.2	-0.025 / -0.035	1 % , min. 1 µm	1	17.9	39	40	4		M10x1

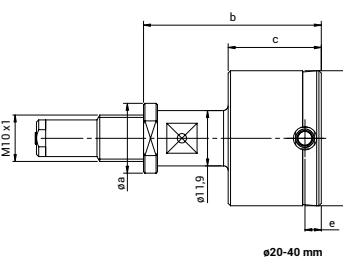
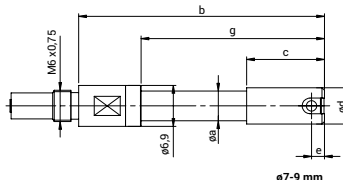
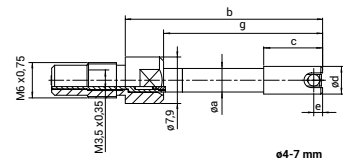

Marameter 844 DR-HR

Indicating plug gage

FEATURES

- Measuring probe made of hardened, stainless guide cylinder and carbide tipped probes
- Carbide driving needle transfers radial measuring movement to the display unit
- Constant measuring force as a result of built-in spring, eliminating user influence
- Measuring head, measuring instrument holder, depth extensions, right angle attachments and depth stops form a comprehensive modular system

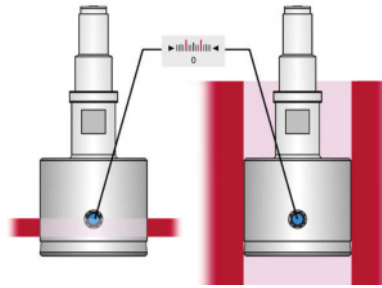

Application:

Model for through holes, for very tight tolerance fields less than 10 µm

- Manufacturing tolerance of the guide cylinder reduced to 0.01 mm ($\pm 5 \mu\text{m}$) to reduce the axial and radial measuring influences
- With extended guide cylinder for measuring through holes from the edge of the hole
- For the rapid testing of diameter, roundness and conicity of bores
- Ideal for testing batches with very tight tolerance fields less than 10 µm
- Rocking in the bore is not required to determine diameter
- Ideal for use in conjunction with digital display units and for subsequent processing of measured values

TECHNICAL DATA

Order no.	Type	Measuring range	Measuring span	Manufacturing tolerance	Linearity	Repeatability f_w	a	b	c	e	g	Connection thread
		mm	mm	mm / mm		μm	mm	mm	mm	mm	mm	
4484569	844 DR-HR	4-7	0.2	-0.005 / -0.015	1 %, min. 1 µm	1	4	38	14.5	6	31.5	M6 x 0.75 / M3.5x0.35
4484570	844 DR-HR	>7-9	0.2	-0.005 / -0.015	1 %, min. 1 µm	1	6.9	50.5	18.5	6	38.5	M6 x 0.75
4484571	844 DR-HR	>9-12	0.2	-0.005 / -0.015	1 %, min. 1 µm	1	7.9	54.5	22.5	10	54.5	M6 x 0.75
4484572	844 DR-HR	>12-13	0.2	-0.005 / -0.015	1 %, min. 1 µm	1	7.9	54.5	22.5	10	54.5	M6 x 0.75
4484573	844 DR-HR	>13-16	0.2	-0.005 / -0.015	1 %, min. 1 µm	1	11.9	54.5	22.5	10	54.5	M6 x 0.75
4484574	844 DR-HR	>16-20	0.2	-0.005 / -0.015	1 %, min. 1 µm	1	15	44.8	22.5	10		M10x1
4484575	844 DR-HR	>20-30	0.2	-0.01 / -0.02	1 %, min. 1 µm	1	15	44.7	27	10		M10x1
4484576	844 DR-HR	>30-40	0.2	-0.01 / -0.02	1 %, min. 1 µm	1	15	44.7	27	10		M10x1
4484577	844 DR-HR	>40-60	0.2	-0.01 / -0.02	1 %, min. 1 µm	1	15	44.7	28	10		M10x1
4484578	844 DR-HR	>60-80	0.2	-0.015 / -0.025	1 %, min. 1 µm	1	17.9	44.8	33	10		M10x1
4484579	844 DR-HR	>80-100	0.2	-0.015 / -0.025	1 %, min. 1 µm	1	17.9	44.8	33	10		M10x1
4484580	844 DR-HR	>100-110	0.2	-0.015 / -0.025	1 %, min. 1 µm	1	17.9	44.8	33	10		M10x1
4484581	844 DR-HR	>110-120	0.2	-0.015 / -0.025	1 %, min. 1 µm	1	17.9	44.8	33	10		M10x1
4484582	844 DR-HR	>120-130	0.2	-0.015 / -0.025	1 %, min. 1 µm	1	17.9	44.8	33	10		M10x1
4484583	844 DR-HR	>130-140	0.2	-0.025 / -0.035	1 %, min. 1 µm	1	17.9	44.8	33	10		M10x1
4484584	844 DR-HR	>140-150	0.2	-0.025 / -0.035	1 %, min. 1 µm	1	17.9	44.8	33	10		M10x1
4484585	844 DR-HR	>150-160	0.2	-0.025 / -0.035	1 %, min. 1 µm	1	17.9	44.8	33	10		M10x1
4484586	844 DR-HR	>160-170	0.2	-0.025 / -0.035	1 %, min. 1 µm	1	17.9	45	40	10		M10x1
4484587	844 DR-HR	>170-180	0.2	-0.025 / -0.035	1 %, min. 1 µm	1	17.9	45	40	10		M10x1
4484588	844 DR-HR	>180-190	0.2	-0.025 / -0.035	1 %, min. 1 µm	1	17.9	45	40	10		M10x1
4484589	844 DR-HR	>190-200	0.2	-0.025 / -0.035	1 %, min. 1 µm	1	17.9	45	40	10		M10x1

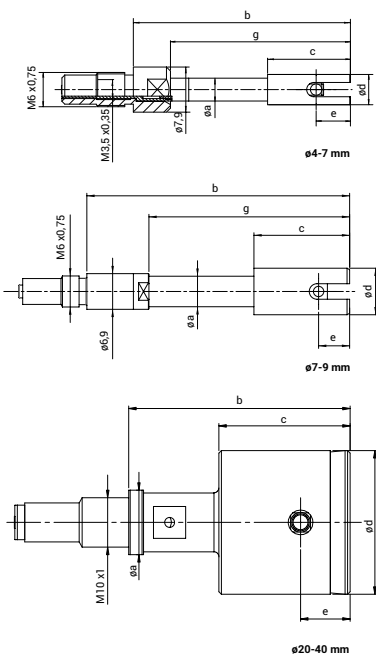

Marameter 844 DS-HR

Indicating plug gage

FEATURES

- Measuring probe made of hardened, stainless guide cylinder and carbide tipped probes
- Carbide driving needle transfers radial measuring movement to the display unit
- Constant measuring force as a result of built-in spring, eliminating user influence
- Measuring head, measuring instrument holder, depth extensions, right angle attachments and depth stops form a comprehensive modular system

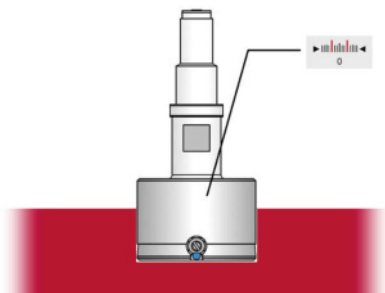

Application: Model for blind holes, for very tight tolerance fields less than 10 µm

- Manufacturing tolerance of the guide cylinder reduced to 0.01 mm ($\pm 5 \mu\text{m}$) to reduce the axial and radial measuring influences
- For measurements close to the base of the hole
- For the rapid testing of diameter, roundness and conicity of bores
- Ideal for testing batches with very tight tolerance fields less than 10 µm
- Rocking in the bore is not required to determine diameter
- Ideal for use in conjunction with digital display units and for subsequent processing of measured values

TECHNICAL DATA

Order no.	Type	Measuring range	Measuring span	Manufacturing tolerance	Linearity deviation	Repeatability f_w	a	b	c	e	g	Connection thread
4484598	844 DS-HR	3–4	0.2	-0.005 / -0.015	1.5 %, min. 1 µm	1		33	23.5	1	23.5	M6 x 0.75 / M3.5x0.35
4484599	844 DS-HR	>4–7	0.2	-0.005 / -0.015	1.5 %, min. 1 µm	1	4	33	9.5	1	26.5	M6 x 0.75 / M3.5x0.35
4484600	844 DS-HR	>7–9	0.2	-0.005 / -0.015	1.5 %, min. 1 µm	1	6.9	45.5	13.5	1	33.5	M6 x 0.75
4484601	844 DS-HR	>9–12	0.2	-0.005 / -0.015	1.5 %, min. 1 µm	1	7.9	45.5	13.5	1	45.5	M6 x 0.75
4484602	844 DS-HR	>12–13	0.2	-0.005 / -0.015	1.5 %, min. 1 µm	1	7.9	45.5	13.5	1	45.5	M6 x 0.75
4484603	844 DS-HR	>13–16	0.2	-0.005 / -0.015	1.5 %, min. 1 µm	1	11.9	45.5	13.5	1	45.5	M6 x 0.75
4484604	844 DS-HR	>16–20	0.2	-0.005 / -0.015	1.5 %, min. 1 µm	1	15	35.8	13.5	1		M10x1
4484605	844 DS-HR	>20–30	0.2	-0.01 / -0.02	1.5 %, min. 1 µm	1	15	38.2	20	1.2		M10x1
4484606	844 DS-HR	>30–40	0.2	-0.01 / -0.02	1.5 %, min. 1 µm	1	15	38.2	20	1.2		M10x1
4484607	844 DS-HR	>40–60	0.2	-0.01 / -0.02	1.5 %, min. 1 µm	1	15	38.2	28	1.2		M10x1
4484608	844 DS-HR	>60–80	0.2	-0.015 / -0.025	1.5 %, min. 1 µm	1	17.9	39	33	1.2		M10x1
4484609	844 DS-HR	>80–100	0.2	-0.015 / -0.025	1.5 %, min. 1 µm	1	17.9	39	33	1.2		M10x1
4484610	844 DS-HR	>100–110	0.2	-0.015 / -0.025	1.5 %, min. 1 µm	1	17.9	39	33	1.2		M10x1
4484611	844 DS-HR	>110–120	0.2	-0.015 / -0.025	1.5 %, min. 1 µm	1	17.9	39	33	1.2		M10x1
4484612	844 DS-HR	>120–130	0.2	-0.015 / -0.025	1.5 %, min. 1 µm	1	17.9	39	33	1.2		M10x1
4484613	844 DS-HR	>130–140	0.2	-0.025 / -0.035	1.5 %, min. 1 µm	1	17.9	39	33	1.2		M10x1
4484614	844 DS-HR	>140–150	0.2	-0.025 / -0.035	1.5 %, min. 1 µm	1	17.9	39	33	1.2		M10x1
4484615	844 DS-HR	>150–160	0.2	-0.025 / -0.035	1.5 %, min. 1 µm	1	17.9	39	33	1.2		M10x1
4484616	844 DS-HR	>160–170	0.2	-0.025 / -0.035	1.5 %, min. 1 µm	1	17.9	38.6	40	1.2		M10x1
4484617	844 DS-HR	>170–180	0.2	-0.025 / -0.035	1.5 %, min. 1 µm	1	17.9	38.6	40	1.2		M10x1
4484618	844 DS-HR	>180–190	0.2	-0.025 / -0.035	1.5 %, min. 1 µm	1	17.9	38.6	40	1.2		M10x1
4484619	844 DS-HR	>190–200	0.2	-0.025 / -0.035	1.5 %, min. 1 µm	1	17.9	38.6	40	1.2		M10x1

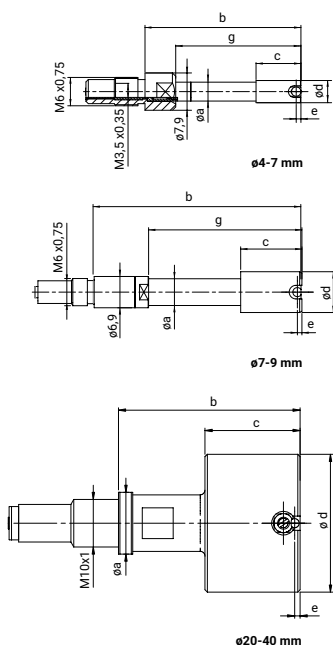

Marameter 844 DS-F

Indicating plug gage

FEATURES

- Measuring probe made of hardened, stainless guide cylinder and carbide tipped probes
- Carbide driving needle transfers radial measuring movement to the display unit
- Constant measuring force as a result of built-in spring, eliminating user influence
- Measuring head, measuring instrument holder, depth extensions, right angle attachments and depth stops form a comprehensive modular system

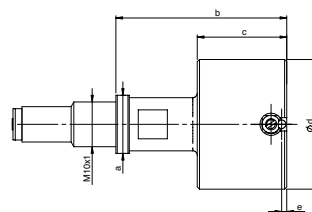
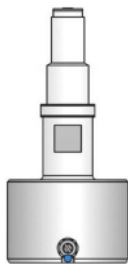

020-40mm

Application: Model for blind holes, with front chamfer

- For measuring very short bores
- For measurements close to the base of the hole
- For rapid testing of diameter, roundness and conicity of bores
- Especially suitable for testing batches with tight tolerance zones
- Rocking in the bore is not required to determine diameter
- Ideal for use in conjunction with digital display units and for subsequent processing of measured values

TECHNICAL DATA

Order no.	Type	Measuring range	Measuring span	Manufacturing tolerance	Linearity deviation	Repeatability f_w	a	b	c	e	g	Connection thread
		mm	mm	mm / mm		μm	mm	mm	mm	mm	mm	
4484627	844 DS-F	2–2,999	0.15	-0.015 / -0.025	1.5 %, min. 1 μm	1		20.7	14,2	0.7	14,2	M6 x 0.75 / M3.5x0.35
4484628	844 DS-F	3–4	0.2	-0.015 / -0.025	1.5 %, min. 1 μm	1		33	23.5	1	23.5	M6 x 0.75 / M3.5x0.35
4484629	844 DS-F	>4–7	0.2	-0.015 / -0.025	1.5 %, min. 1 μm	1	4	33	9.5	1	26.5	M6 x 0.75 / M3.5x0.35
4484630	844 DS-F	>7–9	0.2	-0.015 / -0.025	1.5 %, min. 1 μm	1	6.9	45.5	13.5	1	33.5	M6 x 0.75
4484631	844 DS-F	>9–12	0.2	-0.015 / -0.025	1.5 %, min. 1 μm	1	7.9	45.5	13.5	1	45.5	M6 x 0.75
4484632	844 DS-F	>12–13	0.2	-0.015 / -0.025	1.5 %, min. 1 μm	1	7.9	45.5	13.5	1	45.5	M6 x 0.75
4484633	844 DS-F	>13–16	0.2	-0.015 / -0.025	1.5 %, min. 1 μm	1	11.9	45.5	13.5	1	45.5	M6 x 0.75
4484634	844 DS-F	>16–20	0.2	-0.015 / -0.025	1.5 %, min. 1 μm	1	15	35.8	13.5	1		M10x1
4484635	844 DS-F	>20–30	0.2	-0.02 / -0.03	1.5 %, min. 1 μm	1	15	38.2	20	1.2		M10x1
4484636	844 DS-F	>30–40	0.2	-0.02 / -0.03	1.5 %, min. 1 μm	1	15	38.2	20	1.2		M10x1
4484637	844 DS-F	>40–60	0.2	-0.02 / -0.03	1.5 %, min. 1 μm	1	15	38.2	28	1.2		M10x1
4484638	844 DS-F	>60–80	0.2	-0.025 / -0.035	1.5 %, min. 1 μm	1	17.9	39	33	1.2		M10x1
4484639	844 DS-F	>80–100	0.2	-0.025 / -0.035	1.5 %, min. 1 μm	1	17.9	39	33	1.2		M10x1
4484640	844 DS-F	>100–110	0.2	-0.025 / -0.035	1.5 %, min. 1 μm	1	17.9	39	33	1.2		M10x1
4484641	844 DS-F	>110–120	0.2	-0.025 / -0.035	1.5 %, min. 1 μm	1	17.9	39	33	1.2		M10x1
4484642	844 DS-F	>120–130	0.2	-0.025 / -0.035	1.5 %, min. 1 μm	1	17.9	39	33	1.2		M10x1
4484643	844 DS-F	>130–140	0.2	-0.035 / -0.045	1.5 %, min. 1 μm	1	17.9	39	33	1.2		M10x1
4484644	844 DS-F	>140–150	0.2	-0.035 / -0.045	1.5 %, min. 1 μm	1	17.9	39	33	1.2		M10x1
4484645	844 DS-F	>150–160	0.2	-0.035 / -0.045	1.5 %, min. 1 μm	1	17.9	39	33	1.2		M10x1
4484646	844 DS-F	>160–170	0.2	-0.035 / -0.045	1.5 %, min. 1 μm	1	17.9	38.6	40	1.2		M10x1
4484647	844 DS-F	>170–180	0.2	-0.035 / -0.045	1.5 %, min. 1 μm	1	17.9	38.6	40	1.2		M10x1
4484648	844 DS-F	>180–190	0.2	-0.035 / -0.045	1.5 %, min. 1 μm	1	17.9	38.6	40	1.2		M10x1
4484649	844 DS-F	>190–200	0.2	-0.035 / -0.045	1.5 %, min. 1 μm	1	17.9	38.6	40	1.2		M10x1

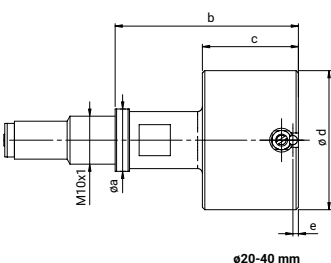
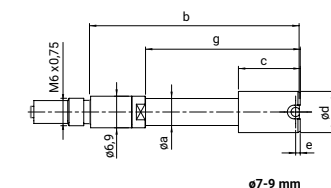
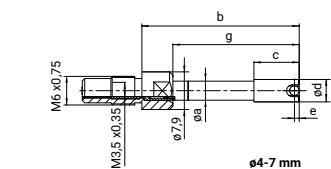

Marameter 844 DR-3

Indicating plug gage

FEATURES

- Measuring head has hard, stainless cylinder guide and carbide tipped anvils (spaced at $3 \times 120^\circ$)
- The carbide expanding pin transfers radial movement to indicating instrument
- Constant measuring force as a result of built-in spring, eliminating user influence
- Extensive modular system is composed of measuring head, holder, depth extension, right angle attachments and depth stops

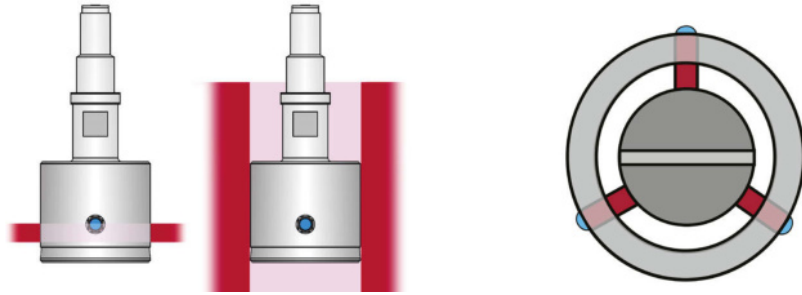

Application:

Model for through holes, with 3-point contact (gaging contacts spaced $3 \times 120^\circ$)

- For fast measurement of interrupted diameters and detection of form deviations in a polygon
- Especially suitable for testing batches with tight tolerance zones
- Rocking in the bore is not required to determine diameter
- Ideal for use in conjunction with digital display units and for subsequent processing of measured values

TECHNICAL DATA

Order no.	Type	Measuring range	Measuring span	Manufacturing tolerance	Linearity deviation	Repeatability f_w	a	b	c	e	Connection thread
		mm	mm	mm / mm		μm	mm	mm	mm	mm	
4484689	844 DR-3	4-7	0.2	-0.015 / -0.025	2 %, min. 1 μm	1	4	38	14.5	6	M6 x 0.75 / M3.5x0.35
4484690	844 DR-3	>7-9	0.2	-0.015 / -0.025	2 %, min. 1 μm	1	6.9	50.5	18.5	6	M6 x 0.75
4484691	844 DR-3	>9-12	0.2	-0.015 / -0.025	2 %, min. 1 μm	1	7.9	54.5	22.5	10	M6 x 0.75
4484692	844 DR-3	>12-13	0.2	-0.015 / -0.025	2 %, min. 1 μm	1	7.9	54.5	22.5	10	M6 x 0.75
4484693	844 DR-3	>13-16	0.2	-0.015 / -0.025	2 %, min. 1 μm	1	11.9	54.5	22.5	10	M6 x 0.75
4484694	844 DR-3	>16-20	0.2	-0.015 / -0.025	2 %, min. 1 μm	1	15	44.6	22.5	10	M10x1
4484695	844 DR-3	>20-30	0.2	-0.02 / -0.03	2 %, min. 1 μm	1	15	44.7	27	10	M10x1
4484696	844 DR-3	>30-40	0.2	-0.02 / -0.03	2 %, min. 1 μm	1	15	44.7	27	10	M10x1
4484697	844 DR-3	>40-60	0.2	-0.02 / -0.03	2 %, min. 1 μm	1	15	44.7	28	10	M10x1
4484698	844 DR-3	>60-80	0.2	-0.025 / -0.035	2 %, min. 1 μm	1	17.9	44.8	33	10	M10x1
4484699	844 DR-3	>80-100	0.2	-0.025 / -0.035	2 %, min. 1 μm	1	17.9	44.8	33	10	M10x1

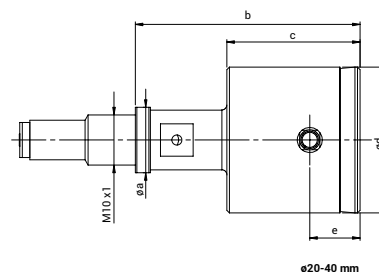
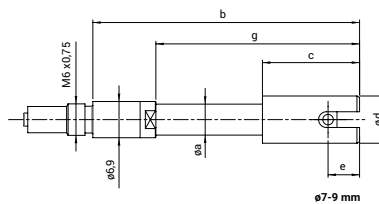
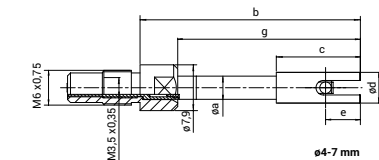

Marameter 844 Dgk / 844 Dga / 844 Dg / 844 Dg-XL / 844 Dgk-Z / 844 Dg-Z

Holder for plug gage

FEATURES

- The measuring instrument holder comprises a handle with a transfer rod, other properties:
 - Holder for upper cylinder shaft \varnothing 8 mm, for display unit e.g. dial comparator or digital dial indicator
 - Lower connecting thread to hold a bore plug gage 844 D / 844 DR / 844 DS



Applications:

- Type 844 Dga:** Special model with clearance button, useful e.g. for sensitive workpieces for inserting a bore plug gage into blind hole model 844 DS more easily. Recommended for small and sensitive holes.
- Type 844 Dg-XL:** Heavy duty and stable design for large bore plug gages (possible from \varnothing 60 mm), especially when using measuring depth extensions 844 Dv (\varnothing 18 mm) for large measuring depths.

TECHNICAL DATA

Order no.	Type	Connection thread	Lifting lever
4484750	844 Dgk	M10 x 1	
4484751	844 Dga	M10 x 1	•
4484752	844 Dg	M6 x 0.75	
4484753	844 Dg	M10 x 1	
4484754	844 Dg	M6 x 0.75	
4484755	844 Dg	M10 x 1	
4484756	844 Dg-XL	M10 x 1	
4484757	844 Dg-XL	M10 x 1	
4484758	844 Dgk-Z	M10 x 1	
4484759	844 Dg-Z	M10 x 1	

Order no.	Connection thread	Dimension L	d1	d2	l
		mm	mm	mm	mm
4484750	M10 x 1	59	11.9	18	11
4484751	M10 x 1	83	11.9	18	36
4484752	M6 x 0.75	109	11.9	18	30
4484753	M10 x 1	109	11.9	18	40
4484754	M6 x 0.75	239	11.9	18	137
4484755	M10 x 1	249	11.9	18	147
4484756	M10 x 1	154	17.9	26	38
4484757	M10 x 1	244	17.9	26	128
4484758	M10 x 1	59	11.9	18	11
4484759	M10 x 1	109	11.9	18	30

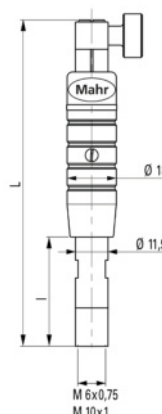

ACCESSORIES

Order no.	Description	Type
4334000	Millimess 1 μ m, \pm 50 μ m	1003
4334102	Millimess 0.5 μ m, \pm 25 μ m	1002
4337620	Digital indicator, 0.0005 mm, 12.5 mm	1086 R
4337624	Digital indicator, 0.0005 mm, 12.5 mm	1086 Ri
4337697	Digital indicator, 0.0001 mm, 12.5 mm	1086 R-HR



1003



1086 R-HR;1086 R;1086 ZR

Marameter 844 Dge

Plug gage holder for inductive probe

FEATURES

- The plug gage holders for inductive probes consist of a handle with cable protection on top
- Fixture (in the handle) for an inductive probe $\varnothing 8$ mm e.g. P2004-M for connection to an amplifier e.g. C1200-M
- Integrated fine adjustment for best probe setting
- Connection thread at the bottom to mount a bore gage 844 D / 844 DR / 844 DS



Applications:

- Special plug gage holders for precise measurements with inductive probes
- Mounting element in the holder for inductive probes with cylindrical shaft $\varnothing 8$ mm
- Cable socket with bend protection
- Fine adjustment attachment for the inductive probe
- Connection thread at the bottom for mounting a plug gage 844 D / 844 DR / 844 DS

TECHNICAL DATA

Order no.	Type	Dimension L	l	Connection thread
4484760	844 Dge	mm	mm	M6 x 0.75
4484761	844 Dge	146	26	M6 x 0.75
		156	36	M10x1

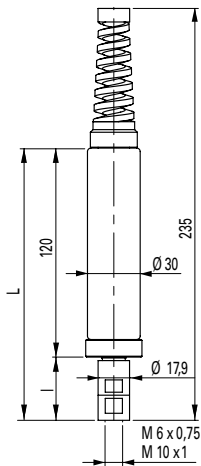

ACCESSORIES

Order no.	Description	Type
5312012	Compact amplifier	C 1200 M
5323010	Inductive probe, ± 2 mm	P2004 M



P2004 M



C 1200 M

Marameter 844 Dv

Extension for measuring depth

FEATURES

- The 844 Dv depth extension is screwed in between holder 844 Dg and plug gage 844 D / 844 DR / 844 DS (if necessary right angle attachment 844 Dw)



Applications:

- For bore measurement at larger depths
- Practical additional function as clamping shank for depth measuring stops 844 Dt

TECHNICAL DATA

Order no.	Type	Dimension L	d1	d2	Connection thread
		mm	mm	mm	
4484770	844 Dv	49	4	7.9	M6 x 0.75 / M3.5x0.35
4484771	844 Dv	99	4	7.9	M6 x 0.75 / M3.5x0.35
4484772	844 Dv	149	4	7.9	M6 x 0.75 / M3.5x0.35
4484773	844 Dv	249	4	7.9	M6 x 0.75 / M3.5x0.35
4484774	844 Dv	50	6.5	7.9	M6 x 0.75
4484775	844 Dv	100	6.5	7.9	M6 x 0.75
4484776	844 Dv	150	6.5	7.9	M6 x 0.75
4484777	844 Dv	250	6.5	7.9	M6 x 0.75
4484778	844 Dv	500	6.5	7.9	M6 x 0.75
4484779	844 Dv	48	11.9	15	M10x1
4484780	844 Dv	98	11.9	15	M10x1
4484781	844 Dv	248	11.9	15	M10x1
4484782	844 Dv	498	11.9	15	M10x1
4484783	844 Dv	750	11.9	15	M10x1
4484784	844 Dv	1000	11.9	15	M10x1
4484785	844 Dv	100	17.9		M10x1
4484786	844 Dv	250	17.9		M10x1
4484787	844 Dv	500	17.9		M10x1
4484788	844 Dv	750	17.9		M10x1
4484789	844 Dv	1000	17.9		M10x1

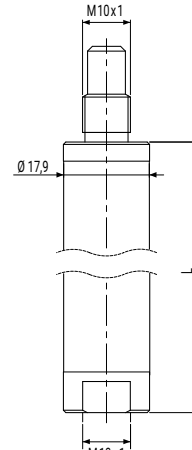
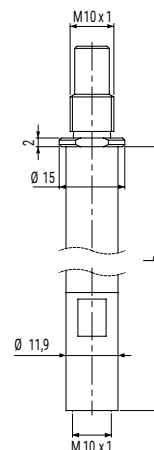
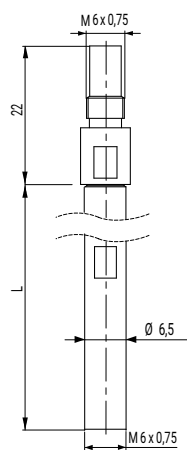
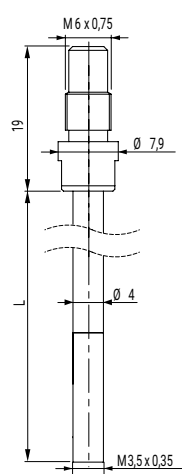

Marameter 844 Dw

Right angle attachment

FEATURES

- The 844 Dw right angle attachment is screwed in between holder 844 Dg and plug gage 844 D / 844 DR / 844 DS (if necessary extensions 844 Dv)

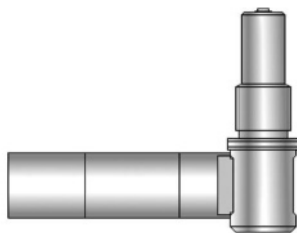

Applications:

- For space-saving and side entering measurement of bores. Typical measuring problem situations:
- Narrow conditions in turning and grinding machines
- Side outgoing bores or bearing points in housings

TECHNICAL DATA

Order no.	Type	Dimension L	d	Connection thread
		mm	mm	
4473409	844 Kw	29	7.9	M6 x 0.75
4484790	844 Dw	53	11.9	M10x1
4484791	844 Dw	56	17.9	M10x1

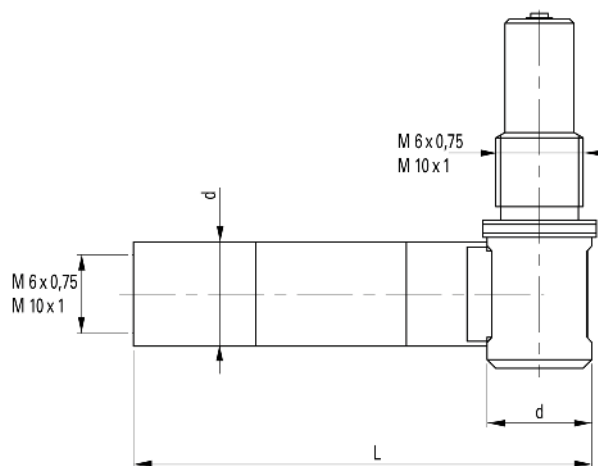

Marameter 844 Dt-R

Depth-stop ring

FEATURES

- For clamping direct on guide cylinder of plug gage 844 D / 844 DR / 844 DS

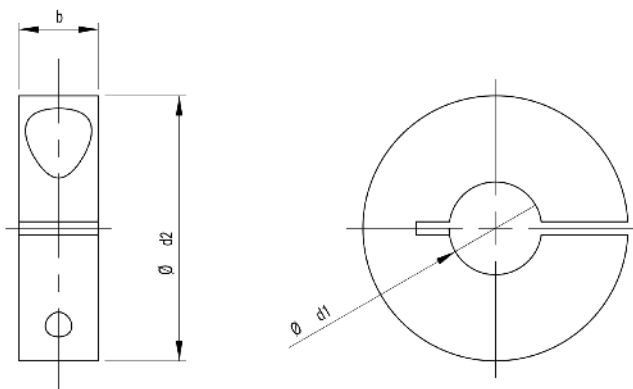

Application:

- For measuring at a defined and repeatable measuring depth and to eliminate a tilt error

TECHNICAL DATA

Order no.	Type	Application range
		mm
4484800	844 Dt-R	For plug gages Ø 3 –40 mm
4484801	844 Dt-R	For plug gages Ø >40 –60 mm
4484802	844 Dt-R	For plug gages Ø >60 –90 mm
4484803	844 Dt-R	For plug gages Ø >90 –105 mm

Order no.	Dimension d1 Comment	d1	d2	b
4484800	Adjusted according to the guide cylinder diameter of the plug gage	3–5 mm	12 mm	6 mm
		>5–9 mm	25 mm	10 mm
		>9–14 mm	32 mm	10 mm
		>14–18 mm	40 mm	12 mm
		>18–24 mm	45 mm	12 mm
		>24–28 mm	50 mm	12 mm
		>28–35 mm	56 mm	12 mm
	>35–40 mm	63 mm	12 mm	
4484801	Adjusted according to the guide cylinder diameter of the plug gage	>40–45 mm	70 mm	14 mm
		>45–55 mm	80 mm	14 mm
		>55–60 mm	90 mm	16 mm
4484802	Adjusted according to the guide cylinder diameter of the plug gage	>60–70 mm	100 mm	16 mm
		>70–90 mm	125 mm	20 mm
4484803	Adjusted according to the guide cylinder diameter of the plug gage	>90–105 mm	90–105 mm	25 mm

Marameter 844 Dt-S

Depth-stop disc

FEATURES

- Full round design
- For clamping on the shaft of the plug gage holder 844 Dg or measuring depth extension 844 Dv

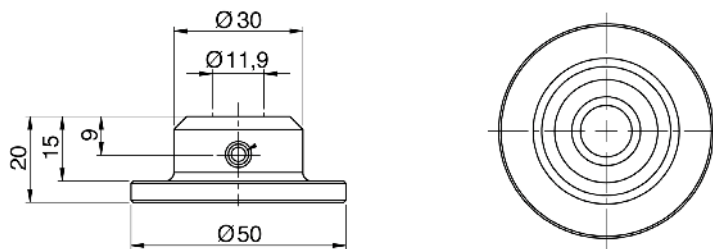

Application:

- For measuring at a defined and repeatable measuring depth and to eliminate a tilt error

TECHNICAL DATA

Order no.	Type	Application range	Mount diameter	Stop surfaces Ø A
4484820	844 Dt-S	mm For plug gages Ø 16 – 40 mm	mm Ø 11.9	mm Full round design, diameter 50 mm

Marameter 844 Dt-B

Depth-stop bridge

FEATURES

- For clamping on the shaft of the plug gage holder 844 Dg or measuring depth extension 844 Dv

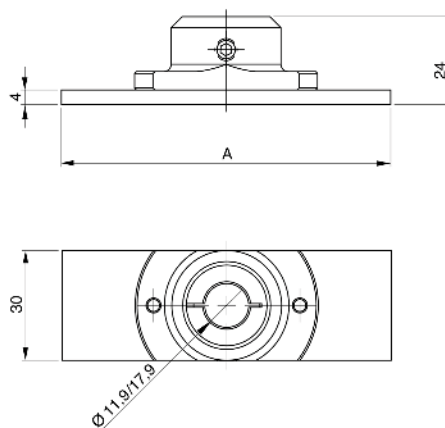

Application:

- For measuring at a defined and repeatable measuring depth and to eliminate a tilt error

TECHNICAL DATA

Order no.	Type	Application range	Mount diameter
		mm	mm
4484821	844 Dt-B	For plug gages \varnothing 16 –60 mm	\varnothing 11.9 mm or \varnothing 17.9 mm as specified, according to clamping shank \varnothing of holder 844 Dg/Dg-XL or measuring depth extension 844 Dv
4484822	844 Dt-B	For plug gages \varnothing >60 –80 mm	\varnothing 11.9 mm or \varnothing 17.9 mm as specified, according to clamping shank \varnothing of holder 844 Dg/Dg-XL or measuring depth extension 844 Dv
4484823	844 Dt-B	For plug gages \varnothing >80 –100 mm	\varnothing 11.9 mm or \varnothing 17.9 mm as specified, according to clamping shank \varnothing of holder 844 Dg/Dg-XL or measuring depth extension 844 Dv
4484824	844 Dt-B	For plug gages \varnothing >100 –160 mm	\varnothing 11.9 mm or \varnothing 17.9 mm as specified, according to clamping shank \varnothing of holder 844 Dg/Dg-XL or measuring depth extension 844 Dv

Order no.	Stop surfaces \varnothing A
	mm
4484821	Bore plug gage diameter + 10 mm
4484822	Bore plug gage diameter + 10 mm
4484823	Bore plug gage diameter + 10 mm
4484824	Bore plug gage diameter + 10 mm

Marameter 844 Dt-3

Depth stop with 3-point contacting

FEATURES

- For clamping on the shaft of the plug gage holder 844 Dg or measuring depth extension 844 Dv

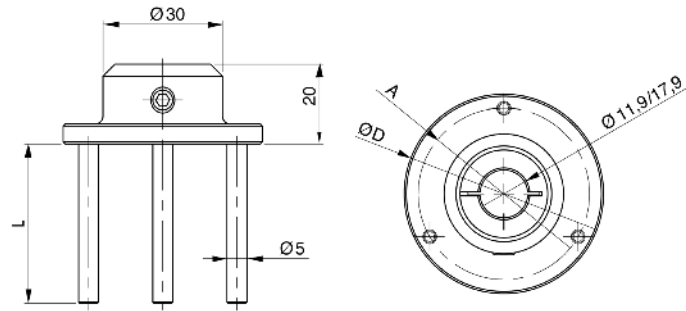

Application:

- For measuring at a defined and repeatable measuring depth and to eliminate a tilt error

TECHNICAL DATA

Order no.	Type	Application range	Mount diameter
		mm	mm
4484810	844 Dt-3	For plug gages Ø 20 –60 mm	Ø 11.9 mm or Ø 17.9 mm As specified, depending on clamping shank Ø of holder 844 Dg/Dg-XL or measuring depth extension 844 Dv
4484811	844 Dt-3	For plug gages Ø >60 –80 mm	Ø 11.9 mm or Ø 17.9 mm As specified, depending on clamping shank Ø of holder 844 Dg/Dg-XL or measuring depth extension 844 Dv
4484812	844 Dt-3	For plug gages Ø >80 –100 mm	Ø 11.9 mm or Ø 17.9 mm As specified, depending on clamping shank Ø of holder 844 Dg/Dg-XL or measuring depth extension 844 Dv
4484813	844 Dt-3	For plug gages Ø >100 –150 mm	Ø 11.9 mm or Ø 17.9 mm As specified, depending on clamping shank Ø of holder 844 Dg/Dg-XL or measuring depth extension 844 Dv

Order no.	ØD	L mm	Stop surfaces Ø A
			mm
4484810	Diameter plug gage + 14 mm	Individual adaptation/specification in case to plug gage	Diameter plug gage + 7 mm
4484811	Diameter plug gage + 14 mm	Individual adaptation/specification in case to plug gage	Diameter plug gage + 7 mm
4484812	Diameter plug gage + 14 mm	Individual adaptation/specification in case to plug gage	Diameter plug gage + 7 mm
4484813	Diameter plug gage + 14 mm	Individual adaptation/specification in case to plug gage	Diameter plug gage + 7 mm

Dimentron® plug gages

The Dimentron® system - built for performance



Dimentron® plug assembly — shown with *Maxµm*® III indicator, housing and handle

The Dimentron plug gage, which makes up the plug body, the panto-assembly, its contacts and transfer rod, is the measuring system comprising the Dimentron plug. It can be interchanged by simply unscrewing it from the display assembly.

The **plug body** is made of tough hardened 440 stainless steel, tempered and ground. Introduction into the bore is facilitated with 52-56 HRC hardness guide.

Standard **contacts** are made of tungsten carbide and based on the bore diameter range, come in two possible radii. Other contact materials are available based on the part being measured. Diamond, ruby or hard-chrome-covered contacts are also available. Diamond or ruby contacts are suggested for soft aluminum or highly wearing applications; hard chromed ones (1000 HV) for aluminum and relevant alloys. Also based on the thickness of the surface, cylindrical contact options are available.

Either 2 or 4 steel spring assemblies **form panto-spring assemblies**. The design of the transfer assembly is determined by the diameter of the plug. This panto-design produces true straight-line transfer to the V-rod.

A **transfer rod**, with spherical tungsten carbide tip, slides on a tempered steel V-shaped guide and inclined plane, transferring the measurement to the display device. This unique floating system has been designed and tested to resist for over 10,000,000 measuring cycles.

Though designed for the toughest shop conditions, wear items do occasionally need replacement. Because of the individual components, **service is fast and easy**. All parts are available separately from Mahr and with standard tools, can be replaced in minutes to help maintain up time on the floor.



Special depth gaging applications



Shown with bench stand 2239307 & plug holder 2248358

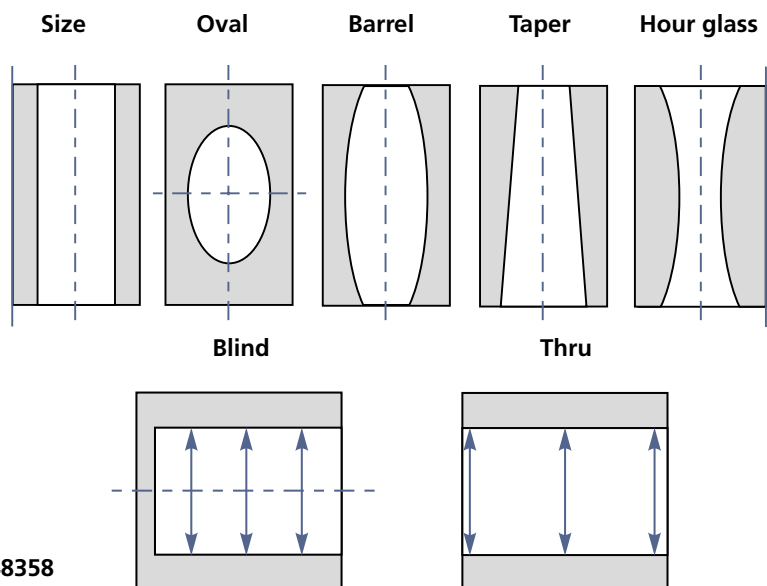

Dimention® plug inside diameter gages

The following table depicts available readouts for Dimention plug inside diameter gages. After making a plug selection, follow the chart for all the components needed to compose a gaging system suited to your application.

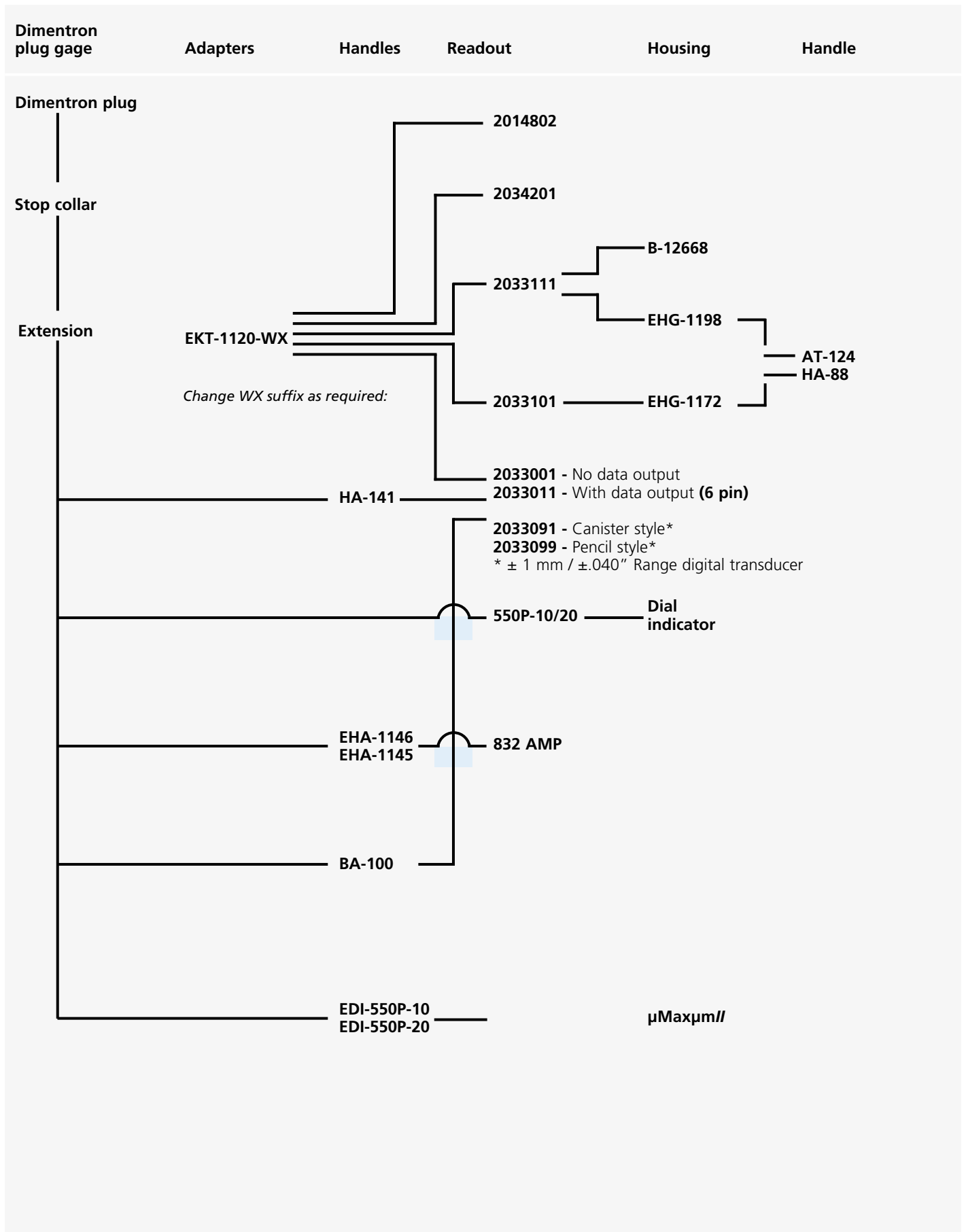

Marameter Dimentron

Indicating plug gage for through hole

FEATURES

- Designed for high production ID gaging
- High chrome content; hardened stainless steel bodies ground precisely for specified size measurement
- Plug tooling interchangeable for quick changeover
- Easy measurement - insert plug into diameter and read (no rocking needed)
- Set to nominal dimension with a single master ring
- Long life
 - Tungsten carbide contacts and V-rod ensure durable motion transfer
 - Open design is conducive to easy rinse cleaning
- Good for determining bore conditions for:
 - Taper
 - Barrel shape
 - Bell mouth
 - 2-point out-of-round
- Stop collars available for all standard sizes
- Captive V-rod design



TECHNICAL DATA

Order no.	Product type	Nominal size		Max. tolerance	Max. tolerance	Max. tolerance	Max. tolerance	Max. tolerance	Max. tolerance	Max. tolerance	Max. tolerance
		mm	inch	M01	050	M02	100	M05	200	M08	400
2057604	Dimentron	3.200 -5.500	.12500 -.21700	± 0.025	± .0010	± 0.038	± .0015				
2057605	Dimentron	5.001 -8.200	.21705 -.03220	± 0.025	± .0010	± 0.046	± .0018	± 0.076	± .0030		
2057606	Dimentron	8.201 -9.500	0.3225 -.37500	± 0.025	± .0010	± 0.046	± .0018	± 0.069	± .0027	± 0.102	± .0040
2057607	Dimentron	9.501 -12.700	.37505 -.50000	± 0.030	± .0012	± 0.051	± .0020	± 0.069	± .0027	± 0.127	± .0050
2057608	Dimentron	12.701 -19.050	.50005 -.75000	± 0.038	± .0015	± 0.058	± .0023	± 0.086	± .0034	± 0.137	± .0054
2057609	Dimentron	19.051 -25.000	.75005 -1.00000	± 0.038	± .0015	± 0.069	± .0027	± 0.102	± .0040	± 0.165	± .0065
2057610	Dimentron	25.001 -38.000	1.00005 -1.50000	± 0.038	± .0015	± 0.076	± .0030	± 0.127	± .0050	± 0.180	± .0071
2057611	Dimentron	38.001 -63.5	1.50000 - 2.50000			± 0.076	± .0030	± 0.152	± .0060	± 0.254	± .0100
2057612	Dimentron	63.5 -76.2	2.500 -3.000			± 0.076	± .0030	± 0.152	± .0060	± 0.254	± .0100
2057613	Dimentron	76.2 -88.9	3.000 -3.500			± 0.076	± .0030	± 0.152	± .0060	± 0.254	± .0100
2057614	Dimentron	88.9 -101.6	3.500 -4.000			± 0.076	± .0030	± 0.152	± .0060	± 0.254	± .0100
2057615	Dimentron	101.6 -114.3	4.000 -4.500			± 0.076	± .0030	± 0.152	± .0060	± 0.254	± .0100
2057616	Dimentron	114.3 -139.7	4.500 -5.500					± 0.152	± .0060	± 0.254	± .0100
2057617	Dimentron	139.7 -165.1	5.500 -6.500					± 0.152	± .0060	± 0.254	± .0100
2057618	Dimentron	165.1 -203.2	6.500 -8.000					± 0.152	± .0060	± 0.254	± .0100
2057619	Dimentron	203.2 -228.6	8.000 -9.000					± 0.152	± .0060	± 0.254	± .0100

Marameter Dimentron

Indicating plug gage for through hole

Order no.	Nominal size		A		B	
	mm	inch	mm	inch	mm	inch
2057604	3.200 – 5.500	.12500 – .21700	31.4	1.23	6.40	.25
2057605	5.001 – 8.200	.21705 – 0.3220	34.8	1.37	6.50	.256
2057606	8.201 – 9.500	0.3225 – .37500	34.8	1.37	6.50	.256
2057607	9.501 – 12.700	.37505 – .50000	35.4	1.39	13.00	.512
2057608	12.701 – 19.050	.50005 – .75000	35.4	1.39	13.00	.512
2057609	19.051 – 25.000	.75005 – 1.00000	48.3	1.90	16.00	.63
2057610	25.001 – 38.000	1.00005 – 1.50000	48.3	1.90	16.00	.63
2057611	38.000 – 63.000	1.50000 – 2.50000	46.7	1.84	19	.748
2057612– 2057615	63.000 – 114.300	2.50000 – 4.50000	46.7	1.84	19	.748
2057616– 2057619	114.300 – 228.300	4.50000 – 9.00000	46.7	1.84	9.5	.375

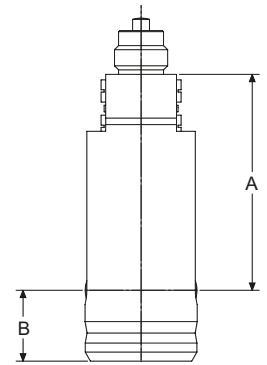

ACCESSORIES

Order no.	Product name	Type
4337620	Digital indicator, 0.0005 mm, 12.5 mm	1086 R
4337624	Digital indicator, 0.0005 mm, 12.5 mm	1086 Ri
4337660	Digital indicator, 0.0005 mm, 12.5 mm	1087 R
4337663	Digital indicator, 0.0005 mm, 12.5 mm	1087 Ri
2050829	Bore gage handle with indicator 221, grad. .0001"	550P-10
2050830	Bore gage handle with indicator P11, grad. 0.002 mm	550P-20
2203139	Adapter for handle HA-88	AT-124
2203140	Adapter for mounting Maxµm III with protective housing to bench stand BA-26	AT-125
2204032	Protective housing for Maxµm III with output	B-12668
2204599	Base with tooling plate, plug to be mounted vertically or horizontally	BA-100
2051697	Bore gage handle with digital indicator µMaxum II, res. 0.001mm / .00005"	EDI-550P-10
2051698	Bore gage handle with digital indicator µMaxum II, res. 0.0005mm / .00002"	EDI-550P-20
2213388	Handle assembly (inductive probe, HA-88 handle, AD-140 adapter) with 1.5m/5ft. straight cable	EHA-1145
2213389	Handle assembly (inductive probe, HA-88 handle, AD-140 adapter) with 3m/11ft. coiled cable	EHA-1146
2214119	Adapter set to mount Maxµm III indicator with 3/8" stem to a Dimentron plug	EKT-1120-W1
2214120	Adapter set to mount Maxµm III indicator with 8 mm stem to a Dimentron plug	EKT-1120-W2
2214121	Adapter set to mount dial indicators or µMaxum II with 3/8" stem to a Dimentron plug	EKT-1120-W3
2214122	Adapter set to mount dial indicators or µMaxum II with 8 mm stem to a Dimentron plug	EKT-1120-W4
2214124	Adapter set to mount dial comparators 1002 – 1010 with 8 mm stem to a Dimentron plug	EKT-1120-W6
2218595	Depth extension 50 mm / 1.97" for plug diameter 9.5 – 19.05 mm / .375 – .75"	EX-204
2218596	Depth extension 100 mm / 3.94" for plug diameter 9.5 – 19.05 mm / .375 – .75"	EX-205
2218597	Depth extension 200 mm / 7.87" for plug diameter 9.5 – 19.05 mm / .375 – .75"	EX-206
2218600	Depth extension 50 mm / 1.97" for plug diameter 19.05 mm / .75" and above	EX-210
2218601	Depth extension 100 mm / 3.94" for plug diameter 19.05 mm / .75" and above	EX-211
2218602	Depth extension 200 mm / 7.87" for plug diameter 19.05 mm / .75" and above	EX-212
2220037	Handle for Maxµm III digital transducers	HA-141
2220100	Handle to be mounted on protective housings EHG-1172 and EHG-1198 via adapter AT-124	HA-88
2033101	Inductive digital comparator, ±1 mm/± .040", no output	Maxµm III
2033111	Inductive digital comparator, ±1 mm/± .040", with output (6-pin)	Maxµm III
2033201	Inductive digital comparator, ± mm/± .040", with data output (6-pin), "0" at 6 o'clock position	Maxµm III



Maxµm III



1086 R; 1086 R-HR; 1086 ZR



1086 Ri



1087 R; 1087 R-HR; 1087 ZR



1087 Ri



EDI-550P-10



HA-141



BA-100

Marameter Dimentron

Indicating plug gage for through hole

FEATURES

- Designed for high production ID gaging
- High chrome content; hardened stainless steel bodies ground precisely for specified size measurement
- Plug tooling interchangeable for quick changeover
- Easy measurement - insert plug into diameter and read (no rocking needed)
- Set to nominal dimension with a single master ring
- Long life
 - Tungsten carbide contacts and V-rod ensure durable motion transfer
 - Open design is conducive to easy rinse cleaning
- Good for determining bore conditions for:
 - Taper
 - Barrel shape
 - Bell mouth
 - 2-point out-of-round
- Stop collars available for all standard sizes
- Captive V-rod design

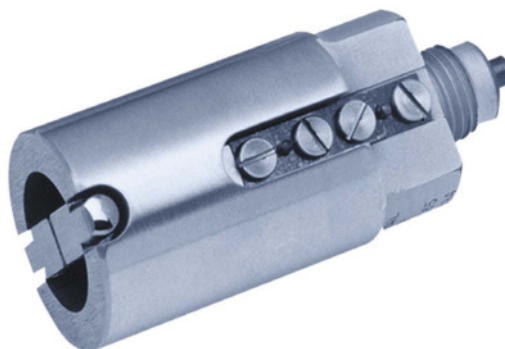

TECHNICAL DATA

Order no.	Product type	Nominal size	Nominal size	Max. tolerance	Max. tolerance	Max. tolerance	Max. tolerance	Max. tolerance	Max. tolerance	Max. tolerance	Max. tolerance
				M01	050	M02	100	M05	200	M08	400
		mm	inch	mm	inch	mm	inch	mm	inch	mm	inch
2057620	Dimentron	3.180	.12500	± 0.025	± .0010	± 0.038	± .0015	-	-	-	-
		-3.620	-.14260								
		3.621	.14265	± 0.025	± .0010	± 0.046	± .0018	± 0.076	± .0030	-	-
		-5.500	-.21700								
2057621	Dimentron	5.501	.21705	± 0.025	± .0010	± 0.046	± .0018	± 0.069	± .0027	± 0.102	± .0040
		-7.940	-.31250								
		7.941	.31255	± 0.030	± .0012	± 0.051	± .0020	± 0.069	± .0027	± 0.127	± .0050
		-8.200	-.32200								
2057622	Dimentron	8.201	.32205	± 0.030	± .0012	± 0.051	± .0020	± 0.069	± .0027	± 0.127	± .0050
		-9.500	-.37500								
2057623	Dimentron	9.501	.37505	± 0.038	± .0015	± 0.058	± .0023	± 0.086	± .0034	± 0.137	± .0054
		-12.700	-.50000								
2057624	Dimentron	12.701	.50005	± 0.038	± .0015	± 0.069	± .0027	± 0.102	± .0040	± 0.165	± .0065
		-19.050	-.75000								
2057625	Dimentron	19.051	.75005	± 0.038	± .0015	± 0.076	± .0030	± 0.127	± .0050	± 0.180	± .0071
		-25.400	-1.00000								
2057626	Dimentron	25.401	1.00005	± 0.038	± .0015	± 0.076	± .0030	± 0.152	± .0060	± 0.221	± .0087
		-38.000	-1.50000								
2057627	Dimentron	38.001	1.50000	-	-	± 0.076	± .0030	± 0.152	± .0060	± 0.254	± .0100
		- 63.5	2.50000								
2057628	Dimentron	63.5	2.500	-	-	± 0.076	± .0030	± 0.152	± .0060	± 0.254	± .0100
		-76.2	-3.000								
2057629	Dimentron	76.2	3.000	-	-	± 0.076	± .0030	± 0.152	± .0060	± 0.254	± .0100
		-88.9	-3.500								
2057630	Dimentron	88.9	3.500	-	-	± 0.076	± .0030	± 0.152	± .0060	± 0.254	± .0100
		-101.6	-4.000								
2057631	Dimentron	101.6	4.000	-	-	± 0.076	± .0030	± 0.152	± .0060	± 0.254	± .0100
		-114.3	-4.500								
2057632	Dimentron	114.3	4.500	-	-	-	-	± 0.152	± .0060	± 0.254	± .0100
		-139.7	-5.500								
2057633	Dimentron	139.7	5.500	-	-	-	-	± 0.152	± .0060	± 0.254	± .0100
		-165.1	-6.500								
2057634	Dimentron	165.1	6.500	-	-	-	-	± 0.152	± .0060	± 0.254	± .0100
		-203.2	-8.000								
2057635	Dimentron	203.2	8.000	-	-	-	-	± 0.152	± .0060	± 0.254	± .0100
		-228.6	-9.000								

Marameter Dimentron

Indicating plug gage for through hole

Order no.	Nominal size		A	Dimension A		B	Dimension B	
	mm	inch		mm	inch		mm	inch
2057620	3.180 – 5.500	.12500 – .21700	31.4	1.23	4	.157		
2057621	5.501 – 8.200	.21705 – 0.3220	34.8	1.37	4	.157		
2057622	8.201 – 9.500	0.3225 – .37500	34.8	1.37	4	.157		
2057623	9.501 – 12.700	.37505 – .50000	35.4	1.39	4	.157		
2057624	12.701 – 19.050	.50005 – .75000	35.4	1.39	4	.157		
2057625	19.051 – 25.400	.75005 – 1.00000	48.3	1.90	4	.157		
2057626	25.401 – 38.000	1.00005 – 1.50000	48.3	1.90	4	.157		
2057627	38.000 – 63.000	1.50000 – 2.50000	46.7	1.84	4	.157		
2057628– 2057635	63.000 – 114.300 114.300 – 228.300	2.50000 – 4.50000 4.50000 – 9.00000	46.7	1.84	4	.157		

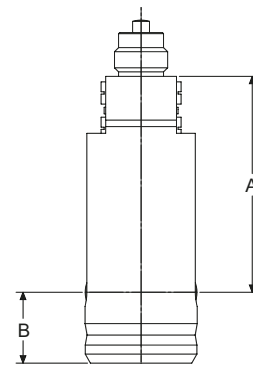

ACCESSORIES

Order no.	Product name	Type
4337620	Digital indicator, 0.0005 mm, 12.5 mm	1086 R
4337624	Digital indicator, 0.0005 mm, 12.5 mm	1086 Ri
4337660	Digital indicator, 0.0005 mm, 12.5 mm	1087 R
4337663	Digital indicator, 0.0005 mm, 12.5 mm	1087 Ri
2050829	Bore gage handle with indicator 221, grad. .0001"	550P-10
2050830	Bore gage handle with indicator P11, grad. 0.002 mm	550P-20
2203139	Adapter for handle HA-88	AT-124
2203140	Adapter for mounting Maxµm III with protective housing to bench stand BA-26	AT-125
2204032	Protective housing for Maxµm III with output	B-12668
2204599	Base with tooling plate, plug to be mounted vertically or horizontally	BA-100
2051697	Bore gage handle with digital indicator µMaxum II, res. 0.001mm / .00005"	EDI-550P-10
2051698	Bore gage handle with digital indicator µMaxum II, res. 0.0005mm / .00002"	EDI-550P-20
2213388	Handle assembly (inductive probe, HA-88 handle, AD-140 adapter) with 1.5m/5ft. straight cable	EHA-1145
2213389	Handle assembly (inductive probe, HA-88 handle, AD-140 adapter) with 3m/11ft. coiled cable	EHA-1146
2214119	Adapter set to mount Maxµm III indicator with 3/8" stem to a Dimentron plug	EKT-1120-W1
2214120	Adapter set to mount Maxµm III indicator with 8 mm stem to a Dimentron plug	EKT-1120-W2
2214121	Adapter set to mount dial indicators or µMaxum II with 3/8" stem to a Dimentron plug	EKT-1120-W3
2214122	Adapter set to mount dial indicators or µMaxum II with 8 mm stem to a Dimentron plug	EKT-1120-W4
2214124	Adapter set to mount dial comparators 1002 – 1010 with 8 mm stem to a Dimentron plug	EKT-1120-W6
2218595	Depth extension 50 mm / 1.97" for plug diameter 9.5 – 19.05 mm / .375 – .75"	EX-204
2218596	Depth extension 100 mm / 3.94" for plug diameter 9.5 – 19.05 mm / .375 – .75"	EX-205
2218597	Depth extension 200 mm / 7.87" for plug diameter 9.5 – 19.05 mm / .375 – .75"	EX-206
2218600	Depth extension 50 mm / 1.97" for plug diameter 19.05 mm / .75" and above	EX-210
2218601	Depth extension 100 mm / 3.94" for plug diameter 19.05 mm / .75" and above	EX-211
2218602	Depth extension 200 mm / 7.87" for plug diameter 19.05 mm / .75" and above	EX-212
2220037	Handle for Maxµm III digital transducers	HA-141
2220100	Handle to be mounted on protective housings EHG-1172 and EHG-1198 via adapter AT-124	HA-88
2033101	Inductive digital comparator, ±1 mm/± .040", no output	Maxµm III
2033111	Inductive digital comparator, ±1 mm/± .040", with output (6-pin)	Maxµm III
2033201	Inductive digital comparator, ± mm/± .040", with data output (6-pin), "0" at 6 o'clock position	Maxµm III



Maxµm III



1086 R; 1086 R-HR; 1086 ZR



1086 Ri



1087 R; 1087 R-HR; 1087 ZR



1087 Ri



EDI-550P-10



HA-141



BA-100

Marameter Dimentron

Indicating plug gage for through hole

FEATURES

- Designed for high production ID gaging
- High chrome content; hardened stainless steel bodies ground precisely for specified size measurement
- Plug tooling interchangeable for quick changeover
- Easy measurement - insert plug into diameter and read (no rocking needed)
- Set to nominal dimension with a single master ring
- Long life
 - Tungsten carbide contacts and V-rod ensure durable motion transfer
 - Open design is conducive to easy rinse cleaning
- Good for determining bore conditions for:
 - Taper
 - Barrel shape
 - Bell mouth
 - 2-point out-of-round
- Stop collars available for all standard sizes
- Captive V-rod design

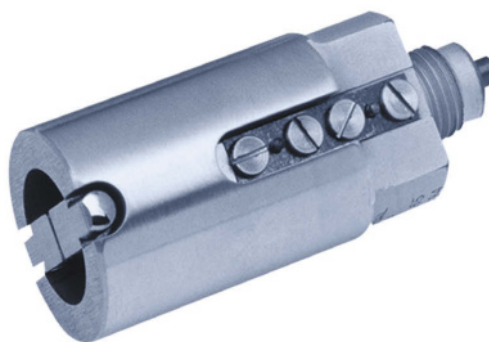

TECHNICAL DATA

Order no.	Product type	Nominal size	Nominal size	Max. tolerance	Max. tolerance	Max. tolerance	Max. tolerance	Max. tolerance	Max. tolerance	Max. tolerance	Max. tolerance	
				M01	050	M02	100	M05	200	M08	400	
		mm	inch	mm	inch	mm	inch	mm	inch	mm	inch	
2058545	Dimentron	5.501	.21705	± 0.025	± .0010	± 0.046	± .0018	± 0.069	± .0027	± 0.102	± .0040	
		-7.940	-.31250"									
		7.941	.31255	± 0.030	± .0012	± 0.051	± .0020	± 0.069	± .0027	± 0.127	± .0050	
2058546	Dimentron	-8.200	-.32200"									
		8.201	.32205	± 0.030	± .0012	± 0.051	± .0020	± 0.069	± .0027	± 0.127	± .0050	
2058547	Dimentron	-9.500	-.37500"									
		9.501	.37505	± 0.038	± .0015	± 0.058	± .0023	± 0.086	± .0034	± 0.137	± .0054	
2058548	Dimentron	-12.700	-.50000"									
		12.701	.50005	± 0.038	± .0015	± 0.069	± .0027	± 0.102	± .0040	± 0.165	± .0065	
2058549	Dimentron	-19.050	-.75000"									
		19.051	.75005	± 0.038	± .0015	± 0.076	± .0030	± 0.127	± .0050	± 0.180	± .0071	
2058550	Dimentron	-25.400	-1.00000"									
		25.401	1.00005	± 0.038	± .0015	± 0.076	± .0030	± 0.152	± .0060	± 0.221	± .0087	
2058551	Dimentron	-38.000	-1.50000"									
		38.001	1.50000	-	-	± 0.076	± .0030	± 0.152	± .0060	± 0.254	± .0100	
2058552	Dimentron	-63.5	-2.50000"									
		63.5	2.500	-	-	± 0.076	± .0030	± 0.152	± .0060	± 0.254	± .0100	
2058553	Dimentron	-76.2	-3.00000"									
		76.2	3.000	-	-	± 0.076	± .0030	± 0.152	± .0060	± 0.254	± .0100	
2058554	Dimentron	-88.9	-3.50000"									
		88.9	3.500	-	-	± 0.076	± .0030	± 0.152	± .0060	± 0.254	± .0100	
2058555	Dimentron	-101.6	-4.00000"									
		101.6	4.000	-	-	± 0.076	± .0030	± 0.152	± .0060	± 0.254	± .0100	
2058556	Dimentron	-114.3	-4.50000"									
		114.3	4.500	-	-	-	-	± 0.152	± .0060	± 0.254	± .0100	
2058557	Dimentron	-139.7	-5.50000"									
		139.7	5.500	-	-	-	-	± 0.152	± .0060	± 0.254	± .0100	
2058558	Dimentron	-165.1	-6.50000"									
		165.1	6.500	-	-	-	-	± 0.152	± .0060	± 0.254	± .0100	
2058559	Dimentron	-203.2	-8.00000"									
		203.2	8.000	-	-	-	-	± 0.152	± .0060	± 0.254	± .0100	
		-228.6	-9.00000"									

Marameter Dimentron

Indicating plug gage for through hole

Order no.	Nominal size		A	Dimension A		B	Dimension B	
	mm	inch		mm	inch		mm	inch
2058545	5.501 – 8.200	.21705 – 0.3220	34.8	1.37	2	.08		
	8.201 – 9.500	0.3225 – .37500						
2058546	9.501 – 12.700	.37505 – .50000	35.4	1.39	2	.08		
2058547	12.701 – 19.050	.50005 – .75000	35.4	1.39	2	.08		
2058548	19.051 – 25.400	.75005 – 1.00000	48.3	1.90	2	.08		
2058549	25.401 – 38.000	1.00005 – 1.50000	48.3	1.90	2	.08		
2058550	38.000 – 63.000	1.50000 – 2.50000	46.7	1.84	2	.08		
2058551– 2058555	63.000 – 114.300	2.50000 – 4.50000	46.7	1.84	2	.08		
2058556– 2058559	114.300 – 228.300	4.50000 – 9.00000	46.7	1.84	2	.08		

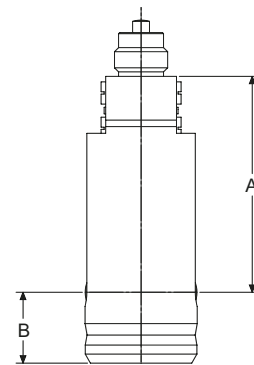

ACCESSORIES

Order no.	Product name	Type
4337620	Digital indicator, 0.0005 mm, 12.5 mm	1086 R
4337624	Digital indicator, 0.0005 mm, 12.5 mm	1086 Ri
4337660	Digital indicator, 0.0005 mm, 12.5 mm	1087 R
4337663	Digital indicator, 0.0005 mm, 12.5 mm	1087 Ri
2050829	Bore gage handle with indicator 221, grad. .0001"	550P-10
2050830	Bore gage handle with indicator P11, grad. 0.002 mm	550P-20
2203139	Adapter for handle HA-88	AT-124
2203140	Adapter for mounting Maxµm III with protective housing to bench stand BA-26	AT-125
2204032	Protective housing for Maxµm III with output	B-12668
2204599	Base with tooling plate, plug to be mounted vertically or horizontally	BA-100
2051697	Bore gage handle with digital indicator µMaxum II, res. 0.001mm / .00005"	EDI-550P-10
2051698	Bore gage handle with digital indicator µMaxum II, res. 0.0005mm / .00002"	EDI-550P-20
2213388	Handle assembly (inductive probe, HA-88 handle, AD-140 adapter) with 1.5m/5ft. straight cable	EHA-1145
2213389	Handle assembly (inductive probe, HA-88 handle, AD-140 adapter) with 3m/11ft. coiled cable	EHA-1146
2214119	Adapter set to mount Maxµm III indicator with 3/8" stem to a Dimentron plug	EKT-1120-W1
2214120	Adapter set to mount Maxµm III indicator with 8 mm stem to a Dimentron plug	EKT-1120-W2
2214121	Adapter set to mount dial indicators or µMaxum II with 3/8" stem to a Dimentron plug	EKT-1120-W3
2214122	Adapter set to mount dial indicators or µMaxum II with 8 mm stem to a Dimentron plug	EKT-1120-W4
2214124	Adapter set to mount dial comparators 1002 – 1010 with 8 mm stem to a Dimentron plug	EKT-1120-W6
2218595	Depth extension 50 mm / 1.97" for plug diameter 9.5 – 19.05 mm / .375 – .75"	EX-204
2218596	Depth extension 100 mm / 3.94" for plug diameter 9.5 – 19.05 mm / .375 – .75"	EX-205
2218597	Depth extension 200 mm / 7.87" for plug diameter 9.5 – 19.05 mm / .375 – .75"	EX-206
2218600	Depth extension 50 mm / 1.97" for plug diameter 19.05 mm / .75" and above	EX-210
2218601	Depth extension 100 mm / 3.94" for plug diameter 19.05 mm / .75" and above	EX-211
2218602	Depth extension 200 mm / 7.87" for plug diameter 19.05 mm / .75" and above	EX-212
2220037	Handle for Maxµm III digital transducers	HA-141
2220100	Handle to be mounted on protective housings EHG-1172 and EHG-1198 via adapter AT-124	HA-88
2033101	Inductive digital comparator, ±1 mm/± .040", no output	Maxµm III
2033111	Inductive digital comparator, ±1 mm/± .040", with output (6-pin)	Maxµm III
2033201	Inductive digital comparator, ± mm/± .040", with data output (6-pin), "0" at 6 o'clock position	Maxµm III



Maxµm III



1086 R; 1086 R-HR; 1086 ZR



1086 Ri



1087 R; 1087 R-HR; 1087 ZR



1087 Ri



EDI-550P-10



HA-141



BA-100

Marameter Dimentron

Indicating plug gage for through hole

FEATURES

- Designed for high production ID gaging
- High chrome content; hardened stainless steel bodies ground precisely for specified size measurement
- Plug tooling interchangeable for quick changeover
- Easy measurement - insert plug into diameter and read (no rocking needed)
- Set to nominal dimension with a single master ring
- Long life
 - Tungsten carbide contacts and V-rod ensure durable motion transfer
 - Open design is conducive to easy rinse cleaning
- Good for determining bore conditions for:
 - Taper
 - Barrel shape
 - Bell mouth
 - 2-point out-of-round
- Stop collars available for all standard sizes
- Captive V-rod design



TECHNICAL DATA

Order no.	Product type	Nominal size		Max. toleran-	Max. toleran-	Max. toleran-	Max. toleran-	Max. toleran-	Max. toleran-	Max. toleran-	Max. toleran-
		mm	inch	ce M01	ce 050	ce M02	ce 100	ce M05	ce 200	ce M08	ce 400
2058560	Dimentron	5.501	.21705	± 0.025	± .0010	± 0.046	± .0018	± 0.069	± .0027	± 0.102	± .0040
		-7.940	-.31250"								
		7.941	.31255	± 0.030	± .0012	± 0.051	± .0020	± 0.069	± .0027	± 0.127	± .0050
2058561	Dimentron	-8.200	-.32200"								
		8.201	.32205	± 0.030	± .0012	± 0.051	± .0020	± 0.069	± .0027	± 0.127	± .0050
2058562	Dimentron	-9.500	-.37500"								
		9.501	.37505	± 0.038	± .0015	± 0.058	± .0023	± 0.086	± .0034	± 0.137	± .0054
2058563	Dimentron	-12.700	-.50000"								
		12.701	.50005	± 0.038	± .0015	± 0.069	± .0027	± 0.102	± .0040	± 0.165	± .0065
2058564	Dimentron	-19.050	-.75000"								
		19.051	.75005	± 0.038	± .0015	± 0.076	± .0030	± 0.127	± .0050	± 0.180	± .0071
2058565	Dimentron	-25.400	-1.00000"								
		25.401	1.00005	± 0.038	± .0015	± 0.076	± .0030	± 0.152	± .0060	± 0.221	± .0087
2058566	Dimentron	-38.000	-1.50000"								
		38.001	1.50000 -	-	-	± 0.076	± .0030	± 0.152	± .0060	± 0.254	± .0100
2058567	Dimentron	-63.5	-2.50000"								
		63.5-76.2	2.500-3.000"	-	-	± 0.076	± .0030	± 0.152	± .0060	± 0.254	± .0100
2058568	Dimentron	-76.2	-3.00000"								
		76.2-88.9	3.000-3.500"	-	-	± 0.076	± .0030	± 0.152	± .0060	± 0.254	± .0100
2058569	Dimentron	-88.9	-3.50000"								
		88.9-101.6	3.500-4.000"	-	-	± 0.076	± .0030	± 0.152	± .0060	± 0.254	± .0100
2058570	Dimentron	-114.3	-4.50000"								
		101.6-114.3	4.000-4.500"	-	-	± 0.076	± .0030	± 0.152	± .0060	± 0.254	± .0100

Marameter Dimentron

Indicating plug gage for through hole

Order no.	Nominal size		A	Dimension A		B	Dimension B	
	mm	inch		mm	inch		mm	inch
2058560	5.501 – 8.200	.21705 – 0.3220	34.8	1.37	0.79	.031		
	8.201 – 9.500	0.3225 – .37500	34.8	1.37	0.79	.031		
2058561	9.501 – 12.700	.37505 – .50000	35.4	1.39	0.79	.031		
2058562	12.701 – 19.050	.50005 – .75000	35.4	1.39	0.79	.031		
2058563	19.051 – 25.400	.75005 – 1.00000	48.3	1.90	0.79	.031		
2058564	25.401 – 38.000	1.00005 – 1.50000	48.3	1.90	0.79	.031		
2058565	38.000 – 63.000	1.50000 – 2.50000	46.7	1.84	0.79	.031		
2058566– 2058570	63.000 – 114.300	2.50000 – 4.50000	46.7	1.84	0.79	.031		

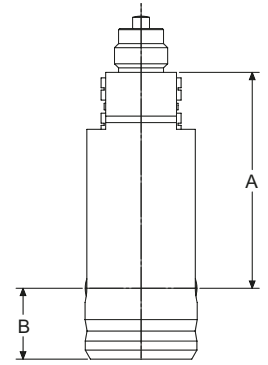

ACCESSORIES

Order no.	Product name	Type
4337620	Digital indicator, 0.0005 mm, 12.5 mm	1086 R
4337624	Digital indicator, 0.0005 mm, 12.5 mm	1086 Ri
4337660	Digital indicator, 0.0005 mm, 12.5 mm	1087 R
4337663	Digital indicator, 0.0005 mm, 12.5 mm	1087 Ri
2050829	Bore gage handle with indicator 221, grad. .0001"	550P-10
2050830	Bore gage handle with indicator P11, grad. 0.002 mm	550P-20
2203139	Adapter for handle HA-88	AT-124
2203140	Adapter for mounting Maxµm III with protective housing to bench stand BA-26	AT-125
2204032	Protective housing for Maxµm III with output	B-12668
2204599	Base with tooling plate, plug to be mounted vertically or horizontally	BA-100
2051697	Bore gage handle with digital indicator µMaxum II, res. 0.001mm / .00005"	EDI-550P-10
2051698	Bore gage handle with digital indicator µMaxum II, res. 0.0005mm / .00002"	EDI-550P-20
2213388	Handle assembly (inductive probe, HA-88 handle, AD-140 adapter) with 1.5m/5ft. straight cable	EHA-1145
2213389	Handle assembly (inductive probe, HA-88 handle, AD-140 adapter) with 3m/11ft. coiled cable	EHA-1146
2214119	Adapter set to mount Maxµm III indicator with 3/8" stem to a Dimentron plug	EKT-1120-W1
2214120	Adapter set to mount Maxµm III indicator with 8 mm stem to a Dimentron plug	EKT-1120-W2
2214121	Adapter set to mount dial indicators or µMaxum II with 3/8" stem to a Dimentron plug	EKT-1120-W3
2214122	Adapter set to mount dial indicators or µMaxum II with 8 mm stem to a Dimentron plug	EKT-1120-W4
2214124	Adapter set to mount dial comparators 1002 – 1010 with 8 mm stem to a Dimentron plug	EKT-1120-W6
2218595	Depth extension 50 mm / 1.97" for plug diameter 9.5 – 19.05 mm / .375 – .75"	EX-204
2218596	Depth extension 100 mm / 3.94" for plug diameter 9.5 – 19.05 mm / .375 – .75"	EX-205
2218597	Depth extension 200 mm / 7.87" for plug diameter 9.5 – 19.05 mm / .375 – .75"	EX-206
2218600	Depth extension 50 mm / 1.97" for plug diameter 19.05 mm / .75" and above	EX-210
2218601	Depth extension 100 mm / 3.94" for plug diameter 19.05 mm / .75" and above	EX-211
2218602	Depth extension 200 mm / 7.87" for plug diameter 19.05 mm / .75" and above	EX-212
2220037	Handle for Maxµm III digital transducers	HA-141
2220100	Handle to be mounted on protective housings EHG-1172 and EHG-1198 via adapter AT-124	HA-88
2033101	Inductive digital comparator, ±1 mm/± .040", no output	Maxµm III
2033111	Inductive digital comparator, ±1 mm/± .040", with output (6-pin)	Maxµm III
2033201	Inductive digital comparator, ± mm/± .040", with data output (6-pin), "0" at 6 o'clock position	Maxµm III



Maxµm III



1086 R; 1086 R-HR; 1086 ZR



1086 Ri



1087 R; 1087 R-HR; 1087 ZR



1087 Ri



EDI-550P-10



HA-141



BA-100

Marameter | Self-centering inner measuring device 844 K

High-precision comparative measurements of holes

Inside measuring probes from the 844 K family are 2-point comparative measuring instruments used to determine a reversal point in a bore by oscillation. This reversal point equates to the minimum and thus the exact bore diameter.

Measuring process

The measuring value is displayed with analog dial comparators or electronic dial indicators.

Practical tip

An electronic dial indicator such as type 1087 BR or 1087 BRi, offers the major advantage of being able to automatically record the reversal point using the MIN function and display an absolute measuring value on the screen due to the PRESET setting. In addition, you can conveniently and reliably transfer the measuring data to a PC or a CAQ system by data cable or Integrated Wireless technology.

Setting the comparative measuring instrument

Setting rings are used to set the instrument to the respective nominal size.

Typical applications of self-centering inside measuring probes

- Rapid testing of hole diameters

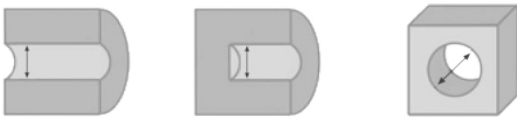

- Determining roundness and cylindricity deviations by rotating and moving to other bore depths



Special advantages

Setting rings are used to set the instrument to the respective nominal size.

- Self-centering in the hole
- Fast determination of reversal point by oscillation
- Measuring value displayed immediately
- Ideal for processing measuring values directly especially when used with digital indicating instruments

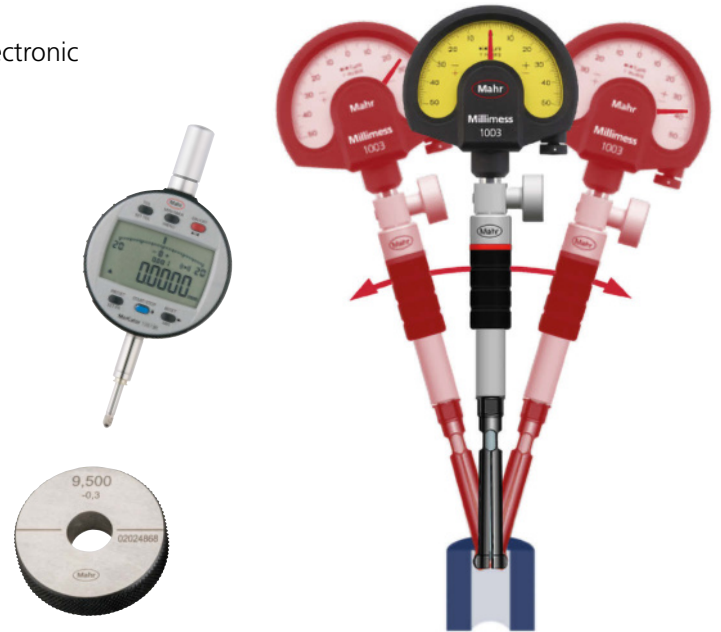

Measuring process

The reversal point (minimum value) is calculated by rocking in a bore.



Marameter | Self-centering inner measuring device 844 K

Inside measuring probe models (split-ball probe)

844 K standard for common hole shapes

- Split-ball probe made of hardened steel
- Hard chrome-plated measuring surfaces

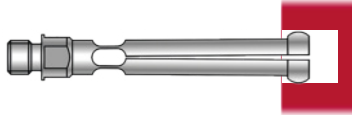

844 KC for common hole shapes with DLC coating

- Split-ball probe made of hardened steel
- Measuring surfaces and inner edges coated with DLC (hard diamond-like coating)
- Enhanced wear protection and very low friction coefficients, therefore ideal for measurements on sensitive or abrasive surfaces
- For common hole shapes



844 KS split-ball probe for bore measurements close to the bottom of the hole

- Split-ball probe made of hardened steel
- Hard chrome plated measuring surfaces

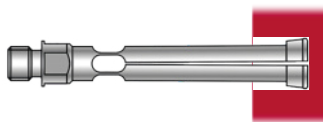

Advantages of DLC coating

- **DLC coating** (diamond-like carbon)
- Extremely hard coating for **very high wear resistance**
- **Extremely low friction coefficient, thus preventing** e.g.
 - Streaking on precision-machined non-ferrous metal surfaces
 - Increased wear on abrasive materials
- DLC coating over entire measuring surfaces including inner contact point of driving needle, for **very high long-term accuracy (linearity)**
- **Visual wear display:** Visible light spot once coating is worn
- **Excellent corrosion prevention**

Ideal equipment for long-term accuracy

Driving needles are inserted in the probe to transfer the measuring movement of the probe head to the indicating instrument. To ensure maximum service life and thus high linearity over a long period of time, Mahr drive needles are generally made of solid carbide.



Modular system

When combined with extensive accessories (indicating instruments, inside measuring probes with driving needle, holders, extensions and right angle attachments), inside measuring probes become precision measuring instruments customized to the measuring task.

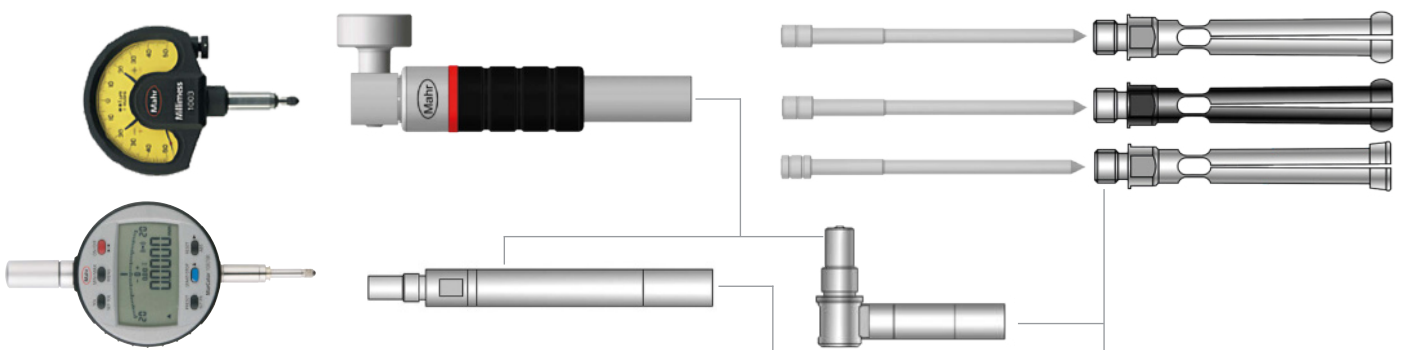

Marameter 844 KC

Self-centering dial bore gage

FEATURES

- Measuring head made in hardened steel, DLC coated
- Constant measuring force as a result of built-in spring, eliminating user influence
- Extensive modular system is composed of measuring head, transfer needle, holder, depth extension, right angle attachments and setting rings



Application: Standard model with DLC-coated surface

- For indicating measurement of diameter and testing for roundness and conicity of bores
- Especially suitable for testing batches
- Determine the reversal point by rocking in the bore



• Benefits of DLC Coating

- DLC = Diamond-Like Carbon
- Extremely high wear resistance, for long service life even on hard or abrasive surfaces
- Reduction of friction, ideal for sensitive surfaces such as non-ferrous metals and aluminium alloys
- Wear indicator, worn areas appear as bright spots in the dark DLC coating

The minimum set of a measuring instrument consists of:

- Measuring head, transfer needle and holder plus indicator unit
- **Package contains:**
Measuring holder 844 Kg, probe, expanding pin, wooden case, excludes indicator

TECHNICAL DATA

Order no.	Type	Nominal size	Individual probe measuring range	Measuring range	Number of measuring probes	Linearity deviation f_e	Repeatability f_w
		mm	mm	mm	Piece		μm
4473105	844 KC	1.00	0.95 – 1.15	0.95 – 1.55	5	2 %, min. 1 μm	1
		1.10	1.07 – 1.25				
		1.20	1.17 – 1.35				
		1.30	1.27 – 1.45				
		1.40	1.37 – 1.55				
4473106	844 KC	1.75	1.50 – 1.90	1.5 – 3.95	9	1 %, min. 1 μm	1
		2.00	1.80 – 2.20				
		2.25	2.05 – 2.45				
		2.50	2.30 – 2.70				
		2.75	2.55 – 2.95				
		3.00	2.80 – 3.20				
		3.25	3.05 – 3.45				
		3.50	3.30 – 3.70				
		3.75	3.55 – 3.95				
4473107	844 KC	4.00	3.70 – 4.30	3.7 – 9.8	12	1 %, min. 1 μm	1
		4.50	4.20 – 4.80				
		5.00	4.70 – 5.30				
		5.50	5.20 – 5.80				
		6.00	5.70 – 6.30				
		6.50	6.20 – 6.80				
		7.00	6.70 – 7.30				
		7.50	7.20 – 7.80				
		8.00	7.70 – 8.30				
		8.50	8.20 – 8.80				
		9.00	8.70 – 9.30				
		9.50	9.20 – 9.80				
		4473108	844 KC				
2.00	1.80 – 2.20						
2.25	2.05 – 2.45						
2.50	2.30 – 2.70						
2.75	2.55 – 2.95						
3.00	2.80 – 3.20						
3.25	3.05 – 3.45						
3.50	3.30 – 3.70						
3.75	3.55 – 3.95						
4.00	3.70 – 4.30						
4.50	4.20 – 4.80						
5.00	4.70 – 5.30						
5.50	5.20 – 5.80						
6.00	5.70 – 6.30						
6.50	6.20 – 6.80						
7.00	6.70 – 7.30						
7.50	7.20 – 7.80						
8.00	7.70 – 8.30						
8.50	8.20 – 8.80						
9.00	8.70 – 9.30						
9.50	9.20 – 9.80						
4473109	844 KC	10.00	9.40 – 10.60	9.4 – 20.6	11	1 %, min. 1 μm	1
		11.00	10.40 – 11.60				
		12.00	11.40 – 12.60				
		13.00	12.40 – 13.60				
		14.00	13.40 – 14.60				
		15.00	14.40 – 15.60				
		16.00	15.40 – 16.60				
		17.00	16.40 – 17.60				
		18.00	17.40 – 18.60				
		19.00	18.40 – 19.60				
		20.00	19.40 – 20.60				

Marameter 844 KC

Self-centering dial bore gage

TECHNICAL DATA

Order no.	Nominal size	Individual probe measuring range	H1	L	Measuring depth
	mm	mm	mm	mm	mm
4473105	1.00	0.95 – 1.15	0.6	19.50	10.5
	1.10	1.07 – 1.25	0.6	19.50	10.5
	1.20	1.17 – 1.35	0.6	19.50	10.5
	1.30	1.27 – 1.45	0.6	19.50	10.5
	1.40	1.37 – 1.55	0.6	19.50	10.5
4473106	1.75	1.50 – 1.90	0.9	25.30	16
	2.00	1.80 – 2.20	0.9	25.30	16
	2.25	2.05 – 2.45	0.9	25.30	16
	2.50	2.30 – 2.70	1.2	30.60	21
	2.75	2.55 – 2.95	1.2	30.60	21
	3.00	2.80 – 3.20	1.2	30.60	21
	3.25	3.05 – 3.45	1.2	30.60	21
	3.50	3.30 – 3.70	1.2	30.60	21
	3.75	3.55 – 3.95	1.2	30.60	21
4473107	4.00	3.70 – 4.30	2.0	47.30	38
	4.50	4.20 – 4.80	2.0	47.30	38
	5.00	4.70 – 5.30	2.0	47.30	38
	5.50	5.20 – 5.80	2.0	47.30	38
	6.00	5.70 – 6.30	2.0	47.30	38
	6.50	6.20 – 6.80	2.0	47.30	38
	7.00	6.70 – 7.30	2.0	47.30	38
	7.50	7.20 – 7.80	2.0	47.30	38
	8.00	7.70 – 8.30	2.0	47.30	38
	8.50	8.20 – 8.80	2.0	47.30	38
	9.00	8.70 – 9.30	2.0	47.30	38
	9.50	9.20 – 9.80	2.0	47.30	38
4473108	1.75	1.50 – 1.90	0.9	25.30	16
	2.00	1.80 – 2.20	0.9	25.30	16
	2.25	2.05 – 2.45	0.9	25.30	16
	2.50	2.30 – 2.70	1.2	30.60	21
	2.75	2.55 – 2.95	1.2	30.60	21
	3.00	2.80 – 3.20	1.2	30.60	21
	3.25	3.05 – 3.45	1.2	30.60	21
	3.50	3.30 – 3.70	1.2	30.60	21
	3.75	3.55 – 3.95	1.2	30.60	21
	4.00	3.70 – 4.30	2.0	47.30	38
	4.50	4.20 – 4.80	2.0	47.30	38
	5.00	4.70 – 5.30	2.0	47.30	38
	5.50	5.20 – 5.80	2.0	47.30	38
	6.00	5.70 – 6.30	2.0	47.30	38
	6.50	6.20 – 6.80	2.0	47.30	38
	7.00	6.70 – 7.30	2.0	47.30	38
	7.50	7.20 – 7.80	2.0	47.30	38
8.00	7.70 – 8.30	2.0	47.30	38	
8.50	8.20 – 8.80	2.0	47.30	38	
9.00	8.70 – 9.30	2.0	47.30	38	
9.50	9.20 – 9.80	2.0	47.30	38	
4473109	10.00	9.40 – 10.60	3.3	48.50	45
	11.00	10.40 – 11.60	3.3	48.50	45
	12.00	11.40 – 12.60	3.3	48.50	45
	13.00	12.40 – 13.60	3.3	48.50	45
	14.00	13.40 – 14.60	3.3	48.50	45
	15.00	14.40 – 15.60	3.3	48.50	45
	16.00	15.40 – 16.60	3.3	48.50	45
	17.00	16.40 – 17.60	3.3	48.50	45
	18.00	17.40 – 18.60	3.3	48.50	45
	19.00	18.40 – 19.60	3.3	48.50	45
	20.00	19.40 – 20.60	3.3	48.50	45

Marameter 844 KC

Self-centering dial bore gage

ACCESSORIES

Order no.	Connection thread	Description	Type
4335000		Millimess 0.5 μm , $\pm 25 \mu\text{m}$	1002
4334000		Millimess 1 μm , $\pm 50 \mu\text{m}$	1003
4333000		Millimess 5 μm , $\pm 130 \mu\text{m}$	1004
4337662		Digital indicator, 0.0005 mm, 12.5 mm	1087 BR
4337664		Digital indicator, 0.0005 mm, 12.5 mm	1087 BRi
4473375		Setting rings in set for measuring range 1 –1.4 mm	844 Ke
4473376		Setting rings in set for measuring range 1.75 –3.75 mm	844 Ke
4473377		Setting rings in set for measuring range 4 –9.5 mm	844 Ke
4473378		Setting rings in set for measuring range 1.75 –9.5 mm	844 Ke
4473379		Setting rings in set for measuring range 10 –20 mm	844 Ke
4473400	M6 x 0.75	Holder for indicator, $\varnothing 8 \text{ mm}$ / M6 x 0.75	844 Kg
4473401	M6 x 0.75	Holder for indicator, $\varnothing 8 \text{ mm}$ / M6 x 0.75	844 Kga
4473402	M6 x 0.75	Holder for indicator, $\varnothing .375''$ / M6 x 0.75	844 Kgz
4473405	M6 x 0.75	Extension for measuring depth, length 50 mm	844 Kv
4473406	M6 x 0.75	Extension for measuring depth, length 100 mm	844 Kv
4473407	M6 x 0.75	Extension for measuring depth, length 250 mm	844 Kv
4473409	M6 x 0.75	Right angle attachment, M6 x 0.75	844 Kw



1004



1003



1002



1087 BR

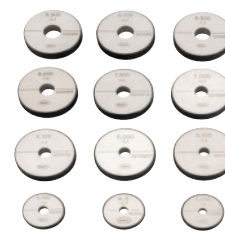

844 Ke



844 Kg;844 Kgz



844 Kga



844 Kv

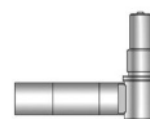

844 Dw;844 Kw

Marameter 844 K

Self-centering dial bore gage

FEATURES

- Measuring head made of hardened steel, hard chrome plated
- Constant measuring force as a result of built-in spring, eliminating user influence
- Extensive modular system is composed of measuring head, transfer needle, holder, depth extension, right angle attachments and setting rings



Application: Standard model

- For indicating measurement of diameter and testing for roundness and conicity of bores
- Especially suitable for testing batches
- Determine the reversal point by rocking in the bore

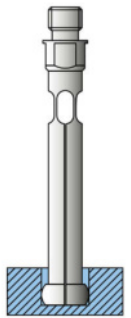

The minimum set of a measuring instrument consists of:

- Measuring head, transfer needle and holder plus indicator unit
- **Package contains:** Measuring holder 844 Kg, probe, expanding pin, wooden case, excludes indicator

TECHNICAL DATA

Order no.	Type	Nominal size mm	Individual probe measuring range mm	Measuring range mm	Number of measuring probes Piece	Linearity deviation f_e	Repeatability f_w μm
4473005	844 K	1.00	0.95 - 1.15	0.95 - 1.55	5	2 %, min. 1 μm	1
		1.10	1.07 - 1.25				
		1.20	1.17 - 1.35				
		1.30	1.27 - 1.45				
		1.40	1.37 - 1.55				
4473006	844 K	1.75	1.50 - 1.90	1.5 - 3.95	9	1 %, min. 1 μm	1
		2.00	1.80 - 2.20				
		2.25	2.05 - 2.45				
		2.50	2.30 - 2.70				
		2.75	2.55 - 2.95				
		3.00	2.80 - 3.20				
		3.25	3.05 - 3.45				
		3.50	3.30 - 3.70				
		3.75	3.55 - 3.95				
4473007	844 K	4.00	3.70 - 4.30	3.7 - 9.8	12	1 %, min. 1 μm	1
		4.50	4.20 - 4.80				
		5.00	4.70 - 5.30				
		5.50	5.20 - 5.80				
		6.00	5.70 - 6.30				
		6.50	6.20 - 6.80				
		7.00	6.70 - 7.30				
		7.50	7.20 - 7.80				
		8.00	7.70 - 8.30				
		8.50	8.20 - 8.80				
		9.00	8.70 - 9.30				
9.50	9.20 - 9.80						
4473008	844 K	1.75	1.50 - 1.90	1.5 - 9.8	21	1 %, min. 1 μm	1
		2.00	1.80 - 2.20				
		2.25	2.05 - 2.45				
		2.50	2.30 - 2.70				
		2.75	2.55 - 2.95				
		3.00	2.80 - 3.20				
		3.25	3.05 - 3.45				
		3.50	3.30 - 3.70				
		3.75	3.55 - 3.95				
		4.00	3.70 - 4.30				
		4.50	4.20 - 4.80				
		5.00	4.70 - 5.30				
		5.50	5.20 - 5.80				
		6.00	5.70 - 6.30				
		6.50	6.20 - 6.80				
7.00	6.70 - 7.30						
7.50	7.20 - 7.80						
8.00	7.70 - 8.30						
8.50	8.20 - 8.80						
9.00	8.70 - 9.30						
9.50	9.20 - 9.80						
4473009	844 K	10.00	9.40 - 10.60	9.4 - 20.6	11	1 %, min. 1 μm	1
		11.00	10.40 - 11.60				
		12.00	11.40 - 12.60				
		13.00	12.40 - 13.60				
		14.00	13.40 - 14.60				
		15.00	14.40 - 15.60				
		16.00	15.40 - 16.60				
		17.00	16.40 - 17.60				
		18.00	17.40 - 18.60				
		19.00	18.40 - 19.60				
		20.00	19.40 - 20.60				

Marameter 844 K

Self-centering dial bore gage

TECHNICAL DATA

Order no.	Nominal size	Individual probe measuring range	H1	L	Measuring depth
	mm	mm	mm	mm	mm
4473005	1.00	0.95 – 1.15	0.6	19.50	10.5
	1.10	1.07 – 1.25	0.6	19.50	10.5
	1.20	1.17 – 1.35	0.6	19.50	10.5
	1.30	1.27 – 1.45	0.6	19.50	10.5
	1.40	1.37 – 1.55	0.6	19.50	10.5
4473006	1.75	1.50 – 1.90	0.9	25.30	16
	2.00	1.80 – 2.20	0.9	25.30	16
	2.25	2.05 – 2.45	0.9	25.30	16
	2.50	2.30 – 2.70	1.2	30.60	21
	2.75	2.55 – 2.95	1.2	30.60	21
	3.00	2.80 – 3.20	1.2	30.60	21
	3.25	3.05 – 3.45	1.2	30.60	21
	3.50	3.30 – 3.70	1.2	30.60	21
	3.75	3.55 – 3.95	1.2	30.60	21
4473007	4.00	3.70 – 4.30	2.0	47.30	38
	4.50	4.20 – 4.80	2.0	47.30	38
	5.00	4.70 – 5.30	2.0	47.30	38
	5.50	5.20 – 5.80	2.0	47.30	38
	6.00	5.70 – 6.30	2.0	47.30	38
	6.50	6.20 – 6.80	2.0	47.30	38
	7.00	6.70 – 7.30	2.0	47.30	38
	7.50	7.20 – 7.80	2.0	47.30	38
	8.00	7.70 – 8.30	2.0	47.30	38
	8.50	8.20 – 8.80	2.0	47.30	38
	9.00	8.70 – 9.30	2.0	47.30	38
4473008	1.75	1.50 – 1.90	0.9	25.30	16
	2.00	1.80 – 2.20	0.9	25.30	16
	2.25	2.05 – 2.45	0.9	25.30	16
	2.50	2.30 – 2.70	1.2	30.60	21
	2.75	2.55 – 2.95	1.2	30.60	21
	3.00	2.80 – 3.20	1.2	30.60	21
	3.25	3.05 – 3.45	1.2	30.60	21
	3.50	3.30 – 3.70	1.2	30.60	21
	3.75	3.55 – 3.95	1.2	30.60	21
	4.00	3.70 – 4.30	2.0	47.30	38
	4.50	4.20 – 4.80	2.0	47.30	38
	5.00	4.70 – 5.30	2.0	47.30	38
	5.50	5.20 – 5.80	2.0	47.30	38
	6.00	5.70 – 6.30	2.0	47.30	38
	6.50	6.20 – 6.80	2.0	47.30	38
7.00	6.70 – 7.30	2.0	47.30	38	
7.50	7.20 – 7.80	2.0	47.30	38	
8.00	7.70 – 8.30	2.0	47.30	38	
8.50	8.20 – 8.80	2.0	47.30	38	
9.00	8.70 – 9.30	2.0	47.30	38	
9.50	9.20 – 9.80	2.0	47.30	38	
4473009	10.00	9.40 – 10.60	3.3	48.50	45
	11.00	10.40 – 11.60	3.3	48.50	45
	12.00	11.40 – 12.60	3.3	48.50	45
	13.00	12.40 – 13.60	3.3	48.50	45
	14.00	13.40 – 14.60	3.3	48.50	45
	15.00	14.40 – 15.60	3.3	48.50	45
	16.00	15.40 – 16.60	3.3	48.50	45
	17.00	16.40 – 17.60	3.3	48.50	45
	18.00	17.40 – 18.60	3.3	48.50	45
	19.00	18.40 – 19.60	3.3	48.50	45
	20.00	19.40 – 20.60	3.3	48.50	45

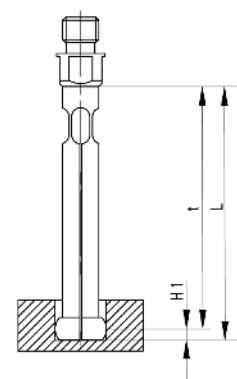

Marameter 844 K

Self-centering dial bore gage

ACCESSORIES

Order no.	Connection thread	Description	Type
4335000		Millimess 0.5 μm , $\pm 25 \mu\text{m}$	1002
4334000		Millimess 1 μm , $\pm 50 \mu\text{m}$	1003
4333000		Millimess 5 μm , $\pm 130 \mu\text{m}$	1004
4337662		Digital indicator, 0.0005 mm, 12.5 mm	1087 BR
4337664		Digital indicator, 0.0005 mm, 12.5 mm	1087 BRi
4473375		Setting rings in set for measuring range 1 –1.4 mm	844 Ke
4473376		Setting rings in set for measuring range 1.75 –3.75 mm	844 Ke
4473377		Setting rings in set for measuring range 4 –9.5 mm	844 Ke
4473378		Setting rings in set for measuring range 1.75 –9.5 mm	844 Ke
4473379		Setting rings in set for measuring range 10 –20 mm	844 Ke
4473400	M6 x 0.75	Holder for indicator, $\varnothing 8 \text{ mm}$ / M6 x 0.75	844 Kg
4473401	M6 x 0.75	Holder for indicator, $\varnothing 8 \text{ mm}$ / M6 x 0.75	844 Kga
4473402	M6 x 0.75	Holder for indicator, $\varnothing .375''$ / M6 x 0.75	844 Kgz
4473405	M6 x 0.75	Extension for measuring depth, length 50 mm	844 Kv
4473406	M6 x 0.75	8Extension for measuring depth, length 100 mm	844 Kv
4473407	M6 x 0.75	Extension for measuring depth, length 250 mm	844 Kv
4473409	M6 x 0.75	Right angle attachment, M6 x 0.75	844 Kw



1004



1003



1002



1087 BR



844 Ke



844 Kg;844 Kgz



844 Kga



844 Kv

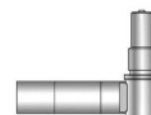

844 Dw;844 Kw

Marameter 844 KS

Self-centering dial bore gage

FEATURES

- Measuring head made of hardened steel, hard chrome plated
- Constant measuring force as a result of built-in spring, eliminating user influence
- Extensive modular system is composed of measuring head, transfer needle, holder, depth extension, right angle attachments and setting rings

The minimum set of a measuring instrument consists of:

- Measuring head, transfer needle and holder plus indicator unit
- **Package contains:** Measuring holder 844 Kg, probe, expanding pin, wooden case, excludes indicator

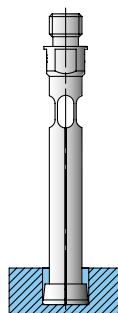

Application: Model for blind holes

- For measurements near to the bottom of bores
- For indicating measurement of diameter and testing for roundness and conicity of bores
- Especially suitable for testing batches
- Determine the reversal point by rocking in the bore

TECHNICAL DATA

Order no.	Type	Nominal size mm	Individual probe measuring range mm	Measuring range mm	Number of mea- suring probes Piece	Linearity deviation f_e	Repeatability f_w μm
4473207	844 KS	4.00	3.70 - 4.30	3.7 - 9.8	12	1 %, min. 1 μm	1
		4.50	4.20 - 4.80				
		5.00	4.70 - 5.30				
		5.50	5.20 - 5.80				
		6.00	5.70 - 6.30				
		6.50	6.20 - 6.80				
		7.00	6.70 - 7.30				
		7.50	7.20 - 7.80				
		8.00	7.70 - 8.30				
		8.50	8.20 - 8.80				
		9.00	8.70 - 9.30				
		9.50	9.20 - 9.80				
4473209	844 KS	10.00	9.40 - 10.60	9.4 - 9.8	11	1 %, min. 1 μm	1
		11.00	10.40 - 11.60				
		12.00	11.40 - 12.60				
		13.00	12.40 - 13.60				
		14.00	13.40 - 14.60				
		15.00	14.40 - 15.60				
		16.00	15.40 - 16.60				
		17.00	16.40 - 17.60				
		18.00	17.40 - 18.60				
		19.00	18.40 - 19.60				
		20.00	19.40 - 20.60				

Order no.	Nominal size mm	Individual probe measuring range mm	H1 mm	L mm	Measuring depth mm
4473207	4.00	3.70 - 4.30	0.5	47.30	38
	4.50	4.20 - 4.80	0.5	47.30	38
	5.00	4.70 - 5.30	0.5	47.30	38
	5.50	5.20 - 5.80	0.5	47.30	38
	6.00	5.70 - 6.30	0.5	47.30	38
	6.50	6.20 - 6.80	0.5	47.30	38
	7.00	6.70 - 7.30	0.5	47.30	38
	7.50	7.20 - 7.80	0.5	47.30	38
	8.00	7.70 - 8.30	0.5	47.30	38
	8.50	8.20 - 8.80	1.0	48.50	45
	9.00	8.70 - 9.30	1.0	48.50	45
	9.50	9.20 - 9.80	1.0	48.50	45
4473209	10.00	9.40 - 10.60	1.0	48.50	45
	11.00	10.40 - 11.60	1.0	48.50	45
	12.00	11.40 - 12.60	1.0	48.50	45
	13.00	12.40 - 13.60	1.0	48.50	45
	14.00	13.40 - 14.60	1.0	48.50	45
	15.00	14.40 - 15.60	1.0	48.50	45
	16.00	15.40 - 16.60	1.0	48.50	45
	17.00	16.40 - 17.60	1.0	48.50	45
	18.00	17.40 - 18.60	1.0	48.50	45
	19.00	18.40 - 19.60	1.0	48.50	45
	20.00	19.40 - 20.60	1.0	48.50	45

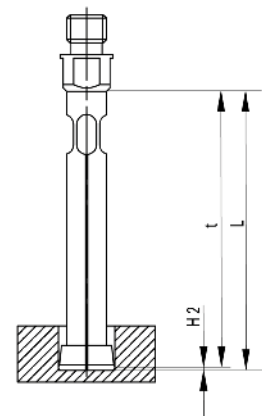

Marameter 844 KS

Self-centering dial bore gage

ACCESSORIES

Order no.	Connection thread	Description	Type
4335000		Millimess 0.5 μm , $\pm 25 \mu\text{m}$	1002
4334000		Millimess 1 μm , $\pm 50 \mu\text{m}$	1003
4333000		Millimess 5 μm , $\pm 130 \mu\text{m}$	1004
4337662		Digital indicator, 0.0005 mm, 12.5 mm	1087 BR
4337664		Digital indicator, 0.0005 mm, 12.5 mm	1087 BRi
4473377		Setting rings in set for measuring range 4 –9.5 mm	844 Ke
4473379		Setting rings in set for measuring range 10 –20 mm	844 Ke
4473400	M6 x 0.75	Holder for indicator, $\varnothing 8 \text{ mm}$ / M6 x 0.75	844 Kg
4473401	M6 x 0.75	Holder for indicator, $\varnothing 8 \text{ mm}$ / M6 x 0.75	844 Kga
4473402	M6 x 0.75	Holder for indicator, $\varnothing .375''$ / M6 x 0.75	844 Kgz
4473405	M6 x 0.75	Extension for measuring depth, length 50 mm	844 Kv
4473406	M6 x 0.75	Extension for measuring depth, length 100 mm	844 Kv
4473407	M6 x 0.75	Extension for measuring depth, length 250 mm	844 Kv
4473409	M6 x 0.75	Right angle attachment, M6 x 0.75	844 Kw



1004



1003



1002



1087 BR

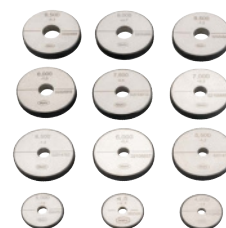

844 Ke



844 Kg;844 Kgz



844 Kga



844 Kv

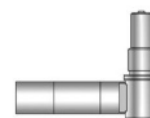

844 Dw;844 Kw

Marameter 844 Kck

Inside measuring probe

FEATURES

- Measuring head made in hardened steel, DLC coated
- Constant measuring force as a result of built-in spring, eliminating user influence
- Extensive modular system is composed of measuring head, transfer needle, holder, depth extension, right angle attachments and setting rings
- **Benefits of DLC Coating**
 - DLC = Diamond-Like Carbon
 - Extremely high wear resistance, for long service life even on hard or abrasive surfaces
 - Reduction of friction, ideal for sensitive surfaces such as non-ferrous metals and aluminium alloys
 - Wear indicator, worn areas appear as bright spots in the dark DLC coating

The minimum set of a measuring instrument consists of:

- Measuring head, transfer needle and holder plus indicator unit

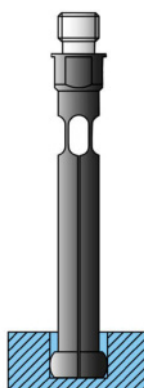

Application:

Standard form with extremely wear resistant DLC-coated surface, ideal also for scratch-sensitive surfaces

- For indicating measurement of diameter and testing for roundness and conicity of bores
- Especially suitable for testing batches
- Determine the reversal point by rocking in the bore

TECHNICAL DATA

Order no.	Nominal size mm	Type	Measuring range mm	Measuring depth mm	L mm
4473130	1	844 Kck	0.95 – 1.15	10.5	19.5
4473131	1.1	844 Kck	1.07 – 1.25	10.5	19.5
4473132	1.2	844 Kck	1.17 – 1.35	10.5	19.5
4473133	1.3	844 Kck	1.27 – 1.45	10.5	19.5
4473134	1.4	844 Kck	1.37 – 1.55	10.5	19.5
4473135	1.75	844 Kck	1.5 – 1.9	16	25.3
4473136	2	844 Kck	1.8 – 2.2	16	25.3
4473137	2.25	844 Kck	2.05 – 2.45	16	25.3
4473138	2.5	844 Kck	2.3 – 2.7	21	30.6
4473139	2.75	844 Kck	2.55 – 2.95	21	30.6
4473140	3	844 Kck	2.8 – 3.2	21	30.6
4473141	3.25	844 Kck	3.05 – 3.45	21	30.6
4473142	3.5	844 Kck	3.3 – 3.7	21	30.6
4473143	3.75	844 Kck	3.55 – 3.95	21	30.6
4473145	4	844 Kck	3.7 – 4.3	38	47.3
4473146	4.5	844 Kck	4.2 – 4.8	38	47.3
4473147	5	844 Kck	4.7 – 5.3	38	47.3
4473148	5.5	844 Kck	5.2 – 5.8	38	47.3
4473149	6	844 Kck	5.7 – 6.3	38	47.3
4473150	6.5	844 Kck	6.2 – 6.8	38	47.3
4473151	7	844 Kck	6.7 – 7.3	38	47.3
4473152	7.5	844 Kck	7.2 – 7.8	38	47.3
4473153	8	844 Kck	7.7 – 8.3	38	47.3
4473154	8.5	844 Kck	8.2 – 8.8	45	47.3
4473155	9	844 Kck	8.7 – 9.3	45	47.3
4473156	9.5	844 Kck	9.2 – 9.8	45	47.3
4473158	10	844 Kck	9.4 – 10.6	45	48.5
4473159	11	844 Kck	10.4 – 11.6	45	48.5
4473160	12	844 Kck	11.4 – 12.6	45	48.5
4473161	13	844 Kck	12.4 – 13.6	45	48.5
4473162	14	844 Kck	13.4 – 14.6	45	48.5
4473163	15	844 Kck	14.4 – 15.6	45	48.5
4473164	16	844 Kck	15.4 – 16.6	45	48.5
4473165	17	844 Kck	16.4 – 17.6	45	48.5
4473166	18	844 Kck	17.4 – 18.6	45	48.5
4473167	19	844 Kck	18.4 – 19.6	45	48.5
4473168	20	844 Kck	19.4 – 20.6	45	48.5

Marameter 844 KCK

Inside measuring probe

TECHNICAL DATA

Order no.	Dimension H1	Dimension L	Connection thread
	mm	mm	
4473130	0.6	19.5	M6 x 0.75
4473131	0.6	19.5	M6 x 0.75
4473132	0.6	19.5	M6 x 0.75
4473133	0.6	19.5	M6 x 0.75
4473134	0.6	19.5	M6 x 0.75
4473135	0.9	25.3	M6 x 0.75
4473136	0.9	25.3	M6 x 0.75
4473137	0.9	25.3	M6 x 0.75
4473138	1.2	30.6	M6 x 0.75
4473139	1.2	30.6	M6 x 0.75
4473140	1.2	30.6	M6 x 0.75
4473141	1.2	30.6	M6 x 0.75
4473142	1.2	30.6	M6 x 0.75
4473143	1.2	30.6	M6 x 0.75
4473145	2	47.3	M6 x 0.75
4473146	2	47.3	M6 x 0.75
4473147	2	47.3	M6 x 0.75
4473148	2	47.3	M6 x 0.75
4473149	2	47.3	M6 x 0.75
4473150	2	47.3	M6 x 0.75
4473151	2	47.3	M6 x 0.75
4473152	2	47.3	M6 x 0.75
4473153	2	47.3	M6 x 0.75
4473154	2	47.3	M6 x 0.75
4473155	2	47.3	M6 x 0.75
4473156	2	47.3	M6 x 0.75
4473158	3.3	48.5	M6 x 0.75
4473159	3.3	48.5	M6 x 0.75
4473160	3.3	48.5	M6 x 0.75
4473161	3.3	48.5	M6 x 0.75
4473162	3.3	48.5	M6 x 0.75
4473163	3.3	48.5	M6 x 0.75
4473164	3.3	48.5	M6 x 0.75
4473165	3.3	48.5	M6 x 0.75
4473166	3.3	48.5	M6 x 0.75
4473167	3.3	48.5	M6 x 0.75
4473168	3.3	48.5	M6 x 0.75

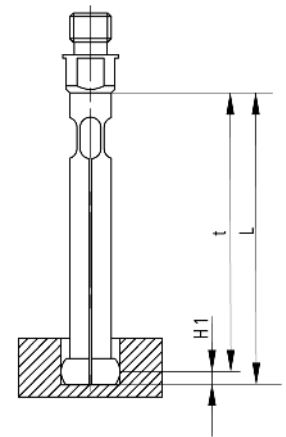

ACCESSORIES

Order no.	Description
4473093	Transfer pin made of carbide for inside measuring probe 844 K and 844 KC, size 0.95 –1.55 mm
4473094	Transfer pin made of carbide for inside measuring probe 844 K and 844 KC, size 1.5 –2.45 mm
4473095	Transfer pin made of carbide for inside measuring probe 844 K and 844 KC, size 2.3 –3.95 mm
4473096	Transfer pin made of carbide for inside measuring probe 844 K and 844 KC, size 3.7 –9.8 mm
4473097	Transfer pin made of carbide for inside measuring probe 844 K and 844 KC, size 9.4 –20.6 mm



Marameter 844 Kk

Inside measuring probe

FEATURES

- Measuring head made of hardened steel, hard chrome plated
- Constant measuring force as a result of built-in spring, eliminating user influence
- Extensive modular system is composed of measuring head, transfer needle, holder, depth extension, right angle attachments and setting rings

The minimum set of a measuring instrument consists of:

- Measuring head, transfer needle and holder plus indicator unit

Application:
Standard model

- For indicating measurement of diameter and testing for roundness and conicity of bores
- Especially suitable for testing batches
- Determine the reversal point by rocking in the bore

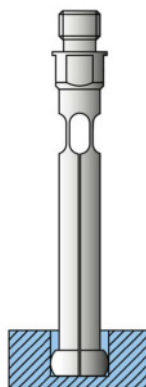

TECHNICAL DATA

Order no.	Nominal size	Type	Measuring range	Measuring depth	Dimension L
	mm		mm	mm	mm
4473030	1	844 Kk	0.95 – 1.15	10.5	19.5
4473031	1.1	844 Kk	1.07 – 1.25	10.5	19.5
4473032	1.2	844 Kk	1.17 – 1.35	10.5	19.5
4473033	1.3	844 Kk	1.27 – 1.45	10.5	19.5
4473034	1.4	844 Kk	1.37 – 1.55	10.5	19.5
4473035	1.75	844 Kk	1.5 – 1.9	16	25.3
4473036	2	844 Kk	1.8 – 2.2	16	25.3
4473037	2.25	844 Kk	2.05 – 2.45	16	25.3
4473038	2.5	844 Kk	2.3 – 2.7	21	30.6
4473039	2.75	844 Kk	2.55 – 2.95	21	30.6
4473040	3	844 Kk	2.8 – 3.2	21	30.6
4473041	3.25	844 Kk	3.05 – 3.45	21	30.6
4473042	3.5	844 Kk	3.3 – 3.7	21	30.6
4473043	3.75	844 Kk	3.55 – 3.95	21	30.6
4473045	4	844 Kk	3.7 – 4.3	38	47.3
4473046	4.5	844 Kk	4.2 – 4.8	38	47.3
4473047	5	844 Kk	4.7 – 5.3	38	47.3
4473048	5.5	844 Kk	5.2 – 5.8	38	47.3
4473049	6	844 Kk	5.7 – 6.3	38	47.3
4473050	6.5	844 Kk	6.2 – 6.8	38	47.3
4473051	7	844 Kk	6.7 – 7.3	38	47.3
4473052	7.5	844 Kk	7.2 – 7.8	38	47.3
4473053	8	844 Kk	7.7 – 8.3	38	47.3
4473054	8.5	844 Kk	8.2 – 8.8	45	47.3
4473055	9	844 Kk	8.7 – 9.3	45	47.3
4473056	9.5	844 Kk	9.2 – 9.8	45	47.3
4473058	10	844 Kk	9.4 – 10.6	45	48.5
4473059	11	844 Kk	10.4 – 11.6	45	48.5
4473060	12	844 Kk	11.4 – 12.6	45	48.5
4473061	13	844 Kk	12.4 – 13.6	45	48.5
4473062	14	844 Kk	13.4 – 14.6	45	48.5
4473063	15	844 Kk	14.4 – 15.6	45	48.5
4473064	16	844 Kk	15.4 – 16.6	45	48.5
4473065	17	844 Kk	16.4 – 17.6	45	48.5
4473066	18	844 Kk	17.4 – 18.6	45	48.5
4473067	19	844 Kk	18.4 – 19.6	45	48.5
4473068	20	844 Kk	19.4 – 20.6	45	48.5

Marameter 844 Kk

Inside measuring probe

TECHNICAL DATA

Order no.	H1	L	Connection thread
	mm	mm	
4473030	0.6	19.5	M6 x 0.75
4473031	0.6	19.5	M6 x 0.75
4473032	0.6	19.5	M6 x 0.75
4473033	0.6	19.5	M6 x 0.75
4473034	0.6	19.5	M6 x 0.75
4473035	0.9	25.3	M6 x 0.75
4473036	0.9	25.3	M6 x 0.75
4473037	0.9	25.3	M6 x 0.75
4473038	1.2	30.6	M6 x 0.75
4473039	1.2	30.6	M6 x 0.75
4473040	1.2	30.6	M6 x 0.75
4473041	1.2	30.6	M6 x 0.75
4473042	1.2	30.6	M6 x 0.75
4473043	1.2	30.6	M6 x 0.75
4473045	2	47.3	M6 x 0.75
4473046	2	47.3	M6 x 0.75
4473047	2	47.3	M6 x 0.75
4473048	2	47.3	M6 x 0.75
4473049	2	47.3	M6 x 0.75
4473050	2	47.3	M6 x 0.75
4473051	2	47.3	M6 x 0.75
4473052	2	47.3	M6 x 0.75
4473053	2	47.3	M6 x 0.75
4473054	2	47.3	M6 x 0.75
4473055	2	47.3	M6 x 0.75
4473056	2	47.3	M6 x 0.75
4473058	3.3	48.5	M6 x 0.75
4473059	3.3	48.5	M6 x 0.75
4473060	3.3	48.5	M6 x 0.75
4473061	3.3	48.5	M6 x 0.75
4473062	3.3	48.5	M6 x 0.75
4473063	3.3	48.5	M6 x 0.75
4473064	3.3	48.5	M6 x 0.75
4473065	3.3	48.5	M6 x 0.75
4473066	3.3	48.5	M6 x 0.75
4473067	3.3	48.5	M6 x 0.75
4473068	3.3	48.5	M6 x 0.75

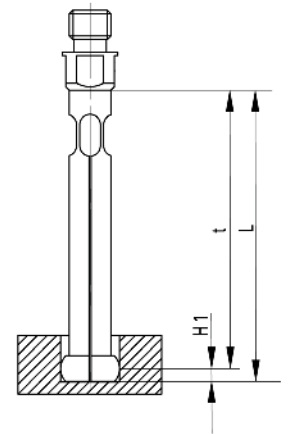

ACCESSORIES

Order no.	Description
4473093	Transfer pin made of carbide for inside measuring probe 844 K and 844 KC, size 0.95 –1.55 mm
4473094	Transfer pin made of carbide for inside measuring probe 844 K and 844 KC, size 1.5 –2.45 mm
4473095	Transfer pin made of carbide for inside measuring probe 844 K and 844 KC, size 2.3 –3.95 mm
4473096	Transfer pin made of carbide for inside measuring probe 844 K and 844 KC, size 3.7 –9.8 mm
4473097	Transfer pin made of carbide for inside measuring probe 844 K and 844 KC, size 9.4 –20.6 mm



Marameter 844 KSk

Blind hole measuring probe

FEATURES

- Measuring head made of hardened steel, hard chrome plated
- Constant measuring force as a result of built-in spring, eliminating user influence
- Extensive modular system is composed of measuring head, transfer needle, holder, depth extension, right angle attachments and setting rings

The minimum set of a measuring instrument consists of:

- Measuring head, transfer needle and holder plus indicator unit

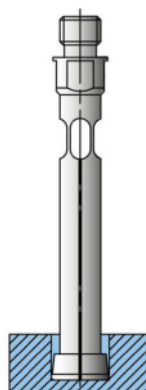

Application:
Model for blind holes

- For measurements near to the bottom of bores
- For indicating measurement of diameter and testing for roundness and conicity of bores
- Especially suitable for testing batches
- Determine the reversal point by rocking in the bore

TECHNICAL DATA

Order no.	Nominal size	Type	Measuring range	Measuring depth	Dimension L
	mm		mm	mm	mm
4473245	4	844 KSk	3.7 – 4.3	38	47.3
4473246	4.5	844 KSk	4.2 – 4.8	38	47.3
4473247	5	844 KSk	4.7 – 5.3	38	47.3
4473248	5.5	844 KSk	5.2 – 5.8	38	47.3
4473249	6	844 KSk	5.7 – 6.3	38	47.3
4473250	6.5	844 KSk	6.2 – 6.8	38	47.3
4473251	7	844 KSk	6.7 – 7.3	38	47.3
4473252	7.5	844 KSk	7.2 – 7.8	38	47.3
4473253	8	844 KSk	7.7 – 8.3	38	47.3
4473254	8.5	844 KSk	8.2 – 8.8	45	47.3
4473255	9	844 KSk	8.7 – 9.3	45	47.3
4473256	9.5	844 KSk	9.2 – 9.8	45	47.3
4473258	10	844 KSk	9.4 – 10.6	45	48.5
4473259	11	844 KSk	10.4 – 11.6	45	48.5
4473260	12	844 KSk	11.4 – 12.6	45	48.5
4473261	13	844 KSk	12.4 – 13.6	45	48.5
4473262	14	844 KSk	13.4 – 14.6	45	48.5
4473263	15	844 KSk	14.4 – 15.6	45	48.5
4473264	16	844 KSk	15.4 – 16.6	45	48.5
4473265	17	844 KSk	16.4 – 17.6	45	48.5
4473266	18	844 KSk	17.4 – 18.6	45	48.5
4473267	19	844 KSk	18.4 – 19.6	45	48.5
4473268	20	844 KSk	19.4 – 20.6	45	48.5

Marameter 844 KSk

Blind hole measuring probe

TECHNICAL DATA

Order no.	H2	Dimension L	Connection thread
	mm	mm	
4473245	0.5	47.3	M6 x 0.75
4473246	0.5	47.3	M6 x 0.75
4473247	0.5	47.3	M6 x 0.75
4473248	0.5	47.3	M6 x 0.75
4473249	0.5	47.3	M6 x 0.75
4473250	0.5	47.3	M6 x 0.75
4473251	0.5	47.3	M6 x 0.75
4473252	0.5	47.3	M6 x 0.75
4473253	0.5	47.3	M6 x 0.75
4473254	0.5	47.3	M6 x 0.75
4473255	0.5	47.3	M6 x 0.75
4473256	0.5	47.3	M6 x 0.75
4473258	1	48.5	M6 x 0.75
4473259	1	48.5	M6 x 0.75
4473260	1	48.5	M6 x 0.75
4473261	1	48.5	M6 x 0.75
4473262	1	48.5	M6 x 0.75
4473263	1	48.5	M6 x 0.75
4473264	1	48.5	M6 x 0.75
4473265	1	48.5	M6 x 0.75
4473266	1	48.5	M6 x 0.75
4473267	1	48.5	M6 x 0.75
4473268	1	48.5	M6 x 0.75

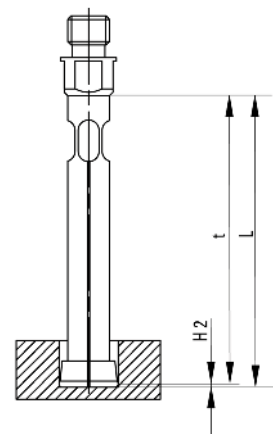

ACCESSORIES

Order no.	Description
4473296	Transfer pin made of carbide for inside measuring probe 844 KS, size 3.7 –9.8 mm
4473297	Transfer pin made of carbide for inside measuring probe 844 KS, size 9.4 –20.6 mm



Marameter | Modular system

By combining with a wide range of accessories (indicators, internal probes with drive needles, holders, extensions and right angle attachment), the internal gage becomes a precision measuring instrument, adapted to the measuring task.

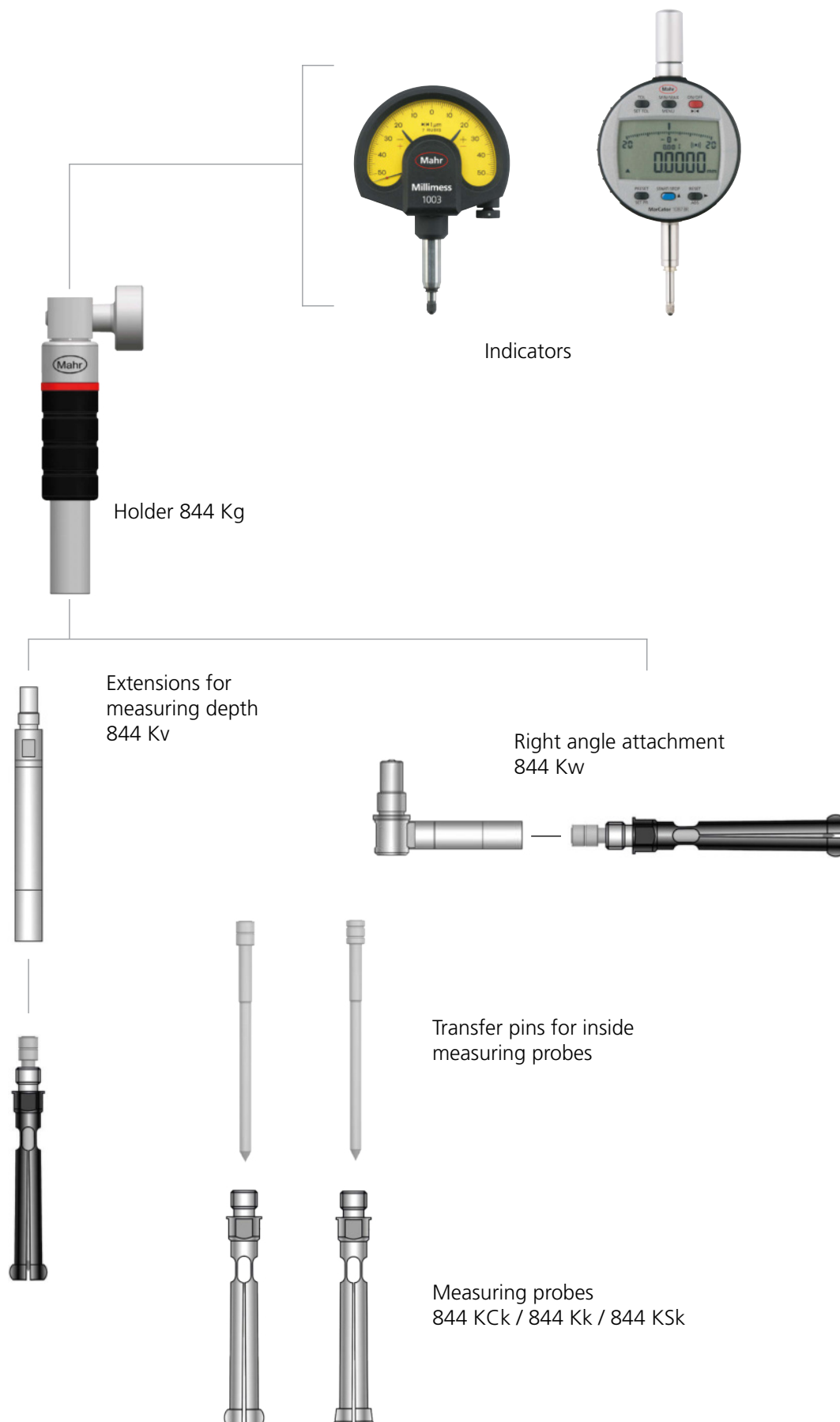

Marameter 844 Kg / 844 Kga / 844 Kgz

Holder for indicator

FEATURES

- Holder for mounting an indicator (comparator, dial gage or inductive probe) and connection of an 844 K/KC/KS inside measuring probe or corresponding accessories such as 844 Kt measuring depth extensions or 844 Kw right angle attachment



Applications:

- **844 Kga:** Special design with retracting button, for easier insertion of the internal measuring probe into bores. Recommended for small and sensitive bores.
- **844 Kgz:** Special design for dial gages with shaft diameter 3/8 inch (typical for dial gages from USA).

TECHNICAL DATA

Order no.	Type	Mount diameter	Dimension L	d1	l	Connection thread
4473400	844 Kg	8 mm	73	10	23	M6 x 0.75
4473401	844 Kga	8 mm	73	10	23	M6 x 0.75
4473402	844 Kgz	.375"	73	10	23	M6 x 0.75

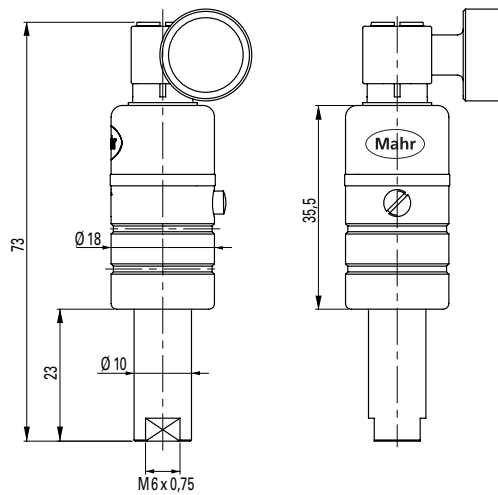

Marameter 844 Kv

Extension for measuring depth

FEATURES

- The measuring depth extension is screwed in between the holder (844 Kg/Kga) and the inside probe (844 K/KS/KS)



Application:

- To reach measuring points in deep bores

TECHNICAL DATA

Order no.	Type	Dimension L
		mm
4473405	844 Kv	50
4473406	844 Kv	100
4473407	844 Kv	250

Order no.	Dimension L	d	Connection thread
	mm	mm	
4473405	50	7.9	M6 x 0.75
4473406	100	7.9	M6 x 0.75
4473407	250	7.9	M6 x 0.75

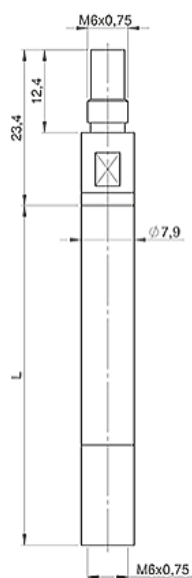

Marameter 844 Kt

Depth stop

FEATURES

Application:

- For setting the 844 K/KC/KS split ball gages to a defined and repeatable measuring depth
- Clamping on the cylindrical shaft $\varnothing 7.9$ mm of the measuring depth extensions 844 Kv

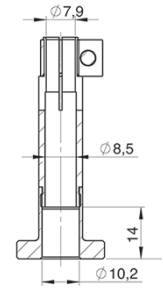
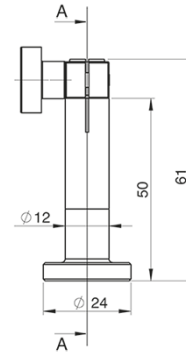
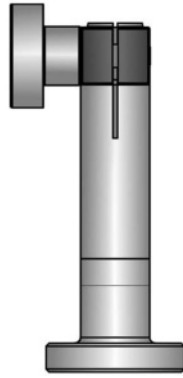

SCHNITT A-A

TECHNICAL DATA

Order no.	Type	Size of measuring surface	Mount diameter
4473408	844 Kt	$\varnothing 24$ mm	mm For shaft $\varnothing 7.9$ mm

Marameter 844 Kw

Right angle attachment

FEATURES

- The 844 Kw right angle attachment is screwed in between holder 844 Kg and bore gage 844 K / 844 KC / 844 KS (if necessary extensions 844 Kv)

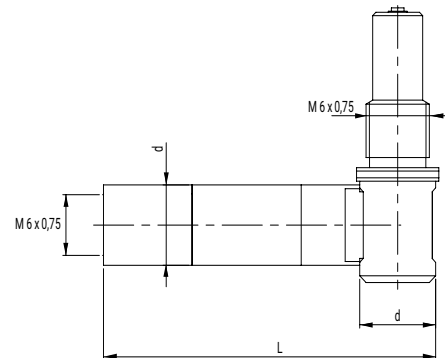
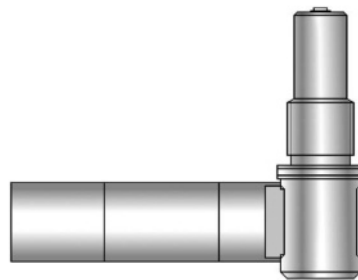

Application:

- For space-saving and side-entering measurement of bores
- Typical measuring problem situations:
 - Narrow conditions in turning and grinding machines
 - Side outgoing bores or bearing points in housings

TECHNICAL DATA

Order no.	Type	L	d	Connection thread
4473409	844 Kw	mm 29	mm 7.9	M6 x 0.75

Marameter 844 Ke

Setting rings in set

FEATURES

2 Designs:

- Setting rings \varnothing 1.0 – 2.75 mm made of hardened steel according to factory standard: manufacturing tolerance of the bore: $\pm 1 \mu\text{m}$
- Setting rings \varnothing 3 – 20 mm made of hardened steel according to DIN 2250 form C

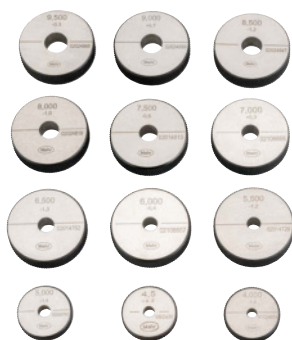

Application:

- The setting rings are used as dimensional standards for adjusting the bore gages 844 K/KC/KS to the respective nominal dimension

TECHNICAL DATA

Order no.	Number of setting rings	Type	Nominal size	Model
			mm	
4473375	5	844 Ke	1 1.1 1.2 1.3 1.4	Hardened steel
4473376	9	844 Ke	1.75 2 2.25 2.5 2.75 3 3.25 3.5 3.75	Hardened steel
4473377	12	844 Ke	4 4.5 5 5.5 6 6.5 7 7.5 8 8.5 9 9.5	Hardened steel
4473378	21	844 Ke	1.75 2 2.25 2.5 2.75 3 3.25 3.5 3.75 4 4.5 5 5.5 6 6.5 7 7.5 8 8.5 9 9.5	Hardened steel
4473379	11	844 Ke	10 11 12 13 14 15 16 17 18 19 20	Hardened steel

Marameter 844 Ke

Setting rings in set

ACCESSORIES

Order no.	Description	Type
4473310	Setting ring, Ø 1 mm	844 Ke
4473311	Setting ring, Ø 1.1 mm	844 Ke
4473312	Setting ring, Ø 1.2 mm	844 Ke
4473313	Setting ring, Ø 1.3 mm	844 Ke
4473314	Setting ring, Ø 1.4 mm	844 Ke
4473315	Setting ring, Ø 1.75 mm	844 Ke
4473316	Setting ring, Ø 2 mm	844 Ke
4473317	Setting ring, Ø 2.25 mm	844 Ke
4473318	Setting ring, Ø 2.5 mm	844 Ke
4473319	Setting ring, Ø 2.75 mm	844 Ke
4710014	Ring gage DIN 2250 C, Ø 3 mm	355 E
4710015	Ring gage DIN 2250 C, Ø 3.25 mm	355 E
4710016	Ring gage DIN 2250 C, Ø 3.5 mm	355 E
4710017	Ring gage DIN 2250 C, Ø 3.75 mm	355 E
4710018	Ring gage DIN 2250 C, Ø 4 mm	355 E
4710019	Ring gage DIN 2250 C, Ø 4.5 mm	355 E
4710020	Ring gage DIN 2250 C, Ø 5 mm	355 E
4710021	Ring gage DIN 2250 C, Ø 5.5 mm	355 E
4710022	Ring gage DIN 2250 C, Ø 6 mm	355 E
4710023	Ring gage DIN 2250 C, Ø 6.5 mm	355 E
4710024	Ring gage DIN 2250 C, Ø 7 mm	355 E
4710025	Ring gage DIN 2250 C, Ø 7.5 mm	355 E
4710026	Ring gage DIN 2250 C, Ø 8 mm	355 E
4710027	Ring gage DIN 2250 C, Ø 8.5 mm	355 E
4710028	Ring gage DIN 2250 C, Ø 9 mm	355 E
4710029	Ring gage DIN 2250 C, Ø 9.5 mm	355 E
4710030	Ring gage DIN 2250 C, Ø 10 mm	355 E
4710031	Ring gage DIN 2250 C, Ø 11 mm	355 E
4710032	Ring gage DIN 2250 C, Ø 12 mm	355 E
4710033	Ring gage DIN 2250 C, Ø 13 mm	355 E
4710034	Ring gage DIN 2250 C, Ø 14 mm	355 E
4710035	Ring gage DIN 2250 C, Ø 15 mm	355 E
4710036	Ring gage DIN 2250 C, Ø 16 mm	355 E
4710037	Ring gage DIN 2250 C, Ø 17 mm	355 E
4710038	Ring gage DIN 2250 C, Ø 18 mm	355 E
4710039	Ring gage DIN 2250 C, Ø 19 mm	355 E
4710040	Ring gage DIN 2250 C, Ø 20 mm	355 E



844 Ke



355 E

Marameter 844 KM

Measuring stand

FEATURES

- High measuring column with large adjustment range
- Stop ring for measuring height, ideal when changing probes
- Large stroke for probe lowering
- Depth stop for stroke limitation
- Large measuring table (Ø 120 mm) with dust grooves and 4 threaded holes for the individual mounting of a prismatic stop 844 KMp
- Adjustment element for device holder 844 Kg / 844 Kga / 844 Kgz with shaft Ø 10 mm
- Additional mounting Ø 8 mm for optional dial gage as measuring depth indicator

Application:

- Ideal for production testing with 844 KM inside measuring probes, eliminates need for rocking to find reversal point



TECHNICAL DATA

Order no.	Type
4473420	844 KM

ACCESSORIES

Order no.	Description	Type
4473425	Floating holder for measuring stand 844 KM, including. 2 bushings to clamp shaft Ø 10 mm and Ø 11.9 mm	844 KMs
4473426	Prismatic stop including knurled clamping screw for measuring table 844 KM	844 KMp



844 KMs

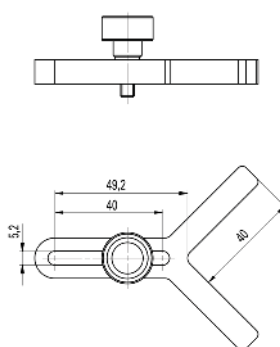

844 KMp

Marameter 844 NB

Self-centering dial bore gage

FEATURES

- Measuring head consists of a carbide tipped moving anvil and an interchangeable stationary anvil with a carbide ball
- Transmission lever system transfers movement of movable anvil to indicating instrument
- The broad centering bridge ensures automatic centering in the bore
- Resistant to temperature because the shank and transfer rod are made of heat resistant Invar steel
- Highly resistant to wear and tear because of carbide tipped moving anvil
- Constant measuring force due to built-in spring, eliminating user influence
- Universally applicable and extremely versatile
 - Each instrument spans a broad measuring range
 - Quick and easy to adjust to any size (within its range)
- Invar steel has a particularly low expansion coefficient
 - Instrument totally insensitive to any kind of heat (including user body heat and increased ambient temperature)
- **Package contains:** measuring holder, measuring head, anvil spindle, wooden case, excludes indicator

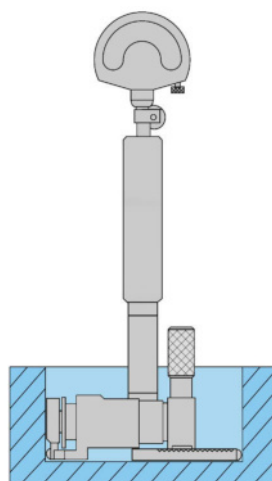

Application:

- For blind holes, to measure almost to the base of a bore

TECHNICAL DATA

Order no.		4474179	4474180	4474186
Type			844 NB	
Measuring range	mm	20 – 50	50 – 110	110 – 300
Measuring range	inch	0.79 – 2"	2 – 4.33"	4.33 – 11.81"
Error limit G_e	μm	4	3	2.5
Repeatability f_w	μm	1		

Order no.	a	b	c	d	e
	mm	mm	mm	mm	mm
4474179	1.5	10	77	60	163
4474180	1.5	12	60	60	144
4474186	2	18	90	90	163

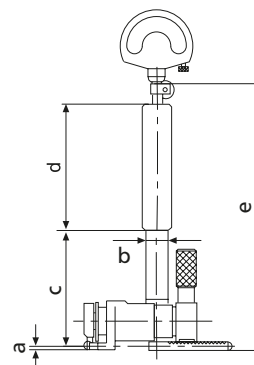

ACCESSORIES

Order no.	Description	Type
4333000	Millimess 5 μm , $\pm 130 \mu\text{m}$	1004
4334000	Millimess 1 μm , $\pm 50 \mu\text{m}$	1003
4335000	Millimess 0.5 μm , $\pm 25 \mu\text{m}$	1002
4337662	Digital indicator, 0.0005 mm, 12.5 mm	1087 BR
4337664	Digital indicator, 0.0005 mm, 12.5 mm	1087 BRi



1004



1003



1002



1087 BR

Marameter 844 N

Self-centering dial bore gage

FEATURES

- Measuring head consists of a carbide tipped moving anvil and an interchangeable stationary anvil with a hardened steel ball
- Transmission lever system transfers movement of movable anvil to indicating instrument
- The broad centering bridge ensures automatic centering in the bore
- Resistant to temperature because the shank and transfer rod are made of heat resistant Invar steel
- Highly resistant to wear and tear because of carbide tipped moving anvil
- Constant measuring force due to built-in spring, eliminating user influence
- Universally applicable and extremely versatile
 - Each instrument spans a broad measuring range
 - Quick and easy to adjust to any size (within its range)
- Extensive modular system is composed of measuring head, holder, extensions, right angle attachments and depth stops
- Invar steel has a particularly low expansion coefficient
 - Instrument totally insensitive to any kind of heat (including user body heat and increased ambient temperature)
- **Package contains:** measuring holder, measuring head, anvil spindle, wooden case, excludes indicator



Application

- Measuring the diameter, roundness and conical form of a bore as well as the distances of parallel plane surfaces

TECHNICAL DATA

Order no.	Type	Measuring range	Measuring range	Distance of movable anvil	Measuring depth	Error limit G_c	Repeatability f_w
		mm	inch	mm	mm	μm	μm
4474000	844 N	18–50	.7–2"	1.3	115	2	0.5
4474001	844 N	35–100	1.4–4"	1.3	148	2	0.5
4474002	844 N	100–250	4–10"	1.6	230	2	0.5
4474003	844 N	250–400	10–16"	2.6	366	3	1.5
4474004	844 N	400–800	16–32"	2.6	366	3	1.5
4474005	844 N	250–800	10–32"	2.6	366	3	1.5

Order no.	a	b	c	d	e
	mm	mm	mm	mm	mm
4474000	5.3	8	115	63	22
4474001	8.5	12	148	80	22
4474002	11.5	18	230	100	25
4474003	16	24	366	110	28
4474004	17.5	24	366	110	28
4474005	17.5	24	366	110	28

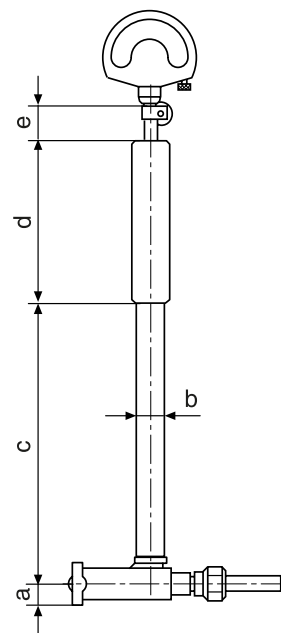

Marameter 844 N

Self-centering dial bore gage

ACCESSORIES

Order no.	Description	Type
4335000	Millimess 0.5 μm , $\pm 25 \mu\text{m}$	1002
4334000	Millimess 1 μm , $\pm 50 \mu\text{m}$	1003
4333000	Millimess 5 μm , $\pm 130 \mu\text{m}$	1004
4337662	Digital indicator, 0.0005 mm, 12.5 mm	1087 BR
4337664	Digital indicator, 0.0005 mm, 12.5 mm	1087 BRi
4800120	Holder, span width 0 –70 mm	420 h
4800121	Holder, span width 0 –120 mm	420 h
4800122	Holder, span width 100 –220 mm	420 h
4800123	Holder, span width 100 –420 mm	420 h
4800124	Holder, span width 400 –820 mm	420 h
4474080	Adjustment bridge (70 x 12 mm), for measuring range 18 –250 mm (for 844 N)	844 Neb
4474081	Adjustment bridge (165 x 17 mm), for measuring range 18 –400 mm (for 844 N)	844 Neb
4474082	Adjustment bridge (320 x 20 mm), for measuring range 18 –800 mm (for 844 N)	844 Neb
4474050	Short holder (18 –50 mm)	844 Ngk
4474051	Short holder (35 –100 mm)	844 Ngk
4474052	Short holder (100 –250 mm)	844 Ngk
4474053	Short holder (250 –800 mm)	844 Ngk
4474060	Measuring depth extension (250 mm) for measuring range 35 –100 mm	844 Nv
4474061	Measuring depth extension (250 mm) for measuring range 100 –250 mm	844 Nv
4474062	Measuring depth extension (500 mm) for measuring range 100 –250 mm	844 Nv
4474063	Measuring depth extension (250 mm) for measuring range 250 –800 mm	844 Nv
4474064	Measuring depth extension (500 mm) for measuring range 250 –800 mm	844 Nv
4474066	Measuring depth extension (250 mm) for measuring range 18 –50 mm	844 Nv
4474070	Right angle attachment, bore depth 45 mm, for measuring range 18 –50 mm	844 Nw
4474071	Right angle attachment, bore depth 55 mm, for measuring range 35 –100 mm	844 Nw
4474072	Right angle attachment, bore depth 70 mm, for measuring range 100 –250 mm	844 Nw
4470098	Base for mounting holder 420 h up to 420 mm	844 ef
4470095	Measuring jaw (60 x 9.5 x 9 mm), for measuring range 18 –800 mm (for 844 N)	844 em



1004



1003



1002



1087 BR



844 em



844 Neb



844 ef

Marameter 844 NH

Self-centering dial bore gage

FEATURES

- Measuring head consists of a carbide-tipped, movable measuring pin and an opposing interchangeable stationary counter probe with carbide ball
- Movements of the measuring pin are transmitted to the indicating instrument via the ring segment
- The broad centering bridge ensures automatic centering in the bore
- Insensitive to temperature due to both the shaft and the transfer rod being made from Invar steel
- Carbide tipped measuring contacts for high wear resistance
- Constant measuring force due to built-in spring, eliminating user influence
- Universally applicable and extremely versatile
 - Each instrument spans a broad measuring range
 - Quick and easy to adjust to any size (within its range)
- Measuring head, measuring instrument holder, depth extensions, right angle attachments, and depth stops form a comprehensive modular system
- Invar steel makes the inner measuring device insensitive to temperature influences of any kind. Body heat from the user or a rise in ambient temperature in the workplace have virtually no influence on measuring results
- **Package contains:** measuring holder, measuring head, anvil spindle, wooden case, excludes indicator



Application:

- Measuring the diameter, roundness and conical form of a bore as well as the distances of parallel plane surfaces

TECHNICAL DATA

Order no.	Type	Measuring range		Distance of movable anvil	Measuring depth	Error limit G_v	Repeatability f_w
		mm	inch				
4475000	844 NH	18 – 50	.7 – 2"	1.3	115	2	0.5
4475001	844 NH	35 – 100	1.4 – 4"	1.3	148	2	0.5
4475002	844 NH	100 – 250	4 – 10"	1.6	230	2	0.5
4475003	844 NH	250 – 400	10 – 16"	2.6	336	3	1.5
4475004	844 NH	400 – 800	16 – 32"	2.6	336	3	1.5
4475005	844 NH	250 – 800	10 – 32"	2.6	336	3	1.5

Order no.	a	b	c	d	e
	mm	mm	mm	mm	mm
4475000	5.3	8	115	63	22
4475001	8.5	12	148	80	22
4475002	11.5	18	230	100	25
4475003	16	24	366	110	28
4475004	17.5	24	366	110	28
4475005	17.5	24	366	110	28

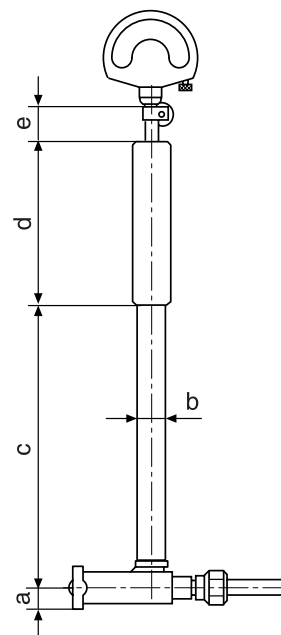

Marameter 844 NH

Self-centering dial bore gage

ACCESSORIES

Order no.	Description	Type
4335000	Millimes 0.5 μm , $\pm 25 \mu\text{m}$	1002
4334000	Millimes 1 μm , $\pm 50 \mu\text{m}$	1003
4333000	Millimes 5 μm , $\pm 130 \mu\text{m}$	1004
4337662	Digital indicator, 0.0005 mm, 12.5 mm	1087 BR
4337664	Digital indicator, 0.0005 mm, 12.5 mm	1087 BRi
4800120	Holder, span width 0 –70 mm	420 h
4800121	Holder, span width 0 –120 mm	420 h
4800122	Holder, span width 100 –220 mm	420 h
4800123	Holder, span width 100 –420 mm	420 h
4800124	Holder, span width 400 –820 mm	420 h
4474080	Adjustment bridge (70 x 12 mm), for measuring range 18 –250 mm (for 844 N)	844 Neb
4474081	Adjustment bridge (165 x 17 mm), for measuring range 18 –400 mm (for 844 N)	844 Neb
4474082	Adjustment bridge (320 x 20 mm), for measuring range 18 –800 mm (for 844 N)	844 Neb
4474050	Short holder (18 –50 mm)	844 Ngk
4474051	Short holder (35 –100 mm)	844 Ngk
4474052	Short holder (100 –250 mm)	844 Ngk
4474053	Short holder (250 –800 mm)	844 Ngk
4474060	Measuring depth extension (250 mm) for measuring range 35 –100 mm	844 Nv
4474061	Measuring depth extension (250 mm) for measuring range 100 –250 mm	844 Nv
4474062	Measuring depth extension (500 mm) for measuring range 100 –250 mm	844 Nv
4474063	Measuring depth extension (250 mm) for measuring range 250 –800 mm	844 Nv
4474064	Measuring depth extension (500 mm) for measuring range 250 –800 mm	844 Nv
4474066	Measuring depth extension (250 mm) for measuring range 18 –50 mm	844 Nv
4474070	Right angle attachment, Bore depth 45 mm, for measuring range 18 –50 mm	844 Nw
4474071	Right angle attachment, Bore depth 55 mm, for measuring range 35 –100 mm	844 Nw
4474072	Right angle attachment, Bore depth 70 mm, for measuring range 100 –250 mm	844 Nw
4470098	Base for mounting holder 420 h up to 420 mm	844 ef
4470095	Measuring jaw (60 x 9.5 x 9 mm), for measuring range 18 –800 mm (for 844 N)	844 em



1004



1003



1002



1087 BR



844 em



844 Neb



844 ef

Multimar | Universal measuring instruments

Whether you are measuring gears, threads, cones or grooves, Multimar universal measuring instruments are an ideal solution for almost all internal and external measurements for which standard measuring instruments are unsuitable. A choice of basic units and an extensive range of accessories are available.

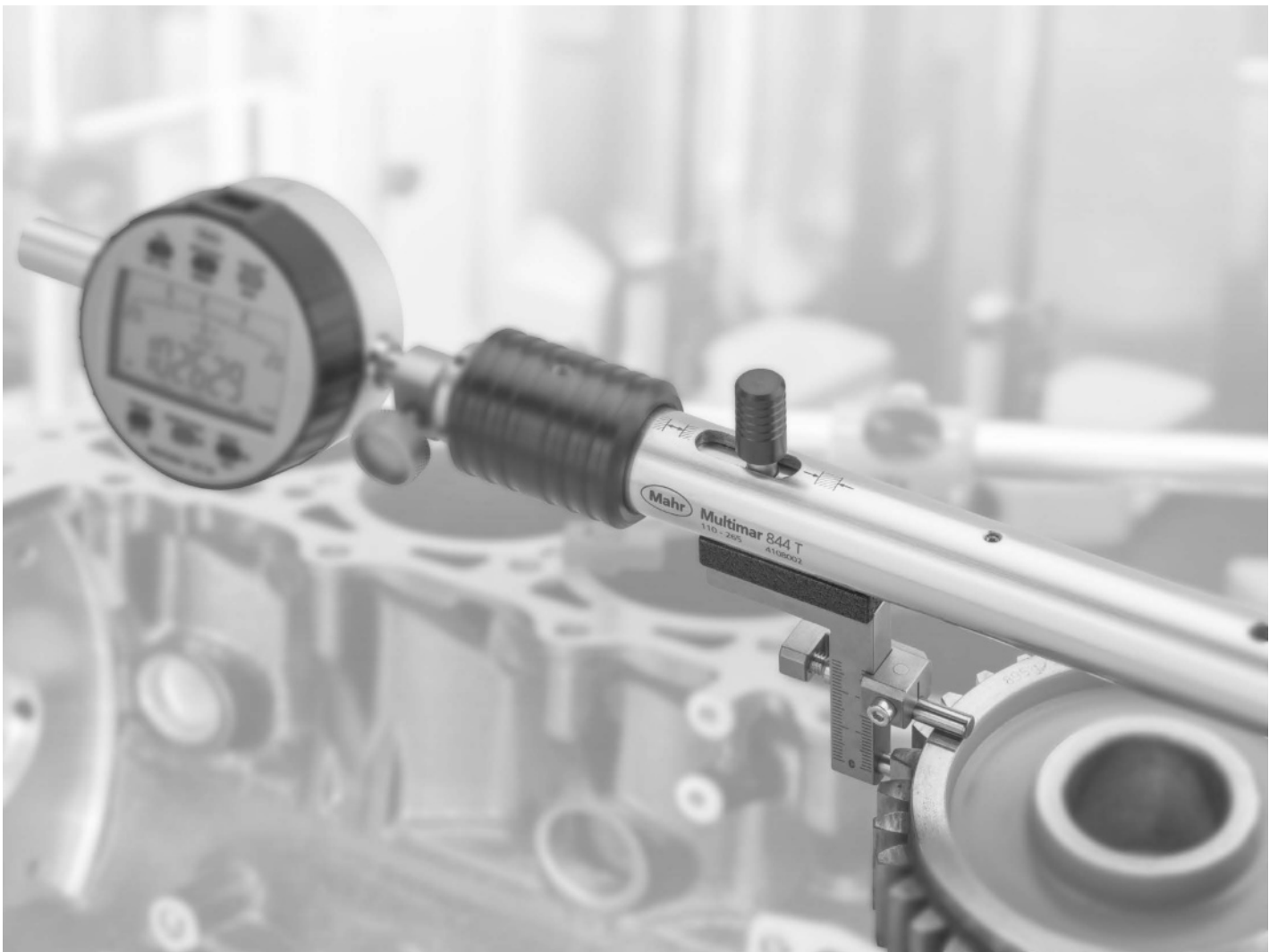

Multimar 25 EWRI / 25 EWR Digital universal caliper	410
Overview Multimar 844 T universal probe and accessories	413
Multimar 844 T Universal probe	416
Multimar 844 Tw Depth stops for measuring arms 844 Tma, 844 Tmi, 844 Te	418
Multimar 844 Tma / 844 Tmi Mounting attachments	419
Multimar 844 Tms Mounting attachments with 90° offset	420
Multimar 844 Ta / 844 Ti Shoulder measuring anvils	421
Multimar 844 Tb / 844 Tc Measuring anvils with measuring blades	423
Multimar 844 Td Anvils with round measuring faces	425
Multimar 844 Tz Cylindrical pin gages	426
Multimar 844 Te Measuring arms	427
Multimar 844 Tp / 844 Ts Measuring anvils, flat	430
Multimar 844 Tk Spherical anvil	431
Multimar 844 S Setting instrument	432
Multimar M36B-10 / M36B-20 Indicating measuring instruments	433
Multimar EDI-36B-10 ...-20 / EMD-36B-10 ...-20D Indicating measuring instruments	434
Multimar 36B-10 / 36B-20 Indicating measuring instruments	435
Multimar EDI-36B-19 / EDI-36B-9 / EMD-36B-19D / EMD-36B-9D Indicating measuring instruments	437
Multimar 36B-19 / 36B-9 / 36B-19M / 36B-9M Indicating measuring instruments	438

Multimar 25 EWRI / 25 EWR

Digital universal calipers

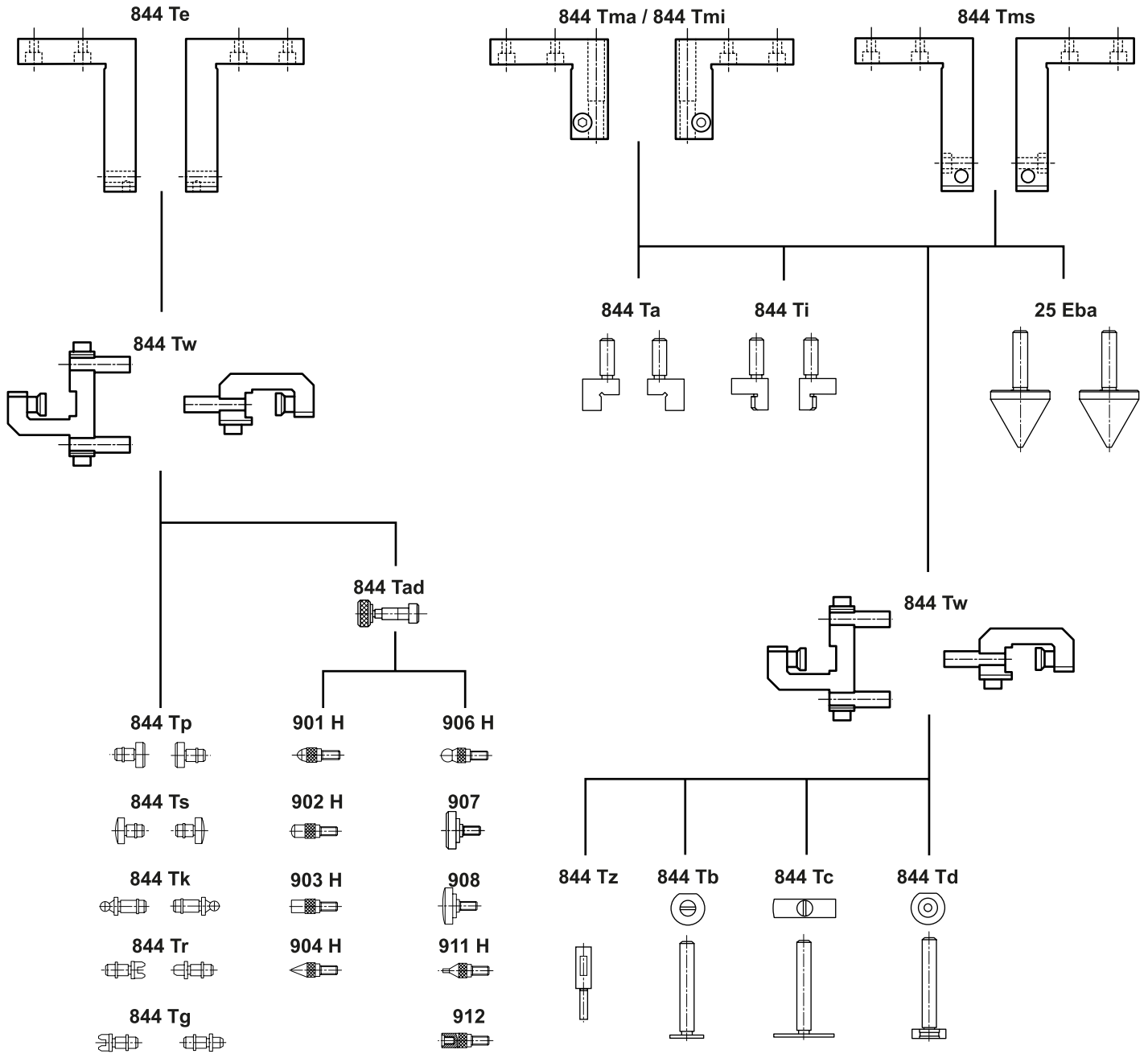

Multimar 25 EWR / 25 EWRi

Digital universal calipers

FUNCTIONS

Functions 25 EWR:

- ON/OFF
- AUTO-ON / OFF
- RESET (set display to zero)
- mm/inch
- PRESET (for entering a numerical value)
- LOCK function (key lock)
- DATA (data transmission via connection cable)

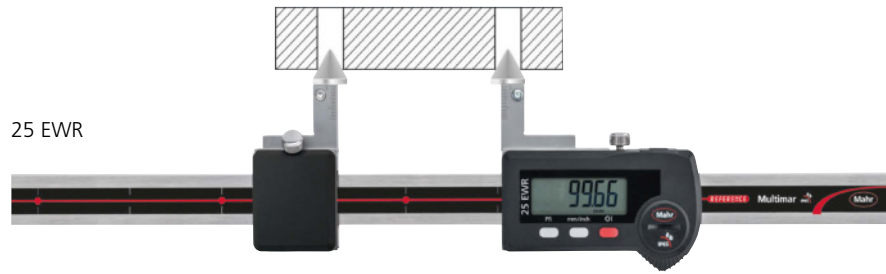

Functions 25 EWRi:

- ON/OFF
- AUTO-ON / OFF
- HOLD (storage of measured values)
- RESET (set display to zero)
- PRESET (for entering a numerical value)
- Reversal of counting direction
- mm/inch
- LOCK function (key lock)
- DATA (data transmission)



- Can be customized to the measuring task due to modular accessories (optional)
- Digital display can always be read as the measuring elements can be installed on the top or bottom
- The application range can be extended by turning the measuring arms
- The two arm holders can be moved along the rail for optimal balance, which is practical with small dimensions
- Slide and rail are made of hardened stainless steel

Applications:

For measuring

- Outside and inside diameters
- Centering shoulders
- Narrow collars
- External and internal tapers
- Dovetails
- Grooves
- Distances between hole centers

TECHNICAL DATA

Order no.	Type	Application range		Resolution	Error limit
		outside	outside		
		mm	inch	mm/inch	mm
4119000	25 EWR	0 – 300	0 – 12	0.01 / .0005"	0.03
4119001	25 EWR	0 – 600	0 – 24	0.01 / .0005"	0.03
4119002	25 EWR	0 – 1000	0 – 40	0.01 / .0005"	0.04
4119003	25 EWR	0 – 1250	0 – 50	0.01 / .0005"	0.04
4119050	25 EWRi	0 – 300	0 – 12	0.01 / .0005"	0.03
4119051	25 EWRi	0 – 600	0 – 24	0.01 / .0005"	0.03
4119052	25 EWRi	0 – 1000	0 – 40	0.01 / .0005"	0.04
4119053	25 EWRi	0 – 1250	0 – 50	0.01 / .0005"	0.04

FEATURES

25 EWR:

- **Software:** MarCom Professional free download: www.mahr.com/marcom (only for Mahr data cables and wireless systems with USB and RS-232 interface)
- **Data interface:** USB, Digimatic, Opto RS-232C, wireless
- **Energy supply:** Battery life approx. 3 years
- **Battery type:** CR 2032 (3V Lithium)
- **IP protection category:** IP 65
- **Package contains:** battery, instruction manual, mounting and resting blocks, wooden case, without arms/attachments and anvils

25 EWRi:

- **Data interface:** Integrated Wireless
- **Energy supply:** Battery life approx. 3 years (approx. 0.5 in wireless mode)

Order no.	a
	mm
4119000	480
4119001	790
4119002	1200
4119003	1450
4119050	480
4119051	790
4119052	1200
4119053	1450

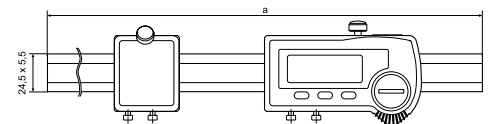



ACCESSORIES

Order no.	For measuring instrument	Description	Type
4102220	25 EWR	Receiver for instruments with Integrated Wireless	i-Stick
4102231	25 EWR	16 EWe transmitter for e-Stick	16 EWe
4102357	25 EWR	16 EXu data connection cable USB (2 m)	16 EXu
4102410	25 EWR	Data connection cable RS232C (2 m)	16 EXr
4102915	25 EWR	Interface adapter with data cable Digimatic (2 m)	16 EWd
4118520	25 EWR, 25 EWRi	Setting gage	25 Eel
4119010	25 EWR, 25 EWRi	Measuring tips for drill hole intervals, Ø 2–20 mm	25 Eba
4119011	25 EWR, 25 EWRi	Measuring tips for drill hole intervals, Ø 10–40 mm	25 Eba
4503020	25 EWR, 25 EWRi	Case for accessories	844 Tzb
4503024	25 EWR, 25 EWRi	Measuring arms, 25 mm	844 Te
4503025	25 EWR, 25 EWRi	Measuring arms, 35 mm	844 Te
4503026	25 EWR, 25 EWRi	Measuring arms, 70 mm	844 Te
4503027	25 EWR, 25 EWRi	Measuring arms, 100 mm	844 Te
4503030	25 EWR, 25 EWRi	Mounting attachment	844 Tma
4503031	25 EWR, 25 EWRi	Mounting attachment	844 Tmi
4503109	25 EWR, 25 EWR, 25 EWRi, 25 EWRi, 25 EWRi	Depth stops for 844 Tma, 844 Tmi, 844 Te	844 Tw



16 EWe



25 Eel



844 Tma

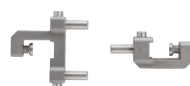

844 Tw



25 Eba



i-Stick

Multimar | Universal gage 844 T for external and internal dimensions

The universal gage Multimar 844 T is easy to use and versatile; ideal for all your measuring requirements in dimensional metrology.

Applications

For measuring:

- External and internal dimensions
- External and internal threads
- Centering shoulders, narrow collars, recesses and grooves
- External and internal tapers, external and internal tooth profiles/gears, etc.

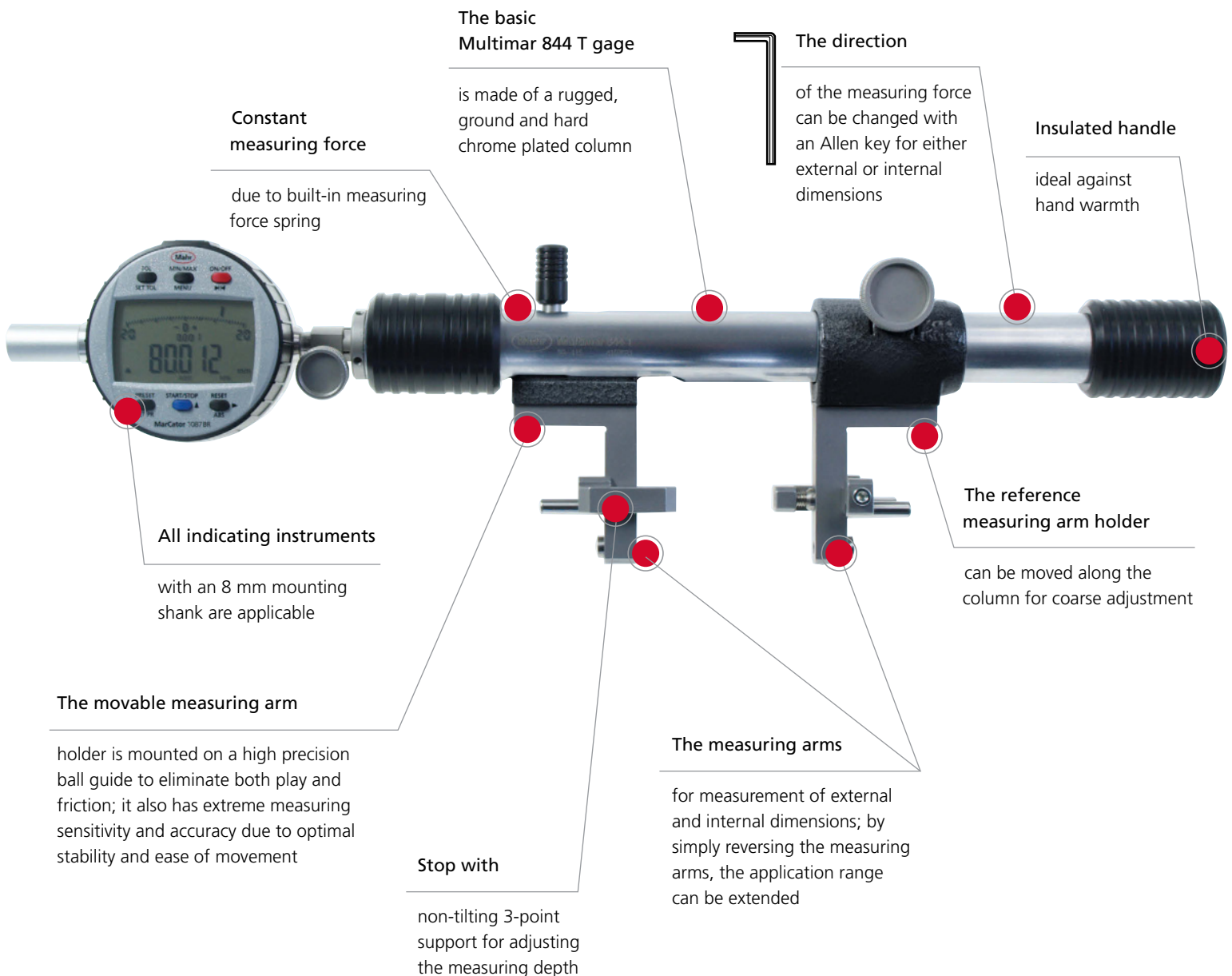

Multimar 844 T

Universal measuring instrument

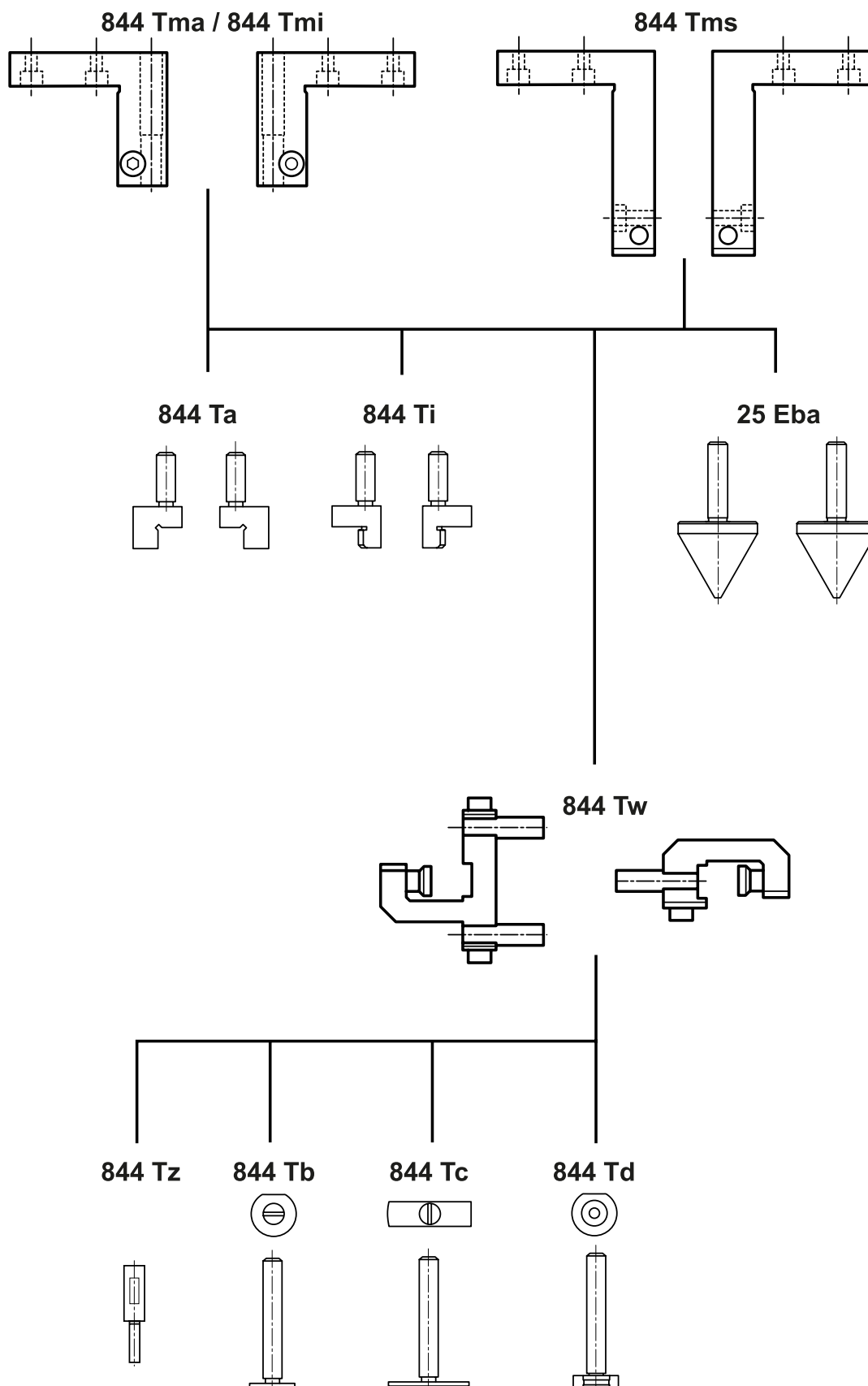

Multimar 844 T

Universal measuring instrument

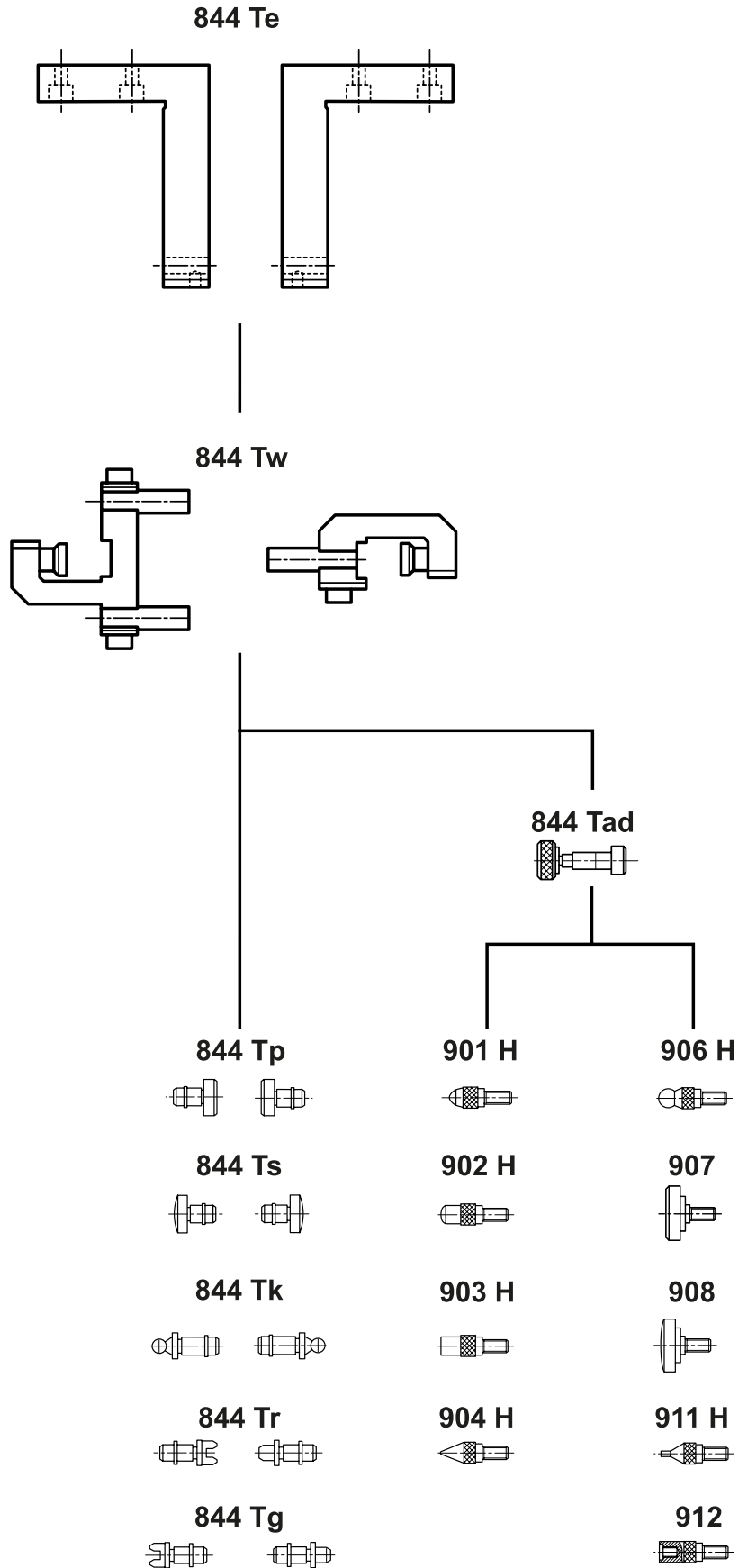

Multimar 844 T

Universal measuring instrument

FEATURES

- For easy adaptation to individual measuring tasks, optional accessories include:
 - Interchangeable measuring arms
 - Contact blocks
 - Stop elements
- The movable measuring arm carrier is mounted on a high precision ball bearing guide for reduced play and friction
 - Results in high measuring sensitivity, accuracy and free movement
- Stable support elements for repeatable measurements
- Constant measuring force with integrated measuring force spring
- Reversible measuring force direction for outside and inside measurement
- Highly stable, precision ground, hard chrome plated guide tube
- Lightweight construction with core made from carbon fiber reinforced plastic (CRP) tube, for measuring range 1000–1500 mm
- The stationary measuring arm holder can be moved along the guide tube and clamped for coarse adjustment
- **Package contains:** instruction manual, mounting and resting blocks, wooden case, excludes indicator, without arms/ attachments and anvils



Applications:

- External and internal measurement of lengths, widths, diameters, distances
- External and internal threads
- Centering shoulders, narrow collars, recesses and grooves
- External and internal tapers
- External and internal gears and more

TECHNICAL DATA

Order no.	Type	Application range outside	Application range inside	Measuring force	Probe path	Product weight
		mm	mm	N	mm	kg
4503001	844 T	0 –85	30 –115	5	12	0.78
4503002	844 T	80 –235	110 –265	5	12	1.01
4503003	844 T	230 –585	260 –615	5	12	1.59
4503004	844 T	580 –985	610 –1015	5	12	2.22
4503005	844 T	970 –1470	1000 –1500	10	12	2.52
4503006	844 T	1470 –1970	1500 –2000	10	12	2.68
4503007	844 T	1970 –2470	2000 –2500	10	12	2.86
4503008	844 T	2470 –2970	2500 –3000	10	12	3.26
4503009	844 T	2970 –3470	3000 –3500	10	12	3.43
4503010	844 T	3470 –3970	3500 –4000	10	12	3.62
4503011	844 T	3970 –4470	4000 –4500	10	12	3.81

Multimar 844 T

Universal measuring instrument

ACCESSORIES

Order no.	Description	Quantity unit	Type
4311000	Dial indicator, 0.01, 10 mm		810 S
4333000	Millimess 5 μm , $\pm 130 \mu\text{m}$		1004
4332000	Millimess 0.01, $\pm 0,25 \text{ mm}$		1010
4337662	Digital indicator, 0.0005 mm, 12.5 mm		1087 BR
4337664	Digital indicator, 0.0005 mm, 12.5 mm		1087 BRi
4503030	Mounting attachment	Pair	844 Tma
4503031	Mounting attachment	Pair	844 Tmi
4503024	Measuring arms, 25 mm	Pair	844 Te
4503025	Measuring arms, 35 mm	Pair	844 Te
4503026	Measuring arms, 70 mm	Pair	844 Te
4503027	Measuring arms, 100 mm	Pair	844 Te
4503040	Mounting attachments offset by 90°, 50 mm	Pair	844 Tms
4503041	Mounting attachments offset by 90°, 100 mm	Pair	844 Tms
4503109	Depth stops for 844 Tma, 844 Tmi, 844 Te	Pair	844 Tw
4503012	Guard bracket for display units		844 Tsb
4503020	Case for accessories		844 Tzb
4450512	Stand		844 Tf



810 S



1004



1087 BR



844 Tma

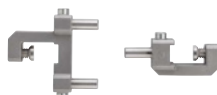

844 Tw

Multimar 844 Tw

Depth stops for 844 Tma, 844 Tmi, 844 Te

FEATURES

- Stops with stall protected 3-point support
- Hardened stop pins
- Interchangeable and adjustable
- **Package contents:**
 - 1 pair of stop pieces with 3 stop pins $\varnothing 5 \times 20$ mm
 - Additionally 1 stop pin each $\varnothing 5 \times 16$ mm and $\varnothing 5 \times 10$ mm for stop piece 1-point

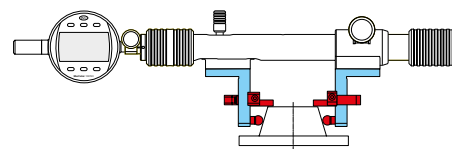
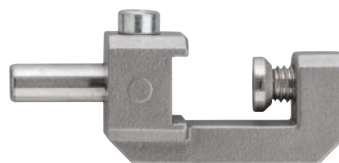
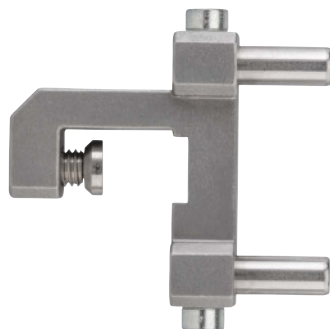

Applications:

- For adjustment of the measuring depth in horizontal measuring position
- Precise stops in one plane for repeatable measurements
- To be mounted on 844 Tma, 844 Tmi, 844 Te
- For easy setting of the measuring depth, a mm scale is engraved on the measuring arms 844 Tma, 844 Tmi and 844 Te
- For precise setting of the measuring depth (i.e. for taper measurements) gage blocks can be used

TECHNICAL DATA

Order no.	Type
4503109	844 Tw

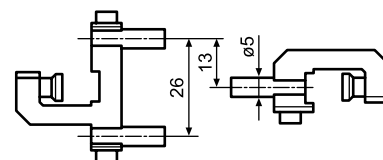

Multimar 844 Tma / 844 Tmi

Mounting attachment

FEATURES

- For outside (844 Tma) and inside diameters (844 Tmi)
- Stainless steel
- Lateral mm scale for easy positioning and adjustment of measuring limit stops
- Reversible measuring arms on measuring arm holders to increase the measuring range
- With $\varnothing 5$ mm mounting bore for inserting interchangeable 844 Ta, 844 Ti, 844 Tb, 844 Tc, 844 Td, 844 Tz and 844 Tv measuring anvils

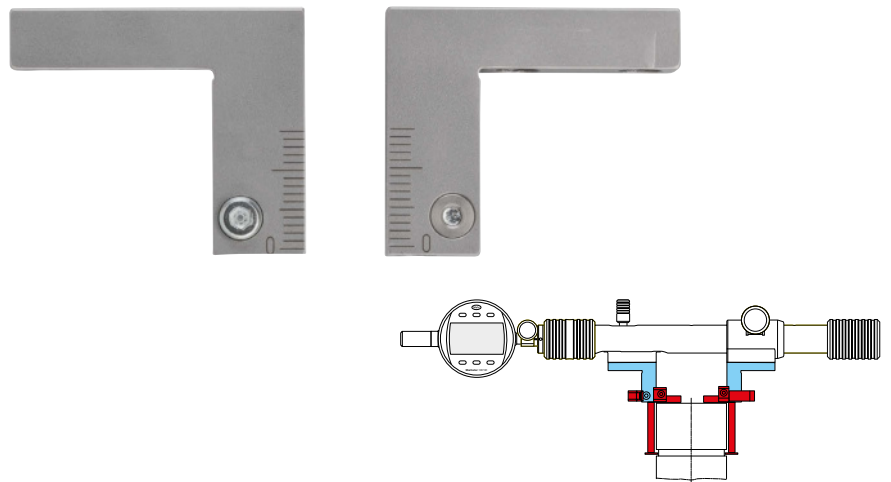

TECHNICAL DATA

Order no.	Mounting hole	Type
	mm	
4503030	5	844 Tma
4503031	5	844 Tmi

Order no.	a	b	Mounting hole
	mm	mm	mm
4503030	24	32	5
4503031	24	32	5

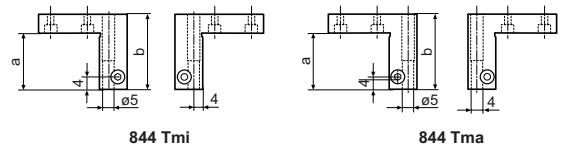

ACCESSORIES

Order no.	Description	Quantity unit	Type
4119010	Measuring tips for drill hole intervals, $\varnothing 2-20$ mm	Piece	25 Eba
4119011	Measuring tips for drill hole intervals, $\varnothing 10-40$ mm	Piece	25 Eba
4500050	Shoulder anvils, flat, hardened steel	Pair	844 Ta
4500055	Shoulder anvils, spherical, hardened steel	Pair	844 Ti
4503015	Measuring anvils with measuring blades, platelet diameter 11 mm, adjustment range 0–20 mm	Piece	844 Tb
4503016	Measuring anvils with measuring blades, platelet diameter 11 mm, adjustment range 20–40 mm	Piece	844 Tb
4503017	Anvils with round measuring faces, diameter 11 mm, adjustment range 0–20 mm	Piece	844 Td
4503018	Anvils with round measuring faces, diameter 11 mm, adjustment range 20–40 mm	Piece	844 Td
4503109	Depth stops for 844 Tma, 844 Tmi, 844 Te	Pair	844 Tw
4503114	Measuring anvils with measuring blades, platelet length 20 mm, adjustment range 0–20 mm	Piece	844 Tc
4503115	Measuring anvils with measuring blades, platelet length 20 mm, adjustment range 20–40 mm	Piece	844 Tc

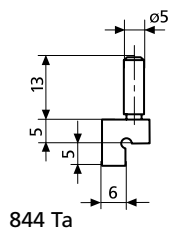

844 Ta

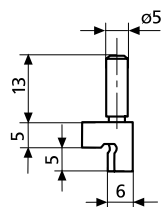

844 Ti

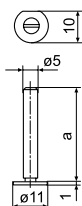

844 Tb

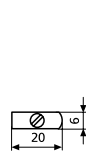

844 Tc

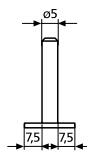

844 Td

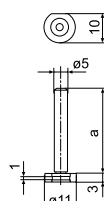

25 Eba

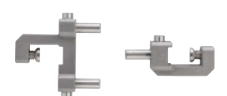

844 Tw

Multimar 844 Tms

Mounting attachments offset by 90°

FEATURES

- For outer and inner diameters
- Stainless steel
- Reversible measuring arms on measuring arm holders to increase the measuring range
- With $\varnothing 5$ mm holder for inserting interchangeable 844 Ta, 844 Ti, 844 Tb, 844 Tc, 844 Td, 844 Tz and 844 Tv measuring anvils

Applications:

- For measuring outer and inner dimensions with side probes:
 - In flat recesses
 - In holes with center hub
 - In holes with retracted drill rod

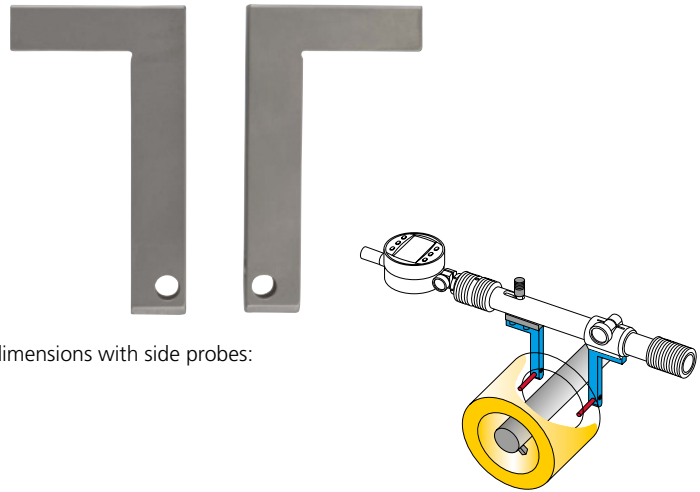

TECHNICAL DATA

Order no.	Mounting hole	Throat depth	Type
	mm	mm	
4503040	5	50	844 Tms
4503041	5	100	844 Tms

Order no.	b	Mounting hole
	mm	mm
4503040	12	5
4503041	12	5

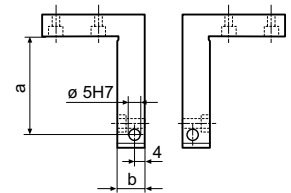

ACCESSORIES

Order no.	Description	Type
4500050	Shoulder anvils, flat, hardened steel	844 Ta
4500055	Shoulder anvils, spherical, hardened steel	844 Ti
4503015	Measuring anvils with measuring blades, platelet diameter 11 mm, adjustment range 0 –20 mm	844 Tb
4503016	Measuring anvils with measuring blades, platelet diameter 11 mm, adjustment range 20 –40 mm	844 Tb
4503017	Anvils with round measuring faces, diameter 11 mm, adjustment range 0 –20 mm	844 Td
4503018	Anvils with round measuring faces, diameter 11 mm, adjustment range 20 –40 mm	844 Td
4503114	Measuring anvils with measuring blades, platelet length 20 mm, adjustment range 0 –20 mm	844 Tc
4503115	Measuring anvils with measuring blades, platelet length 20 mm, adjustment range 20 –40 mm	844 Tc
4503119	Measuring anvils, ball diameter 6 mm, adjustment range 20 –40 mm	844 To

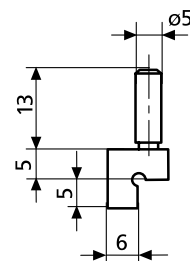

844 Ta

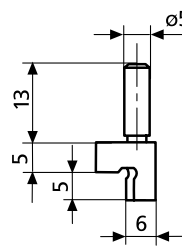

844 Ti

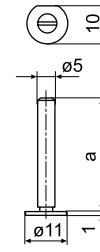

844 Tb

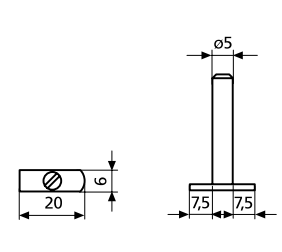

844 Tc

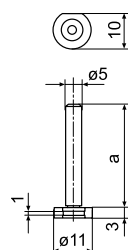

844 Td



844 To

Multimar 844 Ta

Shoulder anvils

FEATURES

- With cylindrical mounting shaft to attach into mounting attachments 844 Tma, 844 Tmi, 844 Tms
- Flat, for external diameter
- Made of hardened steel

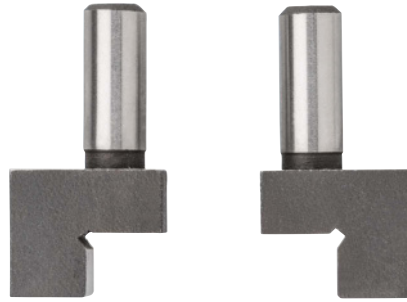

Application:

- For narrow collars such as centering shoulders and other similar measuring tasks

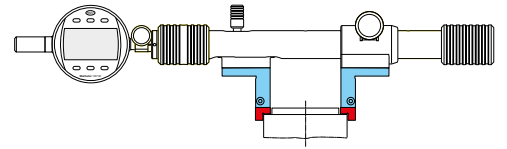

TECHNICAL DATA

Order no.	Mounting shaft diameter	Type
	mm	
4500050	5	844 Ta

Order no.	Mounting \varnothing d
	mm
4500050	5

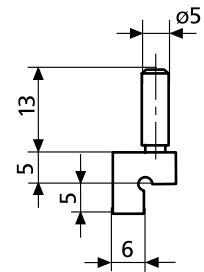

Multimar 844 Ti

Shoulder anvils

FEATURES

- With cylindrical mounting shaft to attach into mounting attachments 844 Tma, 844 Tmi, 844 Tms
- Semi-cylindrical, for internal diameters
- Made of hardened steel

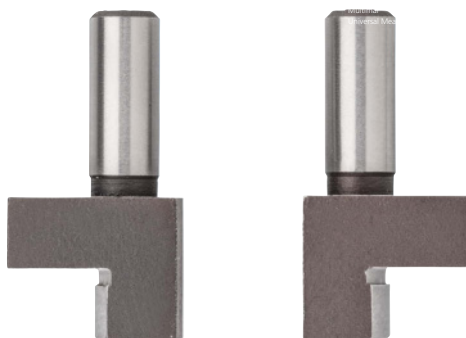

Application:

- For narrow collars such as centering shoulders and other similar measuring tasks

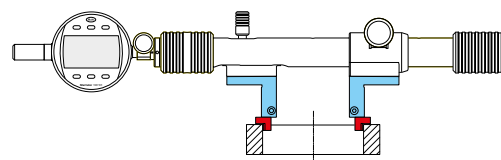

TECHNICAL DATA

Order no.	Mounting shaft diameter	Type
4500055	mm 5	844 Ti

Order no.	Mounting $\varnothing d$
4500055	mm 5

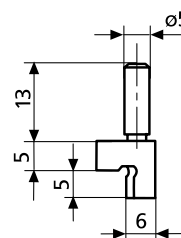

Multimar 844 Tb

Measuring anvils with measuring blades

FEATURES

- With cylindrical mounting shaft to attach into mounting attachments 844 Tma, 844 Tmi, 844 Tms
- Can be moved in the mounting attachment for setting the measuring depth
- With round measuring blade for inner and outer measurements
- Suitable for workpieces with narrow recesses up to 3 mm deep
- Made of hardened steel

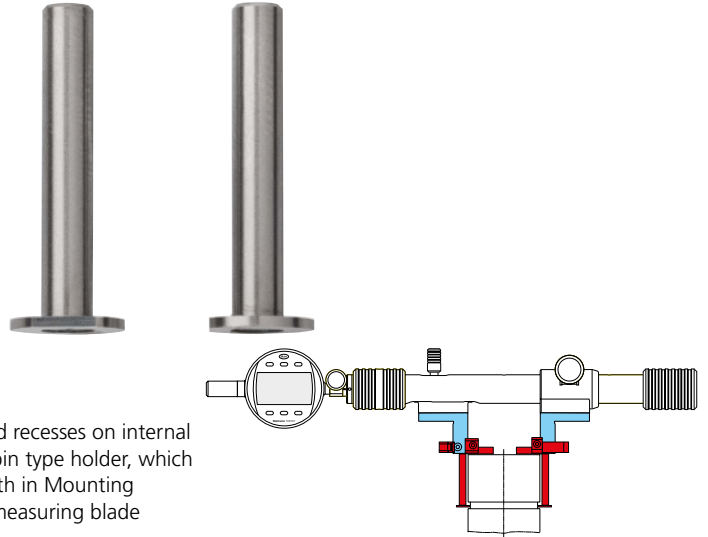

Application:

- For measuring centering shoulders and recesses on internal and external diameters; consists of a pin type holder, which is moved to set the measuring depth in Mounting Attachment 844 Tm and a mounted measuring blade

TECHNICAL DATA

Order no.	Adjustment range	Mounting shaft diameter	Type
	mm	mm	
4503015	0 –20	5	844 Tb
4503016	20 –40	5	844 Tb

Order no.	a	Mounting ϕ d
	mm	mm
4503015	30	5
4503016	50	5

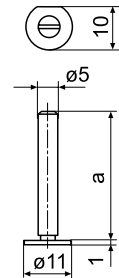

Multimar 844 Tc

Measuring anvils with measuring blades

FEATURES

- With cylindrical mounting shaft to attach into mounting attachments 844 844 Tma, 844 Tmi, 844 Tms
- Can be moved in the mounting attachment for setting the measuring depth
- With long measuring blade
- Suitable for workpieces with narrow recesses up to 7.5 mm deep
- Made of hardened steel

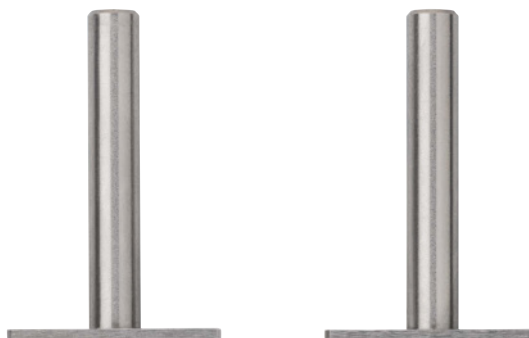

Application:

- For measuring centering shoulders and recesses on internal and external diameter

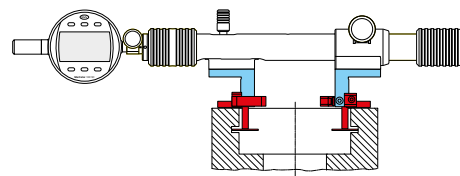

TECHNICAL DATA

Order no.	Adjustment range	Mounting shaft diameter	Type
	mm	mm	
4503114	0 – 20	5	844 Tc
4503115	20 – 40	5	844 Tc

Order no.	a	Mounting ϕ d
	mm	mm
4503114	30	5
4503115	50	5

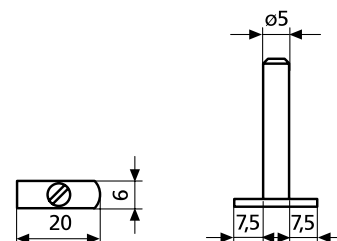

Multimar 844 Td

Anvils with round measuring faces

FEATURES

- With cylindrical mounting shaft to attach into mounting attachments 844 Tma, 844 Tmi, 844 Tms
- Made of hardened steel
- Can be moved in the mounting attachment for setting the measuring depth
- Circular probe for inner and outer measurements
 - Ø 11 mm spherical (R=8 mm)
 - Plane measuring surface (6 x 1 mm)



Application:

- For measuring internal and external dimensions on round or cylindrical parts

TECHNICAL DATA

Order no.	Adjustment range	Mounting shaft diameter	Type
	mm	mm	
4503017	0 –20	5	844 Td
4503018	20 –40	5	844 Td

Order no.	a	Mounting ø d
	mm	mm
4503017	30	5
4503018	50	5

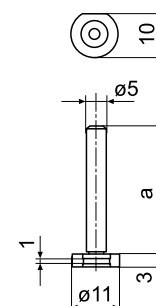

Multimar 844 Tz

Cylindrical measuring pins

FEATURES

- With cylindrical holding shaft for fixing in 844 Tma / 844 Tmi mounting attachments
- Made of hardened steel



Application:

- Determination of the dimension over 2 pins for inner and outer gears

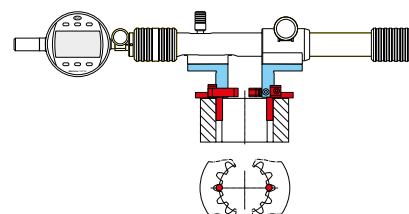

TECHNICAL DATA

Order no.	D	Mounting shaft diameter	Manufacturing tolerance +/-	Type
	mm	mm	µm	
4500500	1	5	2	844 Tz
4500501	1.25	5	2	844 Tz
4500502	1.5	5	2	844 Tz
4500503	1.75	5	2	844 Tz
4500504	2	5	2	844 Tz
4500506	2.5	5	2	844 Tz
4500507	3	5	2	844 Tz
4500508	3.5	5	2	844 Tz
4500509	4	5	2	844 Tz
4500510	4.5	5	2	844 Tz
4500511	5	5	2	844 Tz
4500512	5.5	5	2	844 Tz
4500513	6	5	2	844 Tz

Order no.	D	Dimension L	l	Mounting ø d
	mm	mm	mm	mm
4500500	1	19.5	6	5
4500501	1.25	19.5	6	5
4500502	1.5	19.5	6	5
4500503	1.75	23.5	10	5
4500504	2	23.5	10	5
4500506	2.5	23.5	10	5
4500507	3	28.5	15	5
4500508	3.5	28.5	15	5
4500509	4	28.5	15	5
4500510	4.5	33.5	20	5
4500511	5	33.5	20	5
4500512	5.5	33.5	20	5
4500513	6	33.5	20	5

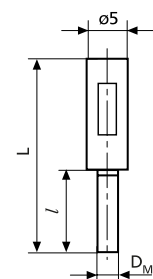

Multimar 844 Te

Measuring arms

FEATURES

- For outer and inner diameters
- Stainless steel
- Lateral mm scale for easy positioning and adjustment of measuring limit stops
- Reversible measuring arms on measuring arm holder to increase the measuring range
- 3.5 mm diameter holder for inserting interchangeable measuring anvils 844 Tp, 844 Ts, 844 Tk, 844 Tr and 844 Tg

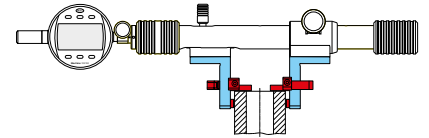

TECHNICAL DATA

Order no.	Mounting hole	Throat depth	Type
	mm	mm	
4503024	3.5	25	844 Te
4503025	3.5	35	844 Te
4503026	3.5	70	844 Te
4503027	3.5	100	844 Te

Order no.	b	Mounting hole
	mm	mm
4503024	6	3.5
4503025	10	3.5
4503026	10	3.5
4503027	12	3.5

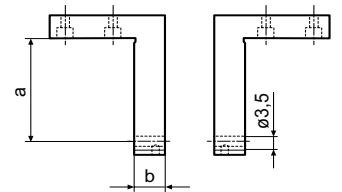

ACCESSORIES

Order no.	Description	Quantity unit	Type
4500040	Anvils for measuring arms, flat, hardened steel	Piece	844 Tp
4500045	Measuring anvils, spherical, hardened steel	Piece	844 Ts
4503080	Adapter \varnothing 3.5 - M2,5 for measuring arms 844 Te	Piece	844 Tad
4503109	Depth stops for 844 Tma, 844 Tmi, 844 Te	Pair	844 Tw

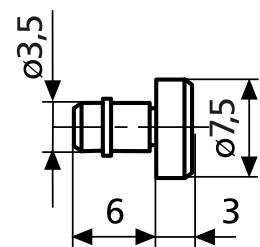

844 Tp

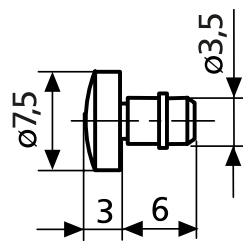

844 Ts

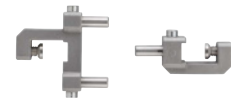

844 Tw

Multimar thread anvils

Measuring arms

FEATURES

- For pitch diameters
- Hardened, wear-resistant special steel
- With cylindrical mounting shank and retainer ring which ensures locking while permitting rotation in bore

ACCESSORIES

Thread pitch	Blade Order no.	Taper Order no.	V-anvil Order no.
Pitch diameter, external thread			
Metric 60°			
0.5 -0.7		4501000	4501200
0.7 -1		4501001	4501201
1.25 -2		4501002	4501202
2 -3.5		4501003	4501203
3.5 -5		4501004	4501204
5 -7		4501005	4501205

Trapezoid 30°			
1.5		4501151	4501351
2		4501152	4501352
3		4501153	4501353
4		4501154	4501354
5		4501155	4501355
6		4501156	4501356
7		4501157	4501357
8		4501158	4501358
9		4501159	4501359
10		4501160	4501360
12		4501161	4501361
14		4501162	4501362
16		4501163	4501363
18		4501164	4501364
20		4501165	4501365

Pitch diameter, internal thread			
Metric 60°			
0.5 -0.7	4174600	4174300	
0.7 -1	4174601	4174301	
1.25 -2	4174602	4174302	
2 -3.5	4174603	4174303	
3.5 -5	4174604	4174304	
5 -7	4174605	4174305	

Trapezoid 30°			
1,5	4501833	4501832	
2	4501835	4501834	
3	4501837	4501836	
4	4501839	4501838	
5	4501841	4501840	
6	4501843	4501842	
7	4501845	4501844	
8	4501847	4501846	
9	4501849	4501848	
10	4501851	4501850	
12	4174981	4174961	

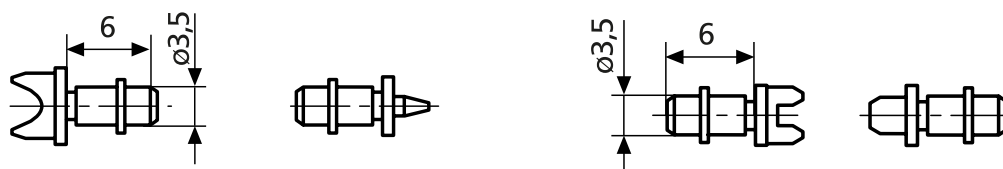

Multimar thread anvils

Measuring arms

FEATURES

- For pitch diameters
- Hardened, wear-resistant special steel
- With cylindrical mounting shank and retainer ring which ensures locking while permitting rotation in bore

ACCESSORIES

Thread pitch in TPI	Blade Order no.	Taper Order no.	V-anvil Order no.
Pitch diameter, external thread			
UST 60°			
40-32		4501018	4501418
32-24		4501019	4501419
24-18		4501020	4501420
18-14		4501021	4501421
14-10		4501022	4501422
10-7		4501023	4501423
7-4.5		4501024	4501424
4.5-3		4501025	4501425

Whitworth 55°			
40-32		4501007	4501207
32-24		4501008	4501208
24-18		4501009	4501209
18-14		4501010	4501210
14-10		4501011	4501211
10-7		4501012	4501212
7-4.5		4501013	4501213
4.5-3		4501014	4501214

Pitch diameter, internal thread			
UST 60°			
40-32	4174615	4174415	
32-24	4174616	4174416	
24-18	4174617	4174417	
18-14	4174618	4174418	
14-10	4174919	4174419	
10-7	4174620	4174420	
7-4.5	4174621	4174421	
4.5-3	4174622	4174422	

Whitworth 55°			
40-32	4174643	4174343	
32-24	4174644	4174344	
24-18	4174645	4174345	
18-14	4174646	4174346	



Multimar 844 Tp

Anvils for measuring arms

FEATURES

- Made of hardened steel
- With cylindrical mounting shank and retainer ring which allows free rotation inside the bore of measuring arms 844 Te

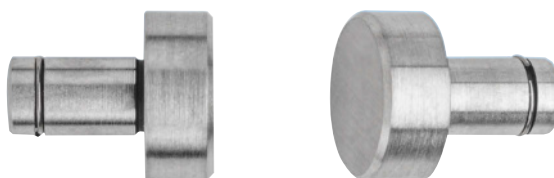

Application:

- Flat; for external diameters, distances and widths

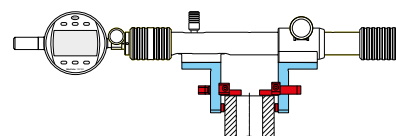

TECHNICAL DATA

Order no.	Mounting shaft diameter	Type
4500040	mm 3.5	844 Tp

Multimar 844 Ts

Measuring anvils

FEATURES

- Made of hardened steel
- With cylindrical mounting shank and retainer ring which allows free rotation inside the bore of measuring arms 844 Te



Application:

- Spherical; for internal diameters

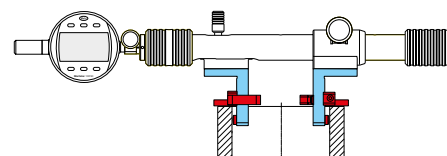

TECHNICAL DATA

Order no.	Mounting shaft diameter	Type
4500045	mm 3.5	844 Ts

Multimar 844 Tk

Ball anvil

FEATURES

- Measuring ball made of carbide
- With cylindrical mounting shank and retainer ring which allows free rotation inside the bore of measuring arms 844 Te
- Manufacturing tolerance ball $\pm 2 \mu\text{m}$



Applications:

- Especially suited for the measurement of internal or external helical gear wheels
- Use of convex contours
- Use for cone measurements

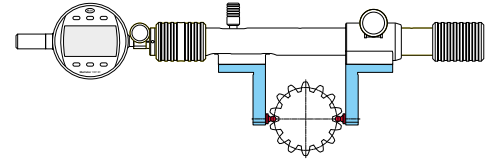

TECHNICAL DATA

Order no.	Mounting shaft diameter	Type
	mm	
4502620	3.5	844 Tk
4502621	3.5	844 Tk
4502622	3.5	844 Tk
4502623	3.5	844 Tk
4502624	3.5	844 Tk
4502625	3.5	844 Tk
4502626	3.5	844 Tk
4502627	3.5	844 Tk
4502628	3.5	844 Tk
4500350	3.5	844 Tk
4502629	3.5	844 Tk
4502630	3.5	844 Tk
4502631	3.5	844 Tk
4500351	3.5	844 Tk
4502632	3.5	844 Tk
4502633	3.5	844 Tk
4502634	3.5	844 Tk
4500352	3.5	844 Tk
4502635	3.5	844 Tk
4502636	3.5	844 Tk
4502637	3.5	844 Tk
4502638	3.5	844 Tk
4502639	3.5	844 Tk
4500353	3.5	844 Tk
4502640	3.5	844 Tk
4502641	3.5	844 Tk
4502642	3.5	844 Tk
4502643	3.5	844 Tk
4500354	3.5	844 Tk
4502543	3.5	844 Tk
4502540	3.5	844 Tk
4502644	3.5	844 Tk
4502544	3.5	844 Tk
4502645	3.5	844 Tk
4502646	3.5	844 Tk
4500356	3.5	844 Tk
4502647	3.5	844 Tk
4502648	3.5	844 Tk
4502649	3.5	844 Tk
4502650	3.5	844 Tk
4502651	3.5	844 Tk
4500618	3.5	844 Tk
4500357	3.5	844 Tk

Order no.	Mounting shaft diameter	Type
	mm	
4502652	3.5	844 Tk
4502541	3.5	844 Tk
4502653	3.5	844 Tk
4500358	3.5	844 Tk
4502654	3.5	844 Tk
4500359	3.5	844 Tk
4500360	3.5	844 Tk
4502655	3.5	844 Tk
4500361	3.5	844 Tk
4502656	3.5	844 Tk
4502657	3.5	844 Tk
4500362	3.5	844 Tk
4500363	3.5	844 Tk
4502658	3.5	844 Tk
4502545	3.5	844 Tk
4502542	3.5	844 Tk
4502547	3.5	844 Tk
4502548	3.5	844 Tk
4502549	3.5	844 Tk
4502550	3.5	844 Tk

Multimar 844 S

Setting device

FEATURES

- Simple handling via clamping element
- Accurate setting of nominal value using gage block combinations
- Instrument setting in horizontal or vertical position (using base 844 Sf)
- Rigid base made of anodized aluminum, for mobile or stationary use in production or in the inspection room
- **Package contains:** basic unit 844 S, instruction manual



Application:

- For setting indicating instruments for internal and external dimensions i. e. Multimar 844 T and Marameter 844 N at any dimension by using gage block combinations

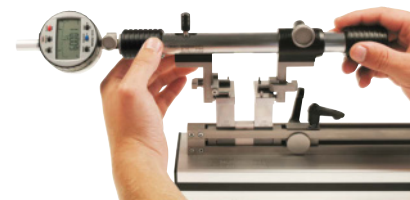

TECHNICAL DATA

Order no.		4503500	4503501	4503502
Type			844 S	
Application range, outside	mm	40–400	40–1150	40–2180
Application range, outside	inch	1.57"–15.8"	1.57"–45.2"	1.57"–85.8"
Application range, inside	mm	0–360	0–1110	0–2140
Application range, inside	inch	0"–14.1"	0"–43.7"	0"–84.2"

Order no.	Instrument dimensions (LxWxH)
4503500	520 x 80 x 40 mm
4503501	1270 x 80 x 40 mm
4503502	2300 x 80 x 80 mm

ACCESSORIES

Order no.	Description	Type
4503510	T-shaped gage blocks (20 mm) for measuring depth up to 40 mm	844 Sp
4503511	Riser blocks 30 mm for extended measuring depths	844 Sph
4474080	Adjustment bridge (70 x 12 mm), for measuring range 18–250 mm (for 844 N)	844 Neb
4474081	Adjustment bridge (165 x 17 mm), for measuring range 18–400 mm (for 844 N)	844 Neb
4470095	Measuring jaw (60 x 9,5 x 9 mm), for measuring range 18–800 mm (for 844 N)	844 em
4503512	Base for vertical use, including screws and table clamp	844 Sf
4474082	Adjustment bridge (320 x 20 mm), for measuring range 18–800 mm (for 844 N)	844 Neb



844 Sp



844 Sph



844 Neb



844 em

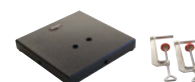

844 Sf

Multimar M36B-10 / M36B-20

Indicator gage

FEATURES

- Friction-free, zero-backlash measuring anvil holder for high measuring accuracy
- Parallel spring-loaded system for repeatable measuring force
- User-friendly and ergonomic:
 - Table surface can be tilted and clamped between 0° and 90°
 - Adjustable lifting of movable probe
- Adjustable measuring force
- **Package contents:** 3-part measuring anvil holder set, type JW-69 (mounting bore for 5 mm shaft), including standard steel measuring anvils and operating instructions

Applications:

- For measuring inside and outside dimensions: diameters, lengths, distances between bores, offsets, etc.
- Measurement in bores, outside surfaces, recesses, centering shoulders, etc.

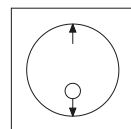

without centralizer

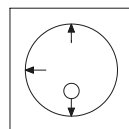

with centralizer

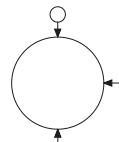

external



TECHNICAL DATA

Order no.		2003200	2003201	2050644	2050648
Type		M36B-10	M36B-20	36B-10M	36B-20M
Application range, outside	mm	6.5 – 125	6.5 – 222	6.5 – 125	6.5 – 222
Application range, outside	inch	.25 – 5"	.25 – 8.75"	.25 – 5"	.25 – 8.75"
Application range, inside	mm	20 – 130	20 – 197	20 – 130	20 – 197
Application range, inside	inch	.75 – 5.1"	.75 – 7.75"	.75 – 5.1"	.75 – 7.75"
Measuring force, adjustable	N	0 – 35			
Probe path, adjustable	mm	6 – 10 mm			
Probe path, adjustable	inch	.25 – .40"			
Indicating instrument (included in package)		None		IDS-317 indicator (Q11-RC)	

Order no.	Mounting hole
	mm
2003200	8
2003201	8
2050644	
2050648	

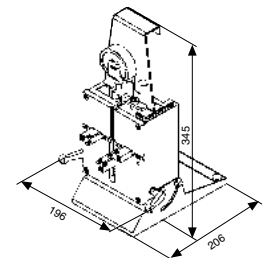

ACCESSORIES

Order no.	Description	Quantity unit	Type
4337662	Digital indicator, 0.0005 mm, 12.5 mm		1087 BR
4337664	Digital indicator, 0.0005 mm, 12.5 mm		1087 Bri
2220461	Set of measuring elements with measuring anvils made of hardened steel, for metric version M36B-10 / M36B-20	Set (3 Pc.)	JW-69
2225694	Separate measuring anvils for JW-69M / 2220461 measuring elements, made of hardened steel	Piece	PS-276
2220455	Jaw set of measuring elements, with measuring anvils made of carbide	Set (3 Pc.)	JW-58
2225676	Separate measuring anvils for JW-58 / 2003211 measuring elements, made of carbide	Piece	PS-226
4500050	Shoulder anvils, flat, hardened steel	Pair	844 Ta
4500055	Shoulder anvils, spherical, hardened steel	Pair	844 Ti
4503015	Measuring anvils with measuring blades, platelet diameter 11 mm, adjustment range 0 – 20 mm	Piece	844 Tb
4503114	Measuring anvils with measuring blades, platelet length 20 mm, adjustment range 0 – 20 mm	Piece	844 Tc
4503017	Anvils with round measuring faces, diameter 11 mm, adjustment range 0 – 20 mm	Piece	844 Td

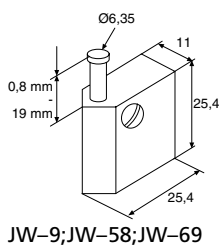

JW-9; JW-58; JW-69

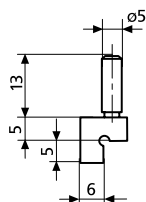

844 Ta



1087 BR

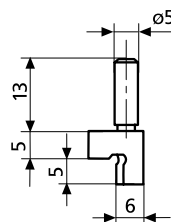

844 Ti



844 Tc

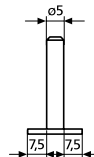

844 Tb

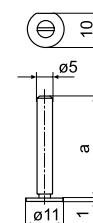

844 Tb

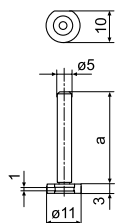

844 Td

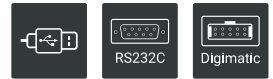

FEATURES

- Friction-free, zero-backlash measuring anvil holder for high measuring accuracy
- Parallel spring-loaded system for repeatable measuring force
- User-friendly and ergonomic:
 - Table surface can be tilted and clamped between 0° and 90°
 - Adjustable lifting of movable probe
- Adjustable measuring force
- **Data interface:** Digimatic, RS-232C, USB
- **Energy supply:** battery operation
- **Package contains:** set of jaws JW-9, instruction manual

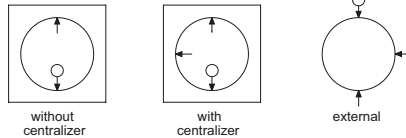

Applications:

- For measuring inner and outer diameters, centering shoulders, narrow collars and recesses
- Support plate with scale to help easily set the diameter
- Third measuring contact as lateral stop or centering device



TECHNICAL DATA

Order no.	2051693	2051695	2051863	2051864	2051873	2051874
Type	EDI-36B-10	EDI-36B-20	EMD-36B-10	EMD-36B-10D	EMD-36B-20	EMD-36B-20D
Application range, outside	mm 6 – 127	mm 6 – 222	mm 6 – 127		mm 6 – 222	
Application range, outside	inch .25 – 5"	inch .25 – 8.75"	inch .25 – 5"		inch .25 – 8.75"	
Application range, inside	mm 19 – 89	mm 19 – 197	mm 19 – 89		mm 19 – 197	
Application range, inside	inch .75 – 3.5"	inch .75 – 7.75"	inch .75 – 3.5"		inch .75 – 7.75"	
Measuring force, adjustable	N		0 – 35			
Probe path, adjustable	mm		6 – 10			
Probe path, adjustable	inch		.25 – .40"			
Indicating instrument (included in package)	2034201 µMaxµm II		2033109 Maxµm III	2033119 Maxµm III	2033109 Maxµm III	2033119 Maxµm III

ACCESSORIES

Order no.	Description	Type
2220455	Jaw set of measuring elements, with measuring anvils made of carbide	JW-58
2225702	Measuring anvil for JW-9, made of steel	PS-55
2225676	Separate measuring anvils for JW-58 / 2003211 measuring elements, made of carbide	PS-226

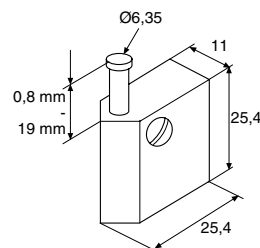

JW-9; JW-58;
JW-69

Multimar 36B-10 / 36B-20

Indicator gage

FEATURES

- Friction-free, zero-backlash measuring anvil holder for high measuring accuracy
- Parallel spring-loaded system for repeatable measuring force
- User-friendly and ergonomic:
 - Table surface can be tilted and clamped between 0° and 90°
 - Adjustable lifting of movable probe
- Adjustable measuring force
- **Data interface:** none
- **Package contains:** set of jaws JW-9, instruction manual

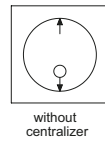

without centralizer

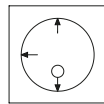

with centralizer

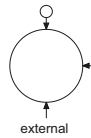

external

Applications:

- For measuring internal and external diameters, centering edges, narrow shoulders and recesses
- "T"-plates give a diameter reading directly across the diameter
- A third contact may be used as a side-stop or centralizer

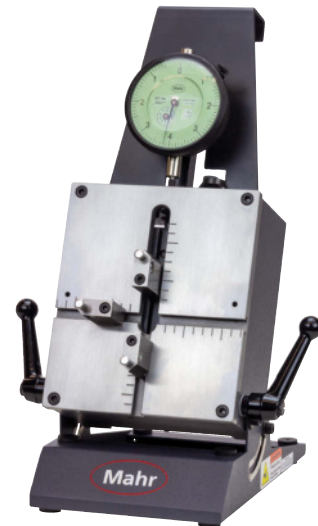

TECHNICAL DATA

Order no.		2050643	2050647
Type		36B-10	36B-20
Application range, outside	inch	.25 – 5"	.25 – 8.75"
Application range, inside	inch	.75 – 3.5"	.75 – 7.75"
Measuring force, adjustable	N	0 – 35	
Probe path, adjustable	inch	.25 – .40"	
Indicating instrument (included in package)		2011593 indicator (32I-RC)	

ACCESSORIES

Order no.	Description	Type
2220455	Jaw set of measuring elements, with measuring anvils made of carbide	JW-58
2225702	Measuring anvil for JW-9, made of steel	PS-55
2225676	Separate measuring anvils for JW-58 / 2003211 measuring elements, made of carbide	PS-226

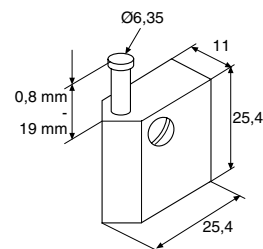

JW-9; JW-58;
JW-69



FEATURES

- Friction-free, zero-backlash measuring anvil holder for high measuring accuracy
- Parallel spring-loaded system for repeatable measuring force
- User-friendly and ergonomic:
 - Table surface can be tilted and clamped between 0° and 90°
 - Adjustable lifting of movable probe
- Adjustable measuring force
- **Data interface:** Digimatic, RS–232C, USB, wireless
- **Energy supply:** battery operation
- **Package contains:** set of jaws JW–9, instruction manual

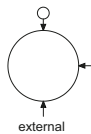
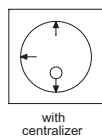
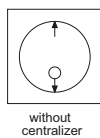

Applications:

- For measuring internal and external diameters, centering edges, narrow shoulders and recesses
- “T”-plates give a diameter reading directly across the diameter. A third contact may be used as a side-stop or centralizer
- “V”-plates are self-centralizing
- Three jaws are used and the measurement is of the distance between the sensitive contact and the chord formed by the two reference contacts. This measurement bears a direct relationship to the diameter and compensation is made by a special ratio indicator so diameter is read directly
- Used to inspect parts with odd number lobing conditions



TECHNICAL DATA

Order no.		2061657	2061658
Type		36B–10-VT	36B–20-VT
Application range, outside	mm	6–127	6–222
Application range, inside	mm	19–89	19–197
Measuring force, adjustable	N		0–35
Probe path, adjustable	mm		6–10 mm
Probe path, adjustable	inch		.25–.40"
Indicating instrument (included in package)			4337662 (1087 BR)

Order no.	Mounting hole
	mm
2061657	8
2061658	8

ACCESSORIES

Order no.	Description	Type
2220455	Jaw set of measuring elements, with measuring anvils made of carbide	JW–58
2225702	Measuring anvil for JW–9, made of steel	PS–55
2225676	Separate measuring anvils for JW–58 / 2003211 measuring elements, made of carbide	PS–226

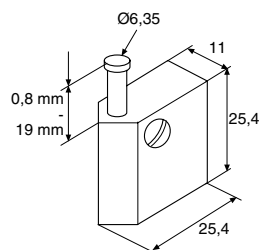

JW–9; JW–58;
JW–69

Multimar EDI-36B-19 / EDI-36B-9 / EMD-36B-19D / EMD-36B-9D

Indicator gage



FEATURES

- Friction-free, zero-backlash measuring anvil holder for high measuring accuracy
- Parallel spring-loaded system for repeatable measuring force
- User-friendly and ergonomic:
 - Table surface can be tilted and clamped between 0° and 90°
 - Adjustable lifting of movable probe
- Adjustable measuring force
- **Data interface:** Digimatic, RS-232C, USB
- **Energy supply:** battery operation
- **Package contains:** set of jaws JW-9, instruction manual

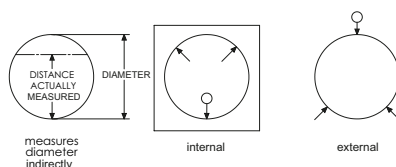

Applications:

- For measuring internal and external diameters, centering edges, narrow shoulders and recesses
- "V"-plates are self-centralizing
- Three jaws are used and the measurement is of the distance between the sensitive contact and the chord formed by the two reference contacts. This measurement bears a direct relationship to the diameter and compensation is made by a special ratio indicator so diameter is read directly
- Used to inspect parts with odd number lobing conditions



TECHNICAL DATA

Order no.		2051694	2051696	2051871	2051881
Type		EDI-36B-19	EDI-36B-9	EMD-36B-19D	EMD-36B-9D
Application range outside	mm	8 – 241	8 – 127	8 – 241	8 – 127
Application range, outside	inch	.312 – 9.5"	.312 – 5"	.312 – 9.5"	.312 – 5"
Application range inside	mm	21 – 229	21 – 117	21 – 229	21 – 117
Application range, inside	inch	.812 – 9"	.812 – 4.625"	.812 – 9"	.812 – 4.625"
Measuring force, adjustable	N	0 – 35			
Probe path, adjustable	mm	6 – 10 mm			
Probe path, adjustable	inch	.25 – .40"			
Indicating instrument (included in package)		2034201 μ Max μ m II		2033145 MaxumIII (special 4:5 ratio)	

ACCESSORIES

Order no.	Description	Type
2220455	Jaw set of measuring elements, with measuring anvils made of carbide	JW-58
2225702	Measuring anvil for JW-9, made of steel	PS-55
2225676	Separate measuring anvils for JW-58 / 2003211 measuring elements, made of carbide	PS-226

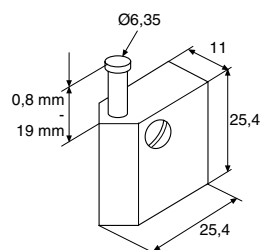

JW-9; JW-58;
JW-69

Multimar 36B-19 / 36B-9

Indicator gage

FEATURES

- Friction-free, zero-backlash measuring anvil holder for high measuring accuracy
- Parallel spring-loaded system for repeatable measuring force
- User-friendly and ergonomic:
 - Table surface can be tilted and clamped between 0° and 90°
 - Adjustable lifting of movable probe
- Adjustable measuring force
- **Data interface:** none
- **Package contains:** set of jaws JW-9, instruction manual

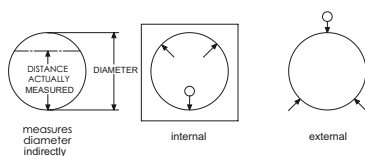

Application:

- For measuring internal and external diameters, centering edges, narrow shoulders and recesses



TECHNICAL DATA

Order no.		2050645	2050652
Type		36B-19	36B-9
Application range, outside	inch	.312 - 9.5"	.312 - 5"
Application range, inside	inch	.812 - 9"	.812 - 4.625"
Measuring force, adjustable	N	0 - 35	
Probe path, adjustable	inch	.25 - .40"	
Indicating instrument (included in package)		IDT-188 indicator (32K-RC)	

ACCESSORIES

Order no.	Description	Type
2220455	Jaw set of measuring elements, with measuring anvils made of carbide	JW-58
2225702	Measuring anvil for JW-9, made of steel	PS-55
2225676	Separate measuring anvils for JW-58 / 2003211 measuring elements, made of carbide	PS-226

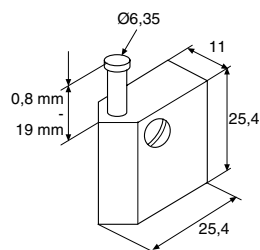

JW-9; JW-58;
JW-69

Multimar 36B–19M / 36B–9M

Indicator gage

FEATURES

- Friction-free, zero-backlash measuring anvil holder for high measuring accuracy
- Parallel spring-loaded system for repeatable measuring force
- User-friendly and ergonomic:
 - Table surface can be tilted and clamped between 0° and 90°
 - Adjustable lifting of movable probe
- Adjustable measuring force
- **Data interface:** none
- **Package contains:** set of jaws JW–9, instruction manual

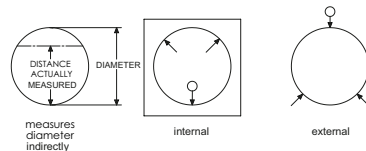

Application:

- For measuring internal and external diameters, centering edges, narrow shoulders and recesses



TECHNICAL DATA

Order no.	2050646	2050653
Type	36B–19M	36B–9M
Application range, outside	mm 8 –241	8 –127
Application range, inside	mm 21 –229	21 –117
Measuring force, adjustable	N	0 –35
Probe path, adjustable	mm	6 –10 mm
Indicating instrument (included in package)	IDS–318 indicator (Q21-RC)	

ACCESSORIES

Order no.	Description	Type
2220455	Jaw set of measuring elements, with measuring anvils made of carbide	JW–58
2225702	Measuring anvil for JW–9, made of steel	PS–55
2225676	Separate measuring anvils for JW–58 / 2003211 measuring elements, made of carbide	PS–226

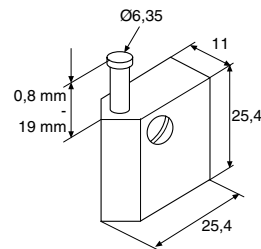

JW–9; JW–58;
JW–69

MarGage | Standards and gage blocks

Today, measurement standards such as parallel gage blocks still form the basis of dimensional metrology. Their applications range from setting gages for indicating measuring instruments to reference standards in calibration laboratories. We guarantee the highest possible quality due to careful selection of materials used and accreditation of the PTB.



Gage blocks

MarGage 402 / 404 / 405 / 406 / 408 / 409 / 412 / 413 **442**
Parallel gage block sets, steel

MarGage 411 / 415 **447**
Parallel gage block sets, steel, for caliper calibration

MarGage 402 C / 404 C / 405 C / 406 C / 408 C / 409 C **448**
Parallel gage block sets, ceramic

MarGage 418 C / 419 C **451**
Parallel gage block sets, ceramic, protective gage blocks and gage blocks for micrometer calibration

MarGage 417 **453**
Parallel gage blocks, individual, steel

MarGage 417 C **456**
Parallel gage blocks, individual, ceramic

Accessories for parallel gage blocks **459**

MarGage 421 **461**
Optical flats, plane-parallel inspection windows

Pin gages

MarGage 426 A **464**
Thread pin gages

MarGage 426 M / 426 MS **465**
Thread pin gages in holder

Setting standards

MarGage 355 E **467**
Setting rings

MarGage 390 **470**
Setting disks

MarGage 402 / 404

Rectangular gage block set made of steel

FEATURES

- Vertical arrangement to save space

Calibration class K

As primary factory standard, particularly for the calibration of subsidiary test laboratories, e.g. for gage blocks of lower tolerance classes.

Tolerance class 0

For maximum accuracy requirements. To be used as basic standards in test laboratories and precision inspection rooms, where other gage blocks and high accuracy measuring instruments are calibrated.

Tolerance class 1

For high accuracy requirements. As reference gage block for the measuring room. Designed to perform particularly accurate measurements. For setting indicating measuring instruments. For checking precision gages.

Tolerance class 2

For checking production gages of quality IT 6 and IT 7. For setting indicating measuring instruments and for checking accurate dimensions in the jig and tool industry.

- Package contains: wooden case with clear labeling strips, Mahr calibration certificate

- Coefficient of linear expansion: $11.5 \times 10^{-6} \text{ K}^{-1}$



TECHNICAL DATA

Order no.	Type	Quantity per set	Tolerance class	Nominal sizes	Increment	Number
				mm	mm	
4800400	402	32	0	1.005	-	1
				1.01–1.09	0.01	9
				1.1–1.9	0.1	9
				1–9	1	9
				10–30	10	3
				50	-	1
4800401	402	32	1	1.005	-	1
				1.01–1.09	0.01	9
				1.1–1.9	0.1	9
				1–9	1	9
				10–30	10	3
				50	-	1
4800402	402	32	2	1.005	-	1
				1.01–1.09	0.01	9
				1.1–1.9	0.1	9
				1–9	1	9
				10–30	10	3
				50	-	1
4800403DKS	402	32	K	1.005	-	1
				1.01–1.09	0.01	9
				1.1–1.9	0.1	9
				1–9	1	9
				10–30	10	3
				50	-	1
4800000	404	46	0	1.001–1.009	0.001	9
				1.01–1.09	0.01	9
				1.1–1.9	0.1	9
				1–9	1	9
				10–100	10	10
				Includes Mahr calibration certificate		
4800001	404	46	1	1.001–1.009	0.001	9
				1.01–1.09	0.01	9
				1.1–1.9	0.1	9
				1–9	1	9
				10–100	10	10
				Includes Mahr calibration certificate		
4800002	404	46	2	1.001–1.009	0.001	9
				1.01–1.09	0.01	9
				1.1–1.9	0.1	9
				1–9	1	9
				10–100	10	10
				Includes Mahr calibration certificate		
4800003DKS	404	46	K	1.001–1.009	0.001	9
				1.01–1.09	0.01	9
				1.1–1.9	0.1	9
				1–9	1	9
				10–100	10	10
				Includes DAkKS calibration certificate		



424

ACCESSORIES

Order no.	Description	Type
4800130	Gage block maintenance accessories	424
4800140	Optical flat, $\varnothing = 45 \text{ mm}$	421
4800142	Wooden tongs, single, to prevent heat transfer when handling gage blocks	423

MarGage 405 / 406

Rectangular gage block set made of steel

FEATURES

- Vertical arrangement to save space

Calibration class K

As primary factory standard, particularly for the calibration of subsidiary test laboratories, e.g. for gage blocks of lower tolerance classes.

Tolerance class 0

For maximum accuracy requirements. To be used as basic standards in test laboratories and precision inspection rooms, where other gage blocks and high accuracy measuring instruments are calibrated.

Tolerance class 1

For high accuracy requirements. As reference gage block for the measuring room. Designed to perform particularly accurate measurements. For setting indicating measuring instruments. For checking precision gages.

Tolerance class 2

For checking production gages of quality IT 6 and IT 7. For setting indicating measuring instruments and for checking accurate dimensions in the jig and tool industry.

- **Package contains:** wooden case with clear labeling strips, Mahr calibration certificate
- **Coefficient of linear expansion:** $11.5 \times 10^{-6} \text{ K}^{-1}$



TECHNICAL DATA

Order no.	Type	Quantity per set	Tolerance class	Nominal sizes	Increment	Number
		Pieces		mm	mm	
4800410	405	47	0	1.005	-	1
				1.01 – 1.19	0.01	19
				1.2 – 1.9	0.1	8
				1 – 9	1	9
				10 – 100	10	10
4800411	405	47	1	1.005	-	1
				1.01 – 1.19	0.01	19
				1.2 – 1.9	0.1	8
				1 – 9	1	9
				10 – 100	10	10
4800412	405	47	2	1.005	-	1
				1.01 – 1.19	0.01	19
				1.2 – 1.9	0.1	8
				1 – 9	1	9
				10 – 100	10	10
4800413DKS	405	47	K	1.005	-	1
				1.01 – 1.19	0.01	19
				1.2 – 1.9	0.1	8
				1 – 9	1	9
				10 – 100	10	10
4800010	406	87	0	0.5	-	1
				1.001 – 1.009	0.001	9
				1.01 – 1.49	0.01	49
				1 – 9.5	0.5	18
				10 – 100	10	10
4800011	406	87	1	0.5	-	1
				1.001 – 1.009	0.001	9
				1.01 – 1.49	0.01	49
				1 – 9.5	0.5	18
				10 – 100	10	10
4800012	406	87	2	0.5	-	1
				1.001 – 1.009	0.001	9
				1.01 – 1.49	0.01	49
				1 – 9.5	0.5	18
				10 – 100	10	10
4800014DKS	406	87	K	0.5	-	1
				1.001 – 1.009	0.001	9
				1.01 – 1.49	0.01	49
				1 – 9.5	0.5	18
				10 – 100	10	10



ACCESSORIES

Order no.	Description	Type
4800130	Gage block maintenance accessories	424
4800140	Optical flat, $\varnothing = 45 \text{ mm}$	421
4800142	Wooden tongs, single, to prevent heat transfer when handling gage blocks	423

MarGage 408 / 409

Rectangular gage block set made of steel

FEATURES

- Vertical arrangement to save space

Calibration class K

As primary factory standard, particularly for the calibration of subsidiary test laboratories, e.g. for gage blocks of lower tolerance classes.

Tolerance class 0

For maximum accuracy requirements. To be used as basic standards in test laboratories and precision inspection rooms, where other gage blocks and high accuracy measuring instruments are calibrated.

Tolerance class 1

For high accuracy requirements. As reference gage block for the measuring room. Designed to perform particularly accurate measurements. For setting indicating measuring instruments. For checking precision gages.

Tolerance class 2

For checking production gages of quality IT 6 and IT 7. For setting indicating measuring instruments and for checking accurate dimensions in the jig and tool industry.

- **Package contains:** wooden case with clear labeling strips, Mahr calibration certificate
- **Coefficient of linear expansion:** $11.5 \times 10^{-6} \text{ K}^{-1}$



TECHNICAL DATA

Order no.	Type	Quantity per set	Tolerance class	Nominal sizes	Increment	Number
		Pieces		mm	mm	
4800020	408	111	0	0.5	-	1
				1.001–1.009	0.001	9
				1.01–1.49	0.01	49
				1–24.5	0.5	48
				25–100	25	4
4800021	408	111	1	0.5	-	1
				1.001–1.009	0.001	9
				1.01–1.49	0.01	49
				1–24.5	0.5	48
				25–100	25	4
4800022	408	111	2	0.5	-	1
				1.001–1.009	0.001	9
				1.01–1.49	0.01	49
				1–24.5	0.5	48
				25–100	25	4
4800027DKS	408	111	K	0.5	-	1
				1.001–1.009	0.001	9
				1.01–1.49	0.01	49
				1–24.5	0.5	48
				25–100	25	4
4800030	409	121	0	0.5	-	1
				1.001–1.009	0.001	9
				1.01–1.49	0.01	49
				1.6–1.9	0.1	4
				1–24.5	0.5	48
				30. 40. 60. 70	10	6
				.80 .90	25	4
				25. 50. 75. 100		
4800031	409	121	1	0.5	-	1
				1.001–1.009	0.001	9
				1.01–1.49	0.01	49
				1.6–1.9	0.1	4
				1–24.5	0.5	48
				30. 40. 60. 70	10	6
				.80 .90	25	4
				25. 50. 75. 100		
4800032	409	121	2	0.5	-	1
				1.001–1.009	0.001	9
				1.01–1.49	0.01	49
				1.6–1.9	0.1	4
				1–24.5	0.5	48
				30. 40. 60. 70	10	6
				.80 .90	25	4
				25. 50. 75. 100		
4800033DKS	409	121	K	0.5	-	1
				1.001–1.009	0.001	9
				1.01–1.49	0.01	49
				1.6–1.9	0.1	4
				1–24.5	0.5	48
				30. 40. 60. 70	10	6
				.80 .90	25	4
				25. 50. 75. 100		



423



424

ACCESSORIES

Order no.	Description	Type
4800130	Gage block maintenance accessories	424
4800140	Optical flat, $\varnothing = 45 \text{ mm}$	421
4800142	Wooden tongs, single, to prevent heat transfer when handling gage blocks	423

MarGage

Rectangular gage block set made of steel

FEATURES

- Long used as the practical standards of dimensional measurement in precision manufacturing
- With accuracies, materials and manufacturing methods greatly refined, gage blocks are now of highest quality and precision
- Used as comparison reference and utilization standards in the field of length measurement
- For checking gages and measuring instruments
- Used individually or in combinations by wringing several blocks together
- Mahr gage blocks are available from stock individually and as full sets in inches (rectangular only)
- Sets are manufactured to Grade 0 only, which meet or exceed ASME B89.1.9–2002 specifications
- Offered in steel to suit a wide range of service conditions
 - Steel blocks are extremely stable, hardened to Rc 62 minimum, and processed through a thorough seasoning cycle to relieve internal stresses before lap finishing
- All block sets are serialized and supplied in a fitted storage case (certification priced separately)
- **Package contains:** wooden case with clear labeling strips



TECHNICAL DATA

Order no.	Quantity per set	Tolerance class	Nominal sizes	Increment	Number
	Pieces		inch	inch	
2176361	81	0	.1001" – .1009" .101" – .149" .050" – .950"	.0001" .001" .050"	9 49 19
		Includes Mahr calibration certificate	1.000" – 4.000"	1.00"	4
2176362	49	0	.1001" – .1009" .101" – .109" .010" – .090" .110" – .190" .100" – .900"	.0001" .001" .010" .010" .100"	9 9 9 9 9
		Includes Mahr calibration certificate	1.000" – 4.000"	1.00"	4

ACCESSORIES

Order no.	Description	Type
4800130	Gage block maintenance accessories	424
4800140	Optical flat, Ø = 45 mm	421
4800142	Wooden tongs, single, to prevent heat transfer when handling gage blocks	423

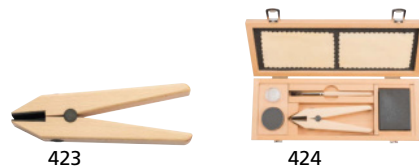

MarGage 412 / 413

Rectangular gage block set made of steel

FEATURES

- Vertical arrangement to save space

Calibration class K

As primary factory standard, particularly for the calibration of subsidiary test laboratories, e.g. for gage blocks of lower tolerance classes.

Tolerance class 0

For maximum accuracy requirements. To be used as basic standards in test laboratories and precision inspection rooms, where other gage blocks and high accuracy measuring instruments are calibrated.

Tolerance class 1

For high accuracy requirements. As reference gage block for the measuring room. Designed to perform particularly accurate measurements. For setting indicating measuring instruments. For checking precision gages.

Tolerance class 2

For checking production gages of quality IT 6 and IT 7. For setting indicating measuring instruments and for checking accurate dimensions in the jig and tool industry.

- Package contains: wooden case with clear labeling strips, Mahr calibration certificate
- Coefficient of linear expansion: $11.5 \times 10^{-6} \text{ K}^{-1}$



TECHNICAL DATA

Order no.	Type	Quantity per set	Tolerance class	Nominal sizes	Number
		Pieces		mm	
4800425	412	8	0	125 / 150 / 175 / 200 / 250 / 300 / 400 / 500	8
			Includes Mahr calibration certificate		
4800426	412	8	1	125 / 150 / 175 / 200 / 250 / 300 / 400 / 500	8
			Includes Mahr calibration certificate		
4800427	412	8	2	125 / 150 / 175 / 200 / 250 / 300 / 400 / 500	8
			Includes Mahr calibration certificate		
4800428DKS	412	8	K	125 / 150 / 175 / 200 / 250 / 300 / 400 / 500	8
			Includes DAkks calibration certificate		
4800430	413	5	0	600 / 700 / 800 / 900 / 1000	5
			Includes Mahr calibration certificate		
4800431	413	5	1	600 / 700 / 800 / 900 / 1000	5
			Includes Mahr calibration certificate		
4800432	413	5	2	600 / 700 / 800 / 900 / 1000	5
			Includes Mahr calibration certificate		
4800433DKS	413	5	K	600 / 700 / 800 / 900 / 1000	8
			Includes DAkks calibration certificate		

ACCESSORIES

Order no.	Description	Type
4800140	Optical flat, $\varnothing = 45 \text{ mm}$	421
4800180	Optical parallel, $\varnothing = 30 \text{ mm}$	421 P
4800142	Wooden tongs, single, to prevent heat transfer when handling gage blocks	423
4800130	Gage block maintenance accessories	424

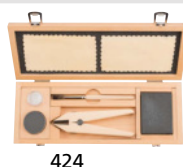
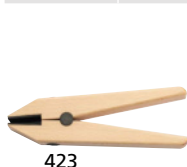

MarGage 411 / 415

Rectangular gage block set made of steel

FEATURES

- Vertical arrangement to save space

Tolerance class 1

For high accuracy requirements. As reference gage block for the measuring room. Designed to perform particularly accurate measurements. For setting indicating measuring instruments. For checking precision gages.

- **Package contains:** wooden case with clear labeling strips, Mahr calibration certificate
- **Coefficient of linear expansion:** $11.5 \times 10^{-6} \text{ K}^{-1}$



Application:

- For testing and calibrating calipers



TECHNICAL DATA

Order no.	Type	Quantity per set	Tolerance class	Nominal sizes	Number
		Pieces		mm	
4800343	411	5	1 Includes Mahr calibration certificate	30 / 41.3 / 131.4 / 243.5 / 281.2	5
4800344	411	5	2 Includes Mahr calibration certificate	30 / 41.3 / 131.4 / 243.5 / 281.2	5
4800339	415	6	1 Includes Mahr calibration certificate	30 / 41.3 / 131.4 / 243.5 / 281.2 / 481.1	6
4800340	415	6	2 Includes Mahr calibration certificate	30 / 41.3 / 131.4 / 243.5 / 281.2 / 481.1	6

MarGage 402 C / 404 C

Rectangular gage block set made of ceramic

FEATURES

- For use in metrology rooms as well as harsh workshop environments
- Practical properties: easy to slide, corrosion-free, no need to preserve, lightweight and very scratch-resistant
- **Corrosion-resistant:** ceramic is also highly resistant to lyes, acids, oil, grinding water and other aggressive media
- Damage to measuring surfaces from scratches or outbreaks causes no burring. The slide function and dimensional stability are retained
- **Extremely wear-resistant:** he longest idle periods and highest stability of all gage block materials. Allows for significantly longer gage monitoring intervals
- **Coefficient of expansion similar to that of steel:** therefore there are no usage restrictions, in manufacturing or in the laboratory, even in extreme temperature conditions
- Ceramic is antistatic, anti-magnetic and not electrically conductive

Calibration class K

As primary factory standard, particularly for the calibration of subsidiary test laboratories, e.g. for gage blocks of lower tolerance classes.

Tolerance class 0

For maximum accuracy requirements. To be used as basic standards in test laboratories and precision inspection rooms, where other gage blocks and high accuracy measuring instruments are calibrated.

Tolerance class 1

For high accuracy requirements. As reference gage block for the measuring room. Designed to perform particularly accurate measurements. For setting indicating measuring instruments. For checking precision gages.

Tolerance class 2

For checking production gages of quality IT 6 and IT 7. For setting indicating measuring instruments and for checking accurate dimensions in the jig and tool industry.

- **Package contains:** wooden case with clear labeling strips, Mahr calibration certificate

- **Coefficient of linear expansion:** $9.3 \times 10^{-6} \text{ K}^{-1}$



TECHNICAL DATA

Order no.	Type	Quantity per set	Tolerance class	Nominal sizes	Increment	Number
				mm	mm	
4800095	402 C	32	0	1.005	-	1
				1.01 – 1.09	0.01	9
				1.1 – 1.9	0.1	9
				1 – 9	1	9
				10 – 30	10	3
50	-	1				
4800096	402 C	32	1	1.005	-	1
				1.01 – 1.09	0.01	9
				1.1 – 1.9	0.1	9
				1 – 9	1	9
				10 – 30	10	3
50	-	1				
4800097	402 C	32	2	1.005	-	1
				1.01 – 1.09	0.01	9
				1.1 – 1.9	0.1	9
				1 – 9	1	9
				10 – 30	10	3
50	-	1				
4800094DKS	402 C	32	K	1.005	-	1
				1.01 – 1.09	0.01	9
				1.1 – 1.9	0.1	9
				1 – 9	1	9
				10 – 30	10	3
50	-	1				
4800008	404 C	46	0	1.001 – 1.009	0.001	9
				1.01 – 1.09	0.01	9
				1.1 – 1.9	0.1	9
				1 – 9	1	9
				10 – 100	10	10
4800009	404 C	46	1	1.001 – 1.009	0.001	9
				1.01 – 1.09	0.01	9
				1.1 – 1.9	0.1	9
				1 – 9	1	9
				10 – 100	10	10
4800004	404 C	46	2	1.001 – 1.009	0.001	9
				1.01 – 1.09	0.01	9
				1.1 – 1.9	0.1	9
				1 – 9	1	9
				10 – 100	10	10
4800088DKS	404 C	46	K	1.001 – 1.009	0.001	9
				1.01 – 1.09	0.01	9
				1.1 – 1.9	0.1	9
				1 – 9	1	9
				10 – 100	10	10

ACCESSORIES

Order no.	Description	Type
4800130	Gage block maintenance accessories	424
4800140	Optical flat, $\varnothing = 45 \text{ mm}$	421
4800142	Wooden tongs, single, to prevent heat transfer when handling gage blocks	423



423

424

MarGage 405 C / 406 C

Rectangular gage block set made of ceramic

FEATURES

- For use in metrology rooms as well as harsh workshop environments
- Practical properties: easy to slide, corrosion-free, no need to preserve, lightweight and very scratch-resistant
- **Corrosion-resistant:** ceramic is also highly resistant to lyes, acids, oil, grinding water and other aggressive media
- Damage to measuring surfaces from scratches or outbreaks causes no burring. The slide function and dimensional stability are retained
- **Extremely wear-resistant.** The longest idle periods and highest stability of all gage block materials. Allows for significantly longer gage monitoring intervals
- **Coefficient of expansion similar to that of steel:** therefore there are no usage restrictions, in manufacturing or in the laboratory, even in extreme temperature conditions
- Ceramic is antistatic, anti-magnetic and not electrically conductive

Calibration class K

As primary factory standard, particularly for the calibration of subsidiary test laboratories, e.g. for gage blocks of lower tolerance classes.

Tolerance class 0

For maximum accuracy requirements. To be used as basic standards in test laboratories and precision inspection rooms, where other gage blocks and high accuracy measuring instruments are calibrated.

Tolerance class 1

For high accuracy requirements. As reference gage block for the measuring room. Designed to perform particularly accurate measurements. For setting indicating measuring instruments. For checking precision gages.

Tolerance class 2

For checking production gages of quality IT 6 and IT 7. For setting indicating measuring instruments and for checking accurate dimensions in the jig and tool industry.

- **Package contains:** wooden case with clear labeling strips, Mahr calibration certificate

- **Coefficient of linear expansion:** $9.3 \times 10^{-6} \text{ K}^{-1}$



TECHNICAL DATA

Order no.	Type	Quantity per set	Tolerance class	Nominal sizes	Increment	Number
		Pieces		mm	mm	
4800420	405 C	47	0	1.005	-	1
				1.01 – 1.19	0.01	19
				1.2 – 1.9	0.1	8
				1 – 9	1	9
				10 – 100	10	10
4800421	405 C	47	1	1.005	-	1
				1.01 – 1.19	0.01	19
				1.2 – 1.9	0.1	8
				1 – 9	1	9
				10 – 100	10	10
4800422	405 C	47	2	1.005	-	1
				1.01 – 1.19	0.01	19
				1.2 – 1.9	0.1	8
				1 – 9	1	9
				10 – 100	10	10
4800423DKS	405 C	47	K	1.005	-	1
				1.01 – 1.19	0.01	19
				1.2 – 1.9	0.1	8
				1 – 9	1	9
				10 – 100	10	10
4800018	406 C	87	0	0.5	-	1
				1.001 – 1.009	0.001	9
				1.01 – 1.49	0.01	49
				1 – 9.5	0.5	18
				10 – 100	10	10
4800019	406 C	87	1	0.5	-	1
				1.001 – 1.009	0.001	9
				1.01 – 1.49	0.01	49
				1 – 9.5	0.5	18
				10 – 100	10	10
4800017	406 C	87	2	0.5	-	1
				1.001 – 1.009	0.001	9
				1.01 – 1.49	0.01	49
				1 – 9.5	0.5	18
				10 – 100	10	10
4800416DKS	406 C	87	K	0.5	-	1
				1.001 – 1.009	0.001	9
				1.01 – 1.49	0.01	49
				1 – 9.5	0.5	18
				10 – 100	10	10

ACCESSORIES

Order no.	Description	Type
4800130	Gage block maintenance accessories	424
4800140	Optical flat, $\varnothing = 45 \text{ mm}$	421
4800142	Wooden tongs, single, to prevent heat transfer when handling gage blocks	423



423



424

MarGage 408 C / 409 C

Rectangular gage block set made of ceramic

FEATURES

- For use in metrology rooms as well as harsh workshop environments
- Practical properties: easy to slide, corrosion-free, no need to preserve, lightweight and very scratch-resistant
- **Corrosion-resistant:** ceramic is also highly resistant to lyes, acids, oil, grinding water and other aggressive media
- Damage to measuring surfaces from scratches or outbreaks causes no burring. The slide function and dimensional stability are retained
- **Extremely wear-resistant:** the longest idle periods and highest stability of all gage block materials. Allows for significantly longer gage monitoring intervals
- **Coefficient of expansion similar to that of steel:** therefore there are no usage restrictions, in manufacturing or in the laboratory, even in extreme temperature conditions
- Ceramic is antistatic, anti-magnetic and not electrically conductive

Calibration class K

As primary factory standard, particularly for the calibration of subsidiary test laboratories, e.g. for gage blocks of lower tolerance classes.

Tolerance class 0

For maximum accuracy requirements. To be used as basic standards in test laboratories and precision inspection rooms, where other gage blocks and high accuracy measuring instruments are calibrated.

Tolerance class 1

For high accuracy requirements. As reference gage block for the measuring room. Designed to perform particularly accurate measurements. For setting indicating measuring instruments. For checking precision gages.

Tolerance class 2

For checking production gages of quality IT 6 and IT 7. For setting indicating measuring instruments and for checking accurate dimensions in the jig and tool industry.

- **Package contains:** wooden case with clear labeling strips, Mahr calibration certificate

- **Coefficient of linear expansion:** $9.3 \times 10^{-6} \text{ K}^{-1}$



TECHNICAL DATA

Order no.	Type	Quantity per set	Tolerance class	Nominal sizes		Increment	Number
				mm	mm		
4800028	408 C	111	0	0.5	-	0.001	1
				1.001 – 1.009	0.001		9
				1.01 – 1.49	0.01		49
				1 – 24.5	0.5		48
				25 – 100	25		4
4800029	408 C	111	1	0.5	-	0.001	1
				1.001 – 1.009	0.001		9
				1.01 – 1.49	0.01		49
				1 – 24.5	0.5		48
				25 – 100	25		4
4800026	408 C	111	2	0.5	-	0.001	1
				1.001 – 1.009	0.001		9
				1.01 – 1.49	0.01		49
				1 – 24.5	0.5		48
				25 – 100	25		4
4800025DKS	408 C	111	K	0.5	-	0.001	1
				1.001 – 1.009	0.001		9
				1.01 – 1.49	0.01		49
				1 – 24.5	0.5		48
				25 – 100	25		4
4800038	409 C	121	0	0.5	-	0.001	1
				1.001 – 1.009	0.001		9
				1.01 – 1.49	0.01		49
				1.6 – 1.9	0.1		4
				1 – 24.5	0.5		48
				30. 40. 60. 70	10		6
				.80 .90	25		4
25. 50. 75. 100							
4800039	409 C	121	1	0.5	-	0.001	1
				1.001 – 1.009	0.001		9
				1.01 – 1.49	0.01		49
				1.6 – 1.9	0.1		4
				1 – 24.5	0.5		48
				30. 40. 60. 70	10		6
				.80 .90	25		4
25. 50. 75. 100							
4800037	409 C	121	2	0.5	-	0.001	1
				1.001 – 1.009	0.001		9
				1.01 – 1.49	0.01		49
				1.6 – 1.9	0.1		4
				1 – 24.5	0.5		48
				30. 40. 60. 70	10		6
				.80 .90	25		4
25. 50. 75. 100							
4800036DKS	409 C	121	K	0.5	-	0.001	1
				1.001 – 1.009	0.001		9
				1.01 – 1.49	0.01		49
				1.6 – 1.9	0.1		4
				1 – 24.5	0.5		48
				30. 40. 60. 70	10		6
				.80 .90	25		4
25. 50. 75. 100							

ACCESSORIES

Order no.	Description	Type
4800130	Gage block maintenance accessories	424
4800140	Optical flat, Ø = 45 mm	421
4800142	Wooden tongs, single, to prevent heat transfer when handling gage blocks	423



MarGage 418 C

Rectangular gage block set made of ceramic

FEATURES

- For use in metrology rooms as well as harsh workshop environments
- Practical properties: easy to slide, corrosion-free, no need to preserve, lightweight and very scratch-resistant
- **Corrosion-resistant:** ceramic is also highly resistant to lyes, acids, oil, grinding water and other aggressive media
- Damage to measuring surfaces from scratches or outbreaks causes no burring. The slide function and dimensional stability are retained
- **Extremely wear-resistant:** the longest idle periods and highest stability of all gage block materials. Allows for significantly longer gage monitoring intervals
- **Coefficient of expansion similar to that of steel:** therefore there are no usage restrictions, in manufacturing or in the laboratory, even in extreme temperature conditions
- Ceramic is antistatic, anti-magnetic and not electrically conductive

Tolerance class 0

For maximum accuracy requirements. To be used as basic standards in test laboratories and precision inspection rooms, where other gage blocks and high accuracy measuring instruments are calibrated.

Tolerance class 1

For high accuracy requirements. As reference gage block for the measuring room. Designed to perform particularly accurate measurements. For setting indicating measuring instruments. For checking precision gages.

- **Package contains:** wooden case with clear labeling strips, Mahr calibration certificate
- **Coefficient of linear expansion:** $9.3 \times 10^{-6} \text{ K}^{-1}$

Application:

- Pair of protective gage blocks: As outer cover gage blocks where the same gage blocks are in frequent use



TECHNICAL DATA

Order no.	Type	Quantity per set	Tolerance class	Nominal sizes	Number
		Pieces		mm	
4800085	418 C	2	0	2	2
			Includes Mahr calibration certificate		
4800086	418 C	2	1	2	2
			Includes Mahr calibration certificate		

MarGage 419 C

Rectangular gage block set made of ceramic

FEATURES

- For use in metrology rooms as well as harsh workshop environments
 - Practical properties: easy to slide, corrosion-free, no need to preserve, lightweight and very scratch-resistant
 - **Corrosion-resistant:** ceramic is also highly resistant to lyes, acids, oil, grinding water and other aggressive media
 - Damage to measuring surfaces from scratches or outbreaks causes no burring. The slide function and dimensional stability are retained
 - **Extremely wear-resistant:** the longest idle periods and highest stability of all gage block materials. Allows for significantly longer gage monitoring intervals
 - **Coefficient of expansion similar to that of steel:** therefore there are no usage restrictions, in manufacturing or in the laboratory, even in extreme temperature conditions
- Ceramic is antistatic, anti-magnetic and not electrically conductive

Tolerance class 1

For high accuracy requirements. As reference gage block for the measuring room. Designed to perform particularly accurate measurements. For setting indicating measuring instruments. For checking precision gages.

- **Package contains:** wooden case with clear labeling strips, Mahr calibration certificate
- **Coefficient of linear expansion:** $9.3 \times 10^{-6} \text{ K}^{-1}$



Application:

- For testing and calibrating outside micrometers



TECHNICAL DATA

Order no.	Type	Quantity per set	Tolerance class	Nominal sizes	Number
		Pieces		mm	
4800090	419 C	10	1 Includes Mahr calibration certificate	2.5 / 5.1 / 7.7 / 10.3 / 12.9 / 15.0 / 17.6 / 20.2 / 22.8 / 25 + 421 P, ø 30 mm	10

MarGage 417/0

Rectangular gage blocks made of steel (Tolerance class 0)

FEATURES

- From nominal size 125 mm on, also supplied with wooden case
- Special sizes are available upon request
- Coefficient of linear expansion: $11.5 \times 10^{-6} \text{ K}^{-1}$



Nominal size mm	Order no.	Nominal size mm	Order no.	Nominal size mm	Order no.
0.5	4801009	1.28	4801056	12.5	4801104
0.55	4801173	1.29	4801057	13	4801105
0.6	4801174	1.3	4801058	13.5	4801106
0.65	4801175	1.31	4801059	14	4801107
0.7	4801176	1.32	4801060	14.5	4801108
0.75	4801177	1.33	4801061	15	4801109
0.8	4801178	1.34	4801062	15.5	4801110
0.85	4801179	1.35	4801063	16	4801111
0.9	4801180	1.36	4801064	16.5	4801112
0.95	4801181	1.37	4801065	17	4801113
1	4801019	1.38	4801066	17.5	4801114
1.0005	4801720	1.39	4801067	18	4801115
1.001	4801020	1.4	4801068	18.5	4801116
1.002	4801021	1.41	4801069	19	4801117
1.003	4801022	1.42	4801070	19.5	4801118
1.004	4801023	1.43	4801071	20	4801119
1.005	4801024	1.44	4801072	20.5	4801120
1.006	4801025	1.45	4801073	21	4801121
1.007	4801026	1.46	4801074	21.5	4801122
1.008	4801027	1.47	4801075	22	4801123
1.009	4801028	1.48	4801076	22.5	4801124
1.01	4801029	1.49	4801077	23	4801125
1.02	4801030	1.5	4801078	23.5	4801126
1.03	4801031	1.6	4801079	24	4801127
1.04	4801032	1.7	4801080	24.5	4801128
1.05	4801033	1.8	4801081	25	4801129
1.06	4801034	1.9	4801082	30	4801130
1.07	4801035	2	4801083	40	4801131
1.08	4801036	2.5	4801084	50	4801132
1.09	4801037	3	4801085	60	4801133
1.1	4801038	3.5	4801086	70	4801134
1.11	4801039	4	4801087	75	4801135
1.12	4801040	4.5	4801088	80	4801136
1.13	4801041	5	4801089	90	4801137
1.14	4801042	5.5	4801090	100	4801138
1.15	4801043	6	4801091	125	4801139
1.16	4801044	6.5	4801092	150	4801140
1.17	4801045	7	4801093	175	4801141
1.18	4801046	7.5	4801094	200	4801142
1.19	4801047	8	4801095	250	4801143
1.2	4801048	8.5	4801096	300	4801144
1.21	4801049	9	4801097	400	4801146
1.22	4801050	9.5	4801098	500	4801148
1.23	4801051	10	4801099	600	4801149
1.24	4801052	10.5	4801100	700	4801150
1.25	4801053	11	4801101	800	4801151
1.26	4801054	11.5	4801102	900	4801152
1.27	4801055	12	4801103	1000	4801153

MarGage 417/1

Rectangular gage blocks made of steel (Tolerance class 1)

FEATURES

- From nominal size 125 mm on, also supplied with wooden case
- Special sizes are available upon request
- Coefficient of linear expansion: $11.5 \times 10^{-6} \text{ K}^{-1}$



Nominal size mm	Order no.	Nominal size mm	Order no.	Nominal size mm	Order no.
0,5	4801209	1.3	4801258	14.5	4801308
0.55	4801358	1.31	4801259	15	4801309
0.6	4801359	1.32	4801260	15.5	4801310
0.65	4801360	1.33	4801261	16	4801311
0.7	4801361	1.34	4801262	16.5	4801312
0.75	4801362	1.35	4801263	17	4801313
0.8	4801363	1.36	4801264	17.5	4801314
0.85	4801364	1.37	4801265	18	4801315
0.9	4801365	1.38	4801266	18.5	4801316
0.95	4801366	1.39	4801267	19	4801317
1	4801219	1.4	4801268	19.5	4801318
1.0005	4801357	1.41	4801269	20	4801319
1.001	4801220	1.42	4801270	20.5	4801320
1.002	4801221	1.43	4801271	21	4801321
1.003	4801222	1.44	4801272	21.5	4801322
1.004	4801223	1.45	4801273	22	4801323
1.005	4801224	1.46	4801274	22.5	4801324
1.006	4801225	1.47	4801275	23	4801325
1.007	4801226	1.48	4801276	23.5	4801326
1.008	4801227	1.49	4801277	24	4801327
1.009	4801228	1.5	4801278	24.5	4801328
1.01	4801229	1.6	4801279	25	4801329
1.02	4801230	1.7	4801280	30	4801330
1.03	4801231	1.8	4801281	40	4801331
1.04	4801232	1.9	4801282	131.4	4803179
1.05	4801233	2	4801283	50	4801332
1.06	4801234	2.5	4801284	60	4801333
1.07	4801235	3	4801285	70	4801334
1.08	4801236	3.5	4801286	75	4801335
1.09	4801237	4	4801287	80	4801336
1.1	4801238	4.5	4801288	90	4801337
1.11	4801239	5	4801289	100	4801338
1.12	4801240	5.5	4801290	125	4801339
1.13	4801241	6	4801291	243.5	4803180
1.14	4801242	6.5	4801292	150	4801340
1.15	4801243	7	4801293	175	4801341
1.16	4801244	7.5	4801294	200	4801342
1.17	4801245	8	4801295	281.2	4803181
1.18	4801246	8.5	4801296	250	4801343
1.19	4801247	9	4801297	300	4801344
1.2	4801248	9.5	4801298	400	4801346
1.21	4801249	10	4801299	481.1	4803182
1.22	4801250	10.5	4801300	500	4801348
1.23	4801251	11	4801301	600	4801349
1.24	4801252	11.5	4801302	700	4801350
1.25	4801253	12	4801303	800	4801351
1.26	4801254	12.5	4801304	900	4801352
1.27	4801255	13	4801305	1000	4801353
1.28	4801256	13.5	4801306		
1.29	4801257	14	4801307		

MarGage 417/2

Rectangular gage blocks made of steel (Tolerance class 2)

FEATURES

- From nominal size 125 mm on, also supplied with wooden case
- Special sizes are available upon request
- Coefficient of linear expansion: $11.5 \times 10^{-6} \text{ K}^{-1}$



Nominal size mm	Order no.	Nominal size mm	Order no.	Nominal size mm	Order no.
0.5	4801409	1.3	4801458	14.5	4801508
0.55	4801777	1.31	4801459	15	4801509
0.6	4801778	1.32	4801460	15.5	4801510
0.65	4801779	1.33	4801461	16	4801511
0.7	4801780	1.34	4801462	16.5	4801512
0.75	4801781	1.35	4801463	17	4801513
0.8	4801782	1.36	4801464	17.5	4801514
0.85	4801783	1.37	4801465	18	4801515
0.9	4801784	1.38	4801466	18.5	4801516
0.95	4801785	1.39	4801467	19	4801517
1	4801419	1.4	4801468	19.5	4801518
1.0005	4803068	1.41	4801469	20	4801519
1.001	4801420	1.42	4801470	20.5	4801520
1.002	4801421	1.43	4801471	21	4801521
1.003	4801422	1.44	4801472	21.5	4801522
1.004	4801423	1.45	4801473	22	4801523
1.005	4801424	1.46	4801474	22.5	4801524
1.006	4801425	1.47	4801475	23	4801525
1.007	4801426	1.48	4801476	23.5	4801526
1.008	4801427	1.49	4801477	24	4801527
1.009	4801428	1.5	4801478	24.5	4801528
1.01	4801429	1.6	4801479	25	4801529
1.02	4801430	1.7	4801480	30	4801530
1.03	4801431	1.8	4801481	40	4801531
1.04	4801432	1.9	4801482	41.3	4803329
1.05	4801433	2	4801483	50	4801532
1.06	4801434	2.5	4801484	60	4801533
1.07	4801435	3	4801485	70	4801534
1.08	4801436	3.5	4801486	75	4801535
1.09	4801437	4	4801487	80	4801536
1.1	4801438	4.5	4801488	90	4801537
1.11	4801439	5	4801489	100	4801538
1.12	4801440	5.5	4801490	125	4801539
1.13	4801441	6	4801491	131.4	4803330
1.14	4801442	6.5	4801492	150	4801540
1.15	4801443	7	4801493	175	4801541
1.16	4801444	7.5	4801494	200	4801542
1.17	4801445	8	4801495	243.5	4803331
1.18	4801446	8.5	4801496	250	4801543
1.19	4801447	9	4801497	300	4801544
1.2	4801448	9.5	4801498	481.1	4803382
1.21	4801449	10	4801499	400	4801546
1.22	4801450	10.5	4801500	500	4801548
1.23	4801451	11	4801501	600	4801549
1.24	4801452	11.5	4801502	700	4801550
1.25	4801453	12	4801503	800	4801551
1.26	4801454	12.5	4801504	900	4801552
1.27	4801455	13	4801505	1000	4801553
1.28	4801456	13.5	4801506		
1.29	4801457	14	4801507		

MarGage 417 C/0

Rectangular gage blocks made of ceramic (Tolerance class 0)

FEATURES

- The outstanding properties of Mahr's ceramic parallel gage blocks offer enormous flexibility in day-to-day use. Ceramic end gages can be used without limitations both in inspection rooms and in the harsh workshop environment
- **Easy to handle:** no end gage material is easier to handle than ceramic - easy to slide, corrosion-free, no need for lubrication, lightweight and scratch-resistant
- **Resistant to impact and breakage:** damage to measuring surfaces from scratches or to edges from impact causes minimal burring. Therefore sliding ability is retained
- **Extremely wear-resistant:** the longest life and highest stability of any material currently used in measuring technology. Allows for significantly longer gage monitoring intervals
- **Corrosion-resistant:** ceramic is highly resistant to lyes, acids, oil, grinding water and other aggressive media, even without protective measures
- **Coefficient of expansion similar to that of steel:** therefore there are no usage restrictions, in manufacturing or in the laboratory, even in extreme temperature conditions
- **Non-magnetizable:** ceramic is antistatic, anti-magnetic and non-conductive. It does not attract dirt or dust and is suitable for use in the vicinity of magnetic fields
- **Coefficient of linear expansion:** $9.3 \times 10^{-6} \text{ K}^{-1}$



Nominal size mm	Order no.
0.5	4804000
1	4804010
1.0005	4804759
1.001	4804011
1.002	4804012
1.003	4804013
1.004	4804014
1.005	4804015
1.006	4804016
1.007	4804017
1.008	4804018
1.009	4804019
1.01	4804020
1.02	4804021
1.03	4804022
1.04	4804023
1.05	4804024
1.06	4804025
1.07	4804026
1.08	4804027
1.09	4804028
1.1	4804029
1.11	4804030
1.12	4804031
1.13	4804032
1.14	4804033
1.15	4804034
1.16	4804035
1.17	4804036
1.18	4804037
1.19	4804038
1.2	4804039
1.21	4804040
1.22	4804041
1.23	4804042
1.24	4804043
1.25	4804044
1.26	4804045
1.27	4804046
1.28	4804047
1.29	4804048
1.3	4804049

Nominal size mm	Order no.
1.31	4804050
1.32	4804051
1.33	4804052
1.34	4804053
1.35	4804054
1.36	4804055
1.37	4804056
1.38	4804057
1.39	4804058
1.4	4804059
1.41	4804060
1.42	4804061
1.43	4804062
1.44	4804063
1.45	4804064
1.46	4804065
1.47	4804066
1.48	4804067
1.49	4804068
1.5	4804069
1.6	4804070
1.7	4804071
1.8	4804072
1.9	4804073
2	4804074
2.5	4804075
3	4804076
3.5	4804077
4	4804078
4.5	4804079
5	4804080
5.5	4804081
6	4804082
6.5	4804083
7	4804084
7.5	4804085
8	4804086
8.5	4804087
9	4804088
9.5	4804089
10	4804090
10.5	4804091

Nominal size mm	Order no.
11	4804092
11.5	4804093
12	4804094
12.5	4804095
13	4804096
13.5	4804097
14	4804098
14.5	4804099
15	4804100
15.5	4804101
16	4804102
16.5	4804103
17	4804104
17.5	4804105
18	4804106
18.5	4804107
19	4804108
19.5	4804109
20	4804110
20.5	4804111
21	4804112
21.5	4804113
22	4804114
22.5	4804115
23	4804116
23.5	4804117
24	4804118
24.5	4804119
25	4804120
30	4804121
40	4804122
50	4804123
60	4804124
70	4804125
75	4804126
80	4804127
90	4804128
100	4804129

MarGage 417 C/1

Rectangular gage blocks made of ceramic (Tolerance class 1)

FEATURES

- The outstanding properties of Mahr's ceramic parallel gage blocks offer enormous flexibility in day-to-day use. Ceramic end gages can be used without limitations both in inspection rooms and in the harsh workshop environment
- **Easy to handle:** no end gage material is easier to handle than ceramic - easy to slide, corrosion-free, no need for lubrication, lightweight and scratch-resistant
- **Resistant to impact and breakage:** damage to measuring surfaces from scratches or to edges from impact causes minimal burring. Therefore sliding ability is retained
- **Extremely wear-resistant:** the longest life and highest stability of any material currently used in measuring technology. Allows for significantly longer gage monitoring intervals
- **Corrosion-resistant:** ceramic is highly resistant to lyes, acids, oil, grinding water and other aggressive media, even without protective measures
- **Coefficient of expansion similar to that of steel:** therefore there are no usage restrictions, in manufacturing or in the laboratory, even in extreme temperature conditions
- **Non-magnetizable:** ceramic is antistatic, anti-magnetic and non-conductive. It does not attract dirt or dust and is suitable for use in the vicinity of magnetic fields
- **Coefficient of linear expansion:** $9.3 \times 10^{-6} \text{ K}^{-1}$



Nominal size mm	Order no.
0.5	4804200
1	4804210
1.0005	4804764
1.001	4804211
1.002	4804212
1.003	4804213
1.004	4804214
1.005	4804215
1.006	4804216
1.007	4804217
1.008	4804218
1.009	4804219
1.01	4804220
1.02	4804221
1.03	4804222
1.04	4804223
1.05	4804224
1.06	4804225
1.07	4804226
1.08	4804227
1.09	4804228
1.1	4804229
1.11	4804230
1.12	4804231
1.13	4804232
1.14	4804233
1.15	4804234
1.16	4804235
1.17	4804236
1.18	4804237
1.19	4804238
1.2	4804239
1.21	4804240
1.22	4804241
1.23	4804242
1.24	4804243
1.25	4804244
1.26	4804245
1.27	4804246
1.28	4804247
1.29	4804248
1.3	4804249
1.31	4804250
1.32	4804251

Nominal size mm	Order no.
1.33	4804252
1.34	4804253
1.35	4804254
1.36	4804255
1.37	4804256
1.38	4804257
1.39	4804258
1.4	4804259
1.41	4804260
1.42	4804261
1.43	4804262
1.44	4804263
1.45	4804264
1.46	4804265
1.47	4804266
1.48	4804267
1.49	4804268
1.5	4804269
1.6	4804270
1.7	4804271
1.8	4804272
1.9	4804273
2	4804274
2.5	4804275
3	4804276
3.5	4804277
4	4804278
4.5	4804279
5	4804280
5.1	4804751
5.5	4804281
6	4804282
6.5	4804283
7	4804284
7.5	4804285
7.7	4804752
8	4804286
8.5	4804287
9	4804288
9.5	4804289
10	4804290
10.3	4804753
10.5	4804291

Nominal size mm	Order no.
11	4804292
11.5	4804293
12	4804294
12.5	4804295
12.9	4804754
13	4804296
13.5	4804297
14	4804298
14.5	4804299
15	4804300
15.5	4804301
16	4804302
16.5	4804303
17	4804304
17.5	4804305
17.6	4804755
18	4804306
18.5	4804307
19	4804308
19.5	4804309
20	4804310
20.2	4804756
20.5	4804311
21	4804312
21.5	4804313
22	4804314
22.5	4804315
22.8	4804757
23	4804316
23.5	4804317
24	4804318
24.5	4804319
25	4804320
30	4804321
40	4804322
41.3	4804758
50	4804323
60	4804324
70	4804325
75	4804326
80	4804327
90	4804328
100	4804329
131.4	4804760

MarGage 417 C/2

Rectangular gage blocks made of ceramic (Tolerance class 2)

FEATURES

- The outstanding properties of Mahr's ceramic parallel gage blocks offer enormous flexibility in day-to-day use. Ceramic end gages can be used without limitations both in inspection rooms and in the harsh workshop environment
- **Easy to handle:** no end gage material is easier to handle than ceramic - easy to slide, corrosion-free, no need for lubrication, lightweight and scratch-resistant
- **Resistant to impact and breakage:** damage to measuring surfaces from scratches or to edges from impact causes minimal burring. Therefore sliding ability is retained
- **Extremely wear-resistant:** the longest life and highest stability of any material currently used in measuring technology. Allows for significantly longer gage monitoring intervals
- **Corrosion-resistant:** ceramic is highly resistant to lyes, acids, oil, grinding water and other aggressive media, even without protective measures
- **Coefficient of expansion similar to that of steel:** therefore there are no usage restrictions, in manufacturing or in the laboratory, even in extreme temperature conditions
- **Non-magnetizable:** ceramic is antistatic, anti-magnetic and non-conductive. It does not attract dirt or dust and is suitable for use in the vicinity of magnetic fields
- **Coefficient of linear expansion:** $9.3 \times 10^{-6} \text{ K}^{-1}$



Nominal size mm	Order no.
0.5	4804400
1	4804410
1.0005	4804765
1.001	4804411
1.002	4804412
1.003	4804413
1.004	4804414
1.005	4804415
1.006	4804416
1.007	4804417
1.008	4804418
1.009	4804419
1.01	4804420
1.02	4804421
1.03	4804422
1.04	4804423
1.05	4804424
1.06	4804425
1.07	4804426
1.08	4804427
1.09	4804428
1.1	4804429
1.11	4804430
1.12	4804431
1.13	4804432
1.14	4804433
1.15	4804434
1.16	4804435
1.17	4804436
1.18	4804437
1.19	4804438
1.2	4804439
1.21	4804440
1.22	4804441
1.23	4804442
1.24	4804443
1.25	4804444
1.26	4804445
1.27	4804446
1.28	4804447
1.29	4804448
1.3	4804449
1.31	4804450
1.32	4804451

Nominal size mm	Order no.
1.33	4804452
1.34	4804453
1.35	4804454
1.36	4804455
1.37	4804456
1.38	4804457
1.39	4804458
1.4	4804459
1.41	4804460
1.42	4804461
1.43	4804462
1.44	4804463
1.45	4804464
1.46	4804465
1.47	4804466
1.48	4804467
1.49	4804468
1.5	4804469
1.6	4804470
1.7	4804471
1.8	4804472
1.9	4804473
2	4804474
2.5	4804475
3	4804476
3.5	4804477
4	4804478
4.5	4804479
5	4804480
5.1	4806114
5.5	4804481
6	4804482
6.5	4804483
7	4804484
7.5	4804485
7.7	4806115
8	4804486
8.5	4804487
9	4804488
9.5	4804489
10	4804490
10.3	4806116
10.5	4804491
11	4804492

Nominal size mm	Order no.
11.5	4804493
12	4804494
12.5	4804495
12.9	4806117
13	4804496
13.5	4804497
14	4804498
14.5	4804499
15	4804500
15.5	4804501
16	4804502
16.5	4804503
17	4804504
17.5	4804505
17.6	4806118
18	4804506
18.5	4804507
19	4804508
19.5	4804509
20	4804510
20.2	4806119
20.5	4804511
21	4804512
21.5	4804513
22	4804514
22.5	4804515
22.8	4806120
23	4804516
23.5	4804517
24	4804518
24.5	4804519
25	4804520
30	4804521
40	4804522
41.3	4806121
50	4804523
60	4804524
70	4804525
75	4804526
80	4804527
90	4804528
100	4804529
131.4	4806122

MarGage 420

Gage block holder and measuring jaws accessory set

FEATURES

- To be used in conjunction with gage blocks for gaging both workpieces and fixtures
- Package contains: wooden case

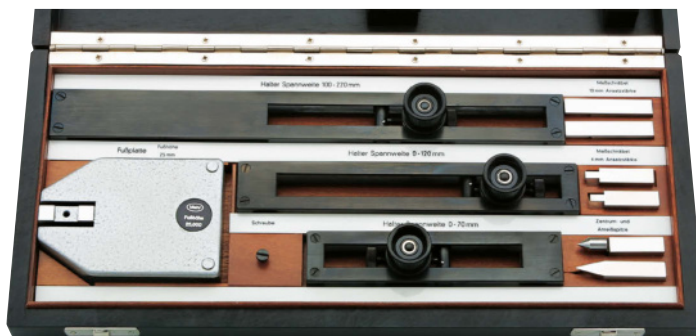

Application:

- To measure and calibrate setting gages and measuring instruments
- For scribing and marking

TECHNICAL DATA

Order no.	Type
4800100	420

ACCESSORIES

Order no.	Description	Type
4800110	Hemispherical measuring jaws, approach 2 x 2 mm = 4 mm	420 m
4800111	Hemispherical measuring jaws, approach 2 x 5 mm = 10 mm	420 m
4800112	Scriber tip	420 a
4800113	Centering point	420 z
4800114	Stand	420 f
4800120	Holder, span width 0 –70 mm	420 h
4800121	Holder, span width 0 –120 mm	420 h
4800122	Holder, span width 100 –220 mm	420 h
4800123	Holder, span width 100 –420 mm	420 h
4800124	Holder, span width 400 –820 mm	420 h

MarGage 424

Gage block maintenance accessories

FEATURES

The main tools for testing and repairing parallel gage blocks:

Optical flat 421

- For checking the flatness of the measuring surface by the interference method, Ø 45 mm

Wooden tongs 423

- For heat-insulation when holding parallel gage blocks
 - **Granite lapping plate**
 - For removing ridges and damage from gage block surfaces.
High-precision model
 - **Special Vaseline tin**
 - For anti-corrosive protection of parallel steel gage blocks
 - **Brush and suede cloth**
 - For cleaning the parallel gage blocks
- Package contains: case



TECHNICAL DATA

Order no.	Type
4800130	424

ACCESSORIES

Order no.	Description	Type
4800142	Wooden tongs, single, to prevent heat transfer when handling gage blocks	423



423

MarGage 421

Optical flat

FEATURES

- Package contains: case

Application:

- For testing the flatness of high precision measuring surfaces (by the interference method) on gage blocks and measuring equipment and on precision components with similarly challenging surfaces



TECHNICAL DATA

Order no.	Type	Diameter	Thickness	Flatness deviation
4800135	421	mm 100	mm 20	μm 0.1
4800140	421	45	11	0.1

MarGage 421 P

Optical parallel

FEATURES

- Package contains: case

Application:

- For simultaneous testing of parallelism and flatness of plan measuring surfaces of outside micrometers and snap gages by interference method



TECHNICAL DATA

Order no.	Type	Diameter	Thickness	Flatness deviation	Parallelism deviation
4800180	421 P	30	12	0.15	0.3

MarGage 421 PS

Optical parallels

FEATURES

- Package contains: case



Application:

- For simultaneous testing of parallelism and flatness of planar measuring surfaces of outside micrometers and indicating snap gages by the interference method
- 4 different thicknesses, for parallelism testing in different spindle settings (rotating spindles)



TECHNICAL DATA

Order no.	Type	Diameter	Measuring range	Nominal size	Flatness deviation	Parallelism deviation	Quantity per set
		mm	mm	mm	µm	µm	Pieces
4800185	421 PS	30	0–25 mm / 0–1"	12	0.15	0.3	4
4800186	421 PS	30	25–50 mm / 1–2"	25	0.15	0.3	4
4800187	421 PS	30	50–75 mm / 2–3"	50	0.15	0.5	4
4800188	421 PS	30	75–100 mm / 3–4"	75	0.15	0.5	4

MarGage 426 A

Thread pin gage

FEATURES

- To hang above the testpiece
- Set consists of 3 pin gages
- Manufacturing tolerance $\pm 0.5 \mu\text{m}$
- Pin gage length: 32 mm



Application:

- For determining pitch diameter of external threads according to the three wire method

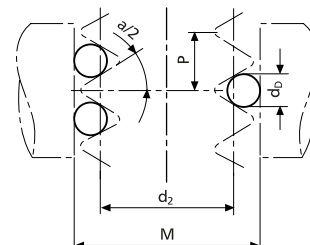

TECHNICAL DATA

Order no.	Type	Diameter	Metric	Whitworth range per 1 inch	UST heats per 1 inch	Trapezoid	Manufacturing tolerance +/-
		mm	mm	TPI	TPI	mm	μm
4821000	426 A	0.17	0.25 / 0.3				0.5
4821001	426 A	0.195			80		0.5
4821002	426 A	0.22	0.35		72		0.5
4821003	426 A	0.25	0.4		64		0.5
4821004	426 A	0.29	0.45 / 0.5		56		0.5
4821005	426 A	0.335	0.6		48		0.5
4821006	426 A	0.39		40	44 / 40		0.5
4821007	426 A	0.455	0.7 / 0.75 / 0.8	32	36		0.5
4821008	426 A	0.53		28	32 / 28		0.5
4821009	426 A	0.62	1	26 / 24	24		0.5
4821010	426 A	0.725	1.25	22 / 20	20		0.5
4821011	426 A	0.895	1.5	19 / 18 / 16	18		0.5
4821012	426 A	1.1	1.75	14	16 / 14 / 13		0.5
4821013	426 A	1.35	2	12 / 11	12 / 11		0.5
4821014	426 A	1.65	2.5	10 / 9	10 / 9	3	0.5
4821015	426 A	2.05	3 / 3.5	8 / 7	8 / 7	4	0.5
4821016	426 A	2.55	4 / 4.5	6	6	5	0.5
4821017	426 A	3.2	5 / 5.5	5 / 4.5	5 / 4.5	6	0.5
4821018	426 A	4	6	4 / 3.5	4	7	0.5

MarGage 426 M

Thread pin gages, holder pair

FEATURES

- For determining the pitch diameter of external threads by the three-wire method
- In conjunction with outside micrometers, indicating measuring instruments or measuring machines
- Each pair consists of one holder with 1 pin gage and one holder with 2 pin gages
- Holder has a satin chrome finish, the retainer ring can be locked yet the rotating spindle can still rotate
- Pin gages are hardened and lapped - freely floating in holder to allow proper positioning and contact with thread flanks
- Manufacturing tolerance $\pm 0.5 \mu\text{m}$
- Mounting bore 6.35 mm = 1/4", 8 mm on request)
- For threads with outer diameter up to 95 mm

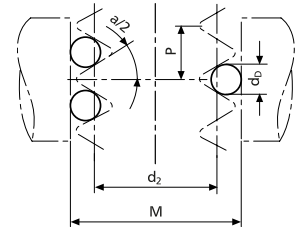
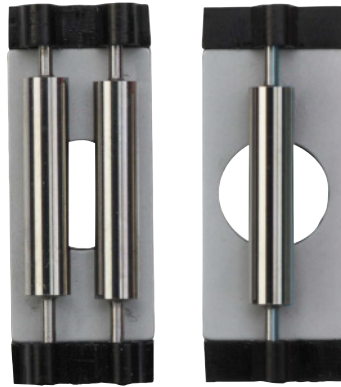

TECHNICAL DATA

Order no.	Type	Mounting hole	Diameter	Metric	Whitworth range per 1 inch	UST heats per 1 inch	Trapezoid
			mm	mm			mm
4820010	426 M	7.5 mm	0.17	0.25 / 0.3			
4820011	426 M	7.5 mm	0.195			80	
4820012	426 M	7.5 mm	0.22	0.35		72	
4820013	426 M	7.5 mm	0.25	0.4		64	
4820014	426 M	7.5 mm	0.29	0.45 / 0.5		56	
4820015	426 M	7.5 mm	0.335	0.6		48	
4820016	426 M	7.5 mm	0.39		40	44 / 40	
4820017	426 M	7.5 mm	0.455	0.7 / 0.75 / 0.8	32	36	
4820018	426 M	7.5 mm	0.53		28	32 / 28	
4820019	426 M	7.5 mm	0.62	1	26 / 24	24	
4820020	426 M	7.5 mm	0.725	1.25	22 / 20	20	
4820021	426 M	7.5 mm	0.895	1.5	19 / 18 / 16	18	
4820022	426 M	7.5 mm	1.1	1.75	14	16 / 14 / 13	
4820023	426 M	7.5 mm	1.35	2	12 / 11	12 / 11	
4820024	426 M	7.5 mm	1.65	2.5	10 / 9	10 / 9	3
4820025	426 M	7.5 mm	2.05	3 / 3.5	8 / 7	8 / 7	4
4820026	426 M	7.5 mm	2.55	4 / 4.5	6	6	5
4820027	426 M	7.5 mm	3.2	5 / 5.5	5 / 4.5	5 / 4.5	6
4820028	426 M	7.5 mm	4	6	4 / 3.5	4	7
4820131	426 M	6.5 mm	0.25	0.4		64	
4820132	426 M	6.5 mm	0.17	0.25 / 0.3			
4820133	426 M	6.5 mm	0.22	0.35		72	
4820134	426 M	6.5 mm	0.29	0.45 / 0.5		56	
4820135	426 M	6.5 mm	0.335	0.6		48	
4820137	426 M	6.5 mm	0.455	0.7 / 0.75 / 0.8	32	36	
4820139	426 M	6.5 mm	0.62	1	26 / 24	24	
4820140	426 M	6.5 mm	0.725	1.25	22 / 20	20	
4820141	426 M	6.5 mm	0.895	1.5	19 / 18 / 16	18	
4820142	426 M	6.5 mm	1.1	1.75	14	16 / 14 / 13	
4820143	426 M	6.5 mm	1.35	2	12 / 11	12 / 11	
4820144	426 M	6.5 mm	1.65	2.5	10 / 9	10 / 9	3
4820145	426 M	6.5 mm	2.05	3 / 3.5	8 / 7	8 / 7	4
4820146	426 M	6.5 mm	2.55	4 / 4.5	6	6	5
4820147	426 M	6.5 mm	3.2	5 / 5.5	5 / 4.5	5 / 4.5	6
4820149	426 M	6.5 mm	0.195			80	
4820150	426 M	6.5 mm	0.39			44 / 40	
4820151	426 M	6.5 mm	0.53			32 / 28	
4820152	426 M	6.5 mm	4	6			7

MarGage 426 MS

Thread pin gages set

FEATURES

- Set of thread pin gages in holder consists of: 18 holder pairs 426 M
- Diameter 0.17 – 3.2 mm
- For threads with outside diameter up to 95 mm
- Package contains: wooden case

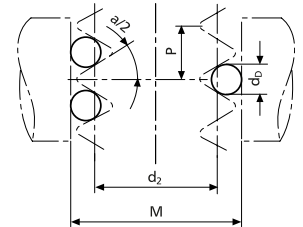

TECHNICAL DATA

Order no.	Type	Mounting hole
		mm
4820000	426 MS	7.5 mm
4820002	426 MS	8.0 mm
4820003	426 MS	6.5 mm
4820004	426 MS	6.35 mm

MarGage 355 E

Ring gage with tolerance class

FEATURES

- Wear-resistant special gage steel
- Hardened and lapped
- Structural dimensions: DIN 2250, version C
- Manufacturing tolerance: DIN 2250 (JS4)
- Uncertainty of the actual size: 1/2 IT 1

Diameter mm	Order no.	Diameter mm	Order no.
1	4710006	52	4710072
2	4710010	53	4710073
3	4710014	54	4710074
4	4710018	55	4710075
5	4710020	56	4710076
6	4710022	57	4710077
7	4710024	58	4710078
8	4710026	59	4710079
9	4710028	60	4710080
10	4710030	61	4710081
11	4710031	62	4710082
12	4710032	63	4710083
13	4710033	64	4710084
14	4710034	65	4710085
15	4710035	66	4710086
16	4710036	67	4710087
17	4710037	68	4710088
18	4710038	69	4710089
19	4710039	70	4710090
20	4710040	71	4710091
21	4710041	72	4710092
22	4710042	73	4710093
23	4710043	74	4710094
24	4710044	75	4710095
25	4710045	76	4710096
26	4710046	77	4710097
27	4710047	78	4710098
28	4710048	79	4710099
29	4710049	80	4710100
30	4710050	81	4710101
31	4710051	82	4710102
32	4710052	83	4710103
33	4710053	84	4710104
34	4710054	85	4710105
35	4710055	86	4710106
36	4710056	87	4710107
37	4710057	88	4710108
38	4710058	89	4710109
39	4710059	90	4710110
40	4710060	91	4710111
41	4710061	92	4710112
42	4710062	93	4710113
43	4710063	94	4710114
44	4710064	95	4710115
45	4710065	96	4710116
46	4710066	97	4710117
47	4710067	98	4710118
48	4710068	99	4710119
49	4710069	100	4710120
50	4710070	125	4710121
51	4710071	175	4710122



MarGage 355 E

Ring gage with tolerance class

FEATURES

- Wear-resistant special gage steel
- Hardened and lapped
- Structural dimensions: DIN 2250, version C
- Manufacturing tolerance: DIN 2250 (JS4)
- Uncertainty of the actual size: 1/2 IT 1
- Gradation 1 mm
- Please specify diameter when placing order

Ø mm	Order no.
101 –105	4714201
106 –110	4714202
111 –115	4714203
116 –120	4714204
121 –124	4714205
126 –130	4714206
131 –135	4714207
136 –140	4714208
141 –145	4714209
146 –150	4714210
151 –155	4714211
156 –160	4714212
161 –165	4714213
166 –170	4714214
171 –174	4714215
176 –180	4714216
181 –185	4714217
186 –190	4714218
191 –195	4714219
196 –200	4714220



MarGage 355 E

Ring gage with tolerance class

FEATURES

- Wear-resistant special gage steel
- Hardened and lapped
- Structural dimensions: DIN 2250, version C
- Manufacturing tolerance: DIN 2250 (JS4)
- Uncertainty of the actual size: 1/2 IT 1
- Gradation 0.001 mm
- Please specify diameter when placing order

Ø mm	Order no.
1 –1.8	4732600
1.801 –3	4732641
3.001 –5	4732642
5.001 –10	4732635
10.001 –15	4732602
15.001 –20	4732603
20.001 –25	4732604
25.001 –32	4732605
32.001 –35	4732606
35.001 –40	4732607
40.001 –45	4732608
45.001 –50	4732609
50.001 –55	4732610
55.001 –60	4732611
60.001 –65	4732612
65.001 –70	4732613
70.001 –75	4732614
75.001 –80	4732615
80.001 –85	4732616
85.001 –90	4732617
90.001 –95	4732618
95.001 –100	4732619
100.001 –105	4732620
105.001 –110	4732636
110.001 –115	4732621
115.001 –120	4732637
120.001 –125	4732622
125.001 –130	4732638
130.001 –135	4732623
135.001 –140	4732639
140.001 –145	4732624
145.001 –150	4732640
150.001 –155	4732625
155.001 –160	4732626
160.001 –165	4732627
165.001 –170	4732628
170.001 –175	4732629
175.001 –180	4732630
180.001 –185	4732631
185.001 –190	4732632
190.001 –195	4732633
195.001 –200	4732634



MarGage 390

Setting disc with tolerance class

FEATURES

- Wear-resistant special gage steel
- Hardened and lapped
- Manufacturing tolerance:
 $\pm 1/2$ IT 2
- Uncertainty of the actual size:
 $1/2$ IT 1
- The ideal setting standards for the Marameter 840 F and 300 P indicating snap gage families

Diameter mm	Order no.
10	4717030
11	4717031
12	4717032
13	4717033
14	4717034
15	4717035
16	4717036
17	4717037
18	4717038
19	4717039
20	4717040
21	4717041
22	4717042
23	4717043
24	4717044
25	4717045
26	4717046
27	4717047
28	4717048
29	4717049
30	4717050
31	4717051
32	4717052
33	4717053
34	4717054
35	4717055
36	4717056
37	4717057
38	4717058
39	4717059
40	4717060
41	4717061
42	4717062
43	4717063
44	4717064
45	4717065
46	4717066
47	4717067
48	4717068
49	4717069
50	4717070
51	4717071
52	4717072
53	4717073
54	4717074
55	4717075
56	4717076
57	4717077
58	4717078
59	4717079
60	4717080
61	4717081
62	4717082
63	4717083
64	4717084
65	4717085
66	4717086
67	4717087
68	4717088



MarGage 390

Setting disc with tolerance class

Diameter mm	Order no.
69	4717089
70	4717090
71	4717091
72	4717092
73	4717093
74	4717094
75	4717095
76	4717096
77	4717097
78	4717098
79	4717099
80	4717100
81	4717101
82	4717102
83	4717103
84	4717104
85	4717105
86	4717106
87	4717107
88	4717108
89	4717109
90	4717110
91	4717111
92	4717112
93	4717113
94	4717114
95	4717115
96	4717116
97	4717117
98	4717118
99	4717119
100	4717120

MarGage 390

Setting disc with tolerance class

FEATURES

- Wear-resistant special gage steel
- Hardened and lapped
- Manufacturing tolerance:
 $\pm 1/2$ IT 2
- Uncertainty of the actual size:
 $1/2$ IT 1
- The ideal setting standards for
the Marameter 840 F and 300 P
indicating snap gage families
- Gradation 0.001 mm
- Please specify diameter
when placing order

\varnothing mm	Order no.
10.001 –14	4719900
14.001 –20	4719901
20.001 –30	4719902
30.001 –40	4719903
40.001 –50	4719904
50.001 –60	4719905
60.001 –70	4719906
70.001 –80	4719907
80.001 –90	4719908
90.001 –100	4719909



Digimar | Height measuring instruments

Whether it's simply scribing a workpiece or completing complex measurements in two dimensions – Digimar guarantees maximum flexibility and quality. Our motorized height measuring instruments are simple to operate and provide a high level of measuring convenience and reliability.



Digimar overview	474
Height measuring instruments	
Digimar 817 CLT	476
Height measuring instrument	
Digimar 816 CL	477
Height measuring instrument	
Digimar accessories	478
Digimar 814 N	485
With cast base	
Digimar 814 G	487
With granite table plate	
Digimar 814 SR	489
Height measuring and scribing instruments	

Digimar 817 CLT: Easy measurements using intuitive touch control



Best connection for secure data

Data can be transferred wirelessly or via USB cable via the MarConnect interface. Quickly print out a series of measurements with an available Bluetooth printer. Simply choose between complete measuring records in PDF format or save your measuring records as a TXT file.



Interfaces for dial indicators

An interface integrated in the slide enables the error-free measurement of the perpendicularity and straightness using the new Millimes 2000/2001W dial comparators.



Ergonomics that can be measured

Ergonomics means that the methods, processes, and arrangement are designed for people and not the other way around. This is exactly what the new Digimar 817 CLT stands for: The simple moving and scrolling functions of the touchscreen work just like smartphones and tablets. The keys on the display are already arranged in such a way that frequently used functions are particularly easy to access. The measurements on the measuring slide can easily be started by hand via the touch display, the thumbwheel with integrated arrow keys, or using Quick mode. Two push buttons to actuate the air bearings are integrated into the handle enabling the device to be guided safely and sensitively by left- and right-handed operators. Regardless of whether you prefer to sit or stand while working, the touch display is always at eye level and can be rotated and tilted as required. This ensures the measuring process is particularly comfortable and relaxed.

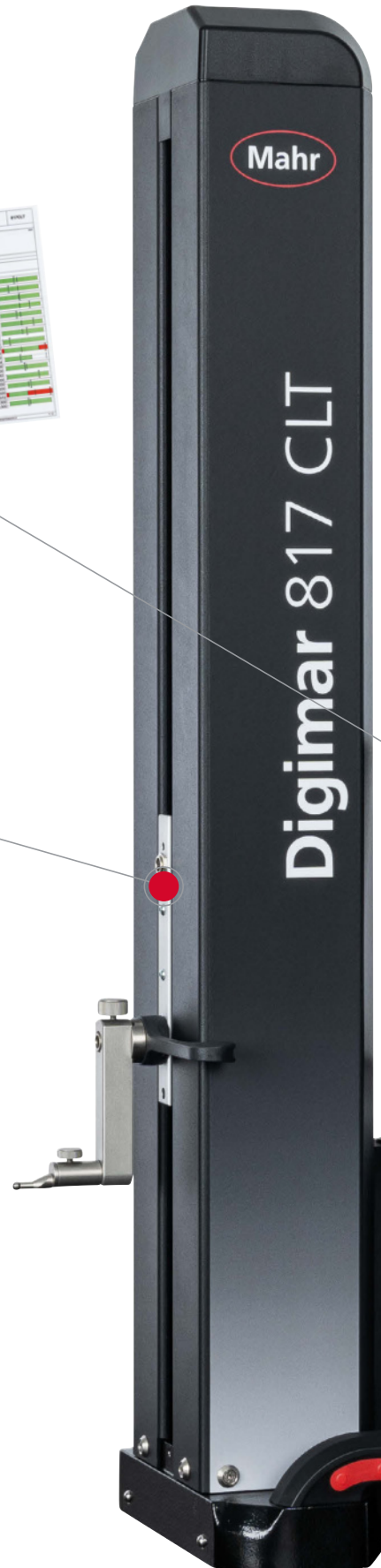



Simple touch measurement

Intuitive operation via large, clearly defined keys to ensure the safe completion on measurements, setting and calculation of functions, and the creation of measuring programs via Drag & Drop.

Pivoting display

10-inch touch panel with turn/tilt joint so that it can be set individually for the work position, height of the operator, and lighting conditions.



Easy handling

The thumbwheel can be used to move the measuring slide quickly and easily start the measurement. The quick measurement function keys also automatically detect surfaces and bores.



Best ergonomics

Ergonomic handles on both sides have an integrated operating key for the air bearing, ensuring the device can be moved accurately and effortlessly on the measuring plate.

Digimar 817 CLT

Height gage



FEATURES

- Contacting from below/above
 - Bar width or groove spacing including bar or groove center
 - Bore or shaft diameter including bore or shaft center
 - Reversal point bores (top or bottom)
 - Reversal point shaft (top or bottom)
 - Calculate distances or symmetry
 - Dynamic measurement functions
 - Right angle measurement
 - Straightness measurement
 - Measurement in 2D mode
 - Measurement programs
 - Measurement data processing
 - Large and clear touch display with backlight
 - Operator guidance via self-explanatory icons
 - Operator guidance in several languages
 - Possibility to set additional zero points on workpiece
 - Additional measuring device can be connected with MarConnect USB interface
 - Future-proof due to update capability
 - Automatic stand-by circuit
 - Adjustable auto-off function, without loss of measured values
 - Excellent measuring accuracy and reliability due to optical incremental measuring system with double reading head
 - Dynamic probe system for high repeatability
 - Air bearing system for easy, jerk-free displacement
 - Measuring head guided in precision ball bearings
 - Simple measuring sequences due to motorized measuring slide
 - Probe constant remains after switch-off
 - Integrated rechargeable battery with high operating time for mains-independent measuring
 - Temperature compensation with an integrated temperature sensor
- Software:** MarCom Professional free download: www.mahr.com/marcom (only for Mahr data cables and wireless systems with USB and RS-232 interface)
- **Data interface:** 3x USB 2.0, wireless
 - **Package contains:** height measuring instrument incl. operating and display unit, carrier 817h1, probe K6/51, setting block 817 eb, USB cable, instruction manual, power source, protection cover, calibration certificate



TECHNICAL DATA

Order no.	4429600	4429601	4429602	
Type	817 CLT			
Measuring range	mm	0 –350	0 –600	0 –1000
Measuring range	inch	0 –14"	0 –24"	0 –40"
Application range from	mm	170		
Application range up to	mm	520	770	1170
Resolution	mm	0.0001, 0.0005, 0.001, 0.005, 0.01		
Resolution	inch	.001", .0005", .0001", .00005", .00001"		
Error limit	µm	(1.8 + L/600) L in mm		
Repeatability bores	µm	1		
Repeatability planes	µm	0.5		
Perpendicularity error	µm	5		10
Operating time max.	h	16		
Measuring force	N	1.0 ± 0.2 N		
Relative humidity non-condensing	%	65		
Working temperature	°C	20		
Operating temperature	°C	10 –40		
Data interface		3x USB 2.0. wireless		
Standard		Factory standard		

Order no.	a	b	c	d	e	f
	mm	mm	mm	mm	mm	mm
4429600	89	278	77	255	688	356
4429601	89	278	77	255	938	610
4429602	89	278	77	255	1338	1016

ACCESSORIES

Order no.	Description	Type
4102220	Receiver for instruments with Integrated Wireless	i-Stick
6910271	Printer set for MarSurf M 310 and Digimar 817 CLT	DP-B1
4221525	Surface plate made from granite, 1000 x 630 mm	107 G
4221573	Open underframe with edge protection, 1000 x 630 mm	107 Ug
4221526	Surface plate made from granite, 1200 x 800 mm	107 G
4221574	Open underframe with edge protection, 1200 x 800 mm	107 Ug



i-Stick



107 G + 107 Ug



DP-B1



FEATURES

- Top or bottom contacting
- Web width or distances between grooves, including center of web or groove
- Bore or shaft diameter, including center of bore or shaft
- Bore reversing point (up or down)
- Shaft reversing point (up or down)
- Calculating distances or symmetry
- Dynamic measuring functions
- Measuring program
- Measuring data processing
- Easy to read backlit graphic LCD
- Clear function keys
- Language-neutral operator guidance with self-explanatory symbols
- Possible to set additional zero points
- Memory can store up to 99 measured values
- Excellent accuracy and reliability due to the optical incremental measurement system with the double reader head
- Dynamic probing system enabling high repeatability
- Air bearings system for light and smooth movement
- Precise measuring head on stainless steel guideways
- Motorized measuring carriage simplifies measurement runs
- Temperature compensation with an integrated temperature sensor
- Probe constant remains after the instrument is switched off
- Integrated rechargeable battery for power source independent measurement
- **Software:** MarCom Professional free download: www.mahr.com/marcom (only for Mahr data cables and wireless systems with USB and RS-232 interface)
- **Data interface:** Opto RS-232C, USB, wireless
- **Battery type:** Ni-Mh rechargeable battery
- **Package contains:** height measuring instrument incl. operating and display unit, carrier 817h1, probe K6/51, setting block 817 eb, instruction manual, power source, protection cover, calibration certificate



TECHNICAL DATA

Order no.	4429030		4429031
Type	816 CL		
Measuring range	mm	0 –350	0 –600
Measuring range	inch	0 –14"	0 –24"
Application range from	mm	170	
Application range up to	mm	520	770
Resolution	mm	0.001, 0.01	
Resolution	inch	.00005", .0001"	
Error limit	µm	(2.8+L/300) L in mm	
Repeatability bores	µm	3	
Repeatability planes	µm	2	
Perpendicularity error	µm	15	20
Operating time max.	h	10	
Measuring force	N	1.0 ± 0.2 N	
Relative humidity non-condensing	%	65	
Working temperature	°C	20	
Operating temperature	°C	10 –40	
Product weight	kg	25.00	30.00
Data interface		Opto RS-232C, USB, wireless	
Standard		Factory standard	

ACCESSORIES

Order no.	Description	Type
4346023	Data connection cable USB (2 m)	2000 USB
4346020	Data connection cable RS232C (2 m)	2000 r
4102232	Transmitter for e-Stick	2000 e
4102230	e-Stick receiver	e-Stick
4221526	Surface plate made from granite, 1200 x 800 mm	107 G
4221574	Open underframe with edge protection, 1200 x 800 mm	107 Ug
4221525	Surface plate made from granite, 1000 x 630 mm	107 G
4221573	Open underframe with edge protection, 1000 x 630 mm	107 Ug



107 G + 107 Ug

Digimar 817 ts1

Probe set

FEATURES

- Large accessory kit consisting of:
 - Depth probe
 - Carrier with extended holder
 - Disc measuring probe for grooves, etc.
 - Conical measuring probe
 - Cylindrical measuring probe
 - Holder for M2 dial test indicator measuring anvils
 - Carrier including 4 spherical probes with shaft holder $\varnothing 8$ mm
 - Plastic case
- Package contains: case

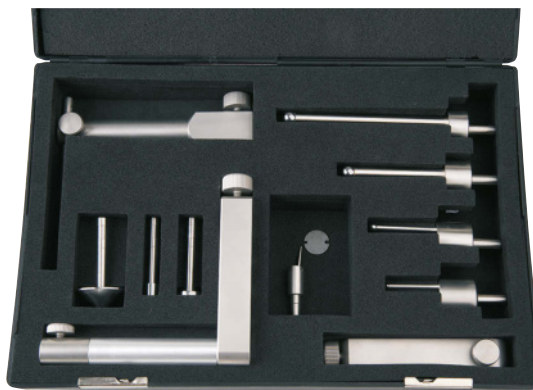

TECHNICAL DATA

Order no.	Type
4429019	817 ts1

COMPONENTS INCLUDED IN SET

Order no.	Description	Type
4429219	Probe carriers, mounting hole 6 mm, a = 100.5 mm, b = 119.5 mm, c = 84 mm	817 h2
4429226	Disc probe $\varnothing 15$ mm	S15/31.2
4429227	Cylindrical probe $\varnothing 10$ mm	Z10/31.2
4429228	Taper probe	MKe 30
4429221	Depth probe incl. holder	TMT 120
4429256	Probe with M2 threads for 3 styli positions ($0^\circ/10^\circ/90^\circ$), incl. styli 800 ts $\varnothing 2.0$ mm	KM 2
4429220	Probe carriers 817 CLM, mounting hole 8 mm	817 h4
7023813	Probe with mount, $\varnothing 4.0$ mm	K 4/30
7023816	Probes with mount, $\varnothing 6$ mm	K 6/40
7023810	Probes with mount, $\varnothing 10.0$ mm	K 10/60
7023615	Probes with mount, $\varnothing 10.0$ mm	K 10/100

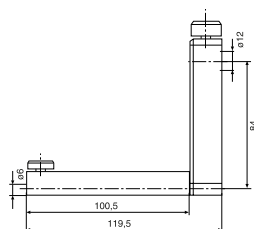

817 h2

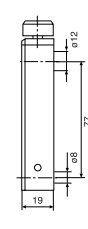

817 h4

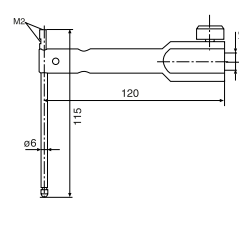

TMT 120

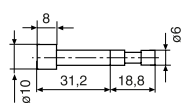

Z 10/31.2

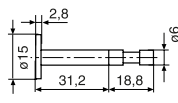

S 15/31.2

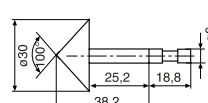

MKe 30

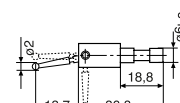

KM 2

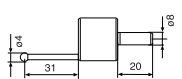

K 4/30

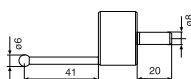

K 6/40

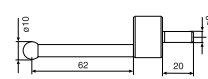

K 10/60

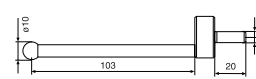

K 10/100

Digimar 817 ts2

Probe set

FEATURES

- Small accessory kit consisting of:
 - Depth probe
 - Carrier with extended holder
 - Disc measuring probe for grooves, etc.
 - Conical measuring probe
 - Cylindrical measuring probe
 - Holder for M2 dial test indicator measuring anvils
 - Plastic case
- Package contains: case

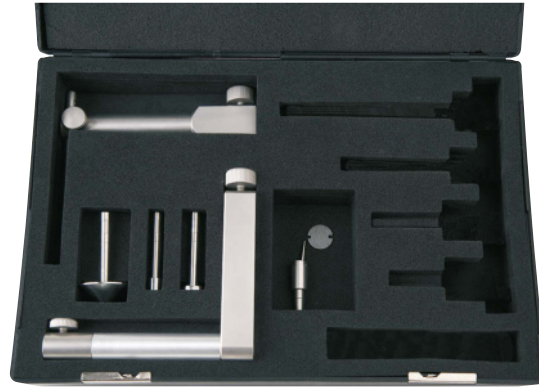

TECHNICAL DATA

Order no.	Type
4429018	817 ts2

COMPONENTS INCLUDED IN SET

Order no.	Description	Type
4429219	Probe carriers, mounting hole 6 mm, a = 100.5 mm, b = 119.5 mm, c = 84 mm	817 h2
4429226	Disc probe \varnothing 15 mm	S15/31.2
4429227	Cylindrical probe \varnothing 10 mm	Z10/31.2
4429228	Taper probe	MKe 30
4429221	Depth probe incl. holder	TMT 120
4429256	Probe with M2 threads for 3 styli positions ($0^\circ/10^\circ/90^\circ$), incl. styli 800 ts \varnothing 2.0 mm	KM 2

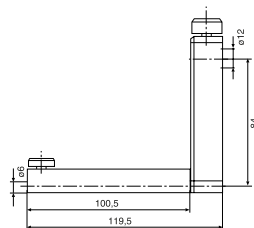

817 h2

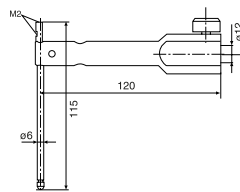

TMT 120

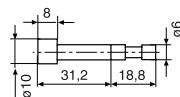

Z 10/31.2

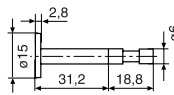

S 15/31.2

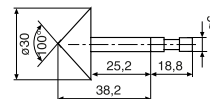

MKe 30

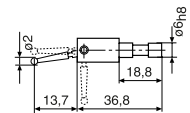

KM 2

Digimar 817 ts3

Universal probe set

FEATURES

- Accessory kit for small parts and delicate grooves, recesses and bores
- Suitable for 817 h4 carriers with 8 mm mounting bore
- Consisting of:
 - Base with 8 mm holding shaft
 - Depth probe
 - Probe shoe for grooves and recesses
 - Spherical measuring probe
 - Conical measuring probe
 - Extension
 - Adapter for M2.5 measuring anvils
 - Wooden case M2.5 measuring anvils
- Package contains: case

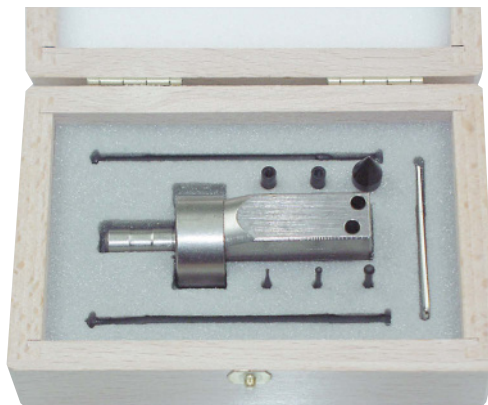

TECHNICAL DATA

Order no.	Type
7034000	817 ts3

COMPONENTS INCLUDED IN SET

Order no.	Description	Type
3015918	Measuring crook, $d = 0.5 \text{ mm}$, $l = 78 \text{ mm}$	TS 0.5/78
3015919	Probe pin/tip, $d = 1.2 \text{ mm}$, $l = 75 \text{ mm}$, $l_s = 15.5 \text{ mm}$	T 1.2/75
3015920	Taper probe	MKe 8
3022000	Spherical probe, $d_k = 3.0 \text{ mm}$, $l = 24 \text{ mm}$	K3/24
3022001	Spherical probe, $d_k = 2.0 \text{ mm}$, $l = 24 \text{ mm}$	K2/24
3022002	Spherical probe, $d_k = 1.0 \text{ mm}$, $l = 24 \text{ mm}$	K1/24
3015888	Extension M3 - M2.5, $d = 4 \text{ mm}$, $l = 20 \text{ mm}$	V/M2.5
3015921	Extension M3 - M3, $d = 4 \text{ mm}$, $l = 20 \text{ mm}$	V/M3
3015921	Extension M3 - M3, $d = 4 \text{ mm}$, $l = 20 \text{ mm}$	V/M 3

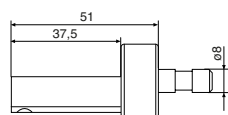

GK/8

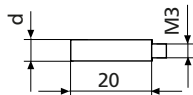

V/M2...M 3

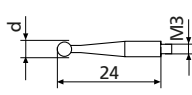

K 1...K3/24

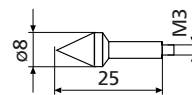

Mke 8

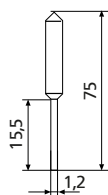

T 1.2/75

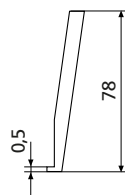

TS 0.5/78

Digimar 817 h1 / 817 h2 / 817 h5

Probe carriers

FEATURES

- Carrier for probes with 6 mm holding shaft
- Used for measurements at increased measuring depth (817 h2)
- Pivoting (817 h5) e.g. for aligning a cylindrical measuring probe



TECHNICAL DATA

Order no.	Type
4429154	817 h1
4429219	817 h2
4429454	817 h5

Order no.	a	b	c	Mounting hole
	mm	mm	mm	
4429154	27.5	46.5	84	6 mm
4429219	100.5	119.5	84	6 mm
4429454	35	54	86	6 mm

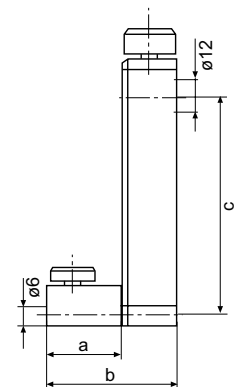

ACCESSORIES

Order no.	Description	Type
4301865	Mounting shaft \varnothing 6 mm	800 a6
4429158	Spherical probe, \varnothing 5.0 mm	K5/51
4429226	Disc probe \varnothing 15 mm	S15/31.2
4429227	Cylindrical probe \varnothing 10 mm	Z10/31.2
4429228	Taper probe	MKe 30
4429254	Spherical probe for 817 CLM, \varnothing 6 mm	K6/51
4429256	Probe with M2 threads for 3 styli positions ($0^\circ/10^\circ/90^\circ$), incl. styli 800 ts \varnothing 2.0 mm	KM 2

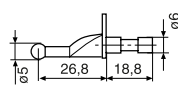

K 5/51

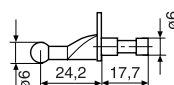

K 6/51

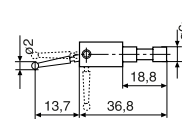

KM 2

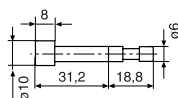

Z 10/31.2

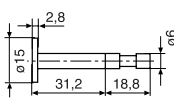

S 15/31.2

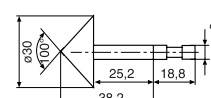

MKe 30

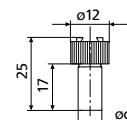

800 a6

Digimar 817 h4

Probe carriers

FEATURES

- Carrier for measuring anvils with 8 mm holding shaft and weighing 102 g
- Suitable for the CXt2 universal measuring probe set
- Compatible with Digimar CX1 and CX2 probes weighing 102 g



TECHNICAL DATA

Order no.	Type	Mounting hole
4429220	817 h4	8 mm

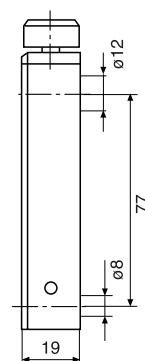

ACCESSORIES

Order no.	Description	Type
3015888	Extension M3 - M2.5, d = 4 mm, l = 20 mm	V/M2.5
3015917	Probe carrier	Gk/8
3015918	Measuring crook, d = 0.5 mm, l = 78 mm	TS 0.5/78
3015919	Probe pin/tip, d = 1.2 mm, l = 75 mm, ls = 15.5 mm	T 1.2/75
3015920	Taper probe	MKe 8
3015921	Extension M3 - M3, d = 4 mm, l = 20 mm	V/M3
3022000	Spherical probe, d _k = 3.0 mm, l = 24 mm	K3/24
3022001	Spherical probe, d _k = 2.0 mm, l = 24 mm	K2/24
3022002	Spherical probe, d _k = 1.0 mm, l = 24 mm	K1/24
7023615	Probes with mount, ø 10.0 mm	K 10/100
7023810	Probes with mount, ø 10.0 mm	K 10/60
7023813	Probe with mount, ø 4.0 mm	K 4/30
7023816	Probes with mount, ø 6 mm	K 6/40

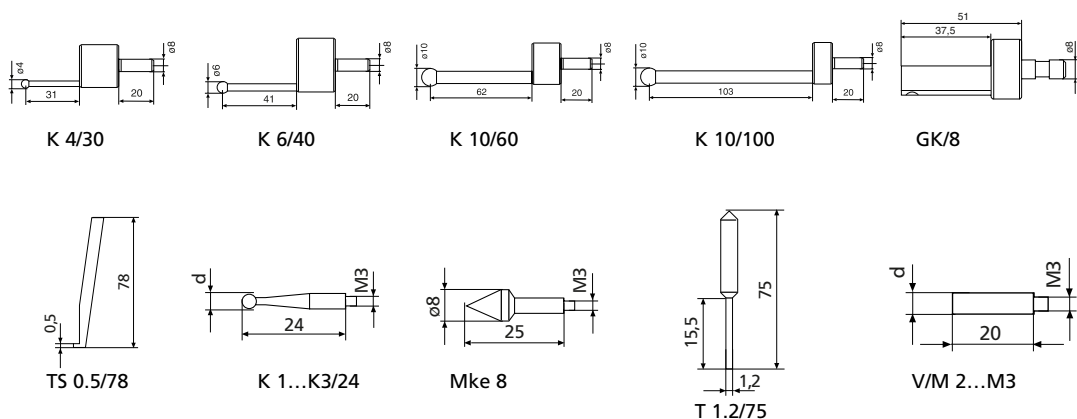

Digimar TMT 120 / TMT 120 S

Depth probe including holder

FEATURES

- Depth probe and carrier for measurements in vertical bores and recesses
- Interchangeable depth probe
- M2 and M2.5 connecting threads for measuring anvils
- M2.5 spherical contact point 901 H
- Pivatable (TMT 120 S only)
- Second depth probe with probe shoe for groove measurement (TMT 120 S only)
- M2 stylus 800 ts with 2 mm ball (TMT 120 S only)

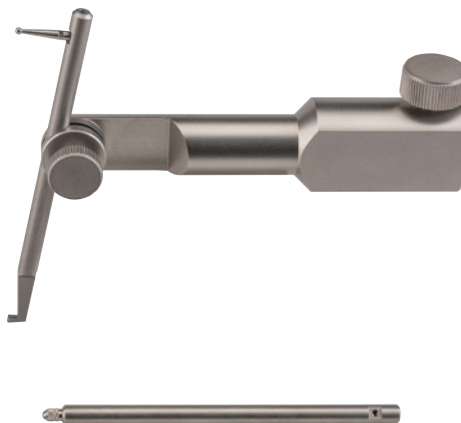

TECHNICAL DATA

Order no.	Type
4429221	TMT 120
4429421	TMT 120 S

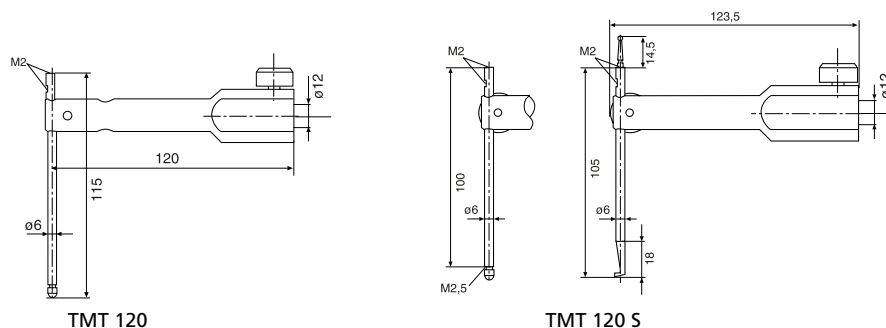

ACCESSORIES

Order no.	Description	Type
4305870	Stylus \varnothing 1.0 mm, carbide, $l = 14.5$ mm	800 ts
4305850	Stylus \varnothing 2.0 mm, carbide, $l = 14.5$ mm	800 ts
4305871	Stylus \varnothing 3.0 mm, carbide, $l = 14.5$ mm	800 ts
4309051	Stylus \varnothing 2.0 mm, ruby, $l = 14.5$ mm	800 tsr
4360001	Standard contact point, steel, $r = 1.5$ mm	901
4360002	Standard contact point, carbide, $r = 1.5$ mm	901 H
4360003	Standard contact point, ruby, $r = 1.5$ mm	901 R
4360241	Pin contact point, carbide, $l = 11$ mm, measuring surface \varnothing 1.5 mm	911 H2

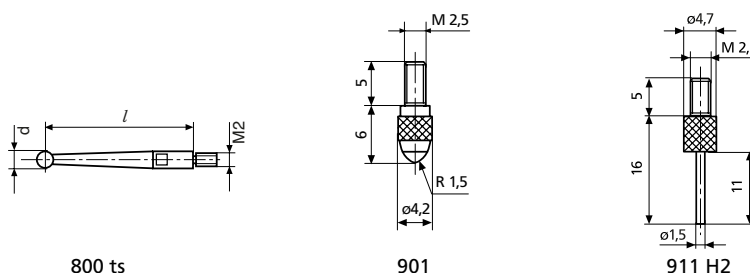

Digimar 817 h3

Carrier for checking perpendicularity

FEATURES

- Carrier for perpendicularity measurement
- Suitable for analog and digital dial indicators
- Ideal with P1514H measuring probe (817 CLM only)



TECHNICAL DATA

Order no.	Type
4429206	817 h3

Order no.	Mounting hole
4429206	8 mm

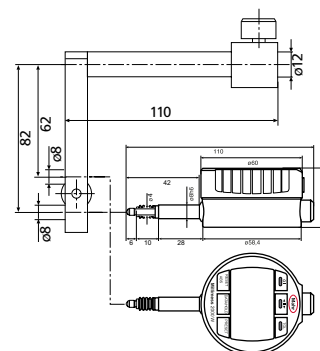

ACCESSORIES

Order no.	Description	Type
4346700	Inductive dial comparator, $\pm 1 \mu\text{m}$	2000 W
4346800	Inductive dial comparator, $\pm 1 \mu\text{m}$	2001 W
4429610	Data connection cable	DK-M1



2001 W



2000 W



DK-M1

Digimar 814 N

Height measuring and scribing instrument



FUNCTIONS

- ON/OFF
- RESET (set display to zero)
- mm/inch
- PRESET (for entering a numerical value)
- MAX/MIN memory for searching the reversal point
- (MAX-MIN) for testing flatness and concentricity
- TOL (enter tolerance limit values)
- Selectable resolution
- DATA (data transmission)

FEATURES

- Large, easy-to-read digital display
- Measuring and display unit are incorporated in the measuring head
- Data transmission via Opto RS232 C interface
- Digital preset
- Zero setting in any position
- MAX, MIN and MAX-MIN functions
- Enter tolerance limit for 1 characteristic
- Switch between mm/inch
- High accuracy
- Incremental inductive measuring system
- Measuring head with a ball bush guide
- Resistance free measuring system
- Easy to operate due to the hand crank on the side of the measuring head
- Constant measuring force; acting upwards or downwards as required
- Measuring head can be locked in position, ideal for scribing tasks
- With fine adjustment
- Power source independent due to being battery operated
- Universal application due to broad range of accessories
- **Data interface:** Opto RS-232C, wireless
- **Battery type:** CR 2032 (3V Lithium)
- **Package contains:** height measuring instrument incl. operating and display unit, caliper arm 814t, spherical probe 814 m, 8 mm, battery, instruction manual, protection cover, test certificate

Applications:

- For measuring heights and distances between bores, surfaces and edges
- For selecting and marking out workpieces



TECHNICAL DATA

Order no.	4426540	4426542
Type	814 N	
Measuring range	mm 0 –320	0 –620
Measuring range	inch 0 –12.6"	0 –24.4"
Resolution	mm 0.001, 0.01	
Resolution	inch .00005", .0005"	
Error limit	µm 20	30
Perpendicularity error	µm 20	30
Operating time max.	h 2000	
Measuring force	N 3	
Working temperature	°C 20	
Operating temperature	°C 5 –40	
Product weight	kg 6.20	10.50
Data interface	Opto RS-232C, wireless	
Standard	Factory standard	

ACCESSORIES

Order no.	Description	Type
4426510	Probe arm 150 mm, mounting hole 8 mm	814 t
4426525	Spherical probe, ball \varnothing 2.0 mm	814 m
4426526	Spherical probe, ball \varnothing 3.0 mm	814 m
4426512	Spherical probe, ball \varnothing 4.0 mm	814 m
4426527	Spherical probe, ball \varnothing 5.0 mm	814 m
4426511	Spherical probe, ball \varnothing 6.0 mm	814 m
4426528	Spherical probe, ball \varnothing 7.0 mm	814 m
4426509	Spherical probe, ball \varnothing 8.0 mm	814 m
4426498	Spherical probe ruby ball, \varnothing = 4.0 mm	817 CI-r
4426513	Disc probe	814 s
4426514	Probe mount with connecting thread M2.5	814 h
4426515	Scriber for height gage 814 G	814 a
4426516	Holder	814 kh
4426071	Measuring taper 0–15 mm	817 ks1
4426072	Measuring taper 14–20 mm	817 ks2
4426073	Measuring taper 18–24 mm	817 ks3
4426074	Measuring taper 23–30 mm	817 ks4
4426517	Two direction probe, \varnothing = 4.0 mm	814 u
4426518	Interchangeable probe arm, \varnothing = 2.0 mm	814 ua
4426434	Holder with connection thread M2.5 / M1.6 / M1.4	817 CI-am
4426433	Stylus with exchangeable measuring pin	817 CI-sa
4426435	Stylus with parallel measuring faces	817 CI-p
4426616	Dust cover for 0–320 mm	
4426619	Dust cover for 0–620 mm	
4102510	Data connection cable RS232C (2 m)	16 ESv
4102235	Transmitter for e-Stick	1082 e
4102230	e-Stick receiver	e-Stick
4102330	Opto USB adapter cable RS232-USB (0.2 m)	Opto USB

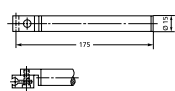

814 t

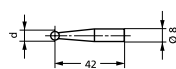

814 m

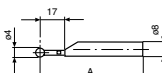

817 CI-r

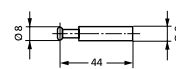

814 s

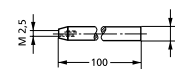

814 h

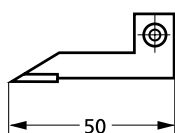

814 a

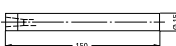

814 kh

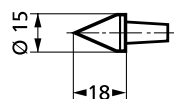

817 ks1

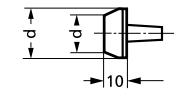

817 ks2;817 ks3;817 ks4

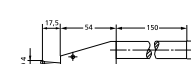

814 u

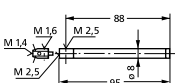

817 CI-am

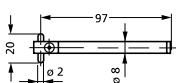

817 CI-sa

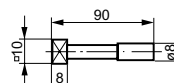

817 CI-p



e-Stick

Digimar 814 G

Height measuring and scribing instrument



FUNCTIONS

- ON/OFF
- RESET (set display to zero)
- mm/inch
- PRESET (for entering a numerical value)
- MAX/MIN memory for searching the reversal point
- (MAX-MIN) for testing flatness and concentricity
- TOL (enter tolerance limit values)
- Selectable resolution
- DATA (data transmission)

FEATURES

- Large, easy-to-read digital display
- Measuring and display unit are incorporated in the measuring head
- Data transmission via Opto RS232 C interface
- Digital preset
- Zero setting in any position
- MAX, MIN and MAX-MIN functions
- Enter tolerance limit for 1 characteristic
- Switch between mm/inch
- High accuracy
- Incremental inductive measuring system
- Measuring head with a ball bush guide
- Resistance free measuring system
- Easy to operate due to the hand crank on the side of the measuring head
- Constant measuring force; acting upwards or downwards as required
- Measuring head can be locked in position, ideal for scribing tasks
- With fine adjustment
- Power source independent due to being battery operated
- Universal application due to broad range of accessories
- **Data interface:** Opto RS-232C, wireless
- **Battery type:** CR 2032 (3V Lithium)
- **Package contains:** height measuring instrument incl. operating and display unit, caliper arm 814t, spherical probe 814 m, 8 mm, battery, instruction manual, protection cover, test certificate

Applications:

- For measuring heights and distances between bores, surfaces and edges
- For selecting and marking out workpieces



TECHNICAL DATA

Order no.	4426541	4426543
Type	814 G	
Measuring range	mm 0 –320	0 –620
Measuring range	inch 0 –12.6"	0 –24.4"
Resolution	mm 0.001, 0.01	
Resolution	inch .00005", .0005"	
Error limit	µm 20	30
Perpendicularity error	µm 20	30
Operating time max.	h 2000	
Measuring force	N 3	
Working temperature	°C 20	
Operating temperature	°C 5 –40	
Product weight	kg 14.00	18.30
Plate size	mm 200 x 300	
Data interface	Opto RS-232C, wireless	
Standard	Factory standard	

ACCESSORIES

Order no.	Description	Type
4426510	Probe arm 150 mm, mounting hole 8 mm	814 t
4426525	Spherical probe, ball \varnothing 2.0 mm	814 m
4426526	Spherical probe, ball \varnothing 3.0 mm	814 m
4426512	Spherical probe, ball \varnothing 4.0 mm	814 m
4426527	Spherical probe, ball \varnothing 5.0 mm	814 m
4426511	Spherical probe, ball \varnothing 6.0 mm	814 m
4426528	Spherical probe, ball \varnothing 7.0 mm	814 m
4426509	Spherical probe, ball \varnothing 8.0 mm	814 m
4426498	Spherical probe ruby ball, \varnothing = 4.0 mm	817 CI-r
4426513	Disc probe	814 s
4426514	Probe mount with connecting thread M2.5	814 h
4426515	Scriber for height gage 814 G	814 a
4426516	Holder	814 kh
4426071	Measuring taper 0–15 mm	817 ks1
4426072	Measuring taper 14–20 mm	817 ks2
4426073	Measuring taper 18–24 mm	817 ks3
4426074	Measuring taper 23–30 mm	817 ks4
4426517	Two direction probe, \varnothing = 4.0 mm	814 u
4426518	Interchangeable probe arm, \varnothing = 2.0 mm	814 ua
4426434	Holder with connection thread M2.5 / M1.6 / M1.4	817 CI-am
4426433	Stylus with exchangeable measuring pin	817 CI-sa
4426435	Stylus with parallel measuring faces	817 CI-p
4426616	Dust cover for 0–320 mm	
4426619	Dust cover for 0–620 mm	
4102510	Data connection cable RS232C (2 m)	16 ESv
4102235	Transmitter for e-Stick	1082 e
4102230	e-Stick receiver	e-Stick
4102330	Opto USB adapter cable RS232-USB (0.2 m)	Opto USB

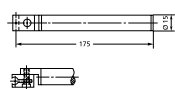

814 t

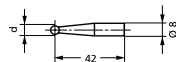

814 m

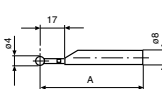

817 CI-r

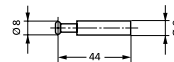

814 s

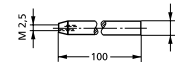

814 h

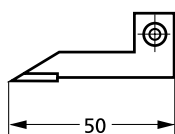

814 a

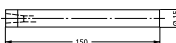

814 kh

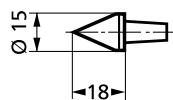

817 ks1

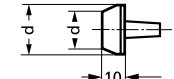

817 ks2;817 ks3;817 ks4

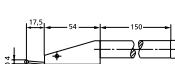

814 u

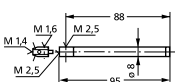

817 CI-am



817 CI-sa

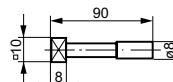

817 CI-p



e-Stick

Digimar 814 SR

Height measuring and scribing instrument



FUNCTIONS

- RESET (set display to zero)
- mm/inch
- ABS (switch between relative and absolute measurement)
- Lock/Unlock
- PRESET (for entering a numerical value)
- DATA (data transmission via connection cable)
- AUTO-ON / OFF

FEATURES

- Battery life up to 3 years
- Travel speed 1.5 m/s (60"/s)
- MarConnect data output: optional
 - USB
 - OPTO RS232C
 - Digimatic
- High contrast 12 mm LCD display
- Sturdy, heavy-duty machine base
- Hardened and lapped contact surface which produces both a smooth and even movement
- Slide and rail are made of hardened stainless steel
- Handwheel for positioning and measuring
- Fine adjuster
- Locking screw
- Interchangeable measuring and scriber tips, carbide-tipped
- **Software:** MarCom Professional free download: www.mahr.com/marcom (only for Mahr data cables and wireless systems with USB and RS-232 interface)
- **Data interface:** Opto RS-232C, Digimatic, USB, wireless
- **Energy supply:** Battery life approximately 3 years
- **Battery type:** CR 2032 (3V Lithium)
- **Package contains:** scriber, battery, carton, instruction manual

Applications:

- Scribing and marking workpieces
- Measuring heights and distances



TECHNICAL DATA

Order no.	4426100		4426101	
Type	814 SR			
Measuring range	mm	0 – 350		0 – 600
Measuring range	inch	0 – 14"		0 – 24"
Resolution	mm	0.01		
Resolution	inch	.0005"		
Error limit	µm	40		50
Operating time max.	h	4000		
Operating temperature	°C	10 – 40		
Product weight	kg	7.00		8.00
Data interface	Opto RS-232C, Digimatic, USB, wireless			
Standard	Factory standard			

Order no.	a	b	c	d
	mm	mm	mm	mm
4426100	62	180	35	580
4426101	62	180	35	835

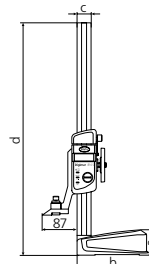

ACCESSORIES

Order no.	Description	Type
4123867	Measuring/scriber point, carbide tipped	814 SRs
4123041	Holder for test indicators	27 Sp
4102357	Data connection cable USB (2 m)	16 EXu
4102915	Interface adapter with data cable Digimatic (2 m)	16 EWd
4102410	Data connection cable RS232C (2 m)	16 EXr
4102230	e-Stick receiver	e-Stick
4102231	Transmitter for e-Stick	16 EWe

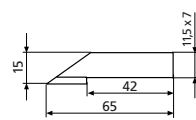

814 SRs; 27 ESh

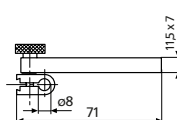

27 Sp



e-Stick



16 EWe

Precimar | Precision length metrology

Precimar stands for high-precision dimensional metrology – for both absolute and relative measurements. Typical applications include products and gages for the aerospace and automotive industries and the production testing of gages in calibration laboratories.



Precimar 826 PC Gage block testing	492
Precimar 130B-24 / 130B-16 Gage block testing	493
Precimar ICM 25 Dial indicator test device	495
Precimar ICM 100 IP Dial indicator test device	498
Precimar ICM 100 Dial indicator test device	499
Software and accessories	500
Precimar SM 60 Length measuring bench	504
Precimar LINEAR 800 / Linear 1200 / Linear 200 Length measuring device	505
Precimar ULM-E Calibration measuring instruments	508
Precimar ULM S-E Calibration measuring instruments	509
Precimar ULM L-E Calibration measuring instruments	510
Precimar PLM 600-E / 1000-E Precision length measuring machine	514
Precimar CiM 1000 CNC Precision length measuring machine	515

Precimar 826 PC

Gage block comparator

FEATURES

The 826 PC gage block measuring instrument is quick, reliable and highly accurate. An open and extremely rigid L-shaped stand forms the base for the two counteracting precision measuring probes and the measuring table.

- C 1202 Amplifier with color display (110 mm / 4,3", 480 x 272 Pixel)
- Rigid cast stand for temperature stability and heat resistance
- Fast adjustment of vertical slide with top probe
- Highly ergonomic, user-friendly one-handed operation to position the gage blocks under the measuring probe
- Precision adjustment via torsionally rigid parallelogram springs
- Electropneumatic lifting of measuring probes
- Precision ball bearing guides for smooth manipulator actuation
- No influence on measurement from hand force
- Round carbide precision support pins make it easy to move the gage blocks on the measuring table
- Set value linked to the stored actual deviation of the reference gage block, avoiding the need for zero point setting
- With QM-Block software (accessory):
- Flattening correction
- Correction of differing coefficients of expansion
- Mean value generation
- **Data interface:** USB
- **Energy supply:** 230 V/115 V; 50/60 Hz
- **Package contains:** Display unit C 1202 + measuring module N 1702 VSS



Application:

- Quick and easy high precision testing of European and US gage blocks up to 170 mm in length, as per ISO 3650

TECHNICAL DATA

Order no.	Type	Application range	Direct measuring range [mm]	Repeatability [µm]	Mass [kg]
		mm			
5350305	826 PC	0.5 to 170	0.2	± 0.01	37

ACCESSORIES

Order no.	Description	Type
4102603	Data cable USB bidirectional (2 m)	DK-U1
4102058	Foot switch to trigger data transmission	16 ESf
9059092	DELL® PC XE3/i5 SFF with WIN10 IoT int.	
3027221	24" monitor	
5350205	QM-Block software	
7023644	Gage block vacuum lifting pad	
4803335DKS	Parallel gage blocks made of carbide in set (11 pieces) incl. DAkkS calibration certificate for calibration of gage block test benches	417-11/K
4800130	Gage block maintenance accessories	424
4448010	Heat shield made of acrylic glass	826 Eg
5355759	Temperature measuring device Almemo 2590 for the temperature compensation in conjunction with the QM-Block software	
5355162	Temperature sensor for Almemo 2590	
9046377	Gage block terminal for temperature sensor	
5355756	230 V AC adapter for Almemo 2590	
5355757	120 V AC adapter for Almemo 2590	
5460029	Laser printer A4	
3018232	USB cable connection for printer	



424

Precimar 130B–24 / 130B–16

Gage block comparator

FEATURES

The 130B–24 and 130B–16 gage block measuring instruments from Mahr are the first choice for many large calibration laboratories. They are designed for comparative measurements of gage blocks.

- A unique “floating measuring frame” ensures exact point-to-point measurement
- Single sensor design for minimal electronic noise
- Precision balanced system for optimum adjustment of measuring forces
- Integrated measuring software and user interface
- Built-in positioning device for reproducible measuring positions
- **Energy supply:** 230 V/115 V; 50/60 Hz
- **Package contains:** Desktop computer, Windows software for 130 B, guide slot 30 x 9 mm, guide slot 35 x 9 mm, guide slot square blocks (5 positions)



Application:

- Quick and easy high precision testing of European and US gage blocks

TECHNICAL DATA

Order no.	Type	Application range	Direct measuring range [mm]	Repeatability [µm]	Mass [kg]
		mm			
2150076	130B–24	2.5 to 100	± 0.01	6σ < 0.025	100
2150080	130B–16	2.5 to 600	± 0.01	6σ < 0.025	140

ACCESSORIES

Order no.	Description
2238823	Guide slot for gage blocks (4 positions)
2238826	Guide slot for cross-section 30 x 9 mm (test piece) and gage block (reference end dimension)
2238825	Guide slot for cross-section 35 x 9 mm (test piece) and gage block (reference end dimension)
2240939	Guide slot for gage block (test piece) and (reference end dimension) cross-section 30 x 9 mm
2240940	Guide slot for gage block (test piece) and (referenced dimension) cross-section 35 x 9 mm
2243256	Guide slot for cross-section 30 x 9 mm (test piece) and (reference end dimension) cross-section 30 x 9 mm
2243257	Guide slot for cross-section 35 x 9 mm (test piece) and (reference end dimension) cross-section 30 x 9 mm
2253440	Almemo temperature measurement device with 2 sensors
2240602	Accessory set for gage block test stand
2260985	Gage block set for the calibration of gage block test stands

Precimar. Dial indicator testing

Partially and fully automated testing of indicating measuring equipment

Dial indicator test devices from Mahr stand for accurate and efficient measurement. These devices are designed for absolute measurement of dial indicators, dial comparators, dial test indicator measuring devices and 2-point bore gages as well as inductive and incremental measuring probes. Typical areas of use include dial indicator testing in all sectors of industry, measuring rooms and calibration laboratories as well as production testing by dial indicator manufacturers. When selecting the Precimar ICM dial gage testers, Mahr offers you practical solutions for both manual and fully automatic testing.

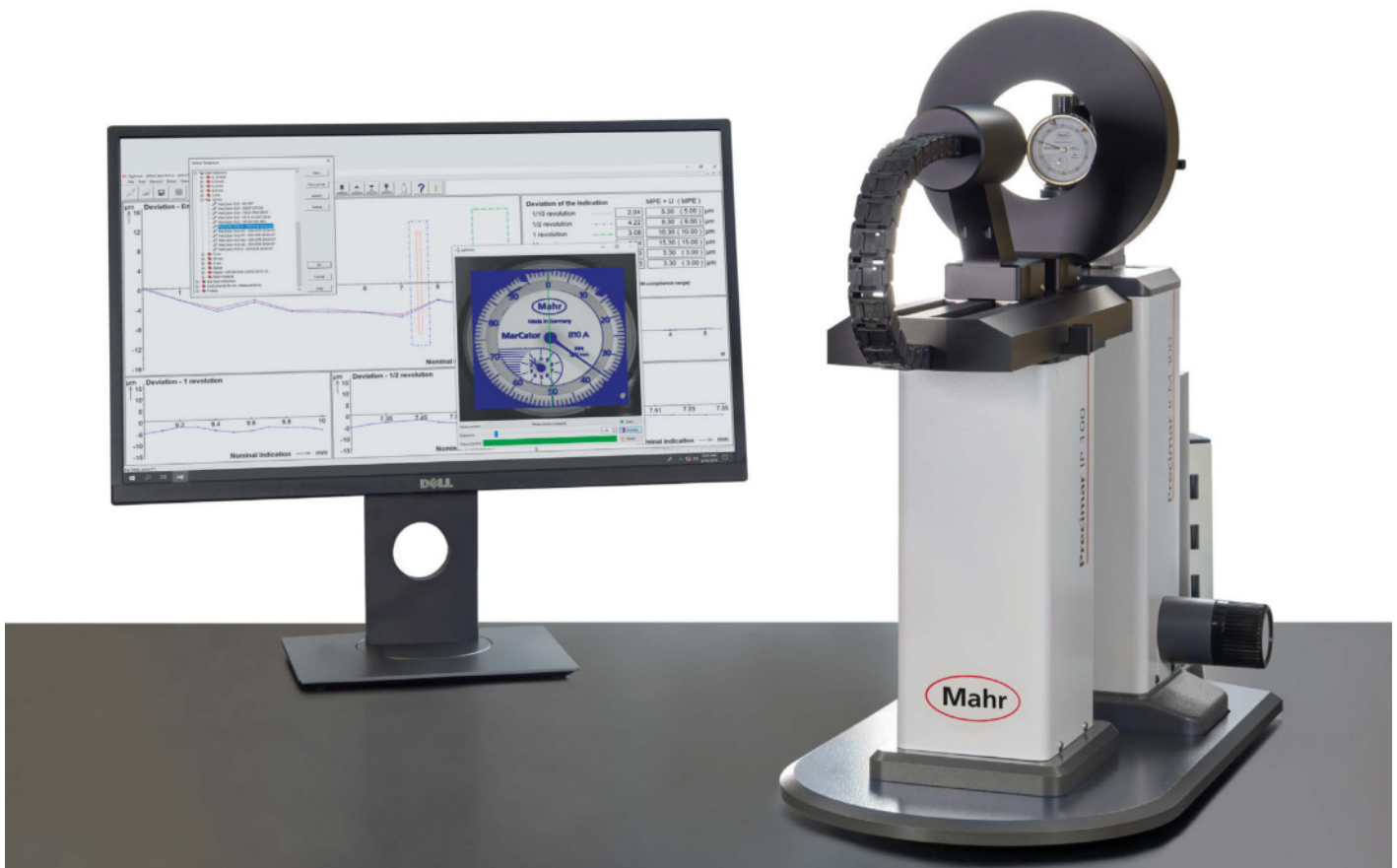

Precimar ICM 25

Manual dial indicator testing position

FEATURES

The Precimar ICM 25 is the most cost effective test station for manual testing of digital and dial indicators, dial test indicator measuring devices as well as inductive and incremental measuring probes.

- C 1202 amplifier with color display (110 mm / 4,3", 480 x 272 pixel)
- Fast height adjustment to adapt indicators according to the measuring range
- Rigid, box-shaped device housing
- For measuring objects with 8 mm, 3/8" shaft diameter
- All control elements are ergonomically arranged
- Complies with Ernst Abbe's comparator principle for maximum measuring accuracy
- **Energy supply:** 230 V/115 V; 50/60 Hz
- **Package contains:** display unit C 1202 + measuring module N 1702 VSS, split bushing BU-197, mounting shaft 800a3/8

Applications:

For testing of

- Dial indicators (analog and digital)
- Dial comparators (analog and digital)
- Dial test indicator measuring devices (analog and digital)
- Inductive and incremental probes



TECHNICAL DATA

Order no.	Type	Measuring range	Measuring uncertainty MPE_{E1} (L in mm) [μm]
		mm	
2062722	ICM 25	25 mm, 2 inch	± 0.2

ACCESSORIES

Order no.	Description	Type
4102058	Foot switch to trigger data transmission	16 ESf
4102603	Data cable USB bidirectional (2 m)	DK-U1
4305885	Mounting shaft $\varnothing 4$ mm	800 a4
4305893	Universal centering support frame	800 b

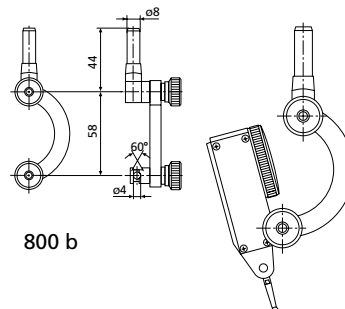
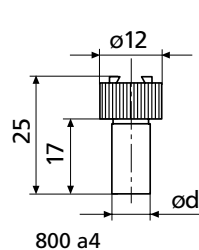

Fast and reliable results

The space-saving table-top unit is designed for simple operation and fast test procedures. Automated measuring significantly increases your efficiency. At the same time, the innovative, ergonomic design ensures that every movement is comfortable.

Fast and reliable data acquisition

The high-performance USB 3.0 camera and robust LED ring light guarantee that all display values are reliably detected. Even if the scale or digit display of your test object is not exactly in the center of the image, the system reads the display values without error.

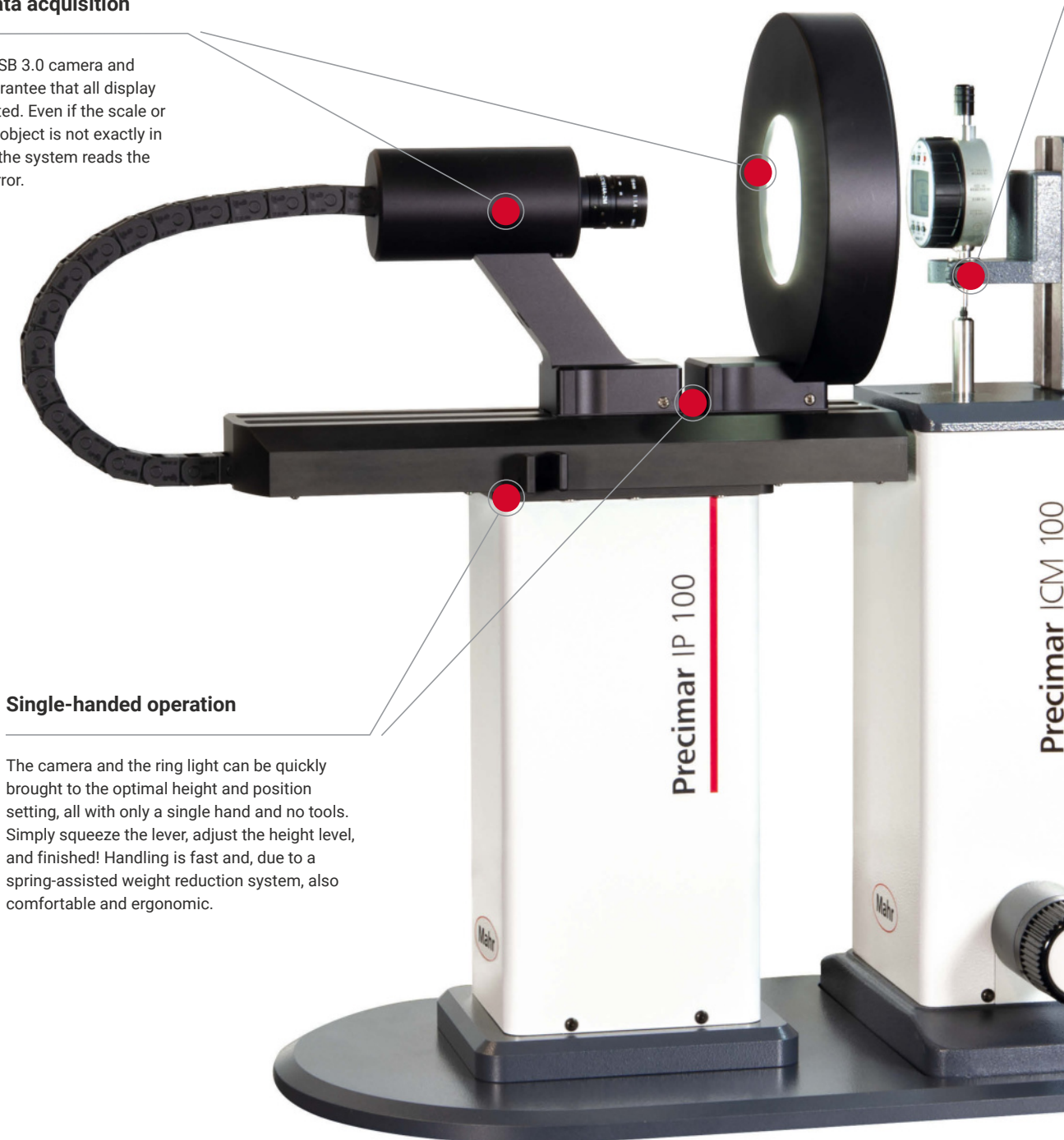

Single-handed operation

The camera and the ring light can be quickly brought to the optimal height and position setting, all with only a single hand and no tools. Simply squeeze the lever, adjust the height level, and finished! Handling is fast and, due to a spring-assisted weight reduction system, also comfortable and ergonomic.

Pre-loaded measurement modules

Measurement modules for more than 266 test specimens are pre-loaded into the software. Simply select a module during set-up based on the indicator you wish to measure. This saves time and reduces the risk of data entry errors. You can also create custom measurement modules or modify existing modules to fit your needs and requirements.

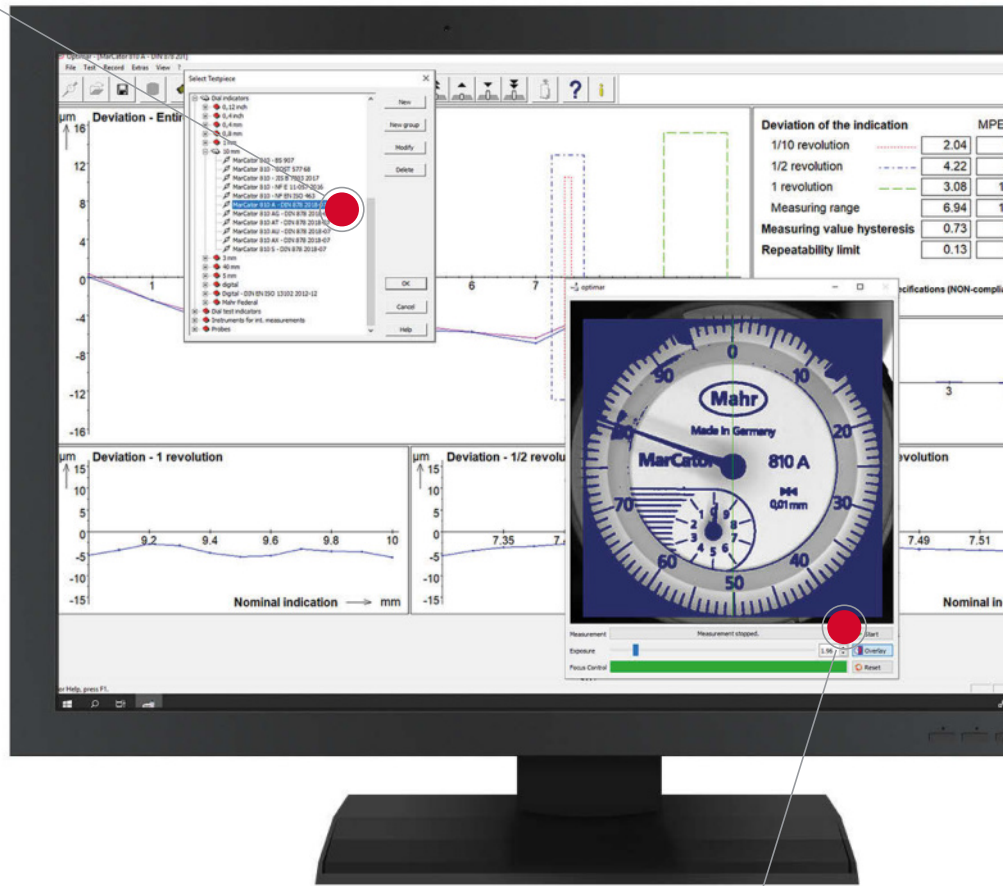

Improved specimen mounting

The bracket for mounting the test specimen exhibits improved clamping properties and easier handling. Specimens with shaft diameters of 8 mm, 28 mm, or 3/8" can be easily and securely mounted.

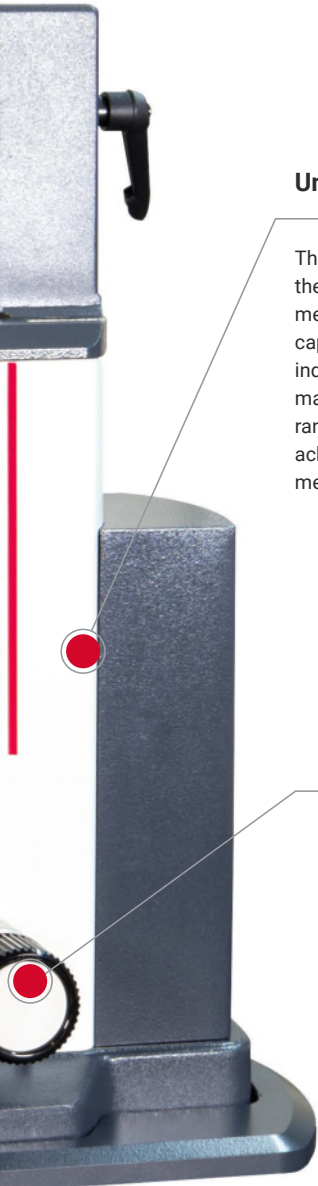

Universal and proven

The proven foundation of the ICM 100 IP is the ICM 100 (fka Optimar 100). This proven measurement solution is versatile in its capability to measure analog and digital indicators and comparators of different makes and models. With its measurement range of up to 4 inches / 100 mm, you will achieve standardized and traceable measurement results.

Easy setup

Ready to go in a few moments – due to software support with live visualization. You can see at a glance whether the camera is in focus and the exposure is sufficient. Real-time visual feedback ensures that each of your hand movements is right.

Manual mode

Would you prefer to measure certain indicators or comparators using a manual or semi-automated process? This is easily accomplished using the electronic handwheel. In manual or semi-automatic mode, the camera can be used as a magnifier. With the enlarged live-feed image, you can more easily read the dial face, thereby reducing eye strain and parallax error.

Precimar ICM 100 IP

Fully automated dial indicator test bench

FEATURES

You can use Precimar ICM 100 IP to automatically and cost-effectively test dial indicators and dial comparators. Easy handling with one hand and the clever software ensure the test device is the perfect solution for measuring rooms, calibration labs, and production testing. Testing measuring equipment has never been as efficient as with the Precimar ICM 100 IP: More than 60% time saved thanks to fast image processing, user-friendly software, and simple handling.



- Convenient, tool-free and intuitive operation with just one hand
- Highest-accuracy measurement through compliance with Abbe's principle
- Testing to international standards, including ASME/ANSI, DIN, BS, JIS, VDI, GOST and NF.
- High-performance USB 3.0 industrial camera with high image quality and wide dynamic range
- Robust, industrial-grade LED ring light for measurements unaffected by ambient light
- Ability to automatically measure digital indicators through direct reading of values – no cables required
- Wide variety of possible test specimens up to 4" inches / 100 mm – dial and digital indicators, comparators, test indicators
- Pre-programmed measurement modules with pre-loaded nominal values and tolerances
- Direct measurement range of 4 inches / 100 mm – no need to reposition the test specimen during testing
- Inductive probes from various manufacturers can be tested (only in manual mode)
- **Energy supply:** 230 V/115 V; 50/60 Hz
- **Package contains:** ICM IP software option, RS232C null modem cable, USB cable, support arm/clamp Ø12 mm, reduction clamping bushing Ø12 mm to Ø8 mm, power source, calibration certificate

Applications:

- Calibration of dial indicators, dial test indicator measuring devices and dial comparators
- The Precimar MSW 100 software system controls the dial indicator test device, processes the camera image (pointer or numeric display of the test object) and the reference measuring values of the dial indicator test device, and also performs all the subsequent processes related to test equipment management
- The testing routine can be implemented based on DIN, VDI, DKD or DAkkS guidelines, various international standards, or based on the company's internal specifications
- Deviations between test objects are illustrated in a graph during testing

TECHNICAL DATA

Order no.	Type	Measuring range	Measuring uncertainty MPE_{E1} (L in mm) [µm]	Mass [kg]
5351010	ICM 100 IP	mm 100 mm	$\leq (0.2 + L/250)$	45

ACCESSORIES

Order no.	Description	Type
3027221	24" monitor	
9059092	DELL PC XE3/i5 SFF with WIN10 IoT int.	
5358001	ICM100 software (V13), basic software	MSW 100
5460030	Ink jet printer A4, letter size	
5460029	Laser printer A4	
3018232	USB cable connection for printer	
7023901	Foot switch for the adoption of measuring values	
7025703	Holder for dial test indicator measuring devices incl. mounting attachment to calibrate both measuring directions	
7011721	Clamping bushing for Ø 3/8" clamping shafts	
7011722	Clamping bushing for Ø 10 mm clamping shafts	
9043093	Support arm for dial indicators and dial comparators with 30 mm clamping shaft	
9043092	Measuring force sensor for ICM 100	
9057923	Extended column to reach 100 mm range, if measuring force sensor is used	

Precimar ICM 100

Motorized dial indicator testing position

FEATURES

The Precimar ICM 100 is the most cost-effective test station for the partially or fully automated testing of dial indicators, dial comparators, dial test indicator measuring devices and 2 point bore gages, as well as inductive and incremental measuring probes.

- Automated sub-processes with motorized measuring spindle drive
- Fully automatic measuring procedure with digital measuring equipment
- Precimar ICM 100 is Suitable for horizontal use
- Fast height adjustment to adapt measuring objects to different measuring ranges
- Rigid, box-shaped device housing
- For measuring objects with 8 mm, 28 mm, 3/8" shaft diameter
- Electronic handwheel for manual control of spindle movement. The sensitivity of the electronic handwheel adjusts automatically to the testpiece resolution
- All operating elements are ergonomically arranged
- Complies with Ernst Abbe's comparator principle for maximum measuring accuracies
- Measuring system with error compensation
- Checking of 2-point inner measuring devices with no loss of accuracy
- Pre-positioning: automatic
- Fine positioning: electronic rotary knob
- **Energy supply:** 230 V/115 V; 50/60 Hz
- **Package contains:** RS232C null modem cable, USB cable, support arm/clamp Ø12 mm, reduction clamping bushing Ø12 mm to Ø8 mm, power source

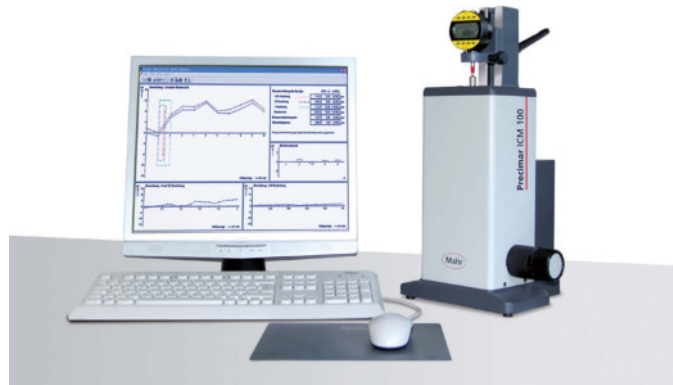

Applications:

For testing of

- Dial indicators (analog and digital)
- Dial comparators (analog and digital)
- Dial test indicator measuring devices (analog and digital)
- Inductive and incremental probes
- 2-point bore gages

TECHNICAL DATA

Order no.	Type	Measuring range	Direct measuring range [mm]	Measuring uncertainty MPE _{E1} (L in mm) [µm]
5351005	ICM 100	mm 100 mm, 4 inch (101.66 mm)	100	≤ (0.2 + L/250)

ACCESSORIES

Order no.	Description	Type
3027221	24" monitor	
9059092	DELL PC XE3/I5 SFF with WIN10 IoT int.	
5358001	ICM100 software (V13), basic software	MSW 100
5460030	Ink jet printer A4, letter size	
5460029	Laser printer A4	
3018232	USB cable connection for printer	
7025703	Holder for dial test indicator measuring devices incl. mounting attachment to calibrate both measuring directions	
7011721	Clamping bushing for Ø 3/8" clamping shafts	
7011722	Clamping bushing for Ø 10 mm clamping shafts	
9043093	Support arm for dial indicators and dial comparators with 30 mm clamping shaft	
9043092	Measuring force sensor for ICM 100	
9057923	Extended column to reach 100 mm range, if measuring force sensor is used	

Precimar MSW 100

Basic software (V13)

FEATURES

- Measurement/testing of dial indicators, dial comparators, dial test indicator measuring devices, and incremental/inductive probes
- Display of deviations curves/values
- Configurable testpiece template
- Preconfigured testpiece template for Mahr products
- Integration of DIN, VDI/VDE, JIS, ANSI, NF, and other standards and guidelines
- Individually adjustable records

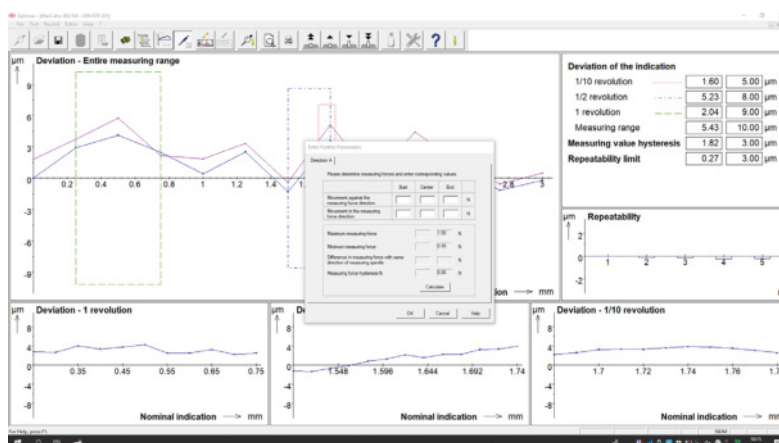

TECHNICAL DATA

Order no.	Supported standards	Type
5358001	<ul style="list-style-type: none"> • ASME B89.1.10M:2001 (Dial indicators, dial comparators, test indicators) • B.S. 907:2008 (Dial indicators) • B.S. 2795:1981 (Test indicators) • DIN 878:2018-06 (Dial indicators) • DIN 879:1999-06 (Dial comparators) • DIN 2270:2017-02 (Test indicators) • DIN EN ISO 463:2006-06 (Dial indicators) • DIN EN ISO 13102:2012-12 (Digital indicators) • DIN 32 876:1986-04 (Probes) • ISO 13102:2012-08 (Digital indicators) • JIS B 7503:2017 (Dial indicators) • JIS B 7519:1994 (Dial comparators) • NF EN ISO 463:2006-06 (Dial indicators) • NF E 11-056:2016-04 (Digital indicators) • NF E 11-057:2016-04 (Dial indicators und Dial comparators) • NF E 11-053:2013-10 (Test indicators) • GOST 577 68:01.07.68 (Dial indicators) • VDI/VDE/DGQ 2618 Part 11.1:2014-11 (Dial indicators) • VDI/VDE/DGQ/DKD 2618 Part 11.4:2019-08 draft (Digital indicators) 	MSW 100

Precimar

Adapter for digital instruments und probes

FEATURES

- For the fully automated measurement of the testpiece
- Direct connection of the measuring equipment to the dial indicator test bench
- Measuring instrument interface is recognized automatically in the software



TECHNICAL DATA

Order no.	For measuring instrument type	For measuring instrument	Data cable needed
7023878	Digital indicators	Mahr MarCator 1075/1075 R Mahr MarCator 1086/1086W/1086 R/ 1086 WR / 1086 Ri /1086 WRi Mahr MarCator 1087/1087 R /1087 Ri / 1087 BR / 1087 BRi	Mahr 16 EXr (Order no. 4102410)
7023913	Digital indicators	Mahr Millitast 1082 TESA DIGICO 10 Sylvac S229 / S213	None
7023909	Digital indicators	Mahr Millitast 1083 / 1085	None
7025985	Digital indicators and comparators	Mahr MarCator 1088 / 1088W Mahr MarCator μ Max μ m XL II Mahr Extramess 2000 / 2001 Mahr Millimes 2100 Mahr Millimes μ Max μ m II	Mahr 2000 r (Order no. 4346020)
7052174	Digital indicators and comparators	Mahr Federal μ Max μ m II / μ Max μ m XL II	None
7046954	Digital indicators	Mitutoyo Digimatic indicator	Digimatic data cable of manufacturer
7033860	Digital indicators and test indicators	Mahr Martest 800 EW / 800 EWL TESA DIGICO 12 TESA Tesatst IP 65 Sylvac S233 / Sylvac S234 Sylvac Series S_Dial	Mahr 800 EWr (Order no. 4305122)
7046956	Digital indicators	TESA DIGICO 205 / 305 / 400 / 500 / 600 /705	RS232 Data cable of manufacturer
7043260	Digital indicators	Starrett indicator	Data cable of manufacturer
7042301	Digital indicators	Guanglu indicator	Data cable of manufacturer and Mahr RS232- cable (Order no. 7024634)
7023897	Digital amplifier	Mahr Millimar C1208 / C1216 / C1240 Mahr Millimar 1240	Mahr RS232 cable (Order no. 7024634)
7024082	Incremental probes	Mahr Millimar 1512 / 1525	None
7034534	Incremental probes	Heidenhain MT/ST 11 μ Ass w. M23-plug, 9-pin	None
7044324	Incremental probes	Mahr Millimar P1514 / P1526 Heidenhain MT/ST 1Vss w. M23-plug, 12-pin	None
7044325	Incremental probes	Mahr Millimar P1514H Heidenhain MT/ST 1Vss w. D-Sub-plug, 15-pin	None
7051758	Incremental probes	Heidenhain MT/ST TTL w. D-Sub-plug, 15-pin	None
7034512	Digital probes	Solartron Orbit DP1, DP2, LE12	
7053933	Incremental probes	Keyence GT2	Keyence cable connection Keyence RS232C communication unit DL-RS1A

Precimar

Holder for 2-point inner measuring devices

FEATURES

- To secure inner measuring devices (up to max. measuring range of 100 mm and max. clamping diameter of 18 mm) during horizontal operation
- Automatic measurement in connection with software option, inductive probe 1340, and modules N1702 M-HR and N 1701 USB



TECHNICAL DATA

Order no.

5320021

ACCESSORIES

Order no.	Type	Description
5320026		Software option for 2-point inner measuring devices
5331125	N 1702 M-HR	Module for inductive probes
5331130	N 1701 USB	USB connecting module
5313400	1340	Inductive probe, ± 2 mm



N 1702 M-HR



N 1701 USB



1340

Precimar. Length measurement for all areas of use

Length measurement is used today in all sorts of different sectors. LINEAR length measuring instruments are setting and measuring instruments designed for general workshop use. The well-established universal length measuring instruments (ULM) are standard instruments for quality assurance in calibration measurement. They are also used for highly accurate length measurements on precision parts. Motorized PLM and CiM instruments offer fast, reliable and user friendly measurement with the lowest possible uncertainty. With products ranging from the simple LINEAR length measuring instrument and the ULM devices to the ultra accurate, partially automated CiM universal measuring machine, Mahr has practical solutions for manufacturing, measuring rooms and calibration laboratories. Precimar offers maximum precision combined with extremely efficient measuring processes.

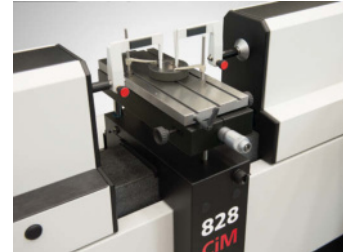

Precimar SM 60

Length measuring bench

FEATURES

The Precimar SM 60 is a user-friendly measuring instrument for fast, precise outside measurements on workpieces.

- Simple instrument design
- Quick adaptation to new workpieces
- Rugged construction makes it suitable for use close to production
- Freely selectable measuring equipment (e.g. digital dial indicator, measuring probes, etc.)
- Carbide measuring surfaces
- Integrated coupling protects the measuring equipment
- Wide choice of measuring attachments
- Suitable for left- and right-handed operators
- Large support table, Ø 60 mm, with variable height adjustment



TECHNICAL DATA

Order no.	5357360	5357370
Type	SM 60	SM 60
Mounting shaft diameter	mm	8
Application range	mm	0 – 60
Measuring range	mm	0 – 25 mm
Measuring surface ø	mm	6
Parallelism of measuring surfaces		<0.001 mm
Size of table	mm	Ø 60
Direct measuring range	mm	25
Measuring forces	N	1 N + measuring force of measuring system
		5 N + measuring force of measuring system
Mass	kg	9

Order no.	Height	Length	Width
	mm	mm	mm
5357360	120	290	140
5357370	120	290	140

ACCESSORIES

Order no.	g	Description	Type
4337661		Digital indicator, 0.0005 mm, 25 mm	1087 R
4337665		Digital indicator, 0.0005 mm, 25 mm	1087 Ri
4337621		Digital indicator, 0.0005 mm, 25 mm	1086 R
4337625		Digital indicator, 0.0005 mm, 25 mm	1086 Ri
5312010		Compact amplifier	C 1200
5323010	M 2.5	Inductive probe, ± 2 mm	P2004 M
5355368		Measuring attachment M 2.5	
5355410		Measuring attachment with plane surface Ø 2 mm	
5355411		Measuring attachment with flat-edged blade 2	
5355412		Measuring attachment with ball zone R20	
5355413		Measuring attachment with flat-edged blade 8 (pair)	
5355414		Measuring attachment with plane surface Ø 8 mm	
5355415		Measuring attachment with plane surface Ø 14 mm	
5355416		Measuring attachment with plane surface Ø 7.5 mm	
5355485		Measuring attachment with plane surface Ø 6.35 mm	



1087 Ri



1086 R-HR;
1086 R; 1086 ZR



C 1200



P2004 U; P2004 T;
P2004 M; P2004 F;
P2004

Precimar Linear 800 / Linear 1200 / Linear 2000

Setting and measuring instrument

FEATURES

LINEAR length measuring instruments from Mahr are ideal for use as a setting and adjusting instrument close to the production area. They offer precision setting of inside and outside comparative measuring instruments, inside micrometers, 2-point bore gages, dial comparator snap gages and many other measuring instruments. As an infinitely adjustable dimensional standard, the LINEAR is a cost effective alternative to setting gages, adjustment rings and gage blocks.

Key advantages include the ease of handling, short set-up time and ability to set any dimension. A switchable measuring force regulator, for both outside and inside measurements, delivers user independent measuring results.

- Base bar made of steel alloy, providing the same thermal behavior as the setting and measuring objects
- Precision ground and lapped guide rail, non-rusting
- Glued on steel scale along entire length of base bar
- Easy to operate
- Precision adjustable to 1/10 µm
- Measured values displayed with MarCheck:
- Display unit with extensive measuring functions, USB connection for printer or stick and USB connection and RS232 interface for transfer to PC
- A factory calibration or DAkkS/ DKD calibration is available for the measuring station
- **Energy supply:** 230 V/115 V; 50/60 Hz
- Accessories
- Testing devices for outside micrometers
- Clamping devices for 2-point bore gages for universal measuring table
- Support for large, 2-point bore gages and their accurate positioning and setup on the LINEAR
- Adjustable height support for setting up large bore gages
- Support plates for rings > 200 mm
- Holding device for long measuring equipment
- Attachment for dial comparator snap gages (height-adjustable)
- Height measuring system for universal measuring table
- Additional support table for long measuring objects
- Measuring anvils with Ø 20 mm balls; with ball-ended gage

TECHNICAL DATA

Order no.	5357302	5357303	5357304	
Type	Linear 800	Linear 1200	Linear 2000	
Measuring range for outer measurement	mm 0 to 815	0 to 1215	0 to 2015	
Measuring range for inner measurement	mm 40 to 855	40 to 1255	40 to 2055	
Measuring uncertainty MPE _{E1} (L in mm)	µm	≤ (0.7 + L/1000)		
Repeatability	µm	≤ 0.5		
Measuring forces	N	3		
Mass	kg	approx. 155	approx. 210	approx. 320

Order no.	Width	Hö Height he	Length
	mm	mm	mm
5357302	240	460	1250
5357303	240	460	1650
5357304	240	460	2450

- blocks; with Ø 15 mm and Ø 7.5 mm spindles
- Caliper, bore gages, plug-on heads, clamping elements
- Testing setups for depth gages
- Support for inside micrometers
- Temperature compensation

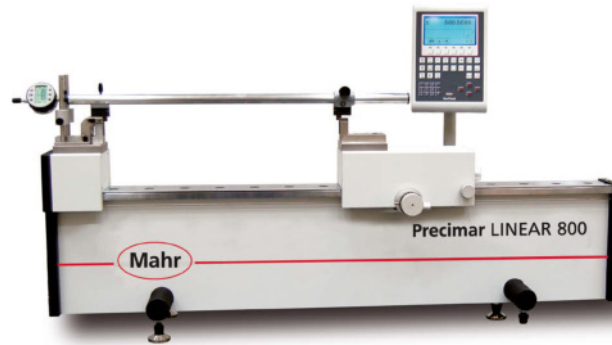

Applications:

- Setting comparative measuring instruments, e.g. Multimar 844 T
- Setting 2-point bore gages, e.g. Intramess 844 N
- Setting dial comparator snap gages, e.g. MaraMeter 840 F
- Checking and setting outer micrometers
- Checking setting standards, rods etc.
- Checking calipers
- Checking and setting inside micrometers
- Measuring cylindrical parts
- Measuring inner dimensions and bores, etc.

Length measuring instruments for calibration metrology

The well-established ULM universal length measuring instruments are standard quality assurance instruments in industrial manufacturing environments and reference instruments for gage and test equipment calibration. They are used for high-precision length measurements on precision parts such as gears, journals, ball hubs, ball cages, ball rings, tapers, gear shafts etc. and for checking gages and test equipment. These instruments are available for several measuring ranges (300 mm to 1500 mm/11.81 in to 59 in), in various accuracy classes (0.3 μm or 0.09 μm / 11.8 μin to 3.5 μin) and with the measuring system arranged in a number of different ways (in the measuring element or base or as a laser). This means that the right measuring instrument can be selected for each and every application. The varied sets of accessories and components are available as modules which also enables subsequent instrument additions.

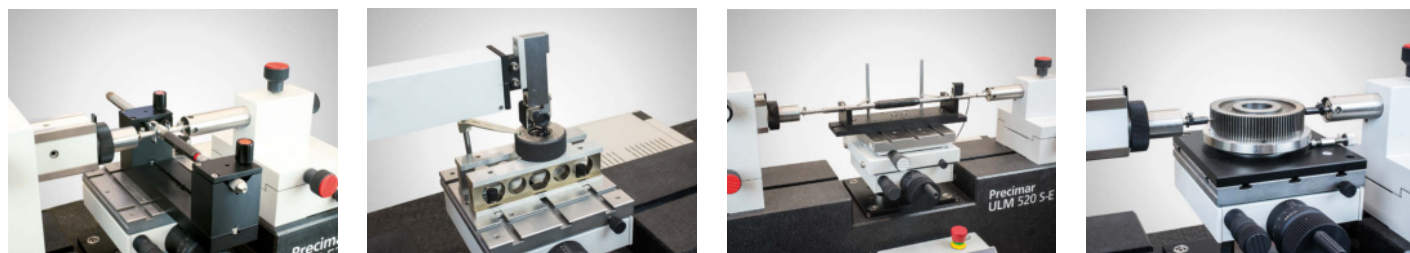

Precimar | Length measuring devices ULM-E series

Powerful Windows software

Maximum ease of use; inner thread measurement supported by automatic Z positioning

Wide range of accessories

Compatible with measuring tasks due to specifically configured accessory sets and individual components

Laser measuring system (ULM L-E variant)

Wide direct measuring range with maximum measuring accuracy

Online temperature monitoring

Correction of the different expansion behaviors and instrument zero-point stabilizing (patented) of the materials used as well as correction of systematic measuring errors due to temperature fluctuations of measuring object and setting standard

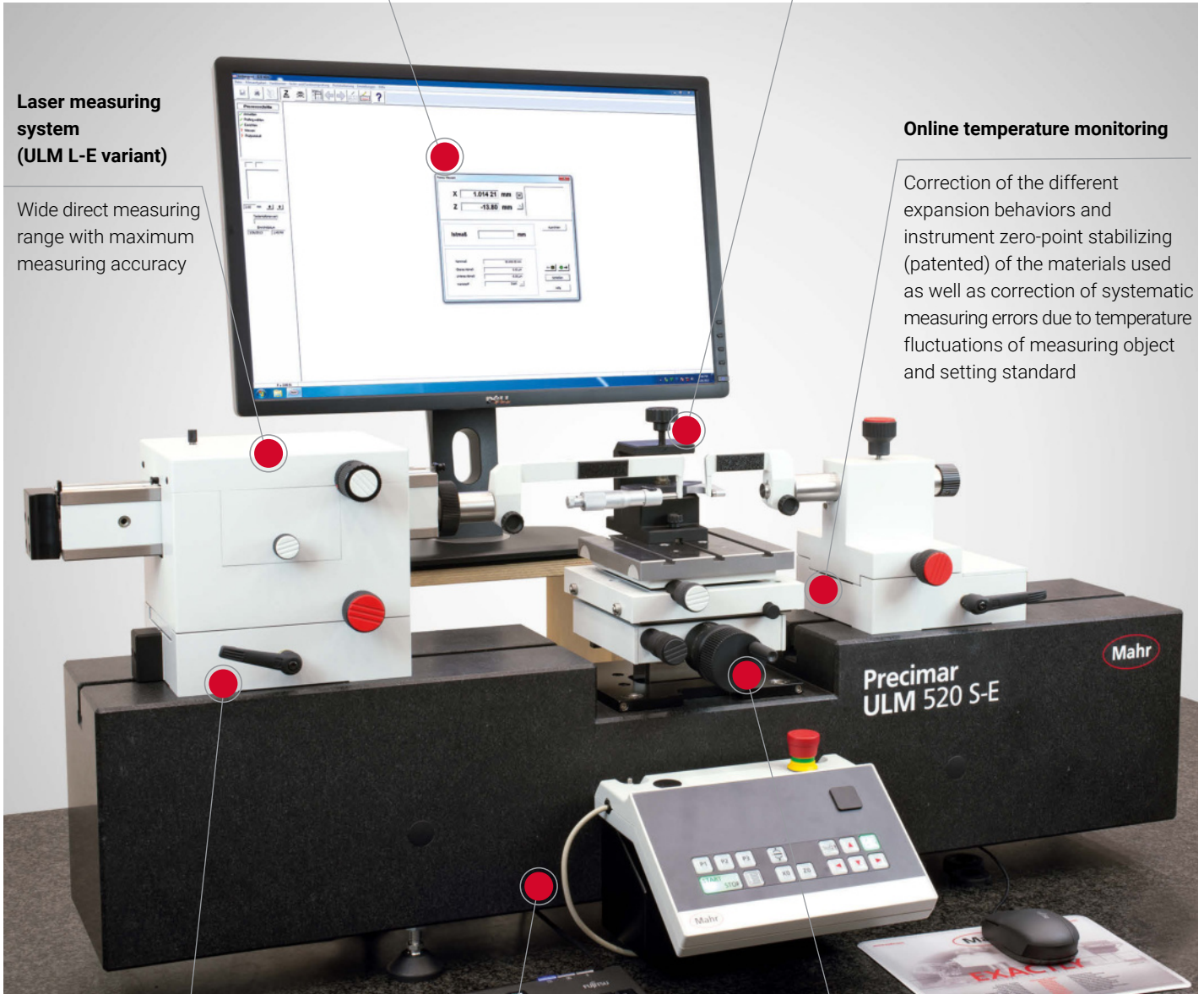

Air bearing

Productivity gain due to quick movement of ABBE measuring element and counter bearing

Granite

Highly homogenous and rigid

Z measuring system

Productivity gain and enabling of 2D measuring procedure by incorporating Z position values and travel paths

Precimar ULM 300-E / ULM 600-E / ULM 1000-E / ULM 1500-E

Calibration measuring instruments

FEATURES

ULM-E universal length measuring comparator instruments are mounted on highly homogeneous rigid granite in a horizontal configuration.

X-axis measuring system:

Heidenhain incremental, precision length measuring system, 100 mm long

Z-axis measuring system:

Renishaw incremental, precision length measuring system, 80 mm long



- High measuring accuracy
- Compliant with Ernst Abbe's comparator principle
- Manual operation of measuring spindle
- Air bearings for smooth manual positioning of measuring element and counter bearing (not ULM 300-E)
- Object table height adjustment via pushbuttons (also positioning of predefined increments)
- Computer provided temperature measurement with 2 or 3 sensors
- Computer-aided correction of systematic instrument errors (CAA)
- Computer-aided instrument zero point stabilizing
- Computer-aided correction of temperature and measuring force influences
- Constant measuring force over the entire measuring spindle setting range
- Large object table with precision guidance in the Z direction and a loading capacity of 25 kg
- Automatic reversing point detection with static and dynamic adoption of measuring values
- Inner thread measurement supported by automatic Z positioning
- Highly flexible in application range
- Mahr 828 WIN measuring and evaluation software runs under MS Windows®
- Optional use of measuring axis extensions
- **Energy supply:** 230 V/115 V; 50/60 Hz

ACCESSORIES

- Large number of accessory kits and modular components for completing a wide variety of measuring tasks, including the measurement of:
 - Thread gages
 - Taper gages
 - Conical thread gages
 - Gears
- Factory calibration or DAkkS/DKD calibration can be additionally offered for this measuring station

TECHNICAL DATA

Order no.		5350258	5350260	5350262	5350266
Type		ULM 300-E	ULM 600-E	ULM 1000-E	ULM 1500-E
Direct measuring range	mm	100			
Measuring range for outer measurement	mm	0 to 305	0 to 640	0 to 1060	0 to 1560
Measuring range for inner measurement	mm	0.5 to 150	0.5 to 485	0.5 to 905	0.5 to 1405
Measuring uncertainty MPE_{E1} (L in mm)	μm	$\leq (0,09+L/2000)$			
Repeatability	μm	$\leq 0,05$			
Measuring forces	N	0.2 ; 1.0 to 4.5 ; 11			
Mass	kg	110	160	215	280

Order no.	Width	Height	Length
	mm	mm	mm
5350258	280	480	685
5350260	380	480	1080
5350262	380	480	1500
5350266	380	480	2000

Applications:

Calibration of

- Plain plug gages and gage rings
- Setting gage rings
- Snap gages
- Spherical gage blocks, internal micrometers
- Gage blocks
- Thread gages
- Taper thread gages
- Gear gages
- Taper gages
- Dial indicators
- Dial comparators
- 2-point bore gages
- Outside micrometers
- 2-point inside micrometers
- Length measurement on precision table



For more information, please visit our website: www.mahr.com

Precimar ULM 520 S-E / ULM 1000 S-E

Calibration measuring instruments

FEATURES

Large universal length measuring instruments with large direct measuring range are mounted on highly homogeneous rigid granite in a horizontal configuration
X-axis measuring system:

- Heidenhain incremental, precision length measuring system, 100 mm long in measuring element
- Heidenhain incremental incident light measuring systems covering the entire length of the base bed and to its right and left
- **Z-axis measuring system:** Renishaw incremental, precision length measuring system, 80 mm long
- Combined measuring instrument for ultra accurate measurements in the range to 100 mm and for measurements in the standard accuracy range
- Accurate throughout the entire movement range of the measuring element and counter bearing
- Recommended for measurements of larger measuring objects, but also suitable for measurements of smaller measuring objects
- Manual operation of measuring spindle
- Air bearings for smooth manual positioning of measuring element and counter bearing
- Object height adjustment via pushbuttons (also positioning of predefined increment)
- Computer provided temperature measurement with 3 sensors
- Computer-aided instrument zero point stabilizing and correction of systematic instrument errors (CAA)
- Constant measuring force over the entire measuring spindle setting range
- Computer-aided correction of temperature and measuring force influences
- Large object table with precision guidance in the Z direction and a loading capacity of 25 kg
- Mahr 828 WIN measuring and evaluation software runs under MS Windows®
- Optional use of measuring axis extensions
- Inner thread measurement supported by automatic Z positioning
- **Energy supply:** 230 V/115 V; 50/60 Hz



TECHNICAL DATA

Order no.		5350267	5350268
Type		ULM 520 S-E	ULM 1000 S-E
Direct measuring range	mm	Outer measurement: 0 to 520 Inner measurement: 0.5 to 365	Outer measurement: 0 to 1025 Inner measurement: 0.5 to 870
Measuring range for outer measurement	mm	0 to 520	0 to 1025
Measuring range for inner measurement	mm	0.5 to 365	0.5 to 870
Measuring uncertainty MPE_{E1} (L in mm)	μm	only with ABBE measuring element: $MPE_{E1} \leq (0.09+L/2000)$ with base bed measuring system: $MPE_{E1} \leq (0.6+L/1000)$	
Repeatability	μm	With Abbe measuring element: ≤ 0.05 With base bed measuring system: ≤ 0.2	
Measuring forces	N	0.2 ; 1.0 to 4.5 ; 11	
Mass	kg	160	215

Order no.	Width	Height	Length
	mm	mm	mm
5350267	380	480	1080
5350268	380	480	1500

ACCESSORIES

- Large number of accessory kits and modular components for completing a wide variety of measuring tasks, including the measurement of:
 - Thread gages
 - Taper gages
 - Conical thread gages
 - Gears
- Factory calibration or DAKKS/DKD calibration can be additionally offered for this measuring station

Applications:

Calibration of

- Plain plug gages and gage rings
- Setting gage rings
- Snap gages
- Spherical gage blocks, internal micrometers
- Gage blocks
- Thread gages
- Taper thread gages
- Gear gages
- Taper gages
- Dial indicators
- Dial comparators
- 2-point bore gages
- Outside micrometers
- 2-point inside micrometers



For more information, please visit our website: www.mahr.com

Precimar ULM 800 L-E / ULM 1500 L-E

Calibration measuring instruments

FEATURES

Universal length measuring instruments with laser measuring system are mounted on highly homogeneous rigid granite in a horizontal configuration

X-axis measuring system:

Interferential laser measuring system, 525 or 1115 mm long

Z-axis measuring system:

Renishaw incremental, precision length measuring system, 80 mm long

- High end length measuring instrument with large direct measuring range
- Compliant with Ernst Abbe's comparator principle
- Manual operation of measuring spindle
- Air bearings for smooth manual positioning of measuring element (with laser reflector) and counter element
- Object table height adjustment via pushbuttons (also positioning of predefined increment)
- Laser correction with respect to environmental influences: temperature, air pressure (humidity optional)
- Separate laser generator outside the measuring instrument, fed via optical cable, and laser beam cover
- Computer-aided instrument zero point stabilizing and correction of systematic instrument errors (CAA)
- Computer provided temperature measurement and computer-aided correction of temperature and measuring force influences
- Constant measuring force over the entire measuring spindle setting range
- Large object table with precision guidance in the Z direction and a loading capacity of 25 kg
- Automatic reversing point detection with static and dynamic adoption of measuring values
- Highly flexible within the application range (can be used for measuring both miniature and large measuring objects)
- Mahr 828 WIN measuring and evaluation software and MS Windows®
- Inner thread measurement supported by automatic Z positioning
- **Energy supply:** 230 V/115 V; 50/60 Hz



TECHNICAL DATA

Order no.	5350263	5350264
Type	ULM 800 L-E	ULM 1500 L-E
Direct measuring range	mm 0 to 525	0 to 1115
Measuring range for outer measurement	mm 0 to 830	0 to 1620
Measuring range for inner measurement	mm 0.5 to 670	0.5 to 1465
Measuring uncertainty MPE_{E1} (L in mm)	μm	$\leq (0,1+L/2000)$
Repeatability	μm	$\leq 0,05$
Measuring forces	N	0.2 ; 1.0 to 4.5 ; 11
Mass	kg 220	325

Order no.	Width	Height	Length
	mm	mm	mm
5350263	380	480	1500
5350264	380	480	2300

ACCESSORIES

- Large number of accessory kits and modular components for completing a wide variety of measuring tasks, including the measurement of:
 - Thread gages
 - Taper gages
 - Conical thread gages
 - Gears
- Factory calibration or DAkkS/DKD calibration can be additionally offered for this measuring station

Applications:

Calibration of

- Plain plug gages and gage rings
- Setting gage rings
- Snap gages
- Spherical gage blocks, internal micrometers
- Gage blocks
- Thread gages
- Taper thread gages
- Gear gages
- Taper gages
- Dial indicators
- Dial comparators
- 2-point bore gages
- Outside micrometers
- 2-point inside micrometers



For more information, please visit our website: www.mahr.com

FEATURES

- Useful accessory packages for the most important calibration tasks
- Software modules optimally matched to the measurement tasks

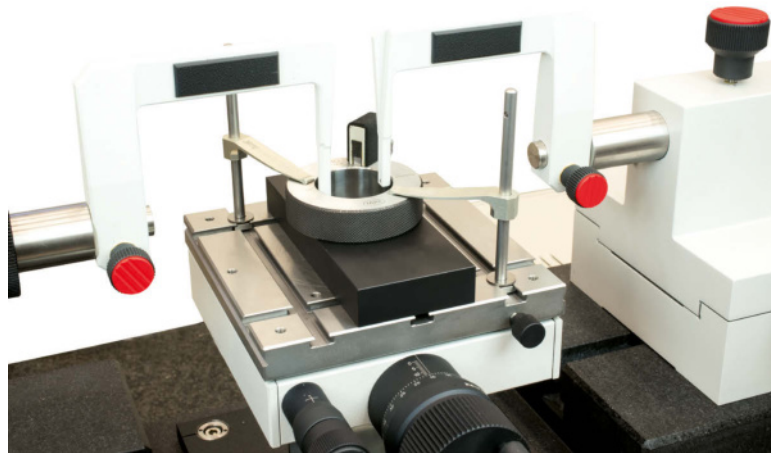

TECHNICAL DATA

Order no.	Description	Required Number of pieces	Application	Accessories package no.
5350161	Software module 828 WIN "Plain gages" / "Snap gages"	1		
5355413	2 pcs. measuring attachments with knife edge 8 mm	2	Plain plug and ring gages ≥ 1 mm	1
5355107	Universal V-clamping device	1		
5355776	Screw clamp for universal V-clamping device	1		
5355127	Measuring arms 28/4, depth 60 mm	2		
5355681	Tilt table	1		
5350163	Software module 828 WIN "Thread gages"	1	Cylindrical thread plug gages (pitch diameter)	3
4820000	Set A - set of thread pin gages 426 MS	1		
5355416	2 pcs. measuring attachments flat surface 7,5mm	2		
5355101	Single-axis floating table	1		
5355102	Floating table mount	1		
5355779	Set G ULM Tesa probe	1		
4631147	T-probe 828 gke, $\varnothing 0.29$ mm	1		
5355724	Single ball stylus $\varnothing 0.62$ mm	1	Cylindrical thread ring gages $\geq M3$ (pitch diameter)	4
7039407	Adapter for single ball probes	1		
5355114	2 pcs parallel bars H=40mm/W=20mm	2		
5350166	Software module 828 WIN "indicators/comparators/test indicators"	1	Indicators Comparators Test indicators	
5355140	Set E1 - Holder for indicator 8 mm	1		
7039499	U-piece for test indicators	1		
5355414	Measuring attachment flat 8 mm	1		

Length measuring machines for high-end calibration

The universal length measuring machines from Mahr are suitable for the absolute and relative measurement of precision products and test equipment. Typical applications here are products and test equipment used in the aerospace and automotive industries, precision engineering as well as series testing of test equipment in calibration laboratories. The PLM and CIM series thereby represents high-end length measuring machines that indicate the slightest length deviations and implement both semi-automated and automated test sequences. In other words: Metrology of the high-precision with extremely efficient processes, both in the measuring room and the calibration laboratory. The diverse range of accessory sets and components allows for the solution of the most diverse measurement and calibration tasks.



Precimar | PLM-E and CIM CNC series

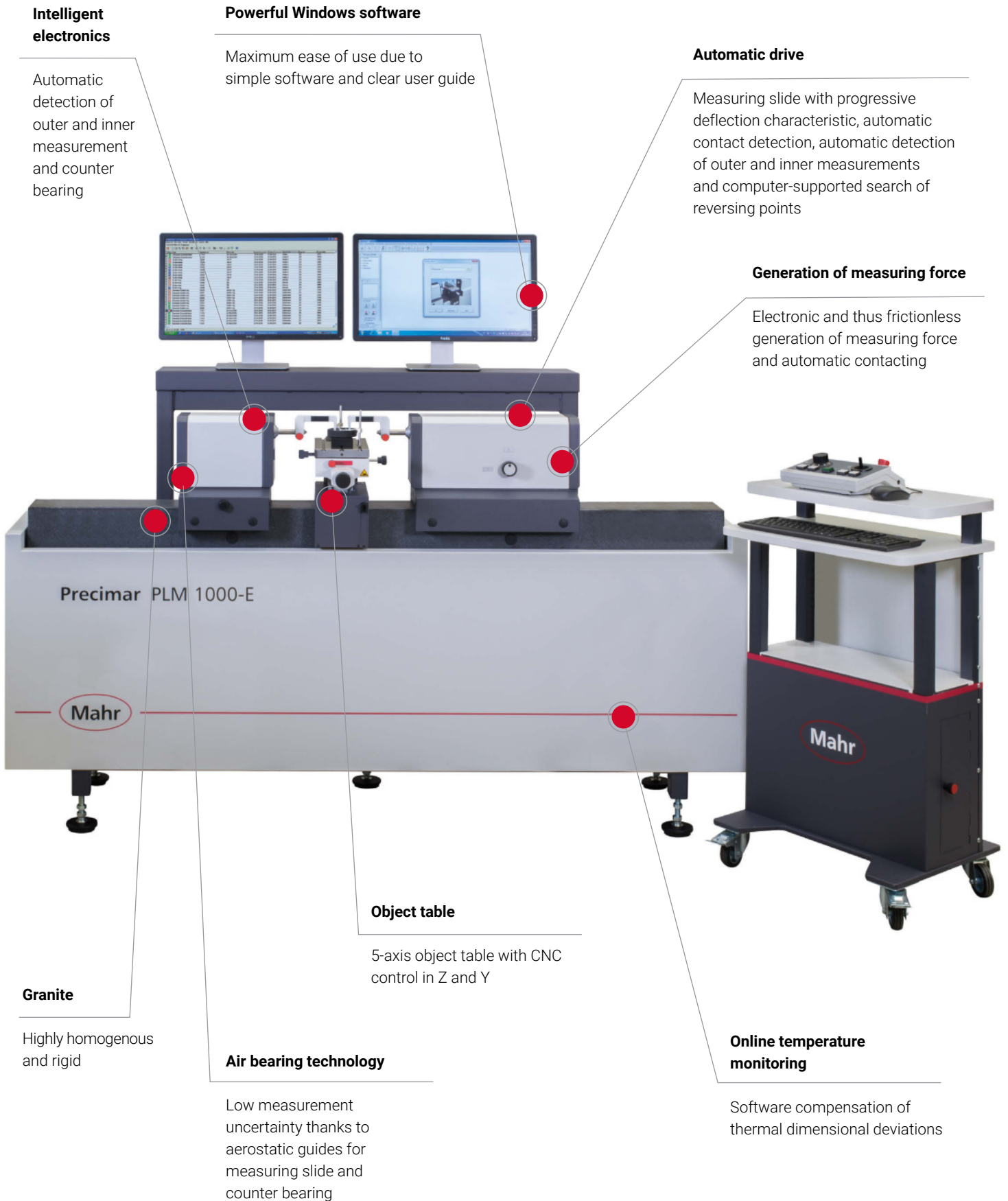

Precimar PLM 600-E / PLM 1000-E

Precision length measuring machine

FEATURES

The PLM-E precision length measuring machine is an Abbe compliant comparator mounted on highly homogeneous rigid granite in a horizontal configuration

- Sensitive adjustment in 5 axes, and object table with a loading capacity of 35 kg
- PC-based, multi-axis machine control, including PC workstation and 828 WIN "Free measurement" basic software
- Simple operating procedure by means of measuring force-adjusted and joystick-controlled measuring slides with progressive deflection characteristic and automatic contact detection
- Automatic detection of outside and inside measurements and computer-aided search for reversal points
- The motorized measuring slide allows for high travel speeds
- The CNC-controlled vertical and cross adjustment of the universal measuring table facilitates highly efficient measuring
- State-of-the-art machine control (MarEcon)
- Recording, processing, logging and transfer of measurement data via powerful software and menu-driven controls
- Software compensation of thermal dimensional deviations
- Very easy to set the measuring force using the software
- Aerostatic guides for all slides mounted on the machine bed ensure low measurement uncertainties
- Electronic generation of measuring force and automatic contacting
- Subjective influences largely eliminated and unintended collisions with the test piece avoided.
- Automatic bore and inner thread measurement
- **Automatic TY adjustment:** What's unique is that a manual TY-adjustment is still possible
- Motorized tilting axis (TB) for alignment. Alignment is carried out via the manual control panel or using the 828 WIN software.
- A factory calibration or DAkkS/ DKD calibration is available for the Precimar PLM-E
- **Energy supply:** 230 V/115 V; 50/60 Hz



TECHNICAL DATA

Order no.	5350700		5350800	
Type	PLM 600-E		PLM 1000-E	
Direct measuring range]	mm	200		
Measuring range for outer measurement	mm	0 to 600	0 to 1000	
Measuring range for inner measurement	mm	0.5 to 445	0.5 to 845	
Measuring uncertainty MPE _{E1} (L in mm)	µm	≤ (0,085 + L/1500)		
Position deviation / error limit (L in mm)	µm	≤ (0.07 + L/2000)		
Repeatability	µm	≤ 0.05		
Measuring forces	N	0 to 13.9	0 to 13.9	
Mass	kg	480	535	

Order no.	Width	Height	Length
	mm	mm	mm
5350700	790	1300	1660
5350800	790	1300	2110

ACCESSORIES

- Large number of accessory kits and modular components for completing a wide variety of measuring tasks, including the measurement of:
 - Thread gages
 - Conical thread gages
 - Gears
 - Thread pitches

Applications:

Calibration of

- Plain plug gages and gage rings
- Setting gage rings
- Snap gages
- Spherical gage blocks, internal micrometers
- Gage blocks
- Thread gages
- Taper thread gages
- Gear gages
- Dial indicators
- Dial comparators
- 2-point bore gages
- Outside micrometers
- 2-point inside micrometers
- Precision length measurement
- Measurement of thin-walled and deformed workpieces

Precimar CIM 1000 CNC

Precision length measuring machine

FEATURES

The Precimar CIM 1000 CNC precision length measuring machine is an Abbe-compliant comparator with horizontal base bed (highly homogeneous, rigid granite)

- Electronically controlled measuring force generation
- Motorized measuring spindle control with joystick and automatic contacting
- Air bearings for smooth positioning of measuring slide, counter bearing and object table
- Sensitive adjustment in 5 axes, and object table with a loading capacity of 25 kg
- Motorized object table height adjustment via joystick or CNC
- Maximum measuring accuracy
- Fast and reliable measurement
- Exceptionally low length measuring uncertainty for precision parts and gage monitoring
- Compliant with Ernst Abbe's comparator principle
- Online temperature monitoring
- Software-supported measuring force generation, especially advantageous for thin-walled workpieces and gages
- Semi-automatic bore and inner thread measurement
- Measuring and evaluation software runs under MS Windows®, 828 WIN
- Patented measuring procedure
- Aerostatic guides for all slides mounted on the machine bed ensure extremely low measuring uncertainties
- Movable measuring spindle mount via a spring parallelogram free from play and friction
- Electronic measuring force adjustment and automatic contacting – largely eliminating subjective influences and avoiding unintended collisions with the testpiece
- Possibility of calculating measuring result down to measuring force 0 N (dynamic measuring)
- **Energy supply:** 230 V/115 V; 50/60 Hz

ACCESSORIES

- Large number of accessory kits and modular components for completing a wide variety of measuring tasks, including the measurement of:
 - Thread gages
 - Conical thread gages
 - Gears
 - Thread pitches
- Factory calibration or DAkkS/DKD calibration can be additionally offered for this measuring station



TECHNICAL DATA

Order no.		5350701	
Type		CIM 1000 CNC	
Direct measuring range	mm	300	
Measuring range for outer measurement	mm	0 to 1000	
Measuring range for inner measurement	mm	0.5 to 845	
Measuring uncertainty MPE _{E1} (L in mm)	µm	≤ (0.055 + L/1500)	
Position deviation / error limit (L in mm)	µm	≤ (0.04 + L/2000)	
Repeatability	µm	≤ 0,03	
Measuring forces	N	0 to 13.9	
Mass	kg	840	

Order no.	Width	Height	Length
	mm	mm	mm
5350701	700	1700	2500

Applications:

Calibration of

- Plain plug gages and gage rings
- Setting gage rings
- Snap gages
- Spherical gage blocks, internal micrometers
- Gage blocks
- Thread gages
- Taper thread gages
- Gear gages
- Dial indicators
- Dial comparators
- 2-point bore gages
- Outside micrometers
- 2-point inside micrometers
- Precision length measurement
- Measurement of thin-walled and deformed workpieces

MarSurf | Surface measuring instruments

Careful testing is paramount wherever surface structures affect the function or appearance of components. MarSurf surface measuring instruments offer outstanding quality. Mahr has perfected the stylus method, which has now become established worldwide. But we can also meet the latest demands for contactless measuring with a range of optical sensors. Mahr's MarSurf surface metrology offers a combination of top quality, maximum competence and perfect expertise.



Overview MarSurf	518
Surface measuring instruments	
MarSurf Pocket Surf IV	520
Mobile roughness measuring instrument	
MarSurf PS 10	524
Mobile roughness measuring instrument	
MarSurf M 310	428
Mobile roughness measuring instrument	
MarSurf M 310 PC	530
Mobile roughness measuring instrument	
MarSurf M 400	534
Mobile surface measuring instrument	
MarSurf XR 1	538
Roughness measuring station	
MarSurf GD 140 / GD 280	539
Roughness measuring station	
MarSurf CD 140 A	542
Contour measuring station	
MarSurf CD 140 / CD 280	543
Contour measuring station	
MarSurf VD 140 / VD 280	544
Roughness and contour measuring station	
MarSurf UD 130 / LD 130 / LD 260	548
Combined contour and surface measuring station	
MarSurf CNC modular	549

Optical or tactile?

Selecting the right measuring equipment

When should you rely on tactile metrology and when does it make more sense to measure using established optical devices? As both methods are equally precise, delivering results with 99 % accuracy, it always comes down to the surface structures you want to measure and which parameters are relevant for your production. Mahr offers you versatile solutions for both types of systems. The following criteria will help you make your selection:

1

Process values in accordance with ISO 4287, ISO 13565, ISO 25178 und ISO 21920

Tactile and optical devices identify the roughness and sometimes the waviness of surfaces – all the while in compliance with the standards DIN EN ISO 4287 and DIN EN ISO 13565. Optical devices also comply with the standard DIN EN ISO 25178 and in future with the standard DIN EN ISO 21920, which allow for an extensive description of a surface without contact.

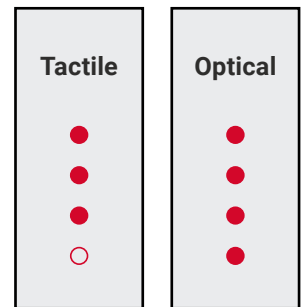

2

Get established process values in the blink of an eye

Roughness, waviness and primary profiles describe the surface and its properties. The parameters derived from that provide information about the quality of the surface. This guarantees reliability in the production process and makes it possible to carry out incoming goods checks quickly.

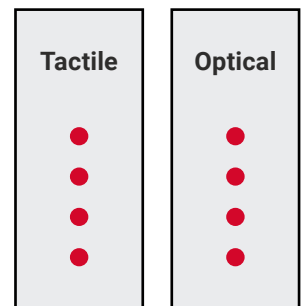

3

Statistical testing

When it comes to machined surfaces, structures are often no longer arranged in a certain direction but are distributed at random. A 2D section does not sufficiently describe them or, if it does, it is extremely time consuming. However, the extensive optical sampling of the surface provides more information and fast measuring results.

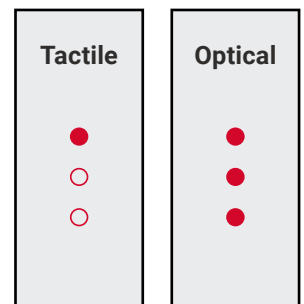



4

Measurement at the touch of a button

Simply place the probe arm on the surface, press the button and begin measurement – no need for complicated peripherals. Read the results directly on the display and print them out with the associated printer as desired. Enjoy all of this at an unbeatable price-performance ratio.

Tactile	Optical
●	○
●	○
●	○
●	○

5

Topological testing

When surfaces are extremely sensitive, soft, sticky or even discontinuous, non-contact and thus optical measurement is the method of choice. This applies equally to coated, inhomogeneous and complex surfaces as well as to surfaces without processing structures: It is best to scan and evaluate them optically.

Tactile	Optical
●	●
○	●
○	●
○	●

6

Easy accessibility

Both optical and tactile mobile devices enable reliable surface testing directly on the workpiece in the production area. To examine surfaces, small depressions or drill holes that are difficult to access, the removable drive units in tactile tools also present a particular advantage.

Tactile	Optical
●	●
●	●
●	○

MarSurf Pocket Surf IV

Mobile roughness measuring instrument



FEATURES

- Sturdy housing made of cast aluminum guarantees accurate and reliable measurement operation over many years
- Measurement of four selectable parameters: Ra, Rmax/Ry, Rz
- Reading of all the parameters after the measurement is completed
- Measuring length adjustable based on 1x, 3x or 5x the cutoff wavelength 0.8 mm/0.030"
- Can be implemented in any position – horizontal, vertical and upside down
- Four locking probe positions – axial or at 90°, 180°, or 270° angle
- Even difficult to reach surfaces on the inner and outer diameters are accessible
- MarConnect data output for simple data transmission, compatible with standard data recording systems
- Easy to read LCD displays the measured roughness parameters in μm or μinch immediately after scanning the surface
- Messages indicating when ranges exceed or fall below a limit and a battery warning symbol are also displayed
- Simplified calibration process
- Improved battery life with easy to replace 9V battery



Applications:

- Pocket-sized, economically priced, completely portable instrument
- Performs traceable surface roughness measurements on a wide variety of surfaces
- Can be used confidently in production, on the shop floor and in the laboratory

TECHNICAL DATA

Order no.	2191800	2191802
Type	Pocket Surf IV	
Parameters	Ra, Ry, Rmax, Rz	
Stylus	10 μm / .0004"	5 μm / .0002"
Data interface	RS-232C, USB	
Rechargeable batteries	Battery, 9V	
H x W x D	mm	140 x 76 x 6.35 mm
Measuring principle	Skid probe system	
Probe	Piezoelectric skid probe	
Measuring range	mm	Ra –6.35 μm / 250 Ry, Rmax, Rz –25.3 μm / 999 μin
Profile resolution	0.01 μm / 1 μin	
Number n of sampling length according to ISO/JIS	Selected: 1 –5	
Measuring force	N	15 mN
Positioning speed	1.0	

MarSurf Pocket Surf IV

Mobile roughness measuring instrument

ACCESSORIES

Order no.	Description	Type
2008010	General purpose probe, 10µm/90°	EGH-1019
2008012	Transverse chisel probe 10 µm	EGH-1020-W1
2008013	Parallel chisel probe	EGH-1020-W2
2008014	Small bore probe, 10µm/90°	EGH-1021
2008011	General purpose probe, 5µm/90°	EGH-1026
2008015	Small bore probe, 5µm/90°	EGH-1027
2008016	Groove bottom probe, 5µm/90°	EGH-1028
2008024	Compact height stand	EAS-2496
2008025	Universal stand	EAS-2426
2008026	Column clamp for EAS-2426	EAS-2567
2008027	Adapter plate	EPL-1681
2008023	Portable V-fixture	EAS-2421
2008022	Bottom plate	EAS-2584
2008021	Bore adapter kit	EAS-2839
2008020	V-adapter kit	EAS-2739
2008030	Certified specimen, incl. test certificate	PMD-90101
2008031	Precision reference specimen, without certificate	EMD-90010
4346020	Data connection cable RS232C (2 m)	2000 r
4346023	2000 USB data connection cable USB (2 m)	2000 USB

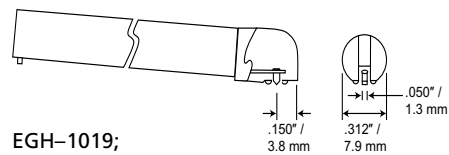

EGH-1019;
EGH-1026



EAS-2421



EAS-2584



EAS-2739



EAS-2839

PS 10 – Mobile measuring made easy

The MarSurf PS 10 is the ideal entry level instrument for surface metrology: Its extraordinarily simple and intuitive operation, along with numerous safety functions including the automatic cutoff, make the device as easy to control as a cellphone. Due to its minimal size, it is also perfect for location-independent measurements – vertical, horizontal and even overhead if necessary. And thanks to the removable drive unit, the MarSurf PS 10 can be used flexibly in production.

The measuring instrument boasts three order options for increased flexibility: with stylus tip 2 µm, 5 µm and also a variant with a transverse drive unit (MarSurf PS 10 C2).

- Intuitive operation: As easy as using a smartphone with a rotatable display
- Creates complete PDF measuring records right in the measuring instrument and data backup as TXT, X3P, CSV and PDF files
- Customized comments for the PDF measuring record entered directly into the MarSurf PS 10
- Error-free operation thanks to an integrated, removable roughness standard
- Automatic cutoff selection, ensuring that even non-specialists get the correct measuring results

9

other optional
probes

Always at hand

The calibration standard stays in the instrument and can be checked at any time.

500 g
lightweight



Extremely easy to operate with detailed profile display

The large 4.3" high-resolution and backlit TFT touch display allows intuitive operation and precise representation of the measuring profile.

Perfect evaluation and documentation

Measuring records are automatically created in the instrument without the need for additional software.

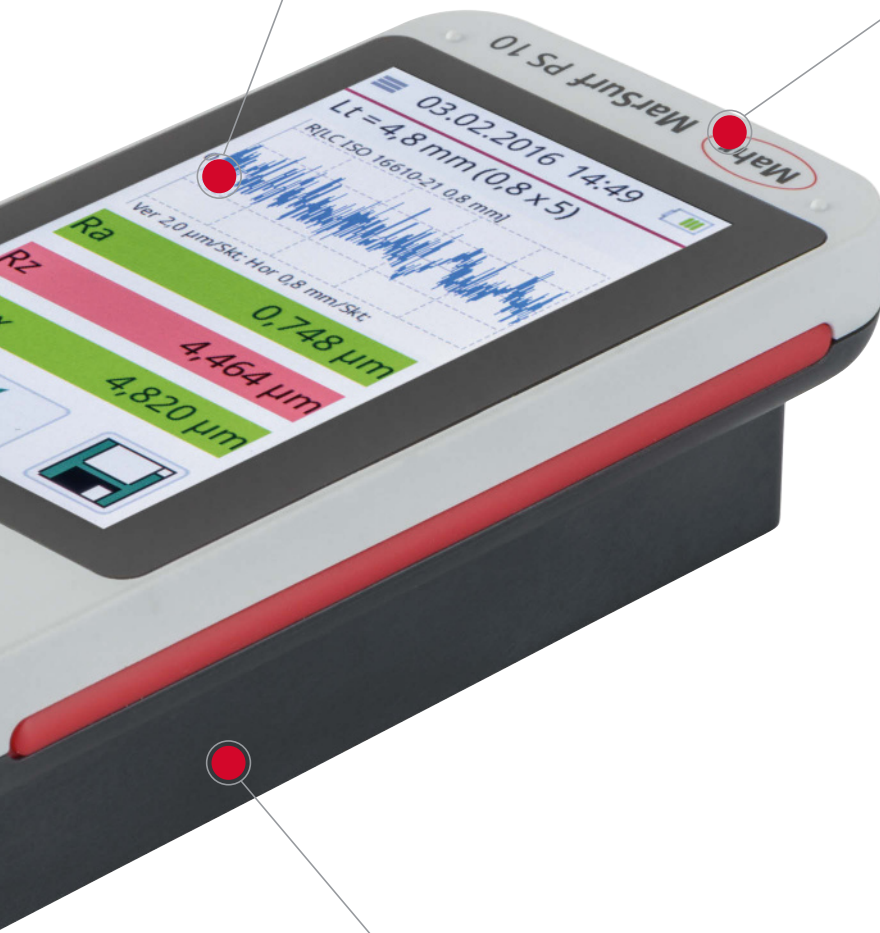

up to

500,000

measurements

can be stored in the instrument

31

parameters

same range of functions as a laboratory instrument

4.3"

TFT touch display

similar to a smartphone

Flexible use

The removable drive unit, in conjunction with the optional handheld support, lends this instrument added versatility where space is limited, e.g. in holes or when measuring small parts.

at least

1,200

measurements

without power supply



FEATURES

MarSurf PS 10 – simple, smart and mobile

- Compact roughness measuring instrument for mobile use
- Simple and intuitive to use: as easy as using a smart phone
- Large, illuminated 4.3" TFT touch display
- Adjustable display
- Data backup as TXT, X3P, CSV or PDF file
- Create complete PDF measuring records directly in the measuring instrument
- Customized comments for the PDF measuring record can be entered directly into the MarSurf PS 10
- Mains-independent operation: Over 1200 measurements without having to recharge the instrument
- An all-in-one solution. Small and lightweight (approx. 500 g)
- Instrument flexibility: removable drive unit
- 31 surface parameters: offer the same range of functions as a laboratory instrument
- Roughness standard stored within housing aids in reducing errors
- Quick access to your frequently used functions via the Favorites list in the display
- Automatic cutoff selection, so even non-specialists can be sure of getting the correct measuring results
- Additional version with transverse drive unit available as MarSurf PS 10 C2 (item number 6910235)

Package contents:

- MarSurf PS 10 unit
- Drive unit (detachable)
- 1 standard probe conforming to standards
- Built-in rechargeable battery
- Roughness standard integrated into housing (detachable), including Mahr calibration certificate
- Probe protection
- Power source with 3 adapters
- Operating instructions
- Carry case with shoulder strap
- USB cable
- Extension cable for drive unit (length 1.2 m)
- Height adjustment (integrated)
- **Software:** MarCom Professional free download: www.mahr.com/marcom (only for Mahr data cables and wireless systems with USB and RS-232 interface)



Applications:

- For shafts and housing components
- For large machines
- For large workpieces
- For milled and turned parts
- For ground and honed workpieces
- On the production line or directly on the machine; ideal for rapid testing of the surface roughness of a workpiece

TECHNICAL DATA

Order no.	6910230	6910232
Type	PS 10	
Parameters	Ra, Rq, Rz (Ry (JIS) is equivalent to Rz), Rz (JIS), Rmax, Rp, RpA (ASME), Rpm (ASME), Rpk, Rk, Rvk, Mr1, Mr2, A1, A2, Vo, Rt, RPl, Rmr (tp (JIS, ASME) is equivalent to Rmr), RSm, RSk, RS, CR, CF, CL, R, Ar, Rx, R3z	
Stylus	2 µm	5 µm
Calibration function	Dynamic; Ra, Rz, Rsm	
Storage capacity	Min. 3900 profiles, min. 500,000 results, min. 1500 PDF records, expandable to 32 GB with Micro SD card	
Languages	German, English, French, Italian, Spanish, Portugese, Dutch, Swedish, Russian, Polish, Czech, Japanese, Chinese, Korean, Hungarian, Turkish, Romanian	
Other	Lock/password protected, date/time	
Data interface	USB, MarConnect (RS-232), Micro SD slot for SD / SDHC cards up to 32 GB	
System of protection	IP 40	
Rechargeable batteries	Lithium-ion battery, min. 1200 measurements	
Wide range power supply	100 to 264 V	
H x W x D	mm	160 mm x 77 mm x 50 mm
Measuring principle	Stylus method	
Probe	Inductive skidded probe	
Measuring range	mm	0.350
Profile resolution	8 nm	
Filter according to ISO/JIS	Gaussian filter as per ISO 16610-21 (formerly ISO 11562), special filter as per DIN EN ISO 13565-1, Lambda s filter as per DIN EN ISO 3274 (can be switched off)	
Cutoff lc according to ISO/JIS	0.25 mm, 0.8 mm, 2.5 mm, automatic filter detection	
Number n of sampling length according to ISO/JIS	Selectable: 1 to 16	
Short stroke under ISO/JIS	Selectable	
Traversing length Lt according ISO/JIS	1.5 mm, 4.8 mm, 15 mm, N x Lc, variable, automatic	
Traversing length according ISO 12085 (MOTIF)	1 mm, 2 mm, 4 mm, 8 mm, 12 mm, 16 mm	
Evaluation length ln according to ISO/JIS	1.25 mm, 4.0 mm, 12.5 mm	
Measuring force	N	0,00075
Positioning speed	0.5; 1.0	

ACCESSORIES

Order no.	Description	Type
6850540	PHT pick-up extension 80 mm	PHT (80 mm)
6111520	Standard probe 2 μm	PHT 6–350
6111526	Standard probe 5 μm	PHT 6–350/ 5 μm
6111527	Standard probe 10 μm	PHT 6–350/ 10 μm
6111521	Probe for bores with a diameter larger than 3 mm	PHT 3–350
6111524	Probe for grooves	PHT 11–100
6111525	Probe for concave and convex surfaces	PHTR–100
6111522	Probe for gear tooth flanks	PHTF 0.5–100
6111523	Probe for metal sheets	PT 150
6850715	Pick-up protection with header V-block, steel	PHT-ts4
7028530	Pick-up protection header V-block, plastic	PHT-ts3
6910209	Mount PS 10/M310 on measuring stand ST	ST-a3
6910435	RD 18 C / PS 10 upright holder for cylindrical drive unit, \varnothing 8 mm	ST-a2
6710803	Measuring stand 300 mm with cast iron base	ST-D
6710806	Measuring stand 300 mm with granite plate	ST-F
6710807	Measuring stand 300 mm with granite plate and T-slot	ST-G
2247086	Adjustable mounting bracket to connect to 814 SR	814 Sh
4426100	Height measuring and scribing instrument, 0 –350 mm	814 SR
4426101	Height measuring and scribing instrument, 0 –600 mm	814 SR
4102357	16 EXu data connection cable USB (2 m) (hardware Revision 1)	16 EXu
4102603	Data cable USB bi-directional (2 m) (hardware Revision 2)	DK-U1
6710401	V-block	PP
6710604	Parallel vice	PPS
6710529	XY Table	CT 120
4246819	Set of miniature precision vises, set contents: mini-vises, jaw widths 15 / 25 / 35 mm, with tripod and V-blocks and miniature dividing attachments	109 PS
6820420	Roughness standard with Mahr calibration certificate, profile depth 10 μm	PRN 10
4413000	Measuring tripod with triangular pedestal 300 mm	815 GN
4413001	Measuring tripod with triangular pedestal 500 mm	815 GN
4413005	Measuring tripod with triangular pedestal 750 mm	815 GN
4416000	Measuring tripod with magnetic base	815 MA
6299054	Evaluation software	SW XR 20
6910240	Protective films for LCD, real glass (3 pieces)	SF LCD
680000DKS	Geometric standard, sinusoidal profile	MGs 1
680000KAL	Geometric standard, sinusoidal profile	MGs 1
680001DKS	Geometric standard, sinusoidal profile	MGs 3
680001KAL	Geometric standard, sinusoidal profile	MGs 3
680002DKS	Geometric standard, sinusoidal profile	MGs 10
680002KAL	Geometric standard, sinusoidal profile	MGs 10

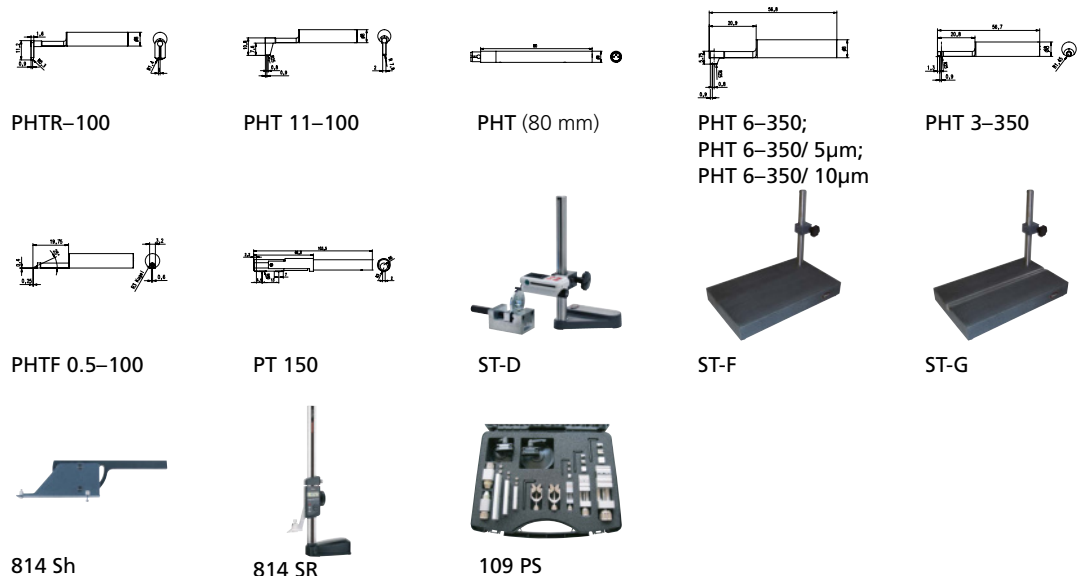

M 310 – Brings added value for mobile roughness measurement

Are you used to using your smartphone to access your data anytime, wherever you are? That is exactly what Mahr's MarSurf M 310 provides you with: A versatile device for the mobile recording and evaluation of measuring data. Simple operation and a robust design

make this Mahr product perfectly suited for use in production, where dirt and dust can clog the instrument and it is often users with little prior knowledge performing the quality control.

For all those who need more

The **MarSurf M 310** has the same functions as the PS 10 but has even more crucial added benefits for you:

- 1 Print directly, document easily**
Measuring results in paper form? Sometimes still the fastest way! The mobile printer allows you to save data on thermal paper, which can then be added directly to the workpiece.
- 2 Preprogrammed measuring functions for immediate measuring success**
A variety of measuring parameters can be defined, saved and then called up on the workpiece in the device settings. Additionally, it works using a barcode scanner, which simply connects to the MarSurf M 310. This allows even workers without expert knowledge or training to determine reliable roughness parameters.
- 3 Robot ready: Integrate instrument directly in the production line**
The MarSurf M 310 and its interfaces can be directly integrated into your production lines, such as for measuring tasks on the robot arm. They control the measuring instrument remotely – conveniently from your computer, for example.

Status at a glance

Instrument status at a glance thanks to two easily visible status LEDs. Depending on the signal color, a measurement is underway, data is being transferred or an error has been detected. Standby mode shows the charging status.

Robust in every respect

Equipped for virtually any environment: The robust skidded probe system means that the measuring instrument is less sensitive to vibrations. The PHT probe is easy to clean due to its open skid.

Modern optics, perfect display

A high resolution, backlit 4.3" TFT display ensures precise display of your measuring results. It is operated directly via the touchscreen – just as you are used to with your smartphone.

IATF compliant

The MarConnect duplex interface enables the transmission of a measuring equipment ID with each measurement. This makes measuring results traceable at any time.



ISO 21920 ready

At the turn of the year 2021/22, the new roughness standards DIN 21920-1 to 3 take effect. The MarSurf M 310 is compliant with these new standards.

Software with a success guarantee

With this measuring instrument, you can reliably determine roughness parameters even without expert knowledge or training – due to intuitive software, clear menu structures and preprogrammed measuring functions.



MarSurf M 310 / M 310 C2 for transverse measurement / M 310 with printer

Mobile roughness measuring instrument

FEATURES

Mobile roughness measurement – guaranteed success!

- Compact roughness measuring instrument for mobile use
- Simple and intuitive to use: as easy as using a smartphone
- Large, illuminated 4.3" TFT touch display
- Adjustable display
- Micro USB interface for remote control using ASCII commands, e.g. using software for statistical process control
- USB-A interface - for connection of e.g. a USB Bluetooth adapter or the USB/Bluetooth printer
- Wireless transmission of measurement results via Bluetooth stick to the free MarCom software
- Remote start of measurement via cable or Bluetooth
- Connection of a scanner for automatic start of the measuring programs or reading of protocol texts via barcode or QR code
- Specification of the intersection line C in μm or in % of Rz for the parameters Rmr and tp
- Data backup as TXT, X3P, CSV or PDF file
- Transfer of measuring records and data optionally via Bluetooth or cable
- IATF 16949 compliant – safe traceability with MarConnect
- Print directly on mobile printer (as option or directly in set with printer)
- Create complete PDF measuring records directly in the measuring instrument
- Customer-specific comments for the PDF measuring record can be entered directly into MarSurf M 310
- Display and printout of the MRC and ADC diagram
- Storage of measuring programs (quick and easy)
- **Mains-independent operation:** Over 1200 measurements without having to recharge the instrument
- An all-in-one solution. Small and lightweight (approx. 500 g)
- Instrument flexibility: removable drive unit
- **31 thread parameters:** offer the same range of functions as a laboratory instrument.
- Roughness standard stored within housing aids in reducing errors
- Quick access to your frequently used functions via the Favorites list in the display
- Automatic cutoff selection, so even non-specialists can be sure of getting the correct measuring results
- Additional versions with transverse drive unit available as MarSurf M 310 C2 or MarSurf M 310 set without probe
- Free software "MarWin Easy



Applications:

- For shafts and housing components
- For large machines
- For large workpieces
- For milled and turned parts
- For ground and honed workpieces
- On the production line or directly on the machine, ideal for rapid testing of the surface roughness of a workpiece in or on the machine

TECHNICAL DATA

Order no.	6910260	6910264	6910265	6910267	6910268
Type	M 310	M 310 C2 for Transverse measurement	M 310	M 310 with printer	
Parameters	A1, A2, Ar, CF, CL, CR, Mr1, Mr2, R, R3z, R _{Pc} , R _S , R _{Sk} , R _{Sm} , Ra, Rk, R _{max} , R _{mr} (tp (JIS, ASME) is equivalent to R _{mr}), R _p , R _{pA} (ASME), R _{pk} , R _{pm} , R _{pm} (ASME), R _q , R _t , R _{vk} , R _x , R _z , R _z (JIS), R _z (Ry (JIS) is equivalent to R _z), V _o				
Stylus			5 μm	2 μm	5 μm
Calibration function	Dynamic; Ra, Rz, R _{sm}				
Storage capacity	Min. 3900 profiles, min. 500,000 results, min. 1500 PDF measuring records, expandable to 32 GB with microSD card (320x memory capacity)				
Languages	German, English, French, Italian, Spanish, Portugese, Dutch, Swedish, Russian, Polish, Czech, Japanese, Chinese, Korean, Hungarian, Turkish, Romanian				
Other	Lock/password protected, date/time				
Data interface	USB A, USB B, MarConnect (bidirectional), Micro SD slot for SD / SDHC cards up to 32 GB				
System of protection	IP 40				
Rechargeable batteries	Lithium-ion battery, 3.7 V, nominal capacity 11.6 Wh, min. 1200 measurements				
Wide range power supply	100 to 264 V				
H x W x D	mm	160 mm x 77 mm x 50 mm			
Measuring principle	Stylus method				
Probe	Inductive skidded probe				
Measuring range	0.350				
Profile resolution	8 nm				
Filter according to ISO/JIS	Gaussian filter as per ISO 16610-21 (formerly ISO 11562), special filter as per DIN EN ISO 13565-1, Lambda s filter as per DIN EN ISO 3274 (can be switched off)				
Cutoff lc according to ISO/JIS	0.25 mm, 0.8 mm, 2.5 mm, automatic filter detection, variable				
Number n of sampling length according to ISO/JIS	Selectable: 1 to 16				
Short stroke under ISO/JIS	Selectable				
Traversing length Lt according ISO/JIS	1.5 mm, 4.8 mm, 15 mm, N x Lc, variable, automatic				
Traversing length according ISO 12085 (MOTIF)	1 mm, 2 mm, 4 mm, 8 mm, 12 mm, 16 mm				
Evaluation length ln according to ISO/JIS	1.25 mm, 4.0 mm, 12.5 mm				
Measuring force	N	.00075			
Positioning speed	0.5; 1.0				

Roughness Viewer" for further documentation (statistics, multiple profiles and results on one page etc.) available for download on the Mahr website.

Package contents:

- MarSurf M 310 basic device
- Drive unit (detachable)
- 1 standard probe PHT6-350,

conforming to standards

- Built-in rechargeable battery
- Roughness standard integrated into housing (detachable), including Mahr calibration certificate
- Probe protection / V-block holder
- Charger / 3 adapters
- Height adjustment (integrated)
- Carry case with shoulder strap

• USB cable

- Hand-held support with height adjustment (pair)
- Roughness standard integrated into housing (detachable), including Mahr calibration certificate
- Extension cable for drive unit (length 1.2 m)
- Operating instructions

MarSurf M 310

Mobile roughness measuring instrument

ACCESSORIES

Order no.	Description	Type
6910271	Printer set for MarSurf M 310	DP-B1
4102603	Data cable USB bi-directional (2 m)	DK-U1
3028620	USB 2D scanner Honeywell Xenon 1900	Handset scanner cable
3003856	USB Bluetooth adapter	USB BT
3028820	2D scanner Bluetooth Zebra DS2278	Handset scanner BT
6850540	PHT pick-up extension 80 mm	PHT (80 mm)
6111520	Standard probe 2 μm	PHT 6-350
6111526	Standard probe 5 μm	PHT 6-350/ 5 μm
6111527	Standard probe 10 μm	PHT 6-350/ 10 μm
6111521	Probe for bores with a dia. larger than 3 mm	PHT 3-350
6111524	Probe for grooves	PHT 11-100
6111525	Probe for concave and convex surfaces	PHTR-100
6111522	Probe for gear tooth flanks	PHTF 0.5-100
6111523	Probe for metal sheets	PT 150
6850715	Pick-up protection with header V-block, steel	PHT-ts4
7028530	Pick-up protection header V-block, plastic	PHT-ts3
6910209	Mount PS 10/M310 on measuring stand ST	ST-a3
6910435	RD 18 C / PS 10 upright holder for cylindrical drive unit, \varnothing 8 mm	ST-a2
6710803	Measuring stand 300 mm with cast iron base	ST-D
6710806	Measuring stand 300 mm with granite plate	ST-F
6710807	Measuring stand 300 mm with granite plate and T-slot	ST-G
2247086	Adjustable mounting bracket to connect to 814 SR	814 Sh
4426100	Height measuring and scribing instrument, 0 -350 mm	814 SR
4426101	Height measuring and scribing instrument, 0 -600 mm	814 SR
6710401	V-block	PP
6710604	Parallel vice	PPS
6710529	XY Table	CT 120
4246819	Set of miniature precision vises, set contents: mini-vises, jaw widths 15 / 25 / 35 mm, with tripod and V-blocks and miniature dividing attachments	109 PS
6820420	Roughness standard with Mahr calibration certificate, profile depth 10 μm	PRN 10
4413000	Measuring tripod with triangular pedestal 300 mm	815 GN
4413001	Measuring tripod with triangular pedestal 500 mm	815 GN
4413005	Measuring tripod with triangular pedestal 750 mm	815 GN
4416000	Measuring tripod with magnetic base	815 MA
6299054	Evaluation software	SW XR 20
6910240	Protective films for LCD, real glass (3 pieces)	SF LCD
6850500	Magnetic fixture PS 10 / M 310	MH
6820521	PS 10 Gage / Geometric Standard incl. Mahr Calibration Certificate	PS 10 KN Mahr
6299436	Software MarWin 13 EasyRoughness mobile	M 310 PC
6800000DKS	Geometric standard, sinusoidal profile	MGs 1
6800000KAL	Geometric standard, sinusoidal profile	MGs 1
6800001DKS	Geometric standard, sinusoidal profile	MGs 3
6800001KAL	Geometric standard, sinusoidal profile	MGs 3
6800002DKS	Geometric standard, sinusoidal profile	MGs 10
6800002KAL	Geometric standard, sinusoidal profile	MGs 10

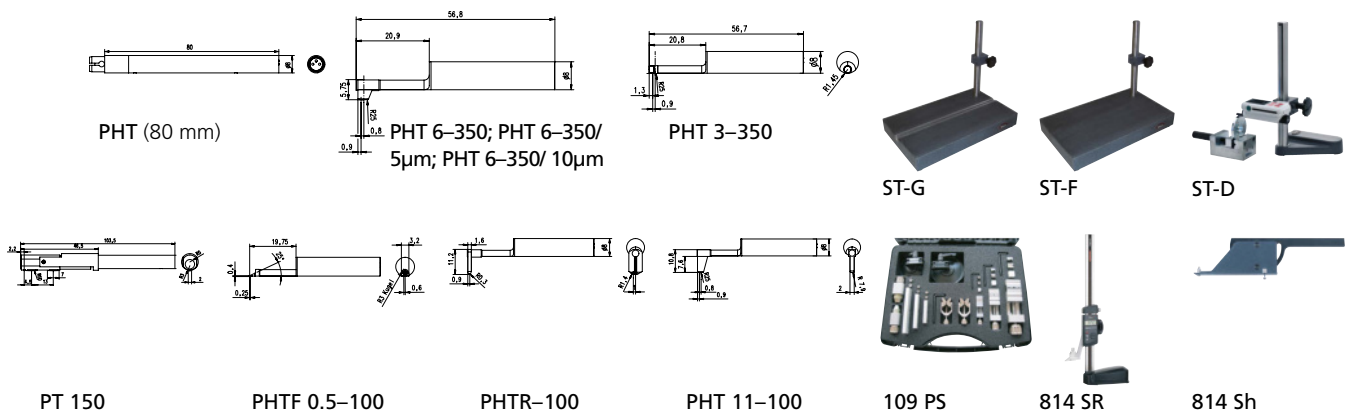

MarSurf M 310 PC

Mobile roughness measuring instrument

FEATURES

- Over 80 parameters for R-, P- and W-profiles according to current ISO/JIS or MOTIF standards (ISO 12085)
- Bandpass filter Ls in accordance with current standard; Ls can also be switched off or varied as required
- Comprehensive measuring records
- Quick and easy measuring programs can be created fast using teach-in methods
- Automatic function for choosing cut-off and traversing length in accordance with standards
- Support for various calibration methods (static and dynamic) by specifying the Ra or Rz parameter
- Adjustable maintenance and calibration intervals
- Multiple measuring station configurations for custom applications
- Range of options provide system flexibility
- Various user levels protect the device against misuse and prevent unauthorized people from using it
- Profile processing
- User-defined parameters
- QS-STAT
- QS-STAT Plus
- Dominant waviness
- ISO 13565-3 parameter
- Digital I/O
- MarSurf M 310 PC
- **Clever combination:**
 - The MarSurf M 310 & MarWin
 - The MarSurf M 310 can be used as a drive unit together with MarWin Easy Roughness software. It can be easily connected to the computer by cable or Bluetooth wireless technology. This use combines the handiness of the Mahr M 310 with the wider range of functions of the software. It allows you to evaluate even more parameters and optimally analyze your measuring results without compromising on flexibility and ease of use. The PC-based instrument delivers all common thread parameters and profiles in accordance with international standards, both in the measuring room and in production. MarSurf M 310 PC from Mahr stands for innovative roughness evaluation software.

Package contents:

- Software MarWin Easy Roughness mobile incl. Mahr license key with standard license
- MarSurf M 310 Set, 2 µm probe tip



Applications:

Mechanical engineering

Bearings, shafts, racks, valves, various components from the engineering and precision engineering industry

Automotive industry

Steering, brake system, gearbox, crankshaft, camshaft, cylinder head, cylinder block, turbocharger

Medicine

Surface roughness measurement for hip and knee endoprostheses

Aerospace

Turbine components

Optics

Various optical components

TECHNICAL DATA

Order no.	6910295	
Type	M 310 PC	
Measuring principle	Stylus method	
Probe	Inductive skidded probe	
Filter according to ISO/JIS	Gaussian filter as per ISO 16610-21 (formerly ISO 11562), special filter as per DIN EN ISO 13565-1, Ls filter as per DIN EN ISO 3274 (can be switched off)	
Cutoff l_c according to ISO/JIS	0.25 mm, 0.8 mm, 2.5 mm, automatic filter detection, variable	
Number n of sampling length according to ISO/JIS	Selectable: 1 to 16	
Short stroke under ISO/JIS	Selectable	
Traversing length according to ISO 12085 (MOTIF)	1 mm, 2 mm, 4 mm, 8 mm, 12 mm, 16 mm	

MarSurf M 310 PC

Mobile roughness measuring instrument

ACCESSORIES

Order no.	Description	Type
3028620	USB 2D scanner Honeywell Xenon 1900	Handset scanner cable
3028820	2D scanner Bluetooth Zebra DS2278	Handset scanner BT
3003856	USB Bluetooth adapter	USB BT
6910271	Printer set for MarSurf M 310	DP-B1
4102603	Data cable USB bi-directional (2 m)	DK-U1
6850540	PHT pick-up extension 80 mm	PHT (80 mm)
6111520	Standard probe 2 µm	PHT 6-350
6111526	Standard probe 5 µm	PHT 6-350/ 5µm
6111527	Standard probe 10 µm	PHT 6-350/ 10µm
6111521	Probe for bores with a dia. larger than 3 mm	PHT 3-350
6111524	Probe for grooves	PHT 11-100
6111525	Probe for concave and convex surfaces	PHTR-100
6111522	Probe for gear tooth flanks	PHTF 0.5-100
6111523	Probe for metal sheets	PT 150
6850715	Pick-up protection with header V-block, steel	PHT-ts4
7028530	Pick-up protection header V-block, plastic	PHT-ts3
6910209	Mount PS 10/M310 on measuring stand ST	ST-a3
6910435	RD 18 C / PS 10 upright holder for cylindrical drive unit, Ø 8 mm	ST-a2
6710803	Measuring stand 300 mm with cast iron base	ST-D
6710806	Measuring stand 300 mm with granite plate	ST-F
6710807	Measuring stand 300 mm with granite plate and T-slot	ST-G
2247086	Adjustable mounting bracket to connect to 814 SR	814 Sh
4426100	Height measuring and scribing instrument, 0 -350 mm	814 SR
4426101	Height measuring and scribing instrument, 0 -600 mm	814 SR
6710401	V-block	PP
6710604	Parallel vice	PPS
6710529	XY Table	CT 120
4246819	Set of miniature precision vises Set contents: mini-vises, jaw widths 15 / 25 / 35 mm, with tripod and V-blocks and miniature dividing attachments	109 PS
6820420	Roughness standard with Mahr calibration certificate, profile depth 10 µm	PRN 10
4413000	Measuring tripod with triangular pedestal 300 mm	815 GN
4413001	Measuring tripod with triangular pedestal 500 mm	815 GN
4413005	Measuring tripod with triangular pedestal 750 mm	815 GN
4416000	Measuring tripod with magnetic base	815 MA
6299054	Evaluation software	SW XR 20
6910240	Protective films for LCD, real glass (3 pieces)	SF LCD
6850500	Magnetic fixture PS 10 / M 310	MH
6820521	PS 10 gage / Geometric Standard incl. Mahr Calibration Certificate	PS 10 KN Mahr
6800000DKS	Geometric standard, sinusoidal profile	MGs 1
6800000KAL	Geometric standard, sinusoidal profile	MGs 1
6800001DKS	Geometric standard, sinusoidal profile	MGs 3
6800001KAL	Geometric standard, sinusoidal profile	MGs 3
6800002DKS	Geometric standard, sinusoidal profile	MGs 10
6800002KAL	Geometric standard, sinusoidal profile	MGs 10

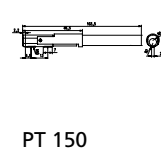
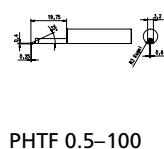
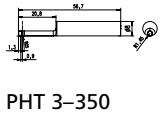
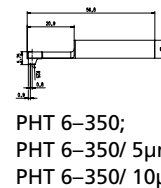
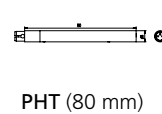
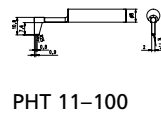
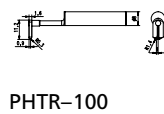

Twin pack with unlimited possibilities

Together with the BFW 250 probe system, the MarSurf M 400 evaluation instrument makes up an unbeatable twin pack: In addition to roughness profiles, highly accurate, standard waviness measurements can be carried out – location-independent in production or in measuring rooms. The reason for this is the integrated skidless probe system that allows a special depth depending on the probe arm – up to 30 mm in grooves, for example.

In addition, the handy tool can also be quickly combined with a number of probe arms without the use of tools thanks to the magnetic probe arm holder. The large selection also ensures that the broad measuring range is tripled from 500 μm to up to 1.500 μm .



Always keep track

With vibrant color display and simple user guidance, you can allocate your results anytime.

On-site documentation

Use the integrated thermal printer for profiles and results to print out your evaluations on site.

Flexible and mobile handling

Select the system that works for you: either wireless with Bluetooth connection or the wired version. Whatever you decide, you can always choose between plugging in to a power supply or using the battery, which means you never lose mobility.

Reliable metrology, reliable results

The highly precise probe system ensures that any skidless tracing as per ISO, JIS or ASME works. Complies with standard measuring point density at all times.



Short setup time, quick change

Due to the motorized height adjustment of the drive unit with automatic zero setting, all you need is a few seconds for setup. It is equally fast to change the probe arm thanks to the magnetic holder.

Scope of delivery (both sets):

- MarSurf M 400 evaluation instrument
- MarSurf SD 26 drive unit including BFW 250 probe system
- Standard probe arm (6852403)
- Thermal paper
- Wide-range power supply unit with 3 adapters
- 2 x USB cables (for connecting to the PC and for use with cable)
- Operating instructions
- Delivery in easy-to-handle transport case

MarSurf M 400

Mobile surface measuring instrument

FEATURES

MarSurf M 400. The best of the "mobiles"

- Surface evaluation using skidless tracing is not only needed in the measuring room but is required more and more in production as well.
- This usually means higher demands on operator qualities, more time, more adjustment work.
- In the line of "mobile surface metrology", MarSurf M 400 offers this required scope of performance and at the same time simple and fast operability.
- Mobile and stationary measuring instrument
- Roughness and waviness measurements
- Traversing lengths up to 26 mm
- Over 50 R, W and P surface parameters
- Automatic choice of cut-off and traversing length in accordance with international standards
- Dynamic calibration function
- Cable and Bluetooth connection between drive unit and evaluation instrument (4 m) (MarSurf M 400 C is only with cable connection)
- Magnetic probe holder (break away probe) BFW 250
- Motorized probe zero setting (max. 7.5 mm)

Supplied with:

- MarSurf M 400 evaluation instrument
- MarSurf SD 26 drive unit including BFW 250 probe system
- Standard probe arm (6852403)
- 1 roll of thermal paper
- Wide-range power supply unit with 3 adapters
- 2 USB cables (for connecting to the PC and the M 400)
- Operating instructions
- Case

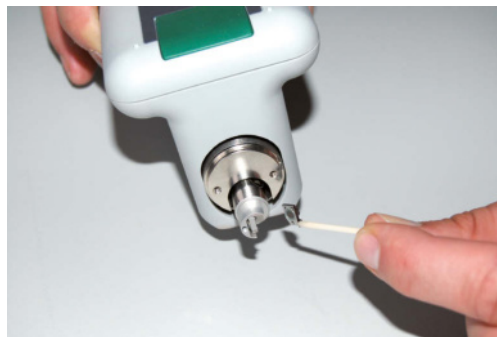
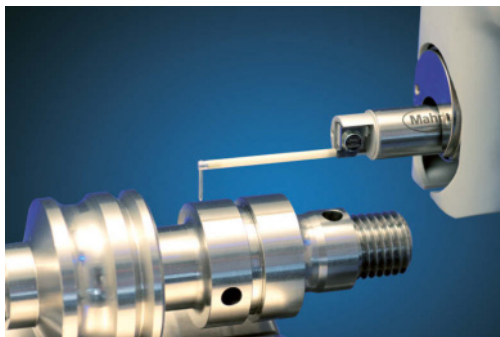

TECHNICAL DATA

Measuring principle	Stylus method
Probe	BFW skidless system
Measuring range	+/-250 µm (up to +/-750 µm with 3x probe arm length)
Profile resolution	Measuring range +/-250 µm: 8 nm Measuring range +/-25 µm: 0.8 nm
Filter according to ISO/JIS	Gaussian filter as per ISO 11562 Filter as per ISO 13565
Cutoff l_c according to ISO/JIS	0.08 mm, 0.25 mm, 0.8 mm, 2.5 mm, automatical, variable
Number n of sampling length according to ISO/JIS	1-5
Contacting speeds	0.2 mm/s; 1.0 mm/s
Measuring force	0.75 mN
Positioning speed	0.5; 1.0
Surface parameters	Over 50 surface parameters for R, P and W profiles according to current ISO/JIS or MOTIF standards (ISO 12085)

APPLICATIONS

Mechanical engineering

Bearings, shafts, racks, valves

Automotive industry

Steering, brake system, gearbox, crankshaft, camshaft, cylinder head, cylinder block, turbocharger

Steel industry

Measurement of sheet metal surfaces
Measurement of roller surface

Medicine

Surface roughness measurement for hip and knee endoprostheses

Aerospace

Turbine components

ACCESSORIES

Measuring stand

ST-D, ST-F and ST-G
Holder on measuring stand

Other accessories

CT 120 XY table, parallel vise, V-block
Assorted probe arms for the BFW probe system



For more information, please visit our website: www.mahr.com

MarSurf | PC-based stationary surface measuring stations

Versatile and powerful in measuring rooms and laboratories

PC-based surface measuring instruments represent the cutting edge in surface measurement and evaluation incorporating international standards, versatile evaluation methods, comprehensive documentation, large storage capacity, data export/import and networking with other systems. Extensive Quality Assurance procedures guarantee the highest quality and stability of software and hardware.



MarSurf CD 140 AG 11: Versatile with intelligent probe system

Mahr has launched a new contour measuring machine on the market – the MarSurf CD 140 AG 11. Its probe system has a measuring range of up to 70 mm and the stylus tips can be replaced quickly and without any tools – without having to recalibrate the system.

The new contour measuring machine MarSurf CD 140 AG 11 enables the user to complete fast and precise measurements. Its flexible workpiece holder makes it particularly easy to handle, while users are also convinced by its extreme versatility – it can also be used to measure roughness. The intelligent probe system and magnetic stylus tip holder ensure the process to replace stylus tips without any tools is the most straightforward process to date. Operators can also choose from a comprehensive range of clamps and workpiece holders. The new MarSurf CD 140 AG 11 can be used in a static position or directly at the location of the workpiece.



Advantages

- Comprehensive contour measurement functions – fast and simple
- Quick adjustment of the Z-axis with handles that are simple to operate
- Replacement of the stylus tip without any tools
- Travel speed in the X-axis of up to 200 mm/s
- Simple program creation or single measurement using MarWin
- Automatic evaluation, best adjustment of contours, CAD contour comparison, and a lot more
- Flexible support plate with 50 mm bore grid for KMG workpiece holder, amongst other
- Optionally expandable with option of roughness measurements ($R_z > 2 \mu\text{m}$)
- Measurement with double stylus

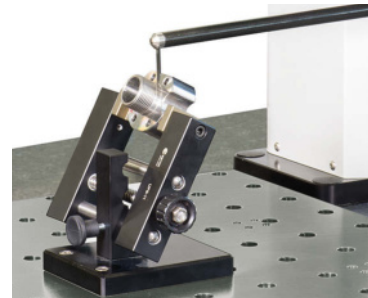
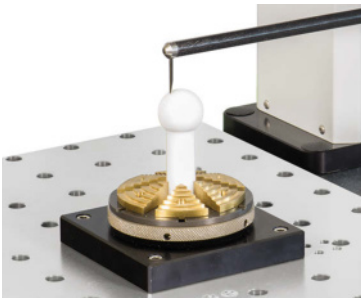
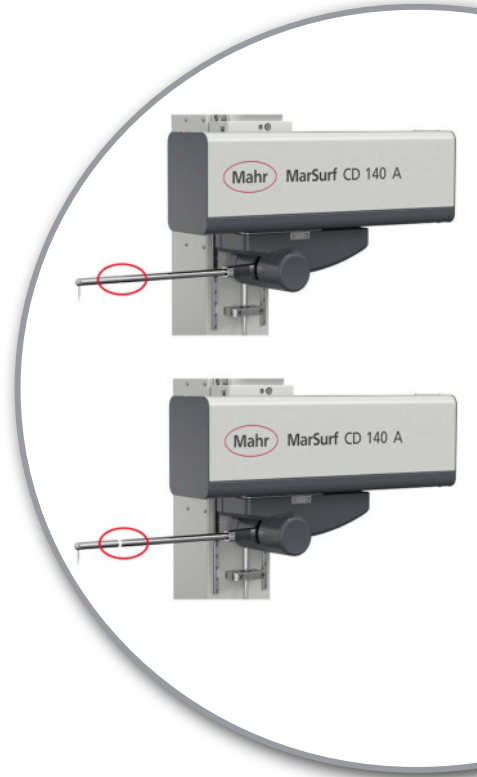

Plug-in guide stops and a wide range of standardized clamping devices as well as workpiece holders enable flexible positioning of your testpiece.

Manual quick adjustment

The fine adjustment is located in the Z-axis and moves the X-axis up and down.

Unique probe system

The probe system with a probe arm length of 350 mm enables a quick change of stylus tips without any tools and without having to recalibrate. The automatic tracing force selection guarantees the correct tracing force is selected when replacing several stylus tips.

X-axis with maximum measuring range

The high-speed X-axis is designed for a large measuring range of 140 mm.

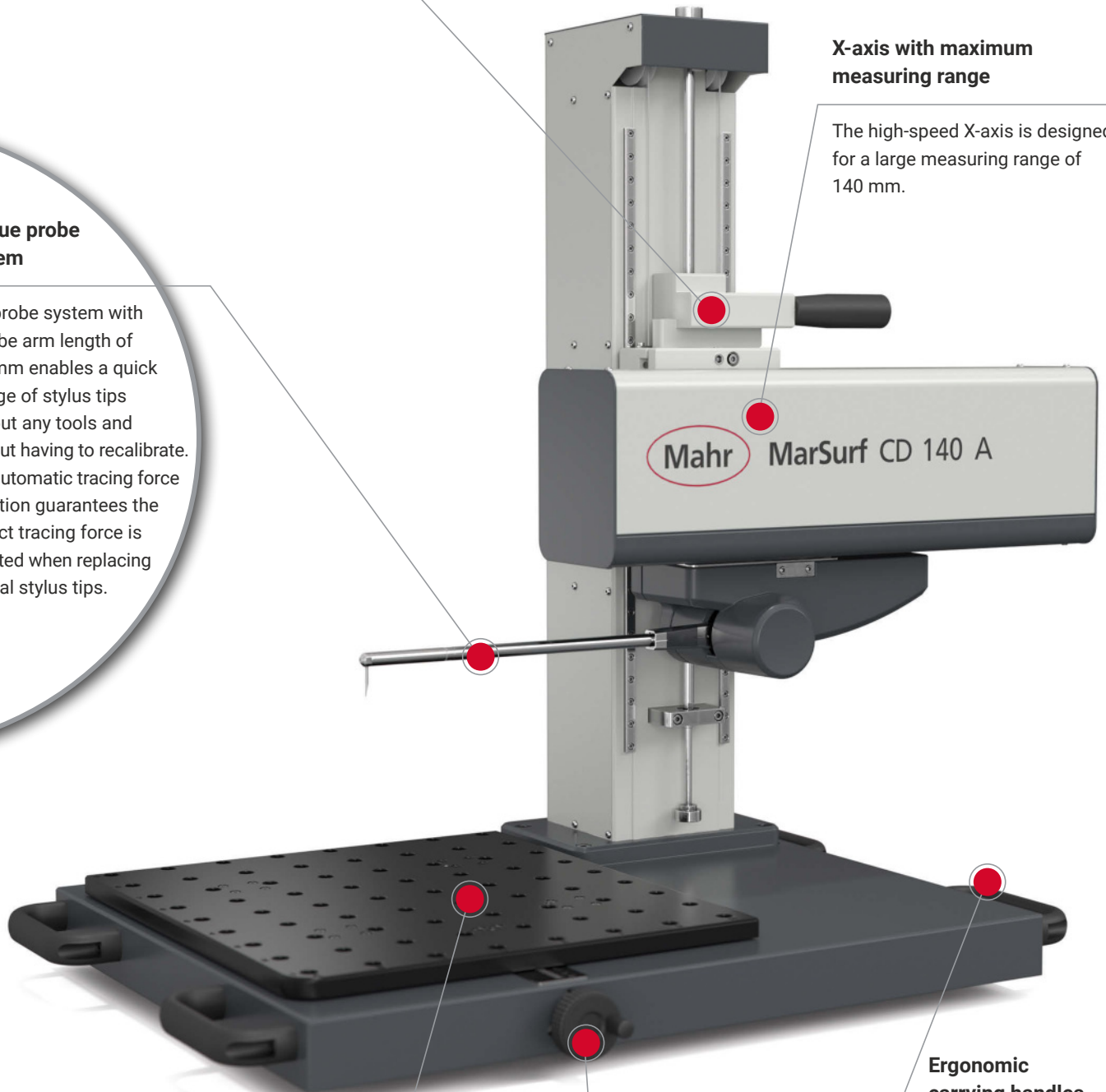

Support plate also for large components

The 390 mm x 450 mm large plate with 50 mm matrix of holes is also suitable for large-volume workpieces. This provides a variety of flexible clamping options.

Generous traverse path

The Y-axis can be adjusted manually with a traverse path of 60 mm.

Ergonomic carrying handles

The handles on the side make it easy to transport the device.

MarSurf XR 1

Roughness measuring station

FEATURES

MarSurf XR 1 is the ideal instrument for a low-cost introduction to user-friendly surface metrology.

- The PC-based instrument delivers all common surface parameters and profiles in accordance with international standards, both in the measuring room and in production. MarSurf XR 1 from Mahr stands for innovative roughness evaluation software.
- Over 80 surface parameters for R-, P- and W-profiles according to current ISO/JIS or MOTIF standards (ISO 12085)
- Bandpass filter Ls in accordance with current standard; Ls can also be switched off or varied as required
- Comprehensive measuring records
- Teach-in methods for the rapid creation of Quick&Easy measuring programs
- Automatic functions for choosing cut-off and traversing length in accordance with standards
- Support for various calibration methods (static and dynamic) by specifying the Ra or Rz parameter
- Adjustable maintenance and calibration intervals
- Multiple measuring station configurations for custom applications
- Range of options provide system flexibility
- Various user levels protect the device against misuse and prevent unauthorized people from using it

Drive units and probe options:

- Skidded or skidless tracing
- Drive units MarSurf GD 26 and/or MarSurf SD 26 and/or MarSurf RD 18

Supplied with:

- MarSurf XR 1, MarWin EasyRoughness Software, Mahr license key with standard license
- Drive unit adapter
- All-in-one PC optional
- MarSurf SD 26 and/or RD 18 drive unit set including probe system
- MFW 250 B probe system set
- MarSurf ST-G measuring stand
- CT 120 XY table



TECHNICAL DATA

XR 1	
Type	XR 1
Measuring principle	Stylus method
Probe	BFW skidless system with MarSurf SD 26 drive unit and/or PHT skidded system with MarSurf RD 18 drive unit
Measuring range	+/-250 µm (up to +/-750 µm with 3x probe arm length) applies to BFW system 350 µm applies to PHT probe system
Filter according to ISO/JIS	filter as per ISO 16610-21(replaced Gaussian filter as per ISO 11562), robust Gaussian filter a per ISO 16610-31
Number n of sampling length according to ISO/JIS	1 to 50 (default: 5)
Traversing lengths	MarSurf GD 26 / SD 26: Automatic; 0.56 mm*; 1.75 mm; 5.6 mm; 17.5 mm, 56 mm, Measurement up to stop, variable * Traversing length dependent on drive unit RD 18: Automatic; 1.75 mm; 5.6 mm; 17.5 mm
Measuring force	0.75 mN
Surface parameters	Over 80 surface parameters for R, P and W profiles according to current ISO/JIS or MOTIF standards (ISO 12085)

APPLICATIONS

Mechanical engineering

Bearings, shafts, racks, valves, various components from the engineering and precision engineering industry

Automotive industry

Steering, brake system, gearbox, crankshaft, camshaft, cylinder head, cylinder block, turbocharger

Medicine

Surface roughness measurement for hip and knee endoprostheses

Aerospace

Turbine components

Optics

Various optical components

ACCESSORIES

General software options:

- Dominant waviness (WDC) for MarWin
- ISO 13565-3 surface parameters
- QS-STAT / QS-STAT Plus
- Profile processing
- User defined parameters between operator and authorized personnel
- Contour 1 for MarSurf XR 1 / XR 20 (in conjunction with MarSurf SD 26 drive unit)
- Digital I/O set
- All options on one MLK



For more information, please visit our website: www.mahr.com

MarSurf GD 140 / GD 280

Roughness measuring station

FEATURES

Innovative technologies:

Fast axes

- Positioning speeds up to 200 mm/s in X
- 40 x faster than its predecessor MarSurf GD 120
- The Z-axis is fully CNC-capable by default
- The Z-axis is approx. twice as fast as previous Mahr Z-axes
- Up to 5 times faster than standard Z-axes on the market
- Contacting and zeroing via the Z-axis
- **New flexible probe system mount with BFW probe system**
- Simple probe arm change and probe arm protection by means of magnetic probe arm holder
- Probe arm holder allows the change from standard to transverse measurement without tools or adapters
- Extensions for the touch probe are possible
- **Innovative workpiece clamping system**
- Mounting plate 390 x 430 mm with bore dimension 50 mm
- Integrated 60 mm TY adjustment
- The combination of mounting plate and integrated TY adjustment makes an additional XY table superfluous
- Low workpiece setup supports a favorable short measurement loop, which has a positive effect on the measurement results

MarSurf GD: The new reference measuring station for roughness and waviness measurements

- The new Mahr measuring stations from the MarSurf GD series are setting new standards. In addition to surface roughness evaluations, profile, and waviness evaluations can also be performed. The new MarSurf GD series is enabling production companies to achieve a new dimension to reliably ensure and improve the production quality of workpieces in the measuring room or close to the production area.
- The new measuring station concept combines speed, security, and flexibility. The aim is to increase the cost-effectiveness of the system for your company.
- The measuring stations are operated with the user-friendly MarWin software (MarWin EasyRoughness or MarWin ProfessionalRoughness).



Applications:

Mechanical engineering

Bearings, threads, threaded bars, ball screws, shafts, racks

Production metrology

Contour measurement in a semi-automatic process

Automotive industry

Steering, brake system, gearbox, crankshaft, camshaft, cylinder head

Medical technology

Contour of hip and knee endoprosthesis, contour of medical screws, contour of dental implants

TECHNICAL DATA

Order no.	6269010	6269011	6269012	6269013
Type	GD 140		GD 280	
Probe	Roughness probe system (skidless)			
Measuring range	mm	500 µm (±250 µm) for probe arm length 45 mm 1500 µm (±750 µm) for probe arm length 135 mm		
Traversing lengths		0.1 mm to 140 mm	0.1 mm to 280 mm	
Measuring force	N	0.7 mN		
Resolution		Measuring range 1: 7.6 nm Measuring range 2: 0.76 nm		
Measuring speed		0,02 mm/s to 10 mm/s		
Positioning speed		X: 0.02 mm/s to 200 mm/s Z: 0.02 mm/s to 50 mm/s		

ACCESSORIES

Order no.	Description	Type
6821000	Manual control panel	
6710700	Option motorized TY axes for basement	
6820000	Calibration standard with 2 balls	Contour B
7003717	Shock and vibration absorbing system for basement	
6851345	Control unit for standard shock and vibration absorbing system	
6830144	Instrument desk 1710 mm x 870 mm x 750 mm	Table
7003789	Table for absorbing system for basement	
5356103	Control panel with monitor	
9026049	Table top 740 x 430 set	
6852551	Probe system extension for BFW probe system length 150 mm	
6852552	Probe system extension for BFW probe system length 300 mm	
6852553	Probe system extension for BFW probe system length 500 mm	
9000682	Depth extension MarSurf GD/VD 140/280	
6820020	Case of DK fixtures	DK
6820001	V-pieces set	AF 25
6820002	Delta block set	AF 25
6820003	Hold down set	AF 25
6820004	Screw-jack set	Alufix
6820005	Three-jaw chuck set	Alufix
680000KAL	Geometric standard, sinusoidal profile	MGs 1
680000DKS	Geometric standard, sinusoidal profile	MGs 1
680001KAL	Geometric standard, sinusoidal profile	MGs 3
680001DKS	Geometric standard, sinusoidal profile	MGs 3
680002KAL	Geometric standard, sinusoidal profile	MGs 10
680002DKS	Geometric standard, sinusoidal profile	MGs 10
6820901KAL	Roughness standard	MRS 1.5
6820901DKS	Roughness standard	MRS 1.5
6820903KAL	Roughness standard	MRS 3
6820903DKS	Roughness standard	MRS 3



For more information, please visit our website: www.mahr.com

The new MarSurf product family

Best performance and precise results in every sprint

With their extremely fast CNC axes and a highly dynamic probe system, machines from the MarSurf CD, MarSurf GD and MarSurf VD series break all speed records. Even when it comes to handling, the instruments are optimized to save your valuable time.

Easy changeover

The **magnetic mount** and **one-time calibration** mean that probe arms can be changed quickly and easily. This saves time when switching to a different measuring task.

Time-saving positioning

Just a few hand movements are required for flexible positioning of workpieces on the large support plate. Thanks to the 50 mm bore grid, the integrated TY-axis and the plug-in guide stops, your workpiece is in the correct position in a flash. **Set up your measuring station in half the time!**

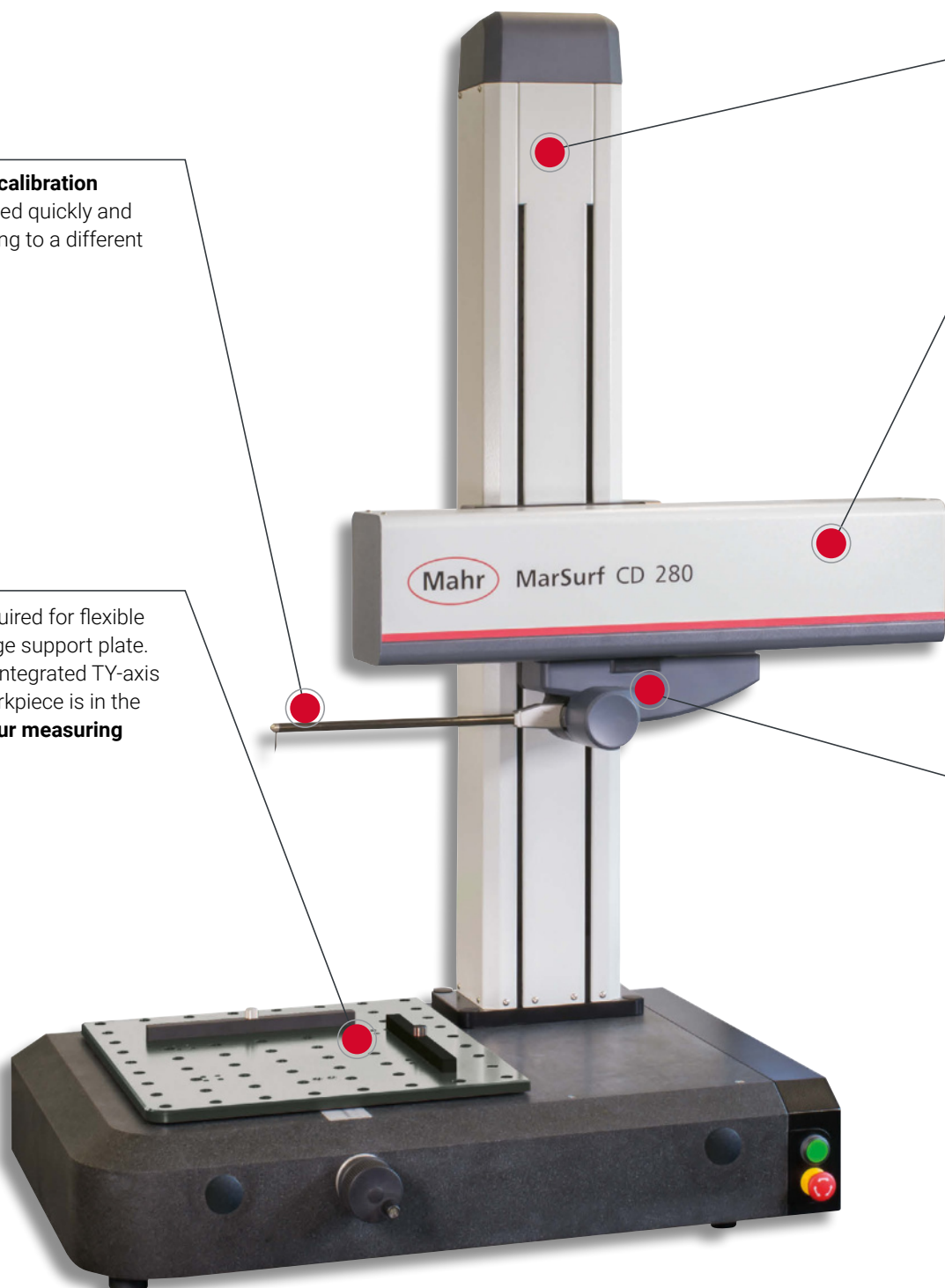

Quick axes

Z-axes with full CNC-capability and high-speed X-axes enable **positioning speeds of up to 50 mm/s in Z-direction and up to 200 mm/s in X-direction**. This means that the MarSurf instruments are particularly fast at getting to the start point of any measurement.

Short measuring times

The highly-dynamic probe system finds the perfect balance between rigidity and dynamics. **Which means you benefit from maximum accuracy at high measuring speeds of up to 10 mm/s.**

PERSONAL BEST!

Contour and surface measurement has never been as speedy as now. Our MarSurf CD 140 leads the way:

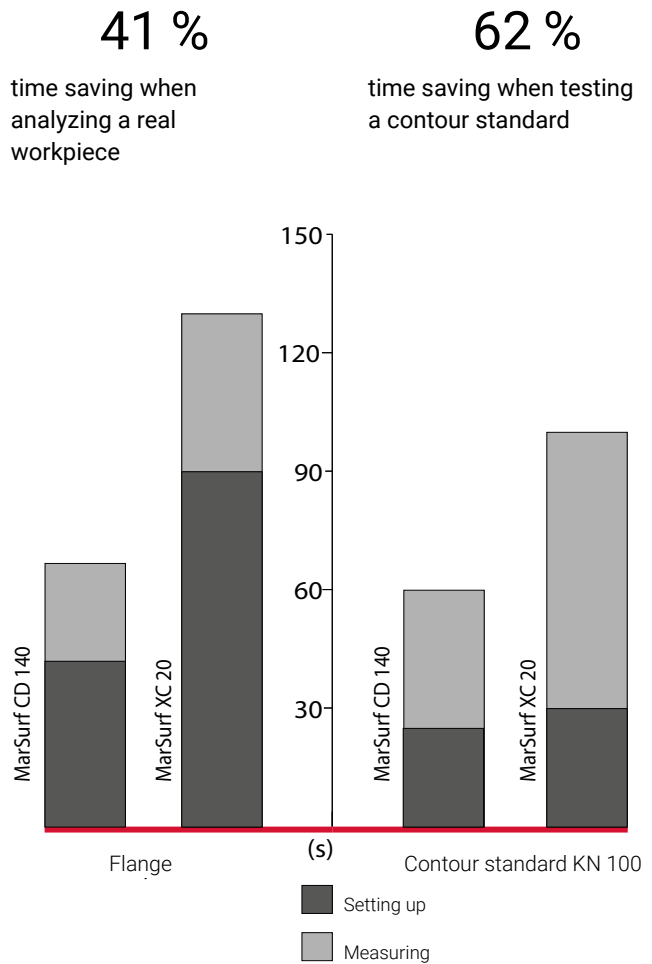

Ground-to-ground time of the new MarSurf CD 140 compared to a similar device.

MarSurf CD 140 A

Contour measuring station

FEATURES

- Traversing speed up to 200 mm/s in the x direction
- Quick adjustment of the Z-axis with easy-to-use handle
- Unique adjustment lock secures the adjusted measuring setup
- Fine adjustment for optimal alignment
- High speed measuring X-axis with 140 mm measuring range
- Integrated, manual 60 mm TY axis
- **Unique probe system**
- Tool-free quick change of probe tips saves time when changing over to another measuring task --> no recalibration required
- Magnetic probe holder
- Standard measuring range up to 70 mm
- Automatic measuring force selection guarantees the correct probe force when used in multiple stylus tip changes
- The low measuring force, starting at 4 mN, means that particularly "delicate" probe arms can be used, for example for small holes.
- Optional: Upgrade for roughness value determination
- **Innovative workpiece clamping system**
- Flexible support plate with 50 mm bore grid
- Integrated 60 mm TY adjustment
- The combination of support plate and integrated TY adjustment omits the need for an additional XY table
- A low workpiece setup supports an advantageous short measuring circuit, which has a positive effect on the measuring results
- A large support plate allows the workpiece to be positioned as required. This makes it easier to pick up larger parts.
- versatile with intelligent touch probe system
- Mahr has launched a new contour measuring machine on the market – its probe system has a measuring range of up to 70 mm and the stylus tips can be replaced quickly and without any tools – without having to recalibrate the system
- its enables the user to complete fast and precise measurements, its flexible workpiece holder makes it particularly easy to handle, while users are also convinced by its extreme versatility

Package contents:

- incl. 350 mm Z axis, 140 mm X axis, machine base with 50 mm hole grid and 60 mm Y adjustment
- Contact element PG A 36–350–25
- Software MarWin EasyContour



Applications:

Mechanical engineering

Bearings, threads, threaded rods, ball screws, shafts, racks

Measurement close to production

Contour measurement in a semi-automatic process

Automotive industry

Steering, brake system, transmission, crankshaft, camshaft, cylinder head

Medicine

Contour measurement for hip and knee endoprotheses, contour measurement for medical screws, contour measurement for dental implant

TECHNICAL DATA

Order no.	6269200	6269201
Type	CD 140 A	
H x W x D	mm	572 x 905 x 822 mm
Probe	Contour probe system	
Measuring range	mm	70 mm with probe arm length 350 mm
Measuring force	N	4 mN to 30 mN, adjustable using software
Resolution	19 nm	
Measuring speed	0.1 mm/s to 10 mm/s	
Positioning speed	X: 0.1 mm/s to 200 mm/s	

ACCESSORIES

Order no.	Description	Type
6820001	V-pieces set	AF 25
6820002	Delta block set	AF 25
6820003	Hold down set	AF 25
6820004	Screw-jack set	Alufix
6820005	Three-jaw chuck set	Alufix
6820020	Case of DK fixtures	DK
6820021	Quick release bracket with adapter plate	Alufix 25–50
6820022	Quick release bracket swivel unit	+90°/–55°
6820023	Precision three-jaw chuck	50 mm
6820024	Precision vise	35 mm
6820026	Spring compressor with attachment for Vee block	4 –50 mm
6820027	Quick release bracket angle element	45°
6820028	Vee block 120°, 60 mm Vee block length	V-block
6820010	MarSurf standard holder	CD/GD/VD
6830144	Instrument desk 1710 mm x 870 mm x 750 mm	Table
6710604	Parallel vice	PPS
6710401	V-block	PP
3028620	USB 2D scanner Honeywell Xenon 1900	Handset scanner cable
3028820	2D scanner Bluetooth Zebra DS2278	Handset scanner BT

plus mobile

- Calibration standard contour B with two balls (45 mm and 6 mm) including Mahr calibration certificate



For more information, please visit our website: www.mahr.com

MarSurf CD 140 / CD 280

Contour measuring station

FEATURES

- Positioning speeds up to 200 mm/s in X
- 25x faster than the predecessors MarSurf PCV and MarSurf CD 120
- All measuring stations of this series have a fully CNC-capable Z-axis
- The Z-axis is approx. twice as fast as previous Mahr Z-axes
- Up to 5x faster than the X-axes usually found on the market
- **highly dynamic, intelligent probe system**
- Probe arm recognition via integrated chip
- Standard measuring range up to 70 mm; max. 100 mm with 490 mm probe arms
- Magnetic probe arm mount, probe arm change without tools
- The probe system combines robustness with dynamics
- Optional: Expansion for roughness evaluation
- **Innovative workpiece clamping system**
- Mounting plate 390 x 430 mm with bore size 50 mm
- Integrated 60 mm TY adjustment
- The combination of mounting plate and integrated TY adjustment omits the needs for an additional XY table
- Low workpiece set-up leads to an advantageously short measuring circuit, which positively affects the measuring results
- **Contour measuring in a new dimension**
- The new MarSurf CD series from Mahr sets new standards when it comes to contour testing. With the new MarSurf CD series, manufacturing companies are entering a new dimension in order to reliably secure and improve the manufacturing quality of workpieces in the measuring room or close to production.
- The new measuring station concept combines speed, reliability and flexibility. The aim is to increase the profitability of the system for your company



Applications:

Mechanical engineering

Bearings, threads, threaded rods, ball spindles, shafts, racks

Measurements close to production

Semi-automatic contour measurement

Automotive Industry

Steering, brake system, transmission, crankshaft, camshaft, cylinder head

Medical technology

Contour of the hip and knee endoprostheses, contour on medical screws, contour on dental implants

TECHNICAL DATA

Order no.	6269000	6269001	6269002	6269003	6269004	6269005	6269006	6269007
Type	CD 140			CD 280				
Probe	Contour probe system							
Measuring range	mm	70 mm with probe arm 350 mm long max. 100 mm with 490 mm long probe arm						
Traversing lengths	0.1 mm to 140 mm				0.1 mm to 280 mm			
Measuring force	N	4 mN to 30 mN, adjustable via software						
Resolution	max. 6 nm (with 210 mm probe arm)							
Measuring speed	0.02 mm/s to 10 mm/s							
Positioning speed	X: 0.02 mm/s to 200 mm/s Z: 0.02 mm/s to 50 mm/s							

ACCESSORIES

Order no.	Description	Type
6821000	Manual control panel	
6710700	Option motorized TY axes for basement	
6820000	Calibration standard with 2 balls	Contour B
7003717	Shock and vibration absorbing system for basement	
6851345	Control unit for standard shock and vibration absorbing system	
6830144	Instrument desk 1710 mm x 870 mm x 750 mm	Table
7003789	Table for absorbing system for basement	
5356103	Control panel with monitor	
9026049	Table top 740 x 430 set	
6820020	Case of DK fixtures	DK
6820001	V-pieces set	AF 25
6820002	Delta block set	AF 25
6820003	Hold down set	AF 25
6820004	Screw-jack set	Alufix
6820005	Three-jaw chuck set	Alufix
6820010	MarSurf standard holder	CD/GD/VD
6820125KAL	Contour standard	KN 100
6820125DKS	Contour standard	KN 100
6800001KAL	Geometric standard, sinusoidal profile	MGS 3
6800001DKS	Geometric standard, sinusoidal profile	MGS 3
6800002KAL	Geometric standard, sinusoidal profile	MGS 10
6800002DKS	Geometric standard, sinusoidal profile	MGS 10
6820903KAL	Roughness standard	MRS 3
6820903DKS	Roughness standard	MRS 3



For more information, please visit our website: www.mahr.com

MarSurf VD 140 / VD 280

Roughness and contour measuring station

FEATURES

- Positioning speeds up to 200 mm/s in X
- Contour measurements are 25x faster than with its predecessor MarSurf PCV or MarSurf CD 120
- Surface measurements are 40 x faster than with the MarSurf GD 120
- By default, the Z-axis is fully CNC-capable
- The Z-axis is approx. twice as fast as previous Mahr Z-axes
- Up to 5 times faster than standard Z-axes on the market
- **Two reference probe systems for your measuring tasks**
- **Contour probe system C 11**
- Probe arm recognition via integrated chip
- Standard measuring range up to 70 mm; Max. 100 mm with 490 mm probe arm length
- Magnetic probe arm holder, probe arm change without tools
- The touch probe combines robustness with dynamics
- Optional: Possibility to extend the roughness value determination to contours
- **Roughness probe system BFW**
- Easy probe arm change and probe arm protection by means of magnetic probe arm holder
- Probe arm mount allows the change from standard to transverse measurement without tools or adapter
- Extensions for the probe system possible
- **Innovative workpiece clamping system**
- Mounting plate 390 x 430 mm with hole dimension 50 mm
- Integrated 60 mm TY adjustment
- The combination of mounting plate and integrated TY adjustment makes an additional XY table superfluous
- Low workpiece setup supports a favorable short measurement loop, which has a positive effect on the measurement results
- **MarSurf VD Series - The MarSurf family is complemented:**
- The easy change between roughness and contour tracing system
- Depending on the measuring task, either the BFW roughness probe system for surface roughness or the C 11 contour probe system for contour measurements can be changed by the operator (hot-plug capable). The new system offers the advan-



TECHNICAL DATA

Order no.	6269020	6269021	6269022	6269023
Type	VD 140		VD 280	
Probe	Roughness probe system (skidless) Contour probe system			
Measuring range	mm	with roughness probe system 500 µm (±250 µm) for probe arm length 45 mm 1500 µm (±750 µm) for probe arm length 135 mm with contour probe system 70 mm with probe arm length 350 mm max. 100 mm with probe arm length 490 mm		
Traversing lengths		0.1 mm to 140 mm	0.1 mm to 280 mm	
Measuring force	N	with roughness probe system: 0.7 mN 4 mN to 30 mN, adjustable via software		
Resolution		with roughness probe system: Measuring range 1: 7.6 nm Measuring range 2: 0.76 nm with contour probe system: max. 6 nm (with 210 mm probe arm)		
Measuring speed		0.02 mm/s to 10 mm/s		
Positioning speed		X: 0.02 mm/s to 200 mm/s Z: 0.02 mm/s to 50 mm/s		

- tages of combining the highly dynamic C 11 contour probe system with the high-precision BFW probe system, which is particularly suitable for fine surfaces.
- The new measuring station concept combines speed, reliability and flexibility.
 - The aim is to increase the profitability of the system for your company.
 - The measuring stations are operated with the user-friendly MarWin software (MarWin Easy Roughness & Contour or MarWin Professional Roughness & Contour).

APPLICATIONS

Mechanical engineering

Bearings, threads, threaded rods, ball screws, shafts, racks

Metrology close to production

Contour measurement in a semi-automatic process

Automotive industry

Steering, brake system, gearbox, crankshaft, camshaft, cylinder head

Medicine

Contour measurement for hip and knee endoprostheses, medical screws, dental implants

MarSurf VD 140 / VD 280

Roughness and contour measuring station

ACCESSORIES

Order no.	Description	Type
6821000	Manual control panel	
6710700	Option motorized TY axes for basement	
6820000	Calibration standard with 2 balls	Contour B
7003717	Shock and vibration absorbing system for basement	
6851345	Control unit for standard shock and vibration absorbing system	
6830144	Instrument desk 1710 mm x 870 mm x 750 mm	Table
7003789	Table for absorbing system for basement	
5356103	Control panel with monitor	
9026049	Table top 740 x 430 set	
6852551	Probe system extension for BFW probe system length 150 mm	
6852552	Probe system extension for BFW probe system length 300 mm	
6852553	Probe system extension for BFW probe system length 500 mm	
9000682	Depth extension MarSurf GD/VD 140/280	
6820020	Case of DK fixtures	DK
6820001	V-pieces set	AF 25
6820002	Delta block set	AF 25
6820003	Hold down set	AF 25
6820004	Screw-jack set	Alufix
6820005	Three-jaw chuck set	Alufix
6820125KAL	Contour standard	KN 100
6820125DKS	Contour standard	KN 100
6800000KAL	Geometric standard, sinusoidal profile	MGS 1
6800000DKS	Geometric standard, sinusoidal profile	MGS 1
6800001KAL	Geometric standard, sinusoidal profile	MGS 3
6800001DKS	Geometric standard, sinusoidal profile	MGS 3
6800002KAL	Geometric standard, sinusoidal profile	MGS 10
6800002DKS	Geometric standard, sinusoidal profile	MGS 10
6820901KAL	Roughness standard	MRS 1.5
6820901DKS	Roughness standard	MRS 1.5
6820903KAL	Roughness standard	MRS 3
6820903DKS	Roughness standard	MRS 3



For more information, please visit our website: www.mahr.com

The universal contour and surface measuring system

Combined contour and roughness measurements can be excellently solved by the proven cutting-edge technology of Mahr metrology. The MarSurf LD 130 and MarSurf LD 260 measuring stations are characterized by consistent further development and integration of the experience gained from the first generation. Measuring tasks in the various applications increasingly demand the combination of contour and roughness determinations. In order to meet these requirements, the measuring instruments must demonstrate enormous metrological performance. Resolutions in the sub-nanometer range as well as residual noise of < 20 nm Rz are just some of the of the required ancillary conditions.

Innovative touch probe solution

Combined contour and roughness measurements, in one go, can be excellently solved by the proven top technology of Mahr metrology.

Easy change

The **magnetic mount** and **automatic stylus detection** allow a quick, easy change of stylus arms. This saves time when changing over to a different measuring task.

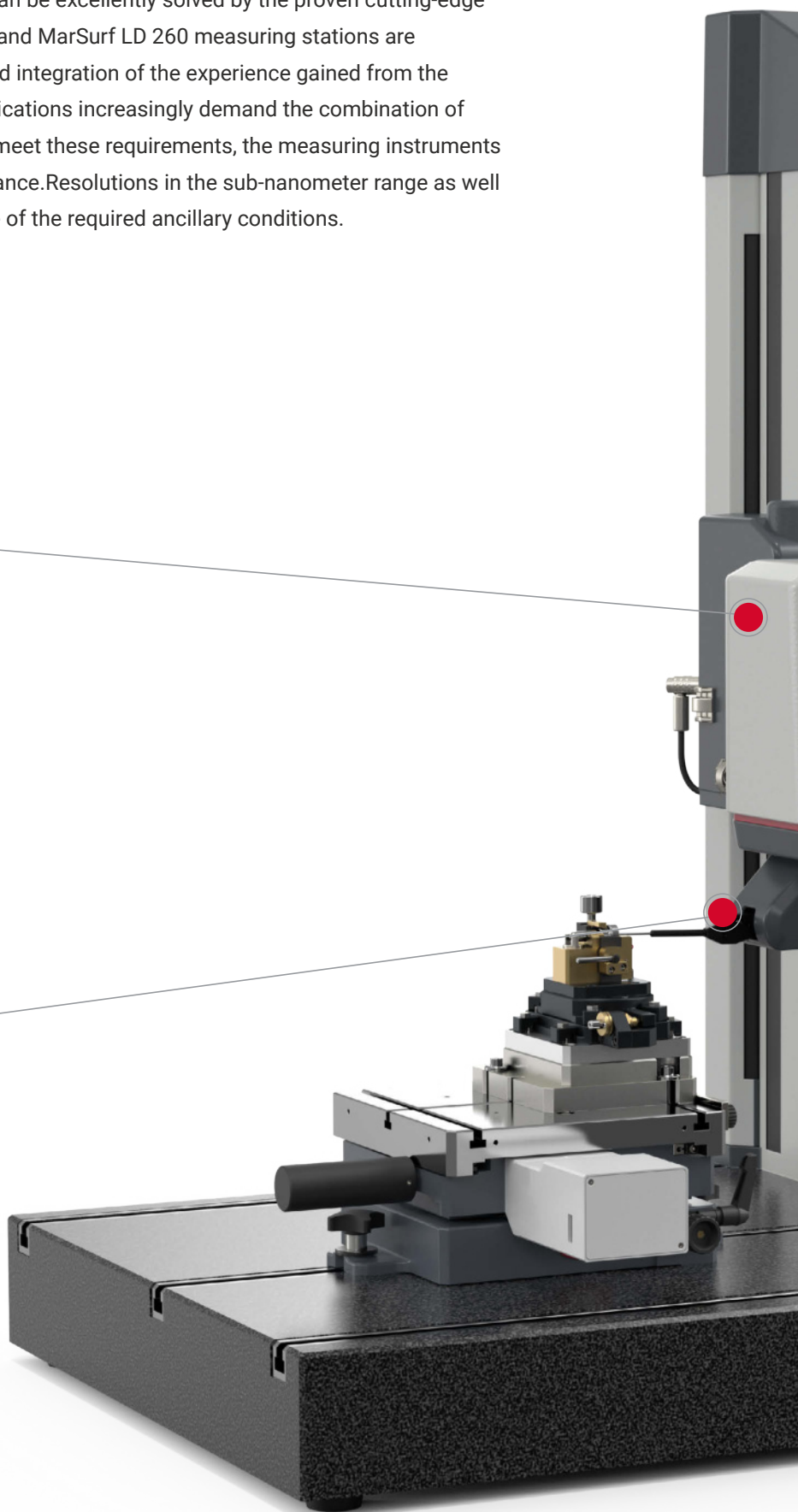



Fast axes

Fully CNC-capable axes allow positioning speeds of up to 200 mm/s. This enables the MarSurf devices to be particularly quickly positioned at the starting point of any measurement.

Reliable measurements

Bionic design of the probe arms and new materials ensure higher stiffness, lower vibration and higher dynamics.

MarSurf UD 130 / LD 130 / LD 260

Combined contour and surface measuring station

FEATURES

The MarSurf UD 130 closes the gap between the high-end solution MarSurf LD 130 / LD 260 and the new standard combination measuring station MarSurf VD 140 / 280 with two drive units. The technical specification of the MarSurf UD 130 is based on the high-quality interferometric probe system and the fast measuring and positioning speeds that have reduced the measuring times for each workpiece.

MarSurf LD 130 / LD 260. A step into a new dimension

- Combined contour and roughness measurements in just one step comes courtesy of proven cutting-edge technology from Mahr metrology. The MarSurf LD 130 and MarSurf LD 260 measuring stations have been systematically developed to draw on the experience from the first generation of equipment.
- Roughness and contour in just one step
- High measuring and positioning speed cuts measuring times dramatically
- Innovative probe system removal
- Quick and reliable probe arm exchange with simultaneous probe arm detection by magnetic holder
- Long measuring length up to 260 mm (MarSurf LD 260) with a measuring stroke of 13 mm (100 mm probe arm length) or 26 mm (200 mm probe arm length)
- Modular construction for ease of maintenance
- No need to fully dismantle the measuring stand for maintenance

Supplied with:

- MarSurf XCR 20 including midrange LD, MarWin software Easy Roughness & Contour, Mahr license key
- TFT monitor
- MCP 21 manual control panel
- MarSurf LD 130 or LD 260 drive unit including LP D 14–10–2/60 LP D 14–10–500 probe system and probe arms
- Calibration standard for contour 1, accuracy class 1
- MarSurf ST 500 CNC measuring stand with 700 mm x 550 mm granite plate (including control module)
- Dampening element set
- CT 300 XY table
- **MarSurf LD 130 / LD 260. A step into a new dimension**
- Combined contour and roughness measurements in just one step comes courtesy of proven

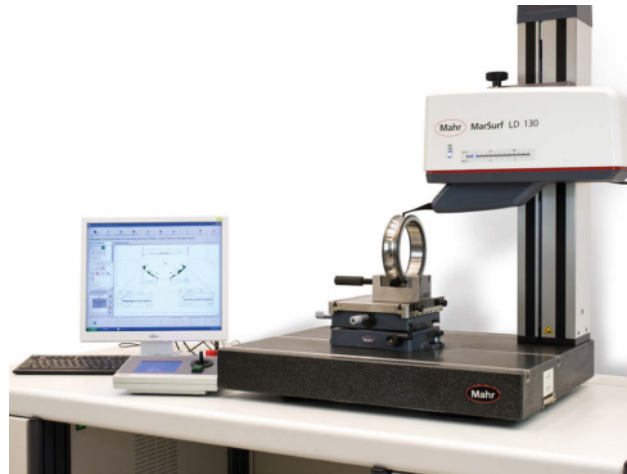

TECHNICAL DATA

	UD 130	LD 130	LD 260
Traversing lengths	0.1 mm to 130 mm	0.1 mm to 130 mm	0.1 mm to 260 mm
Measuring force	1 mN to 30 mN, software-adjustable	0.5 mN to 30 mN, software adjustable	0.5 mN to 30 mN, software-adjustable
Resolution	2 nm	0.8 nm	0.8 nm
Measuring speed	0.1 mm/s to 5 mm/s	0.02 mm/s to 10 mm/s	0.02 mm/s to 10 mm/s
Positioning speed	0.1 mm/s to 30 mm/s	0.02 mm/s to 200 mm/s	0.02 mm/s to 200 mm/s

APPLICATIONS

Mechanical engineering

Roller bearings, threads, threaded rods, ball screws, shafts, racks, ball heads, valves

Measurement close to the production area

Contour and surface roughness measurement in semi-automatic and fully automatic operation

Automotive industry

Engine parts including cylinder block, cylinder head, crankshaft, camshaft, valves, steering, gearbox, injection systems, turbocharger

Medicine

Contour and surface roughness measurement for hip and knee endoprostheses

Contour measurement for medical screws

Contour and surface roughness measurement for dental implants

Optics

Contour and surface roughness measurement of aspherical lenses

ACCESSORIES

- ST 750 measuring stand
- Parallel V-block
- V-block, equipment table
- Measuring cabinet
- Extensive range of probe arms
- Software options:
- Profile processing
- Dominant waviness (Wdc) for MarWin
- ISO 13565–3 surface parameters
- User defined parameters
- Topography
- Topography with MfM / MfM plus
- Thread Evaluation
- Chamfer evaluation (in accordance with Bosch standard)
- QS-STAT / QS-STAT Plus
- Digital I/O set

cutting-edge technology from Mahr metrology. The MarSurf LD 130 and MarSurf LD 260 measuring stations have been systematically developed to draw on the experience from the first generation of equipment.

- Roughness and contour in just one step
- High measuring and positioning speed cuts measuring times dramatically
- Innovative probe system removal
- Quick and reliable probe arm exchange with simultaneous probe arm detection by magnetic holder
- Long measuring length up to 260 mm (MarSurf LD 260) with a measuring stroke of 13 mm (100 mm probe arm length) or 26 mm (200 mm probe arm length)
- Modular construction for ease of maintenance
- No need to fully dismantle the measuring stand for maintenance

MarSurf CNC modular

FEATURES

The MarSurf CNC *modular* measuring stations are based on standard components. A standard surface measuring station can be expanded into a user-friendly, semi-automatic CNC measuring station simply by adding auxiliary table axes and possibly a measuring cabinet.



- Plug-and-play configuration of the control unit
- Easy to operate MarWin Software measuring wizard
- Universal concept for workpiece holder and clamp
- Minimal training required
- **Supplied with:**
- MarSurf LD 130 / LD 260 / UD 130 measuring station
- Including midrange CNC controller
- MarSurf ST 500 / 750 CNC measuring stand
- MCP 21 manual control panel

Optional table axes:

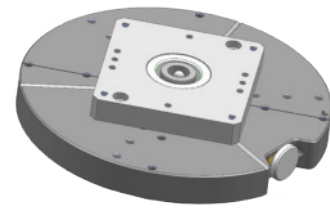
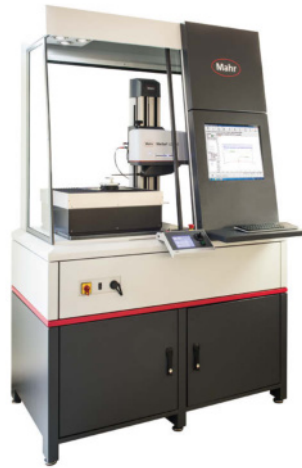
- T1S-L linear axis 200 mm
- T1S-R rotation axis
- T3S-LLR 3 table axes comprising 2 linear and one rotation axis
- **Optional measuring cabinet**



TECHNICAL DATA

	T1S-L Linear axis Complete with control module for midrange CNC Displacement path 200 mm Dimensions 510 mm x 200 mm x 200 mm Bearing strength 50 kg
	T1S-R Rotation axis Complete with standard support plate and control module for midrange CNC For use as a TA or TC axis Dimensions 270 mm x 200 mm x 210 mm Bearing strength 30 kg
	T3S-LLR 3 axis combination Complete with standard support plate and control module for midrange CNC Multiaxis, monolithic structure comprising axes TX, TY, TC Bearing strength 30 kg

APPLICATIONS

Measurement close to the production area

- Pallet measurement
- Topography measurement
- Multiple measuring points on one part without reclamping
- Automatic X-axis alignment
- Universal measuring station for a wide variety of measuring tasks

ACCESSORIES

- Table plate with clamping sphere adapter and universal clamping plate
- Standard measuring station upgraded to MarSurf CNC *modular*



For more information, please visit our website: www.mahr.com

MarSurf | 3D surface metrology for industry and research

Optical analysis of surface topographies and geometries

Due to their versatility, MarSurf 3D measuring systems can be used in many areas of industry, from quality control to serial measurements. Within a few seconds, they deliver accurate and repeatable 3D measurements of almost any material – metals, glass, ceramics, semiconductors, polymers or organic materials.

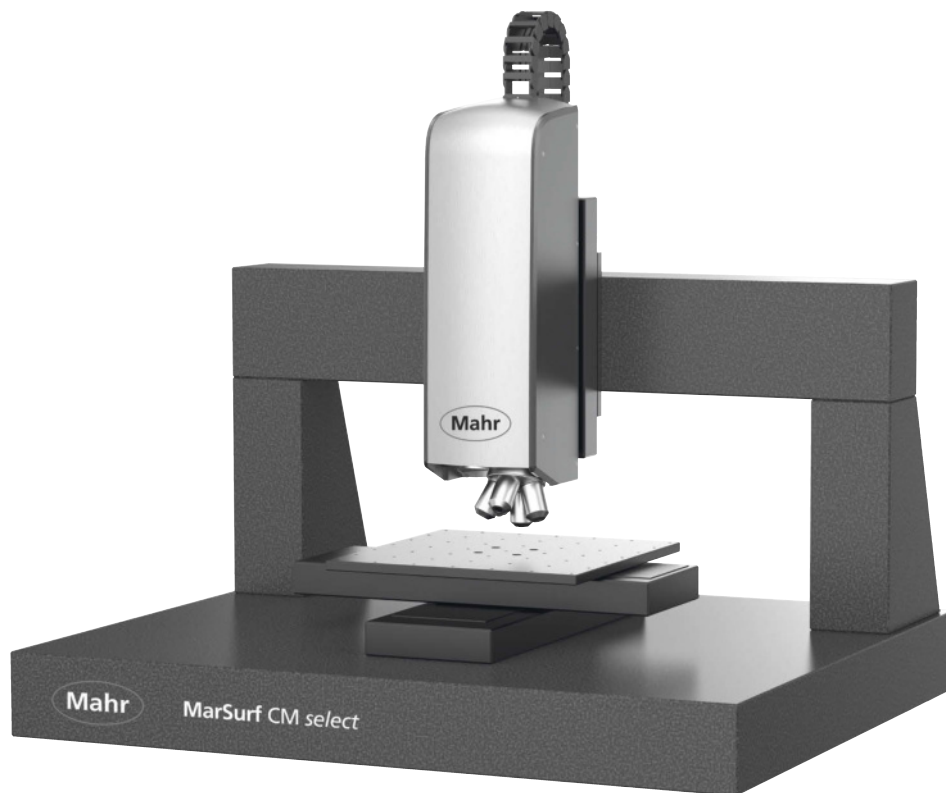

Overview MarSurf Surface measuring instruments	552
MarSurf CM <i>explorer</i> 3D surface measurement	556
MarSurf CM <i>expert</i> 3D surface measurement	557
MarSurf CM <i>mobile</i> 3D surface measurement	558
MarSurf CM <i>select</i> 3D surface measurement	559
MarSurf WI 50 M 3D surface measurement	562
MarSurf WI 50 3D surface measurement	563
MarSurf WI 100 3D surface measurement	564
MarSurf CP / CL <i>select</i> 3D profilometry	568
MarSurf 3D surface metrology - industries	569

Optical or tactile?

Selecting the right measuring equipment

When should you rely on tactile metrology and when does it make more sense to measure using established optical devices? As both methods are equally precise, delivering results with 99 % accuracy, it always comes down to the surface structures you want to measure and which parameters are relevant for your production. Mahr offers you versatile solutions for both types of systems. The following criteria will help you make your selection:

1

Process values in accordance with ISO 4287, ISO 13565, ISO 25178 und ISO 21920

Tactile and optical devices identify the roughness and sometimes the waviness of surfaces – all the while in compliance with the standards DIN EN ISO 4287 and DIN EN ISO 13565. Optical devices also comply with the standard DIN EN ISO 25178 and in future with the standard DIN EN ISO 21920, which allow for an extensive description of a surface without contact.

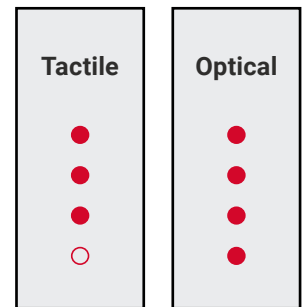

2

Get established process values in the blink of an eye

Roughness, waviness and primary profiles describe the surface and its properties. The parameters derived from that provide information about the quality of the surface. This guarantees reliability in the production process and makes it possible to carry out incoming goods checks quickly.

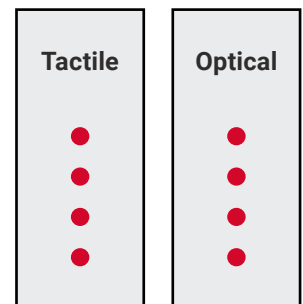

3

Statistical testing

When it comes to machined surfaces, structures are often no longer arranged in a certain direction but are distributed at random. A 2D section does not sufficiently describe them or, if it does, it is extremely time consuming. However, the extensive optical sampling of the surface provides more information and fast measuring results.

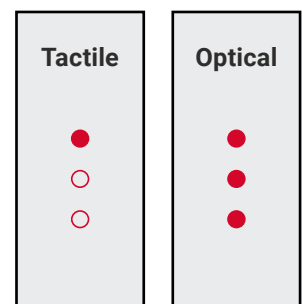



4

Measurement at the touch of a button

Simply place the probe arm on the surface, press the button and begin measurement – no need for complicated peripherals. Read the results directly on the display and print them out with the associated printer as desired. Enjoy all of this at an unbeatable price-performance ratio.

Tactile	Optical
●	○
●	○
●	○
●	○

5

Topological testing

When surfaces are extremely sensitive, soft, sticky or even discontinuous, non-contact and thus optical measurement is the method of choice. This applies equally to coated, inhomogeneous and complex surfaces as well as to surfaces without processing structures: It is best to scan and evaluate them optically.

Tactile	Optical
●	●
○	●
○	●
○	●

6

Easy accessibility

Both optical and tactile mobile devices enable reliable surface testing directly on the workpiece in the production area. To examine surfaces, small depressions or drill holes that are difficult to access, the removable drive units in tactile tools also present a particular advantage.

Tactile	Optical
●	●
●	●
●	○

Maximum signal quality thanks to multi-pinhole technology

Due to in-house developed and patented multi-pinhole technology, the powerful confocal microscopes in the MarSurf product line provide ultrafast image acquisition. This technology enables uniform random distribution as adjacent measuring points are not measured directly after one another. Beyond that, Mahr confocal microscopes set themselves apart due with their extremely low scatter and robust signaling at high light output. This allows you to achieve vertical resolutions into the nanometer range.

2_{nm}

Vertical optical resolution

99% CCF MAX

Maximum correlation to tactile measuring data

50,000_{MTBF}

LED light source

MPD technology

Artefact-free, quick, lowest noise figure, no preferential direction

TrueDetection technology

100-fold measuring point sampling, extremely stable measurements / repeatability

Piezo drive

for maximum vertical resolution

Objectives

Largest quadratic measuring fields, for roughness measurement in one measuring field / best homogenous lighting



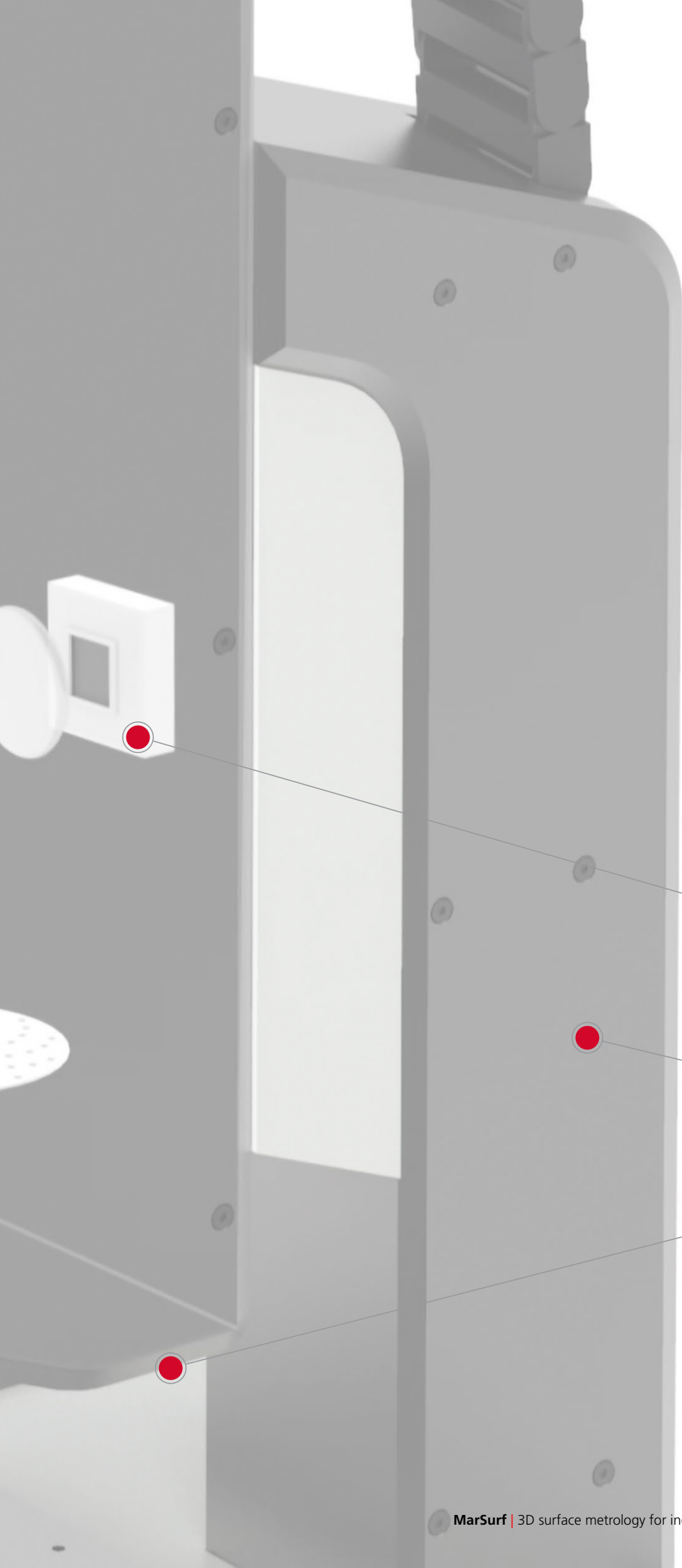

0.1 – 100 %

Reflectivity of all
sample surfaces

Measuring points per second

126,000,00

5_{sec}

Typical measuring time for 3D
roughness measurements

16-bit HDR camera

Optimal signal to noise ratio /
no increased noise with small
magnifications

Path length measuring system

Glass scales with path length
measuring system on all axes

Collision detection

in all directions – safe for
sample and system

MarSurf CM explorer

3D surface measurement

DESCRIPTION

The flexible, all-round measuring solution

The MarSurf CM *explorer* is a compact confocal microscope for the three-dimensional measurement and analysis of surfaces – **non-contact, material independent, and fast.**

The MarSurf CM *explorer* is suitable for use in test laboratories and equipped for quality assurance in production environments due to its robust construction and insensitivity to environmental influences.

Key benefits:

- High measuring speed – even at full resolution
- User-friendly concept
- Safety through collision detection in all directions to protect your workpiece and measuring system
- High Dynamic Range (HDR) function, 16-bit
- Consistent high resolution output of large measuring surfaces due to HD stitching

This established optical measuring system is successfully used, for example, for:

- Roughness measurement according to DIN EN ISO 4287 / 25178
- Topography measurement (including volume, wear, isotropy)
- Measurement of microgeometry and layer thicknesses

Users value the MarSurf CM *explorer* as a reliable measuring system that provides quantitative traceable 3D characteristics for many industries.

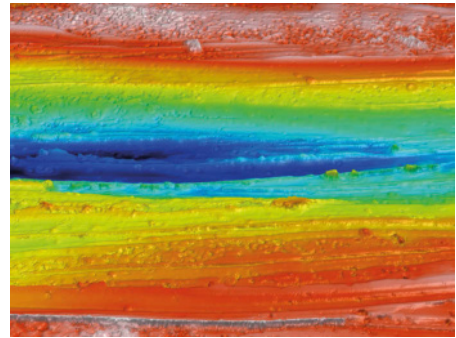

TECHNICAL DATA

CM explorer	
Type	CM explorer
Measuring principle	Confocal High-performance LED (505 nm / white)
Resolution	up to 2 (nm) vertical
Measuring speed	up to 100fps
Surface parameters	ISO 4287, ISO 13565, ISO 25178, ...

Supplied with: MarSurf CM *explorer*

- Confocal measuring head
 - HDR camera (B/W or color camera)
 - 4x lens revolver with identification
- L-tripod including control electronics
- Motorized XY table (50x50 mm) with glass scales for sample positioning and image field merging ("stitching")
- Motorized Z-axis (70 mm) with glass measuring scale
- Measuring system computer with 24" TFT monitor
- Objective lenses:
 - 5x to 100x selectable
- MarSurf MSW for intuitive data acquisition
- MarSurf MfM for professional evaluation, graphical representation and creation of measuring records (choice of Standard, Extended or Premium version)

APPLICATIONS

- **Mechanical engineering**
To qualify and quantify roughness, geometry and wear volume
- **Electronics and semiconductors**
Component inspection down to the sub-micrometer range for defect-free products
- **Medical technology**
Quality assurance of medical surfaces in production and laboratory
- **Material science**
Optimization of functional properties of new surfaces and products
- **Microsystems technology**
Measure complex surface geometries of smallest components with nanometer precision

MarSurf CM expert

3D surface measurement

DESCRIPTION

Automatable, high-end measuring system

The MarSurf CM *expert* is a powerful confocal microscope for the three-dimensional measurement and analysis of surfaces – **non-contact, material independent, and fast.**

The MarSurf CM *expert* is suitable for use in test laboratories and equipped for quality assurance in production environments due to its robust construction and insensitivity to environmental influences.

With additional manual Z positioning, a large x and y travel range and the possibility of automation, it offers excellent ease of use. The option of performing user-independent, fully automatic measurements makes this surface measuring system ideal for straightforward and efficient use in quality assurance.

Key benefits:

- User-independent serial measurements by automation software
- High measuring speed – even at full resolution
- User-friendly concept
- Safety through collision detection in all directions to protect your workpiece and measuring system
- High Dynamic Range (HDR) function, 16-bit
- Consistent high resolution output of large measuring surfaces due to HD stitching

This established optical measuring system is successfully used, for example, for:

- Roughness measurement according to DIN EN ISO 4287 / 25178
- Topography measurement (including volume, wear, isotropy)
- Measurement of microgeometry and layer thicknesses

Users value the reliability of this measuring system, which provides quantitative, traceable 3D characteristics for many industries.

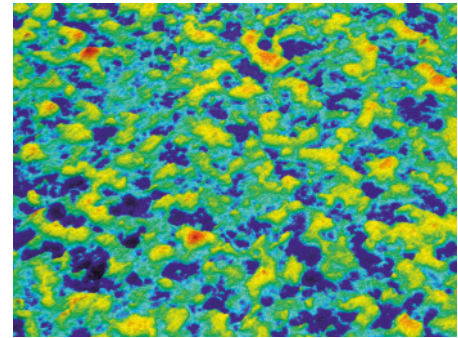

TECHNICAL DATA

CM expert	
Type	CM expert
Measuring principle	Confocal High-performance LED (505nm / white)
Resolution	up to 2 (nm) vertical
Measuring speed	up to 100fps
Surface parameters	ISO 4287, ISO 13565, ISO 25178, ...

Supplied with: MarSurf CM expert

- Confocal measuring head
 - HDR camera (B/W or color camera)
 - 4x lens revolver with identification
- L-tripod including control electronics
- Motorized XY table (100x100 mm) with glass scales for sample positioning and image field merging ("stitching")
- Motorized Z-axis (70 mm) with glass measuring scale
- Measuring system computer with 24" TFT monitor
- Objective lenses:
 - 5x to 100x selectable
- MarSurf MSW for intuitive data acquisition
- MarSurf ASW for automation (optional)
- MarSurf MfM for professional evaluation, graphical representation and creation of measuring records (choice of Standard, Extended or Premium version)

APPLICATIONS

- **Mechanical engineering**
To qualify and quantify roughness, geometry and wear volume
- **Electronics and semiconductors**
Component inspection down to the sub-micrometer range for defect-free products
- **Medical technology**
Quality assurance of medical surfaces in production and laboratory
- **Material science**
Optimization of functional properties of new surfaces and products
- **Microsystems technology**
Measure complex surface geometries of smallest components with nanometer precision



For more information, please visit our website: www.mahr.com

MarSurf CM *mobile*

3D surface measurement

DESCRIPTION

Can be used everywhere

The compact MarSurf CM *mobile* is a portable confocal microscope for the three-dimensional measurement and analysis of surfaces – **non-contact, material independent, and fast.**

The low dead weight and operation via a laptop enable it to be used flexibly for measurement on large objects and difficult to move samples, such as rollers.

- Mobile use enables testing to be completed directly on the component/tool – even if the idle period is minimal
- Compact system (5kg) with motorized axes for HD stitching
- Robust and reliable for use in production
- High measuring speed – even at full resolution
- User-friendly concept
- Consistent high resolution output of large measuring surfaces due to HD stitching

This established optical measuring system is successfully used, or example, for:

- Roughness measurement according to DIN EN ISO 4287 / 25178
- Topography measurement (including volume, wear, isotropy)
- Measurement of microgeometry and layer thicknesses

Users value the MarSurf CM *mobile* as a reliable measuring system that provides quantitative traceable 3D characteristics for many industries .

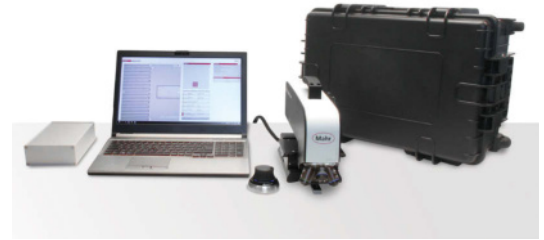

TECHNICAL DATA

CM mobile	
Type	CM <i>mobile</i>
Measuring principle	Confocal High-performance LED (505 nm)
Resolution	up to 2 (nm) vertical
Measuring speed	up to 100fps
Surface parameters	ISO 4287, ISO 13565, ISO 25178, ...

Supplied with:
MarSurf CM *mobile*

- Confocal measuring head
 - B/W or Colour camera
 - 4x lens revolver
- Control electronics integrated in the system, HDR camera
- Motorized XY table (50x50 mm) with glass scales for positioning and image field merging ("stitching")
- Motorized Z-axis (35 mm)
- Laptop or measuring system computer with 24" TFT monitor selectable
- Objective lenses:
 - 5x to 100x selectable
- MarSurf MSW for intuitive data acquisition
- MarSurf MfM for professional evaluation, graphical representation and creation of measuring records (choice of Standard, Extended or Premium version)

APPLICATIONS

- **Mechanical engineering**
Qualification and quantification of the roughness, geometry, and wear volume
- **Tool technology**
Component inspection right in to sub-micrometer range for fault-free products
- **Medical technology**
Quality assurance of medical surfaces in production and the laboratory
- **Materials science**
Optimization of functional features on new surfaces and products
- **Microsystems technology**
Measurement of complex surface geometries of the smallest components with nanometer precision



For more information, please visit our website: www.mahr.com

MarSurf CM *select*

3D surface measurement

DESCRIPTION

Tailor-made measurement of surfaces

The MarSurf CM *select* is a powerful, configurable confocal microscope for the three-dimensional measurement and analysis of surfaces – **non-contact, material independent, and fast.**

Axes and isolation systems as well as software modules can be combined as needed. This allows the measuring system to be adapted to different measuring tasks.

As a multi-sensor system, the MarSurf CM *select* also offers the possibility of combining different sensor technologies in one measuring device. Depending on the measuring task, the optimal point sensor can also be flexibly selected.

The MarSurf CM *select* meets your individual requirements for automation, measuring comfort and accuracy – right up to the fully automated measuring solution.

Key benefits:

- Designed for continuous operation
- Automation software with industrial interfaces for transfer to QA systems
- High measuring speed – even at full resolution
- Individually configurable to your sample size
- Multi-sensor system
- User-friendly concept
- Safety through collision detection in all directions to protect your workpiece and measuring system
- High Dynamic Range (HDR) function, 16-bit
- Consistent high resolution output of large measuring surfaces due to HD stitching

This established optical measuring system is successfully used, for example, for:

- Roughness measurement according to DIN EN ISO 4287 / 25178
- Topography measurement (including volume, wear, isotropy)
- Measurement of microgeometry and layer thicknesses

Users value the reliability of this measuring system, which provides quantitative, traceable 3D characteristics for many industries.

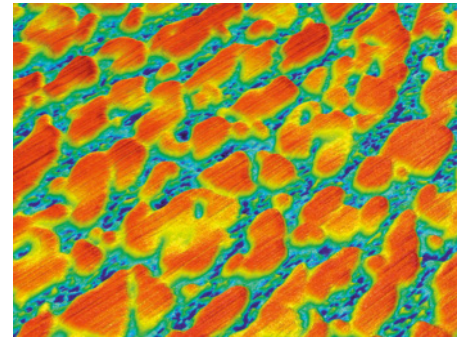

TECHNICAL DATA

CM <i>select</i>	
Type	CM <i>select</i>
Measuring principle	Confocal
Resolution	High-performance LED (505 nm / white) up to 2 (nm) vertical
Measuring speed	up to 100fps
Surface parameters	ISO 4287, ISO 13565, ISO 25178, ...

Supplied with: MarSurf CM *select*

- Confocal measuring head
 - HDR camera (BW or color camera)
 - 4x lens revolver with identification (optional)
- Gantry design including control electronics
- Motorized XYZ axes available in different variants
- Industrial computer including two 24" TFT monitors
- Objective lenses:
 - 5x to 100x selectable
- Vibration damping system available
- Multi-sensor system (optional)
- Overview camera (optional)
- MarSurf MSW for intuitive data acquisition
- MarSurf ASW for automation (optional)
- MarSurf MfM for professional evaluation, graphical representation and creation of measuring records (choice of Standard, Extended or Premium version)

APPLICATIONS

- **Mechanical engineering**
To qualify and quantify roughness, geometry and wear volume
- **Electronics and semiconductors**
Component inspection down to the sub-micrometer range for defect-free products
- **Medical technology**
Quality assurance of medical surfaces in production and laboratory
- **Material science**
Optimization of functional properties of new surfaces and products
- **Microsystems technology**
Measure complex surface geometries of smallest components with nanometer precision



For more information, please visit our website: www.mahr.com

Measuring topographies in the sub-nanometer range

The Mahr white light interferometer series comprises three powerful tools: the MarSurf WI 50 M, the MarSurf WI 50 and the MarSurf WI 100. They score with a very large positioning volume and the intuitive user software that is known and highly esteemed by Mahr customers of optical.

Your advantages

- Use of both phase information and amplitude
- Minimal noise figure
- High precision
- Maximum stability

Powerful ICA technology

The white light interferometer by Mahr is based on a novel algorithm that combines the best properties of traditionally used methods like PSI and VSI in a singular broad range of applications.

This algorithm searches for the best correlation and for this purpose compares each individual pixel. The resulting height values are very precise and robust. This minimizes the noise, which in consequence leads to a uniquely high data quality.

Hereby laboratories and quality assurance can determine the smallest roughness values, step heights or flatness in the nanometer range – all within a matter of seconds.

VDI/VDE 2655 | ISO 25178

Certified system acceptance

Low SNR

Signal-to-noise-ratio as standard

Up to 5 MP

High lateral resolution with maximum number of pixels

ICA technology

Intelligent Correlation Algorithm as standard

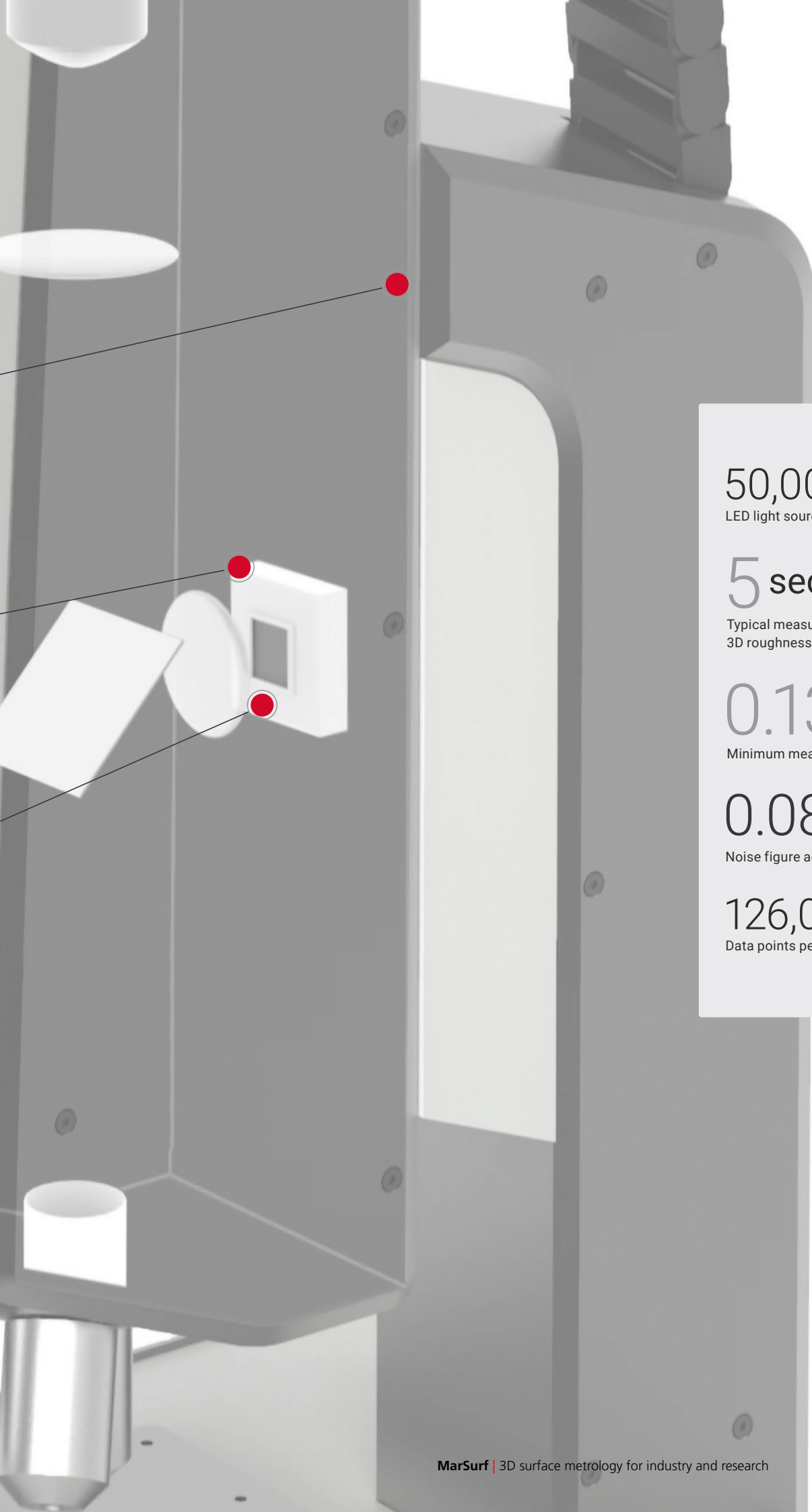

50,000 MTBF
LED light source

5 sec.
Typical measuring time for a
3D roughness measurement

0.13 μm
Minimum measuring point level

0.08 Nanometer
Noise figure according to STR

126,000,000
Data points per second

MarSurf WI 50 M

3D surface measurement

DESCRIPTION

High-performance entry-level solution

The MarSurf WI 50 M is a white light interferometer for the three-dimensional measurement and analysis of surfaces – **non-contact, material independent, and fast.**

Precise measurement in the sub-nanometer range – simple with the new MarSurf WI 50 M, the perfect entry-level solution. The system meets all the requirements of your measuring tasks in the nanometer range – offering maximum performance and outstanding value for money. Adjustment and focusing are child's play thanks to the functional tilting table and manual X-, Y- and Z-axes.

Key benefits:

- Simple technology without motorized axes
- Intuitive operation
- Fast measurements
- Cost-effective
- Robust and reliable
- Max. sample height 220 mm
- Control unit integrated in tripod

This new optical measuring system is successfully used, for example, for:

- Roughness measurement according to DIN EN ISO 4287 / 25178
- Topography measurement (including volume, wear, isotropy)
- Measurement of microgeometry and layer thicknesses

Users value the reliability of MarSurf series measuring systems as they provide quantitative, traceable 3D parameters for many industries.

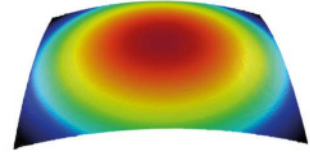

TECHNICAL DATA

WI 50M	
Type	WI 50 M
Measuring principle	White Light Interferometer High-performance LED (650 nm / white) White light interferometer High-power LED (650 nm / white)
Resolution	up to 0.2 (nm) vertical
Measuring speed	up to 140 fps
Surface parameters	ISO 4287, ISO 13565, ISO 25178 ... ISO 4287, ISO 13565, ISO 25178 ...

Supplied with: MarSurf WI 50

- Interferometric measuring head – HDR camera (2 MP or 5 MP)
- L-tripod including control electronics
- Motorized XY table (105x220 mm)
- Manual Z-axis (220 mm)
- Measuring system computer with 24" TFT monitor
- Objective lenses: – 2.5x to 100x selectable
- MarSurf MSW for intuitive data acquisition
- MarSurf MfM for professional evaluation, graphical representation and creation of measuring records (choice of Standard, Extended or Premium version)

APPLICATIONS

- **Mechanical engineering**
Qualification and quantification of the roughness, geometry, and wear volume
- **Electronic system and semiconductors**
Component inspection right down to sub-nanometer range for fault-free products
- **Medical technology**
Quality assurance of medical surfaces in production and the laboratory
- **Materials science**
Optimization of functional features on new surfaces and products
- **Microsystems technology**
Measurement of complex surface geometries of the smallest components with nanometer precision



For more information, please visit our website: www.mahr.com

MarSurf WI 50

3D surface measurement

DESCRIPTION

The flexible, all-round measuring solution

The MarSurf WI 50 is a compact white light interferometer for the three-dimensional measurement and analysis of surfaces – **non-contact, material independent, and fast.**

Allrounder-measurement solutions, flexible at all times, exactly where it comes down to the sub-nanometer: this is what the new MarSurf WI 50 stand for. These high-precision measurement tools for research and quality assurance deliver reliable 3D measuring data – quickly and straightforward in very few steps.

Key benefits:

- High measuring speed – even at full resolution
- CNC-functionality for all axes
- Safety through collision detection in all directions to protect your workpiece and measuring system
- High Dynamic Range (HDR) function, 16-bit
- HD-stitching: Consistent high resolution output of large measuring surfaces

This established optical measuring system is successfully used, for example, for:

- Roughness measurement according to DIN EN ISO 4287 / 25178
- Topography measurement (including volume, wear, isotropy)
- Measurement of microgeometry and layer thicknesses

Users value the reliability of this measuring system, which provides quantitative, traceable 3D characteristics for many industries.



TECHNICAL DATA

WI 50	
Type	WI 50
Measuring principle	White light interferometer High-power LED (650 nm / white)
Resolution	up to 0.2 (nm) vertical
Measuring speed	up to 140 fps
Surface parameters	ISO 4287, ISO 13565, ISO 25178 ...

Supplied with: MarSurf WI 50

- Interferometric measuring head
 - HDR camera (2 MP or 5 MP)
 - 4x lens revolver with identification
- L-tripod including control electronics
- Motorized XY table (50 x 50 mm) with glass scales for sample positioning and image field merging ("stitching")
- Motorized Z-axis (70 mm) with glass measuring scale
- Measuring system computer with 24" TFT monitor
- Objective lenses:
 - 2.5x to 100x selectable
- MarSurf MSW for intuitive data acquisition
- MarSurf MfM for professional evaluation, graphical representation and creation of measuring records (choice of Standard, Extended or Premium version)

APPLICATIONS

- **Mechanical engineering**
Qualification and quantification of the roughness, geometry, and wear volume
- **Electronic system and semiconductors**
Component inspection right down to sub-nanometer range for fault-free products
- **Medical technology**
Quality assurance of medical surfaces in production and the laboratory
- **Materials science**
Optimization of functional features on new surfaces and products
- **Microsystems technology**
Measurement of complex surface geometries of the smallest components with nanometer precision



For more information, please visit our website: www.mahr.com

MarSurf WI 100

3D surface measurement

DESCRIPTION

Automatable, high-end measuring system

The MarSurf WI 100 is a powerful white light interferometer for the three-dimensional measurement and analysis of surfaces – **non-contact, material independent, and fast.**

Allrounder-measurement solutions, flexible at all times, exactly where it comes down to the sub-nanometer: this is what the new MarSurf WI 100 stand for. These high-precision measurement tools for research and quality assurance deliver reliable 3D measuring data – quickly and straightforward in very few steps. With additional manual Z positioning, a large x and y travel range and the possibility of automation, it offers excellent ease of use. The option of performing user-independent, fully automatic measurements makes this surface measuring system ideal for straightforward and efficient use in quality assurance.

Key benefits:

- User-independent serial measurements by automation software
- High measuring speed – even at full resolution
- User-friendly concept
- Safety through collision detection in all directions to protect your workpiece and measuring system
- High Dynamic Range (HDR) function, 16-bit
- HD-stitching: Consistent high resolution output of large measuring surfaces

This established optical measuring system is successfully used, for example, for:

- Roughness measurement according to DIN EN ISO 4287 / 25178
- Topography measurement (including volume, wear, isotropy)
- Measurement of microgeometry and layer thicknesses

Users value the reliability of this measuring system, which provides quantitative, traceable 3D characteristics for many industries.

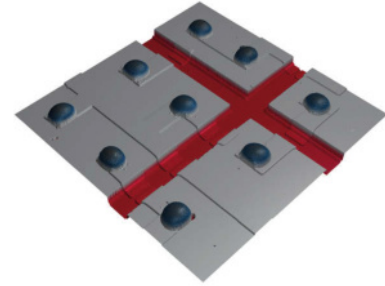

TECHNICAL DATA

Order no.	Type	Other	Power supplied	Measuring principle	Resolution	Measuring speed
6355002	WI 100	Collision detection in xyz direction	100 –240 V	White light interferometer High-power LED (650 nm / white)	up to 0.2 (nm) vertical	up to 140 fps
6355005	WI 100	Collision detection in xyz direction	100 –240 V	White light interferometer High-power LED (650 nm / white)	up to 0.2 (nm) vertical	up to 140 fps

Package contents: MarSurf WI 100

- Interferometric measuring head – HDR camera (2 MP or 5 MP) – 4x lens revolver with identification L-tripod including control electronics
- Motorized XY table (100 x 100 mm) with glass scales for sample positioning and image field merging ("stitching")
- Motorized Z-axis (70 mm) with glass measuring scale
- Additional manual Z-Axis (100 mm)
- Measuring system computer with 24"-TFT-monitor
- Objective lenses: – 2.5x to 100x selectable
- MarSurf MSW for intuitive data acquisition
- MarSurf ASW for automation (optional)
- MarSurf MfM for professional evaluation, graphical representation and creation of measuring records (choice of Standard, Extended or Premium version)

APPLICATIONS

- **Mechanical engineering**
Qualification and quantification of the roughness, geometry, and wear volume
- **Electronic system and semiconductors**
Component inspection right down to sub-nanometer range for fault-free products
- **Medical technology**
Quality assurance of medical surfaces in production and the laboratory
- **Materials science**
Optimization of functional features on new surfaces and products
- **Microsystems technology**
Measurement of complex surface geometries of the smallest components with nanometer precision



For more information, please visit our website: www.mahr.com

ACCESSORIES

Order no.	Description	Type
6820431	Depth standard Pt 0.2–0.4 µm, 1 µm	MDS 1
6820431DKS	Depth standard Pt 0.2–0.4 µm, 1 µm	MDS 1
6820431KAL	Depth standard Pt 0.2–0.4 µm, 1 µm	MDS 1
6820430	Depth standard Pt 1 / 4 / 9 µm	MDS 9
6820430DKS	Depth standard Pt 1 / 4 / 9 µm	MDS 9
6820430KAL	Depth standard Pt 1 / 4 / 9 µm	MDS 9
6820901	Roughness standard	MRS 1.5
6820901DKS	Roughness standard	MRS 1.5
6820901KAL	Roughness standard	MRS 1.5
6820903	Roughness standard	MRS 3
6820903DKS	Roughness standard	MRS 3
6820903KAL	Roughness standard	MRS 3
9040597	Flatness standard incl. PTB certificate	FtS
9040596	Flatness standard	FtS
9040594	Line scale 10/25/100/250 µm	LS
9040595	Line scale 10/25/100/250 µm DAkkS	LS

Flexible 3D profilometer for quality control

The MarSurf CP /CL select 3D profilometer has proven itself many times over when measuring topography, line roughness, height profiles or layer thickness in the production process. Its modular design and ability to combine with different sensors mean that it can adapt to many different measuring tasks. The manual Z-adjuster with fine adjustment guarantees extreme ease of use. Alternatively, there is also a motorized Z-axis. The setup on granite and the use of top-quality components guarantee high repeatability of measurements. It is also possible to measure large and heavy samples.

Point sensors

Sensors with vertical measuring ranges from 0.1 to 10 mm depending on the application as well as high vertical resolution with an optimized signal-to-noise ratio

X-Y axes

available in different sizes



Solid construction

for optimal measuring results / stability



Multi-sensor setup

e.g. for measuring roughness and contours in the millimeter range

Measuring range expansion

of large areas and structure heights in the millimeter range. Typical measuring tasks include flatness, deflection, line roughness, contour and height profile.

Bridge portals

can be individually configured in all sizes

Overview camera

for flexibly teaching measurements

2D and 3D

Measuring 2D and 3D parameters and structures

MarSurf CP / CL select

3D profilometry

DESCRIPTION

Optical 2D/3D profilometry

The MarSurf CP and MarSurf CL *select* are optical profilometers used to complete two- and three-dimensional measurement and analysis of surfaces – **non-contact, material independent, and fast.**

They stand out for extremely fast recording of large measuring surfaces while also ensuring high measuring precision.

Thanks to its modular design, the measuring systems can be adjusted to various measuring tasks and individual automation, measuring convenience, and accuracy requirements. Depending on the measuring task, different sensors can be selected flexibly. Axes systems as well as software modules can be combined individually.

The MarSurf CP and CL *select* meet your individual requirements for automation, measuring comfort and accuracy – right up to the fully automated measuring solution.

- Large scale 3D measurements
- Very high measuring speed
- User-independent serial measurements by automation software
- Excellent flank acceptability
- Layer thickness measurement und measurement of transparent materials
- Large height measurement range with large working distance
- Robust and reliable
- User-friendly concept

This established optical measuring system is successfully used, for example, for:

- Roughness measurement according to DIN EN ISO 4287
- Topography measurement (including volume, wear, isotropy)
- Measurement of macro and micro geometries
- Determination of flatness and coplanarity

Users value the MarSurf CP and CL *select* series as reliable measuring systems that provide quantitative, traceable 2D/3D characteristics for many industries.

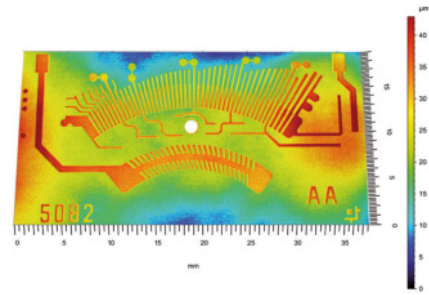

TECHNICAL DATA

CP select	
Type	CP / CL <i>select</i>
Measuring principle	Chromatic-confocal
Measuring speed	4 kHz
Surface parameters	ISO 4287, ISO 13565, ISO 25178, ...

Supplied with: MarSurf CP *select*

- Chromatic point sensors selectable
- Portal construction including control electronics, model selectable
- Motorized XYZ table selectable in different variants
- Industrial computer incl. two 24" TFT monitors
- Vibration damping selectable
- Overview camera selectable
- MarSurf MSW for intuitive data acquisition
- MarSurf ASW for automation (optional)
- MarSurf MfM for professional evaluation, graphic presentation and creation of measuring records (Standard, Extended, Premium version selectable)

MarSurf CL *select*

- Chromatic line sensors selectable
- Portal construction including control electronics, model selectable
- Motorized XYZ table selectable in different variants
- Industrial computer incl. two 24" TFT monitors
- Vibration damping selectable
- Overview camera selectable
- MarSurf MSW for intuitive data acquisition
- MarSurf ASW for automation (optional)
- MarSurf MfM for professional evaluation, graphic presentation and creation of measuring records (Standard, Extended, Premium version selectable)

APPLICATIONS

- **Mechanical engineering**
To qualify and quantify roughness, geometry and wear volume
- **Electronics and semiconductors**
Component inspection down to the sub-micrometer range for defect-free products
- **Medical technology**
Quality assurance of medical surfaces in production and laboratory
- **Material science**
Optimization of functional properties of new surfaces and products
- **Microsystems technology**
Measure complex surface geometries of smallest components with nanometer precision



For more information, please visit our website: www.mahr.com

MarSurf 3D surface metrology - industries

Automotive

- Powertrain
- Body-in-white
- Interior
- Electronics
- Glass components
- Coatings

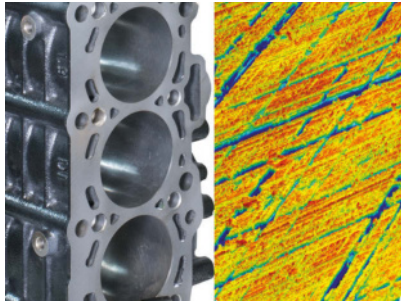

Medical technology

- Implants
- Microfluidics
- Sensors
- Stents
- Microtomes
- Smart materials

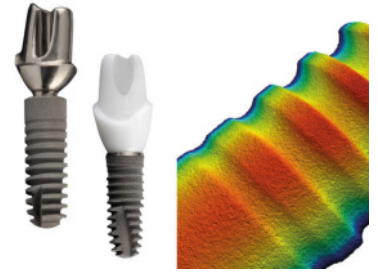

Energy

- Solar cells
- Fuel cells
- Batteries
- Gearbox and turbines

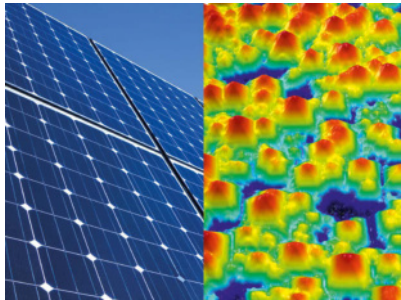

Microsystems

- MEMS
- LED
- High performance electronics
- BGA
- Micro-optics

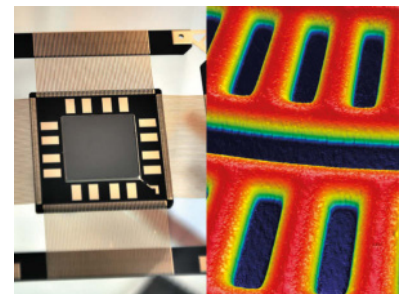

Printing and security

- Printing cylinder
- Printing plates
- Paper sieves
- Bank notes
- Security features
- Works of art
- Chip cards



Tools

- Cutting and milling tools
- Razor blades
- Sand paper
- Coatings
- Micro-tools



Electronic and semiconductor

- BGA
- MEMS
- High performance electronics
- Microelectronics
- Microvias
- Hybrid technology
- Conductor tracks and plates

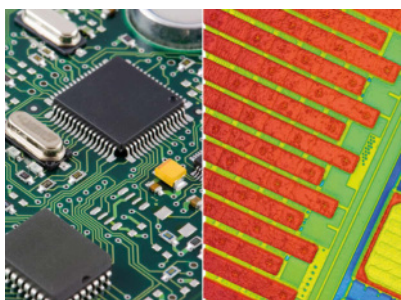

Optics

- Lenses
- Plane optics
- Freeform
- Aspheres
- Laser and x-ray mirrors

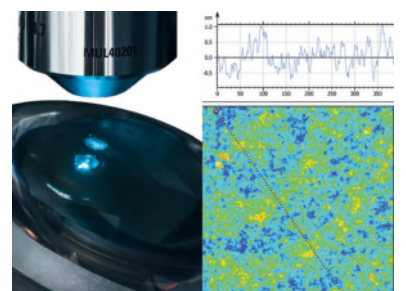

MarVision | Optical measuring instruments

Quality control is in a state of transition throughout the manufacturing industry: The pressure is on to measure workpieces more quickly, more accurately and yet at the same time, more cheaply. That is where measuring microscopes from Mahr come into their own. These instruments provide fast, contactless measurement of contours, distances, angles, radii as well as form and position features on your components, close to production. Even the smallest components can be measured very accurately by selecting appropriate zoom settings. Measuring microscopes from Mahr can be found in virtually every sector and deliver precision measuring results at an attractive price-performance ratio.

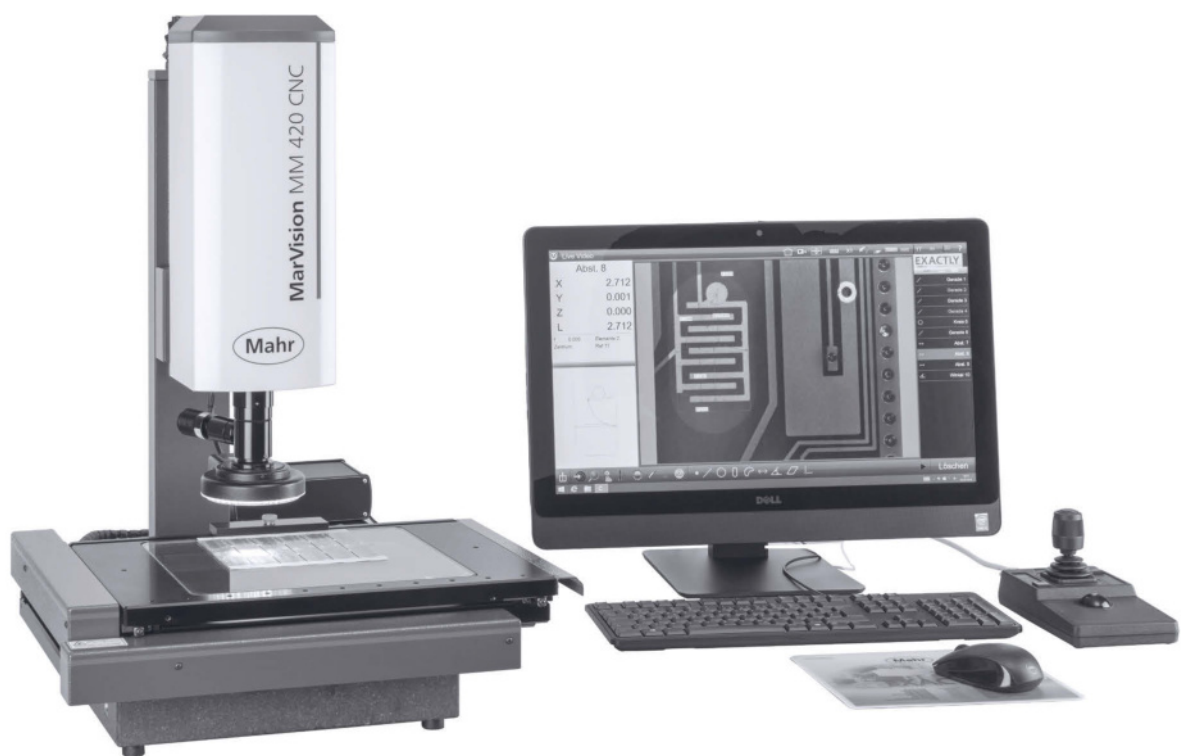

MarVision MM 420	572
MarVision MM 420 CNC	576
Accessories for measuring microscopes	
MarVision 220 Set 2/1 / 220 Set 2/2 / 220 Set 2/3 Set of rack rails	578
MarVision 109 P / 109 Pst / 109 PS Miniature precision vises, set	579

Workshop video

MM 420 measuring microscope

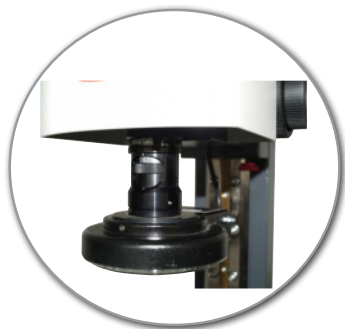

with 6-step
Navitar zoom lens

0.7-4.5x magnification

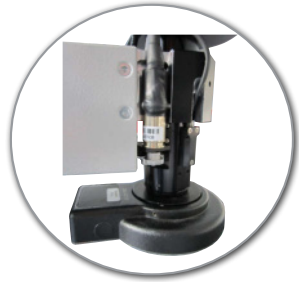

**Motorized
Navitar
zoom lens**

Stable Z-column

150 mm displacement path (can be optionally lengthened by 200 mm, also with measuring system)



Height adjustment

(fine/coarse; mounted on both sides) for sensitive focusing

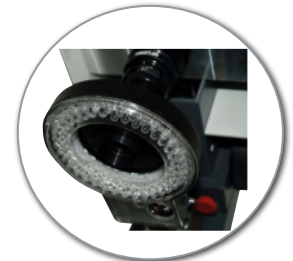

Quadrant LED ring light

(optional coaxial incident light for optimal illumination of plain surfaces)

LED transmitted light

(optional telecentric transmitted light for a sharp image of rotationally symmetrical parts)

Clamp



Quick adjustment

for covering large distances quickly

Solid granite

base

Fine adjustment

for exact positioning

MarVision MM 420 / MM 420 CNC

Configuration optics

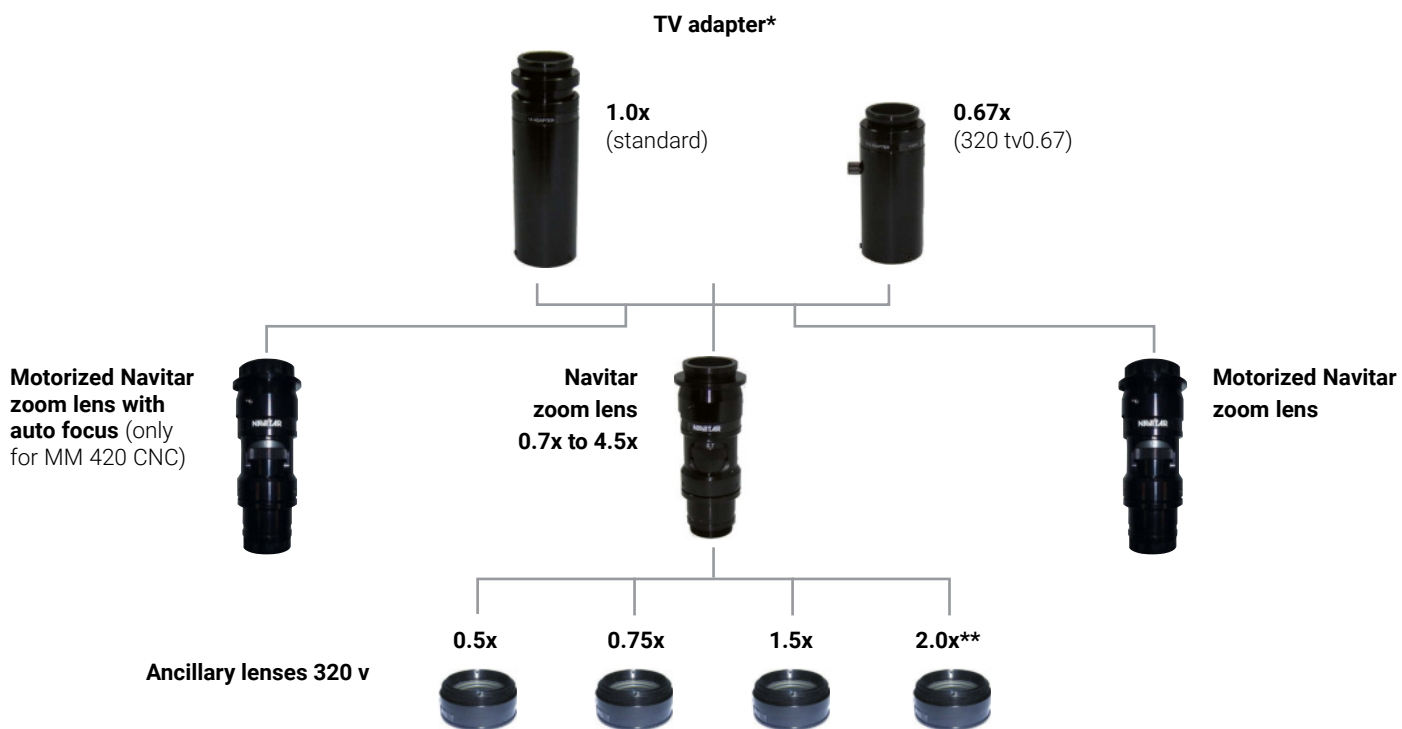

* please specify configuration when placing order

** ancillary lens 2.0x only upon request for MM 420 CNC instrument

TECHNICAL DATA ANCILLARY LENSES

Order no.		Magnification
4247020	320 v0.5	0.5x
4247021	320 v0.75	0.75x
4247022	320 v1.5	1.5x
4247023	320 v2.0	2.0x

Magnification / image sections		Zoom magnification*					
TV adapter	Ancillary lens	0.7x 👁 / ○	1.0x 👁 / ○	2.0x 👁 / ○	3.0x 👁 / ○	4.0x 👁 / ○	4.5x 👁 / ○
0.67	—	23 / 14.3	34 / 10.3	67 / 5.4	101 / 3.6	134 / 2.5	151 / 2.2
0.67	0.5	12 / 28.7	17 / 20.6	34 / 10.7	50 / 7.2	67 / 5.1	75 / 4.5
0.67	0.75	18 / 21.5	25 / 15.4	50 / 8.1	75 / 5.4	101 / 3.8	113 / 3.4
0.67	1.5	35 / 10.7	50 / 7.7	101 / 4.0	151 / 2.7	201 / 1.9	226 / 1.7
0.67	2.0	47 / 7.2	67 / 5.1	134 / 2.7	201 / 1.8	268 / 1.3	302 / 1.1
1.0	—	35 / 9.6	49 / 6.9	94 / 3.6	141 / 2.4	200 / 1.7	225 / 1.5
1.0	0.5	18 / 19.2	25 / 13.8	47 / 7.2	71 / 4.8	100 / 3.4	113 / 3.0
1.0	0.75	26 / 14.4	37 / 10.4	71 / 5.4	106 / 3.6	150 / 2.6	169 / 2.3
1.0	1.5	53 / 7.2	75 / 5.2	150 / 2.7	225 / 1.8	300 / 1.3	338 / 1.1
1.0	2.0	70 / 4.8	98 / 3.5	188 / 1.8	282 / 1.2	400 / 0.9	450 / 0.8

👁 Magnification on monitor

○ Image section in mm

* Circa values (mm x mm = mm²)

MarVision MM 420

Workshop measuring microscope with M3 software

FEATURES

- Integrated color camera
- Zoom lens (0.7x –4.5x), optionally motorized
- LED ring light: 1 ring and 4 segments, individually switchable and dimmable
- Dimmable LED transmitted light
- Laser pointer for position finding
- Solid granite base
- Sturdy steel XY table, precision-mounted
- Quick and fine adjustment of axes
- Optical incremental measuring system for outstanding accuracy and reliability

Control and display unit with M3 software and touchscreen PC

- 23" touchscreen with keyboard and mouse
- Windows 10 Pro operating system, additional software can be installed
- Operation via the multi-touch screen or with a mouse/keyboard
- Large video screen
- Reference/actual evaluation with tolerances
- Record output with company logo
- Graphical display with dimensioning
- Automatic edge detection, even on low contrast parts
- Stitching
- Statistics

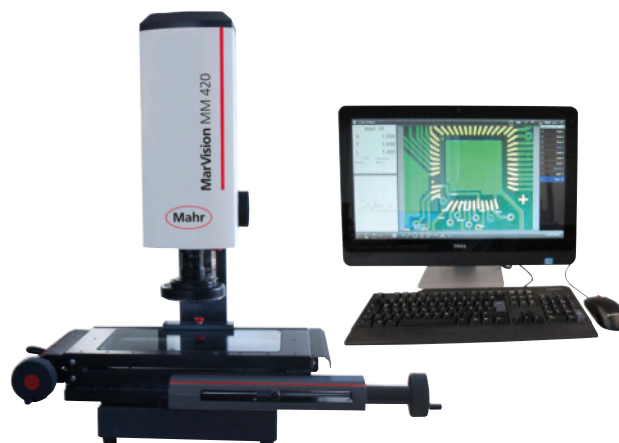

Application:

- Measurement or determination of geometric elements (point, straight line, circle, distance, intersection point, etc.) by automatic edge detection, e.g. on punched and bent components, plastic components, and circuit boards

TECHNICAL DATA

Order no.		4247600	4247601	4247602	4247603
Type		MM 420			
Measuring range X/Y	mm	100 / 100	200 / 100	250 / 170	400 / 250
Size of table	mm	270 x 210	370 x 210	420 x 280	600 x 480
Maximum table load	kg	20			
Measuring system		Built-in incremental scale			
Measuring system - resolution	mm	0,001			
Measuring system - E1 X/Y in µm	µm	1.9 + (L/100)		1.9 + (L/100)	3.9 + (L/100)
Measuring system - E2 XY in µm	µm	2.9 + (L/100)			4.9 + (L/100)
Magnification		35 –225x			
Max. height of test piece	mm		115		290
Max. height of test piece / 0.5-fold	mm		20		200
Max. height of test piece with coax.	mm		115		260
200 extension in Z	mm		315		
200 extension in Z / 0.5-fold	mm		220		
Illumination		LED back and front illumination, adjustable			
Energy supply:		230 V / 50 Hz			
H x W x D	mm	700 x 480 x 430	700 x 650 x 550	700 x 700 x 600	800 x 1000 x 900

MarVision MM 420

Workshop measuring microscope with M3 software

ACCESSORIES

Order no.	Description	Type
4246114	Optional DXF file integration for M3 software	
4247027	Optional TV adapter, 0.67x (instead of 1.0x)	320 tv0,67
4247028	Optional Navitar zoom 6.5:1, motorized	320 zmo
4247029	Optional Navitar zoom 6.5:1, motorized with coaxial light	320 zmk
4247035	Optional Navitar 4 K motor-zoom 8x – 116x	
4247050	Optional telecentric transmitted light for measuring rotationally symmetrical parts	200 ld
4247039	Optional telecentric transmitted light for Navitar 4 K motor zoom	200 ldm
4245300	Optional coaxial LED incident light for zoom lens	320 kaz
4246050	Optional Z axis with measuring system	320 zm
4246051	Optional Z axis, extended by 200 mm	320 Zv
4246052	Optional Z axis, extended by 200 mm, including measuring system	320 zvm
4247020	Ancillary lens 0.5x (for Navitar objective lens only)	320 v0.5
4247021	Ancillary lens 0.75x (for Navitar objective lens only)	320 v0.75
4247022	Ancillary lens 1.5x (for Navitar objective lens only)	320 v1.5
4247023	Ancillary lens 2.0x (for Navitar objective lens only)	320 v2
4246801	Prisms, pair, for diameter 5–55 mm (measuring tables 100x100 mm, 200x100 mm)	220 p
4246802	Center support, pair, center height 40 mm (measuring tables 100x100 mm, 200x100 mm)	220 sp
4246806	Center support, pivoting, Ppair, center height 50 mm, distance between centers 130 mm (measuring table 200 x 100 mm)	220 sps
4246920	Pivoting glass plate, Ø 100 mm (measuring table 200 x 100 mm)	200 dk
4246821	90° stop for MM 220 / MM 320	220 as90
4246901	Calibration standard for circles, with calibration certificate for measuring microscope	320 nkz
4246071	Protective cover for measuring tables 100x100 and 200x100 mm	
4246115	Upgrade M3-Software Version V1 to V2	
4246121	Upgrade M3 software from version V2 to V3	
4246116	DXF option and profiling package for MM 420	
4246117	Upgrade from DXF to profiling for MM 420 / MM 420-CNC	
4246118	Thread measuring option for MM420	
4246119	Optional cable insulation measurement for MM 420	
4246831	Prisms, Pair, for diameter 5–55 mm (measuring table 250 x 170 mm)	220 p
4246833	Center support, pair, center height 40 mm (measuring table 250 x 170 mm)	220 sp
4246807	Center support, pivoting, Pair, center height 50 mm, distance between centers 130 mm (measuring table 250 x 170 mm)	220 sps
4246921	Pivoting glass plate, Ø 100 mm (measuring table 250 x 170 mm)	200 dg
4246072	Protective cover for measuring table 250x170 mm	
4246054	Option measuring system for extended Z-axis (350 mm)	320 zvl
4246832	Prisms, Pair, for diameter 5–55 mm (measuring table 400 x 250 mm)	220 p
4246834	Center support, Pair, center height 40 mm (measuring table 400 x 250 mm)	220 sp
4246808	Center support, pivoting, Pair, center height 50 mm, distance between centers 130 mm (measuring table 400 x 250 mm)	220 sps
4246922	Pivoting glass plate, Ø 100 mm (measuring table 400 x 250 mm)	200 db
4246825	90° stop for table 400x250 mm	220 as90–1
4246073	Protective cover for measuring table 400x250 mm	

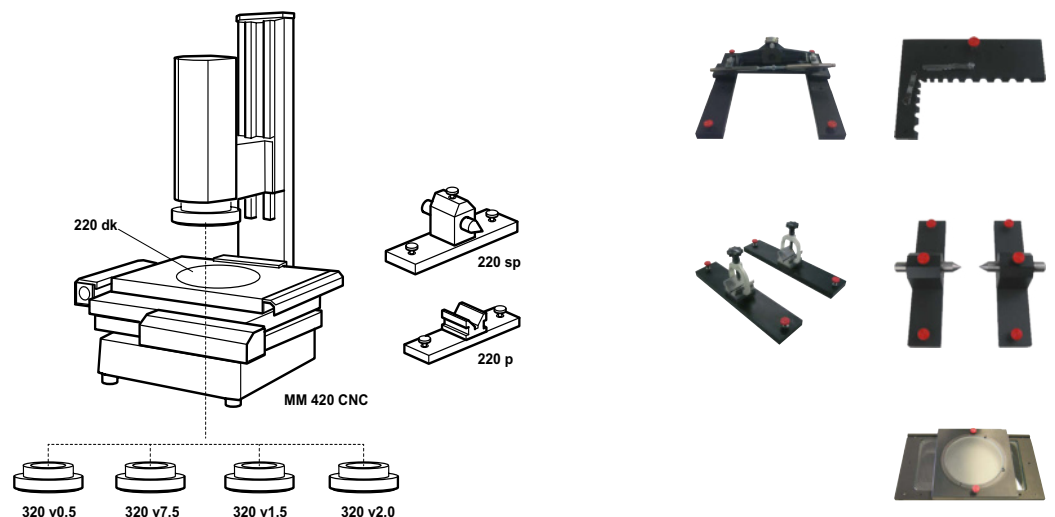

MarVision MM 420 CNC

CNC workshop measuring microscope

FEATURES

- 3-axes CNC control
- Axis movement and speed regulation controlled via the joystick
- Integrated color camera
- Motorized zoom lens (0.7x –4.5x) with autofocus
- LED ring light: 1 ring and 4 segments, individually switchable and dimmable
- LED transmitted light: dimmable
- Laser pointer for position finding
- Solid granite base
- Sturdy steel XY table, precision-mounted
- Optical incremental measuring system for outstanding accuracy and reliability

Operating and display unit M3 software with touchscreen PC

- 23" touchscreen with keyboard and mouse
- The operating system is Windows 10 Pro, so further software can be installed
- Operation via the Multi-Touch screen or with a mouse/keyboard
- M3 Software version 3
- Large video image
- Reference/actual evaluation with tolerances
- Record output with company logo
- Graphic display with dimensioning
- Automatic edge detection, even on low-contrast parts
- Stitching
- Statistics
- Palletizing of serial parts
- Optional hardware components
- Telecentric transmitted light
- Coaxial incident light
- Use of ancillary lenses 0.5x / 2x (additional magnification levels)
- Tactile measuring system Renishaw TP20
- Macro zoom Navitar 4 K motor zoom 8x–116x with 5MB camera
- 0.67x TV adapter for larger line of view

Software options

- Importing DXF data
- DXF and profiling package
- Thread measurement module
- Cable insulation module
- Upgrade of M3 versions V1 and V2
- QDAS converter program

Package contains:

M3 software with touchscreen PC, standard stop bar 220 as, instruction manual, Mahr calibration certificate



Application:

- Measurement or determination of geometric elements (point, straight line, circle, distance, intersection point, etc.) by automatic edge detection, e.g. on punched and bent components, plastic components, and circuit boards

TECHNICAL DATA

Order no.		4247701	4247702	4247703
Type		MM 420 CNC		
Measuring range X/Y	mm	200 / 100	250 / 170	400 / 250
Size of table	mm	370 x 210	420 x 280	600 x 480 x 200
Maximum table load	kg	20		
Measuring system		built-in incremental scale		
Measuring system - resolution	mm	0,001		
Measuring system - E1 X/Y in μm	μm	1.9 + (L/100)	1.9 + (L/100)	3.9 + (L/100)
Measuring system - E2 XY in μm	μm	2.9 + (L/100)		4.9 + (L/100)
Magnification		35 –225x		
Max. height of test piece	mm	200		
Max. height of test piece / 0.5-fold	mm	110		
Max. height of test piece with coax.	mm	200		
Max. height of test piece with coax. / 0.5-fold	mm	110		
Illumination		LED back and front illumination, adjustable		
Energy supply		230 V / 50 Hz		

MarVision MM 420 CNC

CNC workshop measuring microscope

ACCESSORIES

Order no.	Description	Type
4247036	Optional Navitar 4 K motor zoom 8x –116x for CNC-versions	
4246114	Optional DXF file integration for M3 software	
4247027	Optional TV adapter, 0.67x (instead of 1.0x)	320 tv0,67
4247050	Optional telecentric transmitted light for measuring rotationally symmetrical parts	200 ld
4247039	Optional telecentric transmitted light for Navitar 4 K motor zoom	200 ldm
4245302	Optional coaxial LED incident light for zoom lens	320 kac
4247020	Ancillary lens 0.5x (for Navitar objective lens only)	320 v0.5
4247021	Ancillary lens 0.75x (for Navitar objective lens only)	320 v0.75
4247022	Ancillary lens 1.5x (for Navitar objective lens only)	320 v1.5
4247023	Ancillary lens 2.0x (for Navitar objective lens only)	320 v2
4246801	Prisms, Pair, for diameter 5–55 mm (measuring tables 100x100 mm, 200x100 mm)	220 p
4246802	Center support, Pair, center height 40 mm (measuring tables 100x100 mm, 200x100 mm)	220 sp
4246806	Center support, pivoting, Pair, center height 50 mm, distance between centers 130 mm (measuring table 200 x 100 mm)	220 sps
4246920	Pivoting glass plate, Ø 100 mm (measuring table 200 x 100 mm)	200 dk
4246821	90° stop for MM 220 / MM 320	220 as90
4246901	Calibration standard for circles, with calibration certificate for measuring microscope	320 nkz
4246071	Protective cover for measuring tables 100x100 and 200x100 mm	
4246834	Center support, Pair, center height 40 mm (measuring table 400 x 250 mm)	220 sp
4246115	Upgrade M3 software version V1 to V2	
4246121	Upgrade M3 software from version V2 to V3	
4246116	DXF option and profiling package for MM420	
4246117	Upgrade from DXF to profiling for MM 420 / MM 420-CNC	
4246118	Thread measuring option for MM 420	
4246119	Optional cable insulation measurement for MM420	
4247040	Optional 3D tactile measuring system TP20, probe L=20 mm with ball diameter 2 mm	
4247041	Calibration standard ball Ø 20 mm and setting ring Ø 10 mm	
4246831	Prisms, pair, for diameter 5–55 mm (measuring table 250 x 170 mm)	220 p
4246833	Center support, pair, center height 40 mm (measuring table 250 x 170 mm)	220 sp
4246807	Center support, pivoting, pair, center height 50 mm, distance between centers 130 mm (measuring table 250 x 170 mm)	220 sps
4246921	Pivoting glass plate, Ø 100 mm (measuring table 250 x 170 mm)	200 dg
4246072	Protective cover for measuring table 250x170 mm	
4246825	90° stop for table 400x250 mm	220 as90–1
4246922	Pivoting glass plate, Ø 100 mm (measuring table 400 x 250 mm)	200 db
4246832	Prisms, pair, for diameter 5–55 mm (measuring table 400 x 250 mm)	220 p
4246808	Center support, pivoting, pair, center height 50 mm, distance between centers 130 mm (measuring table 400 x 250 mm)	220 sps
4246073	Protective cover for measuring table 400x250 mm	

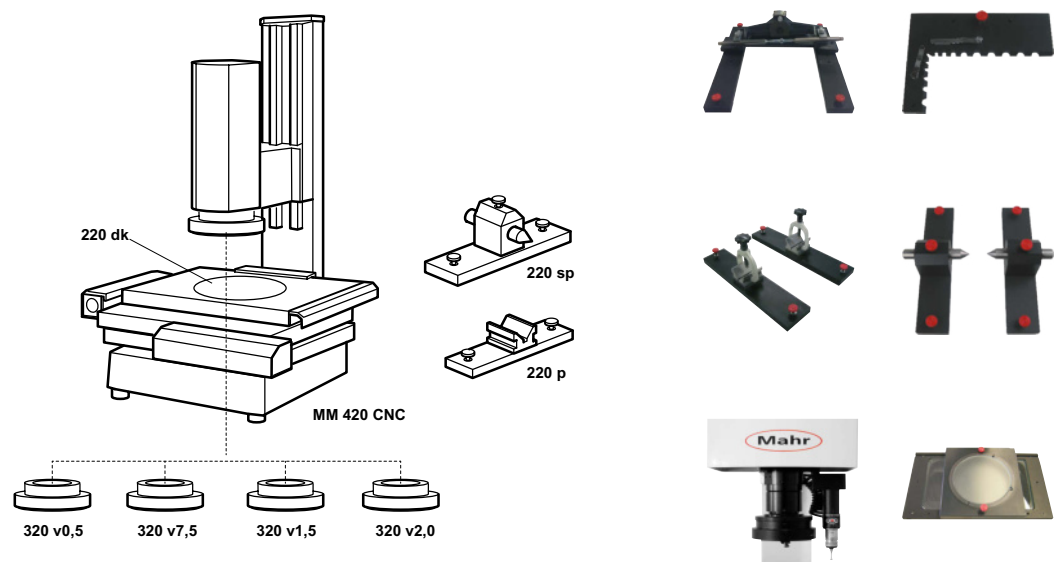

MarVision 220 Set 2/1 / 220 Set 2/2 / 220 Set 2/3

Set of rack rails for measuring range 200 x 100 mm

FEATURES

- Clamping elements

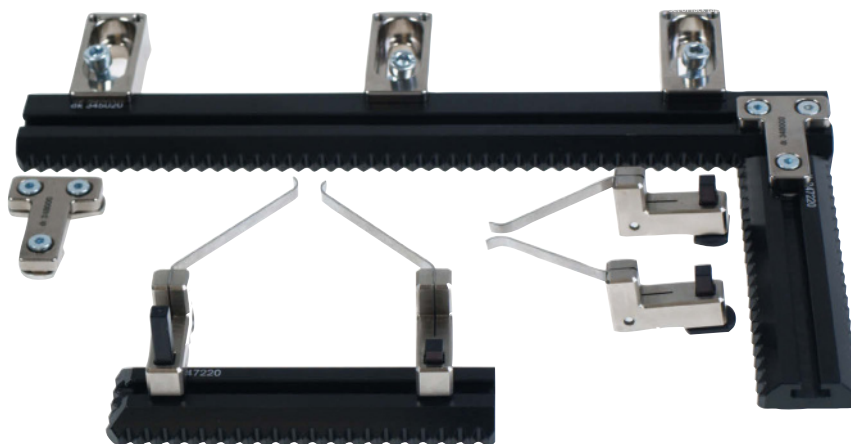

Application:

- For clamping workpieces on measuring microscopes

TECHNICAL DATA

Order no.	Type	Set contents
4246851	220 Set 2/1	Rack rails for measuring range 200 x 100 mm
4246852	220 Set 2/2	Rack rails for measuring range 250 x 170 mm
4246853	220 Set 2/3	Rack rails for measuring range 400 x 200 mm

ACCESSORIES

Order no.	Description	Type
4246850	Set of clamping elements in wooden case	220 Set 1
4246854	V-supports, jaw chuck and tailstock	220 Set 3
4246855	Rotating swivel holder without jaw chuck rack rails	220 ds
4246856	Precision jaw chuck for 0–3 mm for rotating swivel holder 220 ds	220 pb03
4246857	Precision jaw chuck for Ø 0–6.5 mm for rotating swivel holder 220 ds	220 pb065



MarVision 109 P / 109 Pst / 109 PS

Vise with 15 mm jaw width

FEATURES

- Hard chrome plated or anodized construction (jaw width 15 mm)
- Exchangeable clamping jaws in hardened stainless steel and plastic



Application:

- For clamping small workpieces on measuring microscopes

TECHNICAL DATA

Order no.	Type	Set contents
4246810	109 P	Mini vise, jaw width 15 mm
4246811	109 P	Mini vise, jaw width 25 mm
4246812	109 P	Mini vise, jaw width 35 mm
4246813	109 Pst	Tripod for vise, jaw width 15 mm
4246814	109 Pst	Tripod for vise, jaw width 25 mm
4246815	109 Pst	Tripod for vise, jaw width 35 mm
4246816	109 PS	Mini vises, jaw width 15 and 25 mm
4246817	109 PS	Mini vises, jaw width 25 and 35 mm
4246818	109 PS	Mini-vises, jaw widths 15 / 25 / 35 mm, with tripod and V-blocks
4246819	109 PS	Mini-vises, jaw widths 15 / 25 / 35 mm, with tripod and V-blocks and miniature dividing attachments

MarOpto | Measuring instruments for the optical industry

The role of metrology is changing, to keep pace with innovations in manufacturing processes. Given the continual stringent accuracy requirements and falling cycle times, rapid measurement directly at the manufacturing machine is absolutely essential. With MarOpto you can measure lenses, aspheres and freeforms at the point of origin of the product – with rapid feedback to the manufacturing process to avoid waste.



Metrology in lens production The close-to-production 3D measuring station	582
MarOpto MFU 200-3D Precision 3D measuring station	584
MarSurf LD 260 aspheric 2D and 3D Aspheric measuring station	590
MarSurf UD 130 aspheric 2D Aspheric measuring station	591
MarOpto FI 1040 Z Fizeau interferometer	592
MarOpto FI 1100 Z Fizeau interferometer	593
MarOpto MT 100 Measuring towers	593



The latest information about MarOpto products can be found on our website:
www.mahr.com

MFU 200-3D – The close-to-production 3D measuring station – ultraprecise and universal

The MarOpto MFU 200-3D is a universal machine for measuring contour, roughness, axis offset, radial runout and tilt errors in lenses in one setup. It is ideal for spheres, aspheres, cylinder lenses and freeforms. Measurements are taken automatically, quickly and close to production in 2D and 3D. Due to the unique combination of optical and tactile probe arms, a reference surface of the component can be used to determine the form and position of the other surfaces. Mahr's tried and tested software platform MarWin provides the basis for various, modular evaluation options of the lenses. There is a new software package - AnyShape - available for this.

Users benefit from the following advantages:

- Increased productivity thanks to minimal calibration due to greater temperature stability
- Close-to-production option available thanks to measuring cabinet with attenuation
- Accuracy due to dynamic realtime compensation (measurement uncertainty < 100 nm [PV])
- Reference system on the component itself thanks to combination of optical and tactile sensors
- Flexibility thanks to measurable gradient angle of up to 45°
- Standard evaluation as per ISO 10110-5
- Universal thanks to automation of different measuring tasks on one machine

Shorter measuring times

The new quick-clamping device allows individual adjustment to the measuring object.

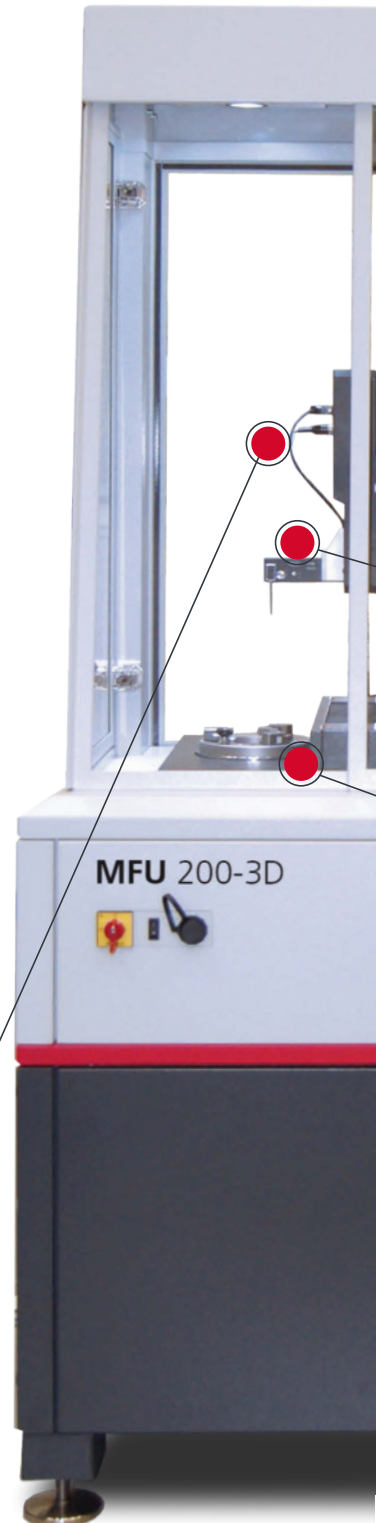

Maximum diameter

180 mm

X-axis

Noise figure

< 5 nm

Roundness deviation

< 20 nm

Measurement uncertainty

< 100 nm PV

Measurable gradient up to

45°

on rotationally symmetrical parts



Most reliable repeatability

Even better drives guarantee maximum reproducibility in the positioning range.

Flexible multisensor system

The flexible motorized probe measures alternately with the tactile probe arm or the optical sensor.

Automated measuring routine

The motorized centering and tilting means that user intervention is no longer required, ensuring process stability.

Unique precision

The MarOpto MFU 200-3D is the most accurate polar coordinate measuring machine in the nm range for lens components.

MarOpto MFU 200-3D

High-precision 3D measuring station for spheres, aspheres and freeforms

DESCRIPTION

The MFU 200-3D is a universal, highly accurate measuring machine for the automatic measurement of spheres, aspheres, freeforms, and special lenses and was developed by Mahr to enable optical components to be tested quickly in 2D and 3D close to the production area.

Accuracy

- With a measurement uncertainty of less than 100 nm PV, the measuring instrument is perfectly designed to meet your process optimization requirements.

Flexibility

- The MFU 200-3D can perform optical and tactile measurements of surfaces. An interferometric point sensor is used for the optical measurement. There is a wide range of probe arms for tactile measurements. Rotationally symmetrical objects with a kurtosis of up to 45°, off-axis and freeforms up to 28° can be measured.



TECHNICAL DATA

Order no.	5440581
Type	MFU 200-3D
Monitor	19" TFT monitor (touchscreen monitor)
Control panel	MCP 12
Motorized measuring probe	T7W
Optical measuring probe	IPS
Probe arm	90° angled, ruby ball ø 3mm, incl. connection for optical sensor
Pitch error	Pitch error of the C-/Z-/X-axis is calibrated
Calibration set and Basic clamp set	included
MFU 200-3D Aspheric software package	included
MFU 200-3D Anyshape software option	optional

ACCESSORIES

Order no.	Description
5440468	Hydraulic expansion chuck ø 25 mm for quick clamp system
5440471	Three-jaw chuck for quick clamp system
5440472	Vise for quick clamp system
5440473	Index plate for quick clamp system
5440474	Mounting plate
3028108	Adapter for hydraulic expansion chuck 25 mm – 12 mm
9058047	Clamps for 200 mm lenses

Clamp set

Universal design for every purpose – the design ensures you are well equipped even if you have a broad range of components.

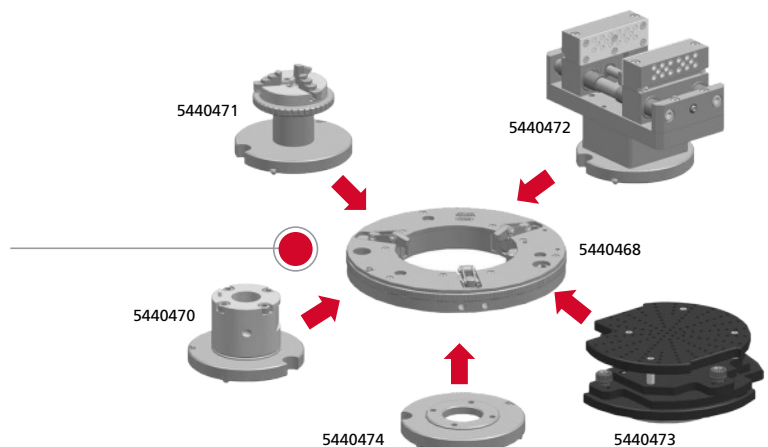

MarOpto MFU 200-3D

High-precision 3D measuring station for spheres, aspheres and freeforms

ADVANTAGES

- Automatic tilting and centering – user-independent positioning, centering, and alignment of measuring objects
- Active tracking – automatic measurement of unknown geometries; the sensor (optical and tactile) automatically follows the surface via the machine controller
- Probe combination – combination of optical sensors and tactile probes can be combined in one probe system; can be moved in space (360°)
- Closed loop integration in the production process (grinding/polishing) perfect for transmissive optics (tilt/centering error designation)

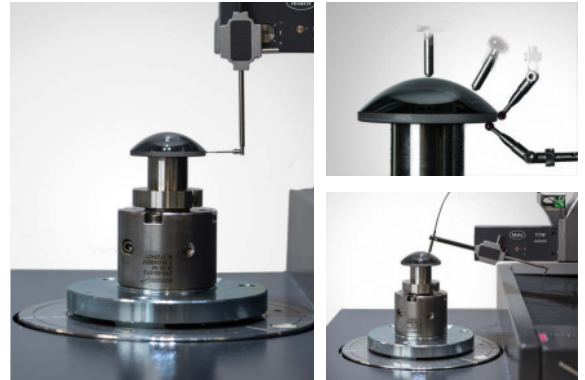

MEASURING TASKS & SOFTWARE

Flexible measuring tasks in one machine

- Form
- Contour
- Roughness
- Axis offset of lenses
- Radial runout error
- Tilt and centering error of the optics

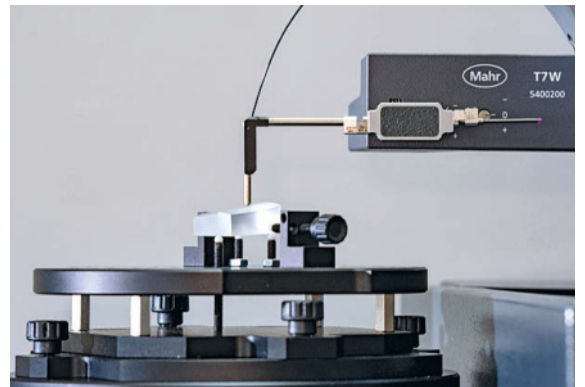

SOFTWARE

Special software package for your requirements

- AsphericLib software for measuring and evaluating spheres and aspheres
- SW analysis of the tool for the future – freeform measurement and evaluation

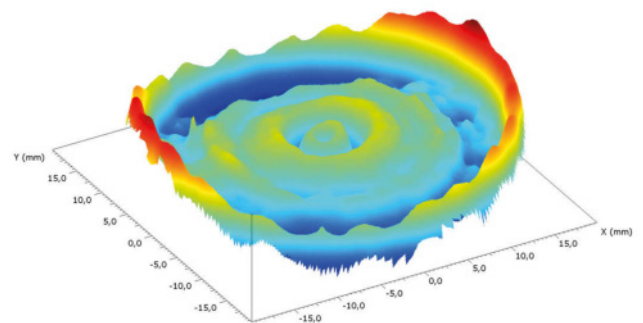

For more information, please visit our website: www.mahr.com

Contour and surface measuring station for production

MarSurf LD 260 Aspheric 2D / 3D

The MarSurf LD 260 Aspheric measuring station is a highly precise 2D / 3D surface measuring station for measuring contours on spheres, aspheres and optical components. Check and correct your individual production steps in closed loop operation. Mahr's tried and tested software platform MarWin provides the basis for flexible evaluation using Aspheric Lib.

Users benefit from the following advantages:

- Closed loop – Output the differential profile to correct the machine tool
- Check the surface in the first machining operations
- Operating concept for production control
- Electronic control of contacting force for different applications

Bionic-style LP D probe arm

Improved dynamics and optimized design, change probe arm without calibration

Measurement of diffractive structures

Determines the form deviation, zone height and distances and much more

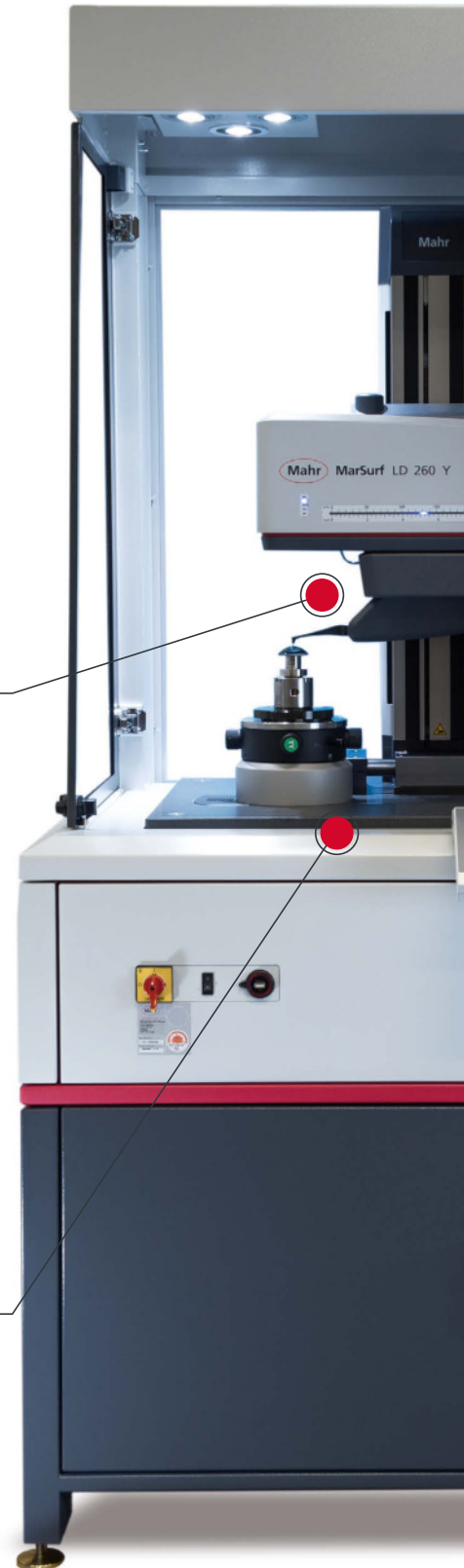

Max. measuring range

260 mm

X-axis

Vertical resolution

0.8 nm

Max. measuring speed

10 mm/s

Form deviation 2D

≤ 100 nm

Form deviation 3D

≤ 200 nm

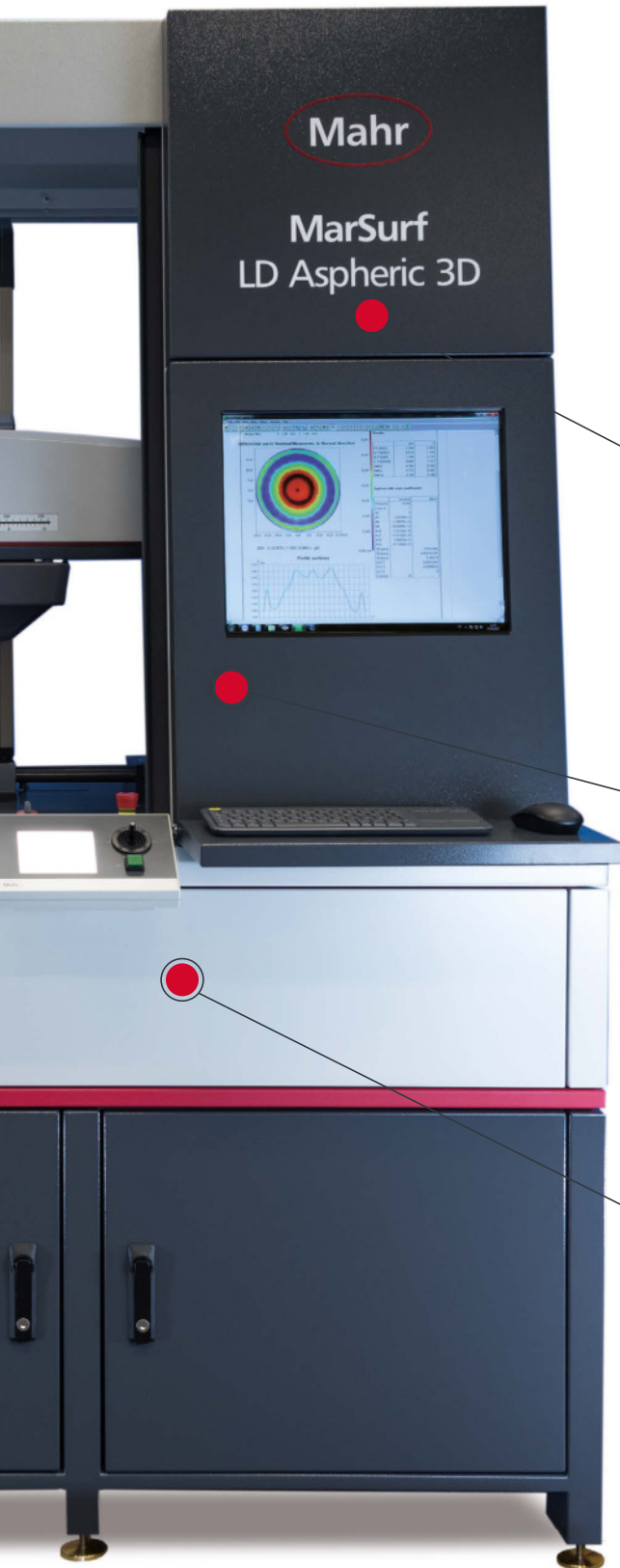

DIN ISO 10110

Evaluation as per DIN ISO 10110-5

Increased flexibility



Different types of rotationally symmetrical aspheres can be measured with one measuring system.

Measurement of bi-aspheres

Optical lenses can be measured on both sides in absolute reference to one another.

Powerful software for measuring tasks in lens production

Mahr not only offers universal hardware with the MarOpto MFU 200-3D, but also the perfectly compatible measuring and evaluation software based on the MarWin platform for the special applications of the optical industry. The user interface of the software is clearly laid out and easy to navigate.

 AnyShape  AsphericLib		Geometry of lens surface	
		rotationally symmetrical	non-rotationally symmetrical
Outer aperture of the lens (reference measurement)	circular	asphere, sphere, optical flat...	cylinder lens, toroid, off axis...
	non-circular	asphere, sphere, optical flat...	cylinder lens, toroid, off axis...

AsphericLib

The AsphericLib software package measures spheres, aspheres and mounting surfaces and evaluates the results. Users can benefit from the following options:

- Automated 2D and 3D measurement
- Define nominal geometries using a clear software interface
- Analyze and display the surface form deviation and the slope error in a graph in accordance with ISO 10110-5
- Reverse engineering and simulation: Determine the asphere coefficients of unknown geometries
- Export profiles for correcting machine tools in file formats
*.mod, *.txt, *.ascii, *.dat, *.xyz, *.zygo.dat, *.x3p
- Import geometry data from the machine tool
- Automatically create measuring records with ISO 10110-5 parameters

Sample applications for testing optical components

The software packages of the MarOpto MFU 200-3D enable the optimal testing of all the relevant optical components with regard to their relevant properties. The following measuring sequences are possible, for example:



Measuring aspheres with AsphericLib

The following measuring routine is specified for testing aspheres with AsphericLib:

- Enter the target parameters (R, k, Ai)
- Automatic alignment of testpiece
- Measure the topography using circular paths
- Evaluate as 3D differential topography and 2D difference profile
- Evaluation as per ISO 10110-5
- Information about power, irregularity, RMSi, R0 etc.

Measuring freeforms with AnyShape

The following measuring routine is specified for testing freeforms with AnyShape :

- Enter geometric parameters (Torus, Biconic, cylinder, off axis, free analytical description)
- Define mechanical fiducials
- Calibrate the workpiece position using fiducials
- Measure the topography using circular paths
- Evaluate as 3D differential topography (R, PV, RMS, Slope)
- Evaluate centering errors (optical axis against mechanical references)

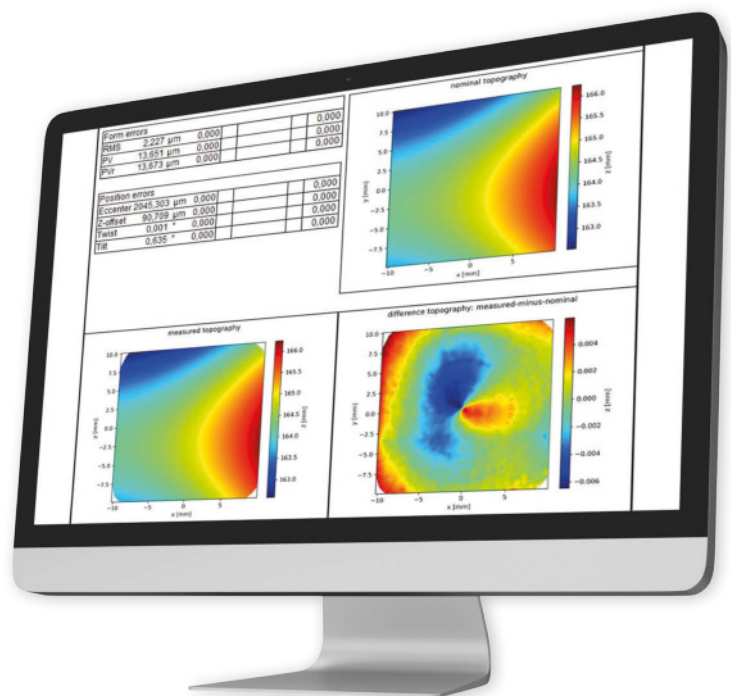

MarSurf LD 260 Aspheric 2D and 3D

Asphere measuring station

DESCRIPTION

MarSurf LD 260. The step into a new dimension

- MarSurf LD 260 Aspheric is a high-precision 2D / 3D surface measuring station for characterizing the contour and roughness of optical components. MarWin is the operating and evaluation software.

Checks the surface in the first machining operations

- Early detection of deviations, thus avoiding costly reworking
- Differential profile output in machine-readable format for controlling the machine tool (closed loop)

Increased flexibility

- Different types of rotationally symmetrical aspheres can be measured with one measuring system, no additional investment required
- Large measuring range up to 260 mm
- Maximum measuring speed and dynamics (up to 10 mm/s for large lenses / up to 0.02 mm/s for microlenses)
- Fully positionable stylus tip

Bionic-style LP D probe arm

- Improved probe system dynamics thanks to increased rigidity and attenuation as well as a lower moment of inertia:
 - Optimized overall design of the probe system
 - Innovative choice of materials
- Probe arm with integrated chip for:
 - Detecting and identifying the probe arm
 - Checking that the probe arm is inserted correctly
 - Providing information from probe arm

Your results will be right

- The high-precision MarSurf LD 260 is the basis for the accurate measurement of your workpieces. The vertical resolution of 0.8 nm and form deviations of < 100 nm guarantee the exact reproduction of your asphere.
- Probe arm change with no need to recalibrate
- Lenses with steep sides can be measured

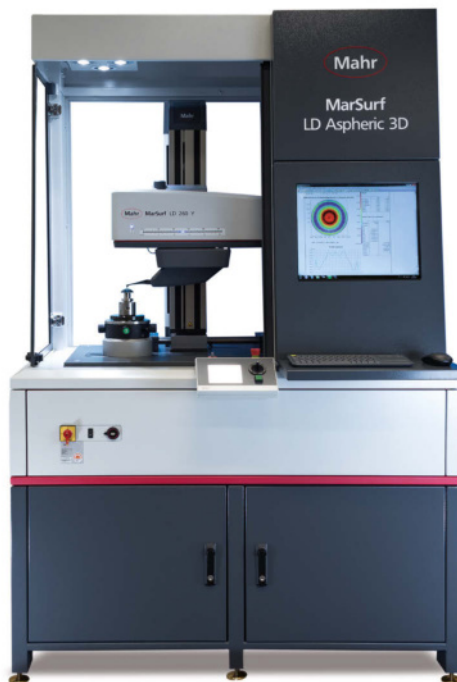

TECHNICAL DATA

Type	MarSurf LD 260 2D-Aspheric	MarSurf LD 260 3D-Aspheric
Structure	Measuring cabin	
Operation	Control panel and 19" TFT monitor (touch screen)	
Measuring column	ST 500 CNC/HZ	ST 500 CNC/HZ/HB
Probe arm	LP D 14-10-2/60 LP D 14-10-500 LP D 1100-10-500	LP D 14-10-2/20 LP D 14-10-500
Formal error	≤ 100 nm	≤ 200 nm
Resolution	0.8 nm	0.8 nm
Calibration set and clamping device set	incl.	incl.
MarOpto Aspheric software package	incl.	incl.

MarSurf UD 130 Aspheric 2D

Asphere measuring station

DESCRIPTION

MarSurf UD 130. A step into a new dimension

- MarSurf UD 130 Aspheric is a high-precision 2D surface measuring station for characterizing contour and roughness on optical components. MarWin is the operating and evaluation software.

Checks the contour in the first machining operations

- Early detection of deviations, thus avoiding costly reworking.
- Differential profile output in machine-readable format for controlling the machine tool.

Increased flexibility

- Different types of rotationally symmetrical aspheres can be measured with one measuring system. No additional investment required.
- Measuring range up to 130 mm
- High measuring speed and dynamics (up to 5 mm/s for large lenses / up to 0.1 mm/s for microlenses)
- Fully positionable stylus tip.

Innovative LP D probe arm

- Improved probe system dynamics by increased rigidity and attenuation as well as a lower moment of inertia:
 - optimized overall design of the probe system
 - innovative choice of materials
- Probe arm with integrated chip for:
 - detecting and identifying the probe arm,
 - checking that the probe arm is inserted correctly,
 - providing information from probe arm.

Your results will be right

- The high-precision MarSurf UD 130 is the basis for the accurate measurement of your workpieces. The vertical resolution of 2 nm and form deviations of < 300 nm guarantee the exact reproduction of your asphere.
- Probe arm change with no need to recalibrate.
- Lenses with steep sides can be measured.



TECHNICAL DATA

Type	MarSurf UD 260 2D-Aspheric
Operation	Control panel and 24" TFT monitor (workstation)
Measuring column	ST 500 CNC/HZ
Probe arm	LP D 14-10-2/60 LP D 14-10-500
Formal error	≤ 300 nm
Resolution	2 nm
Calibration set and clamping device set	incl.
MarOpto Aspheric software package	incl.

MarOpto. Fizeau interferometer

Versatile and powerful in measuring rooms and production

Powerful MarOpto Fizeau interferometers can provide contactless measurements on flats and spherical surfaces and of transmitted wavefronts. MarOpto interferometers are ideal for measuring optical components such as flats, prisms and lenses or precision metal workpieces including bearings, sealing surfaces and polished ceramics.

Measurements can be performed by means of simple interference ring detection, IntelliPhase static spatial carrier analysis, or phase-modulated interferogram analysis. MarOpto Fizeau interferometers offer the flexibility and excellent performance that today's industrial applications demand.



MarOpto FI 1040 Z

Fizeau interferometer

DESCRIPTION

Powerful 40 mm Fizeau interferometer for flat and spherical surfaces

The MarOpto FI 1040 Z is a powerful interferometer that can provide contactless measurements on flats and spherical surfaces and of transmitted wavefronts. The MarOpto FI 1040 Z is ideal for measuring optical components such as flats, prisms and lenses or precision metal workpieces (bearings, sealing surfaces, and polished ceramics). Measurements can be performed by means of simple interference fringe detection, IntelliPhase static spatial carrier analysis, or phase-modulated interferogram analysis. The MarOpto FI 1040 Z offers the flexibility and excellent performance that today's industrial applications demand.

- 6x / 3x zoom for workpieces with a diameter of up to 1.5 mm
- 3 modes of interferogram analysis: Phase shifting, IntelliPhase – static spatial carrier analysis
- Small size allows easy integration into OEM systems
- Compact, rugged design
- Transmission spheres from F / 0.7 to F / 6.0

APPLICATIONS

- Transmission and surface testing of small optics
- Measurements on optics, machined parts, ceramics, semiconductors, and wafers
- Integrated radius of curvature measurements



For more information, please visit our website: www.mahr.com

MarOpto FI 1100 Z

Fizeau interferometer

DESCRIPTION

High accuracy measurement capability with unsurpassed flexibility and versatility

The MarOpto FI 1100 Z offers contactless measurements on flats and spherical lenses. In addition, wavefront measurements can be performed on optical components or assemblies in transmitted light. Measurements may be made by means of simple interference fringe analysis or phase-modulated interferogram analysis. The established IntelliWave software offers superior measurement and analysis capability. The MarOpto FI 1100 Z provides the versatility and reliability to handle today's advanced applications at unrivaled value for money.

- Total USB connectivity option (laptop or desktop) with 1k x 1k true spatial resolution
- Excellent versatility, stability and repeatability
- 1x to 6x zoom, focus and attenuation controls
- Vibration-insensitivity can be accomplished via Mahr's IntelliPhase™ Static Spatial Carrier Acquisition and Analysis Software
- Compact, lightweight and rugged design
- Compatible with all industry standard 4" (100 mm) reference optics and accessories
- High accuracy measurements at an affordable price
- Configurations include horizontal, vertical look up and vertical look down. Optional workstations for flats and for radius of curvature measurements



APPLICATIONS

- Measurement of flat, concave or convex surfaces
- Prism, corner cube, wedge angle and homogeneity measurements
- Measurement of machined, ceramic, and wafer surfaces
- Wavefront analysis of optical systems and components
- Integration into OEM systems

MarOpto MT 100

Measuring towers

DESCRIPTION

The MarOpto MT series provides various versions of modern workshop interferometer towers for use in the production environment. The vertical tower solutions offer simple lens handling, include vibration damping, and require minimal floor space. In addition to yoke testing, the towers with a scale ensure highly accurate radii measurements can be completed. Motorized axes help to complete tasks quickly and easily.

The **MarOpto MT 100** is a highly accurate Fizeau interferometer measuring tower used to test spherical and flat glass surfaces. The stable and vibration-resistant design make this 4" interferometer measuring tower the perfect tool for the production of high-performance lenses. It is also available as an inverse measuring tower – the **MarOpto MT 100i**.

- Highest precision in the production environment:
- Rigid granite tower with passive vibration isolation by four shock absorbers
- Measuring table with clearance-free bearings on linear slides
- Measuring table positioner via a servo motor and ball screw
- Fine selection of speed using joystick
- Manual fine adjustment of the measuring table with fine thread screw via backlash-free preloaded precision cross-roller guides
- 3-axes table: Z-axis in the basic unit and cross table for lenses up to 100 mm
- High-precision glass scale for the absolute measurement of radii, mounted close to the optical axis (Abbe comparator principle)

Options:

- The interferometer measuring tower MarOpto MT 100 can optionally be expanded with a lens extension, lens protection and lens holder.
- Remote control for focus and zoom
- Tilting table 120 mm



For more information, please visit our website: www.mahr.com

Mar4D | Cylinder coordinate measuring machines

The cylinder coordinate measuring machines from the Mar4D PLQ 4200 product range measure rotationally symmetrical workpieces with more flexibility and more conveniently than ever before. They also operate at the highest speed and level of precision providing fast and reliable measuring results.

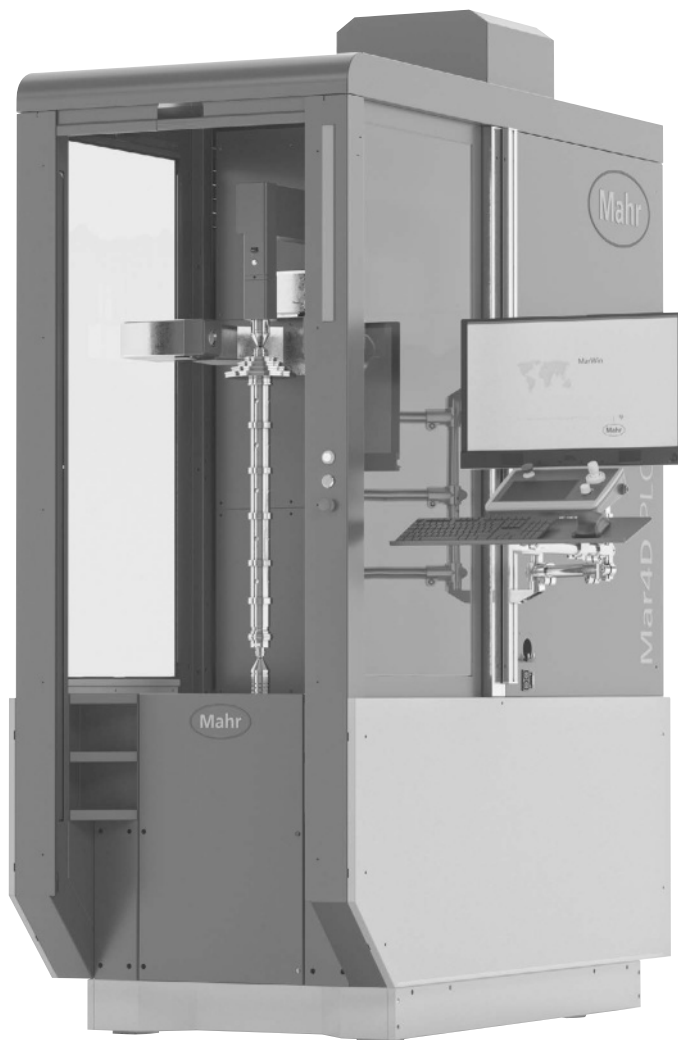

Overview Mar4D PLQ

Cylinder coordinate measuring machines

596

Mar4D PLQ 4200

Cylinder coordinate measuring machine

598

Mar4D PLQ 4200: Fast and precise measurement during production

The cylinder coordinate measuring machines from the Mar4D PLQ 4200 product line measure rotationally symmetrical workpieces with more flexibility and more conveniently than ever before. They operate at the highest speed and level of precision providing fast and reliable measuring results.

With the Mar4D PLQ 4200, Mahr provides its customers with a high-performance measurement solution for complex rotationally symmetrical workpieces. The multisensor system covers a particularly broad range of dimensional measuring tasks. The new machine also has a particularly sturdy design enabling 3D measurements to be completed directly during production, as well as offering shorter processing times and thus increased throughput and excellent productivity rates.



Advantages

- Future-proof due to combined measuring technology: optical and tactile solution in one machine
- Versatile: Measure several features such as the length, diameter, form, position, contour, roundness, roughness, or 3D geometries, such as the symmetry, during a single measuring run
- Fast and precise: Unique speed and optimum axis accuracy even as the tolerances become smaller, achieved thanks to specially developed control architecture
- Flexible for workpieces with a diameter up to 200 mm, a length of up to 1000 mm and a weight of up to 50 kg
- Ergonomic operation and unique safety concept

Fast alignment

The motorized tailstock with clamping force monitor secures the workpieces perfectly without operator intervention.

Process reliability when measuring

Monitoring systems in the machine record and compensate for external influences, such as temperature, vibrations and position in real-time.

Ergonomic design

The sophisticated design of the machine guarantees easy and safe operation.

Reliable software

Thanks to its clearly structured user interface, the MarWin platform software is very user friendly: learn once, apply again and again.

Universally applicable

The multisensor technology of the Mar4D PLQ 4200 enables measurement of various rotationally symmetrical workpieces directly in production.



Detailed information can be found on our website:
<https://metrology.mahr.com/en/mar4d-plq>

Mar4D PLQ 4200

Cylinder coordinate measuring machine

FEATURES

- Fast and precise measurement on the production line
- Simple operation
- Process reliability during measurement
- Ergonomic design
- Reliable software
- Universally applicable
- Telecentric precision optics



TECHNICAL DATA

Order no.		5554200/5554250	5554201/5554251	5554202/5554252
Type		PLQ 4200-T2 Z=450	PLQ 4200-T2 Z=730	PLQ 4200-T2 Z=1000
Dimensions W/H/D	mm	800 / 2200 / 1800	800 / 2500 / 1800	800 / 2500 / 1800
Workpiece weight	kg		max. 20 kg / max. 50 kg	
Workpiece dimension	mm	450	730	1000
Max. diameter	mm	200		
Measured value resolution		adjustable		
Lengths/Diameters	mm	0.01...0.0001		
Angle		0.01...0.0001 degrees (decimal) or degrees, minutes, seconds		
Error limit diameter only, $E_{BXZ,MPE}^*$	μm	$\leq (1 + L/150)$ L in mm		
Error limit only length parallel Z, $E_{BXZ,MPE}^*$	μm	$\leq (2 + L/200)$ L in mm		
Traversing speed Z		max. 200 mm/s		
Traversing speed X1		max. 200 mm/s		
Traversing speed X2		max. 50 mm/s		
Traversing speed C		max. 720°/s / 125°/s		
Traversing speed Y		max. 50 mm/s		

* Tempered workpiece at $t=20 \pm 2^\circ\text{C}$, on smooth surfaces ($R_z < 1 \mu\text{m}$) Din EN ISO 10360-7

Subject to technical changes

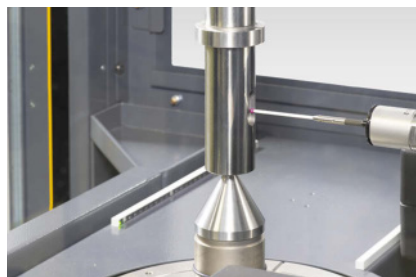

Tactile measurements with SP25

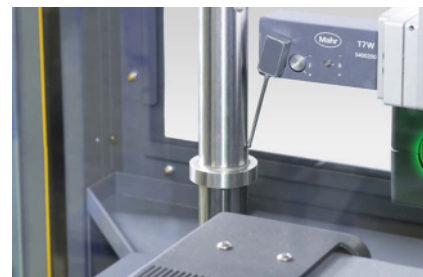

Tactile measurements with T7W

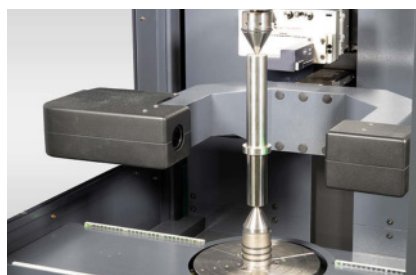

Optical measurements



Control panel

Mar4D PLQ 4200

Cylinder coordinate measuring machine

ACCESSORIES

Order no.	Description	Type
5361112	Center point 60°, Ø 2–5 mm, height 35 mm	
5361223	Center point 60°, Ø 2–44mm, height 46 mm	
5361105	Center point 60°, Ø 3–15 mm, height 25 mm	
5361106	Center point 60°, Ø 2–19 mm, height 44 mm	
9056631	Center point 60°, Ø 2–35 mm, height 46 mm	
5361104	Hollow point 90°, Ø 6–20 mm, height 56 mm	
3026166	USB keyboard German	
3026167	USB keyboard English	
5550400	Tactile probe motorized	T7W
5400211	Probe set	T7W
5550250	Tactile probe Renishaw	SP25M
5550251	Probe set 1 for SP25	
5550252	Probe set 2 for SP25	
5550083	MarControl manual control panel	
5550085	Second monitor plus holder	
5550080	Case plus package	
5550084	Industrial PC	
5550086	Panel PC, included in the scope of delivery	
5550091	Passive, controlled vibration isolation system	
5550100	MarWin complete package	Mar4D
5550460	Option roughness measurement T7W for PLQ 4200	
5480638	Software option roughness for AdvancedForm	
5360581	3-D contour standard (without calibration certificate)	
9964316	Mahr calibration certificate for contour standard	
6980110	DAkkS / DKD - calibration for contour standard	



Center point 60°
Ø 2–15 mm



Center point 60°
Ø 2–44 mm



Center point 60°
Ø 3–15 mm



Center point 60°
Ø 2–19 mm



Center point 60°
Ø 2–35 mm

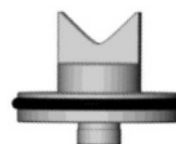

Hollow point 90°
Ø 6–20 mm

MarForm | Form measuring instruments

The error-free functioning and durability of a workpiece is determined not only by its dimensions but above all by its shape. Requirements are rising all the time, whether in terms of roundness, flatness, straightness, coaxiality or run-out - especially in the case of rotationally symmetrical workpieces. MarForm helps you to cut process costs, without driving up testing costs - by means of stable, innovative instruments offering a high degree of automation, flexibility and accuracy.



MarForm MMQ 100 Compact form measuring machine	605
MarForm MMQ 150 Compact form measuring machine	606
MarForm MMQ 200 Compact form measuring machine	607
MarForm MMQ 400 Universal form measuring machine	608
MarForm MMQ 500 Universal form measuring machine	610
MarForm MFU 200 Reference form measuring station	611
MarForm accessories	612
MarForm software MarWin	617



The latest information about MarForm products
is available on our website: www.mahr.com

Precise measurement of form and position – MMQ 500

Based on the variety of precise measurement options, the MarForm MMQ 500 is the best when it comes to tabletop formtesters. The optimized design of the machine ensures that it can be implemented universally guaranteeing maximum utilization. The innovative design of the device makes it extremely easy and safe to operate. You can position all of the components perfectly for your measurement using just one hand. The measuring process itself boasts impressively high speeds. This is because the Z-axis allows movements of up to 100 millimeters/second, making it more than three times faster than conventional measuring machines. The integrated, high-performance MarWin software with its clearly structured user interface provides a user-friendly and secure working environment.

- Universally applicable: from small workpieces that are a few millimeters in size through to heavy components with a weight of up to 80 kg
- Recording the form, position, roughness, contour, and lead in one measuring sequence
- Accurate alignment of workpieces by the automatic centering and tilting table
- Highest axis accuracy even as the tolerances become smaller
- Reliable repeatability even for difficult measuring tasks
- Intuitive software

High load capacity

Even heavy workpieces with a weight of up to 80 kg can be measured safely using the particularly high-performance centering and tilting table.

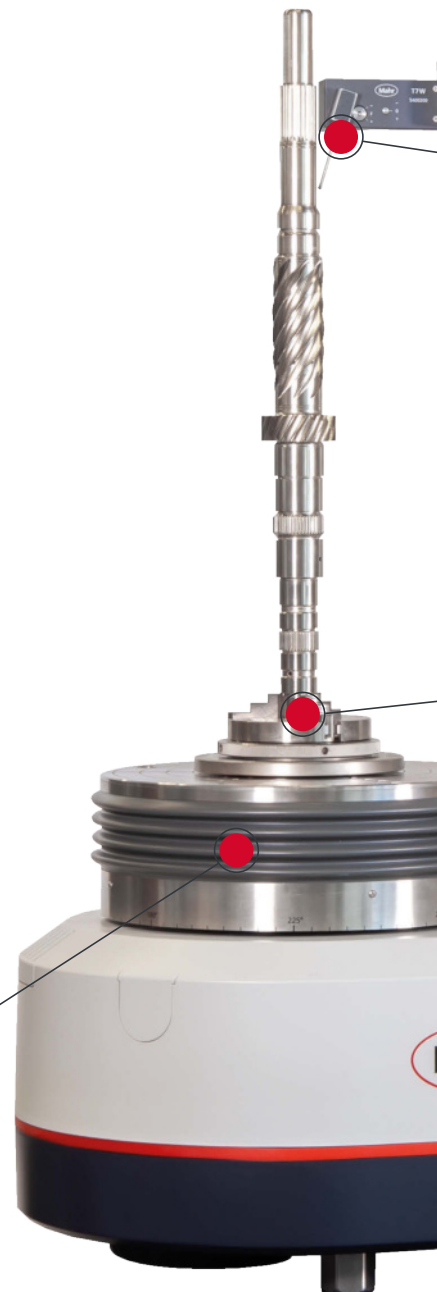

up to
100 mm/s
positioning speed

up to
80 kg
table load

0.01 μm
maximum accuracy
of the measuring axes

.5 μm
centering accuracy of the
centering and tilting table



Optimized base-to-base time

The Z-axis allows movements of up to 100 mm/s, making it more than three times faster than conventional form measuring instruments.

Fully automated probe arm replacement

The probe arm unit of the MarForm MMQ 500 holds up to four probe arms at once thus enabling the probe arm to be replaced quickly without any operator intervention.

More effective alignment

The centering and tilting table also enables complex workpieces to be aligned easily and quickly.

High measuring certainty

The mechanical bearing is up to 70 times stiffer than on comparable models making it insensitive to external influences.

MarForm. Form tester for a wide variety of applications

Form measuring instruments for workbenches or measuring rooms

In many aspects of our daily lives we put our faith in the reliable operation of technical components. From the ABS brakes, fuel injection system and gearbox in our car, to medical products such as prostheses, from the compressor in the air conditioning system to the blades on our razor, not to mention the landing flaps on our holiday airplane - the smooth interaction between moving parts is critical to their error-free function and durability. To guarantee this level of performance, rotationally symmetrical workpieces are manufactured under strict specifications for the permissible deviation from the ideal form. These tolerances can only be reliably tested with high-precision, specially optimized form testers. MarForm helps you to cut process costs, yet without driving up testing costs - by means of stable, innovative instruments offering the highest levels of accuracy. MarForm has the perfect combination for every need.

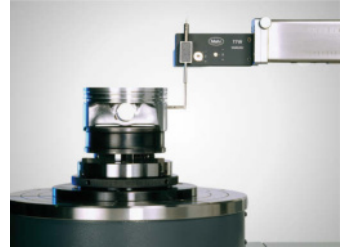
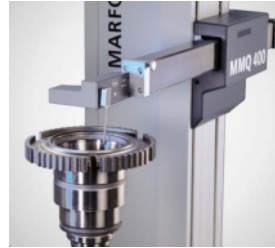

MarForm MMQ 100

Compact form measuring machine

FEATURES

The MarForm MMQ 100 form tester is the ideal solution for simple yet precise measuring tasks.

- Fast and accurate measuring results
- Mechanical bearings for reliability
- Large measuring volume
- Low weight and compact size for greater mobility
- Fast, computer aided workpiece alignment
- Centering and tilting knobs for coarse and fine adjustment
- Universal and reliable
- Workshop compatible, no compressed air connection required
- Touchscreen design eliminates the need for a keyboard or mouse
- Digital encoders in Z and X transfer the measuring position directly to the software

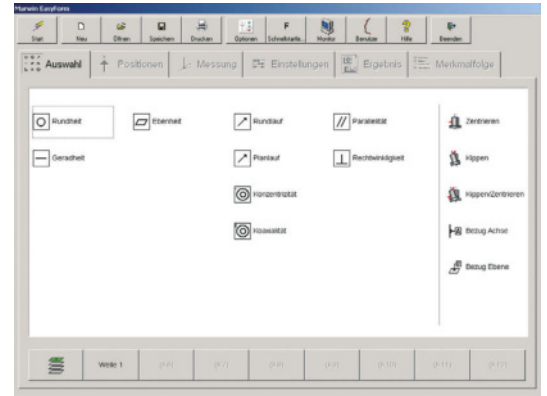

Options:

- AdvancedForm
- Mahr QE QS-STAT data export

VERSIONS

The **MMQ100** measuring station with EasyForm comes as a complete system, consists of the following:

- MarForm MMQ 100
- Digital encoders in X/Z
- T20W probe
- MarWin® EasyForm Software
- MarWin PC with WIN 10 operating system
- 24" TFT monitor
- Touch sensitive touch screen monitor (optional)



For more information, please visit our website: www.mahr.com

MarForm MMQ 150

Compact form measuring machine

FEATURES

MarForm MMQ 150 - Entry-level cylindricity measuring technology. The MMQ 150 is an automatic form tester for testing form and position tolerances:

- Use in production or in measuring rooms
- Fast and easy operation
- Measuring accuracy, optimized for cylindricity tolerances
- Less rejection, saves time, reduced production costs
- Maintenance-free, high-precision mechanical bearing

Options:

- Rim chuck Ø 100 mm
- Various additional clamps
- Commutator analysis
- Vibrational velocity analysis
- Upgrade to MarWin AdvancedForm
- 22" touch screen instead of 24" monitor
- Probe arms of various lengths and with various stylus ball geometries
- Various double probe arms
- Various calibration standards
- Various equipment tables, some with vibration compensation

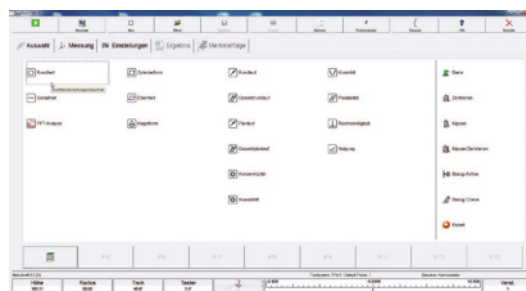

VERSIONS

The MMQ 150 measuring station, consists of the following:

- MarForm MMQ 150 form tester
- T20W length measuring probe with probe arm
- EasyForm Software for measuring and operating
- MarWin PC, Windows 10 operating system
- 24" monitor



For more information, please visit our website: www.mahr.com

MarForm MMQ 200

Compact form measuring machine

FEATURES

- Compact form measuring machine for manufacturing workshops and inspection rooms
- Proof of form and position deviations as per DIN/ISO 1101
- Fully automatic measuring sequences
- Precision roundness measuring axis (C)
- Motorized vertical measuring axis (Z)
- Motorized horizontal positioning axis (X)
- Manual centering and tilting table
- T20W manual length measuring probe or
- T7W motorized probe
- Ergonomic control panel, can also be used to start select measuring programs (P1, P2, P3)

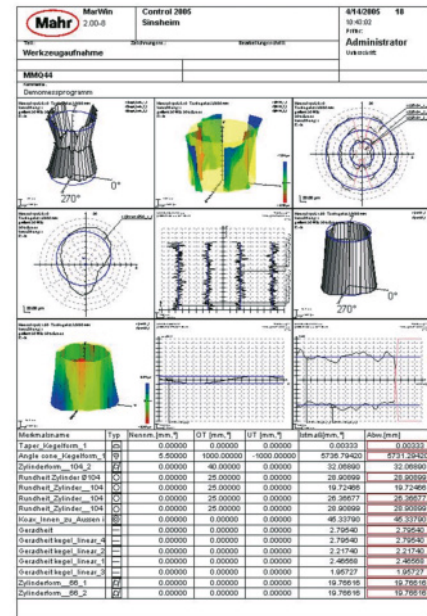

Options:

- 22" touchscreen TFT monitor instead of the 24" standard TFT
- Roughness measurement and evaluation with MMQ 200/T7W
- MarWin Software, diameter evaluation
- Various clamps
- Probe arms of various lengths and with various stylus ball geometries
- Various double probe arms
- Various calibration standards

VERSIONS

- The MarForm **MMQ 200** is available in two versions: As a measuring station with the universal measuring probe **T20W** and as a measuring station with the motorized measuring probe **T7W**, which takes automation another step forward with its unique motorization.
- The **MMQ 200** is operated with the **EasyForm** software. It is controlled by means of touchscreen technology, which also makes operation with the mouse exceptionally easy.

Form measuring station with T20W

- MarForm MMQ 200 form tester
- T20W length measuring probe, manual, with probe arm
- EasyForm measuring and operating software
- Intel-class PC, Windows 10
- 24" TFT monitor
- Rim chuck Ø 100 mm

Form measuring station with T7W

- MarForm MMQ 200 form tester
- T7W length measuring probe with probe arm
- EasyForm measuring and operating software
- Intel-class PC, Windows 10
- 24" TFT monitor
- Rim chuck Ø 100 mm



For more information, please visit our website: www.mahr.com

MarForm MMQ 400

Universal form measuring machine

FEATURES

- MarForm MMQ 400 is suitable for universal use for extensive workpiece evaluation according to DIN ISO 1101.
- High-precision measuring axes in Z and X make every form measuring task possible. There are MarForm MMQ 400 versions available for
- High-precision workpieces
- Unusually long workpieces
- Large and heavy workpieces
- Use in production or in inspection rooms
- Choose from a range of modules available to optimally customize the MarForm MMQ 400 to your requirements:
- Motorized or manual centering and tilting table
- Vertical axis (Z) with a 900 mm, 500 mm or 350 mm measuring length
- Horizontal axis (X) with a 180 mm or 280 mm measuring length and with digital linear scales in axes X and Z. For measurements where finding the exact, reproducible measuring position affects the result
- Manual or fully automatic probe with short measuring circle, high linearity, low measuring force.
- **Path control for quick measurement of a nominal contour**
- optionally with **motorized tailstock for shafts longer 200 mm**

Options:

- Roughness measurement
- Switch between form probe with ruby ball and roughness probe PHT 6–350
- Piston testing with MarWin Evaluation Software
- Shaft twist testing and analysis with MarWin
- Cam profile testing
- Bar to bar variation analysis at commutators
- Contour measurement and evaluation
- Path control (MCPC)
- Free form evaluation
- Vibrational velocity analysis
- Dominant roundness waviness (MBN 10455)

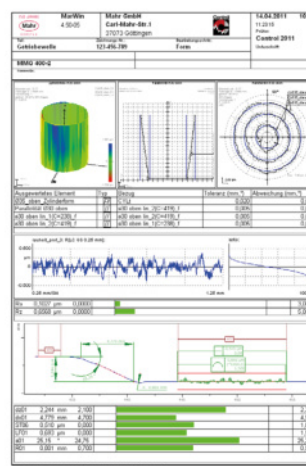

For more information, please visit our website: www.mahr.com

MarForm MMQ 100 / MMQ 150 / MMQ 200 / MMQ 400

Compact form measuring machine

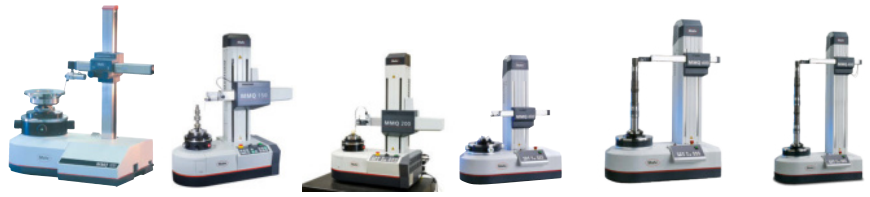

Tabletop form tester overview	MMQ 100	MMQ 150	MMQ 200	MMQ 400-2 Z = 350 mm X = 180 mm	MMQ 400-2 Z = 500 mm X = 280 mm	MMQ 400-2 Z = 900 mm X = 280 mm
Roundness measuring device, C-axis						
Roundness deviation ($\mu\text{m}+\mu\text{m}/\text{mm}$ measuring height) **	0.05 + 0.0006	0.03 + 0.0006	0.03 + 0.0006	0.02 + 0.0005	0.02 + 0.0005	0.02 + 0.0005
Roundness deviation ($\mu\text{m}+\mu\text{m}/\text{mm}$ measuring height) *	0.025 + 0.0003	0.015 + 0.0003	0.015 + 0.0003	0.01 + 0.00025	0.01 + 0.00025	0.01 + 0.00025
Axial runout deviation ($\mu\text{m}+\mu\text{m}/\text{mm}$ measuring radius) **	0.04 + 0.0006	0.04 + 0.0006	0.04 + 0.0006	0.04 + 0.0002	0.04 + 0.0002	0.04 + 0.0002
Axial runout deviation ($\mu\text{m}+\mu\text{m}/\text{mm}$ measuring radius) *	0.02 + 0.0003	0.02 + 0.0001	0.02 + 0.0001	0.02 + 0.0001	0.02 + 0.0001	0.02 + 0.0001
Centering and tilting table						
Centering and tilting table	manual	manual	manual	manual / automatic	manual / automatic	automatic
Table diameter	160	160	160	285	285	285
Table load capacity, centered (N)	200	200	200	600	600	400
Speed (rpm) 50 Hz / 60 Hz	5 / 6	1–6	0.2–15	0.2–15	0.2–15	0.2–15
Vertical unit, Z-axis						
Positioning path (mm) Z axis	300, manual	-	-	-	-	-
Z axis positioning	manual	-	-	-	-	-
Measuring path, motorized Z (mm)	-	250	250	350	500	900
Straightness deviation / 100 mm measuring path (μm)**, Z axis	-	0.4	0.15	0.15	0.15	0.15
Straightness deviation / total measuring path (μm)**, Z axis	-	1	0.3	0.3	0.4	0.9
Parallelism deviation Z-/C axis in tracing direction, measuring path (μm)	-	1	0.5	0.5	0.8	2
Measuring speed (mm/s), Z axis	-	0.5–30	0.5–30	0.1–30	0.1–30	0.1–30
Positioning speed (mm/s), Z axis	-	0.5–50	0.5–100	0.5–100	0.5–100	0.5–100
Horizontal unit, X axis						
Positioning path (mm), X axis	180, manual	150, motorized	150, motorized	-	-	-
Measuring path, motorized X (mm)	-	-	-	180	280	280
Straightness deviation / 100 mm measuring path (μm)**, X-axis	-	-	-	0.4	0.5	0.5
Straightness deviation / total measuring path (μm)**, X axis	-	-	-	0.8	1.5	1.5
Perpendicularity X/C axis, measuring path (μm)	-	-	-	1	2	2
Positioning speed (mm/s), X axis	-	0.5–30	0.5–30	0.5–30	0.5–30	0.5–30
Measuring speed (mm/s), X axis	-	-	-	0.5–10	0.5–10	0.5–10

* Values as maximum deviation from LSC reference circle, filter 15 undulations/revolution.

** All values in accordance with DIN ISO 1101 at 20°C ±1°C in a vibration-neutral environment, filter 15 undulations/revolution LSC or 2.5 mm LSS, 5 rpm or 5 mm/s and standard probe arm with ball diameter 3 mm. Proof at the standard using error separation techniques. Given the number of different options available, only a few machines are described here by way of example. Technical data for "your" MMQ is available from Mahr on request



For more information, please visit our website: www.mahr.com

MarForm MMQ 500

Universal form measuring machine

FEATURES

The MarForm MMQ 500 is the best choice among tabletop form testers due to its wide range of options for high-precision measurement. Due to its optimized machine design, it can be used universally and enables maximum utilization.

- Universally applicable for small workpieces of a few millimeters in size up to heavy workpieces up to 80kg
- Intuitive to use software
- Highest axis accuracy even with decreasing tolerances
- Best repeatability even with difficult measuring tasks
- Measurement of form, position, roughness, contour and twist in one measuring sequence



TECHNICAL DATA

MMQ 500	
Diameter max.* (mm)	530
Measuring distance Z (mm)	470
Type	MMQ 500
Roundness deviation ($\mu\text{m}+\mu\text{m}/\text{mm}$ measuring height)**	0.02 + 0.0005
Roundness deviation ($\mu\text{m}+\mu\text{m}/\text{mm}$ measuring height)*	0.01 + 0.00025
Axial run-out deviation ($\mu\text{m}+\mu\text{m}/\text{mm}$ measuring radius)**	0.04 + 0.0002
Axial run-out deviation ($\mu\text{m}+\mu\text{m}/\text{mm}$ measuring radius)	0.02 + 0.0001
Centering and tilting table	automatic
Table diameter	300
Table load capacity, centered (N)	800
Straightness deviation / total measuring path (μm)**	0.3
Parallelism deviation Z-/C-axis in tracing direction (μm)	0.6
Measuring speed (mm/s), Z axis	100

* Values as maximum deviation from LSC reference circle, filter 15 undulations/revolution.

** All values in accordance with DIN ISO 1101 at 20°C \pm 1°C in a vibration-neutral environment, filter 15 undulations/revolution LSC or 2.5 mm LSS, 5 rpm or 5 mm/s and standard probe arm with ball diameter 3 mm. Proof at the standard using error separation techniques. Given the number of different options available, only a few machines are described here by way of example. Technical data for "your" MMQ is available from Mahr on request

MarForm MFU 200

Reference form measuring station

FEATURES

- Reference form measuring station in a new dimension
- The journey from high precision measuring axes to competent measurements is often a long one that the **MFU 200** has mastered completely. Only the **MFU 200** has integrated reference elements for the real-time spatial compensation of geometric deviations, recording all profiles as high precision 3D coordinates.
- For decades, **MarForm** measuring machines have been recognized for their accuracy and stability. The **MFU 200** was developed with the claims of testing the shape and position features of product parts in a one liter measuring volume close to the production area and at a reasonable cost. In doing so, it has taken our long experience into a new dimension.
- **MFU 200** is a precision reference form measuring center. Its exceptionally low measurement uncertainty increases the tolerance margin for your production processes, thereby lowering production costs.

The form measuring center consists of the following components:

- Circular roundness measuring axis (C)
- Motorized centering and tilting table (X, Y, A, B)
- Roundness measuring axis circular (C- high-speed, up to 200 U/min)
- Vertical straightness measuring axis (Z)
- Horizontal straightness measuring axis (X)
- Tangential multifunction axis (Y)
- Motorized length measuring probe T7W
- MarWin Evaluation Software for form and position features
- The consistent separation of control and evaluation makes **MFU 200** future-proof and expandable. New language versions can be implemented just as effectively as special evaluations and new standards. The **MFU 200** is also already prepared for the use of optical sensor technology, the MarForm IPS, and can thus also measure micro surface structures with high precision.
- In short: **MFU 200** brings form measuring machines for inspection rooms and production areas into a new dimension.



TECHNICAL DATA

MFU 200	
Type	MFU 200
Monitor	19" TFT monitor (touchscreen monitor)
Control panel	MCP 12
Motorized measuring probe	T7W
Probe arm	60 mm ø 1.0, ruby, M2, 60 degrees, prepared for the connection of the optical sensor IPS15
Pitch error	Pitch error of the C-/Z-/X-axis is calibrated

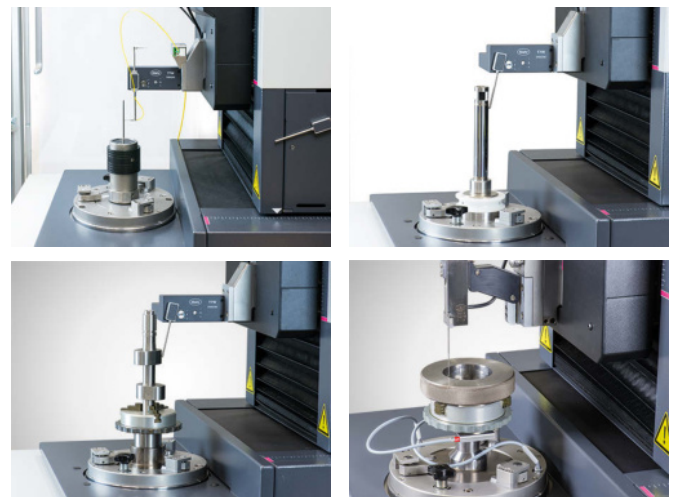

APPLICATIONS

- Checking product parts for form and position features
- Roundness, concentricity / coaxiality, cylindricity, concentricity, axial runout, radial runout, total runout, straightness, parallelism, squareness, inclination, flatness, conicity, diameter, taper, Fourier analysis (waviness analysis), line profile, area profile, cam shape
- Recording of all profiles as high-precision 3D coordinates with real-time
- Spatial compensation of geometric deviations
- Scanning of surfaces, roughness evaluation
- Scanning and evaluation of contours and shapes

Probe arms for T20W probe

Ident-Nr.: 5400160

FT0002-0100,000

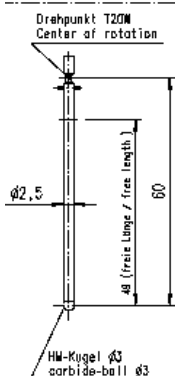

Ident-Nr.: 5400161

FT0002-0300,000

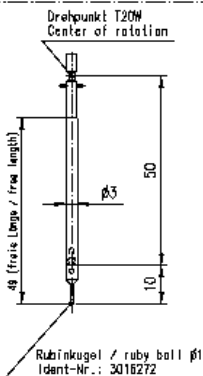

Ident-Nr.: 5400162

FT0002-0350,000

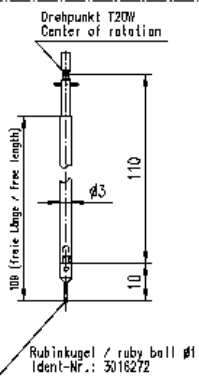

Ident-Nr.: 5400170

FT0002-0380,000

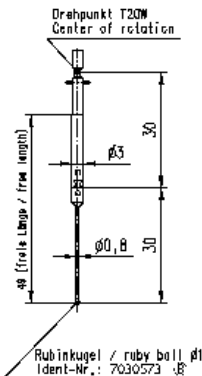

Ident-Nr.: 5400163

FT0002-0200,000

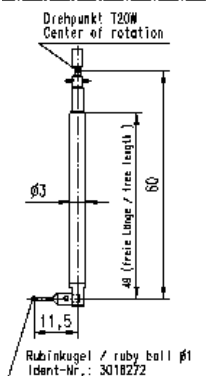

Ident-Nr.: 5400164

FT0002-0250,000

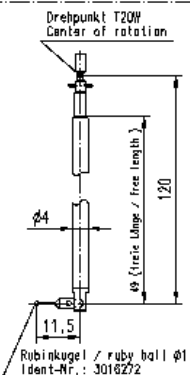

Ident-Nr.: 5400169

FT0002-0700,000

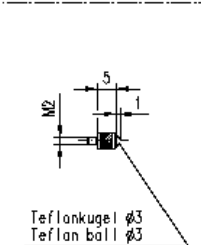

Ident-Nr.: 5400165

FT0002-0400,000

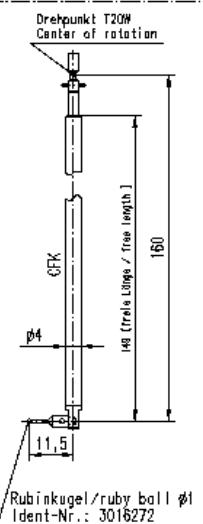

Ident-Nr.: 5400166

FT0002-0500,000

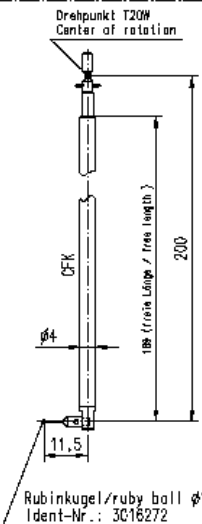

Ident-Nr.: 5400167

FT0002-0600,000

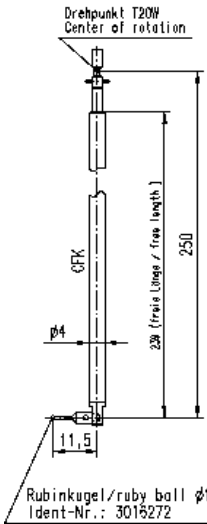

Taststifte / Stylus M2

Ident-Nr.	Kugel- ϕ [mm] ball- ϕ [mm]	Material	Wirklänge [mm] operation length [mm]
4662093	0,3	Ruby/ruby	10
4662090	0,5	Ruby/ruby	10
3016272	1,0	Ruby/ruby	10
8156089	1,0	Ruby/ruby	20
8154125	1,5	Ruby/ruby	10
8154398	3,0	Ruby/ruby	10
8159402	5,0	Ruby/ruby	20
8162168	1,0	HM/carbide	10
8049415	1,5	HM/carbide	10
8162164	2,0	HM/carbide	10
8159618	3,0	HM/carbide	20
8049416	5,0	HM/carbide	20

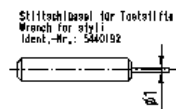

Ident-Nr.: 5400168

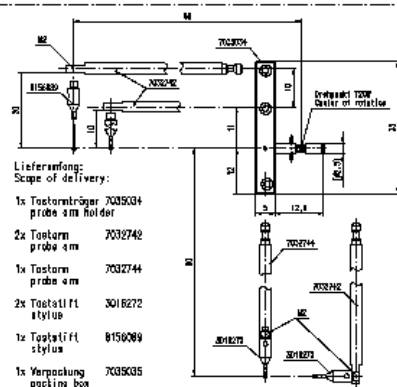

- Lieferumfang:
Scope of delivery:
- 1x Tastorträger 7035034 probe arm holder
 - 2x Tastarm 7032742 probe arm
 - 1x Tastarm 7032744 probe arm
 - 2x Taststift 3016272 stylus
 - 1x Taststift 8156089 stylus
 - 1x Verpackung 7035035 packing box

The optimal solution using accessories

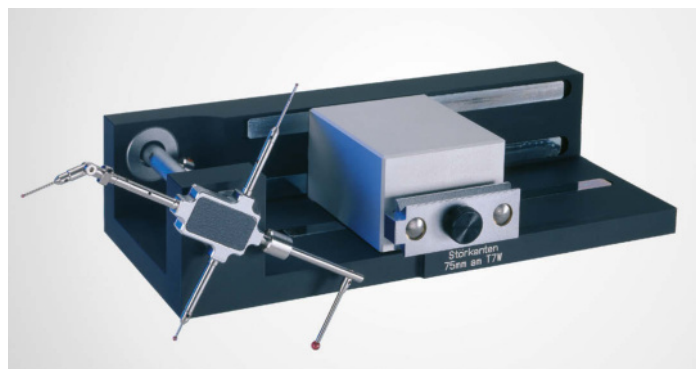

Device for balancing probe arms



Motor-driven T7W probe

The T7W probe is fitted with a motor-driven rotational axis. This makes it possible to move the probe arm gradually to the required contacting position. As a result, measurements can be performed on cylindrical surfaces and end faces. As a zero position probe, the T7W can also switch automatically between internal and external measurements or between end face measurements from above and below without operator intervention. Fully automatic measurement processes on complex workpieces can be carried out without operator intervention too. The probe arms of the T7W are exchangeable. Its motor-driven rotational axis enables the construction of „multi-point probe arms“ - i.e. probe arms with a variety of contacting elements - making it possible to switch between different stylus ball geometries within a single measurement run.

Motor-driven T7W probe with probe arm range of 360° for MMQ 400 and MMQ 400 CNC Order No. 5400200

- Total measuring range of 2.000 µm (0.079“)
- Zero probe with a working range of ± 500 µm (± 0.0197“)
- Measuring force adjustable from 0.01 to 0.2 N
- Two-way measuring direction
- Contacting angle freely selectable in 1° steps
- 360° adjustable (motor-driven)
- Probe arms easily exchangeable (magnetic mount)
- Flexible multi-point probe possible
- Mechanical and electrical overload protection

Accessories for motor-driven T7W probe

Probe arm module for T7W Order No. 5400221
in storage case, consisting of:

- | | |
|---|----------------------------------|
| Stylus arm dia. 0.5 mm,
L=20 mm, M2a | Weight 5.0 g |
| Stylus arm dia. 1.0 mm,
L=20 mm, M2a | Probe arm L=15 mm 2x M2 |
| Stylus arm dia. 1.0 mm,
L=15 mm, M2a | Stylus arm extension 10 mm, M2 |
| Stylus arm dia. 1.5 mm,
L=10 mm, M2a | Stylus arm extension 20 mm, M2 |
| Stylus arm dia. 3.0 mm,
L=10 mm, M2a | Stylus arm extension 30 mm, M2 |
| Stylus arm dia. 3.0 mm,
L=25 mm, M2a | Stylus arm extension 40 mm, M2 |
| Weight 1.5 g | Rotary swivel joint M2 |
| Weight 1.0 g | Hex head screwdriver A/VF 1.5 |
| Weight 2.0 g | Hex head screwdriver A/VF 0.9 |
| Weight 3.0 g | Rotary part M2, concentric |
| Weight 0.5 g | Wrench 1.0 |
| Weight 10.0 g | Stylus arm holder M2i transverse |
| | Stylus arm holder M2i axial |
| | Stylus M2i transverse |
| | Mount 2x M2i transverse |
| | Guide |
| | Adjuster |

Probe arm for T7W probe

Probe arm set for T7W

Order No. 5400211

Consisting of one each of probe arms 5400225, 5400226, 5400229 and 5400230

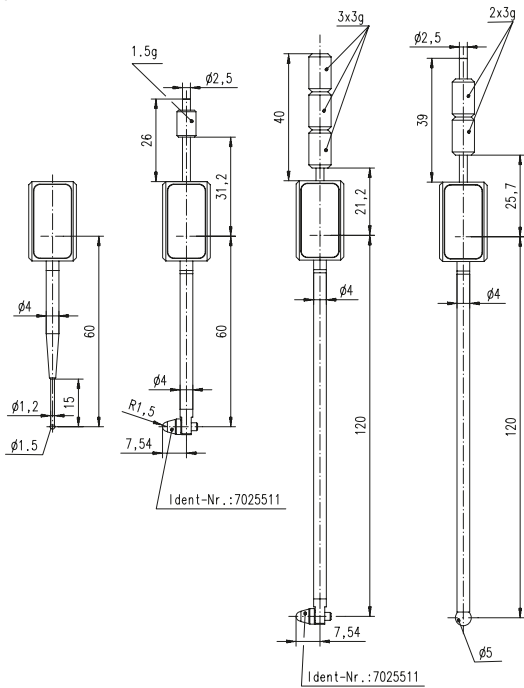

Probe arm set # 2 for T7W

Order No. 5400220

for measuring small workpieces, consisting of a probe arm holder and three exchangeable M2 styli

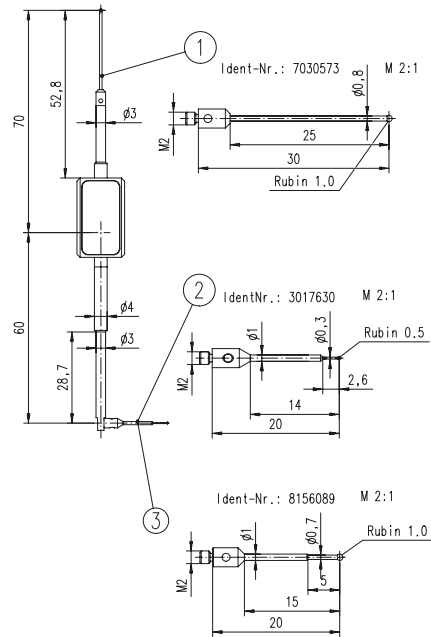

Probe arm module for T7W

Order No. 5400221

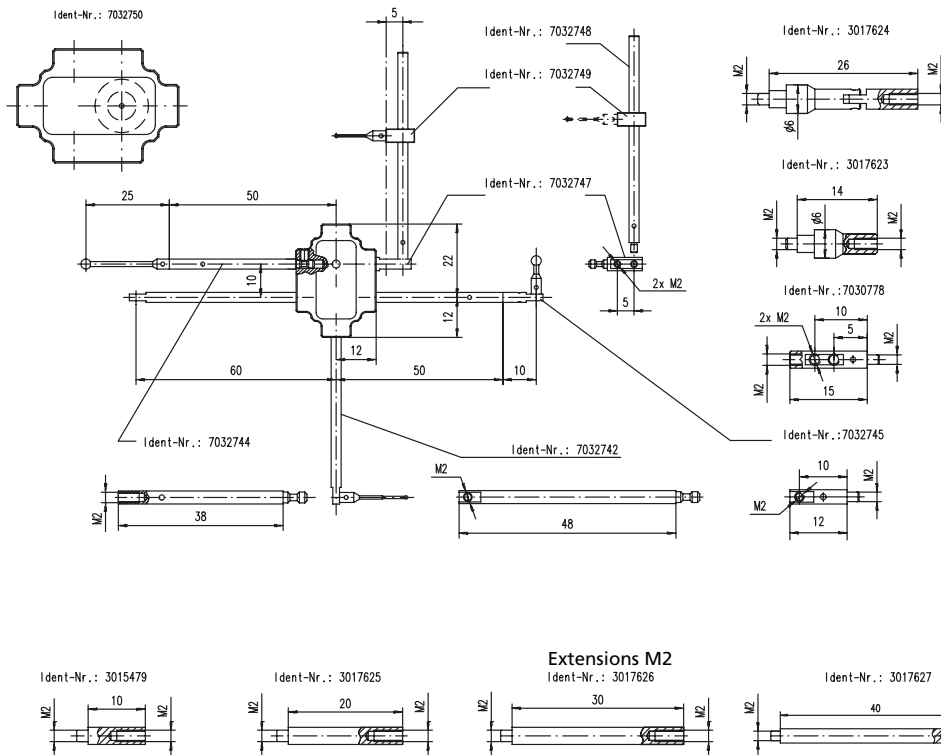

Stylus arms M2

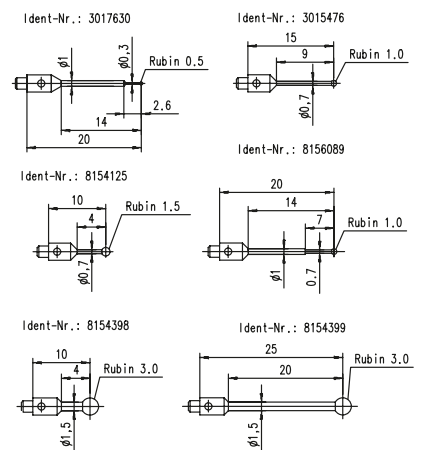

Weights

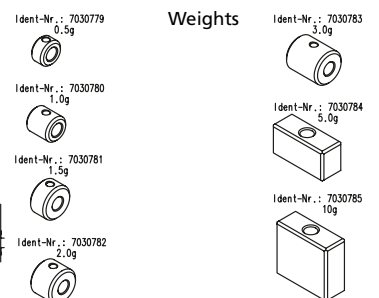

Extensions M2

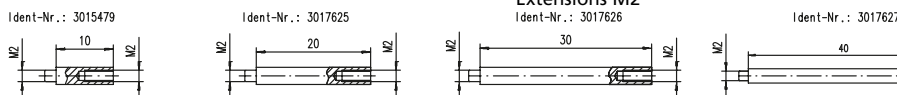

ACCESSORIES

Order no	Description
	Hardware (mandatory item):
9028023	Calibration sphere Ø 15 mm with Mahr calibration certificate
9064901	with MarWin PC with WINDOWS 10, multi-lingual
3026857	Wireless keyboard K400 plus Logitec, German
3026858	Wireless keyboard K400 plus Logitec, English
6710620	Three-jaw chuck with flange, Ø 100 mm, not to be used with basic holder
3017216	Basic holder for quick clamp/retriever interface
9004831	Rim chuck with three jaws, Ø 50 with column and flange for MFU quick clamp
	Software (optional/mandatory item):
5480312	ProfessionalForm software
5480311	AdvancedForm software
	Optical sensor for MFU 200 plus:
5400275	Interferometric controller with IPS15, including rack to hold the IPS box

Further, extensive accessories on request



Three-jaw chuck with column



Calibration sphere



Rim chuck

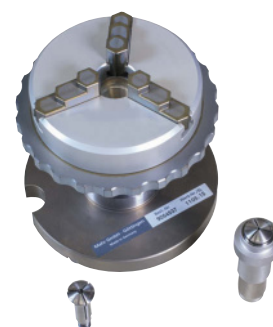

Rim chuck with collet chucks

MarGear | Gear measuring instruments

MarGear metrology allows you to carry out your measuring tasks on gears and gear cutting tools quickly, simply and accurately, in just one measuring process. The flexible systems, create the best possible conditions for gaining and retaining a competitive edge. With or without mechanical alignment and reclamping, and with a combination of gear metrology, form and position evaluation. By fully integrating metrology into production, you can achieve a closed quality control loop in transmission manufacturing.



MarGear GMX 400 W Universal gear measuring center	622
MarGear GRP1 Roughness probe system	623



The latest information about MarGear products is available on our website: www.mahr.com

MarGear. GMX W series

Opening up a new dimension

The W series extends the MarWin® platform to Mahr gear measurement

- MarEcon control unit with tracking mode
- Gear testing software runs under MarWin (option)
- Intuitive GDE interface for gear data (option)
- MarForm Advanced and Professional (option)
- Easy program creation in teach-in mode
- Integration of data matrix code scanners (option)
- Uninterrupted movements
- High precision target positioning
- 3D visualization of gear geometry

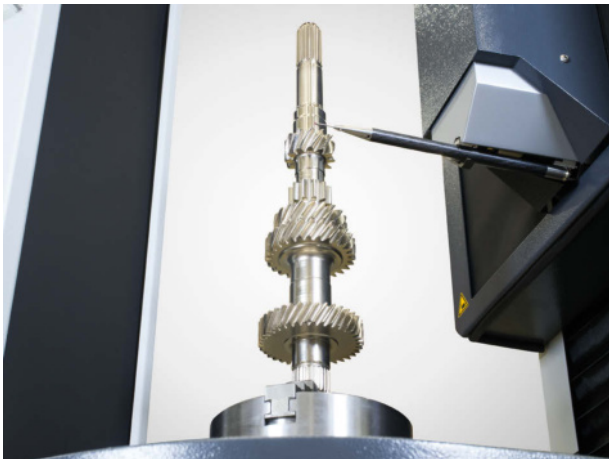
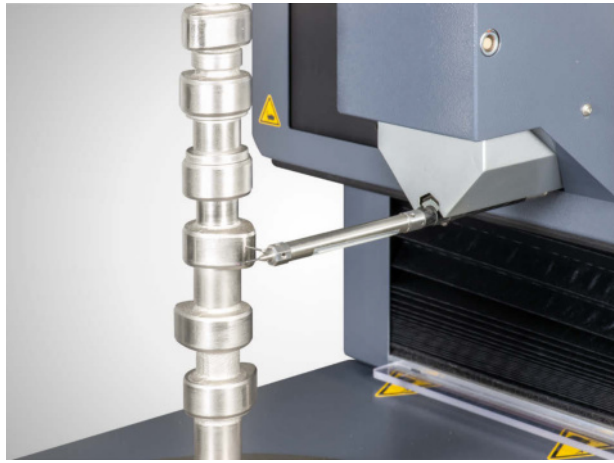
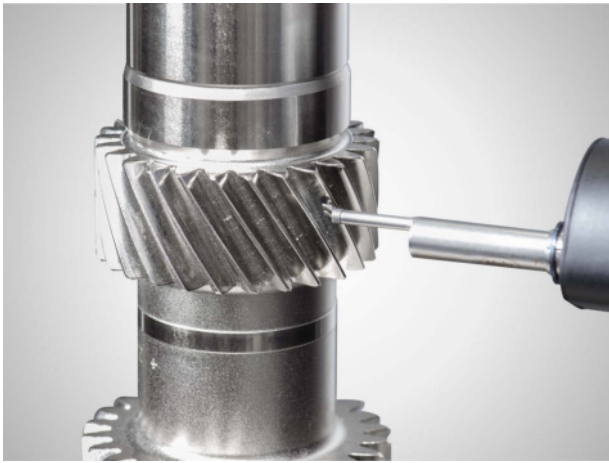

MarGear. GMX W series

Opening up a new dimension

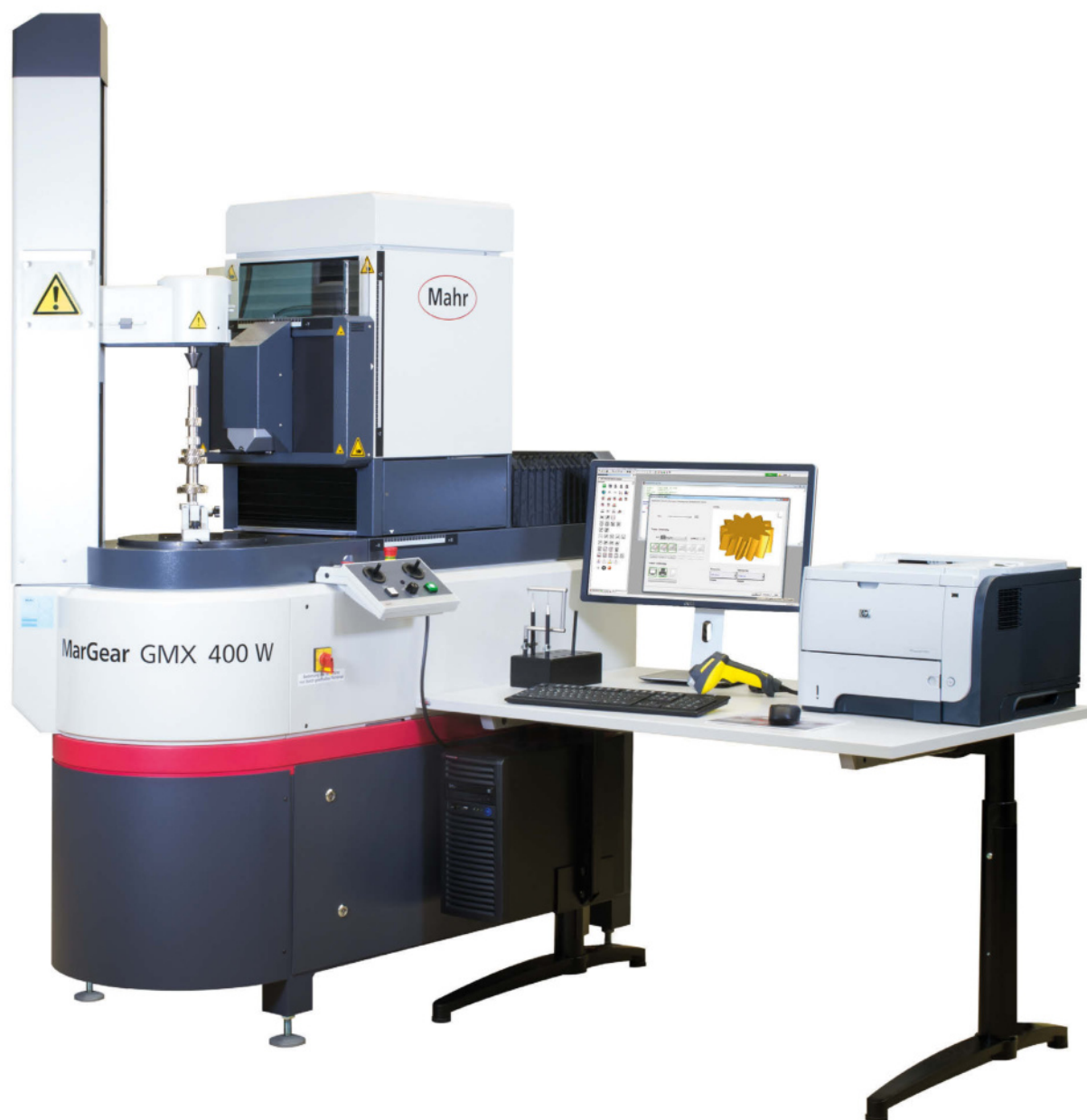

MarGear GMX 400 W

Universal gear measuring center

FEATURES

- Precision, fully automatic testing of gears up to an outer diameter of 400 mm
- Combining gear measuring tasks with various form and position features has never been easier
- With over 6000 units sold, the MarWin environment is a clear and simple way of creating complete programs in teach-in mode
- Improves programming efficiency and reduces the possibility of incorrect use
- Proven GMX realtime machine error correction is also used for positioning movements with the new MarEcon control unit, guaranteeing maximum speed and precision throughout the entire measuring and movement sequence
- **Gear, form and 3D measurements** are performed on one measuring instrument
- **High-precision 3D scanning sensor** combined with directly driven C-axis for accuracy and efficiency
- GDE interface: "Closed loop" for cylindrical gears
- With tailstock option
- Gear measuring instrument, accuracy class 1, for gear measurements in accordance with VDI/VDE 2612/2613 Group 1 at 20°C ± 2 K (rotational axis in formtester accuracy)



TECHNICAL DATA

GMX 400 W	
Measuring path X (mm)	200
Measuring path Y (mm)	200
Measuring path Z (mm)	320
Diameter max.* [mm]	400
Length	1520
Width	621
Height	1920
Mass [kg]	760
Max. workpiece weight [kg]	60
Accuracy	Accuracy class I for gear measurements in accordance with VDI/VDE 2612/2613 Group 1 at 20°C ± 2°C
Axial runout deviation ($\mu\text{m} + \mu\text{m}/\text{mm}$ measuring radius)	0.11 μm + 0.0008 $\mu\text{m}/\text{mm}$
Radial runout deviation (μm in table height)	$\leq 0.11 \mu\text{m}$

* Max. diameter of cylindrical gears

APPLICATIONS

Fully automatic testing of:

- Straight and helical toothed cylindrical gears
- Form and position measurements
- Diameters and lengths

ACCESSORIES

- Data matrix scanner
- Range of chucks for "clamping on the fly" and measurements on "virtually" aligned workpieces (wobble coordinate system)
- Roughness probe GRP1



For more information, please visit our website: www.mahr.com

MarGear GRP1

Roughness probe

FEATURES

- Expansion package for roughness measurement and analysis on gears
- In the field of gear metrology, Mahr already offers highly accurate reference systems that combine gear measurement with the measurement of diameters or form. Moreover in the field of surface metrology, we at Mahr have brought the worldwide styling method to perfection.
- So what could be more obvious than to measure and document roughness parameters such as Ra and Rz when testing your workpieces with a gear measuring device?
- As a specialist for inductive probes, Mahr combines the advantages of its self-developed universal 3D probe with the precision of the proven roughness probe PHT. Gear and roughness measurement grow together.
- Combine the gear analytical measurement with roughness characteristics monitoring on the MarGear GMX series gauging centers. Simultaneously document typical roughness parameters such as Ra and Rz during inspection without reclamping the workpiece on another measuring station. The superior positioning accuracy of the MarGear GMX combined with the new motorized swivel axis of the MarGear roughness probe ensures maximum reproducibility.

Your advantages:

- Miniaturized roughness probe for gears from module 0.8
- The MarWin platform allows the use of our known roughness software for surface metrology at the gear measuring center
- Automatic swivel axis of the roughness probe enables standard surface measurement even on helical gears
- Characteristic values e.g. according to ISO 4287 or ISO 13565-2



APPLICATIONS

- Roughness at teeth flanks
- Roughness at bearing positions



For more information, please visit our website: www.mahr.com

MarShaft | Shaft measuring instruments

The role of metrology is changing, to keep pace with innovations in manufacturing processes. Given the continual stringent accuracy requirements and falling cycle times, rapid measurement directly at the manufacturing machine is absolutely essential. Flexible MarShaft metrology from Mahr is the right solution for quick and accurate measurement in production.



Overview MarShaft	626
Shaft measuring instruments	
MarShaft SCOPE 250 plus	631
Universal, fully automatic optical shaft measuring system	
MarShaft SCOPE plus	632
Optical shaft measuring system	
MarShaft SCOPE 600 plus 3D	633
Optical shaft measuring system	
MarShaft accessories	634
MarShaft Software EasyShaft	636



The latest information about MarShaft products
is available on our website: www.mahr.com

MarShaft SCOPE 600 plus 3D – Universal measuring machine in production

Best performance

also suitable for use in workshop environments, short paths, increase in measuring capacity, no wait times

Measurements without user intervention

The measuring sequences are fully automatic, completely free of user influences, reliable measuring results, avoidance of measurement errors

Quick and easy

Quick measurement and quality reading of the workpiece prevents waste and increases productivity in production

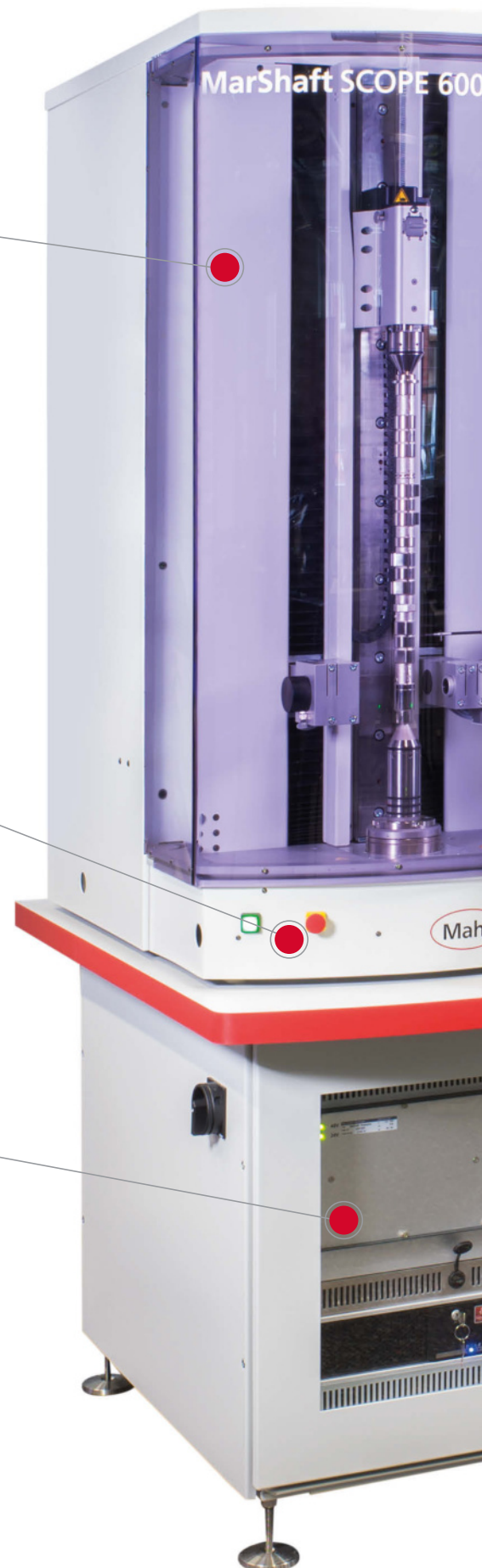



Flexible layout

9 different versions for maximum precision - through customized solutions

Flexible and universal measuring machine

5 measuring machines in one, shaft measuring machine, formtester, contour measuring instrument, 3D measuring machine and gear measuring instrument

Software platform

One user-friendly software, MarWin platform for shafts, form, gears, and contours

MarShaft

Shaft measuring instruments

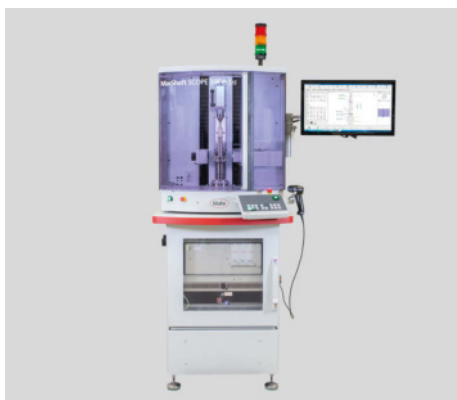

Shaft measuring instruments overview	SCOPE 250 plus 5361802	SCOPE 350 plus 5361507	SCOPE 750 plus 5361508
Order no.			
Measuring range length (Z) (mm)	250	350	750
Measuring range diameter (X) (mm)	40	120	120
Workpiece weight (max.) in kg	5	15 (optional 30)	15 (optional 30)
Length/diameter resolution (mm)	0.01 to 0.0001	0.01 to 0.0001	0.01 to 0.0001
Angle resolution (°)	0.01 to 0.0001	0.01 to 0.0001	0.01 to 0.0001
Length error limit (Z) (µm)	$\leq (3.0 + L/125)$ L in mm	$(2 + L/125)$ L in mm (at 20 °C ± 1 °C on reference standard)	$(2 + L/125)$ L in mm (at 20 °C ± 1 °C on reference standard)
Diameter error limit (X) (µm)	$\leq (1.5 + L/40)$ L in mm	$(1.0 + L/125)$ L in mm (at 20 °C ± 1 °C on reference standard)	$(1.0 + L/125)$ L in mm (at 20 °C ± 1 °C on reference standard)
Drives	Servo motors	Servo motors	Servo motors
Optics	Telecentric precision lens high-resolution CMOS camera	Telecentric precision lens high-resolution CCD array	Telecentric precision lens high-resolution CCD array

MarShaft

Shaft measuring instruments



Shaft measuring instruments overview	SCOPE 1000 <i>plus</i>	SCOPE 600 <i>plus 3D</i>
Order no.	5361516	5361522
Measuring range length (Z) (mm)	1000	600
Measuring range diameter (X) (mm)	120	120
Workpiece weight (max.) in kg	15 (optional 30)	15
Length/diameter resolution (mm)	0.01 to 0.0001	0.01 to 0.0001
Angle resolution (°)	0.01 to 0.0001	0.01 to 0.0001
Length error limit (Z) (µm)	(3 + L/125) L in mm (at 20 °C ± 1 °C on reference standard)	(2 + L/125) L in mm (at 20 °C ± 1 °C on reference standard)
Diameter error limit (X) (µm)	(1.50 + L/125) L in mm (at 20 °C ± 1 °C on reference standard)	(1.0 + L/125) L in mm (at 20 °C ± 1 °C on reference standard)
Drives	Servo motors	Servo motors
Optics	Telecentric precision lens high-resolution CCD array	Telecentric precision lens, high-resolution CCD array

MarShaft. Measurement of shaft-type parts in production.

MarShaft measuring instruments are mostly used in production. However, with their high measuring accuracy they can also be used in measuring laboratories. The instruments are available in various sizes, and their modular design allows them to be optimized to individual measuring tasks. Inline measurement directly in the manufacturing process saves the time and expense of measurements in the measuring room and increases productivity.

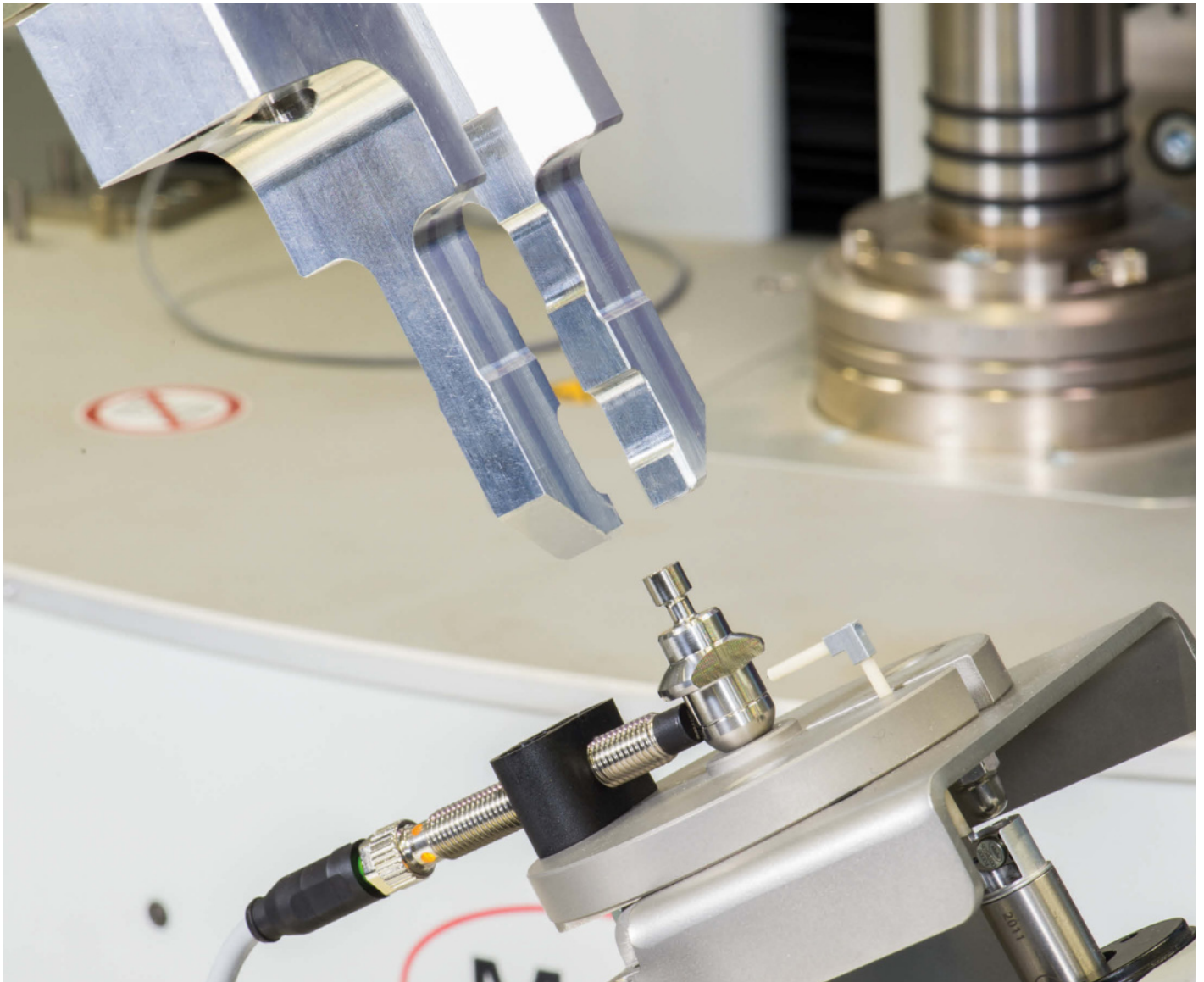

MarShaft SCOPE 250 *plus*

Fully automatic universal optical shaft measuring system

DESCRIPTION

The role of dimensional metrology is expanding at a dramatic rate, in parallel with innovations in manufacturing processes. Given the ever more stringent accuracy requirements and falling cycle times in production (turning, milling, grinding, etc.), rapid measurement directly at the manufacturing machine is absolutely essential. Measurement at the point of origin of the product, with rapid feedback to the manufacturing process to avoid waste. Mahr's flexible MarShaft SCOPE 250 *plus* shaft measuring machine offers the right measuring solution for the fast, precise and fully automatic measurement of rotationally symmetrical workpieces in production.

The MarShaft SCOPE 250 *plus* has a high precision roundness measuring axis (C) and a vertical measuring axis (Z) with a measuring range of 250 mm. At its heart is the state-of-the-art, high-resolution CMOS matrix camera (live image) with an image field of 1088 x 2048 mm. The extremely high image acquisition rate of over 120 images per second keeps measuring times to a minimum. Zoom functions allow the smallest details to be measured, which with conventional measuring methods are difficult if not impossible to test.

Performance features at a glance:

- New, high-resolution CMOS matrix camera with a 40 mm live image field allows fast scanning with over 120 images per second
- High accuracy for diameter and length measurement
- Measuring speeds of up to 200 mm/s result in extremely fast measuring times
- By using Mahr's MarWin software platform, you can benefit from our decades of experience in length, form, position and contour measurement
- Excellent entry level price into the small optical shaft measuring machine segment



TECHNICAL DATA

Order no.	5361802
Measuring range length (Z) (mm)	250
Measuring range diameter (X) (mm)	40
Length/diameter resolution (mm)	0.01...0.0001
Angle resolution (°)	0.01...0.0001
Length error limit (Z) (µm)	≤ (3.0+I/125) L in mm
Diameter error limit (X) (µm)	≤ (1.5+I/40) L in mm
Lens	Telecentric precision optics High-resolution CMOS camera
Drives	Servo motors
Lens	Telecentric precision optics high-resolution CMOS camera

APPLICATIONS

To measure:

- Length
- Diameter
- Form and position tolerances
- Offsets
- Recess width
- Bevel width
- Intersection points
- Position of intersection points
- Angles of rotation
- Radii
- Position of radii
- Taper lengths
- Angles
- Pitches
- Widths across flats
- Outer threads



For more information, please visit our website: www.mahr.com

MarShaft SCOPE plus

MarShaft SCOPE 350 / 750 / 1000 plus optical shaft measuring systems

DESCRIPTION

- The **MarShaft SCOPE plus** is a universal, fully automatic optical shaft measuring system for testing rotationally symmetrical workpieces.
- The **MarShaft SCOPE plus** has a highly accurate roundness measuring axis (C), a vertical measuring axis (Z) and a horizontal measuring axis (X).
- A tactile measuring system with an inductive measuring probe is available as an option, for measuring radial and axial runout, for example. The measuring device is calibrated to the optical measuring system, so it can perform tactile and optical measuring tasks in combination.
- The new MarWin EasyShaft software provides a high level of flexibility and exceptionally user-friendly operation.
- The measuring sequences are carried out fully automatically, free from operator influences.
- The MarShaft SCOPE plus is suitable for use in both the workshop environment and in the inspection room. Zoom functions allow the smallest details to be measured, which with conventional measuring methods are difficult if not impossible to test.
- Automatic measuring procedure
- Matrix camera, 1280 x 1024 pixels
- User-friendly touchscreen operation
- One measuring instrument for multiple measuring tasks
- Good workshop compatibility
- MarWin EasyShaft software provides a high level of flexibility and user-friendly operation

Options:

- Tactile measuring unit for measuring radial run-out and axial run-out
- Temperature compensation
- Thread measurement
- Turbocharger shaft measurement
- Manual control panel
- Signal lamp
- Barcode scanner
- MarWin Professional Shaft software
- QS-Stat interface



TECHNICAL DATA

Order no.	5361507/5361508/5361516
Measuring range length (Z) (mm)	350 / 750 / 1000
Measuring range diameter (X) (mm)	80 or 120
Workpiece weight (max.) in kg	15 (optional 30)
Length/diameter resolution (mm)	0.01 to 0.0001
Angle resolution (°)	0.01 to 0.0001
Length error limit (Z) (µm)	(2 + L/125) L in mm / (3 + L/125) L in mm (at 20°C ± 1°C on reference standard)
Diameter error limit (X) (µm)	(1.0 + L/125) L in mm / (1,5 + L/125) L in mm (at 20°C ± 1°C on reference standard)
Drives	Servo motors
Lens	Telecentric precision lens high-resolution CCD array

APPLICATIONS

Typical workpieces

- Turned parts
- Tripods
- Transmission shaft
- Rack
- Axle journal
- Hollow shaft
- Drive shaft
- Camshaft
- Turbocharger shafts
- Bone screws
- Worm gears
- Balance shafts
- Hydraulic parts
- Valves (diesel engine)
- and much more



For more information, please visit our website: www.mahr.com

MarShaft SCOPE 600 plus 3D

Optical and tactile measuring system

DESCRIPTION

As a specialist in camshaft applications and more recently (optional) in straight and helical cylinder gears, Mahr now offers a completely new measuring technique with the new MarShaft SCOPE 600 plus 3D measuring station: The combination of optical and tactile sensors enables 3D functionality for the first time and thus a complete inspection of the workpiece in one setup. To this end, Mahr has enhanced its already very successful MarShaft SCOPE 750 plus measuring station. It now has a new 2D probe system, a motorized tailstock and calibration for the linear axes. The matrix camera optically measures features such as diameters, lengths, radii, form, position features, cam angles and the cam pitch in just a few seconds. The additional 2D probe records features that cannot be measured optically: concave cam profile, all standard gear parameters on cylindrical gears, axial runouts, reference elements in an axial direction, such as axial grooves. The tactile and optical system are calibrated in one coordinate system. The measuring station uses the MarWin software platform to deliver complete 3D functionality.



TECHNICAL DATA

Order no.	5361522
Measuring range length (Z) (mm)	600
Measuring range diameter (X) (mm)	120
Workpiece weight (max.) in kg	15
Length/diameter resolution (mm)	0.01 to 0.0001
Angle resolution (°)	0.01 to 0.0001
Length error limit (Z) (µm)	(2 + L/125) L in mm (at 20°C ± 1°C on reference standard)
Diameter error limit (X) (µm)	(1.0 + L/125) L in mm (at 20°C ± 1°C on reference standard)
Drives	Servo motors
Lens	Telecentric precision lens high-resolution CCD array

Performance features at a glance:

- Complete measurement of camshafts, including the cam angle and all standard cam contours
- Measurement of the gears on cylindrical gears
- Measurement of contour elements
- Drive pins not used
- Direct measurement of references (e.g. 2-flat or feather key groove)
- Measurement of feather key grooves
- Measurement of blind holes
- 100% 3D function using new 2D probe
- Additional Y measurement axis
- Special calibration of linear axes (Z-X-Y)
- MarShaft Professional
- Manual control panel

Options:

- Barcode scanner
- Signal light (red, yellow, green)
- Coated tip (no driver required)
- Vibration isolation system
- Temperature compensation
- Thread measurement
- Turbocharger shaft measurement

APPLICATIONS

- Complete measurement of camshafts
- Complete measurement of gear shafts

Typical workpieces

- Camshaft
- Gear shafts
- Eccentric shafts
- Shafts with keyways or blind boreholes



For more information, please visit our website: www.mahr.com

ACCESSORIES

Order no.	Description
5361142	DMC scanner set For MarShaft SCOPE <i>plus</i> (all models), incl. USB cable and holder
5361140	Signal lamp red/yellow/green To display the status of the measuring machine, Red=error, Yellow=measurement/calibration is running, Green=measuring machine is finished/available, incl. control unit for operating the signal lamps
5362502	Standing desk Sturdy, aluminum colored frame, screen consists of perforated plate, plate can be adjusted by tilting, Measurements (W/D/H): 70/50/109-126 cm
5361804	Keyboard with mouse / wireless German
5361805	English
5361806	Spanish
5361807	French
5361808	Hungarian
5361514	Tactile measuring unit with additional y-measuring axis (measuring path 60 mm) Version with 1D dial test probe, two friction clutches provide collision protection, measuring anvil with carbide ball - Ø 2 mm, 90° swivel device enables axial (axial run-out) and radial (roundness and radial run-out) measurements
5361515	Version with 2D form measuring probe (2 coordinates) Measuring range +/- 300 µm, measuring force at 100 µm deflection = 0.2 - 0.3 mN, protected from collision by probe arm magnet holder, default probe arm order no. 5367977 included in delivery, In addition to form and position tolerances, the 2D function also allows the scanning of radial bores, for example. In conjunction with MarShaft Professional, highly precise form measurements are possible.
5367977	Probe arm set default for probe system 1320/2B (MarShaft SCOPE 600/850 <i>plus</i> 3D) Functional length = 72 mm, carbide shaft 16 mm, ruby ball Ø = 2 mm
5367978	Probe arm set camshaft for probe system 1320/2B (MarShaft SCOPE 600/850 <i>plus</i> 3D) Functional lengths: Stylus 1 = 73 mm, stylus 2 = 75 mm, stylus 3 = 95 mm, 3 ruby balls Ø = 2 mm
5367979	Probe arm set FL83 for probe system 1320/2B MarShaft SCOPE 600/850 <i>plus</i> 3D) Functional length = 83 mm, carbide shaft = 25.3 mm, ruby ball Ø = 2 mm
5367980	Probe arm set FL95 for probe system 1320/2B (MarShaft SCOPE 600/850 <i>plus</i> 3D) Functional lengths: Stylus 1 = 75 mm, stylus 2 = 95 mm, 2 ruby balls Ø = 2 mm
5367981	Probe arm set FL72 for probe system 1320/2B (MarShaft SCOPE 600/850 <i>plus</i> 3D) Functional length = 72 mm, carbide shaft = 16 mm, ruby ball Ø = 2 mm
5367982	Probe arm set FL72 for probe system 1320/2B (MarShaft SCOPE 600/850 <i>plus</i> 3D) Functional length = 72 mm, carbide shaft = 12 mm, ruby ball Ø = 1 mm

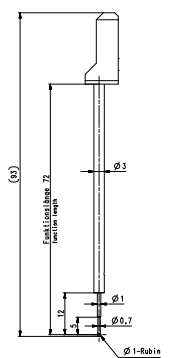
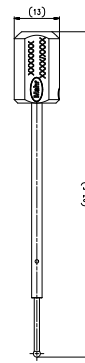
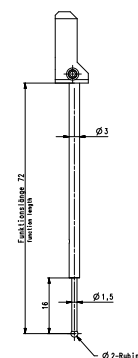
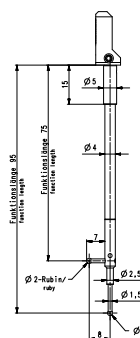
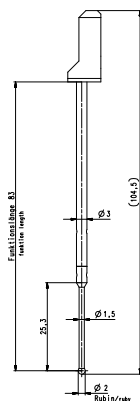
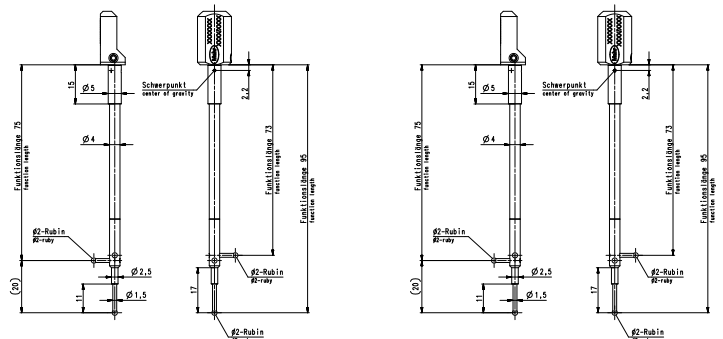

ACCESSORIES

Order no.	Description
5361513	Manual control panel MarShaft SCOPE 350/750/1000 (MarShaft SCOPE 650 <i>plus</i> 3D series) The MarShaft Scope <i>plus</i> can also be operated using a manual control panel. The manual control panel consists of a keypad with 14 keys for controlling the machine axes, quick program start keys, an emergency stop key and a release key.
5361552	Temperature compensation for MarShaft SCOPE 350/750/1000 Temperature compensation is an approximate way of correcting temperature-based measurement errors. The process compensates firstly for deviations in the measuring machine and calibration elements and secondly for length expansion in the testpiece. Temperature sensors that record the machine temperature are located at important machine positions. The control software corrects the measuring machine to a reference temperature. A separate temperature sensor is available for measuring the temperature of the testpiece.
5361112	Centering tip 60° Ø 2-15 mm, (height = 35 mm (lower end face to the upper edge of the tip) 2 units included in delivery of the MarShaft SCOPE 250 <i>plus</i>
5361223	centering tip 60° Ø 2-44 mm, height = 46 mm, (lower end face to upper edge of the tip) 2 units included in the scope of delivery of the MarShaft Scope 350/600/750/1000 <i>plus</i>
5361105	Centering tip 60° Ø 3-15 mm, height = 25 mm, (lower end face to upper edge of the tip)
5361106	Centering tip 60° Ø 2-35 mm, height = 44 mm, (lower end face to upper edge of the tip)
9056631	Centering tip 60° Ø 2-19 mm, height = 46 mm, (lower end face to upper edge of the tip), Carbidor coated (from Ø 36 mm)
9052904	Centering tip 60° Ø 2-35 mm, height = 46 mm, calibration collar, Carbidor coated, height = 56 mm (lower end face to upper edge of the tip), Carbidor coated (from Ø 36 mm), factory calibration of the calibration collar on request
5361107	Centering tip 120° Ø 8-40 mm
5361104	Centering tip 90° Ø 6-20 mm
5360539	Calibrating shaft for MarShaft SCOPE 250 <i>plus</i> Ø 5 - Ø 45 mm, length = 250 mm, diameter graduation: 5 mm, 16 lengths from 5 mm to 185.5 mm, 1 width across flats 8 mm, incl. DAkkS - calibration certificate, wooden case, delivery does not include measuring program
5360532	Calibrating shaft for MarShaft SCOPE 350 <i>plus</i> Ø 25 - 110 mm, length = 300 mm, graduation of the diameter: 25 mm, 40 mm, 60 mm, 80 mm, 110 mm, graduation of the lengths: 37 mm, 52 mm, 86 mm, 101 mm, 165 mm, 238 mm, 266 mm, 280 mm, 300 mm incl. DAkkS certificate, wooden case, scope of delivery does not include measuring program
5360531	Calibrating shaft for MarShaft SCOPE 600/750/850/1000 <i>plus</i> Ø 25 - 110 mm, length = 583 mm, graduation of diameter: 25 mm, 40 mm, 60 mm, 80 mm, 110 mm, graduation of the lengths: 37 mm, 52 mm, 112 mm, 127 mm, 165 mm, 201 mm, 216 mm, 312 mm, 419 mm, 521 mm, 549 mm, 563 mm, 583 mm, DAkkS certificate, wooden case, delivery without measuring program

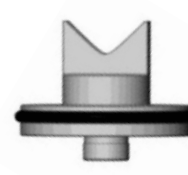
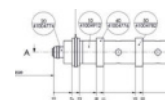
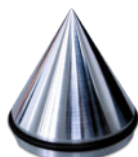

MarShaft Software EasyShaft

DESCRIPTION

- **MarWin EasyShaft software** is the measuring, control and evaluation system for the MarShaft SCOPE plus. It offers precision measurement of diameters, lengths, contour features and form and position tolerances in accordance with standards, along with many new evaluation and documentation options, all with a well-laid-out, intuitive user interface.
- The software runs entirely under the familiar Windows® operating system. The user interface is compatible with other Windows applications, reducing the familiarization time substantially. All Windows-compatible printers can be used for record output.

Performance features at a glance:

The familiar Windows user interface makes for a short learning curve

- The user interface is used as standard across all Mahr products (e.g. EasyForm or Contour 1)
- Clear, windows-based layout
- User-friendly, 100% touchscreen functionality
- Predefined macros for easy programming (e.g. diameter measurement at a mouse click)
- Many functions can be selected directly via obvious icons
- Touchscreen-controllable machine axes
- The live image from the matrix camera is permanently displayed during measurement, i.e. direct visual assessment of the workpiece condition (e.g. soiling) even during measurement
- For individual and serial measurements: the ideal operating strategy for every task
- User-friendly, state-of-the-art measuring program management
- Time-optimized measuring program sequence (shortest measuring times)
- Meaningful measuring records – in black-and-white or color – output to all Windows® printers
- Future-proof investment, runs under Windows 10
- Optional data export to statistics programs extends the range of functions of the EasyShaft software

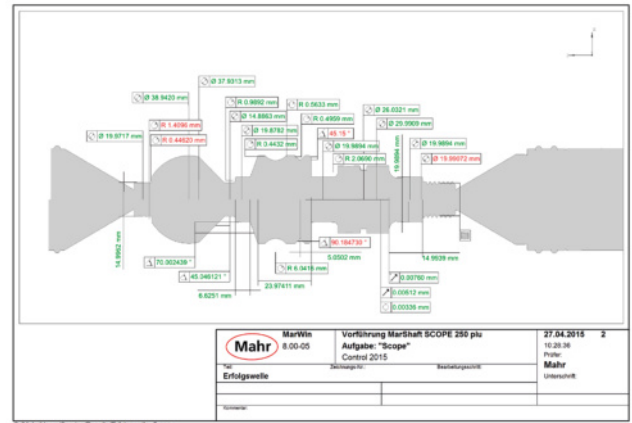
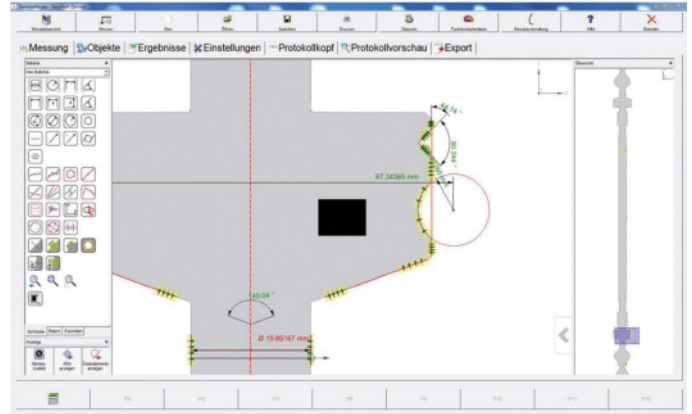

For more information, please visit our website: www.mahr.com

OPTIONS

EasyShaft program window

- The EasyShaft software gives you full control over the MarShaft SCOPE. The touchscreen gives you direct access to positioning, programming, measurement and documentation. The excellent, simple user interface helps you keep track of everything you need to know.
- Many functions, such as loading measuring results or adding feature measurements, can be selected simply by clicking an icon.

EasyShaft commands

- The clearly laid-out command bar contains all the commands required for measuring and evaluating features.
- Macros (composed sequences of evaluation actions, e.g. diameter, radius, distance or angle)
- Features which can be calculated (e.g. direct distance, distance in X and Z, angle, angle sector, radius, roundness, straightness, radial run-out, axial run-out, cylindricity, symmetry)
- Substitute elements which can be calculated (e.g. point, line, circle, point on straight line, intersection point, symmetry straight line, parallel straight line, extreme point, C-reference)

Display palette (touchscreen control of machine axes)

- Used to show or hide the display palette
- Used to select the zoom range
- Joystick for the C-axis
- Joystick for the X- and Z-axis
- Zoom in incrementally
- Zoom in or out continuously
- Zoom out incrementally

The screenshot shows the EasyShaft software interface. At the top, it displays 'MarWin 6.00.05', 'Verföhrung MarShaft SCOPE 200 ju', 'Aufgabe: "Scope"', 'Control 2015', and the date '27.04.2015'. Below this is a table with columns for 'Ergebnisse' and 'Messung'. The table contains multiple rows of data, including feature names like 'Mahr_1', 'Mahr_2', 'Mahr_3', etc., and their corresponding measurement values. The interface is designed for touchscreen control, with various icons and data points visible.



For more information, please visit our website: www.mahr.com

Engineered Solutions | Customer-specific metrology

As modern production techniques develop, bringing with them growing demands in terms of flexibility and quality, conventional metrology faces new challenges. With Engineered Solutions, Mahr can offer you tailor-made solutions that take account of specific environmental conditions and requirements relating to handling, reliability and speed. Measuring solutions that are as individual as your measuring task: For us your requirements are the benchmark.

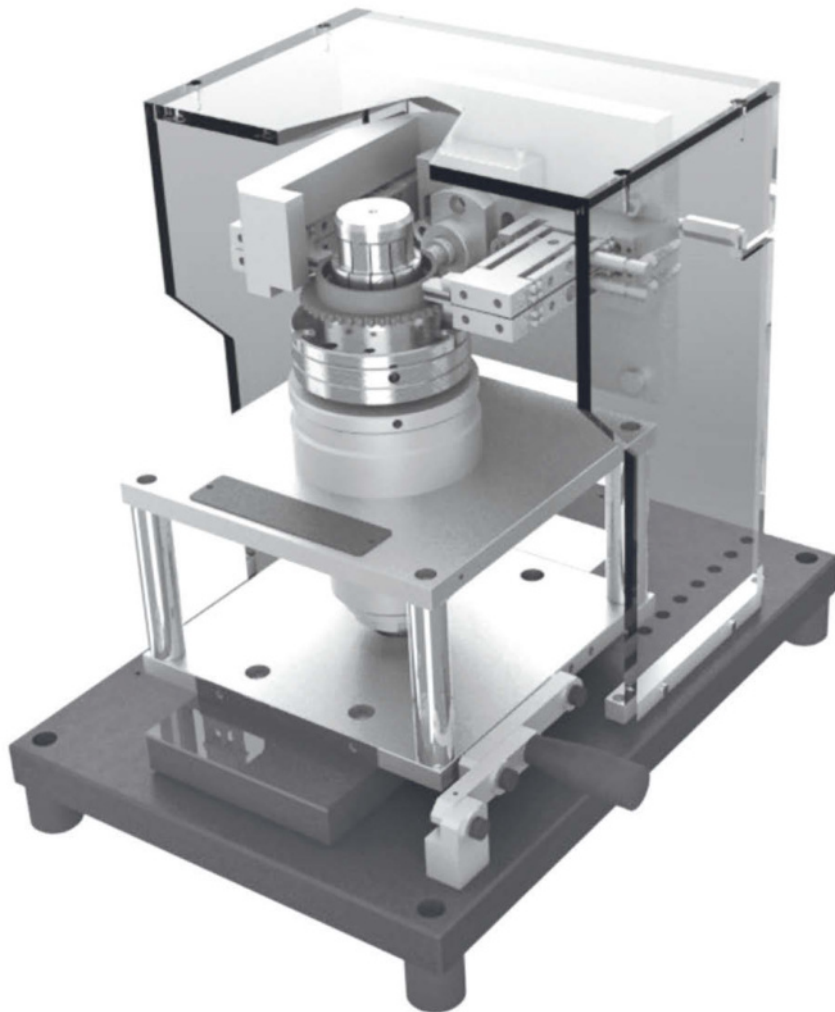

Engineered Solutions Customized measuring stations	640
Engineered Solutions Dimensional solutions	641
Engineered Solutions Contour and surface solutions	642
Engineered Solutions Automated solutions	643
Engineered Solutions MarSurf Engineered	644



The latest information about Engineered Solutions can be found on our website:
www.mahr.com

Customized measuring stations

Complex measuring tasks, striving for maximum efficiency, prompt measuring results on site or the desire for maximum ease of use sometimes require solutions that have been individually designed with these requirements in mind. With Engineered Solutions, Mahr consolidates its extensive product expertise to design tailor-made measuring stations for customers around the world.

We are typically required to:

- Measure directly in production
- Come up with measurements that are easy for on-site personnel to carry out
- Provide measuring results within a few seconds
- Reliably complete complex and demanding measuring tasks
- Simplify measuring tasks that occur on a daily basis
- Have 100% inline control – solutions for integration in the production line
- Have measuring results that can be documented and traced

What challenge are you facing?

There are many reasons why an individual measuring solution may be required. There is generally one problem that cannot be solved at all or is very labor-intensive to solve with the usual standard measuring machines. We solve that problem.

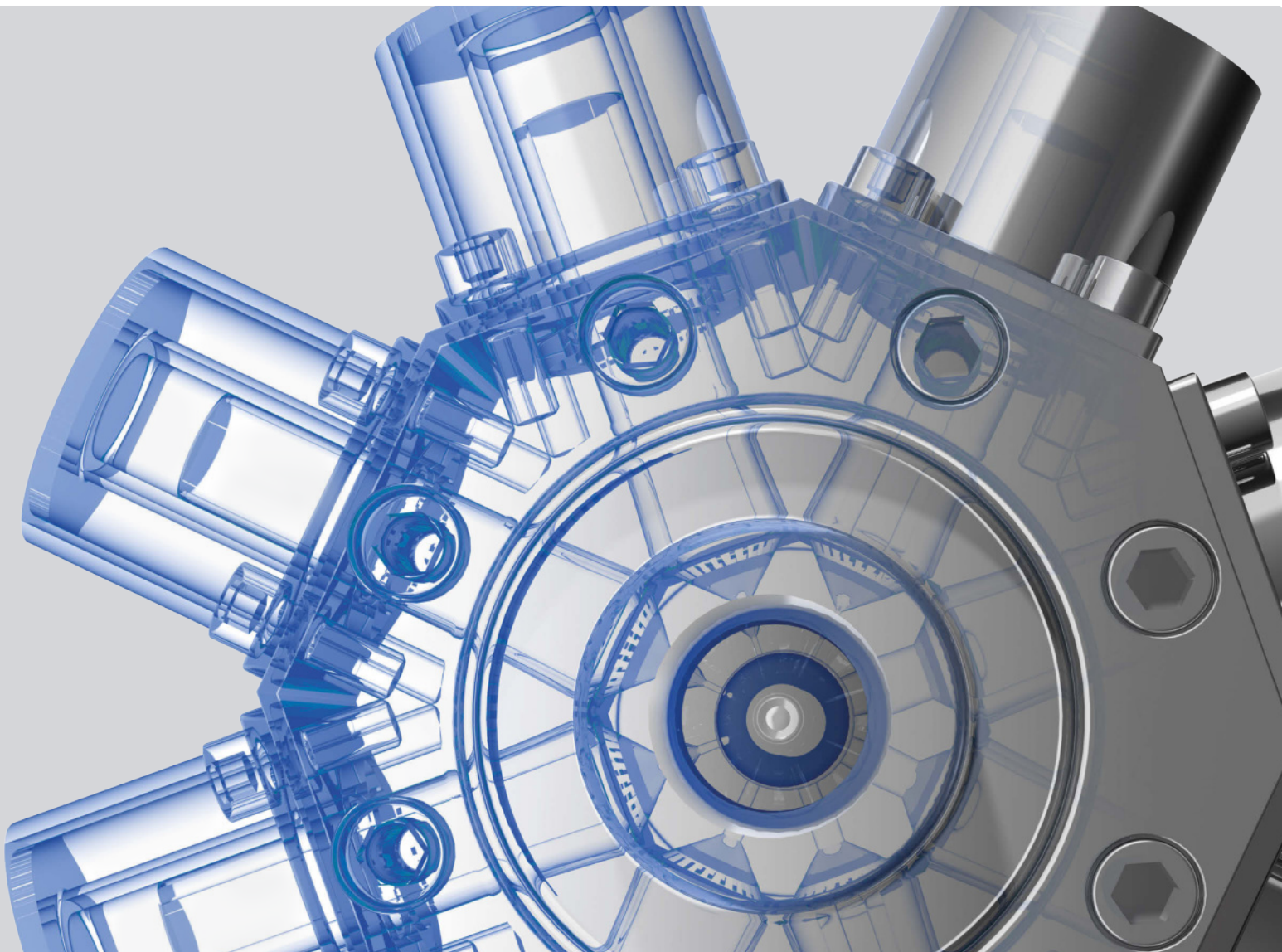

Clever measuring devices, excellent results

Dimensional solutions from Mahr Engineered Solutions



Manual solutions

Manual loading and measurement

- Measure directly in production
- Easy to handle
- Measuring result is available within a few seconds
- Reliable and safe measurements carried out by workshop personnel



Semi-automatic solutions

Manual loading and fully automatic measurement

- Dynamic measurements
- Complex measuring tasks
- Increased efficiency through automation of measuring sequences



Fully automatic machines

Fully automatic inline measurements

- Measuring cell for integration in the production line
- Automatic workpiece recognition and measuring program selection
- Workpiece feeding and alignment
- Workpiece classification



OEM solutions

Measuring modules for inline integration

- Integration of measuring heads in production and assembly lines
- Cooperation with integrators according to customer requirements
- Simple connection and integration
- High-precision metrology from the expert as part of a complete system

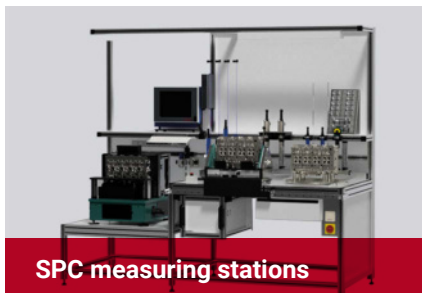

SPC measuring stations

Turnkey solutions for different measuring tasks

- Complete SPC measuring stations with a wide variety of measuring equipment for handling all pending measuring tasks in a manufacturing process
- Complete metrological equipment for production lines and/or workshops

Radius, angle, roughness – or chamfer?

Contour and surface solutions from Mahr Engineered Solutions



Manual auxiliary devices

Quick and easy help in your everyday work

- Elimination of time-consuming setup and alignment of workpieces
- Easy measurement of complex or difficult measuring tasks
- Error reduction through avoidance of incorrect operation



Mobile solutions

The measuring equipment comes to the workpiece

- Measurement directly at the production site
- Measurement directly in the production line, without ejection of the workpiece
- Surface measuring task as part of an SPC measuring station



Manual measuring stations

Positioning and recurring measuring tasks made easy

- Targeted and easy processing of individual measuring tasks
- Easy handling of large and heavy workpieces
- Efficiently process recurring measuring tasks, e.g. work sequence plans

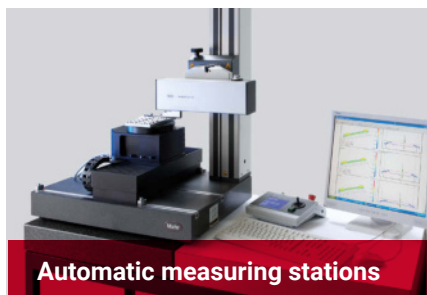

Automatic measuring stations

Automated measuring sequences without tying up personnel

- No operator influence on measuring results
- No staff need to be involved during measurement
- Automation and high-precision metrology combined across the entire measurement circuit



Fully autonomous measuring stations

Insert workpiece, start measurement and get result

- Fully autonomous inline processing of numerous and complex measuring tasks without staff involvement
- All-in-one measuring station: Automatic workpiece recognition and selection of measuring program, probe arm, etc.

Stand-alone machines – automated solutions



Autonomous measuring stations

Measurement without staff involvement

- Fully autonomous processing of multiple and complex measuring tasks
- Combination of several measuring sensors into one measuring station
- Automated measuring room
- Operation without metrology personnel

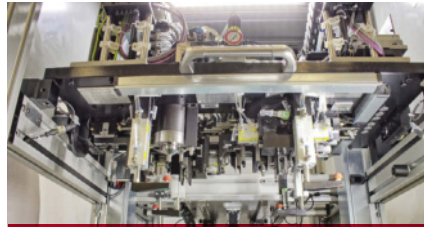

Inline solutions

Measuring stations for integration

- Complete measuring stations with workpiece feeding and output
- Automated workpiece handling in the measuring station
- Automatic workpiece recognition and measuring program selection
- Fully automatic measurement



Complete inline solutions

Measuring stations with peripherals

- Workpiece feeding and alignment
- Workpiece classification
- Laser marking of the workpiece
- Bulk material feeder
- Inspection tasks such as crack detection

For more information,
please visit our website

info-engineered@mahr.com



MarSurf Engineered – customized solutions

Starting with individual workpiece holders right down to fully automatic measuring stations, Engineered Solutions in the MarSurf sector make it possible to simplify surface measurement. Depending on customer requirements, the existing solution portfolio may be used or a new, customized design developed.

Mobile solutions

The measuring equipment comes to the workpiece

- Measure large and heavy workpieces directly at the production site
- Measurement in the production line, without ejection of the workpiece
- Surface measuring task as part of an SPC measuring station



Manual measuring stations

Positioning and recurring measuring tasks made easy

- Targeted & easy processing of individual measuring tasks
- Easy handling of large and heavy workpieces
- Efficiently process recurring measuring tasks, e.g. work sequence plans



The measuring stations displayed are a small selection of previously planned solutions. More information about Engineered Solutions at www.mahr.com

Automatic measuring stations

Automated measuring sequences without tying up personnel

- No operator influence on measuring results
- No staff need to be involved during measurement, which leads to increased efficiency and cost savings
- Automation and highly accurate metrology combined across the entire measurement circuit



Fully autonomous measuring stations

Insert workpiece, start measurement and get result

- Fully autonomous processing of numerous & complex measuring tasks without staff involvement
- Increased efficiency and cost reduction thanks to automatic workpiece recognition, easy selection of measuring programs etc.
- High-quality design for 24/7 operation in production
- Operation by workshop personnel



The right software for the machine

MarSurf Engineered measuring stations use specially developed, intelligent software solutions

- Measuring program creation targets the features to be measured
- No programming knowledge required
- Process-optimized measuring programs
- Simple duplication of measuring programs on structurally identical machines

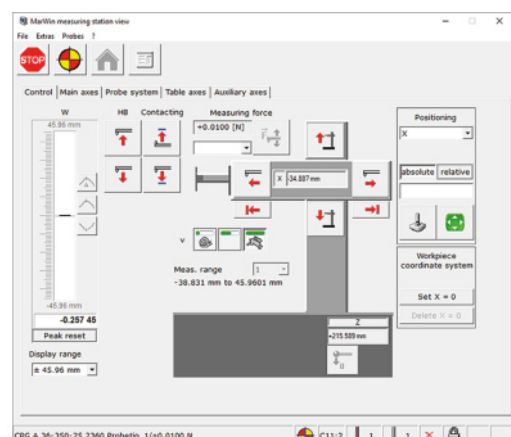

Mahr | Service

Mahr offers a worldwide service network, through its many branches and agencies. In addition to product-related services, we have additional resources available from some of our sites. Mahr is happy to help with any of your metrology questions, no matter how specific. Just ask us!



Mahr Academy	648
Application advice	648
Technical service	649
Service agreements	649
Measuring system calibration services	650
Handheld measuring tool calibration logistics	651
Gage management	652
Repair or exchange	653
Order and subcontract measurement	654
Capability testing	655



The latest information about the MAHR SERVICE CENTER is available on our website:
www.mahr.com



In addition to product training, the Mahr Academy also provides technical content. We not only offer training and courses in metrology, but also in test equipment and quality inspection. Our instructors are one hundred percent in the subject and know from their own experience what it's all about.

Our topics are:

- Quality and test equipment management
- Practical application of production measurement technology
- New standards DIN / ISO / GPS
- AUKOM courses (AUKOM Level 1 - 3, AUKOM Measurement Technician, AUKOM Update, AUKOM Form and Position, AUKOM Management Workshop)
- Webinars and eLearnings

Practical relevance

Experience shows: Practice demands practice! That is why practical application is the focus of every Mahr offer.

Teamwork

Learning is effective in a group. Here you can exchange ideas and benefit from the experiences of the other participants.

Small groups

Due to small groups at our seminars, everyone gets a chance to speak and all questions are answered.

On site and online

All seminars can be booked on-site, online or as hybrid events – so you retain full flexibility.



Do you need help with designing solutions for metrological tasks? Do you need to create measuring programs for complex workpieces? Do your users need some basic product training?

Take advantage of the services offered by our application engineering specialists, with their extensive knowledge and many years of experience in dimensional metrology.

Our application engineering and technical service specialists also offer:

- Sample measurements
- Help with commissioning equipment
- Program creation
- Product training
- Measuring equipment capability testing
- User training

For more information, please visit our website: www.mahr.com

Technical service



Mahr quality guidelines set high standards in which **Mahr measuring instruments** are developed and manufactured, using the very latest technology available. This guarantees that consistently, all **Mahr measuring instruments** are of the highest quality.

To assure that your machine/measuring station receives the best possible care, Mahr operates an efficient worldwide service organization. The **Mahr Service Organization**, run by trained specialists, is equipped with cutting edge tools and instruments, many of which have been specially developed, and stocks an extensive range of spare parts.

Mahr works according to progressive, tried-and-tested guidelines and offers a range of complementary services. To ensure the best results from your **Mahr measuring equipment** at all times, we recommend you use only the services offered by the **Mahr Service Organization**. This is the only way of ensuring that only **original Mahr spare parts** and servicing procedures are used, reflecting the stringent **Mahr quality standard**.



You will find the right contact for your service request under:

www.metrology.mahr.com/en-int/service/mahr-service/service-contacts

Service agreements

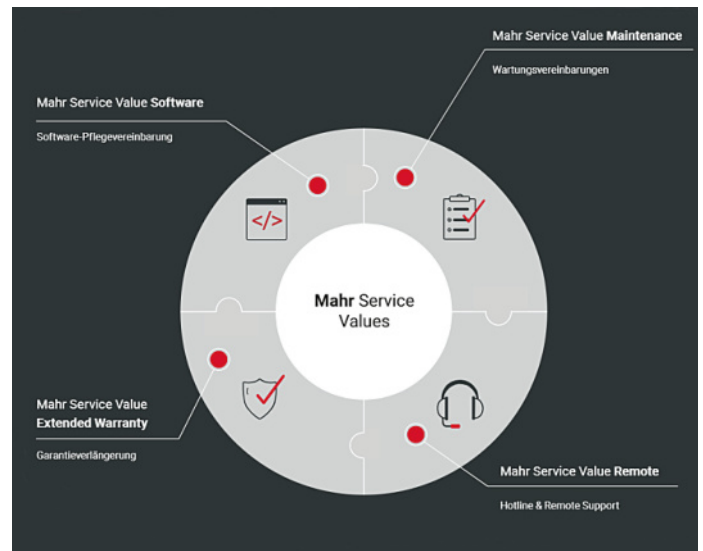

Our service agreements – packages with added value. Whether it's day-to-day business or an exceptional situation: when you call on our service, you want speedy, competent support – without having to worry about the costs. That's exactly what Mahr Service Values are for: our agreements for maintenance, software support, warranty extensions as well as hotline and remote support.

Conveniently secure the right service for your needs with Mahr Service Values - and retain full control over your budget. Depending on the package, we also guarantee you shorter response times or prioritized appointments. You can also put together your own individual service package according to the modular principle. Try it out!

Measuring system calibration services

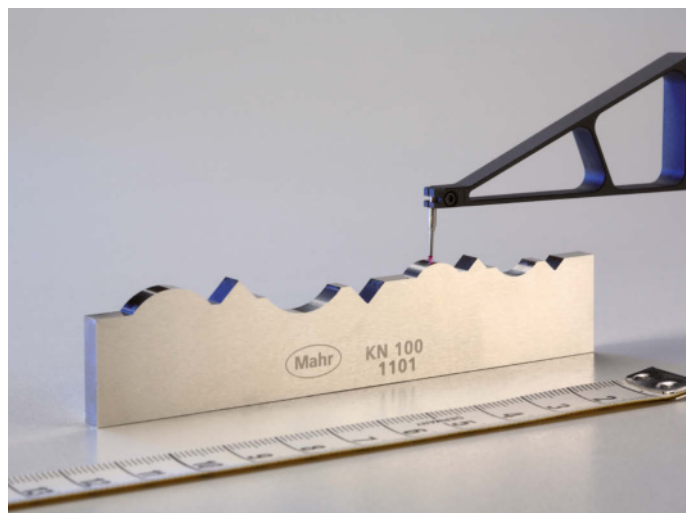

Mahr runs laboratories for various instruments and instrument sizes in the field of length metrology. These laboratories ensure high dimensional accuracy and very low measurement uncertainties. In principle, all measuring equipment can be calibrated. Specific core competencies are available for the following calibration services:

- Gage calibration (length) *
- Parallel gage blocks *
- Setting rings / setting plug gages / setting disks / pin gages *
- Geometry and roughness standards *
- Optical flats
- Inductive probes with/without display unit *
- Thread plug gages / thread ring gages *
- Incremental probes *
- Vertical length measuring devices / height measuring units *
- Calipers / outside micrometers *
- Dial gages / dial comparators / dial test indicators *
- Setting standards *
- Magnification standards (flicks) *
- Contour standards *
- Stylus instruments / roughness and contour measuring instruments *
- Testing cylinders / cylinder squares *
- Roundness standards *
- Length measuring devices *
- Multi-shaft standards *
- Dial comparator and dial gage testers *
- Super-fine roughness standards *
- Custom objects on request
- Depth measurement standards *

* Calibrations with officially recognized calibration certificates according to national and international standards, e.g. DAkkS/DKD (German Calibration Service).

DAkkS (German Calibration Service) is a signatory of the multilateral agreement by the European cooperation for Accreditation (EA) and the International Laboratory Accreditation Cooperation (ILAC) concerning the mutual recognition of calibration certificates.

Your Mahr contact will provide you with information on national and international recognition, e.g., as part of the multilateral agreements www.european-accreditation.org and www.ilac.org



Deutsche
Akkreditierungsstelle
D-K-15074-01-00



For more information, please visit our website: www.mahr.com

Handheld measuring tool calibration

Would you like to have your handheld measuring equipment calibrated by **Mahr**?

Mahr offers calibration also for **non-Mahr products**.



All manufacturers and brands

Our laboratories are accredited and work independently of manufacturers. The following applies to hand-held measuring instruments: No matter what brand your measuring equipment is, we calibrate it – for service from one source.



For more information, please visit our website: www.mahr.com

Gage management

Are you looking to cut your annual calibration costs and to optimize processes for managing and maintaining your gages? Our Service team can help! And that's not all. With the latest Mahr software you can reduce the time you spend on gage management by up to 70%.

Mahr can optimize your gage inventories

Gage management tends to be organized on an individual basis, with companies having very specific requirements. That is why we analyze your needs in detail and work with you to establish the right solutions. Services we can offer in this area include the following:

Record gage inventories

- Help with recording gages, measuring equipment and other tools
- Categorizing into gages and tools
- Defining appropriate inspection intervals

Manage gage inventories

- Organizing simple internal procedures for calibrating, servicing and maintaining gage inventories
- Software solution for gage management
- Measuring instruments and software solution for in-house calibration
- Logistics solutions (e.g., collection service)
- Staff training

Optimizing gage inventories

- **Selecting suitable gages**
- Evaluating and improving test processes
- "Decluttering" gage inventories

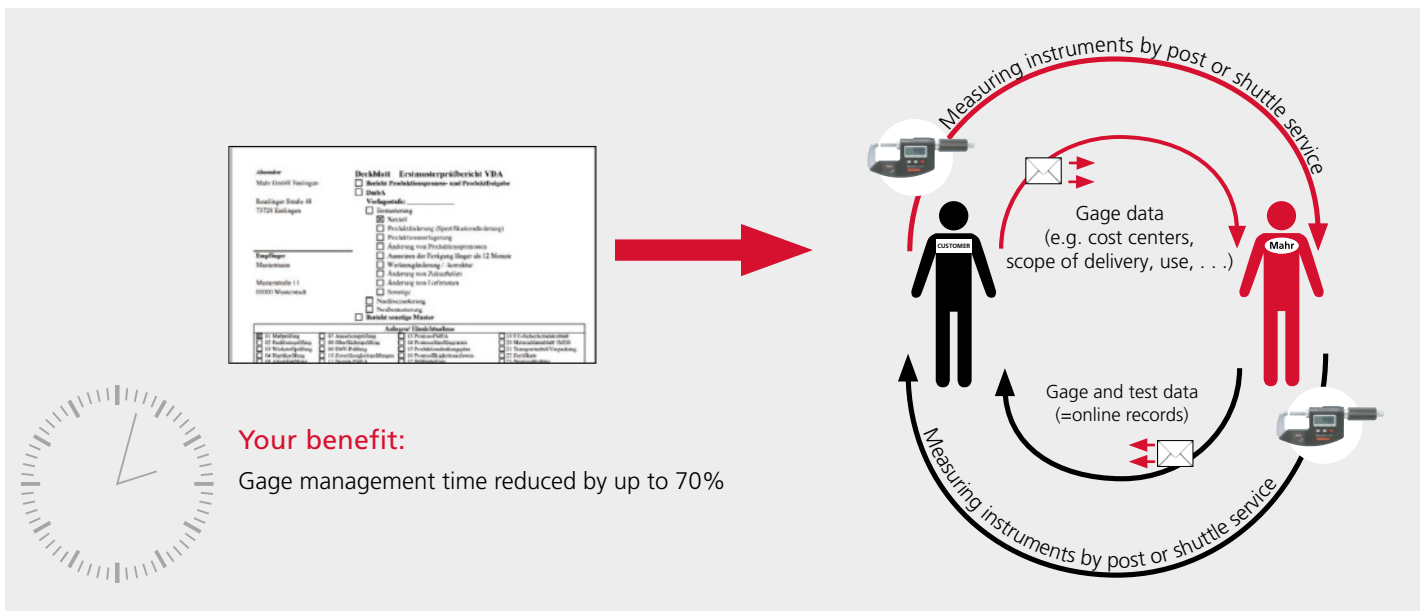

For more information, please visit our website: www.mahr.com

Repair or exchange

Replacement and rental service

Replace instead of repair - this is a simple solution for lots of measuring equipment and small devices. You receive a refurbished device or a corresponding component as a replacement for the defective technology quickly and easily. In this way you can keep downtimes to a minimum and get a 12-month warranty on the replacement unit.

Refurbished equipment & components as replacements (examples):

- Outside micrometers and digital calipers
- Indicating measuring instruments from the Marameter product group
- Mobile roughness measuring instruments, e.g. MarSurf PS 10 or MarSurf M 300
- Surface drive units and probe systems
- Probe arms for surface and form measurement

The choice is yours:

Exchange (Mahr instruments)

If you send in your faulty device you will receive in return a refurbished instrument from our exchange pool, repainted if necessary. We will also engrave your ID number on it if you wish.

Your benefit: Your downtime is kept to a minimum.

Repair

Of course you can also have your own device repaired. When we repair an instrument we fix any functional defects, rework the measuring surfaces and put right any cosmetic damage. The cost of replacement parts is already included in the repair price in this case too.

Your benefit: Thanks to our expertise as the original manufacturer, you have the certainty that after being repaired, your instrument will have the same specification and accuracy as a new unit.

Repair regardless of manufacturer

We can repair leading brands of length measuring instruments.

Your benefit: You have just one contact for all your instrument repairs

Refurbishment (Mahr instruments)

With refurbished instruments we not only fix any faults but also replace worn-out wear parts as a precaution and put right any cosmetic damage. This restores the instrument's metrological capabilities to those of a new device.

Your benefit: When your instrument is returned, its metrological capabilities are equivalent to those of a new device.

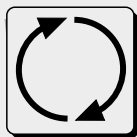

EXCHANGE

Delivery time: approximately 3 working days



REPAIR

Delivery time: depends on instrument

For more information, please visit our website: www.mahr.com

Subcontract measurement services from Mahr

Subcontract measurement and capability testing:

We measure what your measuring devices cannot.

Your benefit: You save money by not having to purchase expensive new equipment.

We help when your measuring capacities are overloaded.

Your benefit: You avoid the need for additional staff and machines.

We test the capability of your measuring systems and the suitability of your equipment for your applications.

Your benefit: When tolerances are tight, you can be sure you are using the right equipment.

Mahr offers the following subcontract measurement services:

1. Measurements on 3D coordinate measuring machines by one of the following methods:
 - a) tactile,
 - b) optical (non-contact), or
 - c) by 3D laser scanning
2. Form and position measurements
3. Roughness and surface
4. Contour measurement
5. Initial sample inspection according to the regulations of the Association of the German Automotive Industry (VDA) and other regulations

Measuring records

After sample inspection of your workpiece you will receive a professional measuring record from us, to which you can refer if any inspections should be required (e.g., in the event of production errors).

Digitization

We can also take care of digitization tasks for you, i.e., we can create CAD data sets to be read into production machines. In reverse engineering procedures, 3D laser scanners generate an exact map of a workpiece in the form of high-resolution point clouds. These point clouds then form the basis for the CAD data set that is created from it.

For more information, please visit our website: www.mahr.com

Capability testing

Mahr tests the capability of your measuring systems:

Are your measuring machines and measuring equipment accurate enough to meet the constantly increasing demands in relation to tolerated deviation?

When workpiece tolerance demands are high, measuring systems are often operating at the limit of their capabilities. Mahr can check whether your measuring machines and equipment are suitable for the tasks at hand. There are two possible methods of capability testing. The effects of various factors which lead to inaccurate measuring results can be more precisely limited in this way.

Method 1:

This method determines the general capabilities of the devices. This is usually carried out in our laboratory, but in exceptional cases it can also be done in your measuring room.

Method 2:

This method determines the influence of the operator on the measuring results. Here we test the devices at your premises under normal operating conditions. We also involve the staff who will be working with the devices later on. As with calibration, a certificate and/or record is issued after the capabilities of the measuring systems have been determined.

Method 3:

Here the test is carried out using automatic measuring equipment. The aim is to exclude the operator influence that is intentionally assessed with method 2. This method is usually carried out on 25 workpieces in two test cycles.

We can conduct these procedures either at our premises as a pre-inspection or at your site in the form of a final inspection. In this way you can be sure of achieving a high level of measuring accuracy on your own premises too. The specified measuring conditions must of course be adhered to.

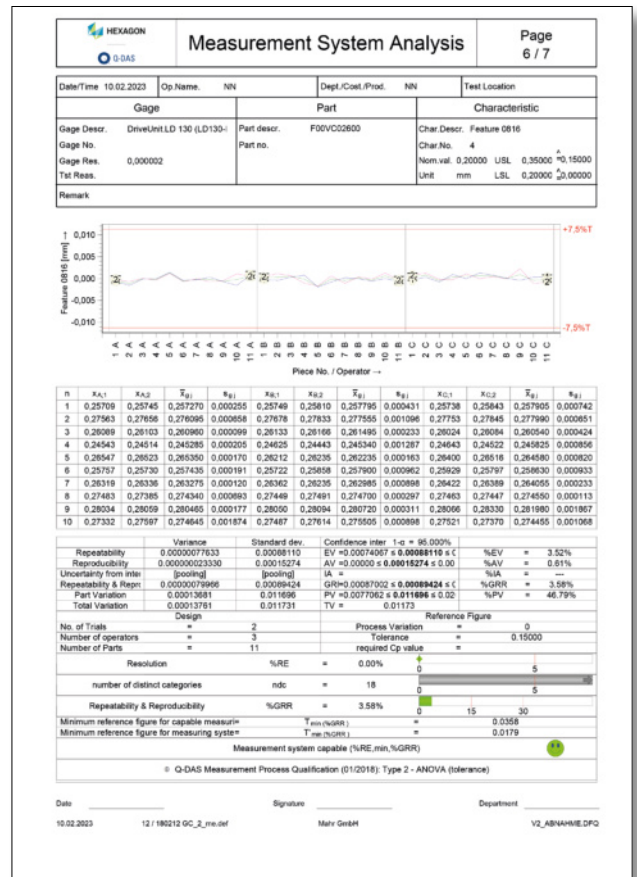

For more information, please visit our website: www.mahr.com

Mahr | Numerical Index

Instrument	Page	Instrument	Page	Instrument	Page
1000 A	209	16 EWR-SM	47	26I	170
1000 B	209	16 EWR-V	38	26IM-RC	170
1002	206	16 EWR-VS	48	26K	168
1002 T	206	16 EWRI	24	26K-RC	168
1002 Z	211	16 EWRI-AA	51	26Q	168
1002 ZT	211	16 EWRI-AI	53	26Q-RC	168
1003	206, 208	16 EWRI-AR	44	27I	168
1003 T	206	16 EWRI-BA	49	27I-RC	168
1003 XL	207	16 EWRI-C	42	27O	168
1003 XLT	207	16 EWRI-H	43	27O-RC	168
1003 Z	211	16 EWRI-LI	55	28IM	170
1003 ZT	211	16 EWRI-NA	45	28IM-RC	170
1004	207	16 EWRI-RW	54	28IN	168
1004 T	207	16 EWRI-S	46	28IN-RC	168
1004 Z	211	16 EWRI-SA	50	28IQN	176
1004 ZT	211	16 EWRI-SI	52	28ISN	176
1010	210	16 EWRI-SM	47	29I	176
1010 T	210	16 EWRI-V	36	30 EWR	56
1010 Z	211	16 EWRI-VS	48	30 EWR-D	58
1010 ZT	211	16 EWd	17	30 EWR-N	59
107 G	284–286	16 EXr	16	30 EWRI	56–57
1075 R	132	16 EXu	15	30 EWRI-D	58
1086 R	136–137	16 FN	30	30 EWRI-N	59
1086 R-HR	139	16 GN	30	300P-1	305
1086 Ri	133–134	16 U	29	300P-1M	306
1086 WR	138	18 ESA	34	300P-2	305
1086 WRi	135	18 EWR	33	300P-2M	306
1086 ZR	136	18 EWR-V	40	300P-3	305
1087 BR	144	18 EWRI	32	300P-3M	306
1087 BRi	143	18 NA	35	300P-4	305
1087 R	141	2000 USB	83	300P-4M	306
1087 R-HR	142		15	300P-5	305
1087 Ri	140	2000 W	188	300P-5M	306
109 P	579	2000 Wi	188	300P-6	305
109 PS	579	2000 d	17	300P-6M	306
109 Pst	579	2000 r	16	300P-7	305
12I	164	2001 W	190	300P-7M	306
12I-RC	164	2001 Wi	190, 192	300P-8	305
12Q	164	220 Set 2/1	578	300P-9	305
12Q-RC	164	220 Set 2/2	578	301 P	313
1301	248	220 Set 2/3	578	301P-1	312
1303	248	22I	168	301P-2	312
1304 K	249	22IN-RC	168	301P-3	312
130B-16	493	22P-10M	322	301P-4	312
130B-24	493	22P-11	321	301P-5	312
1318	250	22P-15	321	301P-6	312
1340	251	22P-15M	322	301P-7	312
16 DN	31	22P-20	321	301P-8	312
16 ER	27–28	22P-20M	322	301P-9	312
16 ESv	16	22QN	168	32I	172
16 EWR	25–26	22QN-RC	168	32I-RC	172
16 EWR-AA	51	23I	170	32Q	172
16 EWR-AI	53	23IM-RC	170	32Q-RC	172
16 EWR-AR	44	23K	168	355 E	467–469
16 EWR-BA	49	23K-RC	168	36B-10	435
16 EWR-C	42	23Q	168	36B-10-VT	436
16 EWR-H	43	23Q-RC	168	36B-19	438
16 EWR-LI	55	23W	168	36B-19M	439
16 EWR-NA	45	23W-RC	168	36B-20	435
16 EWR-RW	54	25 EWR	411	36B-20-VT	436
16 EWR-S	46	25 EWRI	411	36B-9	438
16 EWR-SA	50	25M	168	36B-9M	439
16 EWR-SI	52	25M-RC	168	390	470–471

Mahr | Numerical Index

Instrument	Page	Instrument	Page	Instrument	Page
40 A	70	44 EWR	92, 94	810 S	146
40 ER	66	44 EWg	98	810 SB	151
40 EWR	65, 67	44 F	88	810 SM	147
40 EWR-B	83	45 T	101	810 SRM	147
40 EWR-K	87	57B-11	330	810 SV	146
40 EWR-L	69	57B-11M	331	810 SW	149
40 EWR-R	85	57B-12	330	814 G	487
40 EWR-S	81	57B-12M	331	814 N	485
40 EWR-V	75, 77-78	57B-13	327	814 SR	489
40 EWRI	64	57B-13M	328	815 GN	270
40 EWRI-B	82	57B-14	324	815 MA	271
40 EWRI-K	86	57B-14M	325	815 MB	272
40 EWRI-L	68	57B-15	324	815 MF	275
40 EWRI-R	84	57B-15M	325	815 MG	274
40 EWRI-S	80	6105 N	263	815 P	273
40 EWRI-V	74, 76	6107 S	264	815 XMA	276
40 F	71	6400	265	815 XMB	276
40 FC	71	800 EW	119	815 XMS 285	276
40 SA	70	800 EWL	119	815 XMS 485	276
40 T	72	800 EW _r	16	815 XN	276
40 TS	73	800 EW _u	15	815 XP	276
400B-3	181	800 H	118	816 CL	477
400B-4	181	800 S	106	817 CLT	476
402	442	800 SA	106	817 USB	15
402 C	448	800 SG	106	818	287
404	442	800 SGA	106	818 P	288
404 C	448	800 SGB	107	818 R	289
405	443	800 SGE	109	820 FC	278
405 C	449	800 SGL	107	820 FG	279
406	443	800 SGM	108	820 N	277
406 C	449	800 SL	107	820 NC	278
408	444	800 SM	108	820 NG	279
408 C	450	800 SR	106	821 FG	280
409	444	800 SRM	108	821 NG	280
409 C	450	800 V	114	824 FT	281
411	447	800 VGM	115	824 GT	281
412	446	801 S	111	826 PC	492
413	446	801 S1	111	827 b 14	282
415	447	801 SG	111	827 b 16	282
417 C/0	456	801 SGE	110	827 b 17	282
417 C/1	457	801 SGI	111	827 b 18	282
417 C/2	458	801 SGL	112	827 b 19	282
417/0	453	801 SGM	110	827 b 31	283
417/1	454	801 SL	112	827 b 32	283
417/2	455	801 SM	110	827 b 33	283
418 C	451	801 SR	111	827 b 34	283
419 C	452	801 SRM	110	827 b 35	283
420	459	801 V	117	827 b 36	283
421	461	801 VGM	116	827 b 5	282
421 P	462	802 EW	126	837	161
421 PS	463	802 NW	127	838 EA	334
424	460	803 A	145	838 EI	337
426 A	464	803 AZ	150	838 TA	333
426 M	465	803 S	145	838 TAZ	332
426 MS	466	803 SB	151	838 TI	336
44 A	90	803 SW	149	838 TIZ	335
44 AS	91	805 A	145	838 di (A)	17
44 Ak	100	810 A	146	840 E	302
44 Cm	89	810 AG	152	840 F	294
44 Cms 1	89	810 AT	146	840 FC	295
44 Cms 2	89	810 AU	146	840 FG	298
44 Cms 3	89	810 AX	148	840 FH	296
44 Cms 4	89	810 AZ	150	840 FM	300

Mahr | Numerical Index

Instrument	Page	Instrument	Page	Instrument	Page
840 FS	301	844 Ti	422	D5M	172
844 A	95	844 Tk	431	D5M-RC	172
844 AS	97	844 Tma	419	D6K	172
844 Ag	99	844 Tmi	419	D6K-RC	172
844 D	340	844 Tms	420	D6Q	172
844 D-C	343	844 Tp	430	D6Q-RC	172
844 D-D	349	844 Ts	430	D7I	172
844 D-FD	351	844 Tw	418	D7I-RC	172
844 D-HR	356	844 Tz	426	D7O	172
844 D-M	353	852	315–316	D7O-RC	172
844 D-R	346	852 TS	314	D8I	172
844 DR	341	853	318–319	D8I-RC	172
844 DR-C	344	A1/2Q	162	D8IS	176
844 DR-D	350	A3Q	162	D8IT	176
844 DR-FD	352	A6Q	162	DK-D1	17
844 DR-HR	357	AAT–19	262	DK-U1	15
844 DR-M	354	AAT–20	262	DP20	255, 258
844 DR-R	347	B3K	164	DP50	255, 258
844 DR–3	361	B3K-RC	164	DP60	255, 258
844 DS	342	B3Q	164	DR20	260
844 DS-C	345	B3Q-RC	164	DR20–3	261
844 DS-F	359	B3W	164	DR50	260
844 DS-HR	358	B3W-RC	164	DR50–3	261
844 DS-M	355	B5M	164	EDI–300P–1	303
844 DS-R	348	B5M-RC	164	EDI–300P–2	303
844 Dg	362	B6K	164	EDI–300P–3	303
844 Dg-XL	362	B6K-RC	164	EDI–300P–4	303
844 Dg-Z	362	B6Q	164	EDI–300P–5	303
844 Dga	362	B6Q-RC	164	EDI–300P–6	303
844 Dge	363	B7I	164	EDI–300P–7	303
844 Dgk	362	B7I-RC	164	EDI–300P–8	303
844 Dgk-Z	362	B7O	164	EDI–300P–9	303
844 Dt-B	368	B7O-RC	164	EDI–301P–1	309
844 Dt-R	366	B8I	164	EDI–301P–2	309
844 Dt-S	367	B8I-RC	164	EDI–301P–3	309
844 Dt–3	369	C 1200 M	218	EDI–301P–4	309
844 Dv	364	C 1202	219	EDI–301P–5	309
844 Dw	365	C 1750 PC	222	EDI–301P–6	309
844 D–3	360	C1/2K	168	EDI–301P–7	309
844 K	385	C1/2K-RC	168	EDI–301P–8	309
844 KC	382	C1200 T	218	EDI–301P–9	309
844 Kck	390	C1K	168	EDI–36B–19	437
844 KM	402	C1K-RC	168	EDI–36B–9	437
844 KS	388	CD 140	543	EMD–300P–1D	304
844 KSk	394	CD 140 A	542	EMD–300P–2D	304
844 Ke	400	CD 280	543	EMD–300P–3D	304
844 Kg	397	CIM 1000 CNC	515	EMD–300P–4D	304
844 Kga	397	CM expert	557	EMD–300P–5D	304
844 Kgz	397	CM mobile	558	EMD–300P–6D	304
844 Kk	392	CM select	559	EMD–300P–7D	304
844 Kt	399	CNC modular	549	EMD–300P–8D	304
844 Kv	398	CP / CL select	568	EMD–300P–9D	304
844 Kw	399	Cockpit 13	223	EMD–301P–1D	310
844 N	404	D1K	172	EMD–301P–2D	310
844 NB	403	D1K-RC	172	EMD–301P–3D	310
844 NH	406	D3K	172	EMD–301P–4D	310
844 S	432	D3K-RC	172	EMD–301P–5D	310
844 T	416–417	D3Q	172	EMD–301P–6D	310
844 Ta	421	D3Q-RC	172	EMD–301P–7D	310
844 Tb	423	D3W	172	EMD–301P–8D	310
844 Tc	424	D3W-RC	172	EMD–301P–9D	310
844 Td	425	D5G	172	EMD–36B–19D	437
844 Te	427–429	D5G-RC	172	EMD–36B–9D	437

Mahr | Numerical Index

Instrument	Page	Instrument	Page	Instrument	Page
EMD-57B-11	329	N1/2O	163	P2010 UB	240
EMD-57B-11D	329	N3I	163	P2104 MA	241
GD 140	539	N6I	163	P2104 MB	242
GD 280	539	O1I	166	P2104 TA	241
GMX 400 W	622	O1I-RC	166	P2104 TB	242
GRP1	623	O3I	166	P2104 UA	241
ICM 100 IP	498	O3I-RC	166	P2104 UB	242
ICM 25	495	O6I	166	PLM 1000-E	514
LD 260 Aspheric 2D and 3D	590	O6I-RC	166	PLM 600-E	514
Linear 1200	505	O8I	166	PS 10	524
Linear 2000	505	O8I-RC	166	Pocket Surf IV	520
Linear 800	505	OMI-300P-1	308	Precimar ICM 100	499
M 310	528	OMI-300P-2	308	Q1I	174
M 310 C2	528	OMI-300P-3	308	Q1I-RC	174
M 310 PC	530	OMI-300P-4	308	Q3I	174
M 310	528	OMI-300P-5	308	Q3I-RC	174
M 400	534	OMI-300P-6	308	Q6I	174
M36B-10	433	OMI-300P-7	308	Q6I-RC	174
M36B-20	433	OMI-300P-8	308	Q8I	174
MC-I	15	OMI-300P-9	308	Q8I-RC	174
MFU 200 Aspheric 3D	584	OMI-301P-1	311	Q8IT	178
MM 420	574	OMI-301P-2	311	S 1840 F	220
MM 420 CNC	576	OMI-301P-3	311	S 1840 M	220
MMQ 100	605	OMI-301P-4	311	S 1840 PE/F	221
MMQ 100	609	OMI-301P-5	311	SCOPE 250 plus	631
MMQ 150	606	OMI-301P-6	311	SCOPE 600 plus 3D	633
MMQ 150	609	OMI-301P-7	311	SCOPE plus optical measuring instruments	632
MMQ 200	607	OMI-301P-8	311	SM 60	504
MMQ 200	609	OMI-301P-9	311	SP6IS	178
MMQ 400	608-609	Opto USB	15	SQ6IS	178
MSW 100	500	P 1512 V	252	Software EasyShaft	636
MarCom Prof.	10	P 1530 V	252	Software MarWin	617
Maxµm III	197-200, 202, 204	P1/2I	170	UD 130 Aspheric 2D	591
Millimar - USB	15	P1/2I-RC	170	UD 130/LD 130/LD 260	548
M-300P-1	307	P1300 MA	244	ULM 1000 S-E	509
M-300P-2	307	P1300 MA without cable	244	ULM 1000-E	508
M-300P-3	307	P1300 MB	245	ULM 1500 L-E	510
M-300P-4	307	P1300 MB without cable	245	ULM 1500-E	508
M-300P-5	307	P1300 TA	246	ULM 300-E	508
M-300P-6	307	P1300 TA ohne Kabel	246	ULM 520 S-E	509
M-300P-7	307	P1300 TB	247	ULM 600-E	508
M-300P-8	307	P1300 TB ohne Kabel	247	ULM 800 L-E	510
M-300P-9	307	P1I	170	VD 140	544
N 1701 PF-10000	227	P1I-RC	170	VD 280	544
N 1701 PF-2500/5000	227	P2001 M	234	WI 100	564
N 1701	227	P2004 M	235	WI 50	563
PF-2500/5000-4	227	P2004 MA	236	WI 50 M	562
N 1701 PM-10000	227	P2004 MB	237	XLI-22P-20	320
N 1701 PM-2500	227	P2004 T	235	XLI-57B-13	326
N 1701 PM-5000	227	P2004 TA	236	XLI-57B-15	323
N 1701 PS	230	P2004 TB	237	XR 1	538
N 1701 USB	229	P2004 U	235	e-Stick	14
N 1702 M	224	P2004 UA	236	i-Stick	12
N 1702 M-HR	224	P2004 UB	237	µDimensionair@II	231
N 1702 T	224	P2010 M	238	µMaxµm II	194-196
N 1702 U	224	P2010 MA	239	Dimentron	372, 374, 376, 378
N 1702 VPP	226	P2010 MB	240		
N 1704 I/O	228	P2010 TA	239		
N 1704 M	224	P2010 TB	240		
N 1704 T	224	P2010 UA	239		
N 1704 U	224				

Mahr | Alphabetical Index

Product	Page	Product	Page	Product	Page
2 depth probes incl. carrier (rotatable)	483	Compact amplifier	218–219	Digital indicator	132–144
2-jet air ring gage	260	Compact column amplifier	220	Digital inside micrometer	92
2-jet blind hole air plug HCC	255	Compact column measuring instrument	221	Digital inside micrometer in set	94
A		Compact form measuring machine	605–607	Digital inside quick probe	337
Adapter cable RS232-USB	15	Compact form measuring machine	609	Digital micrometer	74–78, 80–87
Adapter cable RS–232-USB	15	Conical contact point	154	Digital outer quick probe	334
Adapter for digital instruments und probes	501	Contour Measuring Station	543	Digital outside micrometers	64
Adaption cable (for foot swich via MarCom): jack plug Ø 3.5 mm/USB	15	Contour measuring station	542	Digital probe	198–199
Adjustable Stop	283	Cylindrical measuring pins	426	Digital special calipers	42–55
Adjustment pin	265	D		Digital test indicator	119
Adjustment ring	263–264	Data Processing	10, 12, 14–17	Digital universal caliper	36, 38, 40
Angular holder	159	Data cable USB bidirectional	15	Digital universal calipers	411
Anvils for measuring arms	430	Data connection cable RS232C	16	Digital workshop caliper	32–34
Anvils with round measuring faces	425	Data connection cable USB	15	Display unit	197
Asphere measuring station	590–591	Depth micrometer	101	E	
Attachment Stand	283	Depth probe incl. holder	483	Electrical and Pneumatic Length Measuring Instruments	218–224, 226–231, 234–242, 244–252, 255, 258, 260–265, 364, 398
Außentaster	266	Depth stop	399	Extension for measuring depth	
B		Depth stop with 3-point touching	369	F	
Ball anvil	431	Depth stops for 844 Tma, 844 Tmi, 844 Te	418	Fizeau interferometer	592–593
Ball contact	79, 317	Depth-Stop Bridge	368	Flat contact plates	155
Ball contact points	155	Depth-Stop Disc	367	Flat contact point	154, 157
Base with post	282	Depth-Stop Ring	366	Form measuring instruments	584, 605–609, 617
Basic Instrument Measuring Pistol	99	Dial Caliper	29	Fully automated dial indicator test bench	498
Basic software (V12)	500	Dial and Digital Indicators	132–164, 166, 168, 170, 172, 174, 176, 178, 180–181	G	
Basic unit	98	Dial comparator	206–211	Gage block comparator	492–493
Blind hole measuring probe	394–395	Dial indicator	146–148, 150, 162–164, 166, 168, 170, 172, 174, 176, 178, 180	Gage block holder and measuring jaws accessory set	459
C		Dial indicator with IP protection	161	Gage block maintenance accessories	460
CNC Workshop measuring microscope	576	Digimar	476–485, 487, 489	Gear measuring instruments	622–623
Calibration measuring instruments	508–510	Dial indicator depth measuring bridge	126	H	
Caliper	24–36, 38, 40, 42–59	Dial indicator	149	Heavy measuring table	281
Caliper gage for external measurement	332–333	Digital 3D touch probe	476–485, 487, 489	Height Gage	476
Caliper gage for internal measurement	335–336	Digital Caliper	24–28	Height Measuring Instruments	476–485, 487, 489
Caliper with analog display	30–31	Digital Micrometer	64, 66–67, 69	Height measuring and scribing instrument	485, 487, 489
Carrier for checking perpendicularity	484	Digital Micrometer	65, 68	Height measuring instrument	477
Carrier with a joint for a probe	481	Digital Micrometers	65, 68	Holder	121
Center Bench	288	Digital Micrometers	69	Holder for 2-point inner measuring devices	502
Center Bench with V-support	289	Digital and Dial Comparators	188, 190, 192, 194–200, 202, 204, 206–211	Holder for Plug Gage	362
Center bench with roller support	289	Digital depth gage	56–59	Holder for indicator	397
Combined contour and surface measuring station	548				

Product	Page	Product	Page	Product	Page
I					
I/O module	228	Manual dial indicator testing position	495	Measuring computer	222
Incremental Probe	252	MarCal	24–36, 38, 40, 42–59	Measuring head	100
Indicating Measuring Instruments	294–296, 298, 300–316, 318–337, 340–369, 372, 374, 376, 378, 382, 385, 388, 390, 392, 394–395, 397–400, 402–404, 406	MarCator	132–164, 166, 168, 170, 172, 174, 176, 178, 180–181	Measuring instruments for the optical industry	592–593
Indicating bench snap gage	314	MarConnect	10, 12, 14–17	Measuring pistol	95
Indicating measuring instruments	79, 317	MarForm	584, 605–609, 617	Measuring pistol in set	97
Indicating plug gage	340–361	MarGage	442–471	Measuring rollers	156
Indicating plug gage for through hole	372, 374, 376, 378	MarGear	622–623	Measuring software	223
Indicating snap gage	294–296, 298, 300–313	MarOpto	592–593	Measuring spindle extension	157
Indicating thread snap gage	315–316, 318–319	MarShaft	631–633, 636	Measuring stand	124, 402
Indicator gage	433–439	MarShaft 600 plus 3D optical shaft measuring system	633	Measuring tables, measuring tripods, radial runout gages	270–283, 287–289
Inductive dial comparator	188, 190, 192	MarShaft SCOPE 350 / 750 / 1000 plus optical shaft measuring systems	632	Measuring tripod with magnetic base	271–275
Inductive digital comparator	194–196, 200, 202, 204	MarStand	270–289	Measuring tripod with triangular pedestal	270
Inductive probe	234–242, 244–251	MarSurf	520, 524, 528, 530, 534, 538–539, 542–544, 548–549, 556–559, 562–564, 568, 590–591	Mechanical 3D touch probe	127
Inside Micrometer Set	89	MarTest	106–112, 114–127	Micromar	64–78, 80–92, 94–95, 97–101
Inside measuring probe	390, 392	MarVision	574, 576, 578–579	Micrometer	70
Inside micrometer	88, 90	MaraMeter	79	Micrometer with integrated dial comparator	71–72
Inside micrometer in set	91	Marameter	294–296, 298, 300–337, 340–369, 372, 374, 376, 378, 382, 385, 388, 390, 392, 394–395, 397–400, 402–404, 406	Micrometers	64–78, 80–92, 94–95, 97–101
Inspection, testing and measuring equipment	284–286	Matched pair jet probes	262	Millimar	218–224, 226–231, 234–242, 244–252, 255, 258, 260–265
Interface Adapter with Data Cable Digimatic	17	Measuring Towers	593	Millimess	188, 190, 192, 194–200, 202, 204, 206–211
L					
Large dial indicator	152	Measuring and centering arm	123	Mobile Dial Calibrator	181
Large granite comparator stand	280	Measuring anvils	430	Mobile pneumatic length measuring instrument	231
Large granite comparator stand with fine adjustment	280	Measuring anvils with measuring blades	423–424	Mobile roughness measuring instrument	520, 524, 528, 530
Length measuring bench	504	Measuring arms	427–429	Mobile surface measuring instrument	534
		Measuring attachment	156	Module for incremental sensors	226
				Module for inductive probes	224
				Module for pneumatic gages	227
				Motorized dial indicator testing position	499
				Mounting attachment	419
				Mounting attachment offset by 90°	420
				Mounting shaft	120
				Multimar	411, 416–439

Mahr | Alphabetical Index

Product	Page	Product	Page	Product	Page
N					
Nozzle through-hole pin	258				
O					
Optical Measuring Instruments	579				
Optical flat	461				
Optical parallel	462				
Optical parallels	463				
P					
Pin contact point	157				
Plate for single measurement	283				
Plate for sum measurement	283				
Plug Gage Holder for inductive Probe	363				
Portable thickness gages	320–331				
Post and support assemblies	276				
Power supply module	230				
Precimar	492–493, 495, 498–502, 504–505, 508–510, 514–515				
Precision 3D measuring station	584				
Precision bench micrometer	73				
Precision length measurement	492–493, 495, 498–502, 504–505, 508–510, 514–515				
Precision length measuring machine	514–515				
Probe carriers	481				
Probe carriers 817 CLM	482				
Probe holder	282				
Probe set	478–479				
R					
Radial runout gage with center supports	287				
Receiver	14				
Receiver for instruments with Integrated Wireless	12				
Rectangular gage block set made of ceramic	448–452				
Rectangular gage block set made of steel	442–447				
Rectangular gage blocks made of ceramic	456–458				
Rectangular gage blocks made of steel	453–455				
Right Angle Attachment	365, 399				
Ring gage	467–469				
Roller blades, carbide	79, 317				
Roughness Probe	623				
Roughness and Contour Measuring Station	544				
Roughness measuring station	538–539				
S					
Safety dial indicator	151				
Self-centering dial bore gage	382, 385, 388, 403				
Self-centring dial bore gage	404, 406				
Sensor level	160				
Set of miniature precision vises	579				
Set of rack rails for measuring range	578				
200 x 100 mm					
Set of rack rails for measuring range	578				
250 x 170 mm					
Set of rack rails for measuring range	578				
400 x 250 mm					
Setting and measuring instrument	505				
Setting device	432				
Setting disc	470–471				
Setting rings in Set	400				
Shaft measuring instruments	631–633, 636				
Shoulder anvils	421–422				
Single jet probe	262				
Small ceramic comparator stand	278				
Small ceramic comparator stand with fine adjustment	278				
Small comparator stand, plate made of granite	279				
Small dial indicators	145				
Small steel comparator stand	277				
Software interface	10				
Spherical contact plates, steel	156				
Spherical contact point	153				
Stand for vise with 15 mm jaw width	579				
Stand for vise with 25 mm jaw width	579				
Stand for vise with 35 mm jaw width	579				
Standard contact point	153				
Standards and gage blocks	442–471				
Straight holder	158				
Support Arm with fine adjustment	282				
Support Arm without fine adjustment	282				
Support arm with dovetail guide	282				
Surface Measuring Instruments	520, 524, 528, 530, 534, 538–539, 542–544, 548–549, 556–559, 562–564, 568, 590–591				
Surface plate made from granite	284–286				
T					
Test Indicators and Touch Probes	106–112, 114–127				
Test indicator	106–112, 114–118				
Thread pin gage	464				
Thread pin gages set	466				
Thread pin gages, holder pair	465				
U					
USB connecting module	229				
Universal Measuring Instruments	411, 416–439				
Universal centering support frame	125				
Universal form measuring machine	608–609				
Universal gear measuring center	622				
Universal holder with dovetail clamp	122				
Universal measuring instrument	416–417				
Universal probe set	480				
Universal, fully automatic optical shaft measuring system	631				
MarShaft SCOPE 250 plus					
V					
Vise with 15 mm jaw width	579				
Vise with 25 mm jaw width	579				
Vise with 35 mm jaw width	579				
W					
Wedge shaped contact points	154				
Workshop calipers	35				
Workshop measuring microscope with M3 software	574				

America

United States

Mahr Inc. (local H. Q.)

1139 Eddy Street
Providence, RI 02905, USA
Phone: +1 401 784-3100
+1 800 343-2050 (toll-free)
Fax: +1 401 784-3246
information@mahr.com

Mahr Inc. - South Carolina Center of Excellence

4450 Olympic Blvd.
Erlanger, KY 41018, USA
Phone: +1 859 525-6116
Fax: +1 859 525-0481
information@mahr.com

Mahr Inc. - L.A. Center of Excellence

11135 Knott Avenue, Suite H
Cypress, CA 90630, USA
Phone: +1 714 379-7051
Fax: +1 714 379-0468
information@mahr.com

Mahr Inc. - Detroit Center of Excellence

48325 Alpha DRIVE, Suite 100
Phone: +1 (248) 560-6259
Fax: +1 (248) 924-2012
Wixom, MI 48393, USA
information@mahr.com

Mahr Inc. - South Carolina Center of Excellence

7001-A Pelham Road
Greenville, SC 29615, USA
Phone: +1 800-343-2050
Fax: +1 864-203-3275
information@mahr.com

Mahr Metering Systems Corporation

1415 A Cross Beam Dr.
Charlotte, NC 28217, USA
Phone: +1 704 525-7128
+1 800 459-7867 (toll-free)
Fax: +1 704 525-8290
information@mahrusa.com

Mexico

Mahr Corp. de México S.A. de C.V.

Francisco Garza Sada #690,
Col. Chepevera
64030 Monterrey,
Nuevo León, Mexico
Phone: +52 81 8333-2010
ventasMexico@mahr.com

Brazil

Mahr do Brasil Ltda.

Av. João Pescarini
590 - Vinhedo, São Paulo
13280-144, Brazil
Phone: +55 (19) 3876-8600
Fax: +55 11 98203-9834
apoio.vendas@mahr.com

Europe

Germany

Mahr GmbH (Headquarters)

Carl-Mahr-Str. 1
D-37073 Göttingen, Germany
Phone: +49 551 7073-800
Fax: +49 551 7073-888
info@mahr.com

Mahr GmbH

Esslingen site

Reutlinger Straße 48
73728 Esslingen, Germany
Phone: +49 711 9312-600
Fax: +49 711 9312-725
info@mahr.com

Mahr GmbH

Jena site

Max-Grossmann-Str. 1
07745 Jena, Germany
Phone: +49 551 7073 800
Fax: +49 551 7073 808
info@mahr.com

Mahr GmbH South West Branch

Reutlinger Straße 48
73728 Esslingen, Germany
Phone: +49 711 9312-800
Fax: +49 711 9312-815
Niederlassung-Suedwest@mahr.com

Mahr GmbH Northern Branch

Hatzfelder Straße 161
42281 Wuppertal, Germany
Tel. +49 202 758187-0
Fax +49 202 758187-19
Niederlassung-Nord@mahr.com

Mahr GmbH South East Branch

Hopfenstraße 30
85283 Wolnzach, Germany
Phone: +49 8442 96266-0
Fax: +49 8442 96266-11
Niederlassung-Suedost@mahr.com

Mahr MWF GmbH

Melberstraße 9
63762 Grobostheim, Germany
Phone: +49 6026 9728-0
Fax: +49 6026 9728-20
info-mwf@mahr.com

Poland

Mahr Polska Sp. z o.o.

ul. Gimnazjalna 4
01-364 Warszawa, Poland
Phone: +48 22 862 39 97
mahr.polska@mahr.com

Czech Republic

Mahr, spol. S.r.o.

Ulice Kpt. Jaroše 552
41712 Proboštov,
Czech Republic
Phone: +420 417 816 735
info-cz@mahr.com

Slovakia

Mahr Metrológia, s.r.o.

Seberíniho 482/1
821 03 Bratislava, Slovakia
Phone: +421 2 321 212 16
info-sk@mahr.com

Hungary

Mahr Magyarország Kft.

Gyár utca 2
2040 Budaörs, Hungary
Phone: +36 1 414 0177
Fax: +36 1 414 0178
office.hungary@mahr.com

Austria

Mahr Austria GmbH

Hirschstettnerstraße 19-21
1220 Vienna, Austria
Phone: +43 1 204 36 73-0
Fax: +43 1 204 36 73-15
info-at@mahr.com

France

Mahr France SARL

6, rue Lavoisier - Z.I.
91430 Igny, France
Phone: +33 1 69351919
Fax: +33 1 69351900
info@mahr.com

Switzerland

Mahr AG Schweiz

Zürcherstrasse 68
8800 Thalwil, Switzerland
Phone: +41 44 723 39 99
Fax: +41 44 723 39 98
info-ch@mahr.com

Great Britain / Ireland

Mahr UK Ltd.

19 Drakes Mews
Crownhill, Milton Keynes
MK 8 0ER, Great Britain
Phone: +44 1908 563700
Fax: +44 1908 563704
salesuk@mahr.com

Spain

Mahr Metrologia, S.L.

Av. Vía Augusta, 15-25
Edificio @ Sant Cugat B-2 Pl. 1 Of. 13
08174 Sant Cugat del Vallés –
Barcelona, Spain
Phone: +34 (93) 534 22 83
info.es@mahr.com

Asia

China

Mahr Precision Metrology (Suzhou) Ltd.

No.399, Suhong Zhong Road,
Suzhou Industrial Park,
215122 Suzhou, China
Phone: +86 512 6258 5862
Fax: +86 512 6258 5816
infochina@mahr.com

Mahr Precision Metrology (Suzhou) Ltd.

Shanghai Branch

Room 304, No. 14, Lane 1401,
Jiangchang Road, Jing 'an District,
200435 Shanghai, China
Phone: +86 21 52385353
Fax: +86 21 52386012
infochina@mahr.com

Mahr Ltd.

Room 2101, Peninsula Tower,
538 Castle Peak Road, Lai Chi Kok,
Kowloon, Hong Kong, China
Phone: +852 2357 9683
Fax: +852 2763 9613
infochina@mahr.com

Korea

Mahr Korea Ltd.

#701-703, Ace Hitech City
Byeomgye 29 Simin-daero 109
Byeon-gil, Dongan-gu, Anyang City
14042 Gyeonggi-do, South Korea
Phone: +82 2 579 4981
Fax: +82 2 579 4986/7
sales-seo@mahr.com

Japan

Mahr Japan Co., Ltd.

712-4-1, Mamedo-cho, Kohoku-ku,
222-0032 Yokohama, Japan
Phone: +81 45 540-3591
Fax: +81 45 540-6251
info@mahr.jp

Malaysia

Mahr Malaysia Sdn. Bhd.

No. 130, Block B 1,
Leisure Commerce Square
No. 9, Jalan PJS 8/9,
46150 Petaling Jaya, Selangor
Malaysia
Phone: +60 3 7877-2060
Fax: +60 3 7877-2040
sales_msea@mahr.com

Thailand

Mahr S.E.A. Co. Ltd.

719 KPN Tower, 20th Floor
Rama 9 Rd., Bangkapi, Huaykwang
Bangkok 10310, Thailand
Phone: +66 2 717 1050-2
Fax: +66 2 717 1055
sales_msea@mahr.com

India

Mahr Metrology India Pvt. Ltd. Corporate Office, Chennai

B-6, Reddipalayam Road,
4th Street, Mogappair West Estate,
Chennai - 600 037, India
Phone: +91 (44) 4617 5555
Fax: +91 (44) 4617 5505
Sales: +91 91580 02282
Service: +91 80560 78681
Sales Support: mahrindia@mahr.com
Service Support: Service.India@mahr.com

Mahr Metrology India Pvt. Ltd. Bangalore Office

No.6 & 13, 5th 'C' Cross, 3rd Main Road,
St. Claret College Road,
Sharadambanagar, Jalahalli Village,
Bangalore - 560013, India
Sales: +91 78239 46909
Service: +91 95919 97818
Sales Support: mahrindia@mahr.com
Service Support: Service.India@mahr.com

Mahr Metrology India Pvt. Ltd. Pune Office

Bangalow no 10, Mahindra Society,
Shastrinagar, Pune
Maharashtra 411006, India

Mahr Metrology India Pvt. Ltd. Gurgaon Office

P806-P807 8th floor
JMD Megapolis Sohna Road
Sector 48 Gurgaon
Haryana 122001, India

Ahmedabad (Gujarat & MP)

Sales: +91 90990 94080
Service: +91 90990 05302

The addresses of our dealers around the world (outside of the Mahr Group) can be found on our website www.mahr.com

© by Mahr GmbH, Göttingen

We reserve the right to modify our products, especially in light of technical improvements and further developments. All illustrations, numerical values, etc. are therefore subject to change.

3766075 – 02.2023
Printed in Germany



Mahr GmbH
Carl-Mahr-Straße 1
D-37073 Göttingen
Germany

Phone: +49 551 7073 800
info@mahr.com
www.mahr.com



© Mahr GmbH

We reserve the right to make changes to our products,
especially due to technical improvements and further developments.
All illustrations, numerical values, etc. are therefore subject to change.

3766075 | 02.2023



New Products 2022



Content

Digimar Overview	4
Height Measuring Instruments	
Digimar 817 CLT	6
Height Measuring Instrument	
Digimar Accessories	7
Millimes Overview	14
Comparators	
Millimes 2000 W / 2000 Wi	16
Inductive Comparators	
Millimes 2001 W / 2001 Wi	18
Inductive Comparators	
Mar4D PLQ	22
Cylinder Coordinate Measuring Machines	
Mar4D PLQ 4200	24
Cylinder Coordinate Measuring Machine	
MarSurf Overview	26
Contour Measuring Instruments	
MarSurf CD 140 AG 11	28
Contour Measuring Station	
Reference Form Tester Overview	30
Form Measuring Instruments and Measuring Instruments for the Optical Industry	
MarForm MFU 200	32
Reference Form Measuring Station	
MarOpto MFU 200-3D	34
Precision 3D Measuring Station	

Digimar 817 CLT: Easy measurements using intuitive touch control



Best connection for secure data

Data can be transferred wirelessly or via USB cable via the MarConnect interface. Quickly print out a series of measurements? A Bluetooth printer is available for this purpose. Simply choose between complete measuring records in PDF format or save your measuring records as a TXT file.



Interfaces for dial indicators

An interface integrated in the slide enables the error-free measurement of the perpendicularity and straightness using the new Millimes 2000/2001W dial comparators.



Ergonomics that can be measured

Ergonomics means that the methods, processes, and arrangement are designed for people and not the other way around. This is exactly what the new Digimar 817 CLT stands for: The simple moving and scrolling functions of the touchscreen work just like smartphone and tablet. The keys on the display are already arranged in such a way that frequently used functions are particularly easy to access. The measurements on the measuring slide can easily be started by hand via the touch display, the thumbwheel with integrated arrow keys, or using Quick mode. Two pushbuttons to actuate the air bearings are integrated into the handle enabling the device to be guided safely and sensitively by left- and right-handed operators. Regardless of whether you prefer to sit or stand while working: The touch display is always at eye level and can be rotated and tilted as required. This ensures the measuring process is particularly comfortable and relaxed.





Simple touch measurement

Intuitive operation via large, clearly defined keys to ensure the safe completion on measurements, setting and calculation of functions, and the creation of measuring programs via Drag & Drop.

Pivoting display

10-inch touch panel with turn/tilt joint so that it can be set individually for the work position, height of the operator, and lighting conditions.



Easy handling

The thumbwheel can be used to move the measuring slide quickly and easily start the measurement. The quick measurement function keys also automatically detect surfaces and bores.



Best ergonomics

Ergonomic handles on both sides have an integrated operating key for the air bearing ensuring the device can be moved accurately and effortlessly on the measuring plate.



Digimar 817 CLT

Height measuring instrument



FEATURES

Operating and display unit

- Large and clearly defined touch display with backlighting
- Operator guidance with self-explanatory icons
- Multilingual user guidance
- Option of setting additional zero points on the workpiece
- Additional measuring instrument can be connected via MarConnect USB port
- Future-proof thanks to software updates
- Automatic activation of standby mode
- Selectable auto-off function, without loss of measured values



Functions

- Top or bottom contacting
- Web width or distances between grooves, including center of web or groove
- Bore or shaft diameter, including center of bore or shaft
- Bore reversing point (up or down)
- Shaft reversing point (up or down)
- Calculating distances or symmetry
- Dynamic measuring functions
- Perpendicularity measurement
- Straightness measurement
- Measurement in 2D mode
- Measuring programs
- Measuring data processing

Measuring system

- Optical incremental measuring system for outstanding measuring accuracy and reliability
- Dynamic probe system enabling high repeatability
- Air bearing system for light and smooth movement
- Motorized measuring slide simplifies measurement runs
- Probe constant remains after the instrument is switched off
- Integrated rechargeable battery with a long operating life for mains-independent measurement
- Temperature compensation via internal temperature sensor

Scope of delivery

- Height measuring instrument incl. operating and display element
- Carrier 817 h1
- Measuring anvil K6/51
- Setting gage 817 eb
- USB cable
- Operating instructions
- Recharging unit
- Protective cover
- Calibration certificate

TECHNICAL DATA

Order no.	4429600	4429601	4429602
Product type		817 CLT	
Measuring range	mm 0 – 350	0 – 600	0 – 1000
Application range from	mm	170	
Application range up to	mm 520	770	1170
Resolution	mm	0.01, 0.005, 0.001, 0.0005, 0.0001	
Resolution	inch	.001", .0005", .0001", .00005", .00001"	
Error limit	µm	(1.8 + L/600) L in mm	
Repeatability bores	µm	1	
Repeatability planes	µm	0.5	
Perpendicularity error in µm	µm	5	6 10
Operating time max.	h	14	
Measuring force	N	1.0 +/- 0.2 N	
Relative humidity non-condensing	%	65	
Working temperature	°C	20	
Operating temperature	°C	10 – 40	
Product weight	kg	22	26 29
Data interface		USB, Wireless	
Standard		Factory standard	

ACCESSORIES

Order no.	Product name	Product type
6910271	Printer set incl. Bluetooth USB adapter	DP-B1
4102220	USB adapter for MarConnect Wireless	i-stick
4221525	Surface plate made from granite, 1000 x 630 mm	107 G
5450105	Printer paper, 12 rolls	
4221573	Stand, 1000 x 630 mm	107 Ug
4221526	Surface plate made from granite, 1200 x 800 mm	107 G
4221574	Stand, 1200 x 800 mm	107 Ug

Software

- MarCom Professional can be downloaded free of charge from: www.mahr.com/marcom (only for Mahr data cable and wireless systems with USB and RS-232 interface)



i-Stick



107 G + 107 Ug



DP-B1

Digimar 817 ts1

Probe set

FEATURES

- Large accessory kit
- Packaged in a practical plastic case
- Consisting of:
 - Depth probe
 - Carrier with extended holder
 - Disc measuring probe for grooves, etc.
 - Conical measuring probe
 - Cylindrical measuring probe
 - Holder for test indicator styli with M2 thread
 - Carrier including 4 spherical probes with shaft diameter 8 mm
- Package contains: case

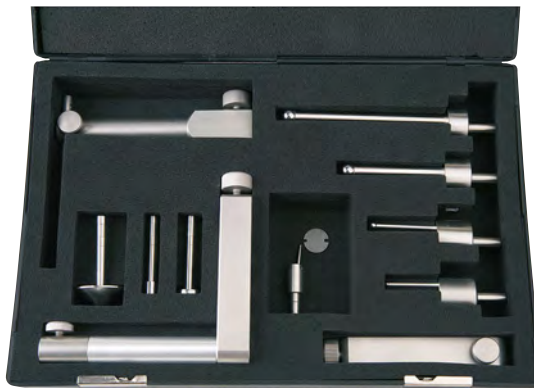

TECHNICAL DATA

Order no.	Product type
4429019	817 ts1

COMPONENTS INCLUDED IN SET

Order no.	Product name	Product type
4429219	Carrier for a probe, mounting hole 6 mm, a = 100.5 mm, b = 119.5 mm, c = 84 mm	817 h2
4429226	Disc probe \varnothing 15 mm	S 15/31.2
4429227	Cylindrical probe \varnothing 10 mm	Z 10/31.2
4429228	Taper probe	MKe 30
4429221	Depth probe incl. Holder	TMT 120
4429256	Probe with M2 threads for 3 styli positions ($0^\circ/10^\circ/90^\circ$), incl. styli 800 ts \varnothing 2.0 mm	KM 2
4429220	Carrier for probes 817 CLM, mounting hole 8 mm	817 h4
7023813	Probe with mount, \varnothing 4.0 mm	K 4/30
7023816	Probes with mount, \varnothing 6 mm	K 6/40
7023810	Probes with mount, \varnothing 10.0 mm	K 10/60
7023615	Probes with mount, \varnothing 10.0 mm	K 10/100

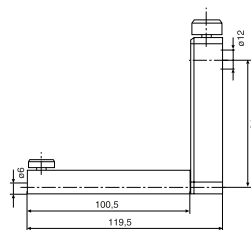

817 h2

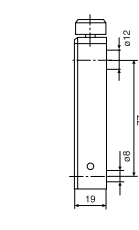

817 h4

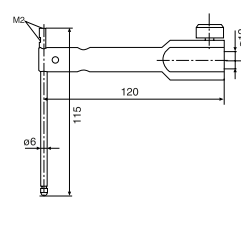

TMT 120

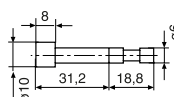

Z 10/31.2

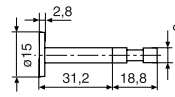

S 15/31.2

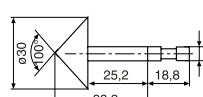

MKe 30

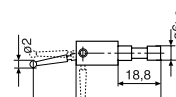

KM 2

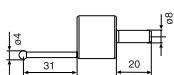

K 4/30

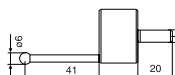

K 6/40

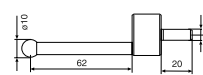

K 10/60

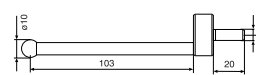

K 10/100

Digimar 817 ts2

Probe set

FEATURES

- Small accessory kit
- Packaged in a practical plastic case
- Consisting of:
 - Depth probe
 - Carrier with extended holder
 - Disc measuring probe for grooves, etc.
 - Conical measuring probe
 - Cylindrical measuring probe
 - Holder for test indicator styli with M2 thread
- Package contains: case

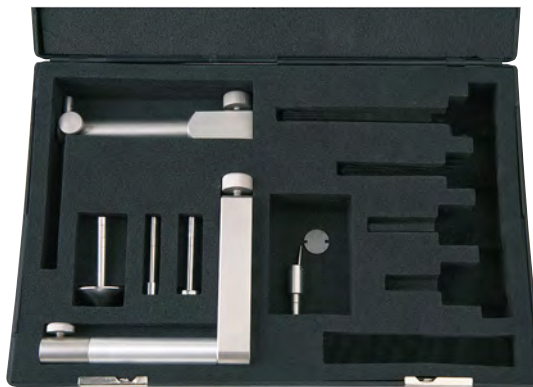

TECHNICAL DATA

Order no.	Product type
4429018	817 ts2

COMPONENTS INCLUDED IN SET

Order no.	Product name	Product type
4429219	Probe carrier, mounting hole 6 mm, a = 100.5 mm, b = 119.5 mm, c = 84 mm	817 h2
4429226	Disc probe \varnothing 15 mm	S 15/31.2
4429227	Cylindrical probe \varnothing 10 mm	Z 10/31.2
4429228	Taper probe	MKe 30
4429221	Depth probe including holder	TMT 120
4429256	Probe incl. styli 800 ts \varnothing 2.0 mm	KM 2

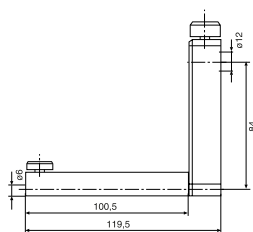

817 h2

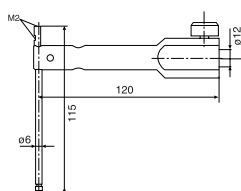

TMT 120

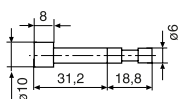

Z 10/31.2

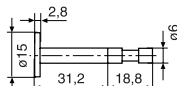

S 15/31.2

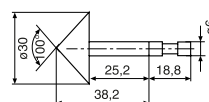

MKe 30

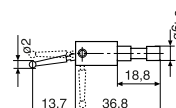

KM 2

Digimar 817 ts3

Universal probe set

FEATURES

- Accessory kit for small parts and delicate grooves, recesses and bores
- Packaged in a practical wooden case
- Suitable for 817 h4 carriers with 8 mm mounting bore
- Consisting of:
 - Base with 8 mm holding shaft
 - Depth probe
 - Probe shoe for grooves and recesses
 - Spherical measuring probe
 - Conical measuring probe
 - Extension
 - Adapter for M2.5 measuring anvils
- Package contains: case

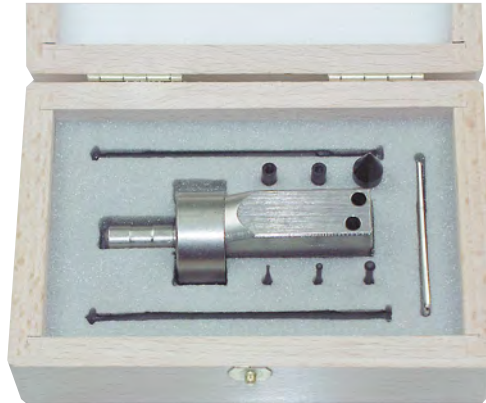

TECHNICAL DATA

Order no.	Product type
7034000	817 ts3

COMPONENTS INCLUDED IN SET

Order no.	Product name	Product type
3015917	Probe carrier	GK/8
3015918	Measuring crook, $d = 0.5 \text{ mm}$, $l = 78 \text{ mm}$	TS 0.5/78
3015919	Probe pin/tip, $d = 1.2 \text{ mm}$, $l = 75 \text{ mm}$, $l_s = 15.5 \text{ mm}$	T 1.2/75
3015920	Taper probe	MKe 8
3022000	Spherical probe, $d_k = 3.0 \text{ mm}$, $l = 24 \text{ mm}$	K 3/24
3022001	Spherical probe, $d_k = 2.0 \text{ mm}$, $l = 24 \text{ mm}$	K 2/24
3022002	Spherical probe, $d_k = 1.0 \text{ mm}$, $l = 24 \text{ mm}$	K 1/24
3015888	Extension M3 - M2.5, $d = 4 \text{ mm}$, $l = 20 \text{ mm}$	V/M 2.5
3015921	Extension M3 - M3, $d = 4 \text{ mm}$, $l = 20 \text{ mm}$	V/M 3

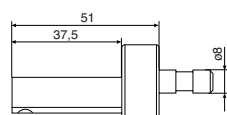

GK/8

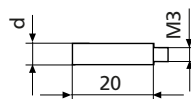

V/M2...M3

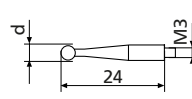

K 1...K3/24

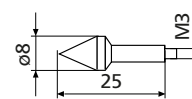

Mke 8

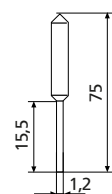

T 1.2/75

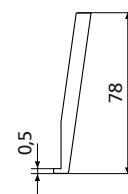

TS 0.5/78

Digimar 817 h1 / 817 h2 / 817 h5

Probe carriers

FEATURES

- Carrier for probes with 6 mm holding shaft
- Used for measurements at increased measuring depth (817 h2)
- Pivoting (817 h5) e.g. for aligning a cylindrical measuring probe



TECHNICAL DATA

Order no.	Product type
4429154	817 h1
4429219	817 h2
4429454	817 h5

Order no.	a	b	c	Mounting hole
	mm	mm	mm	
4429154	27.5	46.5	84	6 mm
4429219	100.5	119.5	84	6 mm
4429454	35	54	86	6 mm

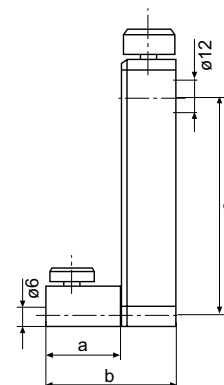

ACCESSORIES

Order no.	Product name	Product type
4301865	Mounting shaft \varnothing 6 mm for touch probes	800 a6
4429158	Spherical probe, \varnothing 5.0 mm	K 5/51
4429226	Disc probe \varnothing 15 mm	S 15/31.2
4429227	Cylindrical probe \varnothing 10 mm	Z10/31.2
4429228	Taper probe	MKe 30
4429254	Spherical probe for 817 CLM, \varnothing 6 mm	K 6/51
4429256	Probe including styli 800 ts \varnothing 2.0 mm	KM 2

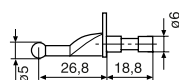

K 5/51

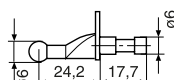

K 6/51

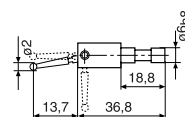

KM 2

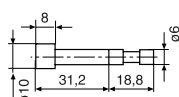

Z 10/31.2

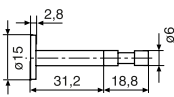

S 15/31.2

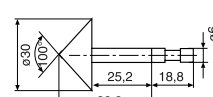

MKe 30

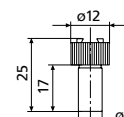

800 a6

Digimar 817 h4

Probe carriers 817 CLM

FEATURES

- Carrier for measuring anvils with 8 mm holding shaft and weighing 102 g
- Suitable for the CXt2 universal measuring probe set
- Compatible with Digimar CX1 and CX2 probes weighing 102 g



TECHNICAL DATA

Order no.	Product type	Mounting hole
4429220	817 h4	8 mm

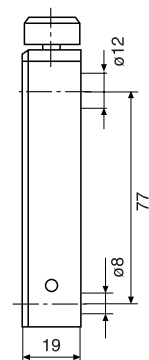

ACCESSORIES

Order no.	Product name	Product type
3015888	Extension M3 - M2.5, d = 4 mm, l = 20 mm	V/M 2.5
3015917	Probe carrier	GK/8
3015918	Measuring crook, d = 0.5 mm, l = 78 mm	TS 0.5/78
3015919	Probe pin/tip, d = 1.2 mm, l = 75 mm, ls = 15.5 mm	T 1.2/75
3015920	Taper probe	MKe 8
3015921	Extension M3 - M3, d = 4 mm, l = 20 mm	V/M 3
3022000	Spherical probe, d _k = 3.0 mm, l = 24 mm	K 3/24
3022001	Spherical probe, d _k = 2.0 mm, l = 24 mm	K 2/24
3022002	Spherical probe, d _k = 1.0 mm, l = 24 mm	K 1/24
7023615	Probes with mount, ø 10.0 mm	K 10/100
7023810	Probes with mount, ø 10.0 mm	K 10/60
7023813	Probe with mount, ø 4.0 mm	K 4/30
7023816	Probes with mount, ø 6 mm	K 6/40

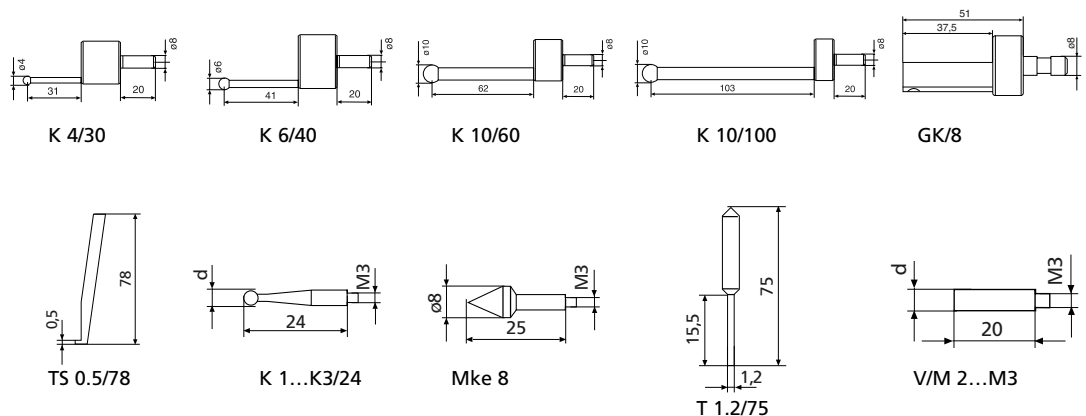

Digimar TMT 120 / TMT 120 S

Depth probe including holder

FEATURES

- Depth probe and carrier for measurements in vertical bores and recesses
- Interchangeable depth probe
- M2 and M2.5 connecting threads for measuring anvils
- M2.5 spherical contact point
- 901 H
- pivoting (TMT 120 S only)
- Second depth probe with probe shoe for groove measurement (TMT 120 S only)
- M2 stylus 800 ts with 2 mm ball (TMT 120 S only)

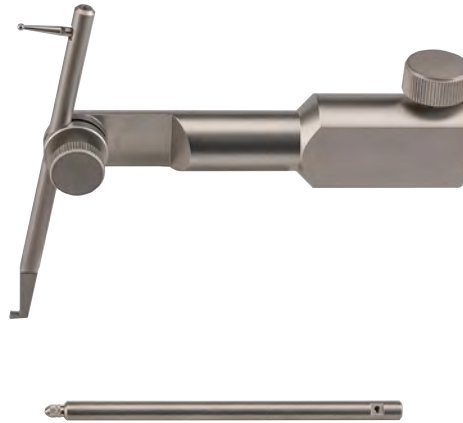

TECHNICAL DATA

Order no.	Product type
4429221	TMT 120
4429421	TMT 120 S

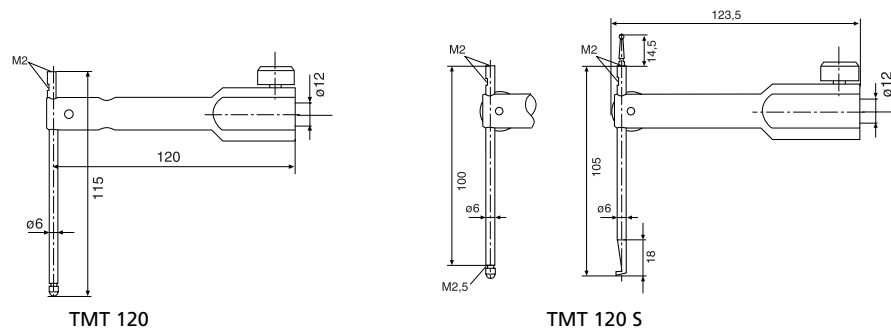

ACCESSORIES

Order no.	Product name	Product type
4305870	Stylus \varnothing 1.0 mm, carbide, $l = 14.5$ mm	800 ts
4305850	Stylus \varnothing 2.0 mm, carbide, $l = 14.5$ mm	800 ts
4305871	Stylus \varnothing 3.0 mm, carbide, $l = 14.5$ mm	800 ts
4309051	Stylus \varnothing 2.0 mm, ruby, $l = 14.5$ mm	800 tsr
4360001	Standard contact point, steel, $r = 1.5$ mm	901
4360002	Standard contact point, carbide, $r = 1.5$ mm	901 H
4360003	Standard contact point, ruby, $r = 1.5$ mm	901 R
4360241	Pin contact point, carbide, $l = 11$ mm, measuring surface \varnothing 1.5 mm	911 H2

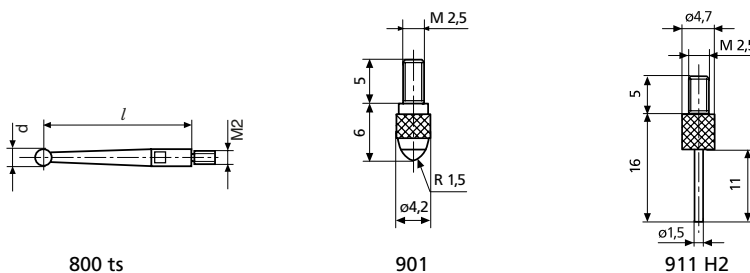

Digimar 817 h3

Carrier for checking perpendicularity

FEATURES

- Carrier for perpendicularity measurement
- Suitable for analog and digital dial indicators
- Ideal with P1514H measuring probe (817 CLM only)



TECHNICAL DATA

Order no.	Product type
4429206	817 h3

Order no.	Mounting hole
4429206	8 mm

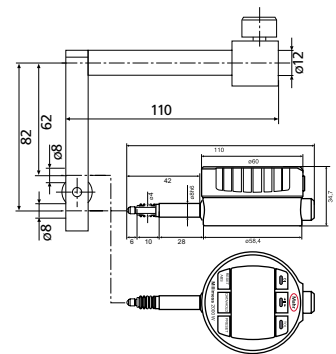

ACCESSORIES

Order no.	Product name	Product type
4429610	Data connection cable RS232C (2 m)	DK-M1
4346700	Digital indicator 0.0001mm/±1mm	2000 W
4346800	Digital indicator 0.0001mm/±1mm	2001 W



2001 W



2000 W



DK-M1

Millimes 2001 Wi: Everything under control! A digital dial comparator – highest level of precision thanks to inductive measuring system



Integrated Wireless

- Integrated wireless interface
- Sending and receiving measuring data and various parameters



Lock individual keys and functions

Remote-controlled settings can be configured easily using MarCom Professional software



Can be configured and controlled remotely using MarCom Professional software



First digital comparator indicator with touch operation



Unique touch operation – even works with gloves

Enormous advantages:

- Keys react even with the slightest touch
 - This prevents a measuring device from being adjusted or deformed
- **Maximum measuring certainty**

Hardened glass front

- Scratch and impact-resistant surface
- Excellent protection against scratches and penetrating liquids
- Wear-free keys react to the slightest touch



Protection rating IP 64

Excellent protection against dust and splash water from all directions ensures optimum workshop compatibility at all times



High-precision ball-bearing guide

Maximum sensitivity of the measuring system. long service life, and high loading capacity

Bi-directional data interface via USB

- Sending and receiving measuring data and various parameters
- Permanent power supply via data cable
- Possible to retrieve the device ID

#ID

Data interface via Digimatic

- To send measuring data



Convenient tolerance functions

- Clear tolerance symbols
- Colorful LED signals (red, green, yellow) to classify the measuring values
 - No go/Go/warning limit
 - No go/Go/rework

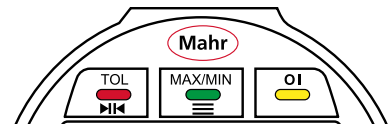

High precision inductive measuring system

Lowest measuring deviations thanks to linearization

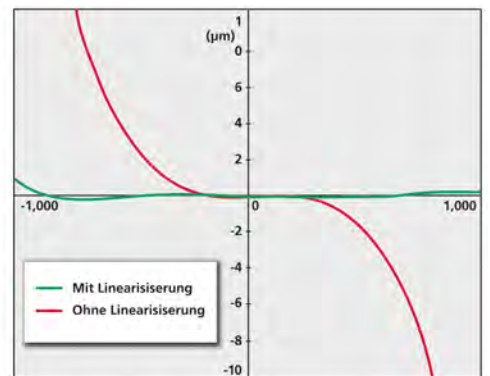

ABS system

Absolute measuring system

The reference to the electric zero point is not lost when the device is switched off

Millimes 2000 W / 2000 Wi

Inductive comparator



FUNCTIONS

- ON/OFF
- mm/inch
- RESET (set display to zero)
- PRESET (for entering a numerical value)
- ABS (reference to the electrical zero point)
- Selectable resolution
- TOL (Tolerance and Warning Limits Input)
- Factor (adjustable)
- Reversal of counting direction
- HOLD (storage of measured values)
- LOCK function (key lock)
- DATA (data transmission)
- Bi-directional data interface (external output and input option of characteristic values as well as setting of individual lock functions by software MarCom)

FEATURES

- **Tempered glass front with touch control panels with enormous advantages:**
 - scratch and impact resistant surface
 - excellent protection against dust, coolants and lubricants
 - wear-free touch operating keys
 - improved safety of measurement values in measuring stands, as only a light touch of the key – no keystroke is required, thus no adjustment or deformation of the measuring device
- High-contrast LCD display, thus very clear and safe to read
- Clear tolerance symbols and colored LED signals (red, green, yellow) for measured value classification
 - **with** warning limit input: No Go / Go / Warning Limit
 - **without** warning limit input: No Go / Go / Rework
- Operating and display unit (bezel) can be rotated through 280°
- Mounting shank and measuring spindle are both made of hardened stainless steel
- Measuring spindle is mounted in a high-precision ball guide for minimal hysteresis
- Linearized inductive absolute measuring system
- Measuring force spring is interchangeable
- Lower stop is adjustable
- Software: MarCom Professional free download: www.mahr.com/marcom (only for Mahr data cables and wireless systems with USB and RS-232 interface)

Application:

For static measuring tasks



TECHNICAL DATA

Order no.	4346700		4346701	
Type	2000 W		2000 Wi	
Measuring range	mm			± 1
Resolution	mm	0.0001, 0.0002, 0.0005, 0.001, 0.002, 0.005, 0.01		
Resolution	inch	.000005", .00001", .00002", .00005", .0001", .0002", .0005"		
Error limit	µm	± (0.2 + 0.5 x L) L in mm		
Measuring value hysteresis f _u	µm	0.3		
Repeatability f _w	µm	0.1		
Standard	Factory standard			
Free stroke	mm	2.5		
Measuring force	N	0.9±0.1 (Reference to absolute zero point of inductive measuring system)		
IP protection category	IP 64			
Supply voltage	100– 240 V			

- Digit height: 11.5 mm
- Data interface: USB, Digimatic
- Energy supply: Integrated rechargeable accumulator (up to 4 weeks) or powered by USB Data Cable
- Battery type: Lithium polymer battery 3.7 V
- Package contains: instruction manual, USB data and charging cable type DK-U1, plug-in power supply (with 4 interchangeable adapters) for USB, rubber bellows, screwdriver for pre-stroke adjustment (hexagon socket 0.9 mm), case

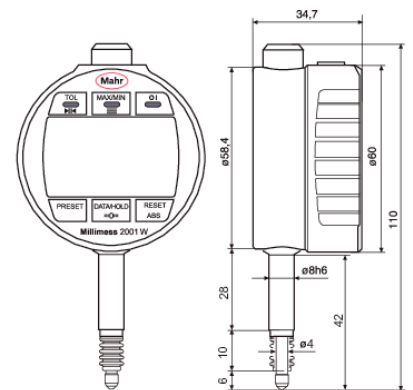

Millimess 2000 W / 2000 Wi

Inductive comparator

ACCESSORIES

Order no.	Description	Type
4102603	Data cable USB bi-directional (2 m)	DK-U1
4102606	Interface adapter with data cable Digimatic (2 m)	DK-D1
4310103	Adapter bushing (.375" / 8 mm)	940
4346010	Manual lifter with cable release	2000 h
4346011	Pneumatic lifter	2000 p
4346012	Measuring force adjuster	2000 m
4337421	Lug back	1086 b
4346050	Measuring force spring 0.25 N	
4346051	Measuring force spring 0.50 N	
4882284	Measuring force spring 0.75 N	
4346052	Measuring force spring 1.00 N	
4346053	Measuring force spring 1.50 N	
4346054	Measuring force spring 2.00 N	
4346055	Measuring force spring 2.50 N	
4337900	Display protection film, anti reflective frosted, made of extra hard hybrid glass, to protect against scratches and reflections	1086 sf
4346606	Shock protection ring made of hard rubber for Millimess 2000 W(i) / 2001 W(i)	1086 sr
4102220	Receiver for instruments with Integrated Wireless	i-Stick

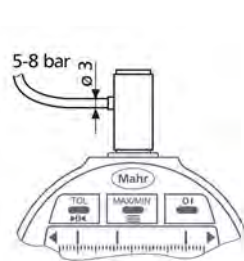

2000 p

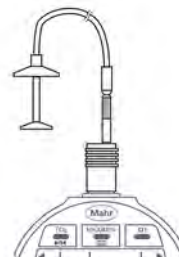

2000 h

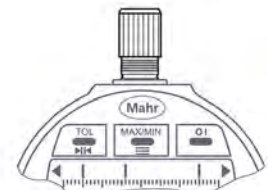

2000 m



1086 sf



1086 sr



i-stick

Millimess 2001 W / 2001 Wi

Inductive comparator

ACCESSORIES

Order no.	Description	Type
4102603	Data cable USB bi-directional (2 m)	DK-U1
4102606	Interface adapter with data cable Digimatic (2 m)	DK-D1
4310103	Adapter bushing (.375" / 8 mm)	940
4346010	Manual lifter with cable release	2000 h
4346011	Pneumatic lifter	2000 p
4346012	Measuring force adjuster	2000 m
4337421	Lug back	1086 b
4346050	Measuring force spring 0.25 N	
4346051	Measuring force spring 0.50 N	
4882284	Measuring force spring 0.75 N	
4346052	Measuring force spring 1.00 N	
4346053	Measuring force spring 1.50 N	
4346054	Measuring force spring 2.00 N	
4346055	Measuring force spring 2.50 N	
4337900	Display protection film, anti reflective frosted, made of extra hard hybrid glass, to protect against scratches and reflections	1086 sf
4346606	Shock protection ring made of hard rubber for Millimess 2000 W(i) / 2001 W(i)	1086 sr
4102220	Receiver for instruments with Integrated Wireless	i-Stick

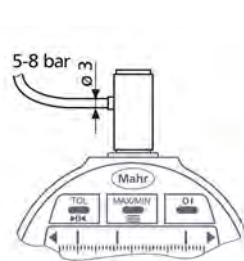

2000 p

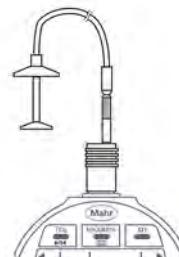

2000 h

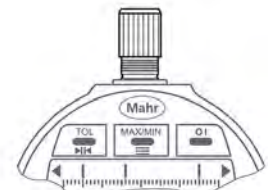

2000 m



1086 sf



1086 sr



i-stick

Millimess 2001 Wi

Inductive comparator

ACCESSORIES

Order no.	Description	Type
4102603	Data cable USB bi-directional (2 m)	DK-U1
4102606	Interface adapter with data cable Digimatic (2 m)	DK-D1
4310103	Adapter bushing (.375" / 8 mm)	940
4346010	Manual lifter with cable release	2000 h
4346011	Pneumatic lifter	2000 p
4346012	Measuring force adjuster	2000 m
4337421	Lug back	1086 b
4346050	Measuring force spring 0.25 N	
4346051	Measuring force spring 0.50 N	
4882284	Measuring force spring 0.75 N	
4346052	Measuring force spring 1.00 N	
4346053	Measuring force spring 1.50 N	
4346054	Measuring force spring 2.00 N	
4346055	Measuring force spring 2.50 N	
4337900	Display protection film, anti reflective frosted, made of extra hard hybrid glass, to protect against scratches and reflections	1086 sf
4346606	Shock protection ring made of hard rubber for Millimess 2000 W(i) / 2001 W(i)	1086 sr
4102220	Receiver for instruments with Integrated Wireless	i-Stick

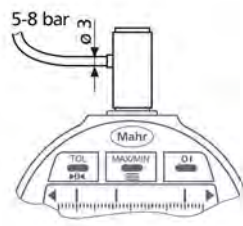

2000 p

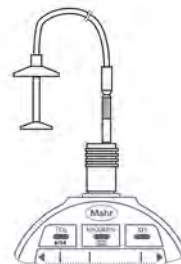

2000 h

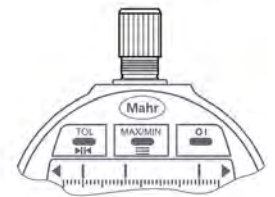

2000 m



1086 sf



1086 sr



i-stick

Mar4D PLQ 4200: Fast and precise measurement during production

The cylinder coordinate measuring machines from the Mar4D PLQ 4200 product line measure rotationally symmetrical workpieces with more flexibility and more conveniently than ever before. They operate at the highest speed and level of precision providing fast and reliable measuring results.

With the Mar4D PLQ 4200, Mahr provides its customers with a high-performance measurement solution for complex rotationally symmetrical workpieces. The multisensor system covers a particularly broad range of dimensional measuring tasks. The new machine also has a particularly sturdy design enabling 3D measurements to be completed directly during production, as well as offering shorter processing times and thus increased throughput and excellent productivity rates.



+ Advantages

- Future-proof thanks to combined measuring technology: optical and tactile solution in one machine
- Versatile: Check several features such as the length, diameter, form, position, contour, roundness, roughness, or 3D geometries, such as the symmetry, during a single measuring run
- Fast and precise: Unique speed and optimum axis accuracy even as the tolerances become smaller achieved thanks to specially developed control architecture
- Flexible for workpieces with a diameter up to 200 mm, a length of up to 1000 mm. and a weight of up to 50 kg
- Ergonomic operation and unique safety concept

Fast alignment

The motorized tailstock with clamping force monitor secures the workpieces perfectly without operator intervention.

Process reliability when measuring

Monitoring systems in the machine record and compensate for external influences, such as temperature, vibrations and position in real-time.

Ergonomic design

The sophisticated design of the machine guarantees easy and safe operation.

Reliable software

Thanks to its clearly structured user interface, the MarWin platform software is very user friendly: learn once, apply again and again.

Universally applicable

The multisensor technology of the Mar4D PLQ 4200 enables measurement of various rotationally symmetrical workpieces directly in production.



Detailed information can be found on our website.
<https://metrology.mahr.com/en/mar4d-plq>

Mar4D PLQ 4200

Cylinder coordinate measuring machine

FEATURES

Fast and precise measurement in production

- Easy to operate
- Process reliability when measuring
- Ergonomic design
- Reliable software
- Universally applicable
- Telecentric precision lens



TECHNICAL DATA

Order no.		5554200	5554201	5554202
Type		PLQ 4200-T2 Z=450	PLQ 4200-T2 Z=730	PLQ 4200-T2 Z=1000
Dimensions W/H/D	mm	800 / 2200 / 1800	800 / 2500 / 1800	800 / 2200 / 1800
Workpiece weight	kg		max. 20 (optional 50)	
Workpiece dimensions	mm	450	730	1000
Max. diameter	mm	200		
Measurement resolution		Adjustable		
Lengths/diameters	mm	0.01...0.0001		
Lengths/diameters	inch	0.001...0.0001		
Angle		0.01...0.0001 degrees (decimal) or degrees, minutes, seconds		
Error limit only diameter, $E_{BZX, MPE}^*$	μm	$\leq (1 + L/150) L$ in mm		
Error limit only parallel length Z, $E_{BZX, MPE}^*$	μm	$\leq (2 + L/200) L$ in mm		
Travel speed Z		max. 200 mm/s		
Travel speed X1		max. 200 mm/s		
Travel speed X2		max. 50 mm/s		
Travel speed C		max. 2.0 1/s		
Travel speed Y		max. 50 mm/s		

* Tempered workpiece at $t=20 \pm 2^\circ\text{C}$, on smooth surfaces ($R_z < 1 \mu\text{m}$) DIN EN ISO 10360-7

Subject to change without notice.

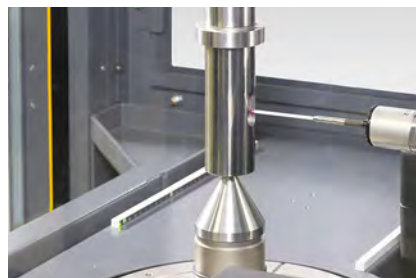

Tactile measurements with SP25



Tactile measurements with T7W



Optical measurements



Control panel

ACCESSORIES

Order no.	Description	Type
5361112	Centering tip 60°, Ø 2–15 mm, height 35 mm	
5361223	Centering tip 60°, Ø 2–44 mm, height 46 mm	
5361105	Centering tip 60°, Ø 3–15 mm, height 25 mm	
5361106	Centering tip 60°, Ø 2–19 mm, height 44 mm	
9056631	Centering tip 60°, Ø 2–35 mm, height 46 mm	
5361104	Hollow tip 90°, Ø 6–20 mm, height 56 mm	
3026166	USB keyboard - German	
3026167	USB keyboard - English	
5550400	Motorized tactile probe	T7W
5400211	Probe set	T7W
5550250	Renishaw tactile probe	SP25M
5550251	Probe set 1 for SP25	
5550252	Probe set 2 for SP25	
5550083	MarControl manual control panel	
5550085	Second monitor plus holder	
5550080	Housing plus package	
5550084	Industrial PC	
5550086	Panel PC included in measuring station scope	
5550091	Passive, controlled vibration isolation system	
5550100	MarWin complete package	Mar4D
5550460	OPTIONAL roughness measurement T7W for PLQ 4200	
5480638	Optional roughness software for AdvancedForm	
5360581	3D contour standard (without calibration certificate)	
9964316	Mahr calibration certificate for contour standard	
6980110	DAkkS / DKD calibration for contour standard	



Centering tip 60°
Ø 2 – 15 mm



Centering tip 60°
Ø 2 – 44 mm



Centering tip 60°
Ø 3 – 15 mm



Centering tip 60°
Ø 2 – 19 mm



Centering tip 60°
Ø 2 – 35 mm

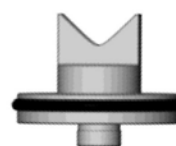

Hollow tip 90°
Ø 6 – 20 mm

MarSurf CD 140 AG 11: All-rounder with intelligent probe system

Mahr has launched a new contour measuring machine on the market – the MarSurf CD 140 AG 11. Its probe system has a measuring range of up to 70 mm and the stylus tips can be replaced quickly and without any tools – without having to recalibrate the system

The new contour measuring machine MarSurf CD 140 AG 11 enables the user to complete fast and precise measurements. Its flexible workpiece holder makes it particularly easy to handle, while users are also convinced by its extreme versatility – it can also be used to measure roughness. The intelligent probe system and magnetic stylus tip holder ensure the process to replace stylus tips without any tools is the most straightforward process to date. Operators can also choose from a comprehensive range of clamps and workpiece holders. The new MarSurf CD 140 AG 11 can be used in a static position or directly at the location of the workpiece.

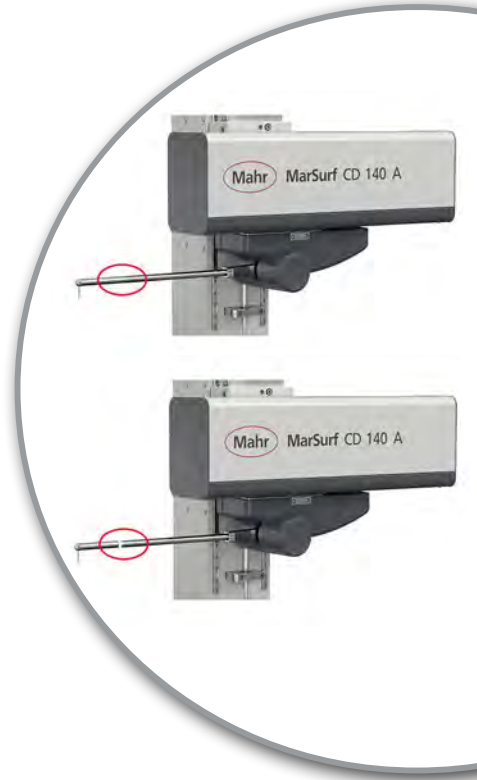

+ Advantages

- Comprehensive contour measurement functions – fast and simple
- Quick adjustment of the Z-axis with handles that are simple to operate
- Replacement of the stylus tip without any tools
- Travel speed in the X-axis of up to 200 mm/s
- Simple program creation or single measurement using MarWin
- Automatic evaluation, best adjustment of contours, CAD contour comparison, and a lot more
- Flexible support plate with 50 mm bore grid for KMG workpiece holder, amongst other
- Optionally expandable with option of roughness measurements ($R_z > 2 \mu\text{m}$)
- Measurement with double stylus

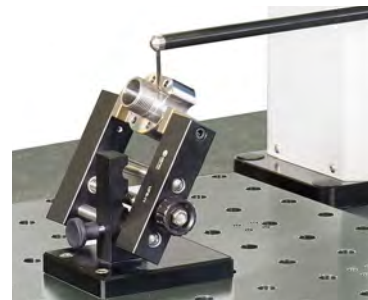

Plug-in guide stops and a wide range of standardized clamping devices as well as workpiece holders enable flexible positioning of your testpiece.

Manual quick adjustment

The fine adjustment is located in the Z-axis and moves the X-axis up and down.

Unique probe system

The probe system with a probe arm length of 350 mm enables a quick change of stylus tips without any tools and without having to recalibrate. The automatic tracing force selection guarantees the correct tracing force is selected when replacing several stylus tips.

X-axis with maximum measuring range

The high-speed X-axis is designed for a large measuring range of 140 mm.

Mahr MarSurf CD 140 A

Support plate also for large components

The 390 mm x 450 mm large plate with 50 mm matrix of holes is also suitable for large-volume workpieces. This provides a variety of flexible clamping options.

Generous traverse path

The Y-axis can be adjusted manually with a traverse path of 60 mm.

Ergonomic carrying handles

The handles on the side make it easy to transport the device.

MarSurf CD 140 AG 11

Contour measuring station

FEATURES

- Fast and precise measurements
- Easy to operate
- Use in a static position or directly at the location of the workpiece
- Manual fine adjustment of the drive unit in the Z-axis
- Stylus tip holder can be used without any tools
- A 390 mm x 450 mm support plate with 50 mm matrix of holes
- High-speed measuring X-axis (140 mm)
- Carrying handles for simple transport
- Quick adjustment of the Z-axis
- Unique adjustment lock secures the adjusted measuring setup
- 350 mm traverse path
- Fast change of stylus tips without tools and without having to recalibrate

Probe system

- Automatic measuring force selection of the correct tracing force when switching between several stylus tips
- Large measuring range – 70 mm
- Probe arm length – 350 mm
- Automated calibration routine for probe arms
- Simple calibration of standard and double probe arms possible
- Simple and repeatable calibration pattern positioning using 50 mm grid
- Magnetic probe arm holder enables probe arm change without tools
- Defined start position
- Aligned axis saving time during preparations

Software

- Simple and intuitive contour measurement and evaluation.
- The measuring assistant will guide you specifically to your measuring data.
- Many measuring tasks – for example for calculating radii, arc lengths, distances, angles etc. – are already pre-programmed for you.
- One particular highlight is the patented “tangential elements” function. This helps evaluate the tangential transitions between radii and straight lines easily and independently of the user.



TECHNICAL DATA

Order no.	6269033
Product type	CD 140 AG 11
Positioning speed	0.1 - 200 mm/s (in X)
Tracing distance (in X) end	140 mm
Measuring speed	0.1 - 10 mm/s
Guide deviation	1 µm / 140 mm
Probe arm length	350 mm
Resolution	19 nm
Measuring range in Z	70 mm
Measuring force (N)	4 mN to 30 mN, in Z+ and Z-, adjustable via software
Dimensions (T x B x H)	572 x 905 x 822 mm

APPLICATIONS

Mechanical engineering

- Bearings, threads, threaded rods, ball spindles, shafts, racks

Measurements close to production

- Semi-automatic contour measurement

Automotive Industry

- Steering, brake system, transmission, crankshaft, camshaft, cylinder head

Medical technology

- Contour of the hip and knee endoprostheses, contour on medical screws, contour on dental implan



For more information, please visit our website: www.mahr.com

ACCESSORIES

Order no.	Description	Type
6820020	DK accessory box including clamping elements	
6820022	Quick clamp swivel unit +90° / -55°	
6820023	Precision three-jaw chuck 50 mm	
6820001	Vee-block set AF 25	
6820002	Delta block set AF 25	
6820004	Screw jack set	
9059081	Precision clamp UZS 15	
6820000	Contour standard – contour B for support plate with 50 mm bore dimension	
6820010	Universal standard holder	
6820125	Contour standard KN 100	
6980110	DAkS/DKD calibration including calibration certificate	
9964316	Mahr calibration including calibration certificate	
6820003	Retainer set AF 25	
6820005	Manual chuck set, Alufix	
6820021	Base plate for DK systems	
6820024	Precision vise 25 mm	
6820025	Vee-block 90°	
6820026	Spring compressor with attachment	
6820027	Quick clamp with 45° angle element	
6820011	Adapter plate for 50 mm	
9000250	Centric clamp with spread up to 45 mm	
9000249	Universal coupling including adapter plate	
9000248	Parallel vise with spread up to 40 mm	
9026049	Table plate 740 x 430 set	



Vee-block set AF 25



Delta block set AF 25



Screw jack set



Precision clamp UZS 15



Contour standard KN 100



2-sphere calibration standard



For more information, please visit our website: www.mahr.com

Measuring system MFU 200: one machine – **two ultra precise versions**

The proven Mahr MFU measuring system is available in two versions for different applications: MFU 200 for testing form and position of rotationally symmetrical workpieces and MFU 200-3D for measuring components in the optical industry.

MFU has stood for accuracy and stability for many years. Thanks to its universality and ultraprecision it has qualified as a highly precise reference measuring system. The highest measuring certainty increases the tolerance margin for production, optimizes processes, and ultimately reduces production costs.



Advantages of the MFU 200

- High precision thanks to nanometer machine accuracy for workpiece tolerances of 0.5 µm
- Simple to operate providing fast and simple access to the measuring result in just a few seconds – even for a new workpiece
- User-friendly software platform MarWin for form, gear, contour, shaft, roughness – learn once, apply again and again.
- Future-proof thanks to software upgrade options: lead, roughness, contour, chatter marks, Capto, commutators



Additional advantages of the MFU 200-3D

- Equipped with optical IPS sensor and MarOpto clamp set for the qualification of spheres, aspheres, and freeforms in the optical industry
- Clear and user-friendly software platform AsphericLib for measuring and evaluating spheres and aspheres
- Measure freeforms flexibly with the clearly laid-out Aspheric Lib software platform and evaluate them using the Anyshape software
- Optimum performance: Form deviations <100 nm (PV) in 2D and 3D

Maximum precision

The MFU 200 concept ensures accuracy in the nanometer range.

Most reliable repeatability

With an absolute positioning accuracy of 0.001 mm within the space, this provides the best possible reproducibility and process capability.

Measurements without user intervention

The fully automated measuring process with motorized centering and tilting means that user intervention is no longer required thus ensuring process stability.



Shorter measuring times

The high-speed C-axis accelerates the measurements considerably thus increasing productivity.

High-performance checks

The motorized T7W measuring probe and the probe arms arranged in the shape of a star combined tacitly and optically with the IPS sensor allows for flexible scanning and user-friendly operation.

MFU 200

Reference form measuring station

DESCRIPTION

- Reference form measuring station in a new dimension
- The journey from high precision measuring axes to competent measurements is often a long one that the **MFU 200** has mastered completely. Only the **MFU 200** has integrated reference elements for the real-time spatial compensation of geometric deviations, recording all profiles as high precision 3D coordinates.
- For decades, **MarForm** measuring machines have been recognized for their accuracy and stability. The new **MFU 200** was developed with the claims of testing the shape and position features of product parts in a one liter measuring volume close to the production area and at a reasonable cost. In doing so, it has taken our long experience into a new dimension.
- **MFU 200** is a precision reference form measuring center. Its exceptionally low measurement uncertainty increases the tolerance margin for your production processes, thereby lowering production costs.

The form measuring center consists of the following components:

- Circular roundness measuring axis (C)
- Motorized centering and tilting table (X, Y, A, B)
- Roundness measuring axis circular (C- high-speed, up to 200 U/min)
- Vertical straightness measuring axis (Z)
- Horizontal straightness measuring axis (X)
- Tangential multifunction axis (Y)
- Motorized length measuring probe T7W
- MarWin Evaluation Software for form and position features
- The consistent separation of control and evaluation makes **MFU 200** future-proof and expandable. New language versions can be implemented just as effectively as special evaluations and new standards. The **MFU 200** is also already prepared for the use of optical sensor technology, the MarForm IPS, and can thus also measure micro surface structures with high precision.
- In short: **MFU 200** brings form measuring machines for inspection rooms and production areas into a new dimension.



TECHNICAL DATA

Order no.	5440580
Type	MFU 200
Monitor	19" TFT monitor (touchscreen monitor)
Control panel	MCP 12
Motorized measuring probe	T7W
Probe arm	60 mm ø 1.0, ruby, M2, 60 degrees, prepared for the connection of the optical sensor IPS15
Pitch error	Pitch error of the C-/Z-/X-axis is calibrated

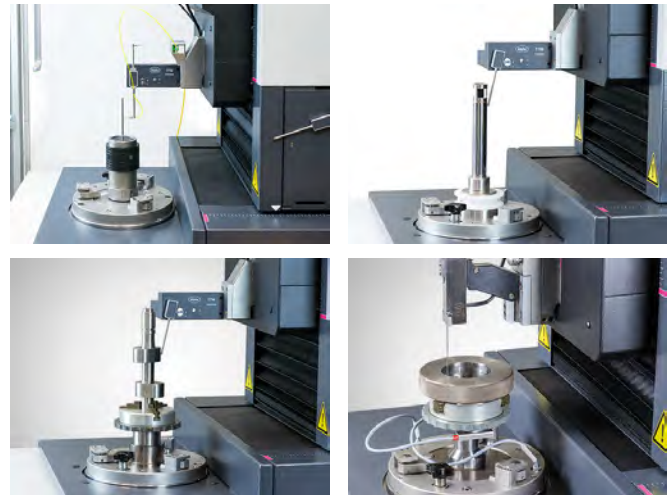

APPLICATIONS

- Checking product parts for form and position features
- Roundness, concentricity / coaxiality, cylindricity, concentricity, axial runout, axial runout, total runout, straightness, parallelism, squareness, inclination, flatness, conicity, diameter, taper, Fourier analysis (waviness analysis), line profile, area profile, cam shape
- Recording of all profiles as high-precision 3D coordinates with real-time
- Spatial compensation of geometric deviations
- Scanning of surfaces, roughness evaluation
- Scanning and evaluation of contours and shapes

ACCESSORIES

Order no.	Description
	Hardware (mandatory position)::
9028023	Calibration sphere Ø 15 mm with Mahr calibration certificate
9064901	with MarWin PC with WINDOWS 10, multi-lingual
3026857	Wireless keyboard K400 plus Logitec, German
3026858	Wireless keyboard K400 plus Logitec, English
6710620	Three-jaw chuck with flange, Ø 100 mm (NEW VERSION!). not to be used with basic holder
3017216	Basic holder for quick clamp/retriever interface
9004831	Rim chuck with three jaws, Ø 50 with column and flange for MFU quick clamp
	Software (optional/mandatory position):
5480312	ProfessionalForm software
5480311	AdvancedForm software
	Optical sensor for MFU 200 plus:
5400275	Interferometric controller with IPS15, including rack to hold the IPS box



Three-jaw chuck with column



Calibration sphere



Rim chuck



Rim chuck with collet chucks



For more information, please visit our website: www.mahr.com

MFU 200-3D

High-precision 3D measuring station for spheres, aspheres and freeforms

DESCRIPTION

- The MFU 200-3D is a universal, highly accurate measuring machine for the automatic measurement of spheres, aspheres, freeforms, and special lenses and was developed by Mahr to enable optical components to be tested quickly in 2D and 3D close to the production area.

Accuracy

- With a measurement uncertainty of less than 100 nm PV, the measuring instrument is perfectly designed to meet your process optimization requirements.

Flexibility

- The MFU 200-3D can perform optical and tactile measurements of surfaces. An interferometric point sensor is used for the optical measurement. There is a wide range of probe arms for tactile measurements. Rotationally symmetrical objects with a kurtosis of up to 45°, off-axis and freeforms up to 28° can be measured.



TECHNICAL DATA

Order no.	5440581
Type	MFU 200-3D
Monitor	19" TFT monitor (touchscreen monitor)
Control panel	MCP 12
Motorized measuring probe	T7W
Optical measuring probe	IPS
Probe arm	90° angled, ruby ball ø 3mm, incl. connection for optical sensor
Pitch error	Pitch error of the C-/Z-/X-axis is calibrated
Calibration set and Basic clamp set	included
MFU 200-3D Aspheric software package	included
MFU 200-3D Anyshape software option	optional

ACCESSORIES

Order no.	Description
5440468	Hydraulic expansion chuck ø 25 mm for quick clamp system
5440471	Three-jaw chuck for quick clamp system
5440472	Vise for quick clamp system
5440473	Index plate for quick clamp system
5440474	Mounting plate
3028108	Adapter for hydraulic expansion chuck 25 mm – 12 mm
9058047	Clamps for 200 mm lenses

Clamp set

Universal design for every purpose – the design ensures you are well equipped even if you have a broad range of components.

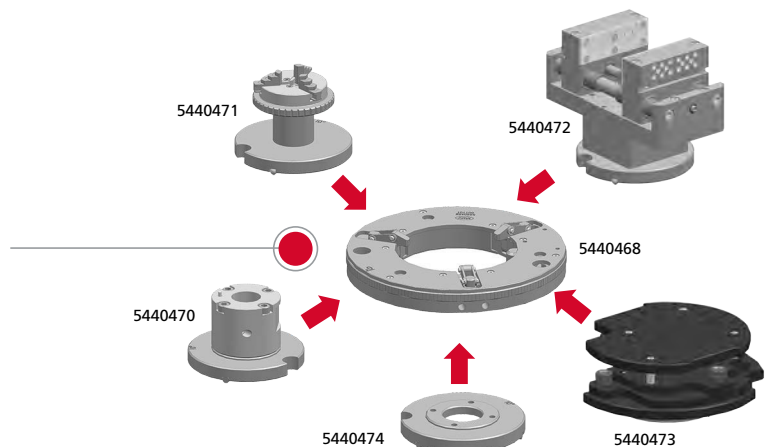

MFU 200-3D

High-precision 3D measuring station for spheres, aspheres and freeforms

Advantages:

- Automatic tilting and centering – user-independent positioning, centering, and alignment of measuring objects
- Active tracking – automatic measurement of unknown geometries; the sensor (optical and tactile) automatically follows the surface via the machine controller
- Probe combination – combination of optical sensors and tactile probes can be combined in one probe system; can be moved in space (360°)
- Closed loop integration in the production process (grinding/polishing) perfect for transmissive optics (tilt/centering error designation)



MEASURING TASKS & SOFTWARE

Flexible measuring tasks in one machine

- Form
- Contour
- Roughness
- Axis offset of lenses
- Radial runout error
- Tilt and centering error of the optics

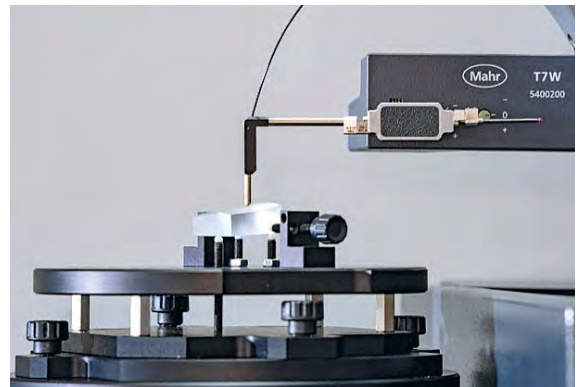

SOFTWARE

Special software package for your requirements

- AsphericLib software for measuring and evaluating spheres and aspheres
- SW analysis of the tool for the future – freeform measurement and evaluation

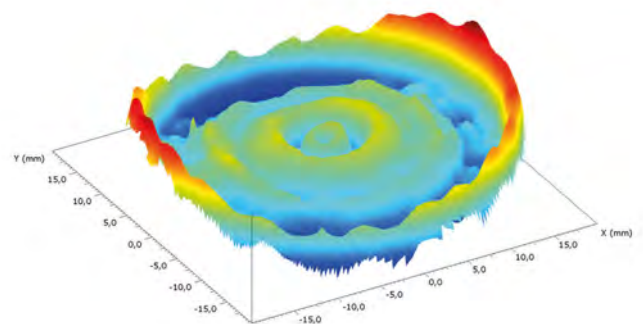

For more information, please visit our website: www.mahr.com



COMPLETE METALWORKING SOLUTIONS

(800) 991-4225

www.ahbinc.com

ISO Certified

customerservice@ahbinc.com

The Mahr logo consists of the word 'Mahr' in a bold, black, sans-serif font, enclosed within a red oval border.

Mahr GmbH

Carl-Mahr-Straße 1
37073 Göttingen
Germany

Reutlinger Straße 48
73728 Esslingen
Germany

Tel.: +49 551 7073 800
info@mahr.com
www.mahr.com

© Mahr GmbH

We reserve the right to make changes to our products, especially due to technical improvements and further developments. All illustrations and technical data are therefore subject to change.

3765844 | 04.2022