

SMAHRT Tools

with Integrated Wireless Tools



PRECISION GAGES

Reliable wireless measuring results,
while being completely mobile.

This is what **EXACTLY** means to us!

AHB
TOOLING & MACHINERY

COMPLETE METALWORKING SOLUTIONS
(800) 991-4225 www.ahbinc.com
ISO Certified customerservice@ahbinc.com

- 0 +
Mahr
EXACTLY



Receiving reliable measuring results
while being completely mobile
This is what EXACTLY means to us!

With Mahr's new Integrated Wireless, you receive an Integrated Wireless data transmission system for the price of a cable. Data acquisition is now even simpler with the ability to transmit your measuring data directly into Microsoft® Excel or your CAQ/SPC Software package, without being tangled with excessive cables.



TABLE OF CONTENTS

SMAHRT Metrology	2
SMAHRT Connectivity	4
MarCal Calipers	
Overview MarCal Caliper16 EWRI	6
MarCal 16 EWRI Digital Caliper	8
MarCal 16 EWRI-C / 16 EWRI-H Digital Caliper for Special Applications	9
Overview MarCal Digital Caliper for Special Applications	10
MarCal 16 EWRI-V Digital Universal Caliper	12
MarCal 30 EWRI / 30 EWRI-D / 30 EWRI-N Digital Depth Gage	13
Micromar Micrometers	
Overview Micromar 40 EWRI	16
Micromar 40 EWRI Digital Micrometer	18
MarCator Digital Indicators	
Overview MarCator 1086 Ri	20
MarCator 1086 Ri / 1086 WRi Digital Indicators	21
Overview MarCator 1087 Ri	24
MarCator 1087 Ri / 1087 BRi Digital Indicators	25
MarConnect Wireless Data Transmission	
MarConnect e-Stick	28
MarConnect 16 EWe / 2000 e / RS232 e / 1082 e	29

SMAHRT METROLOGY



MARCONNECT
**PATENTED INNOVATIVE
WIRELESS TECHNOLOGY**

WIRELESS DEVICES FOR MORE MEASURING CONVENIENCE

Mahr's new devices with Integrated Wireless transmitters are designed for user-friendly, practical and cost-effective use in your factory. They will make your measurement recording processes much faster and more efficient.

Mahr's caliper, micrometers and dial indicators herald a new era:

Mahr has enhanced its MarCal, Micromar and MarCator ranges with state-of-the-art patented technology.

These special measuring instruments:

- Have a transmitter directly integrated in the measuring instrument
- Are energy efficient and do not require a separate battery



BEFORE

Conventional measuring station –with cable connection

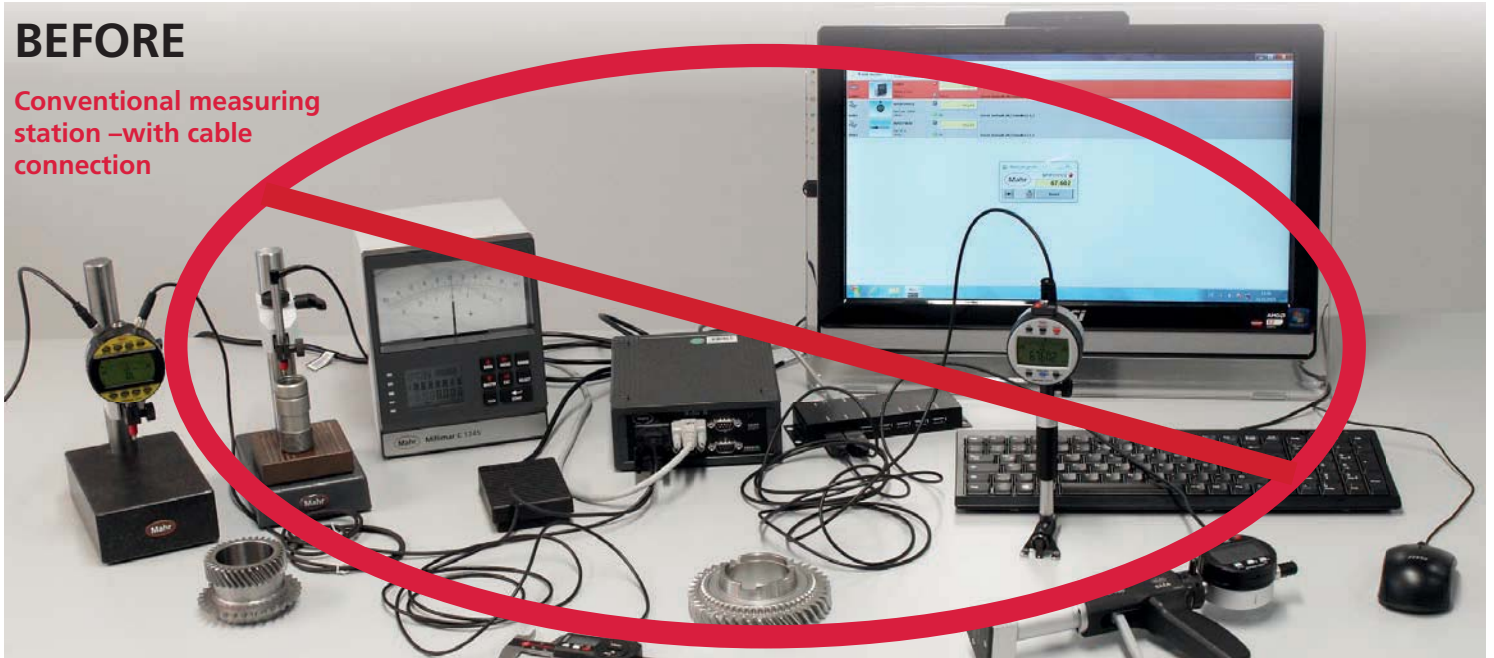

BENEFIT FROM THESE ADVANTAGES:

Data Link	Integrated Wireless	Cable Monnection
Range	Max. 6 m	Max. 2 m (without extension cable)
Freedom of Movement and Operation	Fully autonomous measuring without restrictions	Limited freedom of movement, especially at measuring stations with multiple measuring instruments
Wear	No risk of damage or wear	Risk of: - cable breaks, cable kinks - embrittlement from oil, etc.
Interface	1 affordable i-Stick receiver for 8 measuring instruments (maximum 4 i-Sticks per PC) Free MarCom Professional Software interface	One cable is required for each measuring instrument Additional hardware interface must be purchased
Safety	Visual feedback of successful transmission on display of measuring instrument, or error message	No feedback from transmission Unplugged cables or cable breaks are not identified

AFTER

Innovative measuring station – with Integrated Wireless



SMAHRT CONNECTIVITY

Sending Measuring Results

Data

Integrated Wireless Technology



Retrofitted Wireless Technology



Cable Technology

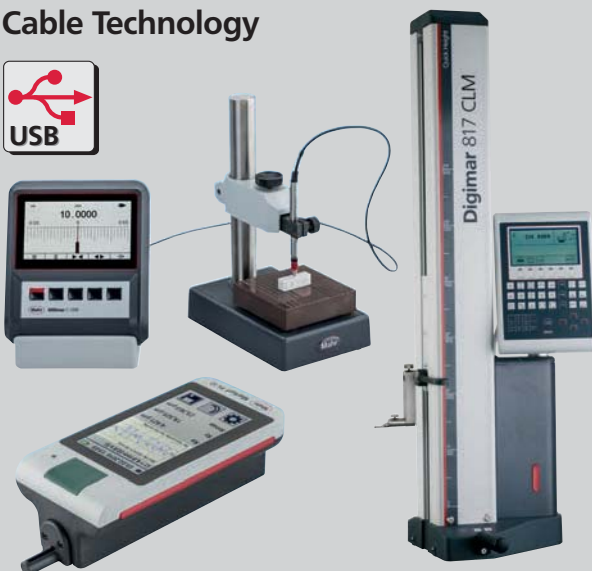

MarCom Pro
Free to
www.mahr.com

Scan the QR code
to watch simple and
practical applications



HIGHLIGHT: Our contribution to the 4th Industrial Revolution: You can now download MarCom Professional Software free of charge!

Transfer

Data Processing

Professional 5.2
Download:
com/marcom

Virtual Interface
Box

CAQ-/SPC-Software



Intelligent Excel
Interface

Microsoft® Excel

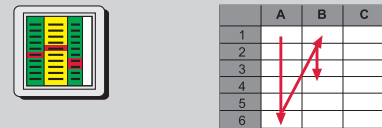

Keyboard Emulation

Any Windows® Software



Text File

Flexible Data Processing

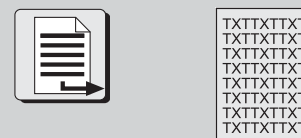

MarCal | The New Generation

Waterproof Digital Calipers with the Reference System and Integrated Wireless

Reference Lock Protection

- Zero position is secured
- Operating error is not possible

The digital caliper MarCal 16 EWRI Reference is equipped with a LOCK function. With this key lock, the zero position is secured and operating error is avoided.



3 Year Battery Life

The new Reference System is just as energy efficient as when the caliper is in standby mode; almost no power is required, therefore extending the life of the battery up to 3 years*.

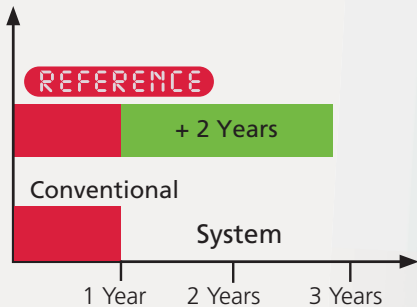

High Quality Guideways

Only MarCal calipers have lapped guideway surfaces to guarantee an even and sensitive run of the slide. Additionally, the service life of the caliper increases, as compared to a ground guideway, due to the greater contact area on the guideway surface.



Guideway Surface

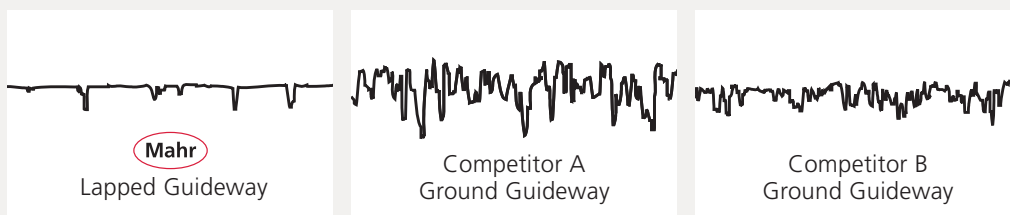

MarConnect Integrated Wireless



With Mahr's new Integrated Wireless, you receive an Integrated Wireless data transmission system for the price of a data cable. Data acquisition with digital calipers is now even simpler with the ability to transmit your measured data directly into Microsoft® Excel or via a keyboard code into any Windows program. Data transmission is now possible without the problems of being caught up between cables.

Secure Data Transmission



With Integrated Wireless, your data will be transferred to the PC and is confirmed with a message on the digital tool's display confirming the sent data has been transferred correctly and/or whether the tool is within reception range of the i-Stick.



Ergonomic Design

The nonslip thumb support of the MarCal16 EWRi ensures secure handling and reliable measuring results, even in contaminated working conditions.



The high contrast display with 11 mm sized digits enables accurate and fatigue-free reading of the measurement results.

Strong Resistance Against Dust, Coolant and Lubricants



Due to the outstanding protection against dust, water, coolant and lubricants, the digital caliper MarCal 16 EWRi Reference delivers precise and secure results, even in the most difficult workshop conditions. The finished plastic components have a powerful chemical resistance.

Code Initials	IP	International Protection
First Digit	6	Dustproof
Second Digit	7	Protected Against Temporary Immersion in Water



MarCal 16 EWRI | Digital Caliper

Functions

- ON/OFF
- AUTO-ON / OFF
- HOLD (storage of measured values)
- RESET (set display to zero)
- PRESET (for entering a numerical value)
- Reversal of counting direction
- mm/in
- LOCK function (key lock)
- DATA (data transmission)
- High contrast digital display
- Locking thumbscrew
- Lapped guideway
- Measuring blade for inside measurements
- Slide and beam made of hardened stainless steel
- Step measuring function
- Immediate measurements due to the Reference System
- Raised guideways for protection of the scale
- Strong resistance against dust, coolants and lubricants
- Dirt wipers integrated in the slide
- MarCom Professional Software free download:
www.mahr.com/marcom (only for Mahr data cables and wireless systems with USB and RS232 interface)
- **Digit Height:** 11 mm
- **Data Interface:** Integrated Wireless
- **Energy Supply:** Battery life approximately 3 years (approximately 1/2 year in wireless mode)
- **IP Protection Category:** IP 67
- **Package Contains:** Battery, Instruction Manual, Case



Technical Data

Order No.	Product Type	Measuring Range	Resolution	Error Limit	Standard	Depth Rod	Friction Wheel
4103400	16 EWRI	0 - 150 mm / 0 - 6 in	0,01 mm / 0.0005 in	0,03 mm	DIN 862	Round	
4103401	16 EWRI	0 - 150 mm / 0 - 6 in	0,01 mm / 0.0005 in	0,03 mm	DIN 862	Round	•
4103402	16 EWRI	0 - 150 mm / 0 - 6 in	0,01 mm / 0.0005 in	0,03 mm	DIN 862	Rectangular	
4103403	16 EWRI	0 - 150 mm / 0 - 6 in	0,01 mm / 0.0005 in	0,03 mm	DIN 862	Rectangular	•
4103404	16 EWRI	0 - 200 mm / 0 - 8 in	0,01 mm / 0.0005 in	0,03 mm	DIN 862	Rectangular	
4103405	16 EWRI	0 - 200 mm / 0 - 8 in	0,01 mm / 0.0005 in	0,03 mm	DIN 862	Rectangular	•
4103406	16 EWRI	0 - 300 mm / 0 - 12 in	0,01 mm / 0.0005 in	0,04 mm	Factory Standard		
4103407	16 EWRI	0 - 300 mm / 0 - 12 in	0,01 mm / 0.0005 in	0,04 mm	Factory Standard		•

Order No.	a	b	c	d	e
4103400	10 mm	40 mm	16 mm	235 mm	16 mm
4103401	10 mm	40 mm	16 mm	235 mm	16 mm
4103402	10 mm	40 mm	16 mm	235 mm	16 mm
4103403	10 mm	40 mm	16 mm	235 mm	16 mm
4103404	10 mm	50 mm	19 mm	285 mm	16 mm
4103405	10 mm	50 mm	19 mm	285 mm	16 mm
4103406	14 mm	64 mm	19 mm	388 mm	16 mm
4103407	14 mm	64 mm	19 mm	388 mm	16 mm

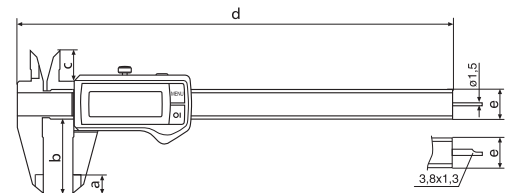

Accessories

Order No.	Product Description	Product Type
4102020	Depth bridge (75 mm x 7 mm)	16 Em
4102220	Receiver including MarCom Standard Software	i-Stick
4102520	Battery 3 V, CR 2032	

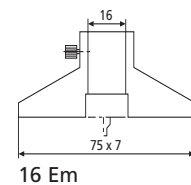

i-Stick

MarCal 16 EWri-C / 16 EWri-H | Digital Caliper for Special Applications

Functions

- ON/OFF
- AUTO-ON / OFF
- HOLD (storage of measured values)
- RESET (set display to zero)
- PRESET (for entering a numerical value)
- Reversal of counting direction
- mm/in
- LOCK function (key lock)
- DATA (data transmission)
- High contrast digital display
- Locking thumbscrew
- Lapped guideway
- Measuring blade for inside measurements
- Slide and beam made of hardened stainless steel
- Step measuring function
- Immediate measurements due to the Reference System
- Raised guideways for protection of the scale
- Strong resistance against dust, coolants and lubricants
- Dirt wipers integrated in the slide
- MarCom Professional Software free download:
www.mahr.com/marcom
(only for Mahr data cables and wireless systems with USB and RS232 interface)
- **Digit Height:** 11 mm
- **Data Interface:** Integrated Wireless
- **Energy Supply:** Battery life approximately 3 years (approximately 1/2 year in wireless mode)
- **IP Protection Category:** IP 67
- **Package Contains:** Battery, Instruction Manual, Case

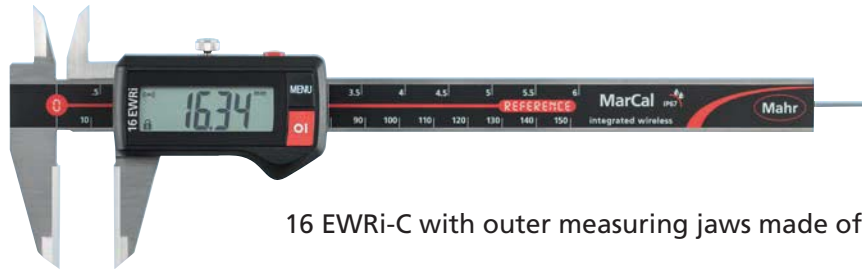

16 EWri-C with outer measuring jaws made of ceramic

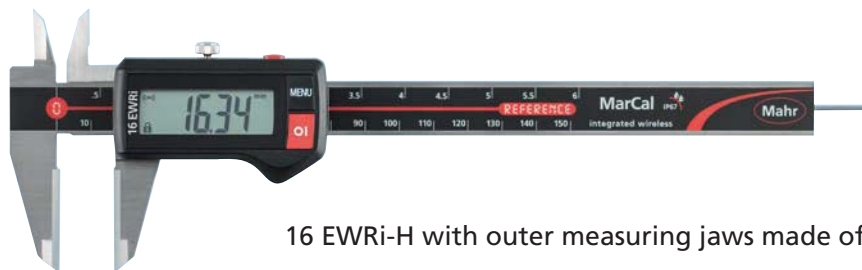

16 EWri-H with outer measuring jaws made of carbide

Technical Data

Order No.	Product Type	Measuring Range	Resolution	Error Limit	Standard	Depth Rod
4103372	16 EWri-C ceramic	0 - 150 mm / 0 - 6 in	0,01 mm / .0005 in	0,03 mm	DIN 862	Round
4103373	16 EWri-H carbide	0 - 150 mm / 0 - 6 in	0,01 mm / .0005 in	0,03 mm	DIN 862	Round

Order No.	a	b	c	d	e
4103372	10 mm	40 mm	16 mm	235 mm	16 mm
4103373	10 mm	40 mm	16 mm	235 mm	16 mm

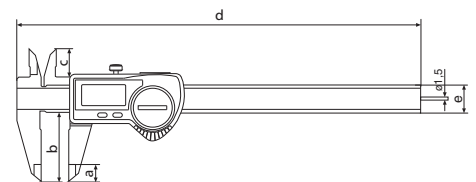

Accessories

Order No.	Product Description	Product Type
4102220	Receiver including MarCom Standard Software	i-Stick
4102520	Battery 3 V, CR 2032	



i-Stick

MarCal Digital Caliper for Special Applications

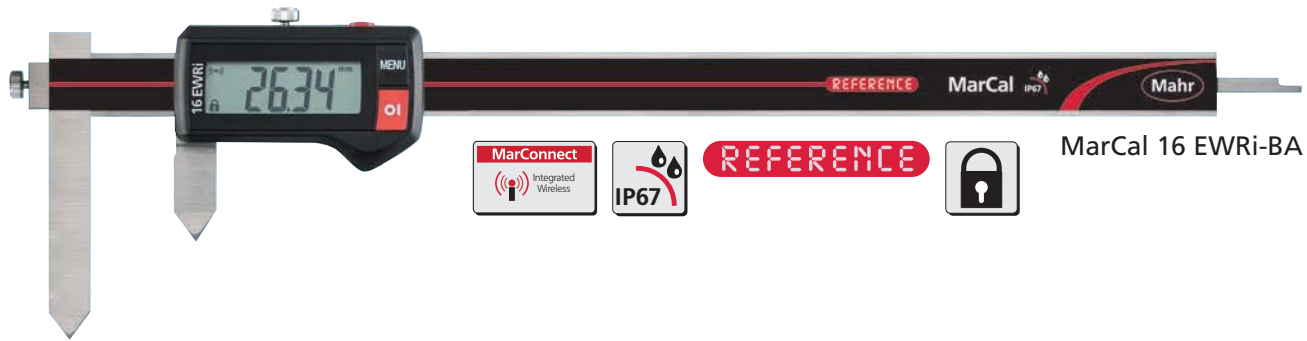

MarCal 16 EWRI-BA

MarCal 16 EWRI-AA

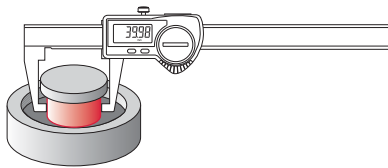

Inward Offset Jaws

MarCal 16 EWRI-AI

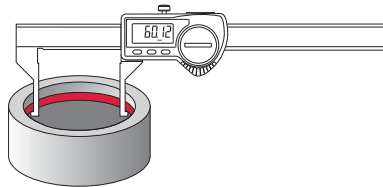

Outward Pointed Jaw

MarCal 16 EWRI-AR

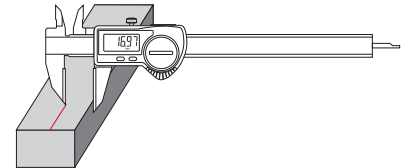

Scribing

MarCal 16 EWRI-BA

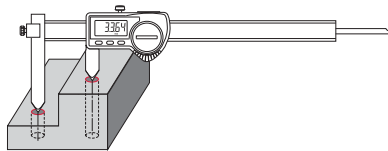

Adjustable Hole Center

MarCal 16 EWRI-LI

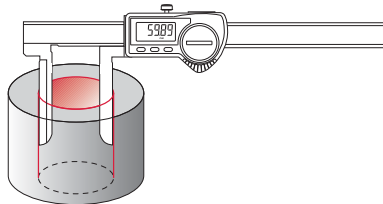

Long Measuring Jaw

MarCal 16 EWRI-NA

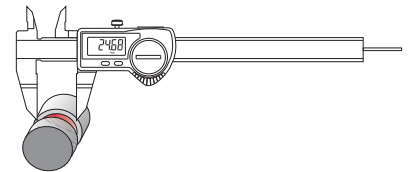

Key Seat

MarCal 16 EWRI-RW

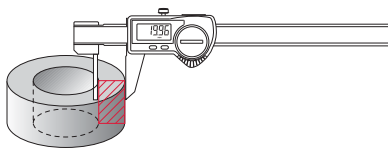

Well Thickness Jaws

MarCal 16 EWRI-S

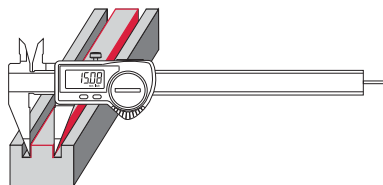

Pointed

MarCal 16 EWRI-SA

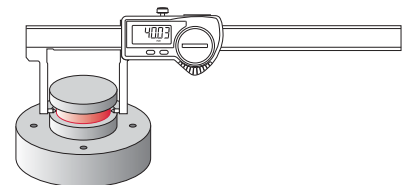

Inward Pointed Jaws

MarCal 16 EWRI-SI

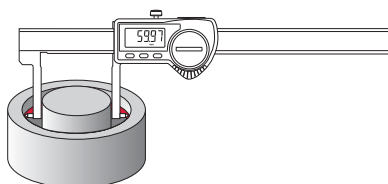

Outward Offset Jaws

MarCal 16 EWRI-SM

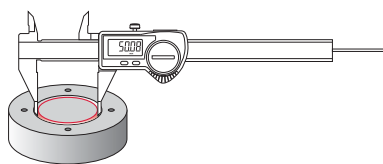

Narrow Jaws

MarCal 16 EWRI-VS

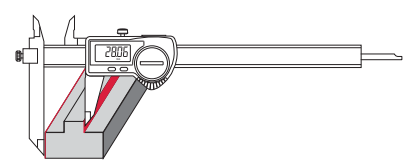

Adjustable Jaws

MarCal Digital Caliper for Special Applications

Functions

- ON/OFF
- AUTO-ON / OFF
- HOLD (storage of measured values)
- RESET (set display to zero)
- PRESET (for entering a numerical value)
- Reversal of counting direction
- mm/in
- LOCK function (key lock)
- DATA (data transmission)
- High contrast digital display
- Locking thumbscrew
- Lapped guideway
- Measuring blade for inside measurements
- Slide and beam made of hardened stainless steel
- Step measuring function
- Immediate measurements due to the Reference System
- Raised guideways for protection of the scale
- Strong resistance against dust, coolants and lubricants
- Dirt wipers integrated in the slide
- MarCom Professional Software free download:
www.mahr.com/marcom
(only for Mahr data cables and wireless systems with USB and RS232 interface)
- **Digit Height:** 11 mm
- **Data Interface:** Integrated Wireless
- **Energy Supply:** Battery life approximately 3 years (approximately ½ year in wireless mode)
- **IP Protection Category:** IP 67
- **Package Contains:** Battery, Instruction Manual, Case

Technical Data

Order No.	Product Type	Measuring Range	Resolution	Error Limit	Depth Rod
4103379	16 EWRI-AA	0 - 150 mm / 0 - 6 in	0,01 mm / 0.0005 in	0,03 mm	None
4103380	16 EWRI-AI	10 mm - 160 mm / 0.4 in - 6.3 in	0,01 mm / 0.0005 in	0,03 mm	None
4103382	16 EWRI-AR	0 - 200 mm / 0 - 8 in	0,01 mm / 0.0005 in	0,03 mm	Rectangular
4103384	16 EWRI-BA	10 mm - 210 mm / 0.4 in - 8.3 in	0,01 mm / 0.0005 in	0,04 mm	Rectangular
4103385	16 EWRI-LI	10 mm - 200 mm / 0.4 in - 8 in	0,01 mm / 0.0005 in	0,05 mm	None
4103374	16 EWRI-NA	0 - 150 mm / 0 - 6 in	0,01 mm / 0.0005 in	0,03 mm	Round
4103381	16 EWRI-RW	0 - 150 mm / 0 - 6 in	0,01 mm / 0.0005 in	0,05 mm	None
4103375	16 EWRI-S	0 - 150 mm / 0 - 6 in	0,01 mm / 0.0005 in	0,03 mm	Round
4103377	16 EWRI-SA	0 - 140 mm / 0 - 5.5 in	0,01 mm / 0.0005 in	0,03 mm	None
4103378	16 EWRI-SI	20 mm - 170 mm / 0.8 in - 6.7 in	0,01 mm / 0.0005 in	0,03 mm	None
4103376	16 EWRI-SM	0 - 150 mm / 0 - 6 in	0,01 mm / 0.0005 in	0,03 mm	Round
4103383	16 EWRI-VS	0 - 200 mm / 0 - 8 in	0,01 mm / 0.0005 in	0,04 mm	Rectangular

Accessories

Order No.	Product Description	Product Type
4102220	Receiver including MarCom Standard Software	i-Stick
4102520	Battery 3 V, CR 2032	



i-Stick



For detailed information about the special caliper line, visit www.mahr.com

MarCal 16 EWRI-V | Digital Universal Caliper

Functions

- AUTO-ON / OFF
- ON/OFF
- DATA (data transmission via connection cable)
- HOLD (storage of measured values)
- PRESET (for entering a numerical value)
- RESET (set display to zero)
- mm/in
- LOCK function (key lock)
- High contrast digital display
- Locking thumbscrew
- Lapped guideway
- Measuring blade for inside measurements
- Slide and beam made of hardened stainless steel
- Step measuring function
- Immediate measurements due to the Reference System
- Raised guideways for protection of the scale
- Strong resistance against dust, coolants and lubricants
- Dirt wipers integrated in the slide
- MarCom Professional Software free download:

www.mahr.com/marcom

(only for Mahr data cables and wireless systems with USB and RS232 interface)

- **Digit Height:** 11 mm
- **Data Interface:** Integrated Wireless
- **Energy Supply:** Battery life approximately 3 years (approximately ½ year in wireless mode)
- **IP Protection Category:** IP 67
- **Package Contains:** Battery, Instruction Manual, Case, Setting Gage for Inside Measurement 16 Eel, Measuring Force Device 16 Ec, Depth Measuring Bridge 16 Em, Anvils for Outside Measurement 16 Eea 1–3, Anvils for Inside Measurement 16 Eei 1–3

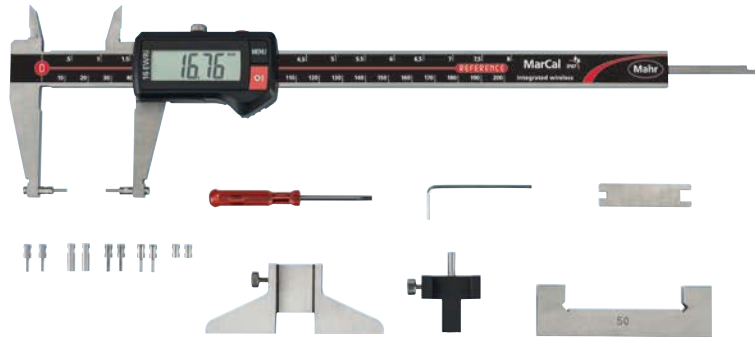

Application:

- Used as standard caliper (four measuring directions), with standard accessories for measuring recesses, grooves, etc.
- Used with special accessories for measuring threads, bores and gears



Technical Data

Order No.	Product Type	Measuring Range	Resolution	Error Limit	Standard	Depth Rod	Including Accessories
4118907	16 EWRI-V	0 - 200 mm / 0 - 8 in	0,01 mm / 0.0005 in	0,03 mm	DIN 862	Rectangular	•

Order No.	b	c	d	e
4118907	48 mm	16,5 mm	285 mm	16 mm

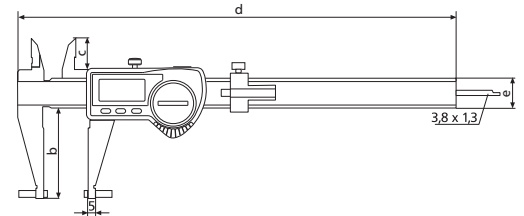

Accessories

Order No	Product Description	Product Type
4102020	Depth bridge (75 mm x 7 mm)	16 Em
4102220	Receiver including MarCom Standard Software	i-Stick
4102520	Battery 3 V, CR 2032	
4118810	Anvil for outside measurement (3,5 x 12 mm)	16 Eea 1
4118811	Anvil for outside measurement (1,5 x 6 mm)	16 Eea 2
4118812	Anvil for outside measurement (3,5 x 6 mm)	16 Eea 3
4118813	Anvil for inside measurement (3,5 x 6 mm)	16 Eei 1
4118814	Anvil for inside measurement (1,5 x 6 mm)	16 Eei 2
4118815	Anvil for inside measurement (3,5 x 6 mm)	16 Eei 3
4118816	Anvil for inside measurement (4 x 2,5 mm)	16 Eei 4
4118817	Setting gage for inside measurement (50 mm)	16 Eel
4118818	Measuring force device	16 Ec
4118819	Mounting attachment for thread anvils 844 TG/844Tr and ball anvils 844 Tk	16 Eab
4879602	Screws M2x8	

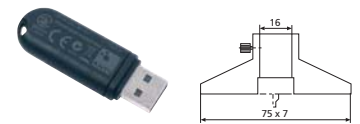

i-Stick

16 Em

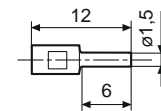

16 Eea 2

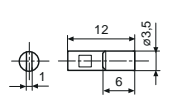

16 Eea 3

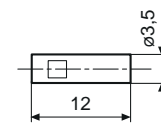

16 Eei 1

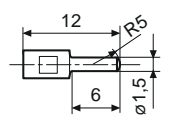

16 Eei 2

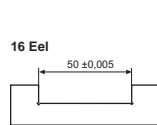

16 Eel

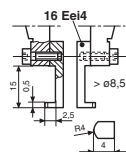

16 Eei 4

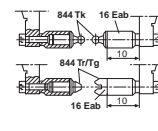

16 Eab

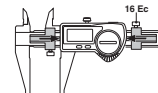

16 Ec

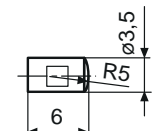

16 Eei 1

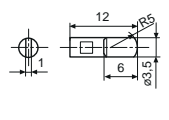

16 Eei 3

MarCal 30 EWRI | Digital Depth Gage

Functions

- ON/OFF
- AUTO-ON / OFF
- RESET (set display to zero)
- mm/in
- PRESET (for entering a numerical value)
- LOCK function (key lock)
- HOLD (storage of measured values)
- Reversal of counting direction
- DATA (data transmission)
- High contrast digital display
- Locking thumbscrew
- Lapped guideway
- Measuring surfaces made of steel
- Slide and beam made of hardened stainless steel
- Immediate measurements due to the Reference System
- Raised guideways for protection of the scale
- Strong resistance against dust, coolants and lubricants
- Dirt wipers integrated in the slide
- **Digit Height:** 11 mm
- **Data Interface:** Integrated Wireless
- **Energy Supply:** Battery life approximately 3 years (approximately 1/2 year in wireless mode)
- **IP Protection Category:** IP 67
- **Package Contains:** Battery, Instruction Manual, Case



REFERENCE



Technical Data

Order No.	Product Type	Measuring Range	Resolution	Error Limit
4126755	30 EWRI	0 - 150 mm / 0 - 6 in	0,01 mm / 0.0005 in	0,03 mm
4126754	30 EWRI	0 - 200 mm / 0 - 8 in	0,01 mm / 0.0005 in	0,03 mm
4126756	30 EWRI	0 - 300 mm / 0 - 12 in	0,01 mm / 0.0005 in	0,04 mm
4126757	30 EWRI	0 - 500 mm / 0 - 20 in	0,01 mm / 0.0005 in	0,05 mm

Order No.	a	b
4126755	234 mm	100 mm
4126754	284 mm	100 mm
4126756	384 mm	150 mm
4126757	584 mm	150 mm

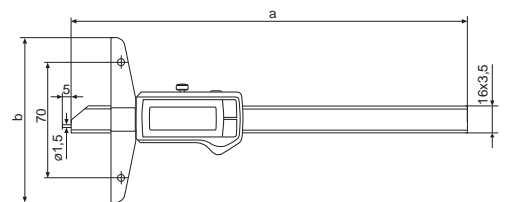

Accessories

Order No.	Product Description	Product Type
4102220	Receiver including MarCom Standard Software	i-Stick
4102520	Battery 3 V, CR 2032	
4125611	Anvil (4 mm)	30 ESa
4126510	Cross beam extension (300 mm)	30 EXm
4126511	Cross beam extension (200 mm)	30 EXm



i-Stick

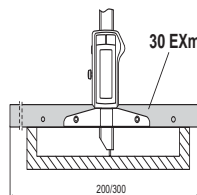

30 EXm

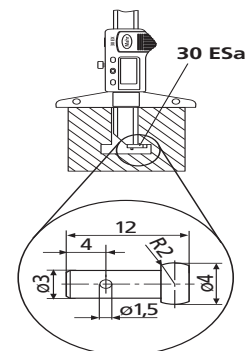

30 ESa

MarCal 30 EWri-D | Digital Depth Gage

Functions

- ON/OFF
- AUTO-ON / OFF
- mm/in
- LOCK function (key lock)
- RESET (set display to zero)
- PRESET (for entering a numerical value)
- DATA (data transmission)
- HOLD (storage of measured values)
- High contrast digital display
- Locking thumbscrew
- Lapped guideway
- Measuring surfaces made of steel
- Slide and beam made of hardened stainless steel
- Immediate measurements due to the Reference System
- Raised guideways for protection of the scale
- Strong resistance against dust, coolants and lubricants
- Dirt wipers integrated in the slide
- **Digit Height:** 11 mm
- **Data Interface:** Integrated Wireless
- **Energy Supply:** Battery life approximately 3 years (approximately 1/2 year in wireless mode)
- **IP Protection Category:** IP 67
- **Package Contains:** Battery, Instruction Manual, Case



REFERENCE



Application:

- Measuring groove widths and distances between grooves

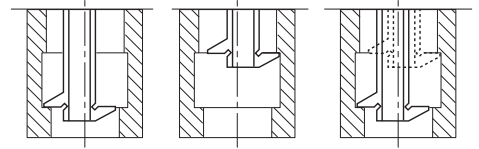

Technical Data

Order No.	Product Type	Measuring Range	Resolution	Error Limit
4126533	30 EWri-D	0 - 200 mm / 0 - 8 in	0,01 mm / 0.0005 in	0,03 mm
4126534	30 EWri-D	0 - 300 mm / 0 - 12 in	0,01 mm / 0.0005 in	0,04 mm

Order No.	a	b	c
4126533	281 mm	100 mm	12 mm
4126534	381 mm	150 mm	12 mm

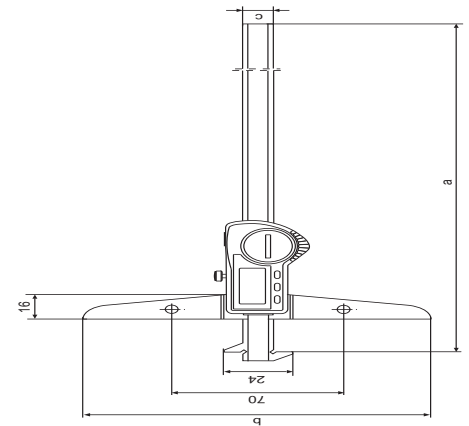

Accessories

Order No.	Product Description	Product Type
4102220	Receiver including MarCom Standard Software	i-Stick
4102520	Battery 3 V, CR 2032	
4126510	Cross beam extension (300 mm)	30 EXm
4126511	Cross beam extension (200 mm)	30 EXm

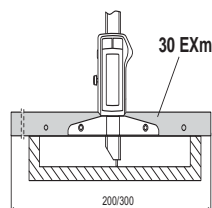

30 EXm



i-Stick

MarCal 30 EWRI-N | Digital Depth Gage

Functions

- ON/OFF
- AUTO-ON / OFF
- mm/inch
- LOCK function (key lock)
- RESET (set display to zero)
- PRESET (for entering a numerical value)
- DATA (data transmission)
- HOLD (storage of measured values)
- High contrast digital display
- Locking thumbscrew
- Lapped guideway
- Measuring surfaces made of steel
- Slide and beam made of hardened stainless steel
- Immediate measurements due to the Reference System
- Raised guideways for protection of the scale
- Strong resistance against dust, coolants and lubricants
- Dirt wipers integrated in the slide
- **Digit Height:** 11 mm
- **Data Interface:** Integrated Wireless
- **Energy Supply:** Battery life approximately 3 years (approximately 1/2 year in wireless mode)
- **IP Protection Category:** IP 67
- **Package Contains:** Battery, Instruction Manual, Anvils 30 Ent (1 mm), 902 (4 mm) and 903 (4 mm), Case



REFERENCE



Application:

- Measuring groove widths and distances between grooves

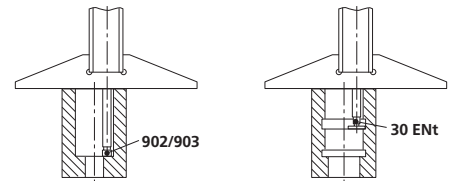

Technical Data

Order No.	Product Type	Measuring Range	Resolution	Error Limit
4126532	30 EWRI-N	0 - 100 / 0 - 4 in	0,01 mm / 0.0005 in	0,03 mm

	a	b	c
4126532	268 mm	85 mm	16 mm

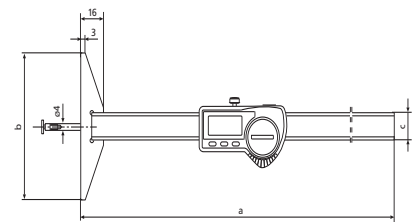

Accessories

Order No.	Product Description	Product Type
4102220	Receiver including MarCom Standard Software	i-Stick
4102520	Battery 3 V, CR 2032	
4126310	Disc type anvil (7,5 mm x 0,5 mm)	30 Ent
4882022	Disc type anvil (7,5 mm x 1 mm)	30 Ent

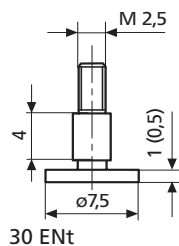

i-Stick

Micromar | The Digital Micrometer Micromar 40 EWRI

Waterproof Micrometer with Integrated Wireless

Unconstrained Movement



Integrated Wireless gives you unconstrained movement. For example, when using the digital micrometer or other wireless products, while measuring at the machine or on large parts, the user is not obstructed by cables.



Large Display

The high contrast display with 10 mm sized digits enables accurate and fatigue-free reading of the measurement results.

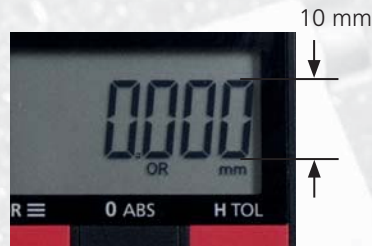

Reference Lock Protection

- Zero position is secured
- Operating error is not possible
- Lock prevents the pressing of buttons

The digital micrometer Micromar 40 EWRI Reference is equipped with a LOCK function. With this keylock, the zero position is secured and operating error is avoided.



IP Protection Category



Strong resistance against dust, coolants and lubricants.

Code Initials	IP	International Protection
First Digit	6	Dustproof
Second Digit	5	Protected Against Powerful Water Jets



HOLD/DATA Function

HOLD





Freezes the measured value after the measurement is taken in a difficult to access area where the display cannot be seen.

DATA

If data transmission is activated, the HOLD button acts as DATA button.



Tolerance Function with Warning Limits

-  Measured value within tolerance limits
-  Warning limit: flashing arrow, if upper warning limit is reached
-  Warning limit: flashing arrow, if lower warning limit is reached
-  Measured value out of tolerance

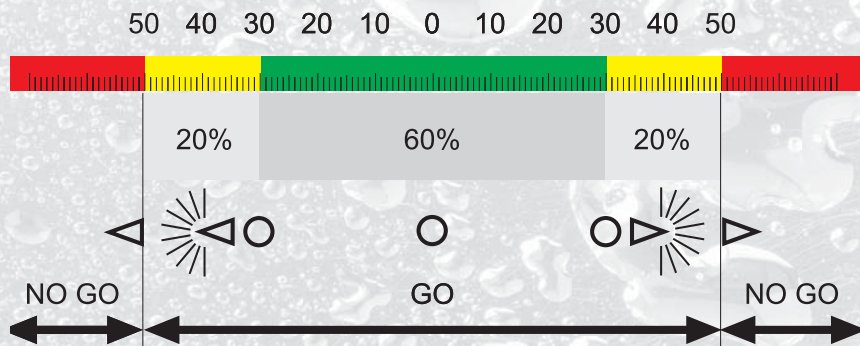

Micromar 40 EWRi | Digital Micrometer

Functions

- RESET (set display to zero)
- ABS (display can be set to zero without losing reference to ORIGIN)
- mm/inch
- ORIGIN (for entering a numerical value)
- LOCK function (key lock)
- TOL (tolerance and warning limits)
- DATA (data transmission)
- HOLD (storage of measured values)
- High contrast digital display
- Hardened and ground stainless steel spindle
- Carbide tipped spindle and anvil
- Rapid drive
- Ratchet integrated in the thimble
- Lacquered and heat insulated steel frame
- MarCom Professional Software free download:
www.mahr.com/marcom (only for Mahr data cables and wireless systems with USB and RS232 interface)
- **Digit Height:** 10 mm
- **Data Interface:** Integrated Wireless
- **IP Protection Category:** IP 65
- **Package Contains:** Instruction Manual, Battery, Setting Standard (from measuring range 25–50 mm), Case

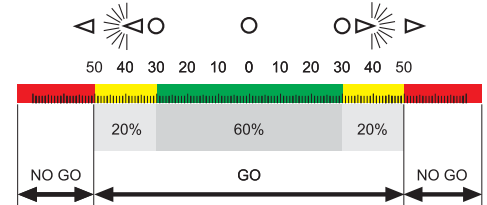

Technical Data

Order No.	Product Type	Measuring Range	Resolution	Error Limit	Spindle Thread Pitch	Measuring Force
4157100	40 EWRi	0 – 25 mm / 0 - 1 in	0,001 mm / 0.00005 in	2 µm	0,5 mm	5 – 10 N
4157101	40 EWRi	25 mm – 50 mm / 1 in - 2 in	0,001 mm / 0.00005 in	2 µm	0,5 mm	5 – 10 N
4157102	40 EWRi	50 mm – 75 mm / 2 in - 3 in	0,001 mm / 0.00005 in	3 µm	0,5 mm	5 – 10 N
4157103	40 EWRi	75 mm – 100 mm / 3 in - 4 in	0,001 mm / 0.00005 in	3 µm	0,5 mm	5 – 10 N

Order No.	a	b	c
4157100	24 mm	9,5 mm	32 mm
4157101	36 mm	11 mm	57 mm
4157102	45 mm	13 mm	82 mm
4157103	57 mm	13 mm	107 mm

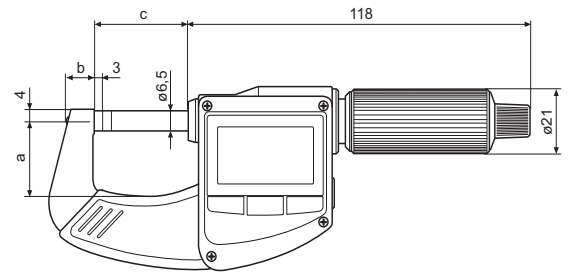

Accessories

Order no.	Product description	Product type
4102220	Receiver including MarCom Standard Software	i-Stick
4102520	Battery 3 V, CR 2032	
4158000	Stand for holding outside micrometers	41 H



i-Stick

41 H

Scan the QR code to watch simple and practical applications



Micromar 40 EWRI | Digital Micrometer Set

Functions

- RESET (set display to zero)
- ABS (display can be set to zero without losing reference to ORIGIN)
- mm/in
- ORIGIN (for entering a numerical value)
- LOCK function (key lock)
- TOL (tolerance and warning limits)
- DATA (data transmission)
- HOLD (storage of measured values)
- High contrast digital display
- Hardened and ground stainless spindle
- Carbide tipped spindle and anvil
- Rapid drive
- Ratchet integrated in the thimble
- Lacquered and heat insulated steel frame
- MarCom Professional Software free download:
www.mahr.com/marcom
(only for Mahr data cables and wireless systems with USB and RS232 interface)
- **Digit Height:** 10 mm
- **Data Interface:** Integrated Wireless
- **IP Protection Category:** IP 65
- **Package contains:** Instruction Manual, Battery, Setting Values, Case

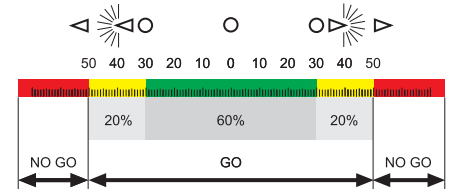

Technical Data

Order No.	Product Type	Measuring Range	Resolution	Spindle Thread Pitch	Measuring Force	Number of Micrometers
4157115	40 EWRI	0 mm - 100 mm / 0 - 4 in	0,001 mm / 0.00005 in	0,5 mm	5 - 10 N	4

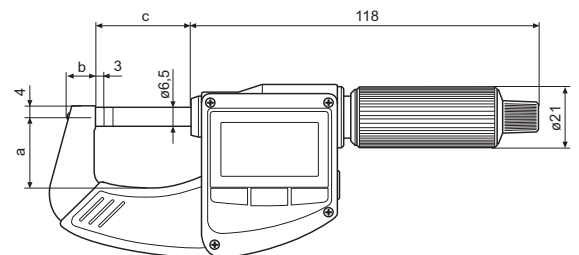

Accessories

Order No.	Product Description	Product Type
4102220	Receiver including MarCom Standard Software	i-Stick
4102520	Battery 3 V, CR 2032	
4158000	Stand for holding outside micrometers	41 H



i-Stick



41 H

MarCator | Digital Indicators

Digital Indicators with Tolerance Indication and Integrated Wireless

Clear Display

Tolerance indication with the displayed value. Displayed is the actual measured value and the tolerance zone position.

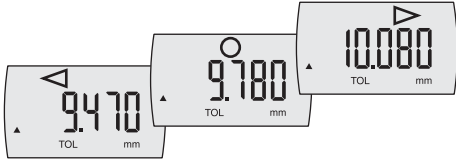

Tolerance indication without the value in the display. In and Out of tolerance will be indicated in the display as a symbol.

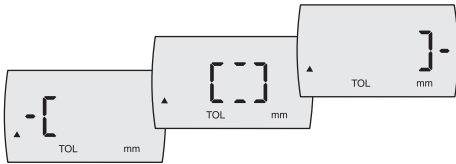

Universal Data Interface



Integrated Wireless
The wireless interface for the price of a cable.



USB
No interface box required; a simple and inexpensive way to set up multiple measuring instruments via a USB hub.



Digimatic
To connect a Digimatic compatible evaluation instrument.



Mahr Opto RS232C
For direct connection to a COM port on a PC.



Absolute Function:
Micrometer can be set in any position to 0,000 mm / 0.0000 in without losing reference to the preset value.

Error-free Operation



Lock Function: Prevents unintentional activation of an operating button. Either all the operating buttons or only certain individual buttons can be locked. If a locked operating button is pressed, the LOCK symbol will appear in the display.

Protection Class



Protection class IP54 (optional)

- Protection cap is sealed
- Rubber bellows for the measuring spindle
- Sealed battery compartment

Code Initials	IP	International Protection
First Digit	5	Dust Protected
Second Digit	4	Protection Against Splash Water in All Directions

3 Year Battery Life

The new Reference System is just as energy efficient as when the caliper is in standby mode; almost no power is required, therefore extending the life of the battery up to 3 years*.

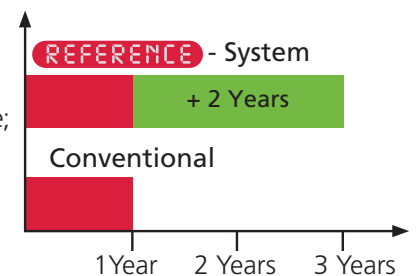

* When Integrated Wireless is deactivated

MarCator 1086 Ri | Digital Indicator

Functions

- ON/OFF
- RESET (set display to zero)
- mm/in
- Reversal of counting direction
- PRESET (for entering a numerical value)
- TOL (enter tolerance limit values)
- <0> (tolerance GO / NO GO display mode)
- ABS (display can be set to zero without losing reference to preset)
- DATA (data transmission via connection cable)
- Factor (adjustable)
- LOCK (individual button lock)
- Integrated Wireless transmitter
- High contrast LCD display
- Operating and display unit (bezel) can be rotated through 280°
- Mounting shank and measuring spindle are both made of hardened stainless steel
- Immediate measurements due to the Reference System
- MarCom Professional Software free download:
www.mahr.com/marcom (only for Mahr data cables and wireless systems with USB and RS232C interface)
- **Digit Height:** 11 mm
- **Data Interface:** Digimatic, Opto RS232C, USB, Integrated Wireless
- **IP Protection Category:** IP 42
- **Package Contains:** Instruction Manual, Battery

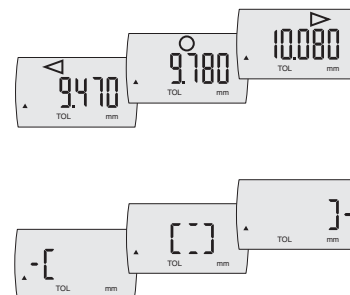

Technical Data

Order No.	4337624	4337625	4337626	4337627	4337628
Product Type	1086 Ri				
Measuring Span	12,5 mm / 0.5 in	25 mm / 1 in	50 mm / 2 in	100 mm / 4 in	25 mm / 1 in
Resolution	0,0005 mm, 0,001 mm, 0,002 mm, 0,005 mm, 0,01 mm				
Resolution	0.00002 in, 0.00005 in, 0.0001 in, 0.0002 in, 0.0005 in				
Error Limit	0,004 mm		0,008 mm	0,009 mm	0,004 mm
Error Limit Over 50 Graduations	0,002 mm				
Repeatability	0,001 mm				
Measuring Force	0,65 - 0,9 N	0,65 - 1,15 N	1,25 - 2,7 N	1,8 - 3,5 N	0 - 0
Standard	Factory standard				
Lifting Protection Cap	•				

Order No..	a	b	c	Mounting Shaft
4337624	126,3 mm	23 mm	13,5 mm	8 mm
4337625	153,4 mm	26,8 mm	26,5 mm	8 mm
4337626	267,3 mm	40 mm	52 mm	8 mm
4337627	420,3 mm	91 mm	103 mm	8 mm
4337628	153,4 mm	26,8 mm	26,5 mm	8 mm

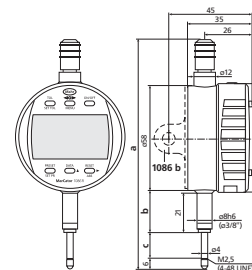

Accessories

Order No.	Product Description	Product Type
4884464	Battery 3 V, Type CR 2450	
4102357	Data connection cable USB (2 m) including MarCom Standard Software	16 EXu
4102915	Digimatic data cable (2 m)	16 EWd
4102410	Data connection cable RS232C (2 m)	16 EXr
4102220	Receiver including MarCom Standard Software	i-Stick
4375004	Protective cap for 1075 R / 1086 R / 1087 R	1086 s
4337421	Lug back	1086 b
4336311	Cable release (12,5 + 25 mm)	1085 a
4336237	Pneumatic lifting (12,5 + 25 mm)	1082 p
4310103	Adapter bush (.375" / 8 mm)	940
4336230	Pneumatic lifting (50 + 100 mm)	1082 p



i-Stick



1085 a

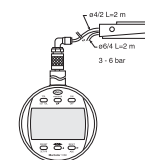

1082 p

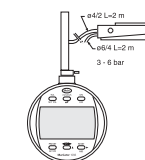

1082 p

MarCator 1086 Ri | Digital Indicator

Functions

- ON/OFF
- RESET (set display to zero)
- mm/in
- Reversal of counting direction
- PRESET (for entering a numerical value)
- TOL (enter tolerance limit values)
- <0> (tolerance GO / NO GO display mode)
- ABS (display can be set to zero without losing reference to preset)
- DATA (data transmission via connection cable)
- Factor (adjustable)
- LOCK (individual button lock)
- Integrated Wireless transmitter
- High contrast LCD display
- Operating and display unit (bezel) can be rotated through 280°
- Mounting shank and measuring spindle made of hardened stainless steel
- Immediate measurements due to the Reference System
- MarCom Professional Software free download:
www.mahr.com/marcom (only for Mahr data cables and wireless systems with USB and RS232C interface)
- **Digit Height:** 11 mm
- **Data Interface:** Digimatic, Opto RS232C, USB, Integrated Wireless
- **IP Protection Category:** IP 42
- **Package Contains:** Instruction Manual, Battery



REFERENCE

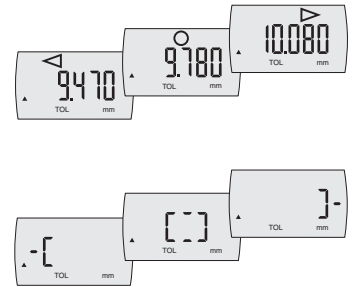

Technical Data

Order No.	4337134	4337135
Product Type	1086 Ri	
Measuring Span	12,5 mm / 0.5 in	25 mm / 1 in
Resolution	0,01 mm	
Resolution	0.0005 in	
Error Limit	0,02 mm	
Error Limit Over 50 Graduations	0,02 mm	
Repeatability	0,01 mm	
Measuring Force	0,65 - 0,9 N	0,65 - 1,15 N
Standard	Factory standard	
Lifting Protection Cap	•	

Order No.	a	b	c	Mounting Shaft
4337134	126,3 mm	23 mm	13,5 mm	8 mm
4337135	153,4 mm	26,8 mm	26,5 mm	8 mm

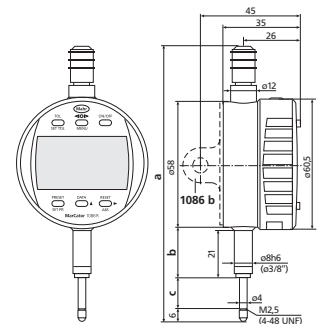

Accessories

Order No.	Product Description	Product Type
4884464	Battery 3 V, Type CR 2450	
4102357	Data connection cable USB (2 m) including MarCom Professional Software	16 EXu
4102915	Digimatic data cable (2 m)	16 EWd
4102410	Data connection cable RS232C (2 m)	16 EXr
4102220	Receiver including MarCom Professional Software	i-Stick
4375004	Protective cap for 1075 R / 1086 R / 1087 R	1086 s
4337421	Lug back	1086 b
4310103	Adapter bush (.375" / 8 mm)	940
4336311	Cable release (12,5 + 25 mm)	1085 a
4336237	Pneumatic lifting (12,5 + 25 mm)	1082 p



i-Stick

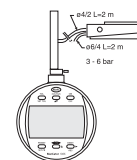

1082 p

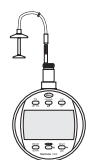

1085 a

MarCator 1086 WRi | Digital Indicator

Functions

- ON/OFF
- RESET (set display to zero)
- mm/in
- Reversal of counting direction
- PRESET (for entering a numerical value)
- TOL (enter tolerance limit values)
- <0> (tolerance GO / NO GO display mode)
- ABS (display can be set to zero without losing reference to preset)
- DATA (data transmission via connection cable)
- Factor (adjustable)
- LOCK (individual button lock)
- Integrated Wireless transmitter
- High contrast LCD display
- Operating and display unit (bezel) can be rotated through 280°
- Mounting shank and measuring spindle are both made of hardened stainless steel
- Immediate measurements due to the Reference System
- MarCom Professional Software free download:
www.mahr.com/marcom (only for Mahr data cables and wireless systems with USB and RS232C interface)
- **Digit height:** 11 mm
- **Data interface:** Digimatic, Opto RS232C, USB, Integrated Wireless
- **IP protection category:** IP 54
- **Package Contains:** Instruction Manual, Battery

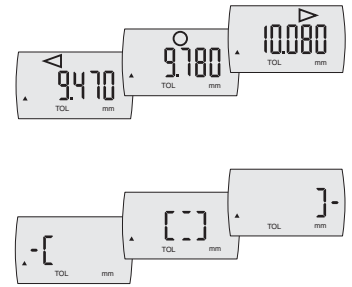

Technical Data

Order No.	4337142	4337143
Product Type	1086 WRi	
Measuring Span	12,5 mm / 0.5 in	25 mm / 1 in
Resolution	0,0005 mm, 0,001 mm, 0,002 mm, 0,005 mm, 0,01 mm	
Resolution	0.00002 in, 0.00005 in, 0.0001 in, 0.0002 in, 0.0005 in	
Error Limit	0,004 mm	
Error Limit over 50 Graduations	0,002 mm	
Repeatability	0,001 mm	
Measuring Force	0,65 - 1,4 N	1 - 2,25 N
Standard	Factory standard	
Protective Measuring Spindle Cap	•	

Order No.	a	b	c	Mounting Shaft
4337142	144,3 mm	21 mm	28,5 mm	8 mm
4337143	193,2 mm	24,8 mm	50 mm	8 mm

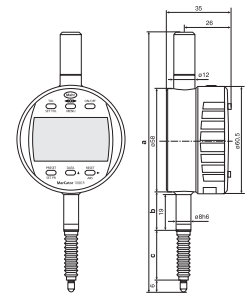

Accessories

Order No.	Product Description	Product Type
4884464	Battery 3 V, Type CR 2450	
4102357	Data connection cable USB (2 m) including MarCom Professional Software	16 EXu
4102915	Digimatic data cable (2 m)	16 EWd
4102410	Data connection cable RS232C (2 m)	16 EXr
4102220	Receiver including MarCom Professional Software	i-Stick
4375004	Protective cap for 1075 R / 1086 R / 1087 R	1086 s
4337421	Lug back	1086 b
4336311	Cable release (12,5 + 25 mm)	1085 a
4310103	Adapter bush (.375" / 8 mm)	940
4336237	Pneumatic lifting (12,5 + 25 mm)	1082 p
4337472-E	Rubber bellows (12,5 mm)	
4337474-E	Rubber bellows (25 mm)	



i-Stick

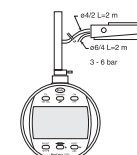

1082 p

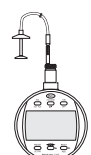

1085 a

MarCator 1087 Ri

Digital Indicator with Integrated Wireless and Dynamic Measuring Functions

Dynamic Measuring Functions

- **MAX-MIN** function ideal for testing flatness and concentricity
- **MAX** and / or **MIN** for searching the reversal point

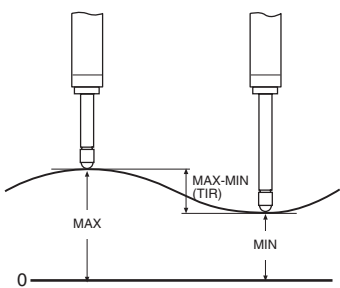

Clear Tolerance Display

The integrated bar graph visualizes the tolerance deviation. Out of tolerance, above the upper or below the lower tolerance limit, is represented by arrows shown in the display.

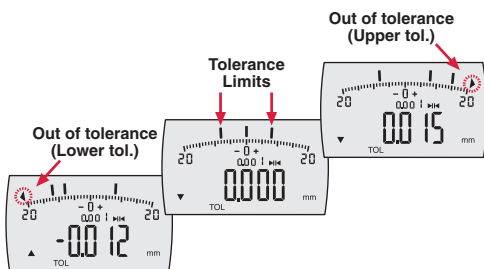

3 Year Battery Life

The new Reference System is just as energy efficient as when the caliper is in standby mode; almost no power is required, therefore extending the life of the battery up to 3 years*.

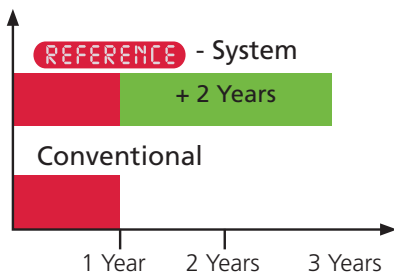

* When Integrated Wireless is deactivated

Universal Data Interface



Integrated Wireless

The wireless interface for the price of a cable.



USB

No interface box required; a simple and inexpensive way to set up multiple measuring instruments via a USB hub.



Digimatic

To connect a Digimatic compatible evaluation instrument.



Mahr Opto RS232C

For direct connection to a COM port on a PC.



ABS

Absolute Function:

Micrometer can be set in any position to 0,000 mm / 0.0000 in without losing reference to the preset value.

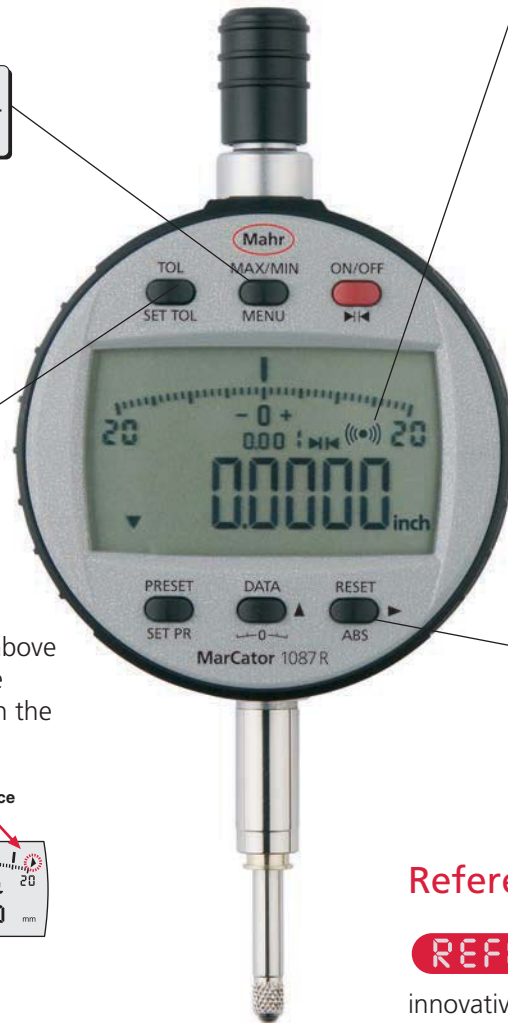

Reference System

REFERENCE The new digital indicators 1087 Ri are equipped with the innovative Reference System. The zero position only has to be set one time: once it is set, the zero remains stored for all further measurements. Therefore, when the indicator is switched ON, or the measuring spindle is moved, the indicator is immediately ready for measurement, eliminating the need to reset as with a conventional indicator.

Error-free Operation

Lock Function: Prevents unintentional



activation of an operating button. Either all the operating buttons or only certain individual buttons can be locked. If a locked operating button is pressed, the LOCK symbol will appear in the display.

MarCator 1087 Ri | Digital Indicator

Functions

- 0 (set the analog display to zero)
- ABS (display can be set to zero without losing reference to preset)
- AUTO-ON / OFF
- DATA (data transmission via connection cable)
- Factor (adjustable)
- LOCK (individual button lock)
- MAX/MIN memory for searching the reversal point
- ON/OFF
- PRESET (for entering a numerical value)
- RANGE (switch the measuring range and resolution)
- RESET (set display to zero)
- TIR (MAX-MIN) for testing flatness and concentricity
- TOL (enter tolerance limit values)
- Reversal of counting direction
- mm/in
- Integrated Wireless transmitter
- High contrast LCD display
- Operating and display unit (bezel) can be rotated through 280°
- Lifter protection cap on the measuring spindle
- Hardened stainless steel clamping shaft and measuring pin
- Immediate measurements due to the Reference System
- MarCom Professional Software free download:
www.mahr.com/marcom (only for Mahr data cables and wireless systems with USB and RS232C interface)
- **Digit Height:** 8,5 mm
- **Data Interface:** Digimatic, Opto RS232C, USB, Integrated Wireless
- **Energy Supply:** Battery operation
- **IP Protection Category:** IP 42
- **Package Contains:** Instruction Manual, Battery



REFERENCE



Technical Data

Order No.	4337663	4337665	4337667
Product Type	1087 Ri		
Measuring Range	12,5 mm / 0.5 in	25 mm / 1 in	50 mm / 2 in
Resolution	0,0005 mm, 0,001 mm, 0,002 mm, 0,005 mm, 0,01 mm / 0.00002 in, 0.00005 in, 0.0001 in, 0.0002 in, 0.0005 in		
Readings	0,001 mm, 0,002 mm, 0,005 mm, 0,01 mm, 0,02 mm, 0,05 mm		
Range of Analog Display	± 0,01 mm, ± 0,02 mm, ± 0,04 mm, ± 0,1 mm, ± 0,2 mm		
Error Limit	0,004 mm		0,007 mm
Error Limit Over 50 Graduations	0,002 mm		
Repeatability	0,001 mm		
Measuring Force	0,65 - 0,85 N	0,65 - 0,9 N	1,25 - 2,7 N
Standard	Factory standard		
Lifting Protection Cap	•		

Order No.	a	b	c	Mounting Shaft
4337663	126,3 mm	23 mm	13,5 mm	8 mm
4337665	153,4 mm	26,8 mm	26,5 mm	8 mm
4337667	267,3 mm	40 mm	52 mm	8 mm

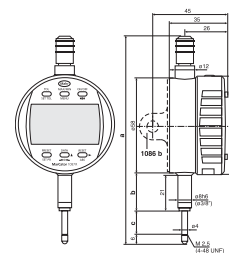

Accessories

Order No.	Product Description	Product Type
4884464	Battery 3 V, Type CR 2450	
4102357	Data connection cable USB (2 m) including MarCom Standard Software	16 EXu
4102915	Digimatic data cable (2 m)	16 EWd
4102411	Digimatic data cable (2 m)	16 EXd
4102410	Data connection cable RS232C (2 m)	16 EXr
4102220	Receiver including MarCom Standard Software	i-Stick
4375004	Protective cap for 1075 R / 1086 R / 1087 R	1086 s
4337421	Lug back	1086 b
4336237	Pneumatic lifting (12,5 + 25 mm)	1082 p
4336311	Cable release (12,5 + 25 mm)	1085 a
4310103	Adapter bush (.375" / 8 mm)	940
4336230	Pneumatic lifting (50 + 100 mm)	1082 p



i-Stick

1082 p

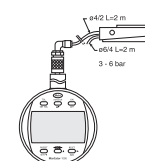

1082 p



1085 a

MarCator 1087 BRi | Digital Indicator

Functions

- ON/OFF
- RESET (set display to zero)
- mm/in
- PRESET (enter a numerical value)
- Reversal of counting direction
- TOL (enter tolerance limit values)
- START/STOP search for reversal point
- MAX/MIN memory for searching the reversal point
- ABS (display can be set to zero without losing reference to preset)
- 0 (set the analog display to zero)
- DATA (data transmission via connection cable)
- Factor (adjustable)
- LOCK (individual button lock)
- Integrated Wireless transmitter
- High contrast LCD display
- Operating and display unit (bezel) can be rotated through 280°
- Lifter protection cap on the measuring spindle
- Hardened stainless steel clamping shaft and measuring pin
- Immediate measurements due to the Reference System
- MarCom Professional Software free download:
www.mahr.com/marcom (only for Mahr data cables and wireless systems with USB and RS232 interface)
- **Digit Height:** 8,5 mm
- **Data Interface:** Opto RS232C, Digimatic, USB, Integrated Wireless
- **Energy Supply:** Battery life approximately 3 years
- **IP Protection Category:** IP 42
- **Package Contains:** Instruction Manual, Battery



Bore Gage Application

When measuring with a 2-point bore gage, the reversing point will be calculated automatically during reversal. When used with the PRESET value, the ACTUAL measured value is shown on the display. The 1087 BRi can process 64 measurements per second for fast measurement certainty.

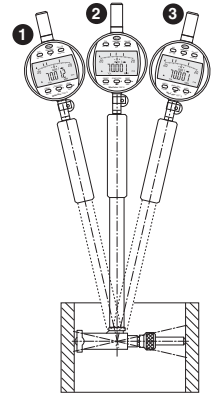

Technical Data

Order No.	4337664
Product Type	1087 BRi
Measuring Range	12,5 mm / 0.5 in
Resolution	0,0005, 0,001, 0,002, 0,005, 0,01
Resolution	0.00002 in, 0.00005 in, 0.0001 in, 0.0002 in, 0.0005 in
Readings	0,001 mm, 0,002 mm, 0,005 mm, 0,01 mm, 0,02 mm, 0,05 mm
Range of Analog Display	± 0,01 mm, ± 0,02 mm, ± 0,04 mm, ± 0,1 mm, ± 0,2 mm
Error Limit	0,004 mm
Error Limit Over 50 Graduations	0,002 mm
Repeatability	0,001 mm
Measuring Force	0,65 - 0,9 N
Standard	Factory standard
Protective Measuring Spindle Cap	•

Order No.	a	b	c	Mounting Shaft
4337664	126,3 mm	23 mm	13,5 mm	8 mm

Accessories

Order No.	Product Description	Product Type
4884464	Battery 3 V, Type CR 2450	
4102357	Data connection cable USB (2 m) including MarCom Professional Software	16 EXu
4102915	Digimatic data cable (2 m)	16 EWd
4102410	Data connection cable RS232C (2 m)	16 EXr
4102220	Receiver including MarCom Professional Software	i-Stick
4375004	Protective cap for 1075 R / 1086 R / 1087 R	1086 s
4310103	Adapter bush (0.375 in / 8 mm)	940

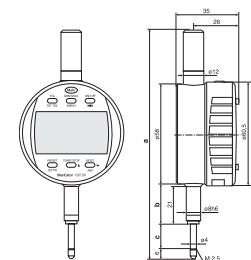

i-Stick

MarConnect Integrated Wireless

Transmit your measuring data, directly into Microsoft® Excel or via a virtual interface box to your PC software, without being tangled with cables.



Application Example:
Digital Indicator 1087 Ri with
Plug Gage MaraMeter 844 D



Application Example:
Digital Indicator 1087 BRi with
Self-Centering Bore Gage
MaraMeter 844 N



Application Example:
Digital Indicator 1086 Ri
with Snap Gage 300P-1



Application Example:
Digital Indicator 1087 Ri with
Universal Gage Multimar 844 T

MarConnect e-Stick | Receiver

- Retrofits all Mahr hand measuring instruments that have a data interface
- Wireless data transmission from a measuring instrument to a PC
- Secure data transmission due to the acknowledgement dialog of the received data from the PC to the measuring instrument
- Optical confirmation of received data
- Compact transmitter without an external antenna
- Bi-directional radio link (remote control from measuring instruments)
- Radio frequency is 2400 MHz
- **Package Contains:** e-Stick, Wireless Receiver, Driver
- MarCom Professional Software free download:
www.mahr.com/marcom (only for Mahr data cables and wireless systems with USB and RS232 interface)



Technical Data

Order No.	4102230
Frequency Band	2400 MHz
Radio Range	up to 6 m
Product Type	e-Stick
Number of Connectable Wireless Receivers for e-Stick	1
Number of Connectable Transmission Modules for e-Stick	8
For Measuring Instrument	Transmission modules 16 EWe, 2000 e, RS232 e

MarConnect 16 EWe / 2000 e / RS232 e / 1082 e | Transmitter

- Retrofits on all Mahr hand measuring instruments that have a data interface
- Wireless data transmission from a measuring instrument to a PC
- Secure data transmission due to the acknowledgement dialog of the received data from the PC to the measuring instrument
- Optical confirmation of received data
- Compact transmitter without an external antenna
- Bi-directional radio link (remote control from measuring instruments)
- Radio frequency is 2400 MHz
- MarCom Professional Software free download:
www.mahr.com/marcom (only for Mahr data cables and wireless systems with USB and RS232 interface)



Technical Data

Order No.	4102231	4102232	4102233	4102235
Frequency Band	2400 MHz			
Radio Range	up to 6 m (20 ft)			
Product Type	16 EWe	2000 e	RS232 e	1082 e
For Measuring Instrument	MarCal 16 ER, 16 EWR, 16 EWW, 30 EWR, 30 EWN, Digimar 814 SR, Micromar 40 EWR, 40 EWS, 40 EWW, 44 EWR, 46 EWR, MarCator 1075 R, 1086 R, 1087 R, 1087 BR, MarSurf PS1, PS10	Digimar 816 CL, MarCator 1088 / 1088W, Millimess 2000, 2001, 2100, µMaxum II, Millimar C.1200	Millimar C.1208, C.1216, C.1245, S1840 Digimar 817 CLM	Digimar M814 N/G, Multimar 25 ES, MarTool 106 ES

MarCom Professional 5.2 | Software-Interface

- Directly transfer measured values into Microsoft® Excel, SPC Software using virtual interface box (MUX50 format), a text file or key code
- The measured values for each connected measuring instrument can be copied into a separate column, table or folder in Microsoft® Excel
- USB hubs can also be connected as a measuring instrument interface
- Clear depiction of the selected measuring devices by means of icons
- Freely definable and configurable measurement cycles
- Flexible, user-friendly data transmission via the data button on the measuring device or data cable or via a PC keyboard, timer, remote control or foot switch connected to a USB interface

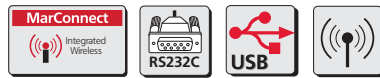

For free
download
www.mahr.com/marcom

Order No.	4102212
Connected Wireless Receivers for the i-Stick	4
Connectable Devices with Integrated Wireless	32
Connected Wireless Receivers for the e-Stick	1
Connectable Sender Modules for the e-Stick	8
Connected Wireless Receivers FM 2	1
Connectable Sender Modules for the Wireless Receivers FM 2	100
Devices to be Connected with a USB Interface	128
Connectable USB Foot Switches	128
Devices to be Connected with an RS232C Interface	2
Virtual Interface Boxes (8 Inputs)	4

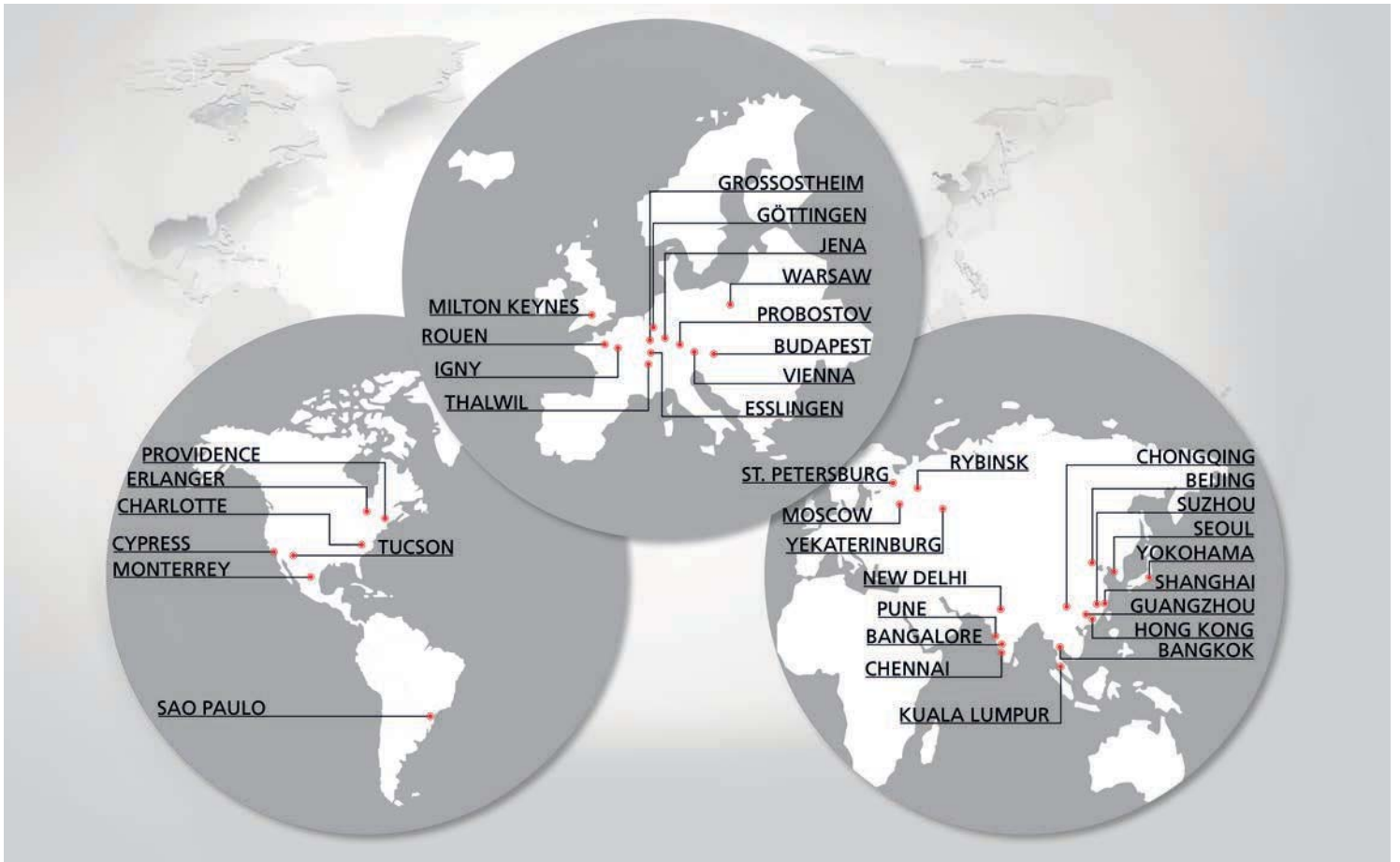

Partner for manufacturing companies worldwide.

Close to our customers.



COMPLETE METALWORKING SOLUTIONS

(800) 991-4225

www.ahbinc.com

ISO Certified

customerservice@ahbinc.com

Mahr Inc.
1144 Eddy Street, Providence, RI 02905
1-800-991-4225

www.mahr.com



- 0 +



EXACTLY