

Styli and accessories

AHB

TOOLING & MACHINERY

COMPLETE METALWORKING SOLUTIONS

(800) 991-4225

www.ahbinc.com

ISO Certified

customerservice@ahbinc.com





Page 8-3

Technical specifications and quick reference guides

Quick selection from our extensive range.



Page 8-8

Accuracy at the point of contact

An explanation of why it is important to choose the right stylus for your application, and an overview of the entire range of stylus types.



Page 8-13

M2 threaded stylus range

Styli for use with the industry-standard CMM probes TP2, TP20 and TP200.



Page 8-21

M3 threaded stylus range

Styli for use with manual CMM probes TP1 and TP6 and the most flexible scanning probe, SP25M.



Page 8-27

M4 threaded stylus range

Optimized for stiffness and weight, styli purposely designed for the high accuracy TP7M and our comprehensive range of probing for machine tools.



Page 8-38

M5 threaded stylus range

A premium range specifically designed for highest accuracy scanning probes from Renishaw and other manufacturers.



Page 8-53

Styli for Faro arms and Zeiss probing systems

These styli have been designed especially for use on Faro portable arm CMMs and with Zeiss probing systems.



Page 8-87

Accessories

All of the 'bits and pieces' that you need to assemble anything from the most complex stylus clusters to a simple star.

Technical specifications

Ball material properties

Stylus type	Material	Grade	Deviation from spherical form	Structure	Composition	Purity	Density	Hardness	Compression strength	Bending strength	Fracture toughness K1c
			(μm)	–	(wt%)	(%)	(g/cm^3)	HV	(MPa)	(MPa)	($\text{MN}/\text{m}^{3/2}$)
AL ₂ O ₃ ruby balls	Synthetic ruby monocrystalline	Grade 5*	0.13	mono	99% AL ₂ O ₃	99.90	3.90	2300	2100	400-700	1
Silicon nitride balls	Hard pressed Si ₃ N ₄	Grade 5*	0.13	poly	Si ₃ N ₄	90	3.0-3.2	1600	3000	850	6
Zirconia oxide balls	Sintered ZrO ₂	Grade 5*	0.13	poly	ZrO ₂	90-95	6.05	1200	2000	1000	10
Alumina hollow balls	White ceramic sintered alumina AL ₂ O ₃	–	1	poly	AL ₂ O ₃	99.80	3.8-3.9	1900	2500	350	3.5
Silver steel disks	Silver steel	–	1	–	–	–	8	450	–	–	–
Silver steel simple cylinder	Silver steel	–	Roundness 4 μm	–	–	–	8	200	–	–	–
Ruby ball ended cylinder	Synthetic ruby	Ball: Grade 5*	Ball deviation from spherical form: 0.13 Concentricity: Ball/cylinder 4 μm	mono	99% AL ₂ O ₃	99.90	3.99	2300	2300	400-700	1
Tungsten carbide ball ended cylinder	Tungsten carbide	–	+ 20 μm end radius	–	92-93.5% WC 6.5-8% CO	14.8	14.95	1550	6000	–	–
Silver steel simple pointer	Silver steel	–	Cone angle 30°	–	–	–	8	300	–	–	–
Tungsten carbide radius end pointer	Tungsten carbide	–	Cone angle 30°	–	92-93.5% WC 6.5-8% CO	99.90	15	1550	6000	–	–
Aluminum hollow balls	Al. alloy 6082-T6	–	30 μm	–	95.2-98.3% AL	–	2.7	95	–	–	–

* Refers to DIN-5401 ball grade standard

* Grade 3 sphericity balls are available on request.

Extension material properties

Material	Coefficient of expansion @ 25 °C
Stainless steel	16x10 ⁻⁶ /°C
Tungsten carbide	5x10 ⁻⁶ /°C
White ceramic sintered alumina	8.1x10 ⁻⁶ /°C
Carbon fiber	-0.4x10 ⁻⁶ /°C
Titanium	9.2x10 ⁻⁶ /°C
Ruby	4.5x10 ⁻⁶ /°C
Silicon nitride	3.2x10 ⁻⁶ /°C
Zirconia	10.5x10 ⁻⁶ /°C

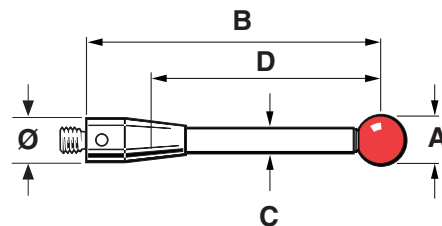

- A** Ball diameter
- B** Overall length
- C** Stem diameter
- D** Effective working length
- Ø M2 = 3 mm
- Ø M3 = 4 mm
- Ø M4 = 7 mm
- Ø M5 = 10 mm

Styli and accessories

M2 styli and extensions quick reference guide

These are a selection of the most popular styli.

Ruby ball / stainless steel stem

Ball diameter	1.0 (0.04)	1.5 (0.06)	2.0 (0.08)	2.5 (0.10)	3.0 (0.12)	4.0 (0.16)	5.0 (0.20)	6.0 (0.24)	8.0 (0.32)
Length 10 mm	A-5000-7806	A-5000-7802	A-5000-7807	A-5000-7803	A-5000-3604	A-5000-4154	A-5000-4155	A-5000-4156	A-5000-4158
20 mm	-	-	A-5000-3603	A-5000-7804	A-5000-4160	A-5000-4161	-	-	-

Ruby ball / tungsten carbide stem

Ball diameter	0.3 (0.012)	0.5 (0.02)	0.7 (0.03)	1.0 (0.04)	1.5 (0.06)	2.0 (0.08)	2.5 (0.10)	3.0 (0.12)	4.0 (0.16)	5.0 (0.20)
Length 10 mm	A-5000-7800	A-5000-7805	A-5000-7801	A-5003-1325	-	-	-	-	-	-
20 mm	-	A-5003-1345	A-5003-0577	SEE DRAWING	A-5003-0034	A-5003-3822	A-5003-1896	A-5003-0938	A-5003-1029	A-5003-0046
30 mm	-	-	-	A-5000-8663	A-5003-0035	A-5003-0036	A-5003-0038	A-5003-0040	A-5003-0043	A-5003-0047
40 mm	-	-	-	-	-	A-5003-0037	A-5003-0039	A-5003-0041	A-5003-0044	A-5003-0048
50 mm	-	-	-	-	-	-	-	A-5003-0042	A-5003-0045	A-5003-0049

Ruby ball / ceramic stem

Ball diameter	3.0 (0.12)	4.0 (0.16)	5.0 (0.20)	6.0 (0.24)
Length 30 mm	A-5003-4177	A-5003-1370	A-5003-4779	A-5003-4780
50 mm	A-5003-0064	A-5003-0065	A-5003-0066	A-5003-0470

Ruby ball / carbon fiber stem

Ball diameter	4.0 (0.16)	5.0 (0.20)	6.0 (0.24)
Length 30 mm	A-5003-4241	A-5003-4781	A-5003-4782
50 mm	A-5003-2285	A-5003-2286	A-5003-2287
75 mm	A-5003-4784	A-5003-4785	A-5003-4786
100 mm	A-5003-2289	A-5003-2290	A-5003-2291

Stylus extensions

Length	5.0 (0.20)	10.0 (0.40)	20.0 (0.80)	30.0 (1.19)	40.0 (1.58)	50.0 (1.97)	70.0 (2.76)	90.0 (3.55)
Stainless steel	A-5004-7610	A-5004-7585	A-5004-7586	A-5004-7591	A-5004-7611	-	-	-
Ceramic	-	-	-	A-5003-0070	A-5003-0071	A-5003-0072	-	-
Carbon fiber	-	-	-	-	A-5003-2280	A-5003-2281	A-5003-2282	A-5003-2283

M3 styli and extensions quick reference guide

These are a selection of the most popular styli.

Ruby ball / stainless steel stem

Ball diameter		1.0 (0.04)	2.0 (0.08)	3.0 (0.12)	4.0 (0.16)	5.0 (0.20)
Length	21 mm	A-5000-3551	A-5000-3552	A-5000-3553	A-5000-7606	A-5000-7630
	31 mm	–	–	–	A-5000-3554	A-5000-7648

Ruby ball / tungsten carbide stem

Ball diameter		0.5 (0.02)	1.5 (0.06)	2.0 (0.08)	2.5 (0.10)	3.0 (0.12)	4.0 (0.16)	5.0 (0.20)
Length	21 mm	A-5000-7632	A-5003-0050	–	A-5003-0054	–	–	–
	30 mm	–	A-5003-0051	A-5003-0052	A-5003-0055	A-5003-0057	–	–
	40 mm	–	–	A-5003-0053	A-5003-0056	A-5003-0058	A-5003-0060	A-5003-0062
	50 mm	–	–	–	–	A-5003-0059	A-5003-0061	A-5003-0063

Ruby ball / ceramic stem

Ball diameter		3.0 (0.12)	4.0 (0.16)	5.0 (0.20)
Length	50 mm	A-5003-0067	A-5003-0068	A-5003-0069

Ruby ball / carbon fiber stem

Ball diameter		6.0 (0.24)	8.0 (0.32)
Length	75 mm	A-5003-4860	A-5003-4861
	100 mm	A-5003-4862	A-5003-4863

Stylus extensions

Length	10.0 (0.40)	20.0 (0.80)	35.0 (1.38)	50.0 (1.97)	70.0 (2.76)
Stainless steel	A-5004-7609	A-5004-7583	A-5004-7584	–	–
Ceramic	–	–	–	A-5003-0075	–
Carbon fiber	–	–	–	A-5003-4864	A-5003-4865

M4 styli and extensions quick reference guide

These are a selection of the most popular styli.

Ruby ball / stainless steel stem

Ball diameter	1.0 (0.04)	2.0 (0.08)	3.0 (0.12)	4.0 (0.16)	5.0 (0.20)	6.0 (0.24)	8.0 (0.32)
Length 10 mm	–	–	–	–	A-5000-6350	–	–
20 mm	A-5000-7545	A-5000-7547	A-5000-7549	A-5000-7551	SEE DRAWING	A-5000-7555	A-5000-7557
30 mm	–	–	–	–	A-5000-6352	–	–
50 mm	–	–	–	–	A-5000-7521	–	–
100 mm	–	–	–	–	A-5000-7522	–	–

Ruby ball / tungsten carbide stem

Ball diameter	1.0 (0.04)	2.0 (0.08)	3.0 (0.12)	4.0 (0.16)	5.0 (0.20)	6.0 (0.24)
Length 20 mm	A-5003-4792	A-5003-2932	A-5003-4793	A-5003-4794	A-5003-4795	A-5003-4796
50 mm	–	A-5003-4797	A-5003-3680	A-5003-4799	A-5003-4800	A-5003-4801

Ruby ball / ceramic stem

Ball diameter	5.0 (0.20)	6.0 (0.24)	8.0 (0.32)
Length 50 mm	A-5003-0235	A-5000-3709	A-5000-7795
75 mm	A-5003-0236	A-5003-2764	A-5003-4802
100 mm	A-5000-9761	A-5000-3712	A-5000-7796

Ruby ball / carbon fiber stem

Ball diameter	6.0 (0.24)	8.0 (0.32)
Length 50 mm	A-5003-1436	–
100 mm	A-5003-1358	–
150 mm	A-5003-1255	–
200 mm	A-5003-1075	–
300 mm	–	A-5003-3461

Stylus extensions

Length	10.0 (0.41)	15.0 (0.60)	20.0 (0.79)	30.0 (1.19)	50.0 (1.97)	100.0 (3.94)
Stainless steel	A-5004-7559	A-5004-7600	A-5004-7601	A-5004-7602	–	–
Ceramic	–	–	–	A-5000-7754	A-5000-7755	A-5000-7727

M5 styli and extensions quick reference guide

These are a selection of the most popular styli.

Ruby ball / tungsten carbide stem

Ball diameter	0.3 (0.012)	0.5 (0.02)	0.7 (0.03)	1.0 (0.04)	1.5 (0.06)	2.0 (0.08)	2.5 (0.10)	3.0 (0.12)	4.0 (0.16)	5.0 (0.20)
Length 20 mm	A-5003-5201	A-5003-5202	A-5003-5203	A-5003-5204	A-5003-5205	A-5003-5206	A-5003-5207	A-5003-5208	A-5003-5209	A-5003-5210
30 mm	A-5003-5211	A-5003-5212	A-5003-5213	A-5003-5214	A-5003-5215	A-5003-5216	A-5003-5217	A-5003-5218	A-5003-5219	A-5003-5220
40 mm	–	–	–	–	A-5003-5221	A-5003-5222	A-5003-5223	A-5003-5224	–	–
50 mm	A-5003-5225	A-5003-5226	A-5003-5227	A-5003-5228	A-5003-5229	SEE DRAWING	A-5003-5232	A-5003-5234	A-5003-5235	A-5003-5236
75 mm	A-5003-5240	A-5003-5241	A-5003-5242	A-5003-5243	A-5003-5244	–	–	A-5003-5253	SEE DRAWING	SEE DRAWING
100 mm	–	–	–	–	–	–	A-5003-5254	–	–	–

Ruby ball / carbon fiber stem

Ball diameter	2.5 (0.10)	6.0 (0.24)	8.0 (0.32)	10.0 (0.40)
Length 20 mm	–	–	–	–
30 mm	–	–	–	–
40 mm	–	–	–	–
50 mm	–	A-5003-5237	A-5003-5238	A-5003-5239
75 mm	–	A-5003-5250	A-5003-5251	A-5003-5252
100 mm	–	SEE DRAWING	SEE DRAWING	SEE DRAWING
150 mm	–	A-5003-5265	A-5003-5266	A-5003-5267
200 mm	–	A-5003-5268	A-5003-5269	A-5003-5270
300 mm	–	A-5003-5271	A-5003-5272	A-5003-5273

Stylus extensions

Length	10.0 (0.41)	20.0 (0.79)	30.0 (1.19)	40.0 (1.58)	50.0 (1.97)	60.0 (2.37)	70.0 (2.76)	80.0 (3.15)	90.0 (3.55)	100.0 (3.94)
CF/titanium (Ø11 mm)	–	–	–	A-5555-0647	A-5555-0648	A-5555-0649	A-5555-0623	A-5555-0650	A-5555-0651	A-5555-0652
CF/titanium (Ø20 mm)	–	–	–	A-5555-0620	A-5555-0657	A-5555-0658	–	A-5555-0621	–	A-5555-0659
Stainless steel	A-5555-0142	A-5555-0140	A-5555-0669	–	A-5555-0670	–	–	–	–	A-5555-0136
Aluminum tube	–	–	–	–	A-5555-0671	–	–	–	–	A-5555-0127

Length	120.0 (4.76)	150.0 (5.91)	180.0 (7.09)	200.0 (7.88)	250.0 (9.85)	300.0 (11.82)	400.0 (15.76)	500.0 (19.70)	600.0 (23.64)
CF/titanium (Ø11 mm)	A-5555-0425	A-5555-0424	A-5555-0653	A-5555-0654	A-5555-0655	A-5555-0642	A-5555-0656	–	–
CF/titanium (Ø20 mm)	A-5555-0660	A-5555-0661	A-5555-0662	A-5555-0663	A-5555-0427	A-5555-0664	A-5555-0665	A-5555-0667	A-5555-0668
Stainless steel	–	–	–	–	–	–	–	–	–
Aluminum tube	–	–	–	A-5555-0125	–	–	–	–	–

Accuracy at the point of contact

As industry has developed its requirement for increasingly diverse and complex manufactured parts, inspection systems have had to work hard to keep up. The use of co-ordinate measuring machines (CMMs) with probing systems and in-process inspection on machine tools are two of the solutions offered by Renishaw to help you maximize your productivity and maintain the highest quality.

Successful gaging depends very much on the ability of the probe's stylus to access a feature and then maintain accuracy at the point of contact. At Renishaw, we have used our expertise in probe and stylus design to develop a comprehensive range of CMM and machine tool styli to offer you the greatest possible precision.

These notes explain the critical features of every stylus type, helping you to choose the right design for each inspection need.

What is a stylus?

A stylus is that part of the measuring system which makes contact with the component, causing the probe's mechanism to displace. The generated signal enables a measurement to be taken. The feature to be inspected dictates the type and size of stylus used. In all cases, however, maximum rigidity of the stylus and perfect sphericity of the tip are vital.

To achieve this, Renishaw's stylus stems are produced on CNC machine tools to exacting standards. Great care is taken to ensure that location faces give maximum stiffness whilst stylus mass is optimized to suit Renishaw's range of probes.

Genuine Renishaw stylus balls are produced to the highest standards and are bonded to the stems in such a way as to ensure maximum joint integrity.

The performance of your gaging can easily be degraded if you use a stylus with poor ball roundness, poor ball location, bad thread fit or a compromised design that allows excessive bending during measurement. To ensure the integrity of the data you gather, make certain that you specify and use a stylus from the comprehensive range of genuine Renishaw styli.

What naming protocol do Renishaw use to describe their styli range?

Renishaw uses the following naming protocol to allow easy identification of styli by name and part number. The examples below show how this protocol is assigned and describe the abbreviations used:

Straight styli

M2 STY D2R L20 EWL14 d1.4SS

The above protocol describes an M2 threaded straight stylus fitted with a 2 mm diameter ruby ball. It has an overall length of 20 mm, has an effective working length (EWL) of 14 mm and has a 1.4 mm diameter stainless steel stem.

Star styli

M2 STR D2R L20 5BALL L19.5 S32

The above protocol describes an M2 threaded star stylus fitted with a 2 mm diameter ruby ball. It has five balls on the star and an overall length of 19.5 mm (from the center of the ball to the rear of the star mounting face when assembled to a probe). The span of the star cluster is 32 mm.

Disk styli

M2 DSC SD18 SLVS T2.2 L2.6 BR-Y

The above protocol describes an M2 threaded disk stylus with a spherical diameter disk of 18 mm. It is made from silver steel with a disk thickness of 2.2 mm and a length of 2.6 mm. BR stands for balls/rollers followed by yes (Y) or no (N).

Cylinder styli

M2 CYL D3 SLVS L13 EWL4

The above protocol describes an M2 threaded cylinder stylus with a critical measuring element diameter of 3 mm made from silver steel. It has an overall length of 13 mm and an EWL of 4 mm.

Extensions

M4 EXT L15 d7 SS

The above protocol describes an M4 threaded extension with a length of 15 mm and a diameter of 7 mm. The extension is made from stainless steel.

Terminology

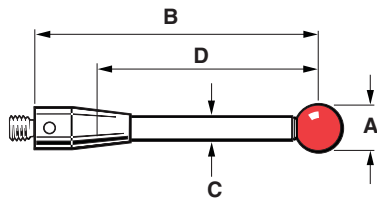

- A Ball diameter
- B Overall length
- C Stem diameter
- D Effective working length

Overall length

Renishaw uses a standard description of overall length, measuring from the rear mounting face of the stylus to the center of the ball.

Effective working length (EWL)

This is measured from the center of the ball to the point at which the stem will foul against the feature when measuring 'normal' to the part.

Choosing a stylus

To maintain accuracy at the point of contact, we recommend that you:

Keep styli short

The more a stylus bends or deflects, the lower the accuracy. Probing with the minimum stylus length for your application is the best option.

Minimize joints

Every time you join styli and extensions, you introduce potential bending and deflection points. Try, wherever possible, to keep to the minimum number of pieces for your application.

Keep the ball as large as possible

There are two reasons for this:

- firstly, it maximizes your ball/stem clearance, thereby reducing the chances for false triggers caused by 'shanking out' on the stylus stem
- secondly, the larger ball reduces the effect of the surface finish of the component being inspected.

The range of genuine Renishaw styli

Ball material

Ruby

The industry standard and the optimum stylus ball material for a vast majority of measurement applications, ruby is one of the hardest known materials. Synthetic ruby is 99% pure aluminum oxide which is grown into crystals (or "boules") at 2000 °C using the Verneuil process.

The boules are then cut and gradually machined into a highly spherical form. Ruby balls are exceptionally smooth on the surface, have great compressive strength and a high resistance to mechanical corrosion.

Very few applications exist where ruby is not the preferred ball material, however there are two applications where balls manufactured from other materials are recommended.

The first is for heavy-duty scanning applications on aluminum. Because the materials attract, a phenomenon known as 'adhesive wear' can occur, which involves build up of aluminum from the surface onto the ball. A better ball material for such applications is silicon nitride.

The second is in heavy-duty scanning applications on cast iron. Interaction between the two materials can result in 'abrasive wear' of the ruby ball surface. For such applications, zirconia balls are recommended.

Silicon nitride

Silicon nitride possesses many similar properties to ruby. It is a very hard and wear-resistant ceramic which can be machined into very high precision spheres. It can also be polished to an extremely smooth surface finish. Silicon nitride does not have the attraction to aluminum and so does not exhibit the adhesive wear seen with ruby in similar applications. However, silicon nitride does show significant abrasive wear characteristics when scanning on steel surfaces and so its applications are best confined to aluminum.

Zirconia

Zirconia is a particularly tough ceramic material with hardness and wear characteristics approaching those of ruby. Its surface properties make it an ideal material for aggressive scanning applications on cast iron components.

Stem material

Steel

Stylus stems manufactured from stainless steel are used widely for styli with ball/tip diameters of 2 mm or greater and with lengths up to 30 mm. Within this range, one-piece steel stems offer the optimum stiffness-to-weight ratio, giving adequate ball/stem clearance without compromising stiffness with a joint between the stem and threaded body.

Please contact us if you require any styli with special ball materials. We can recommend the most suitable material for scanning different materials.

Styli and accessories

Tungsten carbide

Tungsten carbide stems are best used for maximizing stiffness with either small stem diameters required for ball diameters of 1 mm and below, or lengths up to 50 mm. Beyond this, weight can become a problem and stiffness is lost due to deflection at the stem to body joint.

Ceramic

For ball diameters greater than 3 mm, and lengths over 30 mm, ceramic stems offer stiffness comparable to steel but are significantly lighter than tungsten carbide. Ceramic stemmed styli can also offer additional crash protection to your probe as the stem will shatter in a collision.

Carbon fiber (Renishaw GF)

There are many grades of carbon fiber materials, however Renishaw GF combines optimum stiffness characteristics, both longitudinally and in torsion (important in star constructions), with extremely low weight. Carbon fiber is inert and this, combined with a special resin matrix, provides excellent protection in the most hostile of machine tool environments.

Renishaw GF is ideal for maximizing stiffness while giving very low mass for styli above 50 mm in length. It is the optimum stem material for high-accuracy strain gage technology probes with excellent vibration-damping characteristics and negligible co-efficient of thermal expansion.

The genuine Renishaw stylus range comprises several types:

Straight styli

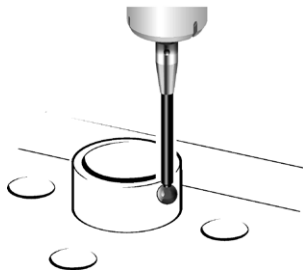

These are the simplest form of stylus, incorporating highly spherical industrial ruby balls and a choice of stem material.

Ruby is an extremely hard material and hence stylus wear is minimized. It is also of low density, keeping tip mass to a minimum, which avoids unwanted probe triggers caused by machine motion or vibration.

Mounted on stems made from a range of materials – stainless steel, tungsten carbide, ceramic and a specialized carbon fiber material, “Renishaw GF” – these simple ruby ball styli are suitable for most inspection applications.

Each stylus has an effective working length (EWL) which is the penetration that can be achieved by the ball before the stem fouls against the feature.

The size of the ball and the EWL of the stylus chosen are dictated by the size of the feature to be inspected. However, keeping the stylus ball as large as possible and the stem as short as possible will ensure maximum ball/stem clearance, whilst providing a greater yet still rigid EWL. Using larger ruby balls also reduces the effect of the surface finish of the component being inspected.

Probing with very long stylus/extension combinations is not recommended with standard kinematic touch trigger probes as the rigidity is reduced and accuracy lost due to stylus bending. This is not the case with other types of probe such as those with strain gage technology, as their very low trigger forces permit the use of long stylus/extension combinations without a significant loss of accuracy.

Star styli

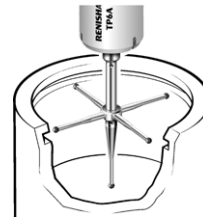

These stylus clusters provide you with multiple-tip probing of complex features and bores. Four or five ruby ball systems are mounted rigidly on a stainless steel center. Three standard sizes are offered – alternatively, you can create custom-made star styli using a 5-way stylus center and any of the genuine Renishaw stylus range.

Star styli can be used to inspect a variety of different features. Their use can reduce inspection cycle times by allowing multi-tip probing, minimizing the need to move the probe to extreme points of internal features such as the sides or grooves in a bore. Using star styli also allows effective probing in the –Z (upwards) direction when using a 5-way probe, provided that the stylus tips extend beyond the diameter of the probe body. Each tip on a star stylus requires datuming (sometimes referred to as ‘qualifying’ or ‘calibrating’) in the same manner as a single-ball stylus. The ‘span’ of star styli is taken from ball center to ball center.

Disk styli



These styli are used to probe undercuts and grooves within bores which may be inaccessible to star styli. They are ‘sections’ of highly spherical balls and are available in various diameters and thicknesses. Full rotational adjustment and the ability to add a center stylus are features of the Renishaw range of disk styli that make them particularly flexible and easy to use.

Probing with the 'spherical edge' of a simple disk is effectively the same as probing on or about the equator of a large stylus ball. However, only a small area of this ball surface is available for contact and hence thinner disks require careful angular alignment in order to ensure correct contact with the feature being probed.

A simple disk requires datuming for only one diameter (usually in a ring gage), but limits effective probing to only X and Y directions.

Adding a 'radius end roller' allows you to datum and hence probe in the Z direction, provided that the center of the 'radius end roller' extends beyond the diameter of the probe. The 'radius end roller' can be datumed on a sphere or a slip gage. Rotating and locking the disk about its center axis allows the 'radius end roller' to be positioned to suit the application.

Disks may also have a threaded center to allow the fixing of a center stylus, giving the additional flexibility of probing the bottom of deep bores (where access for the disk may be limited).

Styli for specialist applications

A range of specialist styli is available to enable probing of features such as thread form, thin sectioned material, tool setting and other specialist applications.

Cylinder styli



These are used for probing holes in thin sheet material. In addition, various threaded features can be probed and the centers of tapped holes located. Ball-ended cylinder styli allow full datuming and probing in X, Y and Z directions, thus allowing surface inspection to be performed.

Pointer and ceramic hollow ball styli

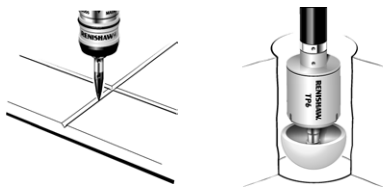

Pointer styli are designed for the inspection of thread forms, specific points and scribed lines (to lower accuracy). The use of a radius end pointer stylus allows more accurate datuming and probing of features as detailed above and can also be used to inspect the location of very small holes.

Ceramic hollow ball styli are ideal for probing deep features and bores in X, Y and Z directions, with the need to datum only one ball. There are two versions in the range, 18 mm and 30 mm diameter, specially designed for the TP2 / TP20 / TP200 and TP6 probes respectively. Probing with such a large diameter ball can average out the effects of very rough surfaces.

Tool setting styli



Typically, these are fitted with a square tip and can have threaded or plain shaft attachments. The tip faces are ground to ensure high squareness and parallelism. The TS27R tool setting probe for machining centers can also be fitted with a tungsten carbide disk stylus.

Crash protection devices



Renishaw's stylus crash protection devices are designed to break in the event of impact and protect the probe from damage.

Accessories and tools

A wide range of accessories including extensions, 4 and 5-way centers and stylus knuckles complement the genuine Renishaw stylus range to achieve fully flexible inspection.

Stylus centers



These provide maximum probing flexibility with a single probe. Taking up to five styli of the same mounting thread, this accessory allows you to build stylus configurations to your own specification.

Stylus knuckles



These give full adjustment about two axes, allowing the stylus to be orientated to probe angled features. This adjustment is especially useful when the probe cannot be correctly orientated by the probe head, or when access for the head is limited.

Styli and accessories

Stylus extensions



These provide additional probing penetration by extending the stylus away from the probe. However, using stylus extensions can reduce probe accuracy due to loss of rigidity. This is not the case with electronic probes, whose extremely low trigger forces render them less sensitive to this type of inaccuracy.

Stylus thread adaptors



These allow M2, M3, M4 and M5 threaded styli to be interchanged on the majority of touch trigger probes. They are particularly useful for adapting the extensive range of specialized application M2 styli for use on larger probes.

Stylus tools

Specifically designed for mounting styli correctly onto probes and for the construction of specialized stylus combinations, Renishaw's stylus tools protect your investment.

S7 stylus tool



The S7 stylus tool is used for tightening styli and accessories when connecting to one another or directly into the probe. It is specifically designed to yield if excessive tightening force is applied, avoiding damage to the threads of stylus and probe.

Stylus crank



A stylus crank can allow access to features that are otherwise difficult to reach, and are often used in lathe inspection applications.

Renishaw stylus kits

Renishaw styli and accessories are available in a wide selection of kits, ranging from a small precision set of the most frequently used styli, to a comprehensive set to meet virtually every inspection need.

Some sets are housed in a quality wooden case for maximum protection and superb presentation. The styli are held in a wood insert, individually located in a nylon sleeve providing protection for the mounting threads. This type of box features a removable module which houses up to twelve ruby ball styli and contains a tray for disks, tools and accessories. This allows the stylus selection for a particular inspection task to be brought to the CMM's table. The sloping lid design of this kit provides easy access to styli, minimizing handling of ruby balls and contact surfaces, thus aiding cleanliness.

Probing kits are also available to include a probe, probe head, extension bars and styli.

Custom design service

If you cannot achieve your objectives using our extensive range of standard products, Renishaw's Styli and Custom Products Division offers a unique service by providing customers with a total solution for their probing needs for CMM, machine tool or scanning applications.

The Division includes expertise in applications, design, engineering and manufacturing with extensive experience in providing tailor-made product solutions to specific customer's requirements.

In many application problems, the solution lies in the choice of the stylus which influences access of the workpiece features, inspection times and probe performance. All of these aspects are considered within the design of a custom stylus, ensuring that the solution incorporates the ideal choice of materials and optimizes probe performance for your particular application.

Renishaw's Styli and Custom Products Division has supplied over 5,000 different custom styli into probing applications worldwide, so the solution to your application problem may already exist.

For advice and further details, please contact your nearest Renishaw distributor.

Always use genuine Renishaw styli or your probe performance will be compromised!

M2 threaded stylus range

Ruby ball styli (stainless steel stems)

Ball material	Part number									
Ruby	A-5000-7806	A-5000-7802	A-5000-7807	A-5000-7803	A-5000-3604	A-5000-4154	A-5000-4155	A-5000-4156	A-5000-4158	A-5000-4158
Price	\$32	\$22	\$22	\$22	\$22	\$22	\$36	\$39	\$72	
Silicon nitride	A-5004-0210	A-5004-1918	A-5003-6120	A-5004-1920	A-5003-2138**	A-5003-9524	A-5004-1921	A-5004-0237**	A-5004-1922	
Price	\$53	\$69	\$69	\$69	\$69	\$69	\$78	\$78	\$112	
Zirconia	A-5003-7757**	A-5004-0165	A-5003-7723	A-5004-2913	A-5004-2914	A-5003-7261**	A-5003-2186	A-5004-2203**	A-5004-2915	
Price	\$69	\$69	\$69	\$69	\$69	\$69	\$78	\$78	\$112	
A	Ball dia. mm (in.)	1.0 (0.04)	1.5 (0.06)	2.0 (0.08)	2.5 (0.10)	3.0 (0.12)	4.0 (0.16)	5.0 (0.20)	6.0 (0.24)	8.0 (0.32)
B	Length mm (in.)	10.0 (0.40)	10.0 (0.40)	10.0 (0.40)	10.0 (0.40)	10.0 (0.40)	10.0 (0.40)	10.0 (0.40)	10.0 (0.40)	11.0 (0.44)
C	Stem dia. mm (in.)	0.7 (0.03)	0.7 (0.03)	1.0 (0.04)	1.0 (0.04)	1.5 (0.06)	1.5 (0.06)	2.5 (0.10)	2.5 (0.10)	2.5 (0.10)
D	EWL* mm (in.)	4.5 (0.18)	4.5 (0.18)	6.0 (0.24)	6.5 (0.26)	7.0 (0.28)	10.0 (0.40)	10.0 (0.40)	10.0 (0.40)	11.0 (0.44)
	Mass grams	0.3	0.3	0.3	0.3	0.4	0.4	0.7	0.9	1.5

10 mm range

Ball material	Part number				
Ruby	A-5000-3603	A-5000-7804	A-5000-4160	A-5000-4161	
Price	\$25	\$25	\$25	\$25	
Silicon nitride	A-5003-1730**	A-5004-1923	A-5003-6691	A-5004-0236**	
Price	\$76	\$69	\$73	\$69	
Zirconia	A-5004-2916	A-5004-2917	A-5004-1057	A-5004-2918	
Price	\$69	\$69	\$69	\$69	
A	Ball dia. mm (in.)	2.0 (0.08)	2.5 (0.10)	3.0 (0.12)	4.0 (0.16)
B	Length mm (in.)	20.0 (0.79)	20.0 (0.79)	20.0 (0.79)	20.0 (0.79)
C	Stem dia. mm (in.)	1.4 (0.06)	1.4 (0.06)	1.5 (0.06)	1.5 (0.06)
D	EWL* mm (in.)	14.0 (0.56)	16.4 (0.65)	17.0 (0.67)	20.0 (0.79)
	Mass grams	0.4	0.4	0.5	0.6

20 mm range

Ruby ball styli (tungsten carbide stems)

Ball material	Part number				
Ruby	A-5000-7800	A-5000-7805	A-5000-7801	A-5003-1325	
Price	\$111	\$90	\$84	\$77	
Silicon nitride	A-5004-2016**	A-5003-2020**	–	A-5004-2018	
Price	\$189	\$169	–	\$69	
Zirconia	–	A-5003-7672**	A-5004-2632**	A-5004-2919**	
Price	–	\$165	\$210	\$191	
A	Ball dia. mm (in.)	0.3 (0.012)	0.5 (0.02)	0.7 (0.03)	1.0 (0.04)
B	Length mm (in.)	10.0 (0.40)	10.0 (0.40)	10.0 (0.40)	10.0 (0.40)
C	Stem dia. mm (in.)	0.2 (0.01)	0.4 (0.02)	0.5 (0.02)	0.7 (0.03)
D	EWL* mm (in.)	2.0 (0.08)	3.0 (0.12)	4.0 (0.16)	4.0 (0.16)
	Mass grams	0.3	0.3	0.3	0.3

10 mm range

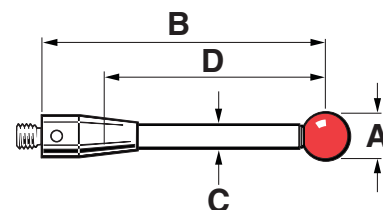

** Special * Effective working length

M2 styli

Ruby ball styli (tungsten carbide stems) – continued

Ball material	Part number					
Ruby	A-5003-1345	A-5003-0577	A-5000-7808	A-5003-0033	A-5003-0034	
Price	\$105	\$107	\$49	\$55	\$55	
Silicon nitride	A-5004-2019**	–	A-5004-1508	A-5004-2021	A-5004-1925	
Price	\$169	–	\$86	\$86	\$86	
Zirconia	A-5004-2920	A-5004-1714**	A-5004-0435	A-5004-2921	A-5004-2922	
Price	\$217	\$104	\$86	\$86	\$86	
A	Ball dia. mm (in.)	0.5 (0.02)	0.7 (0.03)	1.0 (0.04)	1.0 (0.04)	1.5 (0.06)
B	Length mm (in.)	20.0 (0.79)	20.0 (0.79)	20.0 (0.79)	20.0 (0.79)	20.0 (0.79)
C	Stem dia. mm (in.)	0.3 (0.012)	0.5 (0.02)	0.7 (0.03)	0.8 (0.04)	1.0 (0.04)
D	EWL* mm (in.)	7.0 (0.28)	12.0 (0.48)	7.0 (0.28)	12.5 (0.50)	12.5 (0.50)
	Mass grams	0.48	0.32	0.50	0.41	0.50

20 mm range

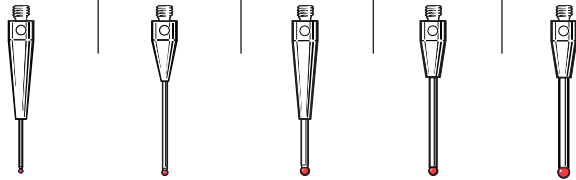

Ball material	Part number					
Ruby	A-5003-3822	A-5003-1896	A-5003-0938	A-5003-1029	A-5003-0046	
Price	\$27	\$72	\$78	\$78	\$44	
Silicon nitride	A-5004-1017**	A-5004-1928	A-5004-1021	A-5004-1929	A-5004-1930	
Price	\$86	\$86	\$86	\$86	\$95	
Zirconia	A-5004-2923	A-5004-2924	A-5004-0437	A-5004-2925	A-5004-2926	
Price	\$86	\$86	\$86	\$86	\$95	
A	Ball dia. mm (in.)	2.0 (0.08)	2.5 (0.10)	3.0 (0.12)	4.0 (0.16)	5.0 (0.20)
B	Length mm (in.)	20.0 (0.79)	20.0 (0.79)	20.0 (0.79)	22.0 (0.87)	20.0 (0.79)
C	Stem dia. mm (in.)	1.0 (0.04)	1.0 (0.04)	1.5 (0.06)	2.0 (0.08)	2.5 (0.10)
D	EWL* mm (in.)	14.0 (0.55)	15.5 (0.62)	17.0 (0.67)	22.0 (0.87)	20.0 (0.79)
	Mass grams	0.48	0.50	0.77	1.24	1.98

20 mm range

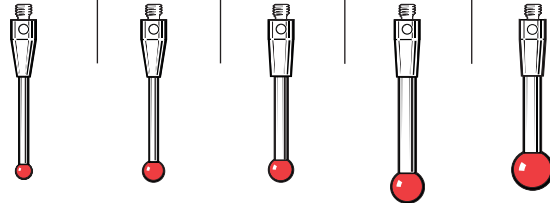

Ball material	Part number						
Ruby	A-5000-8663	A-5003-0035	A-5003-0036	A-5003-0038	A-5003-0040	A-5003-0043	A-5003-0047
Price	\$84	\$38	\$44	\$44	\$44	\$44	\$49
Silicon nitride	A-5004-2022	A-5004-1931	A-5003-7573**	A-5004-1932	A-5004-1933	A-5004-1944	A-5004-1945
Price	\$86	\$86	\$86	\$86	\$86	\$86	\$95
Zirconia	A-5004-2927	A-5004-1711**	A-5004-1058	A-5004-2928	A-5004-0264	A-5004-2929	A-5004-2930
Price	\$104	\$86	\$86	\$86	\$86	\$86	\$95
A	Ball dia. mm (in.)	1.0 (0.04)	1.5 (0.06)	2.0 (0.08)	2.5 (0.10)	3.0 (0.12)	4.0 (0.16)
B	Length mm (in.)	27.5 (1.08)	30.0 (1.19)	30.0 (1.19)	30.0 (1.19)	30.0 (1.19)	30.0 (1.19)
C	Stem dia. mm (in.)	0.7 (0.03)	1.0 (0.04)	1.5 (0.06)	2.0 (0.08)	2.0 (0.08)	2.5 (0.10)
D	EWL* mm (in.)	20.5 (0.81)	22.5 (0.89)	22.5 (0.89)	22.5 (0.89)	27.0 (1.06)	30.0 (1.19)
	Mass grams	0.40	0.58	0.99	1.48	1.49	2.57

30 mm range

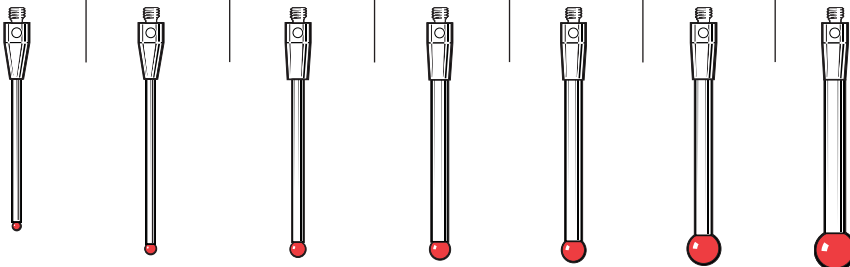

* Effective working length

** Special

Ruby ball styli (ceramic stems)

Ball material	Part number			
Ruby	A-5003-4177	A-5003-1370	A-5003-4779	A-5003-4780
Price	\$84	\$50	\$86	\$92
Silicon nitride	A-5004-1946	A-5004-1952	A-5004-1953	A-5004-1954
Price	\$103	\$103	\$112	\$121
Zirconia	A-5004-2931	A-5004-2932	A-5004-2933	A-5004-2934
Price	\$103	\$103	\$112	\$121
A Ball dia. mm (in)	3.0 (0.12)	4.0 (0.16)	5.0 (0.20)	6.0 (0.24)
B Length mm (in)	30.0 (1.19)	30.0 (1.19)	30.0 (1.19)	30.0 (1.19)
C Stem dia mm (in)	2.0 (0.08)	2.0 (0.08)	2.5 (0.10)	2.5 (0.10)
D EWL* mm (in)	27.0 (1.06)	30.0 (1.19)	30.0 (1.19)	30.0 (1.19)
Mass grams	0.44	0.68	0.93	1.11

30 mm range

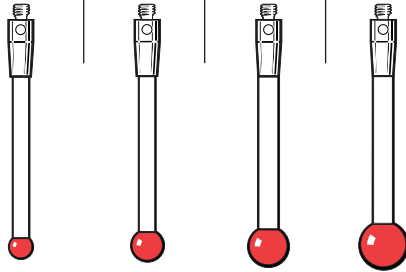

Ruby ball styli (carbon fiber stems)

Ball material	Part number		
Ruby	A-5003-4241**	A-5003-4781	A-5003-4782
Price	\$100	\$104	\$109
Silicon nitride	A-5004-1955	A-5004-1956	A-5004-1957
Price	\$103	\$112	\$121
Zirconia	A-5004-2935	A-5004-2936	A-5004-0618
Price	\$164	\$112	\$121
A Ball dia. mm (in)	4.0 (0.16)	5.0 (0.20)	6.0 (0.24)
B Length mm (in)	30.0 (1.19)	30.0 (1.19)	30.0 (1.19)
C Stem dia mm (in)	3.0 (0.12)	3.0 (0.12)	3.0 (0.12)
D EWL* mm (in)	30.0 (1.19)	30.0 (1.19)	30.0 (1.19)
Mass grams	0.57	0.79	0.96

30 mm range

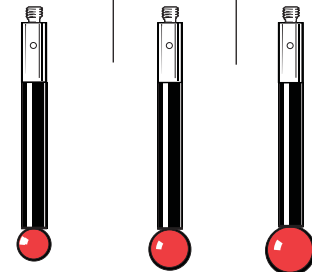

Ruby ball styli (tungsten carbide stems)

Ball material	Part number								
Ruby	A-5003-0037	A-5003-0039	A-5003-0041	A-5003-0044	A-5003-0048	A-5003-0042	A-5003-0045	A-5003-0049	A-5003-0049
Price	\$49	\$49	\$49	\$49	\$53	\$44	\$49	\$53	\$53
Silicon nitride	A-5003-7269**	A-5004-1959	A-5004-1960	A-5004-1961	A-5004-1962	A-5004-1963	A-5004-1964	A-5004-1965	A-5004-1965
Price	\$143	\$86	\$86	\$86	\$95	\$86	\$86	\$95	\$95
Zirconia	A-5004-2937	A-5004-2938	A-5004-1059	A-5004-2939	A-5004-2940	A-5004-2942	A-5004-2943**	A-5004-2944	A-5004-2944
Price	\$86	\$86	\$86	\$86	\$95	\$86	\$86	\$95	\$95
A Ball dia. mm (in.)	2.0 (0.08)	2.5 (0.10)	3.0 (0.12)	4.0 (0.16)	5.0 (0.20)	3.0 (0.12)	4.0 (0.16)	5.0 (0.20)	5.0 (0.20)
B Length mm (in.)	40.0 (1.58)	40.0 (1.58)	40.0 (1.58)	40.0 (1.58)	40.0 (1.58)	50.0 (1.97)	50.0 (1.97)	50.0 (1.97)	50.0 (1.97)
C Stem dia. mm (in.)	1.5 (0.06)	2.0 (0.08)	2.0 (0.08)	2.0 (0.08)	2.5 (0.10)	2.0 (0.08)	2.0 (0.08)	2.5 (0.10)	2.5 (0.10)
D EWL* mm (in.)	32.5 (1.28)	32.5 (1.28)	37.0 (1.46)	40.0 (1.58)	40.0 (1.58)	47.0 (1.85)	50.0 (1.97)	50.0 (1.97)	50.0 (1.97)
Mass grams	1.29	1.95	1.97	2.04	3.17	2.44	2.52	3.75	3.75

40 mm – 50 mm range

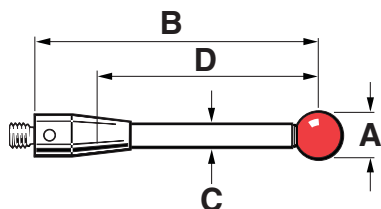
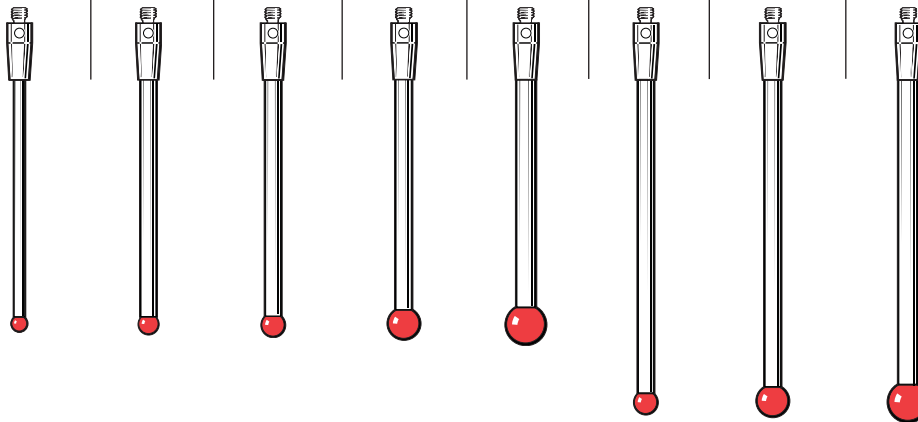

** Special * Effective working length

M2 styli

Ruby ball styli (ceramic stems)

Ball material	Part number			
Ruby	A-5003-0064	A-5003-0065	A-5003-0066	A-5003-0470
Price	\$70	\$70	\$90	\$86
Silicon nitride	A-5004-1967	A-5004-1519	A-5004-1968**	A-5004-1969
Price	\$103	\$115	\$112	\$201
Zirconia	A-5004-2945	A-5004-2946	A-5004-2947	A-5004-2948
Price	\$103	\$103	\$112	\$121
A Ball dia. mm (in)	3.0 (0.12)	4.0 (0.16)	5.0 (0.20)	6.0 (0.24)
B Length mm (in)	50.0 (1.97)	50.0 (1.97)	50.0 (1.97)	50.0 (1.97)
C Stem dia. mm (in)	2.0 (0.08)	2.0 (0.08)	2.5 (0.10)	2.5 (0.10)
D EWL* mm (in)	47.0 (1.85)	50.0 (1.97)	50.0 (1.97)	50.0 (1.97)
Mass grams	0.83	0.91	1.31	1.49

50 mm range

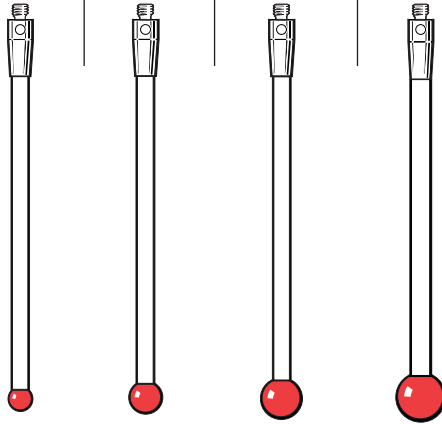

Ruby ball styli (carbon fiber stems)

Ball material	Part number		
Ruby	A-5003-2285	A-5003-2286	A-5003-2287
Price	\$105	\$110	\$115
Silicon nitride	A-5004-1970	A-5004-1971	A-5004-1972
Price	\$103	\$112	\$121
Zirconia	A-5004-1331	A-5004-1330	A-5004-1329
Price	\$103	\$112	\$121
A Ball dia. mm (in)	4.0 (0.16)	5.0 (0.20)	6.0 (0.24)
B Length mm (in)	50.0 (1.97)	50.0 (1.97)	50.0 (1.97)
C Stem dia. mm (in)	3.0 (0.12)	3.0 (0.12)	3.0 (0.12)
D EWL* mm (in)	50.0 (1.97)	50.0 (1.97)	50.0 (1.97)
Mass grams	1.00	1.10	1.20

50 mm range

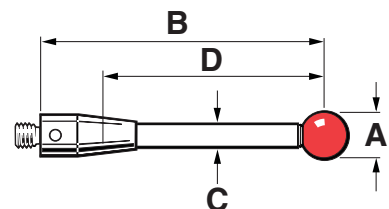
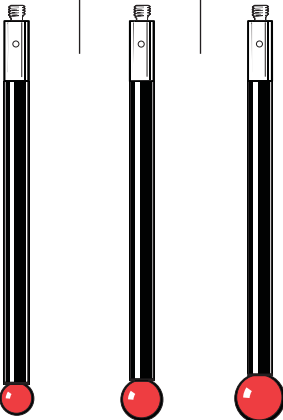

* Effective working length

** Special

Ruby ball styli (carbon fiber stems)

Ball material	Part number					
Ruby	A-5003-4784	A-5003-4785	A-5003-4786	A-5003-2289	A-5003-2290	A-5003-2291
Price	\$135	\$144	\$152	\$154	\$163	\$172
Silicon nitride	A-5004-1973	A-5004-1974	A-5004-1975	A-5004-1976	A-5004-1977	A-5004-1978
Price	\$121	\$121	\$121	\$121	\$121	\$138
Zirconia	A-5004-2949	A-5004-2950	A-5004-2951	A-5004-2952	A-5004-2953	A-5004-2954
Price	\$121	\$121	\$121	\$121	\$121	\$138
A Ball dia. mm (in.)	4.0 (0.16)	5.0 (0.20)	6.0 (0.24)	4.0 (0.16)	5.0 (0.20)	6.0 (0.24)
B Length mm (in.)	75.0 (2.96)	75.0 (2.96)	75.0 (2.96)	100.0 (3.94)	100.0 (3.94)	100.0 (3.94)
C Stem dia. mm (in.)	2.0 (0.08)	3.0 (0.12)	3.0 (0.12)	3.0 (0.12)	3.0 (0.12)	3.0 (0.12)
D EWL* mm (in.)	75.0 (2.96)	75.0 (2.96)	75.0 (2.96)	100.0 (3.94)	100.0 (3.94)	100.0 (3.94)
Mass grams	0.75	1.35	1.45	1.50	1.59	1.78

75 mm – 100 mm range

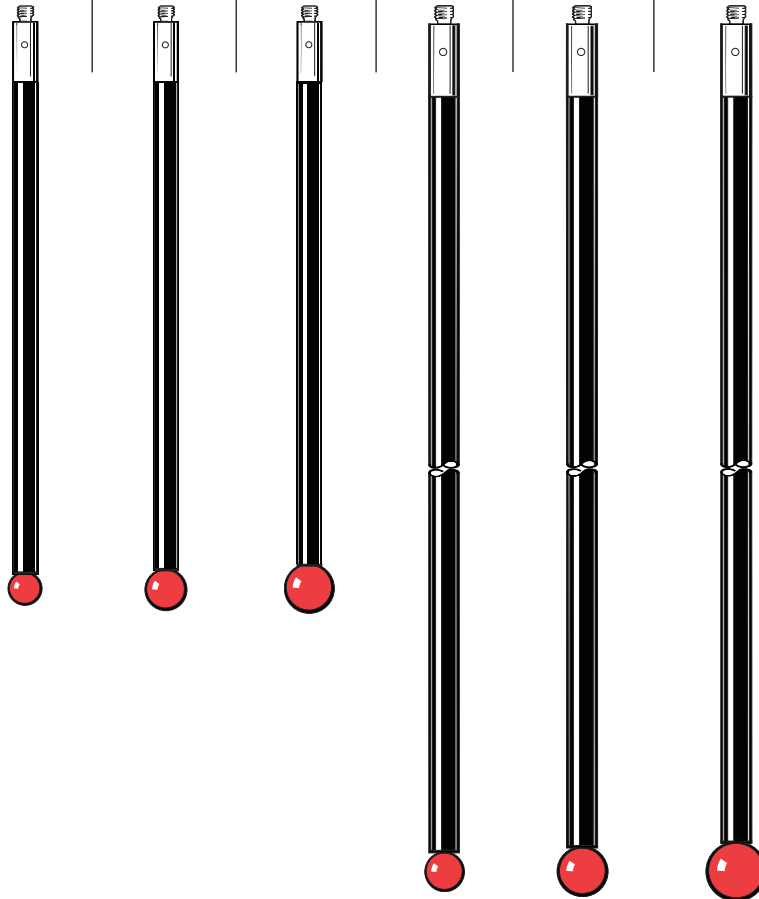

Star styli (fixed)

Part number	A-5003-4011	A-5000-7811	A-5003-4787	A-5003-4788	A-5000-7629	A-5000-3626
Span mm (in.)	10.0 (0.40)	10.0 (0.40)	20.0 (0.79)	20.0 (0.79)	18.0 (0.71)	30.0 (1.19)
Ball mm (in.)	0.5 (0.02)	1.0 (0.04)	0.5 (0.02)	1.0 (0.04)	2.0 (0.08)	2.0 (0.08)
Stem dia. mm (in.)	0.3 (0.012)	0.7 (0.03)	0.3 (0.012)	0.7 (0.03)	1.4 (0.06)	1.4 (0.06)
EWL* mm (in.)	N/A	N/A	N/A	N/A	12.0 (0.48)	12.0 (0.48)
Mass grams	0.7	0.5	0.7	0.9	1.3	1.8
Price	\$249	\$138	\$264	\$221	\$139	\$133

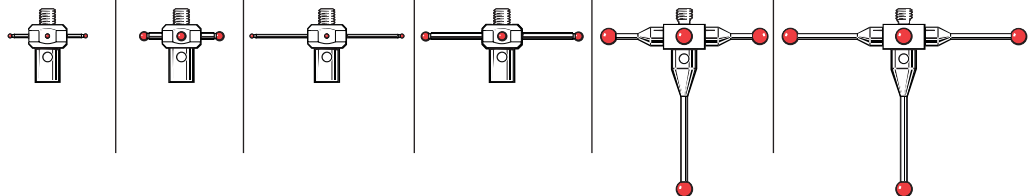

* Effective working length

M2 styli

Star stylus centers

Part number	A-5003-4789	A-5003-4790	A-5003-4791	A-5000-3609
Ball mm (in.)	1.0 (0.04)	0.5 (0.02)	1.0 (0.04)	2.0 (0.08)
Stem dia. mm (in.)	0.7 (0.03)	0.4 (0.02)	0.7 (0.03)	1.4 (0.06)
EWL* mm (in.)	3.5 (0.14)	7.0 (0.28)	11.0 (0.44)	12.0 (0.48)
Mass grams	0.31	0.43	0.45	0.44
Price	\$125	\$163	\$125	\$71

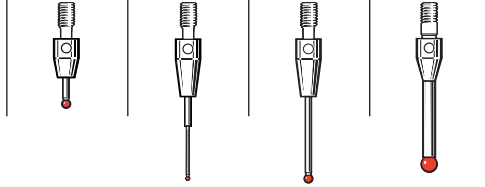

Disk styli

Part number	A-5000-3611 Ruby	A-5004-1387 Silver steel	A-5004-1395 Silver steel	A-5004-1396 Silver steel	A-5000-7809 Silver steel
Disk dia. mm (in.)	6.0 (0.24)	10.0 (0.39)	12.0 (0.47)	14.0 (0.55)	18.0 (0.71)
Disk depth mm (in.)	1.2 (0.05)	1.2 (0.05)	1.6 (0.06)	1.6 (0.06)	1.6 (0.06)
Roller depth mm (in.)	2.0 (0.08)	2.0 (0.08)	2.5 (0.10)	2.5 (0.10)	2.5 (0.10)
Stem dia. mm (in.)	2.0 (0.08)	2.0 (0.08)	4.2 (0.17)	4.2 (0.17)	4.2 (0.17)
Mass grams	0.6	1.0	2.0	2.5	3.0
Price	\$70	\$103	\$121	\$121	\$89

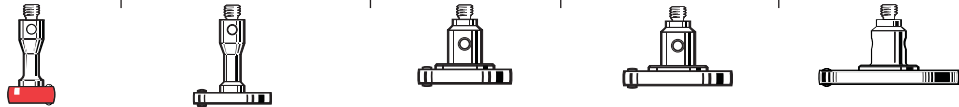

Part number	A-5000-3613 Silver steel	A-5000-7810 Silver steel	A-5000-4187 Silver steel
Disk dia. mm (in.)	18.0 (0.71)	25.0 (0.99)	25.0 (0.99)
Disk depth mm (in.)	2.3 (0.10)	1.6 (0.06)	3.1 (0.13)
Roller depth mm (in.)	3.0 (0.12)	2.5 (0.10)	N/A
Stem dia. mm (in.)	N/A	4.2 (0.17)	N/A
Mass grams	2.7	4.0	3.8
Price	\$105	\$89	\$99

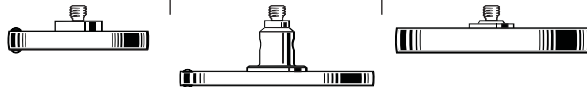

Cylinder styli

Part number	A-5004-7589 Silver steel	A-5004-7590 Silver steel	A-5000-8876 Ruby	A-5000-8877 Ruby	A-5000-7812 Ruby	A-5003-0073 Ruby
Cylinder dia. mm (in.)	1.5 (0.06)	3.0 (0.12)	1.0 (0.04)	1.5 (0.06)	2.0 (0.08)	4.0 (0.16)
Overall length mm (in.)	10.75 (0.42)	12.75 (0.50)	15.0 (0.60)	15.0 (0.60)	21.2 (0.83)	22.0 (0.87)
Stem dia. mm (in.)	1.0 (0.04)	1.5 (0.06)	N/A	N/A	1.6 (0.07)	2.0 (0.08)
EWL* mm (in.)	1.25 (0.05)	3.8 (0.15)	8.0 (0.32)	8.0 (0.32)	7.2 (0.29)	10.0 (0.40)
Mass grams	0.3	0.6	0.3	0.3	0.5	0.9
Price	\$26	\$26	\$185	\$270	\$147	\$130

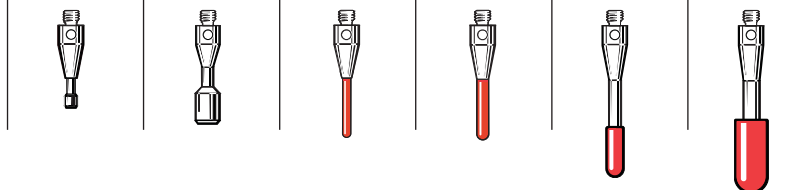

* Effective working length

Parallel hemispherical-ended styli (tungsten carbide)

Part number	A-5003-1208	A-5003-1210	A-5003-1218	A-5003-1219	A-5003-1228	A-5003-0074	A-5003-1258
Cylinder dia. mm (in.)	0.3 (0.012)	0.5 (0.02)	1.0 (0.04)	1.5 (0.06)	2.0 (0.08)	2.0 (0.08)	3.0 (0.12)
Overall length mm (in.)	10.2 (0.41)	15.3 (0.61)	35.5 (1.40)	15.8 (0.63)	16.0 (0.63)	40.0 (1.58)	22.5 (0.89)
EWL* mm (in.)	2.7 (0.11)	7.8 (0.31)	28.0 (1.10)	8.3 (0.33)	8.5 (0.34)	32.0 (1.26)	22.5 (0.89)
Mass grams	0.3	0.3	0.7	0.6	0.8	2.0	2.0
Price	\$220	\$190	\$160	\$85	\$85	\$87	\$155

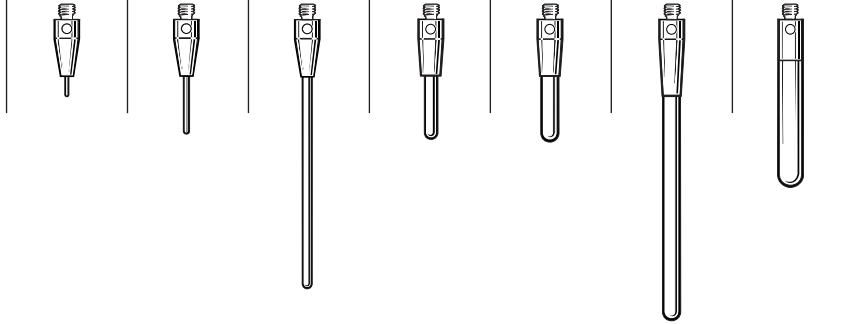

Stylus extensions (stainless steel)

Part number	A-5004-7610	A-5004-7585	A-5004-7586	A-5004-7591	A-5004-7611
Length mm (in.)	5.0 (0.20)	10.0 (0.40)	20.0 (0.79)	30.0 (1.19)	40.0 (1.58)
Stem dia. mm (in.)	3.0 (0.12)	3.0 (0.12)	3.0 (0.12)	3.0 (0.12)	3.0 (0.12)
Mass grams	0.2	0.4	0.9	1.4	1.8
Price	\$12	\$13	\$15	\$17	\$19

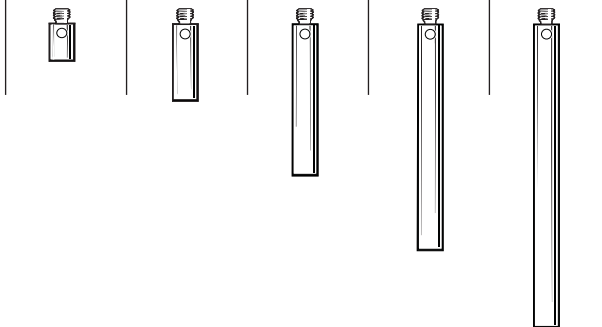

Stylus extensions (ceramic)

Part number	A-5003-0070	A-5003-0071	A-5003-0072
Length mm (in.)	30.0 (1.19)	40.0 (1.58)	50.0 (1.97)
Stem dia. mm (in.)	3.0 (0.12)	3.0 (0.12)	3.0 (0.12)
Mass grams	0.97	1.22	1.51
Price	\$58	\$58	\$60

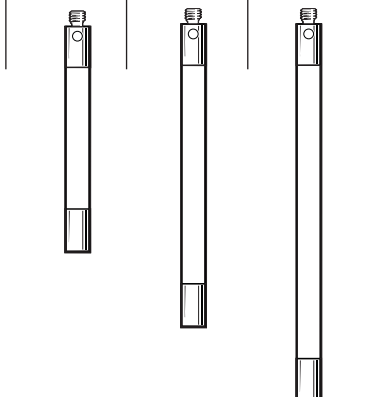

** Special * Effective working length

M2 styli

Stylus extensions (carbon fiber)

Part number	A-5003-2280	A-5003-2281	A-5003-2282	A-5003-2283
Length mm (in.)	40.0 (1.58)	50.0 (1.97)	70.0 (2.76)	90.0 (3.55)
Stem dia. mm (in.)	3.0 (0.12)	3.0 (0.12)	3.0 (0.12)	3.0 (0.12)
Outer dia. mm (in.)	3.5 (0.14)	3.5 (0.14)	3.5 (0.14)	3.5 (0.14)
Mass grams	0.9	1.0	1.3	1.5
Price	\$97	\$101	\$105	\$110

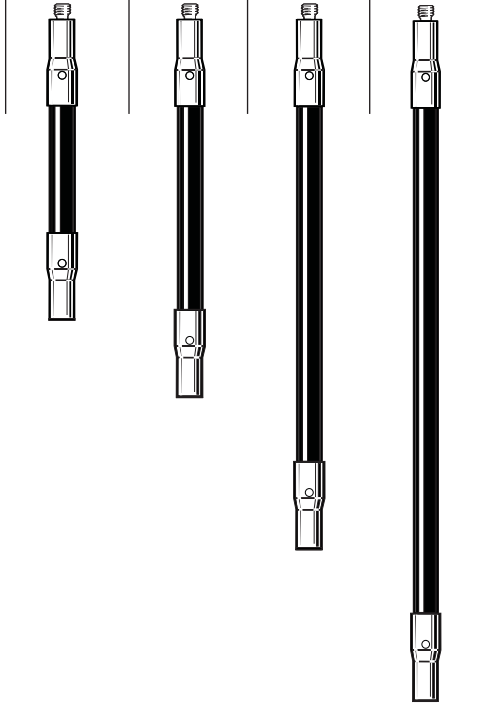

Special purpose styli

Part number	A-5004-7588 Silver steel	A-5000-7813 Tungsten carbide	A-5000-3614 Ceramic
Length mm (in.)	15.0 (0.60)	10.0 (0.40)	11.0 (0.44)
Ball dia. mm (in.)	N/A	N/A	18.0 (0.71)
End feature mm (in.)	Flat rad. 0.05 (0.002)	Spherical rad. 0.1 (0.004)	N/A
Angles	30° inclusive	30° inclusive	N/A
Mass grams	0.7	0.7	3.3
Price	\$25	\$67	\$279

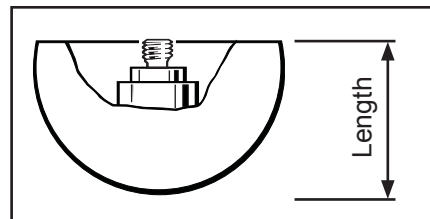

M3 threaded stylus range

Ruby ball styli (stainless steel stems)

Ball material	Part number						
Ruby	A-5000-3551	A-5000-3552	A-5000-3553	A-5000-7606	A-5000-7630	A-5000-3554	A-5000-7648
Price	\$32	\$32	\$32	\$32	\$32	\$32	\$32
Silicon nitride	A-5004-1979	A-5003-5723	A-5003-6257**	A-5003-5061	A-5003-6695**	A-5004-1980	A-5004-1981
Price	\$69	\$69	\$69	\$69	\$78	\$69	\$78
Zirconia	A-5004-2955	A-5003-5736	A-5004-2956	A-5003-5737	A-5003-9500	A-5004-2957	A-5004-2958
Price	\$84	\$84	\$84	\$84	\$94	\$84	\$94
A Ball dia. mm (in.)	1.0 (0.04)	2.0 (0.08)	3.0 (0.12)	4.0 (0.16)	5.0 (0.20)	4.0 (0.16)	5.0 (0.20)
B Length mm (in.)	21.0 (0.83)	21.0 (0.83)	21.0 (0.83)	21.0 (0.83)	21.0 (0.83)	31.0 (1.23)	31.0 (1.23)
C Stem dia. mm (in.)	0.7 (0.03)	1.4 (0.06)	1.5 (0.06)	2.5 (0.10)	2.5 (0.10)	2.5 (0.10)	3.5 (0.14)
D EWL* mm (in.)	4.0 (0.16)	9.6 (0.38)	14.7 (0.58)	17.2 (0.68)	21.0 (0.83)	27.0 (1.07)	31.0 (1.23)
Mass grams	1.0	1.0	1.0	1.3	1.5	2.5	3.0

21 mm – 31 mm range

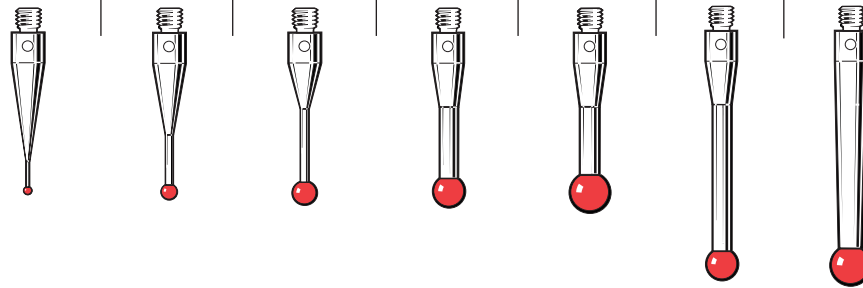

Ruby ball styli (tungsten carbide stems)

Ball material	Part number						
Ruby	A-5000-7632	A-5003-0050	A-5003-0054	A-5003-0051	A-5003-0052	A-5003-0055	A-5003-0057
Price	\$98	\$44	\$44	\$49	\$44	\$44	\$44
Silicon nitride	A-5004-2023**	A-5004-1198	A-5004-1982	A-5003-8091**	A-5003-5724	A-5004-1983	A-5004-1984**
Price	\$323	\$86	\$86	\$86	\$86	\$86	\$86
Zirconia	A-5004-2959	A-5004-2960	A-5004-2961	A-5004-2962	A-5003-5738	A-5004-2963	A-5003-6766
Price	\$230	\$104	\$104	\$104	\$104	\$104	\$104
A Ball dia. mm (in.)	0.5 (0.02)	1.5 (0.06)	2.5 (0.10)	1.5 (0.06)	2.0 (0.08)	2.5 (0.10)	3.0 (0.12)
B Length mm (in.)	21.0 (0.83)	20.0 (0.79)	20.2 (0.80)	30.0 (1.19)	30.0 (1.19)	30.0 (1.19)	30.0 (1.19)
C Stem dia. mm (in.)	0.4 (0.02)	1.0 (0.04)	2.0 (0.08)	1.0 (0.04)	1.5 (0.06)	2.0 (0.08)	2.0 (0.08)
D EWL* mm (in.)	2.0 (0.08)	12.5 (0.50)	12.5 (0.50)	22.5 (0.89)	22.8 (0.90)	22.5 (0.89)	24.0 (0.94)
Mass grams	1.0	0.8	1.3	0.93	1.32	1.81	1.83

20 mm – 30 mm range

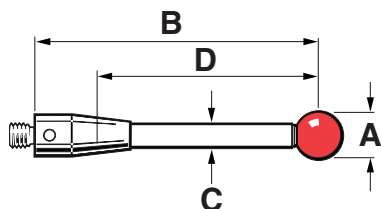
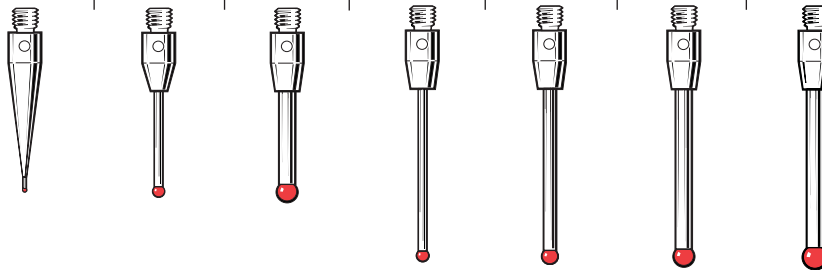

** Special * Effective working length

M3 styli

Ruby ball styli (tungsten carbide stems) – continued

Ball material	Part number					
Ruby	A-5003-0053	A-5003-0056	A-5003-0058	A-5003-0060	A-5003-0062	
Price	\$49	\$49	\$49	\$44	\$74	
Silicon nitride	A-5004-1985	A-5004-1986	A-5004-1987	A-5004-1195	A-5004-1718	
Price	\$86	\$86	\$86	\$86	\$103	
Zirconia	A-5003-2043**	A-5004-2964	A-5004-2965	A-5003-6767	A-5004-2966	
Price	\$104	\$104	\$104	\$104	\$115	
A	Ball dia. mm (in.)	2.0 (0.08)	2.5 (0.10)	3.0 (0.12)	4.0 (0.16)	5.0 (0.20)
B	Length mm (in.)	40.0 (1.58)	40.0 (1.58)	40.0 (1.58)	40.0 (1.58)	40.0 (1.58)
C	Stem dia. mm (in.)	1.5 (0.06)	2.0 (0.08)	2.0 (0.08)	2.0 (0.08)	2.5 (0.10)
D	EWL* mm (in.)	32.5 (1.28)	32.5 (1.28)	33.7 (1.33)	36.0 (1.42)	40.0 (1.58)
	Mass grams	1.58	2.28	2.30	2.38	3.50

40 mm range

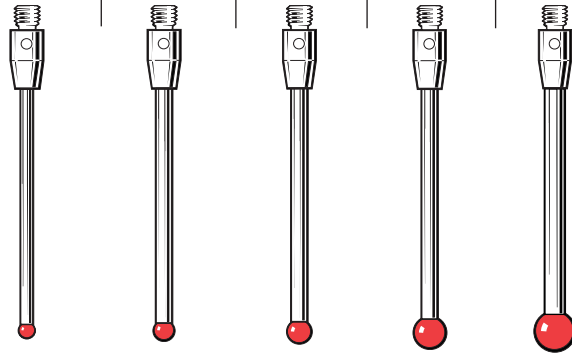

Ruby ball styli (tungsten carbide stems)

Ball material	Part number			
Ruby	A-5003-0059	A-5003-0061	A-5003-0063	
Price	\$53	\$53	\$53	
Silicon nitride	A-5004-1199	A-5004-1988	A-5004-1201	
Price	\$86	\$86	\$95	
Zirconia	A-5004-2968	A-5003-6768	A-5003-7665**	
Price	\$104	\$104	\$115	
A	Ball dia. mm (in.)	3.0 (0.12)	4.0 (0.16)	5.0 (0.20)
B	Length mm (in.)	50.0 (1.97)	50.0 (1.97)	50.0 (1.97)
C	Stem dia. mm (in.)	2.0 (0.08)	2.0 (0.08)	2.5 (0.10)
D	EWL* mm (in.)	43.7 (1.72)	46.0 (1.82)	50.0 (1.97)
	Mass grams	2.78	2.85	4.10

50 mm range

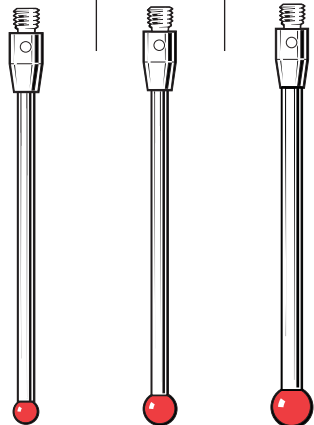

Ruby ball styli (ceramic stems)

Ball material	Part number			
Ruby	A-5003-0067	A-5003-0068	A-5003-0069	
Price	\$70	\$70	\$70	
Silicon nitride	A-5004-1989	A-5003-5725	A-5004-1990	
Price	\$103	\$103	\$112	
Zirconia	A-5004-2969	A-5003-5739	A-5004-2970	
Price	\$125	\$125	\$136	
A	Ball dia. mm (in.)	3.0 (0.12)	4.0 (0.16)	5.0 (0.20)
B	Length mm (in.)	50.0 (1.97)	50.0 (1.97)	50.0 (1.97)
C	Stem dia. mm (in.)	2.0 (0.08)	2.0 (0.08)	2.5 (0.10)
D	EWL* mm (in.)	43.7 (1.72)	46.0 (1.82)	50.0 (1.97)
	Mass grams	1.17	1.24	1.33

50 mm range

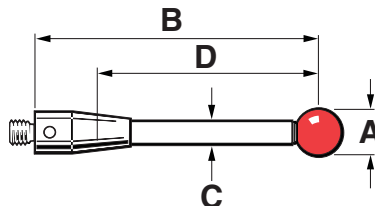
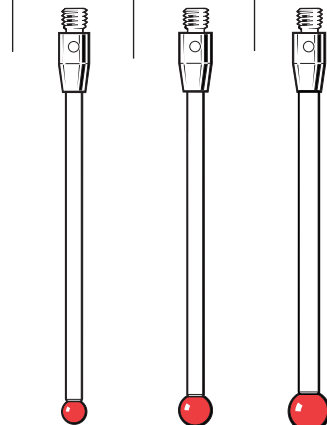

* Effective working length

** Special

Ruby ball styli (carbon fiber stems)

Ball material	Part number			
Ruby	A-5003-4860	A-5003-4862	A-5003-4861	A-5003-4863
Price	\$158	\$180	\$168	\$190
Silicon nitride	A-5003-5726	A-5004-1991	A-5003-5727	A-5004-5466
Price	\$129	\$147	\$147	\$155
Zirconia	A-5003-5740	A-5003-6771	A-5003-5741	A-5003-6778**
Price	\$157	\$178	\$178	\$188
A Ball dia. mm (in.)	6.0 (0.24)	8.0 (0.32)	6.0 (0.24)	8.0 (0.32)
B Length mm (in.)	75.0 (2.96)	75.0 (2.96)	100.0 (3.94)	100.0 (3.94)
C Stem dia. mm (in.)	4.0 (0.16)	4.0 (0.16)	4.0 (0.16)	4.0 (0.16)
D EWL* mm (in.)	75.0 (2.96)	75.0 (2.96)	100.0 (3.94)	100.0 (3.94)
Mass grams	2.40	2.98	2.89	3.47

75 mm – 100 mm
range

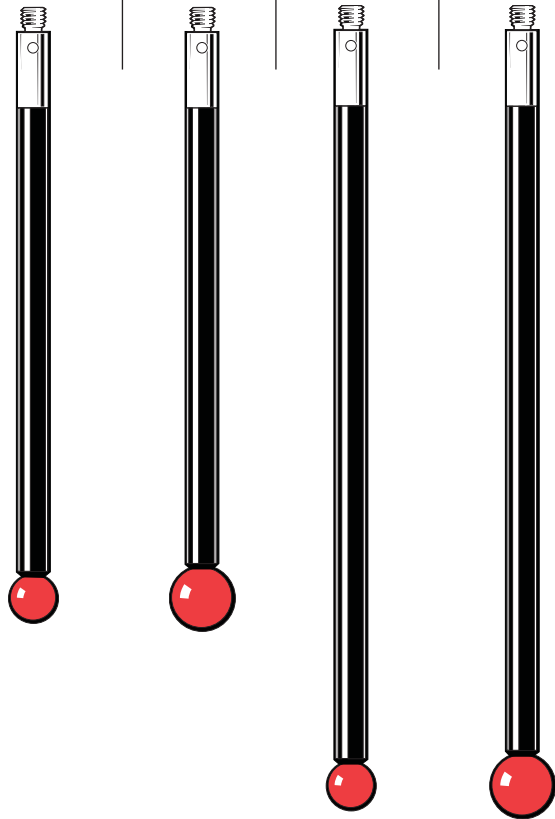

M3 styli

Ruby ball styli (carbon fiber stems) – continued

Ball material	Part number						
Ruby	A-5003-7057	A-5003-7056	A-5003-7055	A-5003-7054	A-5003-7445	A-5003-7446	A-5003-7447
Price	\$275	\$275	\$301	\$301	\$275	\$301	\$301
Silicon nitride	A-5004-1992	A-5004-1993	A-5004-1994	A-5004-1995	A-5004-1996	A-5004-1997	A-5004-1998
Price	\$293	\$293	\$293	\$293	\$310	\$310	\$310
Zirconia	A-5004-2972	A-5003-9495	A-5004-2973	A-5004-2974	A-5004-2975	A-5004-2976	A-5004-2977
Price	\$355	\$355	\$355	\$355	\$376	\$376	\$376
A Ball dia. mm (in.)	10.0 (0.40)	10.0 (0.40)	10.0 (0.40)	10.0 (0.40)	12.0 (0.48)	12.0 (0.48)	12.0 (0.48)
B Length mm (in.)	75.0 (2.96)	100.0 (3.94)	150.0 (5.91)	200.0 (7.88)	100.0 (3.94)	150.0 (5.91)	200.0 (7.88)
C Stem dia. mm (in.)	4.0 (0.16)	4.0 (0.16)	4.0 (0.16)	4.0 (0.16)	4.0 (0.16)	4.0 (0.16)	4.0 (0.16)
D EWL* mm (in.)	75.0 (2.96)	100.0 (3.94)	150.0 (5.91)	200.0 (7.88)	100.0 (3.94)	150.0 (5.91)	200.0 (7.88)
Mass grams	4.05	4.53	5.49	6.47	5.9	6.9	7.9

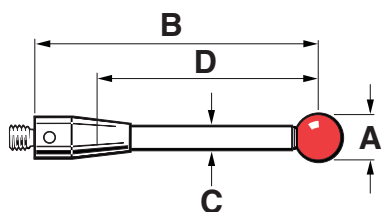
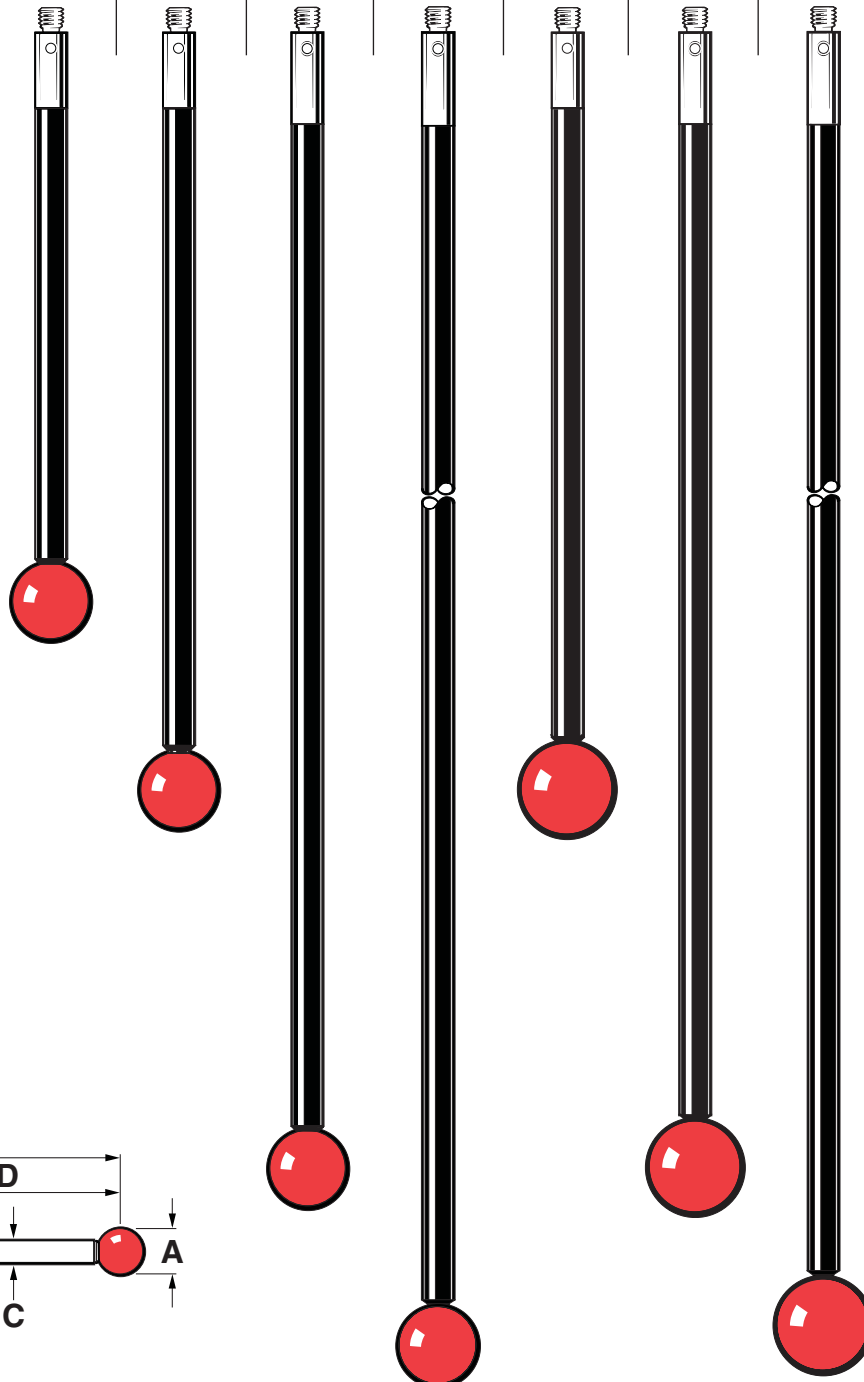

* Effective working length

Stylus extensions (stainless steel)

Part number	A-5004-7609	A-5004-7583	A-5004-7584
Length mm (in.)	10.0 (0.40)	20.0 (0.79)	35.0 (1.38)
Stem dia. mm (in.)	4.0 (0.16)	4.0 (0.16)	4.0 (0.16)
Mass grams	0.9	1.6	2.9
Price	\$13	\$15	\$12

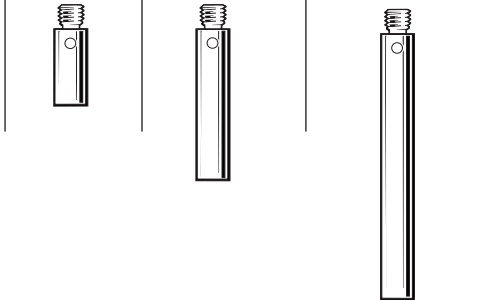

Stylus extensions (carbon fiber)

Part number	A-5003-4864	A-5003-4865
Length mm (in.)	75.0 (2.96)	100.0 (3.94)
Stem dia. mm (in.)	4.0 (0.16)	4.0 (0.16)
Mass grams	2.53	3.02
Price	\$102	\$110

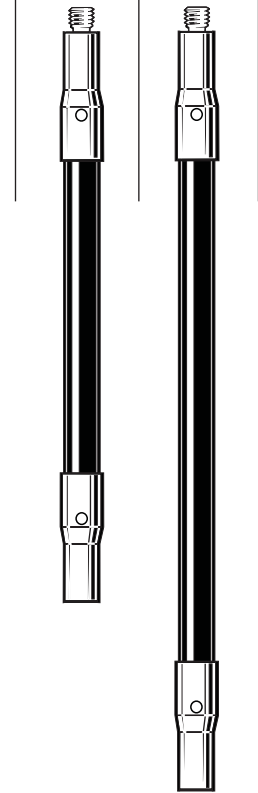

Stylus extensions (ceramic)

Part number	A-5003-0075
Length mm (in.)	50.0 (1.97)
Stem dia. mm (in.)	4.0 (0.16)
Mass grams	2.95
Price	\$58



M3 styli

Disk and hollow ball styli

Part number	A-5000-3615 Silver steel	A-5000-7612 Silver steel	A-5000-7669 Carbon steel
Disk dia. mm (in.)	12.7 (0.50)	35.0 (1.38)	63.5 (2.51)
Disk depth mm (in.)	2.2 (0.09)	5.0 (0.20)	6.0 (0.24)
Stem dia. mm (in.)	3.5 (0.14)	N/A	N/A
Mass grams	4.0	10.0	45.0
Price	\$74	\$126	\$134

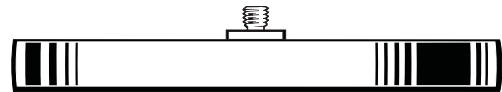
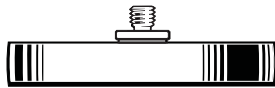
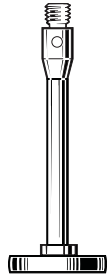

Part number	A-5000-7814 Ceramic	A-5003-7098 Ceramic
Disk dia. mm (in.)	30.0 (1.19)	30.0 (1.19)
Disk depth mm (in.)	17.0 (0.67)	1.5 (0.06)
Stem dia. mm (in.)	N/A	4.0 (0.16)
Mass grams	13.0	3.6
Price	\$343	\$300

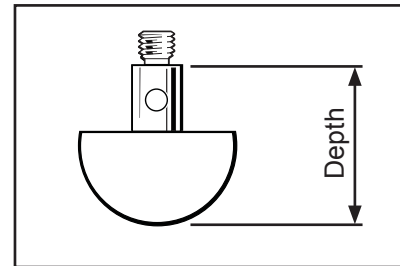
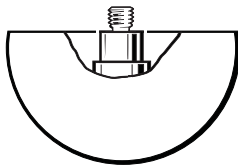

Star styli (fixed)

Part number	A-5003-0076	A-5003-0077
Span mm (in.)	30.0 (1.19)	50.0 (1.97)
Ball mm (in.)	2.0 (0.08)	2.0 (0.08)
Stem dia. mm (in.)	1.4 (0.06)	1.4 (0.06)
EWL* mm (in.)	11.0 (0.44)	11.0 (0.44)
Mass grams	2.38	5.25
Price	\$140	\$140

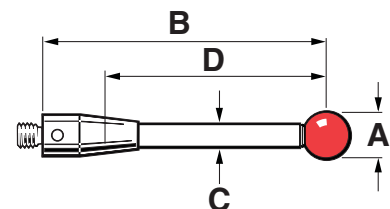
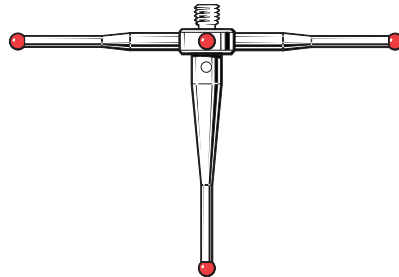
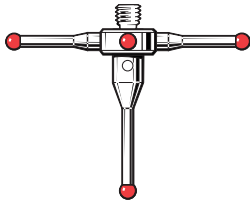

* Effective working length

M4 threaded stylus range

Ruby ball styli (stainless steel stems)

Ball material	Part number				
Ruby	A-5000-6350	A-5000-7545	A-5000-7547	A-5000-7549	A-5000-7551
Price	\$70	\$87	\$76	\$45	\$45
Silicon nitride	–	–	A-5003-5728	–	A-5003-5729
Price	–	–	\$71	–	\$63
Zirconia	–	–	A-5003-5742	–	A-5003-5743
Price	–	–	\$71	–	\$63
A Ball dia. mm (in.)	5.0 (0.20)	1.0 (0.04)	2.0 (0.08)	3.0 (0.12)	4.0 (0.16)
B Length mm (in.)	10.0 (0.39)	19.5 (0.77)	19.0 (0.75)	18.5 (0.73)	18.0 (0.71)
C Stem dia. mm (in.)	3.0 (0.12)	0.7 (0.03)	1.4 (0.05)	2.0 (0.08)	3.0 (0.12)
D EWL* mm (in.)	5.0 (0.20)	4.5 (0.18)	9.2 (0.36)	13.0 (0.52)	13.7 (0.54)
Mass grams	1.9	2.5	2.3	2.0	2.1

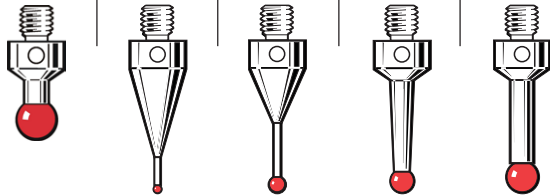

Part number	A-5000-7553	A-5000-6731	A-5000-6352	A-5000-7555	A-5000-7557
A Ball dia. mm (in.)	5.0 (0.20)	5.0 (0.20)	5.0 (0.20)	6.0 (0.24)	8.0 (0.32)
B Length mm (in.)	17.5 (0.69)	20.0 (0.79)	30.0 (1.19)	17.0 (0.67)	16.0 (0.63)
C Stem dia. mm (in.)	3.5 (0.14)	3.0 (0.12)	3.0 (0.12)	4.5 (0.18)	6.0 (0.24)
D EWL* mm (in.)	13.6 (0.54)	15.89 (0.63)	26.0 (1.03)	13.3 (0.52)	16.0 (0.63)
Mass grams	2.3	2.4	3.0	3.0	3.9
Price	\$45	\$70	\$70	\$50	\$67

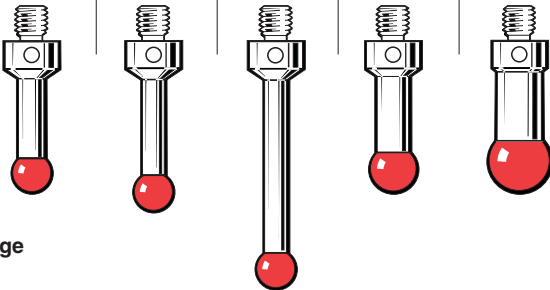

10 mm – 30 mm range

Ruby ball styli (tungsten carbide stems)

Part number	A-5003-4792	A-5003-2932	A-5003-4793	A-5003-4794	A-5003-4795	A-5003-4796
A Ball dia. mm (in.)	1.0 (0.04)	2.0 (0.08)	3.0 (0.12)	4.0 (0.16)	5.0 (0.20)	6.0 (0.24)
B Length mm (in.)	20.0 (0.79)	20.0 (0.79)	20.0 (0.79)	20.0 (0.79)	20.0 (0.79)	20.0 (0.79)
C Stem dia. mm (in.)	0.7 (0.03)	1.5 (0.06)	2.0 (0.08)	2.0 (0.08)	2.5 (0.10)	2.5 (0.10)
D EWL* mm (in.)	10.0 (0.40)	10.0 (0.40)	8.5 (0.33)	8.5 (0.33)	7.9 (0.31)	10.7 (0.42)
Mass grams	2.39	3.01	3.53	3.53	4.52	4.66
Price	\$77	\$86	\$86	\$86	\$92	\$92

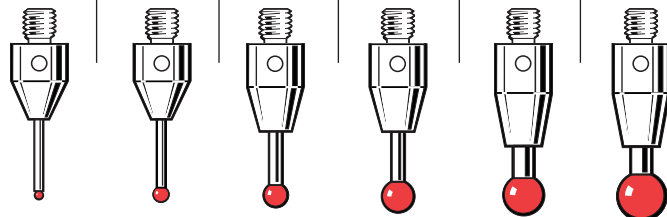

20 mm range

* Effective working length

M4 styli

Ruby ball styli

Part number	A-5003-0233 Ceramic	A-5000-7521 Stainless steel	A-5003-0235 Ceramic	A-5000-3709 Ceramic	A-5000-7795 Ceramic	
A	Ball dia. mm (in.)	4.0 (0.16)	5.0 (0.20)	5.0 (0.20)	6.0 (0.24)	8.0 (0.32)
B	Length mm (in.)	50.0 (1.97)	50.0 (1.97)	50.0 (1.97)	50.0 (1.97)	50.0 (1.97)
C	Stem dia. mm (in.)	3.0 (0.12)	4.5 (0.18)	3.8 (0.15)	4.5 (0.18)	4.5 (0.18)
D	EWL* mm (in.)	33.5 (1.32)	33.5 (1.32)	33.5 (1.32)	38.5 (1.52)	50.0 (1.97)
	Mass grams	3.9	5.8	5.0	4.8	5.4
	Price	\$70	\$70	\$82	\$97	\$108

50 mm range

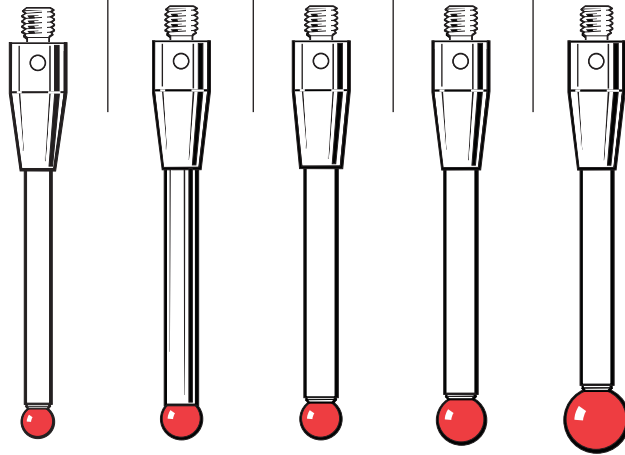

Part number	A-5003-4797 Tungsten carbide	A-5003-3680 Tungsten carbide	A-5003-4799 Tungsten Carbide	A-5003-4800 Tungsten carbide	A-5003-4801 Tungsten carbide	
A	Ball dia. mm (in.)	2.0 (0.08)	3.0 (0.12)	4.0 (0.16)	5.0 (0.20)	6.0 (0.24)
B	Length mm (in.)	50.0 (1.97)	50.0 (1.97)	50.0 (1.97)	50.0 (1.97)	50.0 (1.97)
C	Stem dia. mm (in.)	1.5 (0.06)	2.0 (0.08)	2.0 (0.08)	2.5 (0.10)	2.5 (0.10)
D	EWL* mm (in.)	40.0 (1.58)	38.5 (1.52)	38.5 (1.52)	37.9 (1.49)	40.7 (1.60)
	Mass grams	3.80	4.94	4.99	6.72	6.86
	Price	\$92	\$96	\$96	\$100	\$100

50 mm range

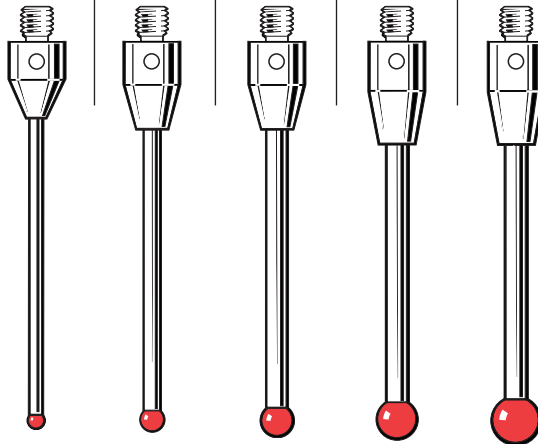

Part number	A-5003-0236 Ceramic	A-5003-2764 Ceramic	A-5003-4802 Ceramic	
A	Ball dia. mm (in.)	5.0 (0.20)	6.0 (0.24)	8.0 (0.32)
B	Length mm (in.)	75.0 (2.96)	75.0 (2.96)	75.0 (2.96)
C	Stem dia. mm (in.)	3.8 (0.15)	4.5 (0.18)	4.5 (0.18)
D	EWL* mm (in.)	58.5 (2.30)	63.5 (2.51)	75.0 (2.96)
	Mass grams	5.63	5.64	6.20
	Price	\$86	\$103	\$115

75 mm range

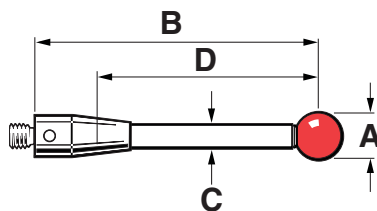
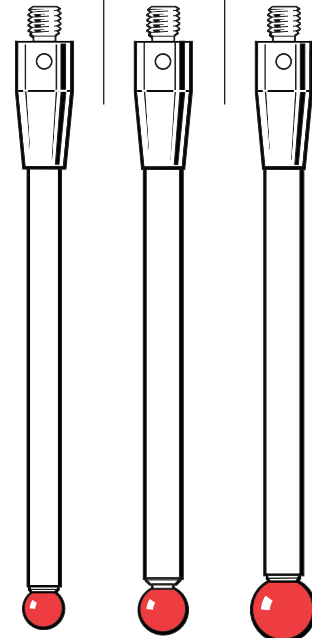

* Effective working length

Ruby ball styli

Part number	A-5000-7522 Stainless steel	A-5000-9761 Ceramic	A-5000-7523 Stainless steel	A-5000-3712 Ceramic	A-5000-8156 Ceramic	A-5000-7796 Ceramic	A-5003-3461 Carbon fiber
A Ball dia. mm (in)	5.0 (0.20)	5.0 (0.20)	5.0 (0.20)	6.0 (0.24)	6.0 (0.24)	8.0 (0.32)	8.0 (0.32)
B Length mm (in)	100.0 (3.94)	100.0 (3.94)	150.0 (5.91)	100.0 (3.94)	150.0 (5.91)	100.0 (3.94)	300.0 (11.82)
C Stem dia mm (in)	4.5 (0.18)	3.8 (0.15)	4.4 (0.17)	4.5 (0.18)	4.5 (0.18)	4.5 (0.18)	4.5 (0.18)
D EWL* mm (in)	83.2 (3.38)	83.5 (3.29)	133.00 (5.24)	88.5 (3.48)	135.0 (5.31)	100.0 (3.94)	300.0 (11.82)
Mass grams	11.3	6.3	17.4	6.3	7.9	7.5	10.4
Price	\$79	\$150	\$88	\$109	\$170	\$140	\$430

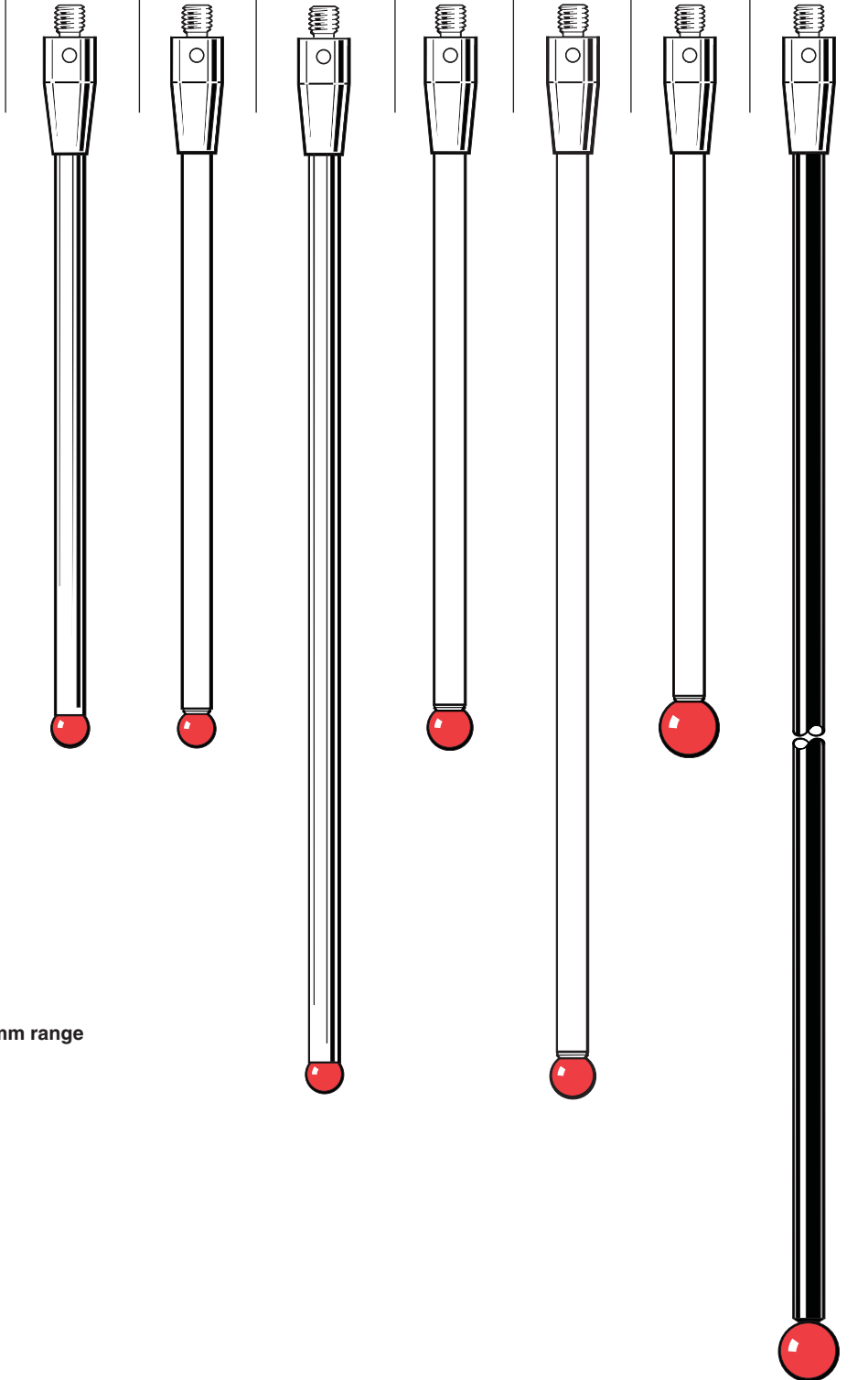

100 mm – 300 mm range

* Effective working length

M4 styli

Ruby ball styli (carbon fiber stems)

Recommended for use with OMP400 and RMP600

Ball material	Part number			
Ruby	A-5003-7306	A-5003-6510	A-5003-6511	A-5003-6512
Price	\$128	\$145	\$274	\$289
Silicon nitride	A-5003-5730	A-5003-5731	–	–
Price	\$221	\$240	–	–
Zirconia	A-5003-5744	A-5003-5745	–	–
Price	\$221	\$240	–	–
A Ball dia. mm (in)	6.0 (0.24)	6.0 (0.24)	6.0 (0.24)	6.0 (0.24)
B Length mm (in)	50.0 (1.97)	100.0 (3.94)	150.0 (5.91)	200.0 (7.88)
C Stem dia mm (in)	4.5 (0.18)	4.5 (0.18)	4.5 (0.18)	4.5 (0.18)
D EWL* mm (in)	38.5 (1.52)	88.5 (3.48)	138.5 (5.45)	188.5 (7.42)
Mass grams	4.1	6.2	7.5	8.7

A-5003-1436	A-5003-1358	A-5003-1255	A-5003-1075
\$128	\$145	\$274	\$289
–	–	–	–
–	–	–	–
–	–	–	–
–	–	–	–
6.0 (0.24)	6.0 (0.24)	6.0 (0.24)	6.0 (0.24)
50.0 (1.97)	100.0 (3.94)	150.0 (5.91)	200.0 (7.88)
4.5 (0.18)	4.5 (0.18)	4.5 (0.18)	4.5 (0.18)
38.5 (1.52)	88.5 (3.58)	138.5 (5.46)	188.5 (7.42)
4.1	6.2	7.5	8.7

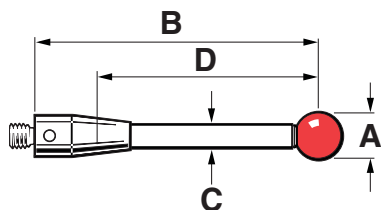
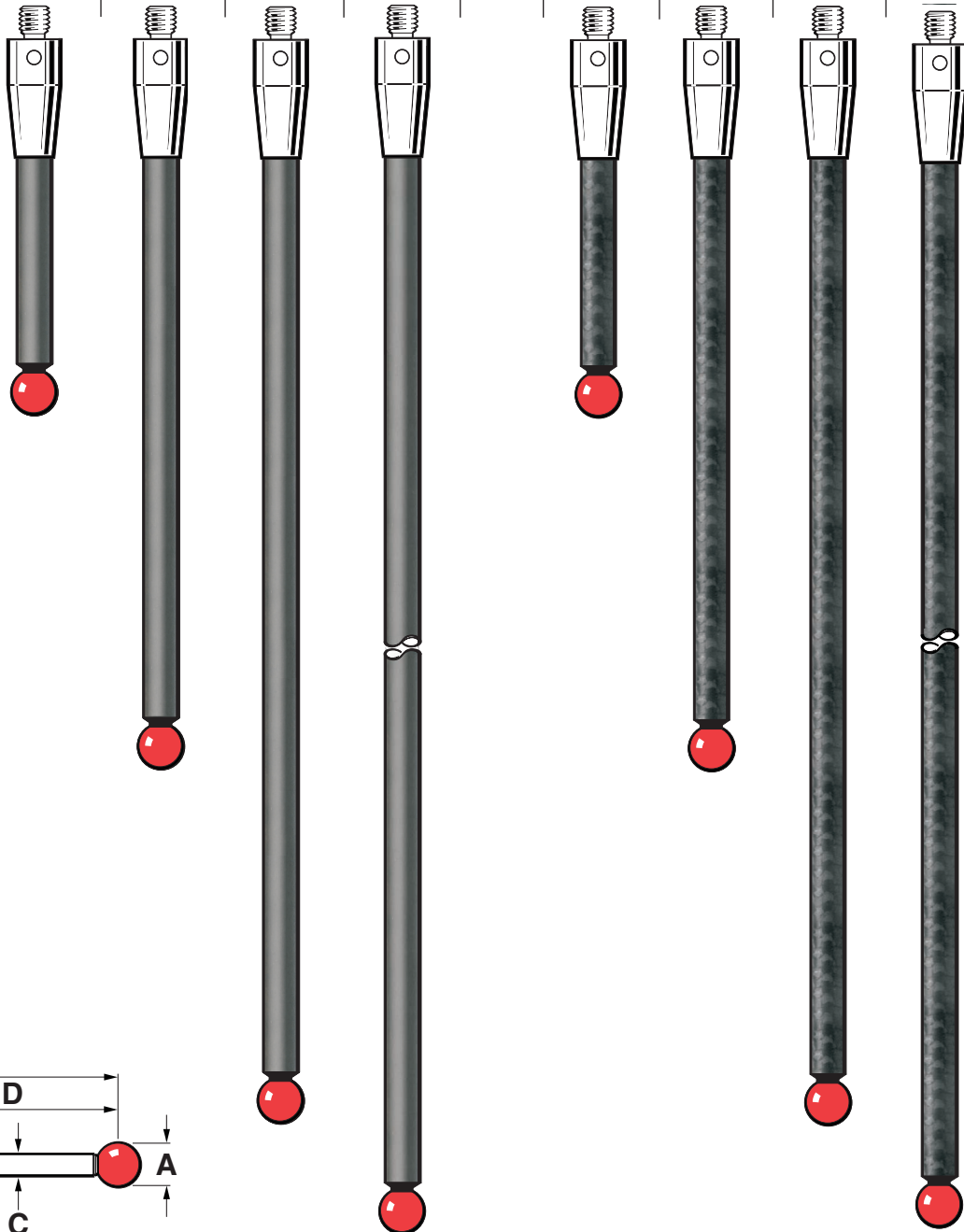

* Effective working length

Star styli

Part number	A-5000-6462 Ceramic	A-5000-7098 Ceramic
Ball mm (in.)	6.0 (0.24)	6.0 (0.24)
Length mm (in.)	100.0 (3.94)	50.0 (1.97)
Stem dia. mm (in.)	4.5 (0.18)	4.5 (0.18)
EWL* mm (in.)	88.5 (3.48)	38.5 (1.52)
Mass grams	7.5	6.0
Price	\$94	\$89

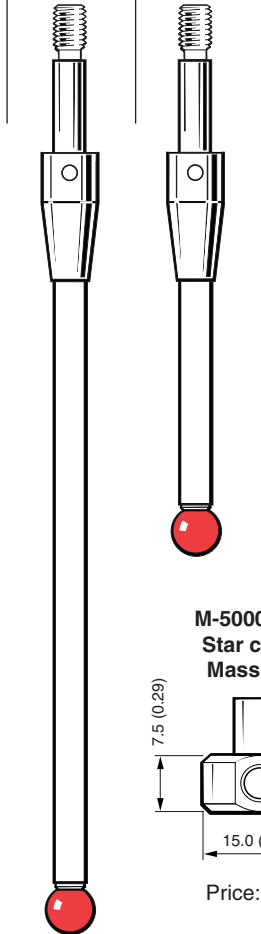

Disk styli

Part number	A-5000-7596	A-5000-7597	A-5000-7598
Diameter A mm (in.)	30.0 (1.19)	35.0 (1.38)	50.0 (1.97)
Diameter B mm (in.)	21.0 (0.83)	21.0 (0.83)	23.0 (0.91)
C mm (in.)	2.2 (0.09)	2.2 (0.09)	3.0 (0.12)
D mm (in.)	3.0 (0.12)	3.0 (0.12)	4.0 (0.16)
Mass grams	8.01	9.57	13.55
Price	\$114	\$109	\$119

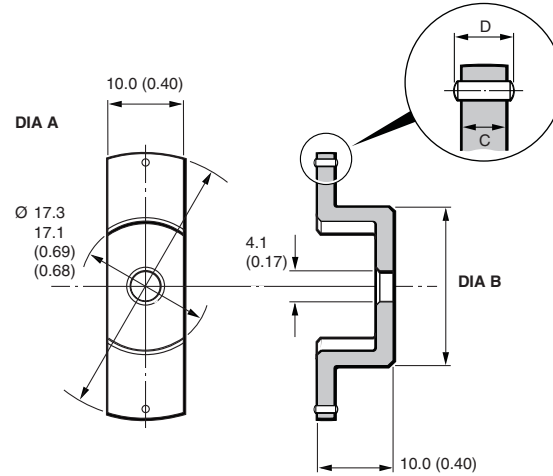

Part number	A-5000-6351 Silver steel
Disk dia. mm (in.)	30.0 (1.18)
Disk depth mm (in.)	3.0 (0.12)
Length mm (in.)	10.0 (0.39)
Rollers	NO
Mass grams	7.9
Price	\$165

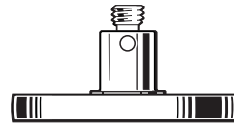

Swivel adaptor

Part number	A-5004-7607	A-5004-7608
Length A mm (in.)	10.0 (0.40)	13.5 (0.54)
Length B mm (in.)	12.5 (0.50)	16.0 (0.63)
Mass grams	2.76	3.70
Price	\$50	\$50

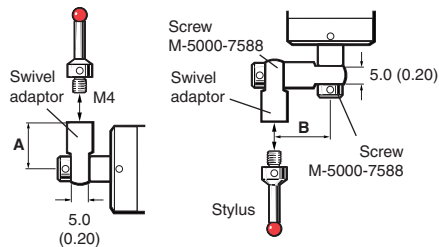

Stylus crank

Part number	A-5004-7605	A-5004-7606
Length A mm (in.)	21.9 (0.86)	27.6 (1.09)
Mass grams	6.07	6.94
Price	\$57	\$57

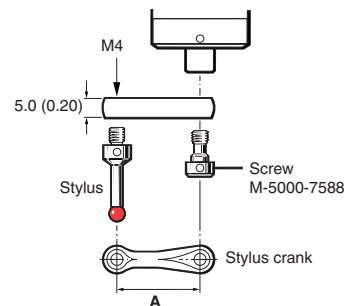

* Effective working length

M4 styli

Crash protection devices

Part number	A-5004-7598	A-5004-7603	A-5004-7604	A-5004-7621	* A-5003-0661	A-5004-7624	A-5004-6723
	Stainless steel	Stainless steel	Stainless steel	Silver steel	Silver steel	Silver steel	Silver steel
Price	\$8	\$5	\$5	\$25	\$25	\$25	\$25
For pack of ten	-	-	-	-	A-5004-1865	A-5004-1867	A-5004-1869
Price	-	-	-	-	\$165	\$165	\$165
Length mm (in.)	8.0 (0.32)	8.0 (0.32)	10.0 (0.40)	12.0 (0.48)	15.2 (0.60)	9.0 (0.36)	16.0 (0.63)
Mass grams	1.8	1.4	1.5	2.7	4.6	1.5	2.1
For use on	LP2	LP2	LP2	MP10	TS27R	HPMA	HPMA
	-	-	-	MP12	-	HPRA	HPRA
	-	-	-	RMP60	-	HPPA	HPPA
	-	-	-	OMP60	-	-	-
	-	-	-	MP3	-	-	-
	-	-	-	MP11	-	-	-

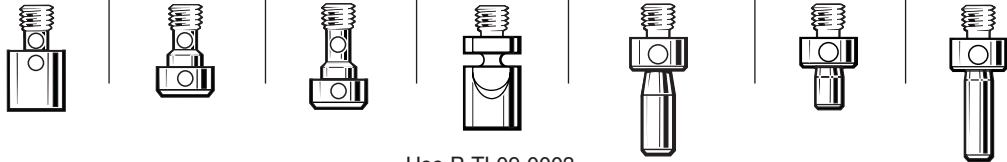

Use P-TL09-0003
to tighten

* Please note: If you require the full TS27R break stem kit, please order A-5003-5171.

Part number	A-5004-7616	A-5004-7618	A-5004-7619	A-5004-7620	A-5004-7622
	M3	M3	M3	M4	M4
	Silver steel	Silver steel	Silver steel	Silver steel	Silver steel
Length mm (in.)	13.3 (0.52)	22.3 (0.88)	30.3 (1.19)	13.5 (0.53)	19.0 (0.75)
Mass grams	2.43	3.6	4.5	1.37	2.2
Price	\$25	\$25	\$25	\$25	\$25
For use on	TS20	TS20	TS20	RP1/RP2	TSA

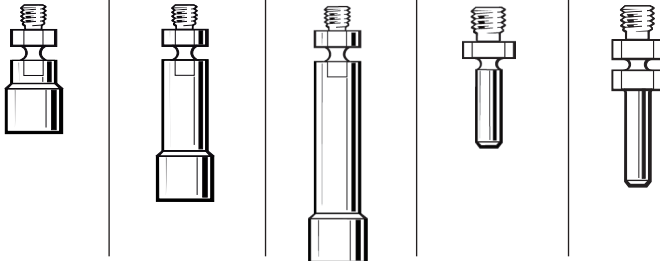

Cranked styli

Part number	A-5000-5302	A-5000-5307	A-5000-6620	A-5000-7580
	M4	M4	M4	M4
	Tungsten steel	Tungsten steel	Tungsten steel	Tungsten steel
Length mm (in.)	32.0 (1.26)	21.6 (0.85)	27.4 (1.08)	38.8 (1.53)
Mass grams	3.8	3.85	4.7	2.5
For use on	LP2	LP2	LP2	LP2
Price	\$122	\$122	\$122	\$52

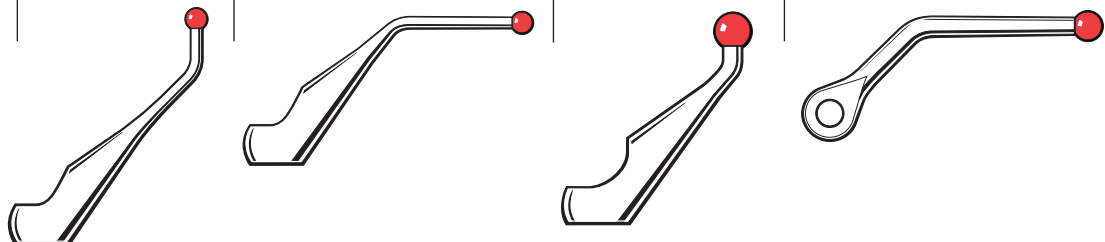

TS27R styli – parallel shafted (not M4) – not compatible with TS27 probes

Part number	A-2008-0382 Tungsten carbide	A-2008-0384 Ceramic
Overall length mm (in.)	23.0 (0.91)	22.0 (0.87)
Mass grams	12.1	7.1
Price	\$111	\$260

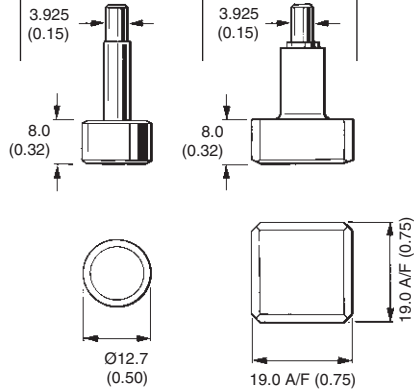

Stylus conversion kit for TS27R to allow horizontal machining applications (**A-2008-0448**)

Price: \$120

Stylus holder assembly
A-2008-0389
Price: \$25

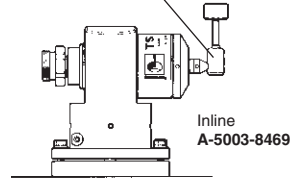

Vertical machining applications

Stylus holder
A-5004-7617*
Price: \$95

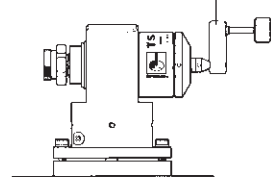

Horizontal machining applications

* Order also requires 2 x P-SC13-0404

Tool datuming styli

Part number	A-5000-3212 Stainless steel	A-5000-6701 Stainless steel	A-5000-6713 Aluminum	A-5000-6403 Stainless steel
Overall length mm (in.)	53.0 (2.09)	43.0 (1.70)	96.5 (3.80)	32.5 (1.28)
Stem dia. mm (in.)	4.5 (0.18)	4.5 (0.18)	7.5 (0.30)	5.4 (0.22)
Mass grams	4.5	4.3	21.9	11.0
Price	\$107	\$107	\$128	\$107

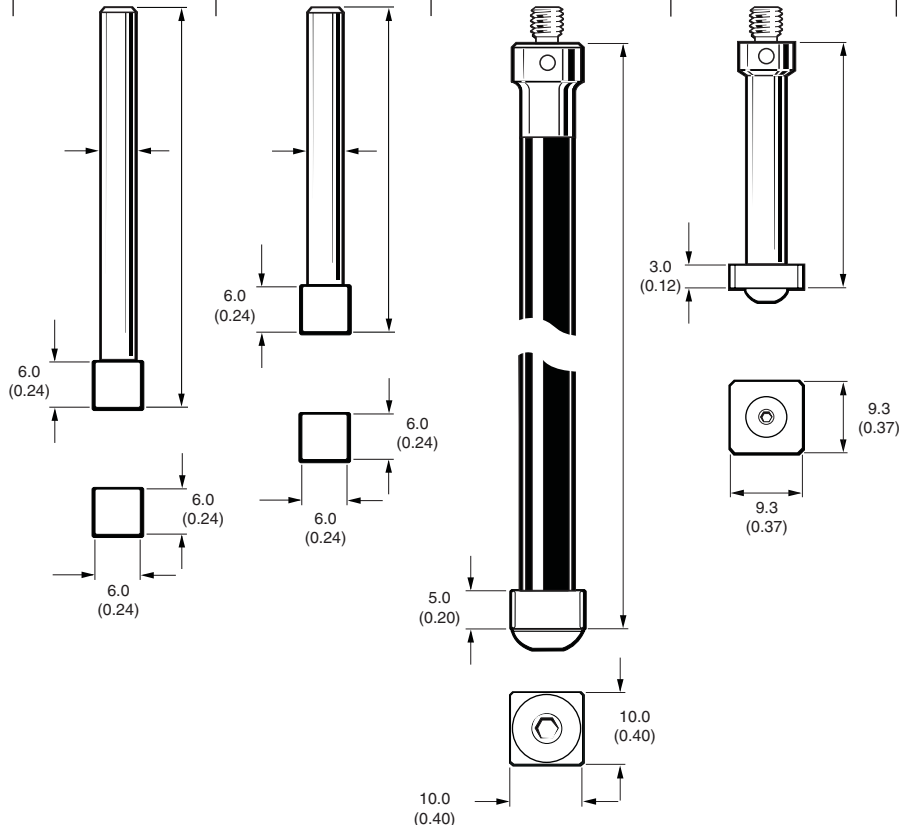

M4 styli

Tool datuming styli – continued

Part number	A-2197-0157 Tungsten steel	A-2197-0158 Tungsten steel	A-2197-0159 Tungsten steel	A-2197-0160 Tungsten steel	A-2197-0161 Tungsten steel	A-2197-0162 Tungsten steel
Length mm (in.)	14.2 (0.56)	19.5 (0.77)	29.5 (1.16)	34.5 (1.36)	39.5 (1.55)	49.5 (1.95)
Mass grams	14.86	16.0	20.0	20.7	21.8	23.5
Price	\$116	\$116	\$116	\$116	\$116	\$116
For use on	HPPA	HPPA	HPPA	HPPA	HPPA	HPPA
	HPMA	HPMA	HPMA	HPMA	HPMA	HPMA
	HPRA	HPRA	HPRA	HPRA	HPRA	HPRA
	RP3	RP3	RP3	RP3	RP3	RP3

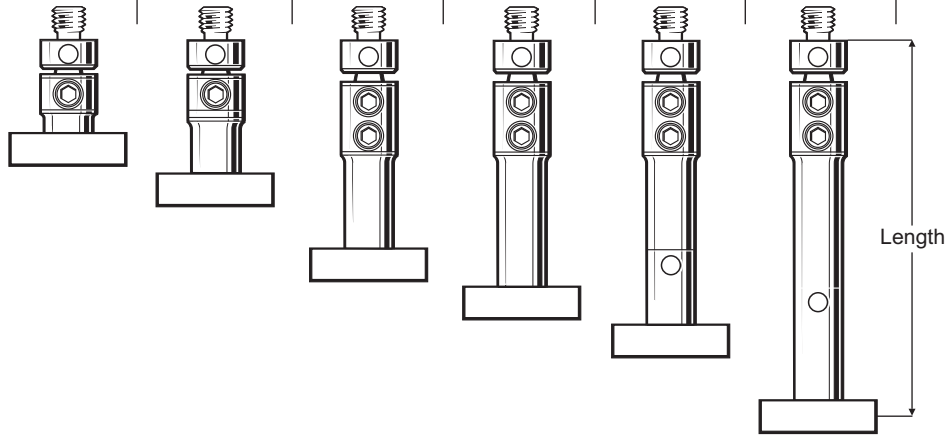

Part number	A-2008-0601 M3	A-2008-0602 M3	A-2008-0603 M3	A-2048-2050 M4	A-2048-2051 M4	A-2116-0140 M4	A-2116-0141 M4
	Tungsten steel	Tungsten steel	Tungsten steel	Tungsten steel	Tungsten steel	Tungsten steel	Tungsten steel
Length mm (in.)	15.4 (0.61)	24.0 (0.96)	32.4 (1.27)	23.2 (0.91)	32.0 (1.26)	32.0 (1.26)	42.0 (1.65)
Mass grams	9.1	8.0	8.95	18.14	20.64	13.56	16.05
Price	\$116	\$116	\$116	\$137	\$137	\$109	\$127
For use on	TS20	TS20	TS20	HPA (M6 MTG)	HPA (M6 MTG)	TSA	TSA

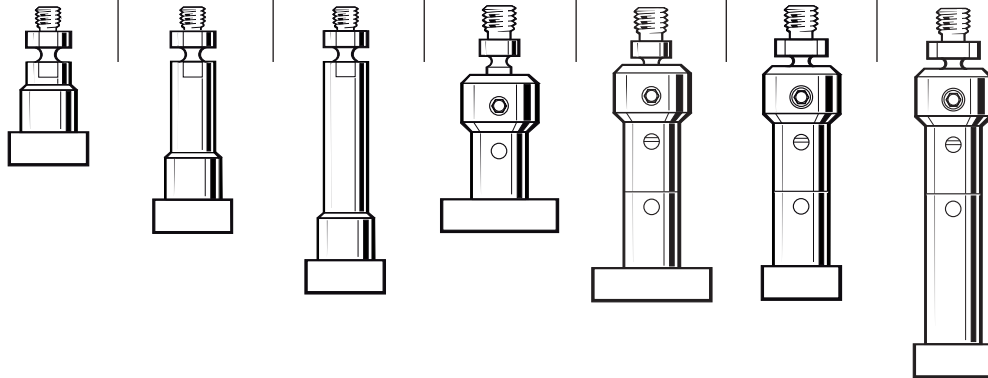

Part number	A-2116-0142
Length mm (in.)	30.3 (0.40)
Mass grams	22.6
Price	\$158
For use on	TSA

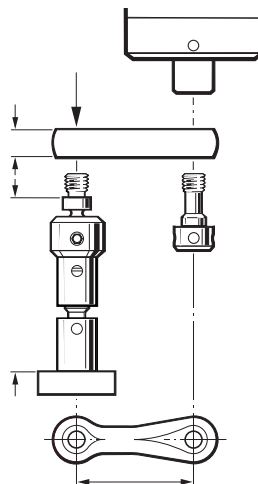

Stylus extensions

Part number	A-5004-7599 Stainless steel	A-5004-7600 Stainless steel	A-5004-7601 Stainless steel	A-5004-7602 Stainless steel	A-5000-7754 Ceramic	A-5000-7755 Ceramic	A-5000-7727 Ceramic	A-5003-0587 Ceramic
Length mm (in.)	10.0 (0.40)	15.0 (0.60)	20.0 (0.79)	30.0 (1.19)	30.0 (1.19)	50.0 (1.97)	100.0 (3.94)	200.0 (7.87)
Stem dia. mm (in.)	7.0 (0.28)	7.0 (0.28)	7.0 (0.28)	7.0 (0.28)	7.4 (0.29)	7.4 (0.29)	7.4 (0.29)	7.4 (0.29)
Mass grams	2.4	3.7	4.8	7.4	5.1	6.7	10.6	18.4
Price	\$36	\$36	\$36	\$36	\$51	\$60	\$154	\$165

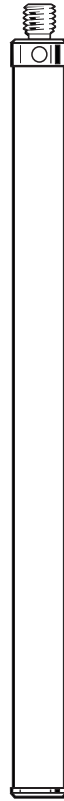

M4 styli

Tungsten carbide styli (stainless steel stems)

Part number	A-5000-7670	A-5000-7671	A-5000-7672	A-5000-9685	A-5000-9697
A Ball dia. mm (in.)	5.0 (0.20)	5.0 (0.20)	5.0 (0.20)	5.0 (0.20)	3.0 (0.12)
B Length mm (in.)	50.0 (1.97)	100.0 (3.94)	150.0 (5.91)	54.0 (2.12)	55.0 (2.17)
C Stem dia. mm (in.)	4.5 (0.18)	4.5 (0.18)	4.5 (0.18)	3.9 (0.15)	1.9 (0.07)
D EWL* mm (in.)	35.0 (1.38)	85.0 (3.35)	135.0 (5.31)	50.0 (1.97)	25.0 (0.99)
Mass grams	6.2	11.9	18.2	6.9	3.8
Price	\$70	\$79	\$88	\$159	\$147

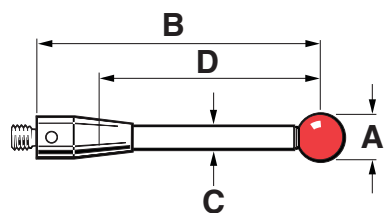
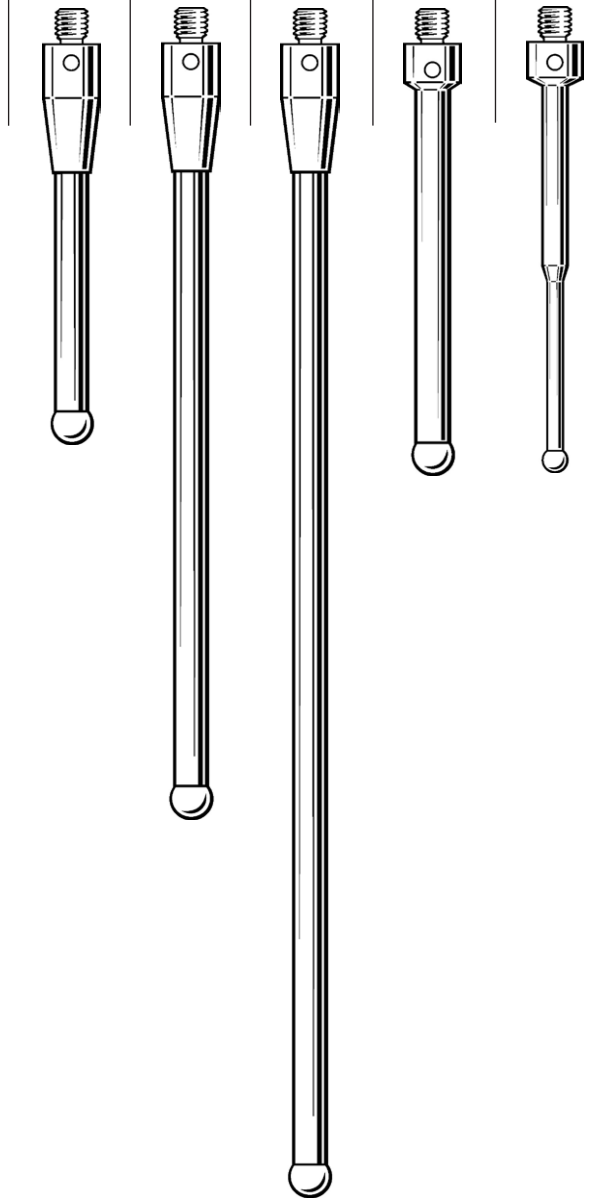

* Effective working length

Walter styli

M1.4 thread styli

Part number	A-5003-3814	A-5003-3045	A-5003-3042	A-5000-9860	A-5003-1699
	M1.4	M1.4	M1.4	M1.4	M1.4
Stem material	Tungsten carbide	Stainless steel	Tungsten carbide	Tungsten carbide	Stainless steel
Ball material	Tungsten carbide	Tungsten carbide	Ruby	Tungsten carbide	Tungsten carbide
A Ball dia. mm (in.)	0.5 (0.02)	1.0 (0.04)	0.5 (0.02)	1.0 (0.04)	0.6 (0.02)
B Length mm (in.)	12.5 (0.49)	25.0 (0.98)	12.5 (0.49)	13.0 (0.51)	12.75 (0.50)
D EWL* mm (in.)	1.5 (0.059)	1.5 (0.059)	3.0 (0.12)	1.0 (0.04)	1.0 (0.04)
Mass grams	0.2	1.1	0.19	0.22	0.41
Price	\$259	\$172	\$259	\$129	\$259



Adaptors

Part number	A-5003-1448	A-5000-9724
D3 MTG	2 x M1.4 adaptor 20°	M1.4 adaptor 20°
Mass grams	9.73	8.31
Price	\$172	\$172

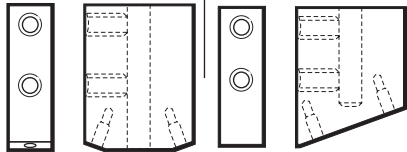

Crash protection device

Part number	A-5004-7615
Length mm (in.)	16.0 (0.63)
Mass grams	2
Price	\$60

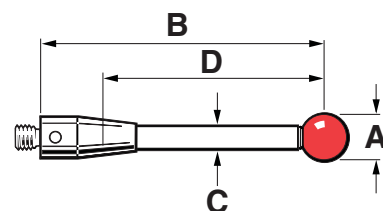

* Effective working length

M5 threaded stylus range

Ruby micro ball styli (tungsten carbide stems)

Part number	A-5003-5201	A-5003-5202	A-5003-5203	
A	Ball dia. mm (in.)	0.3 (0.012)	0.5 (0.02)	0.7 (0.03)
B	Length mm (in.)	20.0 (0.79)	20.0 (0.79)	20.0 (0.79)
C	Stem dia. mm (in.)	0.2 (0.01)	0.4 (0.02)	0.5 (0.02)
D	EWL* mm (in.)	3.0 (0.12)	4.0 (0.16)	5.0 (0.20)
	Mass grams	6.5	6.5	6.5
	Price	\$92	\$79	\$79

20 mm range

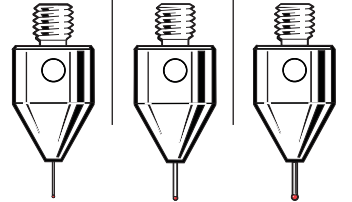

A-5003-5211	A-5003-5212	A-5003-5213
0.3 (0.012)	0.5 (0.02)	0.7 (0.03)
30.0 (1.19)	30.0 (1.19)	30.0 (1.19)
0.2 (0.01)	0.4 (0.02)	0.5 (0.02)
3.0 (0.12)	4.0 (0.16)	5.0 (0.20)
8.95	8.95	8.98
\$96	\$86	\$86

30 mm range

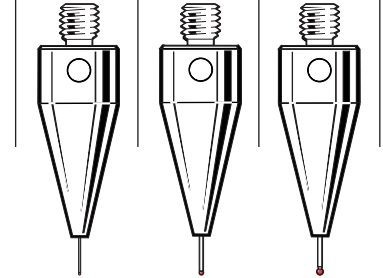

Part number	A-5003-5225	A-5003-5226	A-5003-5227	
A	Ball dia. mm (in.)	0.3 (0.012)	0.5 (0.02)	0.7 (0.03)
B	Length mm (in.)	50.0 (1.97)	50.0 (1.97)	50.0 (1.97)
C	Stem dia. mm (in.)	0.2 (0.01)	0.4 (0.02)	0.5 (0.02)
D	EWL* mm (in.)	3.0 (0.12)	4.0 (0.16)	5.0 (0.20)
	Mass grams	15.79	15.79	15.79
	Price	\$125	\$115	\$115

50 mm range

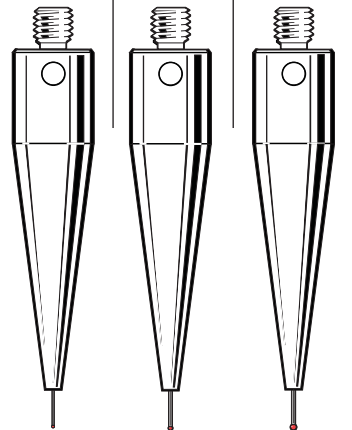

A-5003-5240	A-5003-5241	A-5003-5242
0.3 (0.012)	0.5 (0.02)	0.7 (0.03)
75.0 (2.96)	75.0 (2.96)	75.0 (2.96)
0.2 (0.01)	0.4 (0.02)	0.5 (0.02)
3.0 (0.12)	4.0 (0.16)	5.0 (0.20)
23.84	23.84	23.84
\$134	\$125	\$115

75 mm range

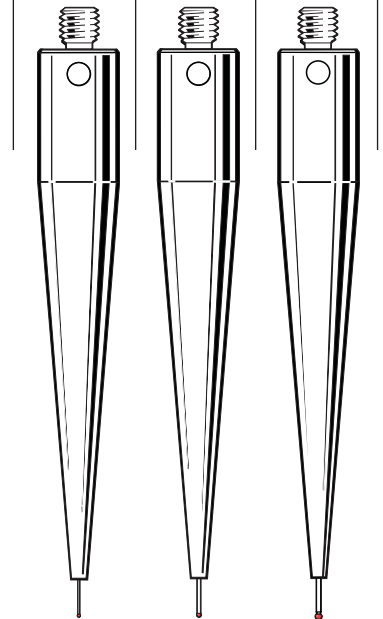

* Effective working length

Ruby ball styli (tungsten carbide stems)

Ball material	Part number						
Ruby	A-5003-5204	A-5003-5205	A-5003-5206	A-5003-5207	A-5003-5208	A-5003-5209	A-5003-5210
Price	\$71	\$61	\$61	\$61	\$61	\$67	\$67
Silicon nitride	–	–	A-5003-5732	–	–	A-5003-5733	–
Price	–	–	\$86	–	–	\$94	–
Zirconia	–	–	A-5003-5746	–	–	A-5003-5747	–
Price	–	–	\$86	–	–	\$94	–
A Ball dia. mm (in.)	1.0 (0.04)	1.5 (0.06)	2.0 (0.08)	2.5 (0.10)	3.0 (0.12)	4.0 (0.16)	5.0 (0.20)
B Length mm (in.)	20.0 (0.79)	20.0 (0.79)	20.0 (0.79)	20.0 (0.79)	20.0 (0.79)	20.0 (0.79)	20.0 (0.79)
C Stem dia. mm (in.)	0.7 (0.03)	1.0 (0.04)	1.0 (0.04)	1.5 (0.06)	2.0 (0.08)	2.0 (0.08)	3.0 (0.12)
D EWL* mm (in.)	5.0 (0.20)	11.0 (0.44)	11.0 (0.44)	11.0 (0.44)	11.0 (0.44)	11.9 (0.47)	11.5 (0.45)
Mass grams	6.52	4.68	4.70	4.84	5.12	5.19	6.06

20 mm range

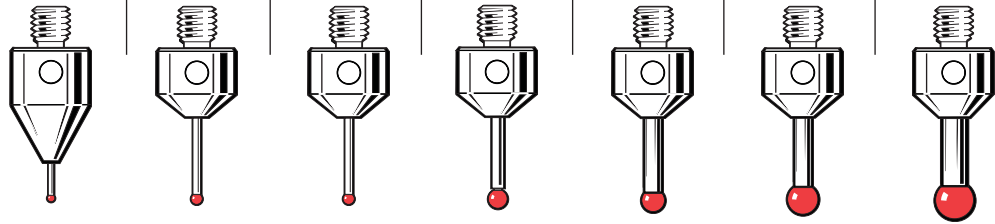

Part number	A-5003-5214	A-5003-5215	A-5003-5216	A-5003-5217	A-5003-5218	A-5003-5219	A-5003-5220
A Ball dia. mm (in.)	1.0 (0.04)	1.5 (0.06)	2.0 (0.08)	2.5 (0.10)	3.0 (0.12)	4.0 (0.16)	5.0 (0.20)
B Length mm (in.)	30.0 (1.19)	30.0 (1.19)	30.0 (1.19)	30.0 (1.19)	30.0 (1.19)	30.0 (1.19)	30.0 (1.19)
C Stem dia. mm (in.)	0.7 (0.03)	1.0 (0.04)	1.0 (0.04)	1.5 (0.06)	2.0 (0.08)	2.0 (0.08)	3.0 (0.12)
D EWL* mm (in.)	5.0 (0.20)	12.0 (0.48)	21.0 (0.83)	21.0 (0.83)	21.0 (0.83)	21.9 (0.86)	21.5 (0.85)
Mass grams	9.01	7.28	4.81	5.14	5.58	5.64	7.10
Price	\$77	\$46	\$67	\$67	\$67	\$72	\$77

30 mm range

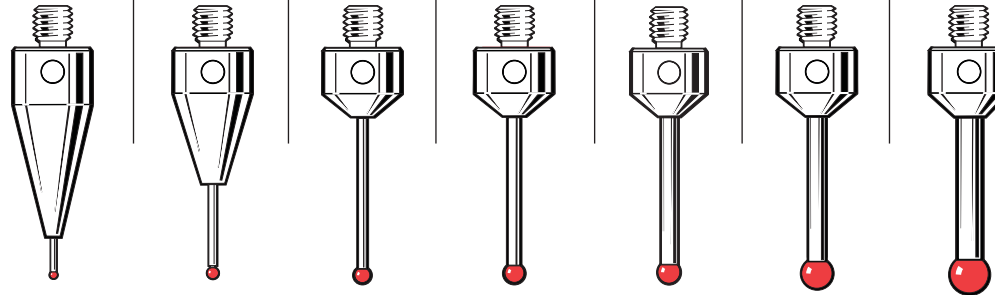

Part number	A-5003-5221	A-5003-5222	A-5003-5223	A-5003-5224
A Ball dia. mm (in.)	1.5 (0.06)	2.0 (0.08)	2.5 (0.10)	3.0 (0.12)
B Length mm (in.)	40.0 (1.58)	40.0 (1.58)	40.0 (1.58)	40.0 (1.58)
C Stem dia. mm (in.)	1.0 (0.04)	1.0 (0.04)	1.5 (0.06)	2.0 (0.08)
D EWL* mm (in.)	22.0 (0.87)	31.0 (1.23)	31.0 (1.23)	31.0 (1.23)
Mass grams	7.39	4.93	5.40	6.04
Price	\$96	\$86	\$86	\$86

40 mm range

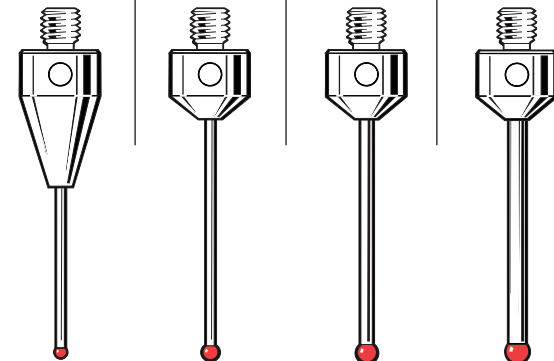

* Effective working length

M5 styli

Ruby ball styli (< 5 mm ball diameter) (tungsten carbide stems)

Part number	A-5003-5228	A-5003-5229	A-5003-5230	A-5003-5231	A-5003-5233	A-5003-5232	A-5003-5234	A-5003-5235	
A	Ball dia. mm (in.)	1.0 (0.04)	1.5 (0.06)	2.0 (0.08)	2.0 (0.08)	2.5 (0.10)	2.5 (0.10)	3.0 (0.12)	4.0 (0.16)
B	Length mm (in.)	50.0 (1.97)	50.0 (1.97)	50.0 (1.97)	50.0 (1.97)	50.0 (1.97)	50.0 (1.97)	50.0 (1.97)	50.0 (1.97)
C	Stem dia. mm (in.)	0.7 (0.03)	1.0 (0.04)	1.0 (0.04)	1.0 (0.04)	1.5 (0.06)	2.0 (0.08)	2.0 (0.08)	2.0 (0.08)
D	EWL* mm (in.)	5.0 (0.20)	5.0 (0.20)	41.0 (1.62)	5.0 (0.20)	5.0 (0.20)	41.0 (1.62)	41.0 (1.62)	41.9 (1.65)
	Mass grams	15.81	14.82	5.05	14.85	14.94	6.48	6.50	6.55
	Price	\$109	\$105	\$96	\$77	\$77	\$86	\$86	\$86

50 mm range

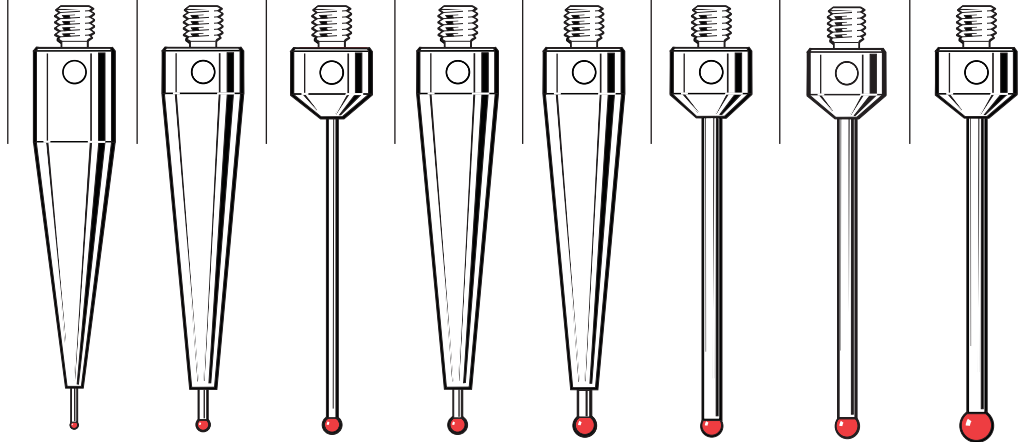

Ruby ball styli (≥ 5 mm ball diameter)

Ball material	Part number				
Ruby	A-5003-5236	A-5003-5237	A-5003-5238	A-5003-5239	
Price	\$86	\$96	\$105	\$115	
Silicon nitride	-	A-5003-5734	-	-	
Price	-	\$134	-	-	
Zirconia	-	A-5003-5748	-	-	
Price	-	\$134	-	-	
	Tungsten carbide	Carbon fiber	Carbon fiber	Carbon fiber	
A	Ball dia. mm (in.)	5.0 (0.20)	6.0 (0.24)	8.0 (0.32)	10.0 (0.40)
B	Length mm (in.)	50.0 (1.97)	50.0 (1.97)	50.0 (1.97)	50.0 (1.97)
C	Stem dia. mm (in.)	3.0 (0.12)	4.0 (0.16)	6.0 (0.24)	6.0 (0.24)
D	EWL* mm (in.)	41.5 (1.63)	39.5 (1.56)	39.5 (1.56)	44.5 (1.75)
	Mass grams	9.19	6.10	7.96	8.91

50 mm range

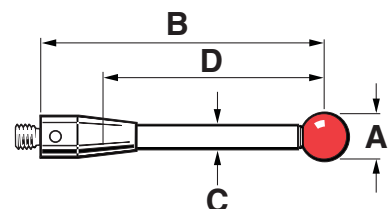
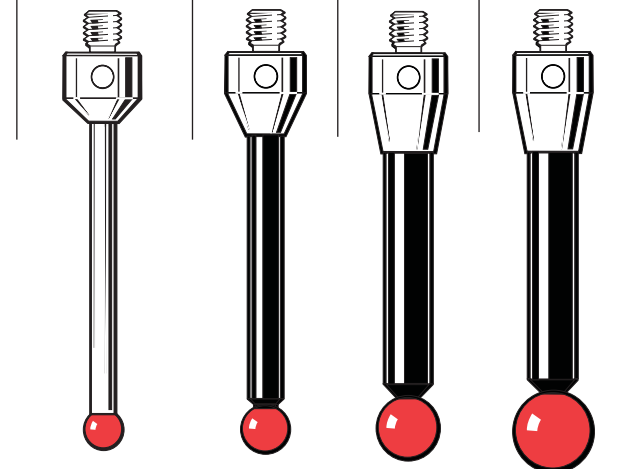

* Effective working length

Ruby ball styli (1 mm – 10 mm ball diameter)

Part number	A-5003-5243 Tungsten carbide	A-5003-5244 Tungsten carbide	A-5003-5248 Tungsten carbide	A-5003-5249 Tungsten carbide	A-5003-5250 Carbon fiber	A-5003-5251 Carbon fiber	A-5003-5252 Carbon fiber
A Ball dia. mm (in.)	1.0 (0.04)	1.5 (0.06)	4.0 (0.16)	5.0 (0.20)	6.0 (0.24)	8.0 (0.32)	10.0 (0.40)
B Length mm (in.)	75.0 (2.96)	75.0 (2.96)	75.0 (2.96)	75.0 (2.96)	75.0 (2.96)	75.0 (2.96)	75.0 (2.96)
C Stem dia. mm (in.)	0.7 (0.03)	1.0 (0.04)	3.0 (0.12)	3.0 (0.12)	4.0 (0.16)	6.0 (0.24)	6.0 (0.24)
D EWL* mm (in.)	5.0 (0.20)	5.0 (0.20)	66.0 (2.60)	66.0 (2.60)	65.1 (2.56)	64.5 (2.54)	69.5 (2.74)
Mass grams	23.86	23.90	11.61	11.80	6.59	9.06	10.01
Price	\$115	\$105	\$96	\$105	\$125	\$115	\$125

75 mm range

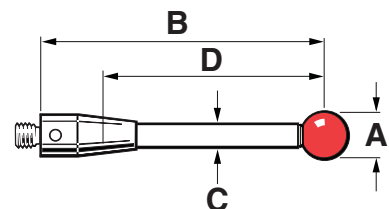
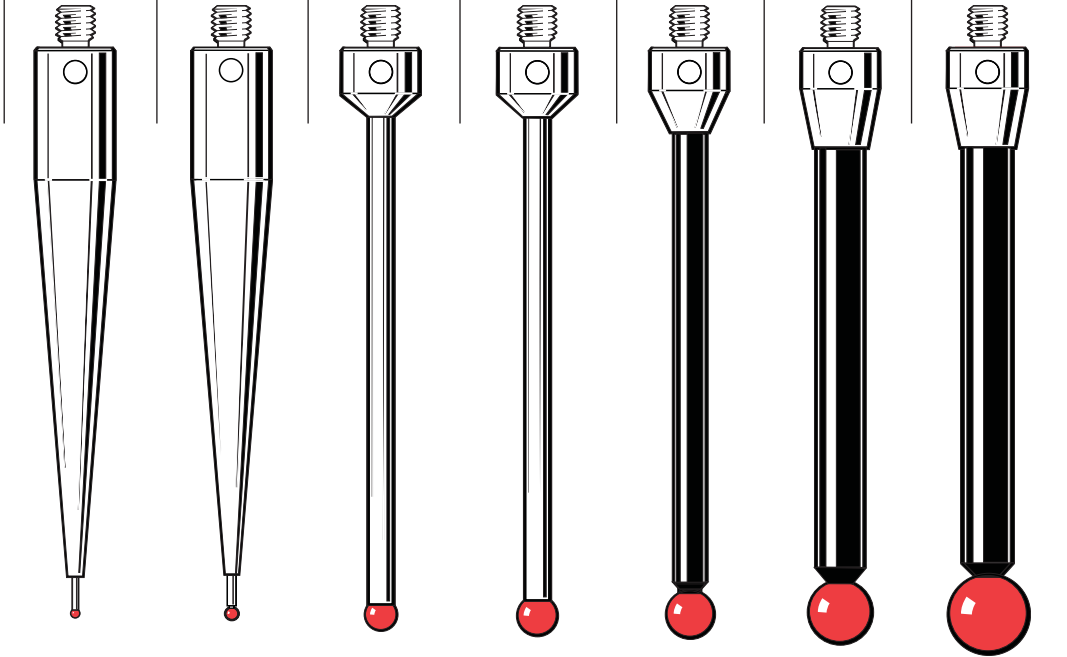

* Effective working length

M5 styli

Ruby ball styli (≤ 50 mm EWL)

Part number	A-5003-5253 Tungsten carbide	A-5003-5255 Tungsten carbide	A-5003-5256 Tungsten carbide	A-5003-5257 Tungsten carbide	A-5003-5261 Carbon fiber	
A	Ball dia. mm (in.)	3.0 (0.12)	4.0 (0.16)	4.0 (0.16)	5.0 (0.20)	8.0 (0.32)
B	Length mm (in.)	100.0 (3.94)	100.0 (3.94)	100.0 (3.94)	100.0 (3.94)	100.0 (3.94)
C	Stem dia. mm (in.)	2.0 (0.08)	2.0 (0.08)	3.0 (0.12)	3.0 (0.12)	6.0 (0.24)
D	EWL* mm (in.)	20.0 (0.79)	30.5 (1.20)	50.0 (1.97)	50.0 (1.97)	50.0 (1.97)
	Mass grams	25.71	25.75	23.07	23.31	22.97
	Price	\$125	\$125	\$144	\$125	\$144

100 mm range

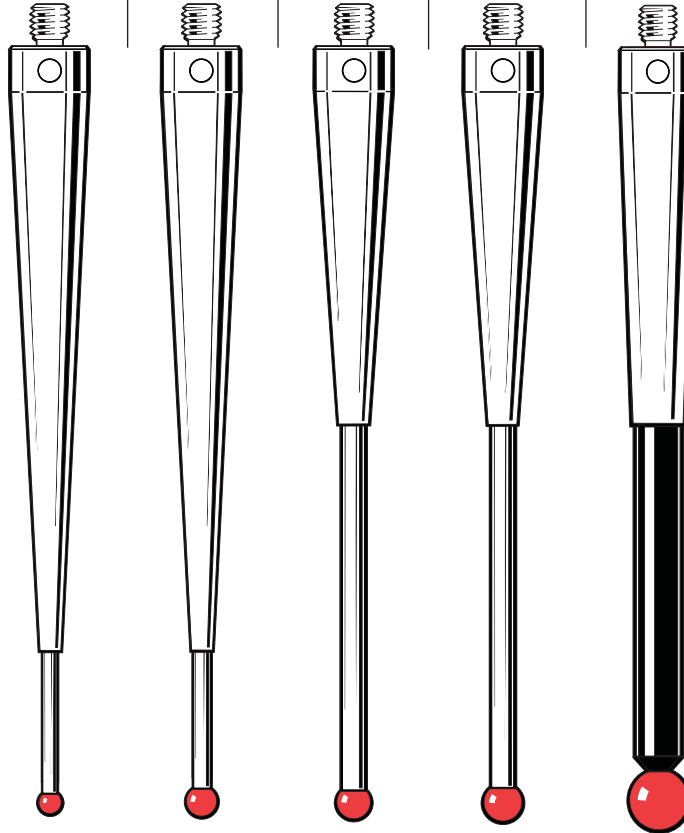

Ruby ball styli (> 50 mm EWL)

Ball material		Part number						
Ruby		A-5003-5254	A-5003-5259	A-5003-5258	A-5003-5260	A-5003-5262	A-5003-5264	A-5003-5263
Price		\$144	\$134	\$144	\$153	\$163	\$173	\$153
Silicon nitride		-	A-5003-5735	-	-	-	-	-
Price		-	\$188	-	-	-	-	-
Zirconia		-	A-5003-5749	-	-	-	-	-
Price		-	\$188	-	-	-	-	-
		Tungsten carbide	Carbon fiber	Tungsten carbide	Carbon fiber	Carbon fiber	Carbon fiber	Carbon fiber
A	Ball dia. mm (in.)	3.0 (0.12)	6.0 (0.24)	5.0 (0.20)	6.0 (0.24)	8.0 (0.32)	10.0 (0.40)	10.0 (0.40)
B	Length mm (in.)	100.0 (3.94)	100.0 (3.94)	100.0 (3.94)	100.0 (3.94)	100.0 (3.94)	100.0 (3.94)	100.0 (3.94)
C	Stem dia. mm (in.)	1.5 (0.06)	4.0 (0.16)	3.0 (0.12)	4.0 (0.16)	6.0 (0.24)	6.0 (0.24)	6.0 (0.24)
D	EWL* mm (in.)	55.0 (2.17)	58.9 (2.32)	91.0 (3.59)	90.1 (3.55)	89.5 (3.52)	94.5 (3.72)	95.5 (3.76)
	Mass grams	16.30	19.66	14.40	7.08	10.17	11.11	23.91

100 mm range

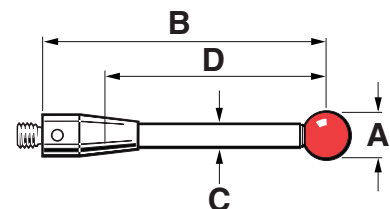
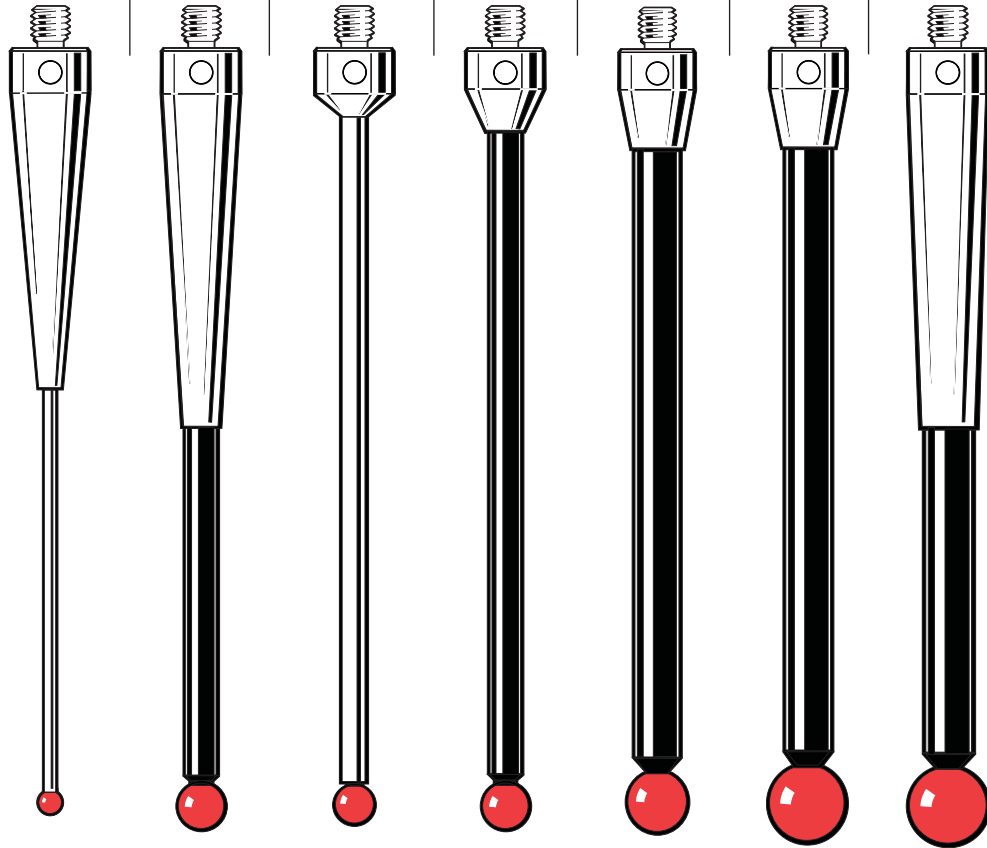

* Effective working length

M5 styli

Ruby ball styli (carbon fiber stems)

Part number	A-5003-5265	A-5003-5266	A-5003-5267	
A	Ball dia. mm (in.)	6.0 (0.24)	8.0 (0.32)	10.0 (0.40)
B	Length mm (in.)	150.0 (5.91)	150.0 (5.91)	150.0 (5.91)
C	Stem dia. mm (in.)	4.0 (0.16)	6.0 (0.24)	6.0 (0.24)
D	EWL* mm (in.)	137.0 (5.39)	135.0 (5.31)	144.5 (5.69)
	Mass grams	9.09	13.71	14.66
	Price	\$230	\$249	\$269

150 mm range

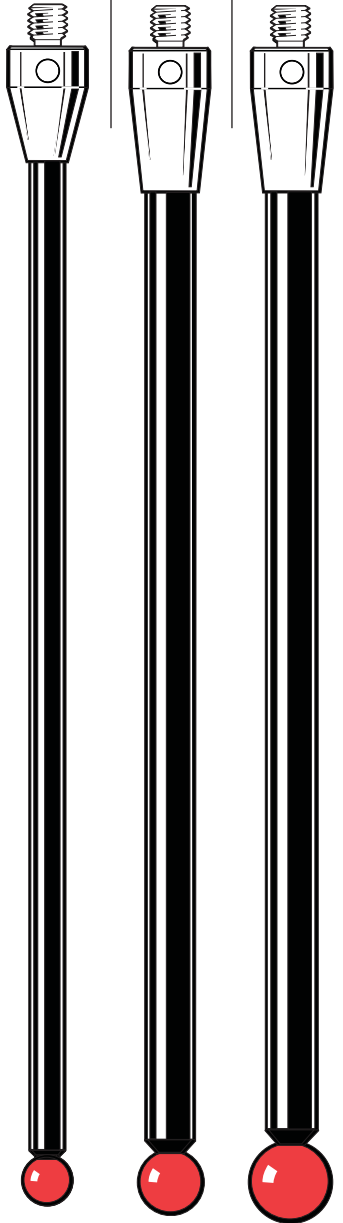

A-5003-5268	A-5003-5269	A-5003-5270
6.0 (0.24)	8.0 (0.32)	10.0 (0.40)
200.0 (7.88)	200.0 (7.88)	200.0 (7.88)
4.0 (0.16)	6.0 (0.24)	6.0 (0.24)
187.0 (7.36)	180.0 (7.09)	194.5 (7.66)
10.07	15.92	16.87
\$326	\$345	\$364

200 mm range

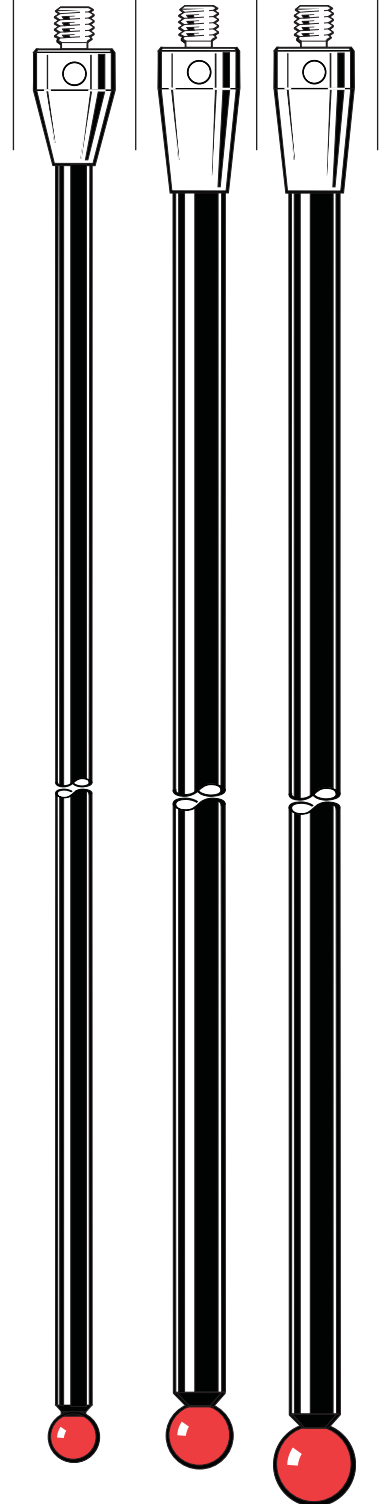

* Effective working length

Ruby ball styli (carbon fiber stems)

Part number	A-5003-5271	A-5003-5272	A-5003-5273	
A	Ball dia. mm (in.)	6.0 (0.24)	8.0 (0.32)	10.0 (0.40)
B	Length mm (in.)	300.0 (11.82)	300.0 (11.82)	300.0 (11.82)
C	Stem dia. mm (in.)	4.0 (0.16)	6.0 (0.24)	6.0 (0.24)
D	EWL* mm (in.)	287.0 (11.30)	280.0 (11.03)	294.5 (11.59)
	Mass grams	12.02	20.33	21.28
	Price	\$422	\$441	\$460

300 mm range

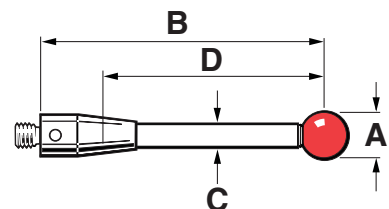
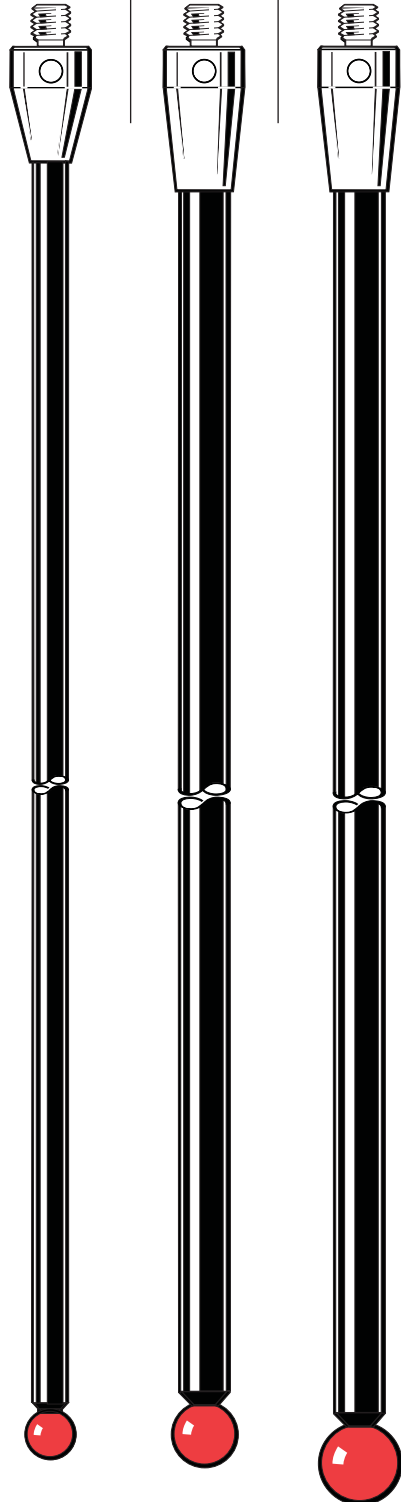

* Effective working length

M5 styli

Stylus extensions – thermo stable carbon fiber stems, titanium ends

Part number	A-5555-0647	A-5555-0648	A-5555-0649	A-5555-0623	A-5555-0650	A-5555-0651	A-5555-0652
Length mm (in.)	40.0 (1.58)	50.0 (1.97)	60.0 (2.37)	70.0 (2.76)	80.0 (3.15)	90.0 (3.55)	100.0 (3.94)
Stem dia. mm (in.)	11.0 (0.44)	11.0 (0.44)	11.0 (0.44)	11.0 (0.44)	11.0 (0.44)	11.0 (0.44)	11.0 (0.44)
Mass grams	7.6	8.3	9.0	9.7	10.4	11.1	11.8
Price	\$157**	\$159**	\$162**	\$166**	\$170**	\$182**	\$187**

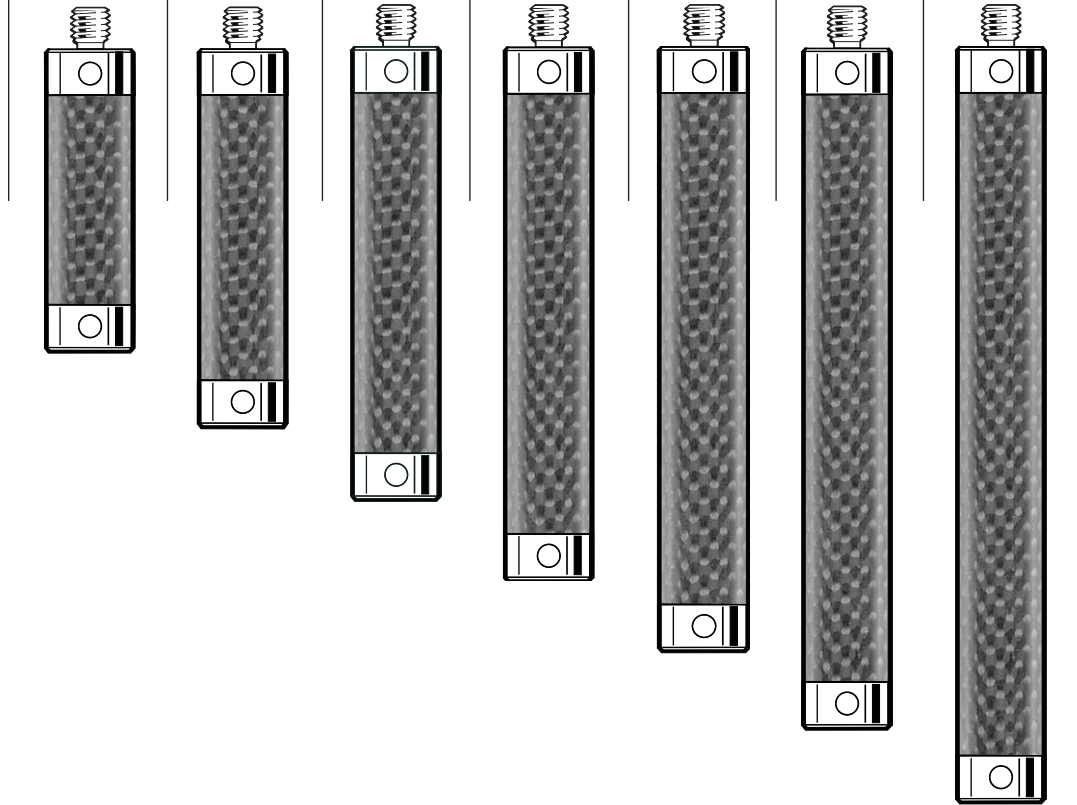

M5 extension tools

A-5003-6134

For M5 threaded extensions with
11 mm (0.44 mm stem diameter

Price: \$21

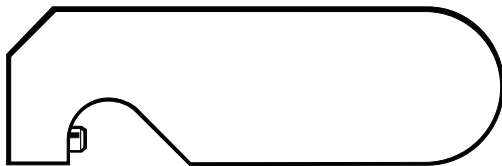

A-5003-6135

For M5 threaded extensions with
20 mm (0.79 in) stem diameter

Price: \$21

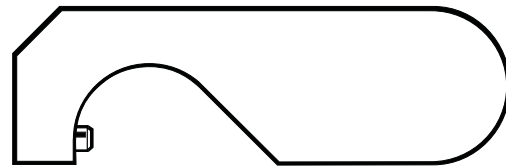

Note: These tools are designed to fit stylus extensions for Renishaw probes without causing any internal damage.

** Special

Stylus extensions – thermo stable carbon fiber stems, titanium ends

Part number	A-5555-0425	A-5555-0424	A-5555-0653	A-5555-0654	A-5555-0655	A-5555-0642	A-5555-0656
Length mm (in.)	120.0 (4.73)	150.0 (5.91)	180.0 (7.09)	200.0 (7.88)	250.0 (9.85)	300.0 (11.82)	400.0 (15.76)
Stem dia. mm (in.)	11.0 (0.44)	11.0 (0.44)	11.0 (0.44)	11.0 (0.44)	11.0 (0.44)	11.0 (0.44)	11.0 (0.44)
Mass grams	13.2	15.4	17.5	18.9	22.4	25.9	33.0
Price	\$191**	\$201**	\$208**	\$221**	\$238**	\$280**	\$333**

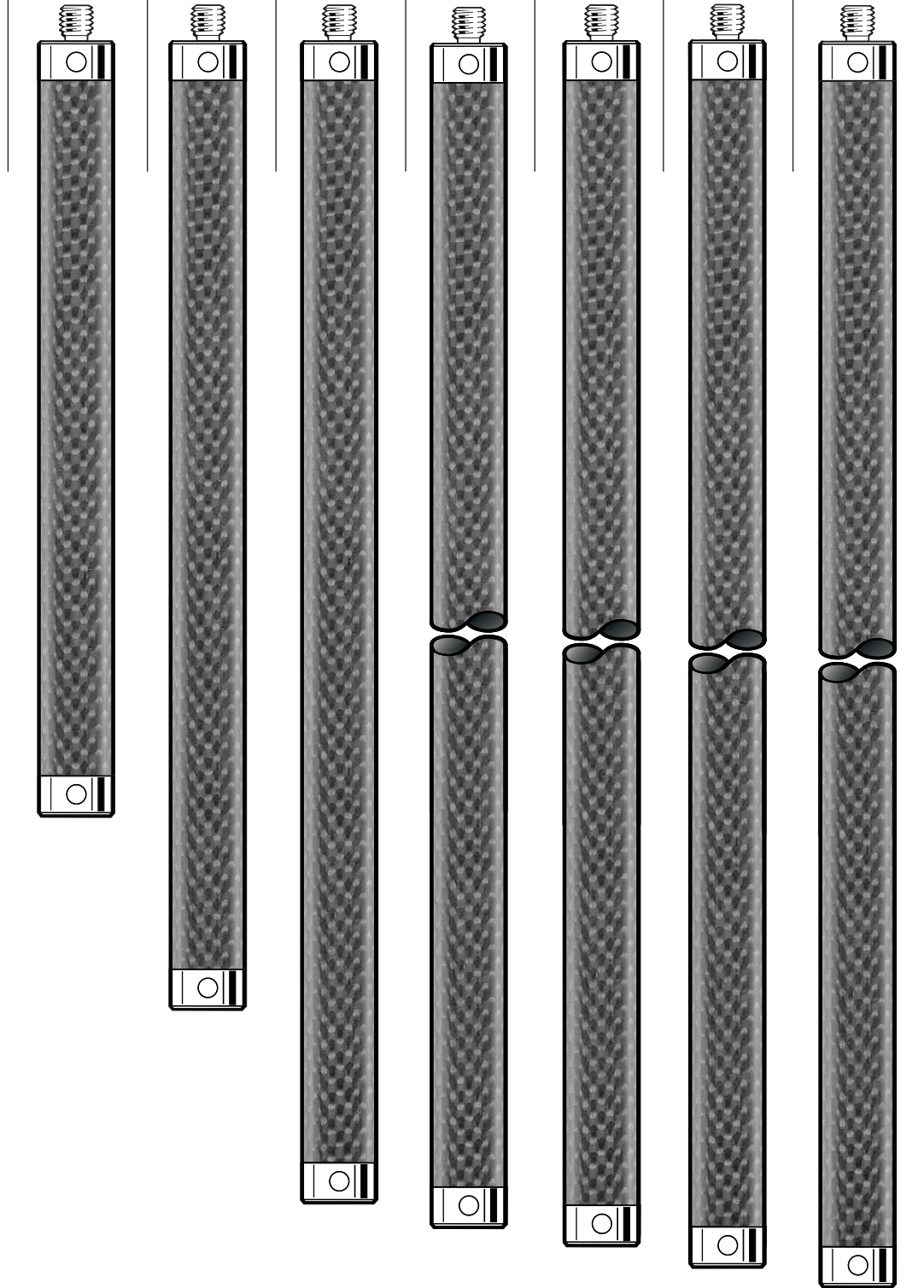

** Special

M5 styli

Stylus extensions – thermo stable carbon fiber stems, titanium ends

Part number	A-5555-0620	A-5555-0657	A-5555-0658	A-5555-0621	A-5555-0659	A-5555-0660	A-5555-0661
Length mm (in.)	40.0 (1.58)	50.0 (1.97)	60.0 (2.37)	80.0 (3.15)	100.0 (3.94)	120.0 (4.73)	150.0 (5.91)
Stem dia. mm (in.)	20.0 (0.79)	20.0 (0.79)	20.0 (0.79)	20.0 (0.79)	20.0 (0.79)	20.0 (0.79)	20.0 (0.79)
Mass grams	23.8	25.1	26.5	29.3	32.1	34.9	39.0
Price	\$154**	\$159**	\$162**	\$170**	\$192**	\$203**	\$214**

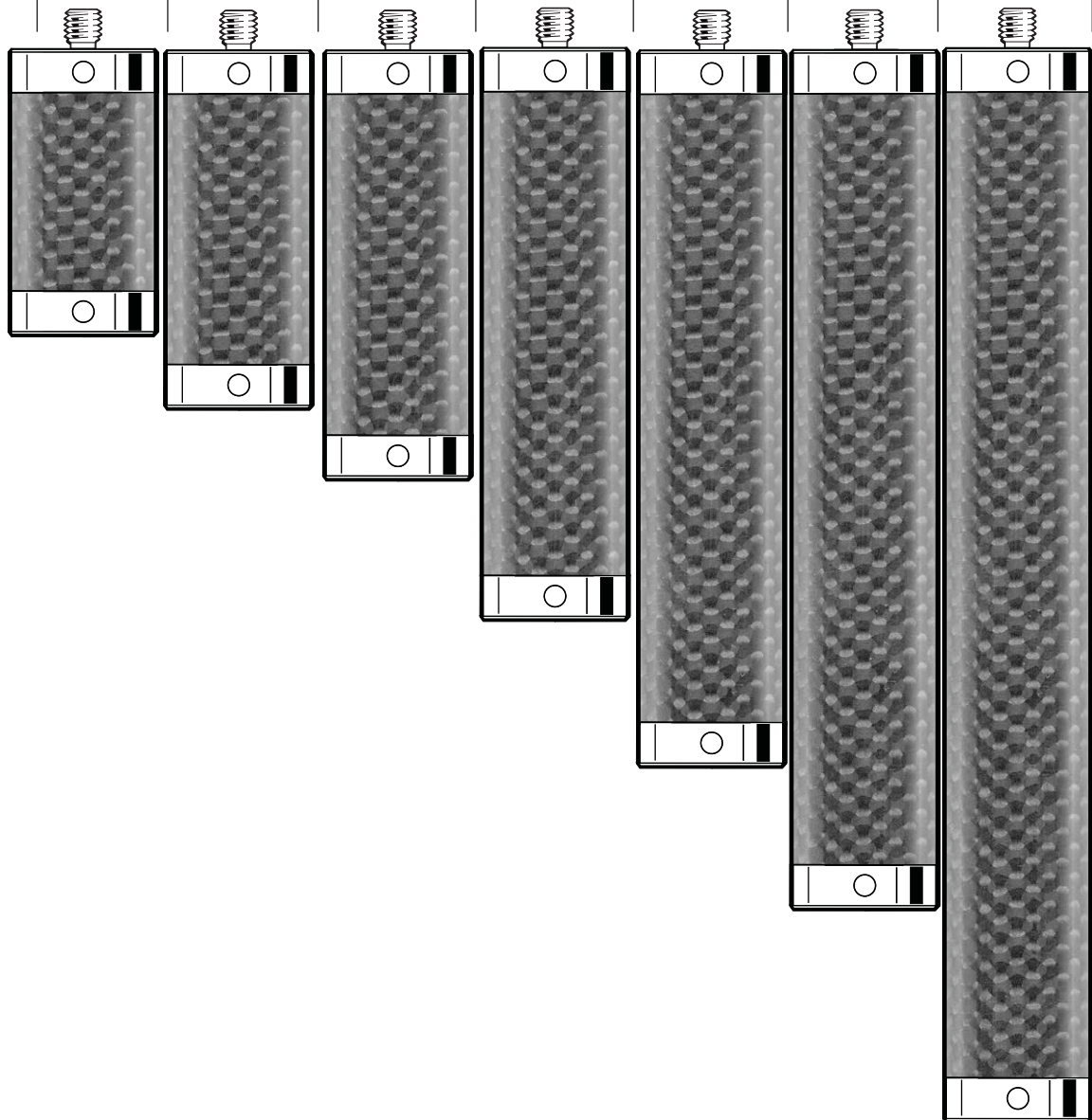

** Special

Stylus extensions – thermo stable carbon fiber stems, titanium ends

Part number	A-5555-0662	A-5555-0663	A-5555-0427	A-5555-0664	A-5555-0665	A-5555-0667	A-5555-0668
Length mm (in.)	180.0 (7.09)	200.0 (7.88)	250.0 (9.85)	300.0 (11.82)	400.0 (15.76)	500.0 (19.70)	600.0 (23.64)
Stem dia. mm (in.)	20.0 (0.79)	20.0 (0.79)	20.0 (0.79)	20.0 (0.79)	20.0 (0.79)	20.0 (0.79)	20.0 (0.79)
Mass grams	43.2	46.0	52.9	59.9	73.8	87.7	101.5
Price	\$229**	\$238**	\$266**	\$298**	\$349**	\$420**	\$280**

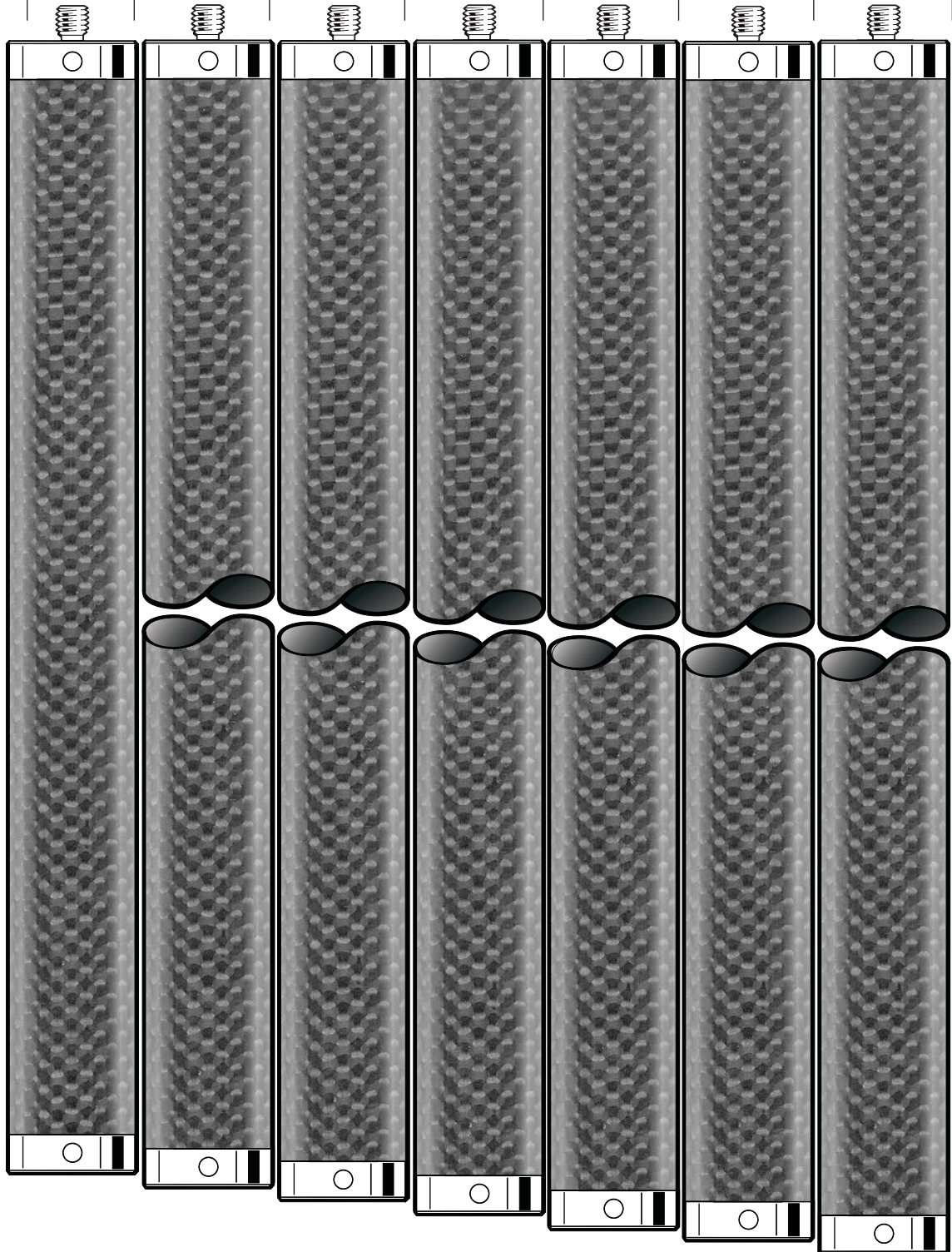

** Special

M5 styli

Stylus extensions – stainless steel

Part number	A-5555-0142	A-5555-0140	A-5555-0669	A-5555-0670	A-5555-0136
Length mm (in.)	10.0 (0.40)	20.0 (0.79)	30.0 (1.19)	50.0 (1.97)	100.0 (3.94)
Stem dia. mm (in.)	11.0 (0.44)	11.0 (0.44)	11.0 (0.44)	11.0 (0.44)	11.0 (0.44)
Mass grams	6.0	13.0	20.0	34.8	73.0
Price	\$25**	\$25**	\$25**	\$27**	\$29**

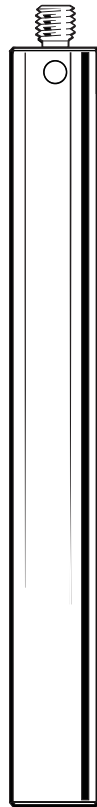
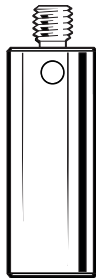
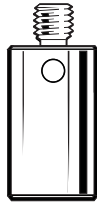
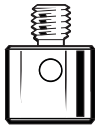

** Special

Stylus extensions – aluminum

Part number	A-5555-0671	A-5555-0127	A-5555-0125
Length mm (in.)	50.0 (1.97)	100.0 (3.94)	200.0 (7.88)
Stem dia. mm (in.)	20.0 (0.79)	20.0 (0.79)	20.0 (0.79)
Mass grams	47.2	50.0	85.0
Price	\$71**	\$73**	\$92**

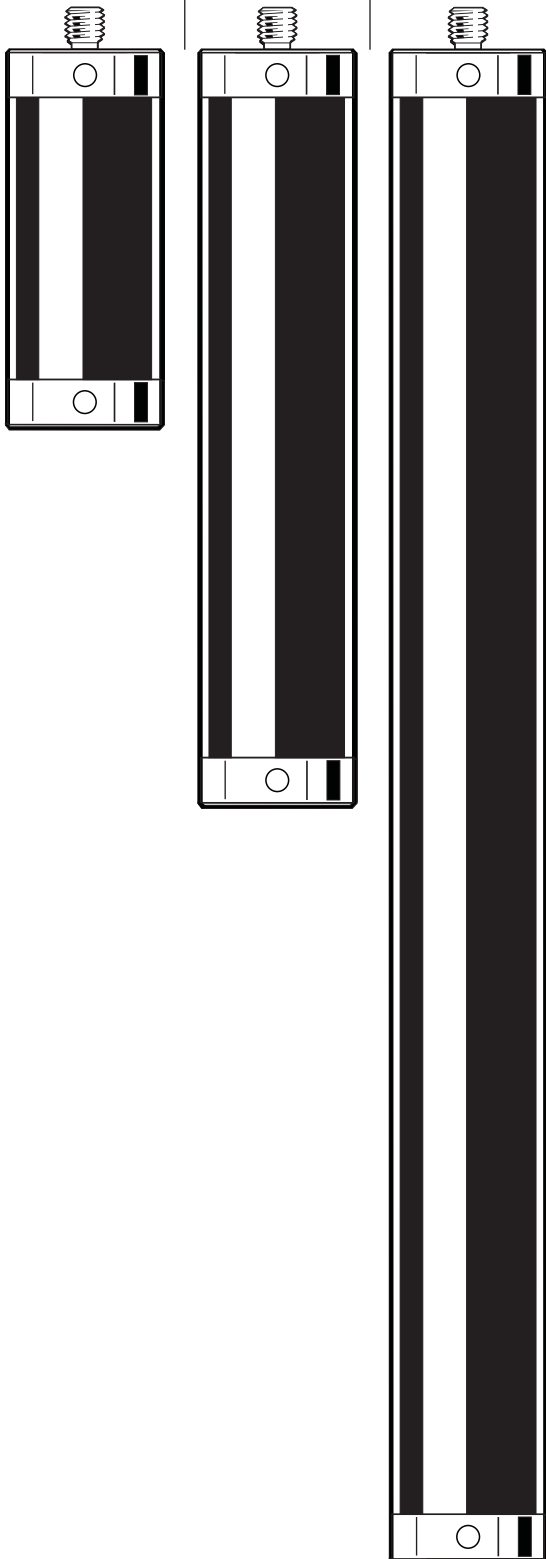

** Special

M5 styli

Disk styli

Part number	A-5003-5288 Silver steel	A-5003-5289 Silver steel	A-5003-5290 Silver steel	A-5003-5291 Silver steel
Disk diameter mm (in.)	12.0 (0.48)	21.0 (0.83)	35.0 (1.38)	63.5 (2.51)
Disk depth mm (in.)	3.0 (0.12)	3.0 (0.12)	5.0 (0.20)	5.0 (0.20)
Roller depth mm (in.)	5.0 (0.20)	5.0 (0.20)	8.0 (0.32)	8.0 (0.32)
Mass grams	2.52	5.23	14.00	51.00
Price	\$125	\$134	\$144	\$163

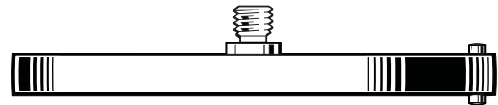
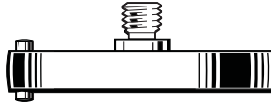
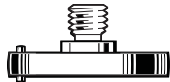

Hemispherical styli

Part number	A-5003-5275 Ceramic	A-5003-5276 Ceramic	A-5003-5277 Ceramic
Ball diameter mm (in.)	16.0 (0.63)	22.0 (0.87)	30.0 (1.19)
Length mm (in.)	19.5 (0.77)	20.5 (0.81)	24.5 (0.96)
Mass grams	7.0	14.0	19.7
Price	\$225	\$225	\$300

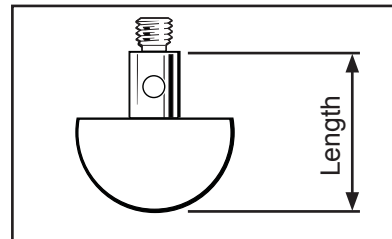
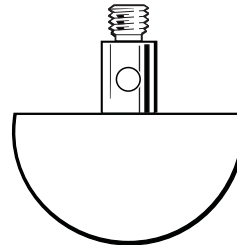
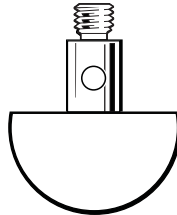
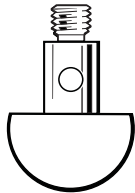

Styli for FARO® arms

These styli have been designed especially for use on FARO® portable arm CMMs. Their robust design and construction utilizes Grade 5 Zirconia balls that have a high fracture toughness. The balls are bonded to the high strength tungsten carbide stem with impact resistant adhesive, and specialist construction techniques have been incorporated to ensure that the joint between the body and stem is extremely rigid and virtually indestructible.

1¼–20 UN thread styli

Part number	A-5003-7673	A-5003-7674	A-5003-7675
Ball dia (mm)	3	6	N/A
Length (mm)	57	57	57
Price	\$325	\$325	\$325

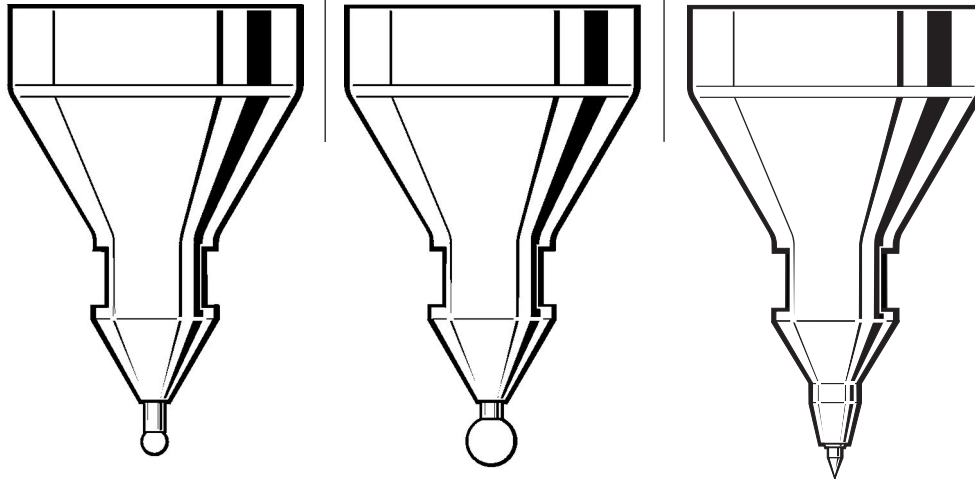

M6 styli

Part number	A-5003-7676	A-5003-7677	A-5003-7678	A-5003-7679
Ball dia	1/8 in	1/4 in	3 mm	6 mm
Length (mm)	43	43	43	43
Price	\$225	\$225	\$225	\$225

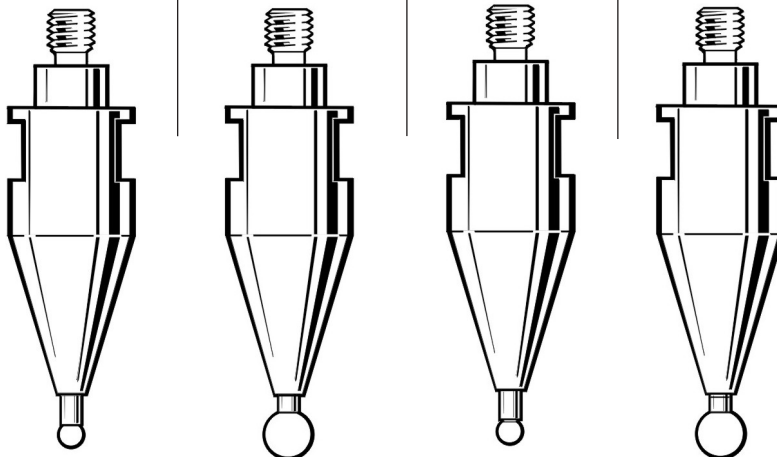

Styli for FARO® arms

FARO® kit

A-5003-9190 FARO® probe kit 0073 12 piece

Price: \$1,034

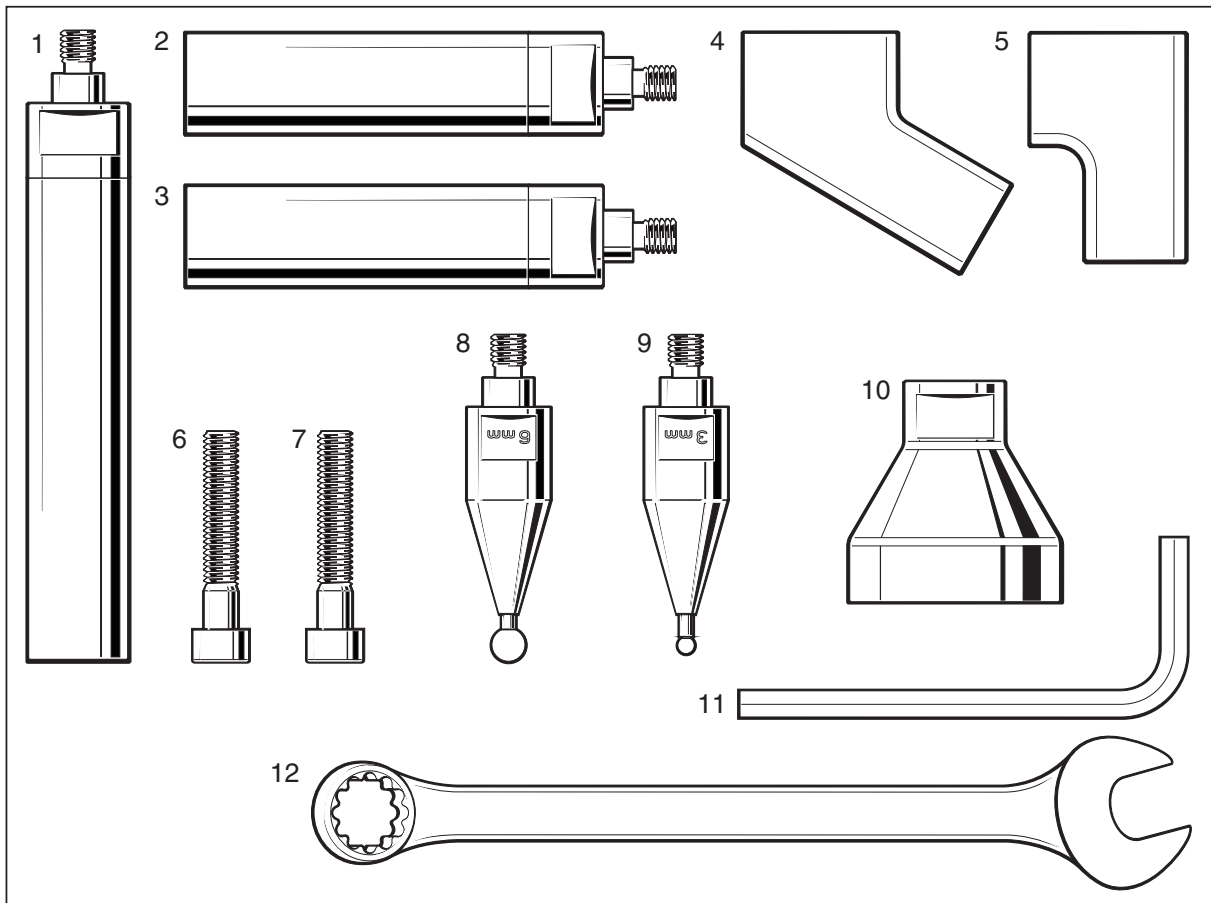

Position	Part number	Description
1	A-5003-9127	M6M - M6F EXT L101.6 (4.0) D18 AL
2 and 3	A-5003-9126	M6M - M6F EXT L76.2 (3.0) D18 AL
4	A-5003-9186	M6F FARO EXT 60 DEG ADAPTOR
5	A-5003-9187	M6F FARO EXT 90 DEG ADAPTOR
6 and 7	P-SC08-0635	SCREW HEX SKT CAPHD M6X35 STST
8	A-5003-7679	STYLUS M6 DIA 6 MM 21 PROBE 0067
9	A-5003-7678	STYLUS M6 DIA 3 MM 21 PROBE 0065
10	M-5003-9133	FARO ADAPTOR 1.25-20 UN-M6
11	P-TL01-0500	SKT WRENCH 5MM A/F
12	P-TL09-0012	12 MM A/F OPEN/RING SPANNER

M5 styli, adaptors and accessories for Zeiss analog probe systems

Schematics not shown to scale

Styli with conical stem base, titanium base, tungsten carbide stem, ruby ball

Part number	A-5555-0001	A-5555-0002	A-5555-0003	A-5555-0004	A-5555-0005	A-5555-0006	A-5555-0007	A-5555-0008
Zeiss order number	600331-9096	602030-9003	602030-9004	600331-9098	602030-9005	602030-9006	602030-9007	600331-9097
DK (mm)	3	3	3	3	5	5	5	8
L (mm)	50	75	75	115	75	75	100	80
DG (mm)	19	19	19	19	19	19	19	19
ML (mm)	21.5	35	50	18	35	50	60	57
DS (mm)	2	2	2	2	3.5	3.5	3.5	6
Weight (g)	23	30	22	56	34	28	38	45
Price	\$94	\$96	\$90	\$143	\$106	\$101	\$106	\$140

Part number	A-5555-0009	A-5555-0010	A-5555-0011
Zeiss order number	600331-9099	602030-9008	602030-9009
DK (mm)	8	8	8
L (mm)	100	115	140
DG (mm)	19	19	19
ML (mm)	60	56.5	100
DS (mm)	6	6	6
Weight (g)	57	68	74
Price	\$150	\$150	\$159

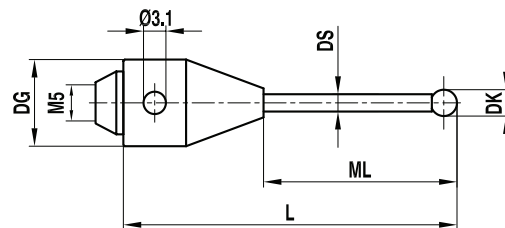

Adaptor with thread/conical stem base, stainless steel

Part number	A-5555-0013	A-5555-0014
Zeiss order number	600331-0001	602030-0018
D (mm)	18	18
L (mm)	10	12
Weight (g)	12	10
Price	\$34	\$25

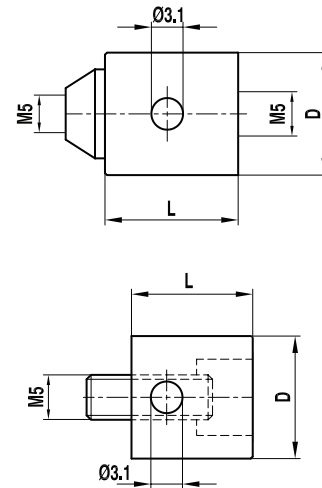

Conical holder, stainless steel

Part number	A-5555-0015	A-5555-0016	A-5555-0017
Zeiss order number	602030-8350	602030-8351	602030-8352
DS (mm)	2	3.5	6
L (mm)	24	24	24
DG (mm)	19	19	19
Weight (g)	29	29	29
Price	\$64	\$60	\$57

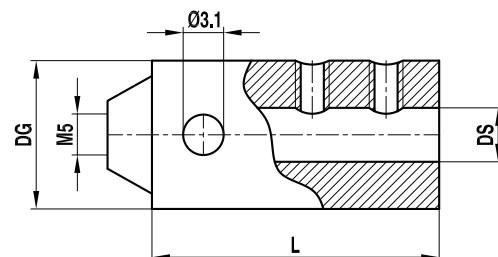

M5 styli for Zeiss probing systems

Tungsten carbide styli, titanium base, tungsten carbide stem, ruby ball

Schematics not shown to scale

Part number	A-5555-0018	A-5555-0019	A-5555-0020	A-5555-0021	A-5555-0022	A-5555-0023	A-5555-0024	A-5555-0025
Zeiss order number	602030-9010	600342-8020	602030-9011	600342-8021	600342-8025	602030-9012	602030-9013	600342-8022
DK (mm)	3	3	3	3	4	4	5	5
L (mm)	25	33.5	50	58	33.5	64	50	53
DG (mm)	11	11	11	11	11	11	11	11
ML (mm)	15	23.5	40	48	23.5	54	40	43
DS (mm)	2	2	2	2	2	2	3.5	3.5
Weight (g)	4	4.5	5.2	5.5	4.5	5.9	9	9.8
Price	\$45	\$45	\$45	\$45	\$57	\$60	\$53	\$50

Part number	A-5555-0026	A-5555-0027	A-5555-0028	A-5555-0029	A-5555-0030	A-5555-0031	A-5555-0032	A-5555-0033
Zeiss order number	602030-9015	600342-8026	600342-8027	600342-8023	600342-8123	602030-9014	602030-9016	602030-9017
DK (mm)	5	6	7	8	8	8	8	8
L (mm)	75	54	55	63.5	63.5	74	75	100
DG (mm)	11	11	11	11	19	11	11	11
ML (mm)	65	44	45	50.5	41.5	61	62	87
DS (mm)	3.5	3.5	3.5	6	6	6	6	6
Weight (g)	12.5	10	10	24.8	36.7	29.5	30	40
Price	\$57	\$57	\$60	\$64	\$69	\$66	\$66	\$66

Part number	A-5555-0034	A-5555-0035	A-5555-0036	A-5555-0037	A-5555-0038	A-5555-0039	A-5555-0040
Zeiss order number	600342-8024	600342-8124	600342-8028	600342-8128	600342-8029	600342-8129	602030-9018
DK (mm)	8	8	9	9	10	10	10
L (mm)	114.5	114.5	64.5	64.5	65.5	65.5	118
DG (mm)	11	19	11	19	11	19	11
ML (mm)	101.5	92.5	51.5	42.5	52.5	43.5	105
DS (mm)	6	6	6	6	6	6	6
Weight (g)	45.8	57.5	26.3	36.8	25.8	37.5	47.3
Price	\$66	\$83	\$67	\$81	\$73	\$94	\$73

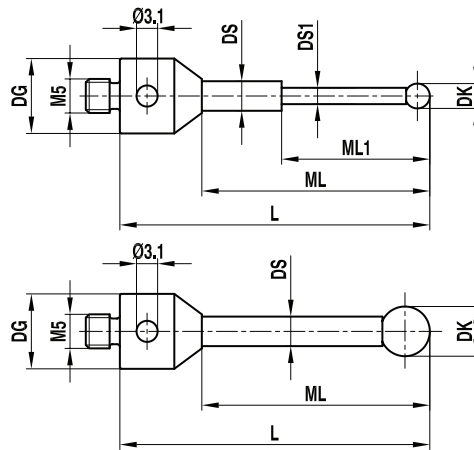

Tungsten carbide styli, titanium base, tungsten carbide stem, silicon nitride ball

Schematics not shown to scale

Part number	A-5555-3777	A-5555-3778	A-5555-3779	A-5555-3780	A-5555-3781	A-5555-3782	A-5555-3783	A-5555-3784
Zeiss order number	-	-	-	-	-	-	-	-
DK (mm)	1	1	1	1.5	2	2	2	2
L (mm)	20	25	30	30	20	25	30	40
DG (mm)	11	11	11	11	11	11	11	11
ML1 (mm)	5	5	5	8	-	-	-	-
ML (mm)	10	15	20	20	10	15	20	30
DS1 (mm)	0.8	0.8	0.8	1	-	-	-	-
DS (mm)	1	1	1	1.5	1	1	1.5	1.5
Weight (g)	3.5	3.5	3.8	3.5	3.5	3.5	3.8	4
Price	\$52	\$52	\$52	\$52	\$52	\$52	\$52	\$52

Part number	A-5555-3785	A-5555-3786	A-5555-3787	A-5555-3734	A-5555-3788	A-5555-3789
Zeiss order number	626115-0303-025	626115-0300-033	626115-0302-050	626115-0300-058	626115-0400-034	6262115-0401-064
DK (mm)	3	3	3	3	4	4
L (mm)	25	33.5	50	58	33.5	64
DG (mm)	11	11	11	11	11	11
ML (mm)	15	23.5	40	48	23.5	54
DS (mm)	2	2	2	2	2	2
Weight (g)	4	4.5	5.3	5.5	4.5	5.9
Price	\$53	\$53	\$53	\$53	\$54	\$64

Part number	A-5555-3790	A-5555-3791	A-5555-3792	A-5555-3793	A-5555-3794	A-5555-3795
Zeiss order number	-	626115-0501-050	626115-0501-053	626115-0500-075	-	-
DK (mm)	5	5	5	5	5	6
L (mm)	30	50	53	75	100	54
DG (mm)	11	11	11	11	11	11
ML (mm)	20	40	43	65	90	44
DS (mm)	3.5	3.5	3.5	3.5	3.5	3.5
Weight (g)	8	9	9.8	12.5	18	10
Price	\$62	\$64	\$64	\$67	\$76	\$66

Part number	A-5555-3796	A-5555-3797	A-5555-3798	A-5555-3799	A-5555-3800	A-5555-3801
Zeiss order number	-	626115-0800-064	626115-0800-075	626115-0801-100	626115-0800-115	-
DK (mm)	7	8	8	8	8	9
L (mm)	55	63.5	75	100	114.5	64.5
DG (mm)	11	11	11	11	11	11
ML (mm)	45	50.5	62	87	101.5	51.5
DS (mm)	3.5	6	6	6	6	6
Weight (g)	10	36.6	29.4	39.9	45.7	26.3
Price	\$74	\$74	\$85	\$89	\$94	\$87

Part number	A-5555-3802	A-5555-3803	A-5555-3804
Zeiss order number	-	-	-
DK (mm)	10	10	10
L (mm)	65.5	118	150
DG (mm)	11	11	11
ML (mm)	52.5	105	135
DS (mm)	6	6	6
Weight (g)	25.8	47.3	60
Price	\$97	\$108	\$111

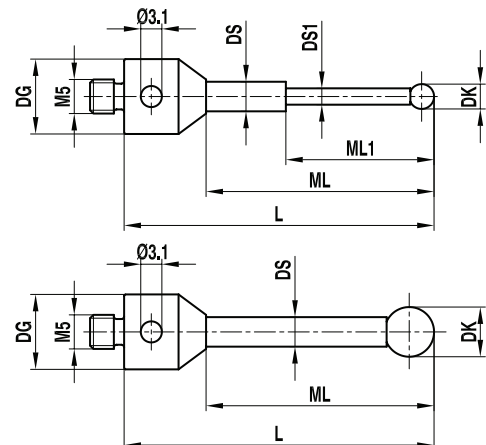

M5 styli for Zeiss probing systems

Reference styli (red dot), high-strength stainless steel base and stem, ruby ball

Schematics not shown to scale

Part number	A-5555-3805
Zeiss order number	600342-8023-010
DK (mm)	8
L (mm)	63.5
DG (mm)	11
ML (mm)	50.5
DS (mm)	6
Weight (g)	24.8
Price	\$106

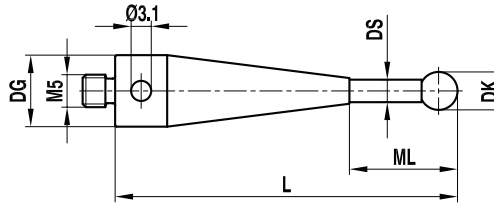

Thermo stable carbon fiber styli, titanium base, thermo stable carbon fiber stem, ruby ball

Part number	A-5555-1916	A-5555-1847	A-5555-0730	A-5555-3806	A-5555-1917	A-5555-0731
Zeiss order number	626105-0300-025	626105-0300-033	626105-0300-050	626105-0300-058	626105-0400-033	626105-0400-064
DK (mm)	3	3	3	3	4	4
L (mm)	25	33.5	50	58	33.5	64
DG (mm)	11	11	11	11	11	11
ML (mm)	15	23.5	40	48	23.5	54
DS (mm)	2	2	2	2	2	2
Weight (g)	4	4.2	4.5	4.9	4.2	4.6
Price	\$69	\$71	\$73	\$83	\$76	\$92

Part number	A-5555-0732	A-5555-2013	A-5555-0735	A-5555-0410	A-5555-0733	A-5555-0734
Zeiss order number	626105-0510-050	–	626105-0510-075	626105-0510-100	626105-0610-054	626105-0710-055
DK (mm)	5	5	5	5	6	7
L (mm)	50	53	75	100	54	55
DG (mm)	11	11	11	11	11	11
ML (mm)	40	43	65	90	44	45
DS (mm)	3.5	3.5	3.5	3.5	3.5	3.5
Weight (g)	4.8	4.9	5	5.4	4.9	4.9
Price	\$85	\$85	\$87	\$104	\$90	\$104

Part number	A-5555-3807	A-5555-2011	A-5555-1918	A-5555-3808	A-5555-9361	A-5555-1112
Zeiss order number	626105-0820-063	626105-0820-075	626105-0820-100	626105-0820-114	626105-0820-150	626105-0820-200
DK (mm)	8	8	8	8	8	8
L (mm)	63.5	75	100	114.5	150	200
DG (mm)	11	11	11	11	11	11
ML (mm)	50.5	62	87	101.5	137	187
DS (mm)	6	6	6	6	6	6
Weight (g)	7	7.3	7.5	9.5	11	13
Price	\$111	\$115	\$120	\$124	\$157	\$173

Part number	A-5555-3809	A-5555-3810	A-5555-3811	A-5555-0643	A-5555-0644
Zeiss order number	–	626105-1020-065	626105-1020-118	626105-1020-150	626105-1020-200
DK (mm)	9	10	10	10	10
L (mm)	64.5	65.5	118	150	200
DG (mm)	11	11	11	11	11
ML (mm)	51.5	52.5	105	137	187
DS (mm)	6	6	6	6	6
Weight (g)	7.2	8	14.5	16	19
Price	\$117	\$133	\$150	\$185	\$205

Thermo stable carbon fiber styli, titanium base, thermo stable carbon fiber stem, silicon nitride ball

Schematics not shown to scale

Part number	A-5555-3812	A-5555-1828	A-5555-3813	A-5555-3814	A-5555-3815	A-5555-3816
Zeiss order number	-	626105-0301-033	-	626103-0301-058	-	-
DK (mm)	3	3	3	3	4	4
L (mm)	25	33.5	50	58	33.5	64
DG (mm)	11	11	11	11	11	11
ML (mm)	15	23.5	40	48	23.5	54
DS (mm)	2	2	2	2	2	2
Weight (g)	4	4.2	4.5	4.9	4.2	4.6
Price	\$96	\$97	\$99	\$110	\$115	\$118

Part number	A-5555-3817	A-5555-0759	A-5555-2012	A-5555-9045	A-5555-3818	A-5555-3819
Zeiss order number	626105-0511-050	-	626105-0511-075	626105-0511-100	-	-
DK (mm)	5	5	5	5	6	7
L (mm)	50	53	75	100	54	55
DG (mm)	11	11	11	11	11	11
ML (mm)	40	43	65	90	44	45
DS (mm)	3.5	3.5	3.5	3.5	3.5	3.5
Weight (g)	4.8	4.9	5	5.4	4.9	4.9
Price	\$111	\$111	\$113	\$131	\$117	\$131

Part number	A-5555-0720	A-5555-2010	A-5555-3820	A-5555-3821	A-5555-1169	A-5555-1179
Zeiss order number	626105-0821-063	-	626105-0821-100	626105-0821-114	626105-0821-150	626105-0821-200
DK (mm)	8	8	8	8	8	8
L (mm)	63.5	75	100	114.5	150	200
DG (mm)	11	11	11	11	11	11
ML (mm)	50.5	62	87	101.5	137	187
DS (mm)	6	6	6	6	6	6
Weight (g)	7	7.3	7.5	9.5	11	13
Price	\$140	\$141	\$147	\$150	\$184	\$199

Part number	A-5555-3822	A-5555-3823	A-5555-3824	A-5555-3825	A-5555-1171
Zeiss order number	-	-	626105-1021-118	626105-1021-150	626105-1021-200
DK (mm)	9	10	10	10	10
L (mm)	64.5	65.5	118	150	200
DG (mm)	11	11	11	11	11
ML (mm)	51.5	52.5	105	137	187
DS (mm)	6	6	6	6	6
Weight (g)	7.2	8	14.5	16	19
Price	\$143	\$159	\$177	\$212	\$231

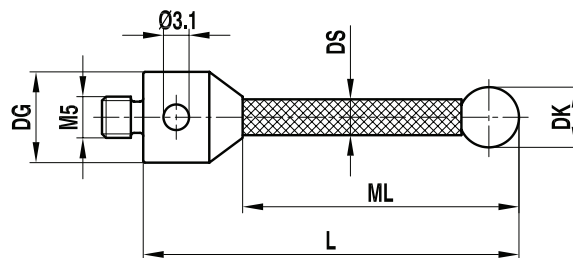

M5 styli for Zeiss probing systems

Ceramic styli, titanium base, ruby ball

Schematics not shown to scale

Part number	A-5555-0041	A-5555-0042	A-5555-0043	A-5555-0044	A-5555-0045	A-5555-0046	A-5555-0047	A-5555-0048
Zeiss order number	600342-8013	600342-8016	600342-8017	600342-8014	600342-8018	600342-8118	600342-8019	600342-8119
DK (mm)	5	6	7	8	9	9	10	10
L (mm)	53	54	55	63.5	64.5	64.5	65.5	65.5
DG (mm)	11	11	11	11	11	19	11	19
ML (mm)	43	44	45	50.5	51.5	42.5	52.5	43.5
DS (mm)	3.5	3.5	3.5	6	6	6	6	6
Weight (g)	4.6	4.7	5	8.3	8.4	21	9	38
Price	\$52	\$57	\$64	\$69	\$71	\$80	\$80	\$87

Part number	A-5555-0049	A-5555-0050	A-5555-0051
Zeiss order number	600342-8114	600342-8015	600342-8115
DK (mm)	8	8	8
L (mm)	63.5	114.5	114.5
DG (mm)	19	11	19
ML (mm)	41.5	101.5	92.5
DS (mm)	6	6	6
Weight (g)	33	11.8	38
Price	\$71	\$80	\$81

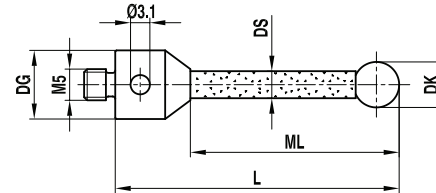

Small ball styli, stepped stem, stainless steel base, tungsten carbide stem, ruby ball

Part number	A-5555-0052	A-5555-0053	A-5555-0054	A-5555-0055	A-5555-0056	A-5555-0057	A-5555-0058	A-5555-0059
Zeiss order number	602030-8060	602030-8061	602030-8062	602030-8063	602030-8064	602030-8065	602030-8066	602030-8067
DK (mm)	0.8	1	1.35	1.35	1.5	1.5	2	2
L (mm)	32	32	32	44	32	44	32	44
DG (mm)	11	11	11	11	11	11	11	11
ML (mm)	12	12	12	19	12	19	12	19
ML1 (mm)	4.8	5.0	-	-	-	-	-	-
DS (mm)	1	1	1	1	1	1	1.5	1.5
DS1 (mm)	0.6	0.8	-	-	-	-	-	-
Weight (g)	6.8	6.8	6.9	7.5	6.5	7.5	7.3	8
Price	\$78	\$67	\$66	\$69	\$66	\$69	\$66	\$69

Part number	A-5555-0060	A-5555-0061	A-5555-0062	A-5555-0063
Zeiss order number	602030-8068	602030-8069	602030-8070	602030-8071
DK (mm)	2	2.5	2.5	2.5
L (mm)	58	32	44	58
DG (mm)	11	11	11	11
ML (mm)	33	12	19	33
DS (mm)	1.5	1.5	1.5	1.5
Weight (g)	8	7.3	8	8
Price	\$67	\$66	\$69	\$73

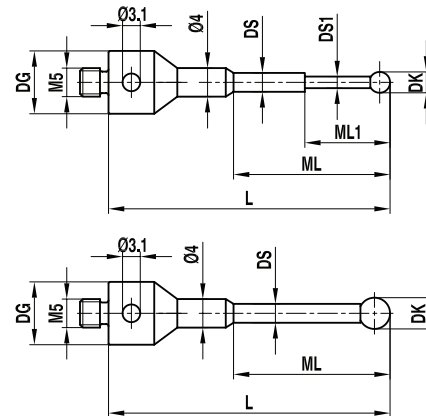

Small ball styli, titanium base, tungsten carbide stem, ruby ball

Part number	A-5555-0064	A-5555-0065	A-5555-0066	A-5555-0067	A-5555-0068
Zeiss order number	602030-9019	602030-9020	602030-9021	602030-9022	602030-9023
DK (mm)	1	1.5	2	2.5	3.5
L (mm)	55	55	55	55	55
DG (mm)	11	11	11	11	11
ML (mm)	5	5	5	5	10
DS (mm)	0.8	1	1.5	2	2.5
Weight (g)	11.9	11.9	11.9	11.9	11.9
Price	\$140	\$131	\$127	\$131	\$131

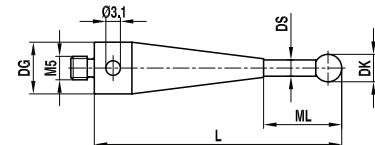

Cube star, titanium base, tungsten carbide stem, ruby ball

Schematics not shown to scale

Part number	A-5555-0069	A-5555-0070	A-5555-0071	A-5555-0072	A-5555-0073
Zeiss order number	602030-9024	602030-9025	602030-9026	602030-9027	602030-9028
DK (mm)	1	1.5	2	2.5	3.5
L (mm)	45	45	45	45	45
ML (mm)	7	7.5	7.5	8	15
DS (mm)	2	2	2	2	2
DS1 (mm)	0.8	1	1.5	1.5	-
B (mm)	15	15	15	15	15
Weight (g)	17.3	17.3	17.3	17.3	17.3
Price	\$191	\$191	\$191	\$207	\$222

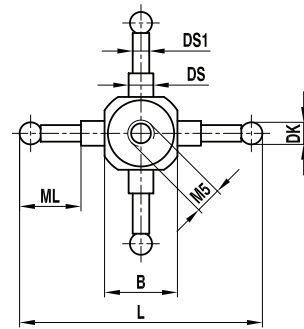

Styli for thread measurement, stainless steel base, tungsten carbide stem, ruby ball

Part number	A-5555-0074	A-5555-0075	A-5555-0076	A-5555-0077
Zeiss order number	602030-9070	602030-9071	602030-9072	602030-9073
DK (mm)	1.35	2.3	1.8	0.8
L (mm)	40	40	40	40
DG (mm)	11	11	11	11
ML (mm)	9	12	10	5
DS (mm)	1	1	1	0.6
B (mm)	2	2.5	2	1.9
Weight (g)	11	13	12	7
Price	\$103	\$124	\$134	\$199

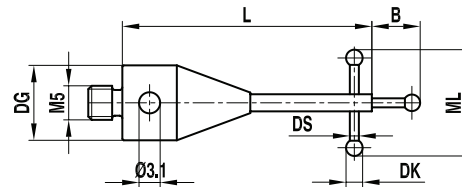

Long threaded styli, thread length 12.5 mm, stainless steel base, tungsten carbide stem, ruby ball

Part number	A-5555-0078	A-5555-0079	A-5555-0080	A-5555-0081	A-5555-0082	A-5555-0083	A-5555-0084
Zeiss order number	600342-8200	600342-8201	600342-8202	600342-8203	600342-8221	600342-8222	600342-8250
DK (mm)	1.35	1.5	2	2.5	3	5	0.3
L (mm)	32.85	33	33.5	34	34.5	43.5	21.8
DG (mm)	11	11	11	11	19	19	11
ML (mm)	23.85	24	24.5	25	16.5	25.5	12.8
ML1 (mm)	-	-	-	-	-	-	2.3
DS (mm)	1	1	1.5	1.5	2	3.5	1
DS1 (mm)	-	-	-	-	-	-	0.2
Weight (g)	6	7	7	7	20	23	6
Price	\$46	\$46	\$41	\$43	\$55	\$64	\$80

Part number	A-5555-0085	A-5555-0086	A-5555-0087	A-5555-0088
Zeiss order number	600342-8251	600342-8252	600342-8253	600342-8254
DK (mm)	0.5	0.6	0.8	1
L (mm)	22	22.1	22.3	22.5
DG (mm)	11	11	11	11
ML (mm)	13	13.1	13.3	13.5
ML1 (mm)	2.5	4.6	4.8	5.0
DS (mm)	1	1	1	1
DS1 (mm)	0.3	0.4	0.6	0.8
Weight (g)	6	6	6	6
Price	\$64	\$64	\$62	\$55

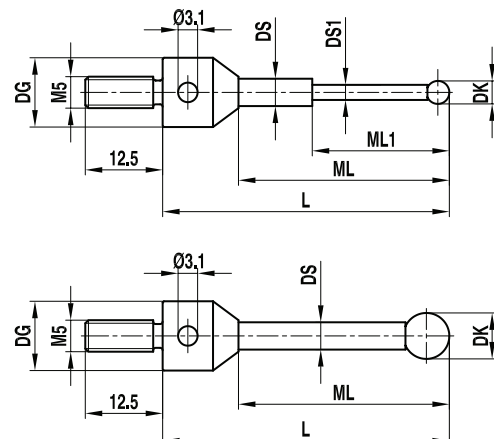

M5 styli for Zeiss probing systems

Long threaded styli, thread length 5 mm, stainless steel base, tungsten carbide stem, ruby ball

Schematics not shown to scale

Part number	A-5555-0799	A-5555-9324	A-5555-3826	A-5555-3827	A-5555-0686	A-5555-3828
Zeiss order number	626115-0140-033	626115-0150-033	626115-0200-034	–	626115-0250-034	–
DK (mm)	1.35	1.5	2	2.5	2.5	3
L (mm)	32.85	33	33.5	34	34	25.5
DG (mm)	11	11	11	11	11	11
ML (mm)	23.85	24	24.5	25	25	16.5
DS (mm)	1	1	1.5	1	1.5	2
Weight (g)	6	7	7	7	7	9
Price	\$46	\$46	\$41	\$41	\$43	\$52

Part number	A-5555-3829	A-5555-0331	A-5555-1157	A-5555-1842	A-5555-1844	A-5555-1843
Zeiss order number	–	626115-0030-022	626115-0050-022	626115-0060-022	626115-0080-022	626115-0100-022
DK (mm)	5	0.3	0.5	0.6	0.8	1
L (mm)	34.5	21.8	22	22.1	22.3	22.5
DG (mm)	11	11	11	11	11	11
ML (mm)	25.5	12.8	13	13.1	13.3	13.5
ML1 (mm)	–	2.3	2.5	4.6	4.8	1.5
DS (mm)	3.5	1	1	1	1	1
DS1 (mm)	–	0.2	0.3	0.4	0.6	0.8
Weight (g)	9	6	6	6	6	6
Price	\$60	\$80	\$64	\$64	\$62	\$55

Part number	A-5555-1873
Zeiss order number	–
DK (mm)	1.5
L (mm)	33
DG (mm)	11
ML (mm)	24
ML1 (mm)	7
DS (mm)	1.5
DS1 (mm)	1
Weight (g)	7
Price	\$62

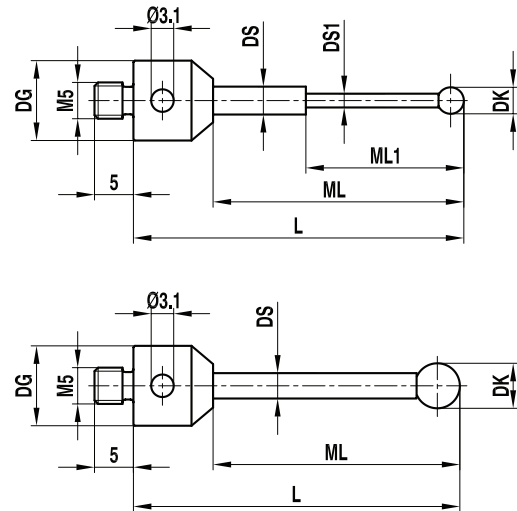

Flat washer for star styli, stainless steel

Part number	A-5555-0089	A-5555-0090
Zeiss order number	600341-0140	600341-0141
D (mm)	11	19
B (mm)	1.5	2
Weight (g)	1	4
Price	\$15	\$16

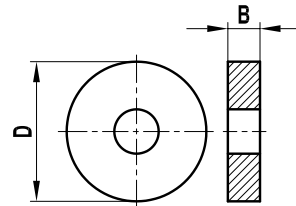

Grooved washer for star styli, stainless steel

Part number	A-5555-0091	A-5555-0092
Zeiss order number	600341-0150	600341-0151
D (mm)	11	19
B (mm)	2	4
Weight (g)	1	7
Price	\$46	\$48

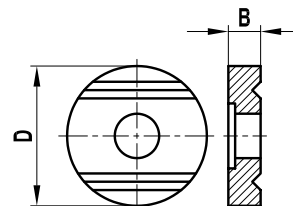

Tungsten carbide pin for star styli

Schematics not shown to scale

Part number	A-5555-0093	A-5555-0094	A-5555-0095	A-5555-0096
Zeiss order number	600341-0520	600341-0521	600341-0522	600341-0523
L (mm)	10	10	18	18
D (mm)	1	1.5	2	3.5
Weight (g)	1	1	1	3
Price	\$6	\$6	\$8	\$8

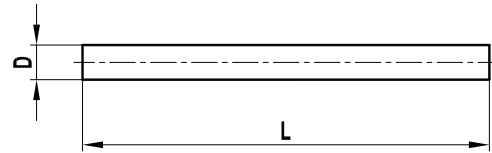

Rotary adaptor, titanium

Part number	A-5555-0099	A-5555-0713
Zeiss order number	602030-9095	612030-9737
L (mm)	30	29
D (mm)	18	11
Weight (g)	43	13
Price	\$170	\$170

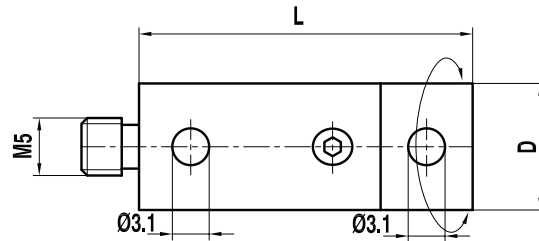

Holder, 90 degree offset, titanium

Part number	A-5555-1097
Zeiss order number	626105-6901-001
ML (mm)	17
DG (mm)	11
L (mm)	22.5
Weight (g)	6
Price	\$53

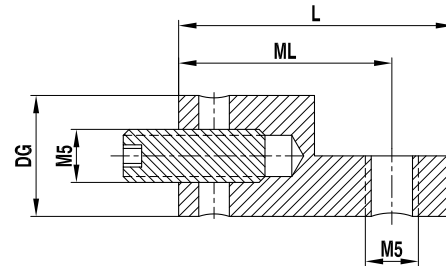

Rotary knuckle, slewing range 360 degrees, swing range 180 degrees, titanium

Part number	A-5003-5278	A-5555-3841
Zeiss order number	-	-
L (mm)	51	58
D (mm)	11	18
Weight (g)	19	58
Price	\$247	\$291

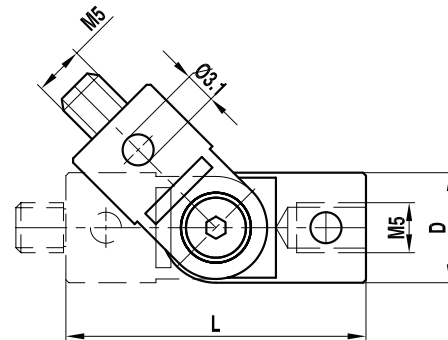

Holder, 90 degrees, stainless steel

Part number	A-5555-0104
Zeiss order number	600341-8160
DS1 (mm)	1-1.5
L (mm)	45
DG (mm)	11
DS (mm)	6
Weight (g)	16
Price	\$64

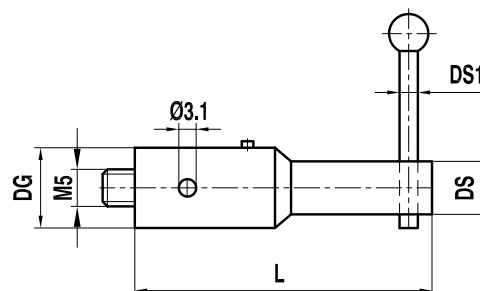

Fits with styli A-5555-0107 to A-5555-0115

M5 styli for Zeiss probing systems

5-way holder, stainless steel

Schematics not shown to scale

Part number	A-5555-0105	A-5555-0106	A-5555-1245
Zeiss order number	600341-8367	600341-8368	626115-5000-199
DS (mm)	1	1.5	2
L (mm)	10	10	10
DG (mm)	11	11	11
Weight (g)	3.2	3.2	3.2
Price	\$64	\$64	\$64

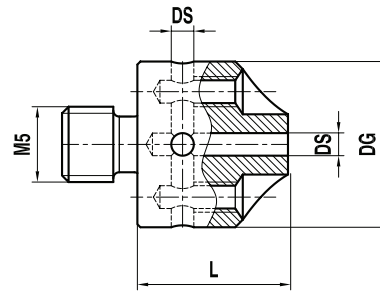

Styli for holder, tungsten carbide stem, ruby ball

Part number	A-5555-0107	A-5555-0108	A-5555-0109	A-5555-0110	A-5555-0111
Zeiss order number	600341-8454	600341-8450	600341-8451	600341-8452	600341-8453
DK (mm)	1	0.3	0.5	0.6	0.8
L (mm)	16	15.3	15.5	15.6	15.8
DS (mm)	1	1	1	1	1
DS1 (mm)	0.8	0.2	0.3	0.4	0.6
ML (mm)	5	2.3	2.5	4.6	4.8
Weight (g)	1	1	1	1	1
Price	\$48	\$64	\$165	\$48	\$46

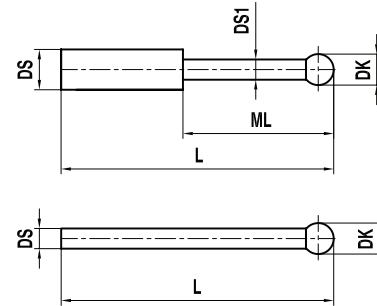

Part number	A-5555-0112	A-5555-0113	A-5555-0114	A-5555-0115	A-5555-0116	A-5555-0117
Zeiss order number	600341-8500	600341-8501	600341-8502	600341-8503	600341-8510	600341-8511
DK (mm)	1.35	1.5	2	2.5	3	5
L (mm)	26.35	26.5	27	27.5	38	45
DS (mm)	1	1	1.5	1.5	2	3.5
Weight (g)	1	1	1	1	2	6
Price	\$48	\$39	\$45	\$46	\$45	\$50

Holder for swivel styli, stainless steel

Part number	A-5555-0118
Zeiss order number	600341-8180
L (mm)	40
DG (mm)	11
DS (mm)	6
DS1 (mm)	1-1.5
Weight (g)	15
Price	\$80

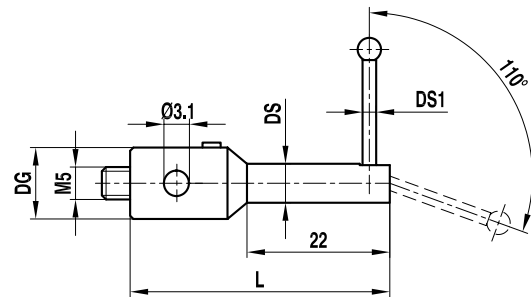

Styli for swiveling components, S4 steel ball, tungsten carbide stem, ruby ball

Part number	A-5555-0119	A-5555-0120
Zeiss order number	600341-8183	600341-8185
DK (mm)	1	2
L (mm)	17.5	28.5
DS (mm)	1	1.5
DS1 (mm)	0.8	-
ML (mm)	5	24.5
Weight (g)	1	1
Price	\$69	\$66

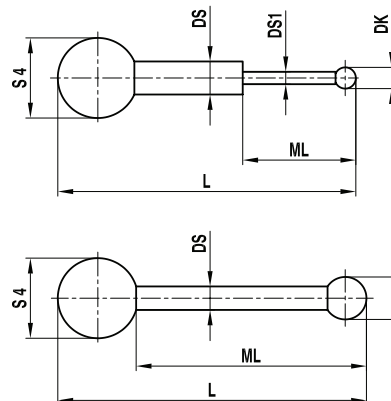

Star styli, stainless steel base, tungsten carbide stem, ruby ball

Part number	A-5555-1153	A-5555-1135	A-5555-3839
Zeiss order number	-	-	-
DK (mm)	0.6	0.8	1
L (mm)	40	40	40
DG (mm)	11	11	11
DS (mm)	4	4	4
DS1 (mm)	0.4	0.6	0.8
ML (mm)	30	30	30
A (mm)	8	8	8
Weight (g)	9	9	9
Price	\$701	\$631	\$573

Schematics not shown to scale

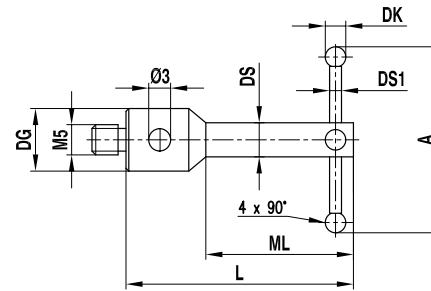

Reference sphere with stem, M8 thread, stainless steel, ceramic ball including certificate

Part number	A-5555-3842	A-5555-3843	A-5555-3844	A-1034-0124
Zeiss order number	-	-	-	-
DK (mm)	15	20	25	30
L (mm)	130	135	140	145
DG (mm)	24	24	24	24
SW (mm)	22	22	22	22
Price	\$397	\$502	\$525	\$550

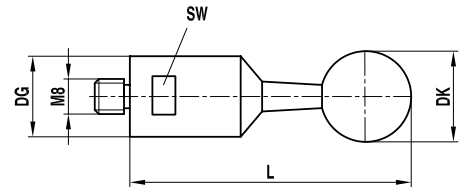

Spherical disk styli, aluminum base, high-strength steel disk

Part number	A-5555-0121	A-5555-0122	A-5555-0123	A-5555-0124
Zeiss order number	600341-8090	600341-8095	602030-8091	000000-1165-629
DK (mm)	10	15	20	15
L (mm)	21.5	21.5	60	40
DG (mm)	7	10	7	7
B (mm)	1.5	1.5	1	1
Weight (g)	3	6	8	5
Price	\$166	\$168	\$247	\$212

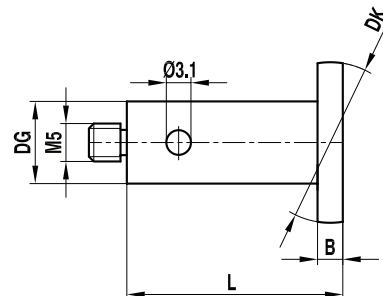

M5 styli for Zeiss probing systems

Extensions

Schematics not shown to scale

Aluminum, stainless steel ends

Part number	A-5555-0125	A-5555-0126	A-5555-0127	A-5555-0128	A-5555-0129	A-5555-0130	A-5555-0131	A-5555-0132
Zeiss order number	600341-8420	600341-8421	600341-8422	600341-8423	600341-8424	600341-8425	600341-8265	600341-8264
L (mm)	200	150	100	80	60	40	120	100
D (mm)	20	20	20	20	20	20	11	11
Weight (g)	84.7	67.4	50.7	44.8	37.7	29	30.9	25.6
Price	\$92	\$81	\$73	\$71	\$71	\$67	\$48	\$46

Part number	A-5555-0133	A-5555-0134	A-5555-0135
Zeiss order number	600341-8263	600341-8262	600341-8261
L (mm)	80	60	40
D (mm)	11	11	11
Weight (g)	20.6	15.4	10.3
Price	\$45	\$41	\$39

Stainless steel

Part number	A-5555-0136	A-5555-0137	A-5555-0138	A-5555-0139	A-5555-0140	A-5555-0141	A-5555-0142
Zeiss order number	600341-0260	600341-0258	600341-0256	600341-0254	600341-0252	600341-0251	600341-0250
L (mm)	100	80	60	40	20	15	10
D (mm)	11	11	11	11	11	11	11
Weight (g)	73	58	42	28	13	9	6
Price	\$29	\$29	\$27	\$25	\$25	\$25	\$25

Titanium

Part number	A-5555-0143	A-5555-0144	A-5555-0145	A-5555-0146	A-5555-0147	A-5555-0148	A-5555-0149	A-5555-0150
Zeiss order number	602030-9044	602030-9045	602030-9046	602030-9047	602030-9048	602030-9049	602030-9050	602030-9051
L (mm)	10	15	20	25	25	40	40	50
D (mm)	11	11	11	11	18	11	18	11
Weight (g)	3.9	5.7	7.5	9.5	24.6	12.6	31.5	13.2
Price	\$30	\$34	\$36	\$37	\$39	\$39	\$48	\$62

Part number	A-5555-0151	A-5555-0152	A-5555-0153	A-5555-0154	A-5555-0155	A-5555-0156	A-5555-0157	A-5555-0158
Zeiss order number	602030-9052	602030-9053	602030-9054	602030-9055	602030-9056	602030-9057	602030-9058	602030-9059
L (mm)	50	60	60	75	75	80	80	90
D (mm)	18	11	18	11	18	11	18	11
Weight (g)	33.3	14.2	35.1	15.3	37.9	15.6	38.8	16.5
Price	\$71	\$64	\$74	\$67	\$78	\$73	\$80	\$73

Part number	A-5555-0159	A-5555-0160	A-5555-0161	A-5555-0162	A-5555-0163	A-5555-0164	A-5555-0165	A-5555-0166
Zeiss order number	602030-9060	602030-9061	602030-9062	602030-9063	602030-9064	602030-9065	602030-9066	602030-9067
L (mm)	90	100	100	120	120	150	150	200
D (mm)	18	11	18	11	18	11	18	18
Weight (g)	40.6	17.2	42.5	19.8	46.1	22.5	51.6	61
Price	\$85	\$73	\$89	\$78	\$97	\$85	\$106	\$115

Part number	A-5555-0167	A-5555-0168
Zeiss order number	602030-9068	602030-9069
L (mm)	250	300
D (mm)	18	18
Weight (g)	70	79
Price	\$127	\$143

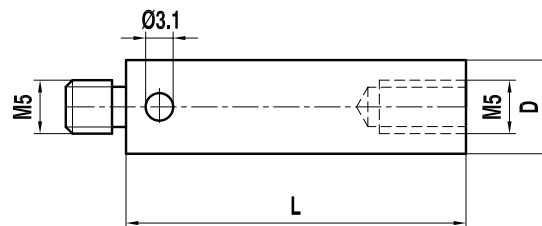

Black thermo stable carbon fiber, titanium ends

Schematics not shown to scale

Part number	A-5555-0647	A-5555-0648	A-5555-0649	A-5555-0623	A-5555-0650	A-5555-0651
Zeiss order number	626107-1040-100	626107-1050-100	626107-1060-100	626107-1070-100	626107-1080-100	626107-1090-100
L (mm)	40	50	60	70	80	90
D (mm)	11	11	11	11	11	11
Weight (g)	9	10	11	10	12	13
Price	\$157	\$159	\$162	\$166	\$170	\$182

Part number	A-5555-0652	A-5555-0425	A-5555-0424	A-5555-0653	A-5555-0654	A-5555-0655
Zeiss order number	626107-1100-100	626107-1120-100	626107-1150-100	626107-1180-100	626107-1200-100	626107-1250-100
L (mm)	100	120	150	180	200	250
D (mm)	11	11	11	11	11	11
Weight (g)	14	15	17	19	21	24
Price	\$187	\$191	\$201	\$208	\$221	\$238

Part number	A-5555-0642	A-5555-0656	A-5555-0620	A-5555-0657	A-5555-0658	A-5555-0621
Zeiss order number	626107-1300-100	626107-1400-100	626107-2040-100	626107-2050-100	626107-2060-100	626107-2080-100
L (mm)	300	400	40	50	60	80
D (mm)	11	11	21	20	21	21
Weight (g)	27	34	26	28	29	32
Price	\$280	\$333	\$154	\$159	\$162	\$170

Part number	A-5555-0659	A-5555-0661	A-5555-0663	A-5555-0427	A-5555-0664	A-5555-0665
Zeiss order number	626107-2100-100	626107-2150-100	626107-2200-100	626107-2250-100	626107-2300-100	626107-2400-100
L (mm)	100	150	200	250	300	400
D (mm)	21	21	21	21	21	20
Weight (g)	34	41	48	55	62	75
Price	\$192	\$214	\$238	\$266	\$298	\$349

Part number	A-5555-0667	A-5555-0668
Zeiss order number	626107-2500-100	626107-2600-100
L (mm)	500	600
D (mm)	20	20
Weight (g)	89	103
Price	\$420	\$280

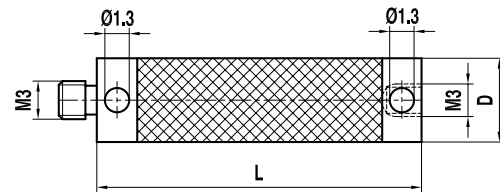

M5 styli for Zeiss probing systems

Adaptor plate extension for MT/VAST. Black thermo stable carbon fiber, titanium cube and plate adaptor

Schematics not shown to scale

Part number	A-5555-3845	A-5555-3846	A-5555-3847	A-5555-3848	A-5555-3849	A-5555-3850
Zeiss order number	-	-	-	-	-	-
L (mm)	25	40	50	60	80	100
DG (mm)	11	11	11	11	11	11
ML (mm)	66.5	81.5	91.5	101.5	121.5	141.5
B (mm)	15	15	15	15	15	15
Weight (g)	60	62	64	66	68	70
Price	\$259	\$266	\$273	\$282	\$298	\$309

Part number	A-5555-3851	A-5555-3740	A-5555-3852	A-5555-0699	A-5555-1985	A-5555-1986
Zeiss order number	-	-	-	625107-2025-130	625107-2040-130	625107-2050-130
L (mm)	120	150	200	25	40	50
DG (mm)	11	11	11	20	20	20
ML (mm)	161.5	191.5	241.5	66.5	81.5	91.5
B (mm)	15	15	15	15	15	15
Weight (g)	72	77	84	60	62	64
Price	\$321	\$361	\$374	\$277	\$284	\$291

Part number	A-5555-1987	A-5555-0700	A-5555-1988	A-5555-1989	A-5555-0701	A-5555-1990
Zeiss order number	626107-2060-130	626107-2080-130	626107-2100-130	625107-2120-130	625107-2150-130	625107-2200-130
L (mm)	60	80	100	120	150	200
DG (mm)	20	20	20	20	20	20
ML (mm)	101.5	121.5	141.5	161.5	191.5	241.5
B (mm)	15	15	15	15	15	15
Weight (g)	66	68	70	72	77	84
Price	\$300	\$317	\$335	\$349	\$376	\$418

Part number	A-5555-1979	A-5555-1980	A-5555-1855	A-5555-1981	A-5555-1982	A-5555-1983
Zeiss order number	626107-2025-110	626107-2040-110	626107-2050-110	625107-2060-110	625107-2080-110	625107-2100-110
L (mm)	25	40	50	60	80	100
DG (mm)	20	20	20	20	20	20
ML (mm)	71.5	86.5	96.6	106.5	126.5	146.5
B (mm)	20	20	20	20	20	20
Weight (g)	74	76	78	80	82	84
Price	\$265	\$284	\$293	\$302	\$319	\$337

Part number	A-5555-1938	A-5555-1937	A-5555-1984
Zeiss order number	626107-2120-110	626107-2150-110	626107-2200-110
L (mm)	120	150	200
DG (mm)	20	20	20
ML (mm)	166.5	196.5	246.5
B (mm)	20	20	20
Weight (g)	86	91	98
Price	\$349	\$376	\$418

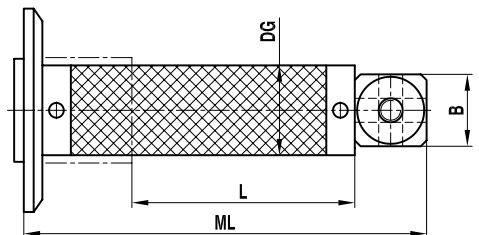
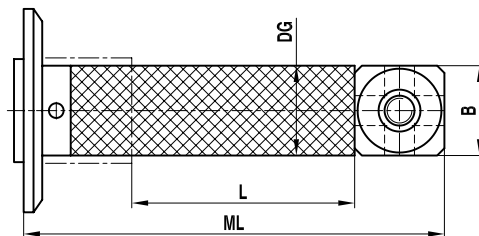

Cube, titanium

Schematics not shown to scale

Part number	A-5555-0189	A-5555-0190
Zeiss order number	600341-8361	600341-8002
B (mm)	15	20
Weight (g)	12.6	31.5
Price	\$50	\$60

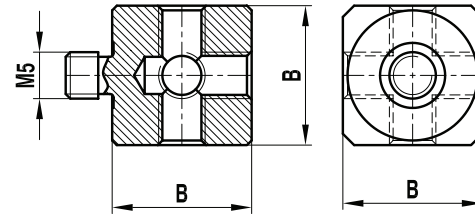

Cube, aluminum

Part number	A-5555-0191	A-5555-0192
Zeiss order number	602030-8363	602030-8362
B (mm)	15	20
Weight (g)	7.5	20
Price	\$69	\$87

Double cube (titanium)

Part number	A-5555-0194
Zeiss order number	600342-8103
B (mm)	20
L (mm)	40
Weight (g)	64
Price	\$108

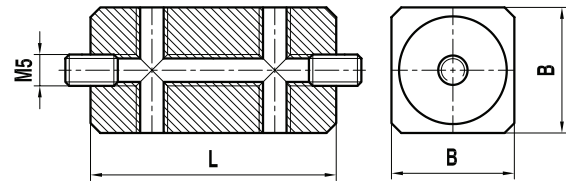

Spherical disk, high-strength steel

Part number	A-5555-0196	A-5555-0197	A-5555-0198	A-5555-0199	A-5555-0200	A-5555-0201	A-5555-0203
Zeiss order number	602030-0004	602030-0005	602030-0006	602030-0007	602030-0008	602030-0009	602030-0011
B (mm)	4	4	4	5	5	5	4
DK (mm)	15	20	30	40	50	60	20
M5/8 (mm)	M5	M5	M5	M5	M5	M5	8
Weight (g)	5	9	21	42	64	89	8
Price	\$134	\$134	\$136	\$145	\$145	\$148	\$147

Part number	A-5555-0204	A-5555-0205	A-5555-0206	A-5555-0207	A-5555-0208
Zeiss order number	600341-0200	600341-0203	600341-0204	600341-0205	600341-0206
B (mm)	2	4	4	5	6
DK (mm)	20	30	40	50	60
M5/8 (mm)	8	8	8	8	8
Weight (g)	4	10	21	36	59
Price	\$138	\$138	\$140	\$154	\$159

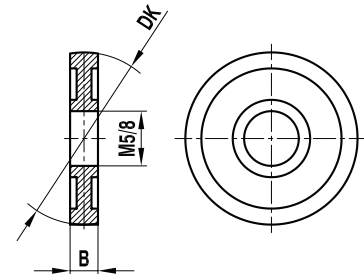

M5 styli for Zeiss probing systems

Hole location gage, stainless steel

Schematics not shown to scale

Part number	A-5555-0209	A-5555-0210	A-5555-0211	A-5555-0212	A-5555-0213	A-5555-0214
Zeiss order number	602030-0012	602030-0013	600203-0014	602030-0015	602030-0016	600203-0017
G1	M4	M5	M6	M8	M10	M12
L (mm)	16	16	18	20	25	25
DG (mm)	10	10	12	15	18	20
ML (mm)	10	10	12	12	15	15
MB (mm)	1.8	1.8	1.8	3	3	3
Weight (g)	4	4	7	13	25	33
Price	\$73	\$73	\$71	\$74	\$74	\$76

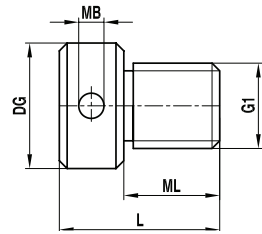

Star stylus, stainless steel base, tungsten carbide stem, ruby ball

Part number	A-5555-0215
Zeiss order number	600331-8093
DK (mm)	5
L (mm)	80
DG (mm)	19
DS (mm)	3.5
Weight (g)	70
Price	\$437

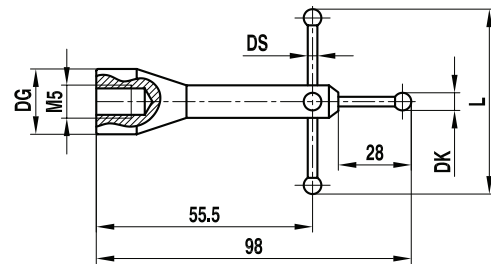

Pointed stylus, titanium base, tungsten carbide stem

Part number	A-5555-0216
Zeiss order number	600342-8051
L (mm)	61
DG (mm)	11
ML (mm)	39
DS (mm)	3.5
Weight (g)	12
Price	\$69

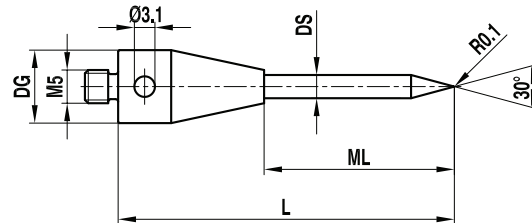

Cube extension, titanium

Part number	A-5555-0217
Zeiss order number	602030-0019
L (mm)	120
B (mm)	20
Weight (g)	87
Price	\$265

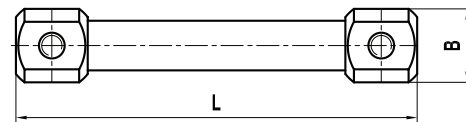

Knuckle, swing range 180 degrees, titanium

Part number	A-5555-0218	A-5555-0219
Zeiss order number	600342-9002	600342-9003
L (mm)	30	36
D (mm)	11	18
Weight (g)	11.2	37.2
Price	\$122	\$140

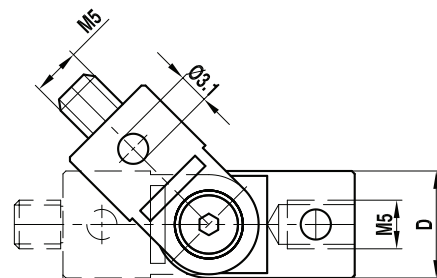

Bolts for spherical disk and cube, stainless steel

Schematics not shown to scale

Part number	A-5555-0221	A-5555-0222	A-5555-0223
Zeiss order number	600341-0210	600341-0211	600341-0212
L (mm)	35	30	17.5
ML (mm)	26	21	9
Weight (g)	9	9	7
Price	\$19	\$17	\$15

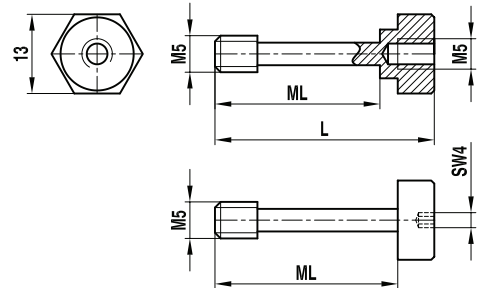

Bolts for cubes, stainless steel

Part number	A-5555-0224	A-5555-0225
Zeiss order number	600341-0220	600341-0221
ML (mm)	26	21
Weight (g)	4	3
Price	\$9	\$9

Adaptor, stainless steel

Part number	A-5555-0226	A-5555-0227	A-5555-0228
Zeiss order number	602030-0215	602030-0315	602030-0318
Threads	M5/M2	M5/M3	M5/M4
L (mm)	10	10	10
DG (mm)	11	11	11
Weight (g)	5.2	5.2	5.2
Price	\$20	\$20	\$20

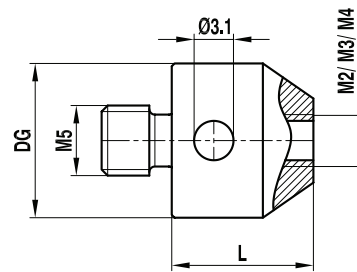

Holder for digitalization styli, stainless steel

Part number	A-5555-0231	A-5555-0232
Zeiss order number	602030-9113	602030-9115
L (mm)	119	127
D (mm)	15.81	9.52
B	M2	M2
Weight (g)	126	87
Price	\$268	\$302

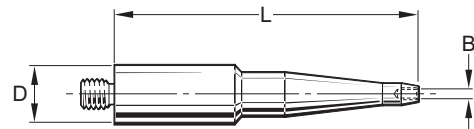

Adaptor plates for Zeiss probe heads

Adaptor plate for dynamic systems (ST), aluminum

Part number	A-5555-0322	A-5555-0251
Zeiss order number	600660-8240	600660-8251
Quantity in kit	1	2
Weight (g)	72	144
Price	\$300	\$599

Schematics not shown to scale

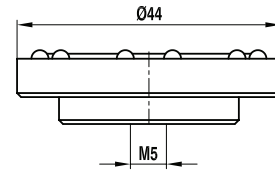

Adaptor plate for Prismo dynamic systems (ST), aluminum

Part number	A-5555-0253	A-5555-3900
Zeiss order number	620660-8251-000	—
Quantity in kit	2	1
Weight (g)	144	72
Price	\$599	\$300

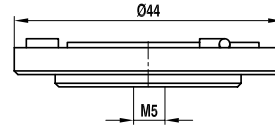

Adaptor plate for measuring systems MT/Vast, aluminum, with active ID chip

Part number	A-5555-0255	A-5555-0256	A-5555-0258*
Zeiss order number	600667-9601	600667-9611	600667-8571
Quantity in kit	1	2	1
Weight (g)	153	306	130
Price	\$441	\$881	\$441

* adaptor plate without cube

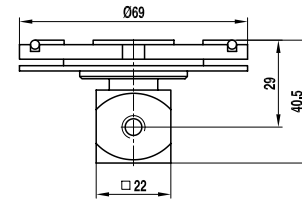

Adaptor plate for XXT TL1, reference plate for XXT TL1

Part number	A-5555-1235	A-5555-1236
Zeiss order number	620161-8055-000	620161-8058-000
Weight (g)	4.6	4.6
Price	\$390	\$312

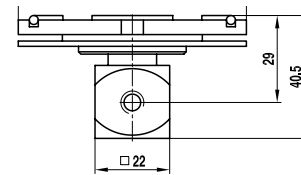

Adaptor plate for VAST XXT TL2, reference plate for XXT TL2

Part number	A-5555-1237	A-5555-1238
Zeiss order number	620161-8065-000	620161-8068-000
Weight (g)	5.4	5.4
Price	\$369	\$369

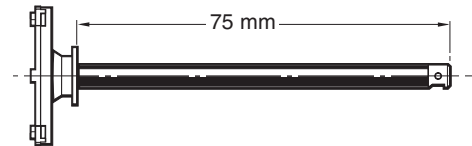

Adaptor plate for VAST XXT TL3, reference plate for XXT TL3

Part number	A-5555-1239	A-5555-1240
Zeiss order number	620161-8075-000	620161-8078-000
Weight (g)	4.6	4.6
Price	\$369	\$369

VAST XXT TL1 with star adaptor

Part number	A-5555-1241
Zeiss order number	626103-8031-055
Weight (g)	6.3
Price	\$340

VAST XXT TL3 with star adaptor

Part number	A-5555-1242
Zeiss order number	626103-8033-055
Weight (g)	6.3
Price	\$340

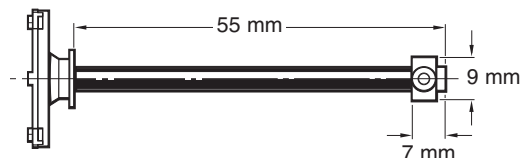

M3 styli, adaptors and accessories for Zeiss analog probe systems

Schematics not shown to scale

Carbide styli XXT, titanium base, tungsten carbide stem, ruby ball

Part number	A-5004-3176	A-5004-2185	A-5004-1702	A-5004-2186	A-5555-3853	A-5004-3179
Zeiss order number	626113-0030-013	626113-0030-020	626113-0050-013	626113-0050-020	626113-0060-014	626113-0060-020
DK (mm)	0.3	0.3	0.5	0.5	0.6	0.6
L (mm)	13	20	13	20	14	20
DG (mm)	5	5	5	5	5	5
ML (mm)	4	11	4	11	5	1
ML1 (mm)	2.3	2.3	2.3	2.3	4.6	4.6
DS (mm)	1	1	1	1	1	1
DS1 (mm)	0.2	0.2	0.3	0.3	0.4	0.4
Weight (g)	0.62	0.69	0.61	0.69	0.61	0.68
Price	\$167	\$73	\$73	\$73	\$57	\$60

Part number	A-5004-3273	A-5004-3274	A-5004-1883	A-5004-3187	A-5555-3854	A-5004-1863
Zeiss order number	626113-0080-014	626113-0080-020	626113-0080-034	626113-0100-014	626113-0101-020	626113-0100-020
DK (mm)	0.8	0.8	0.8	1	1	1
L (mm)	14	20	34	14	20	20
DG (mm)	5	5	5	5	5	5
ML (mm)	5	11	25	5	11	11
ML1 (mm)	-	4.8	4.1	-	5.1	5
DS (mm)	0.6	1	1	0.8	1	1
DS1 (mm)	-	0.6	0.6	-	0.6	0.8
Weight (g)	0.62	0.69	0.8	0.63	0.7	0.69
Price	\$57	\$57	\$69	\$59	\$64	\$60

Part number	A-5004-3519	A-5004-3427	A-5555-9341	A-5004-3272	A-5004-1862	A-5555-9339
Zeiss order number	626113-0130-020	626113-0100-030	626113-0100-040	626113-0150-014	626113-0150-020	626113-0151-030
DK (mm)	1	1	1	1.5	1.5	1.5
L (mm)	20	30	40	14	20	30
DG (mm)	5	5	5	5	5	5
ML (mm)	11	21	31	5	11	21
ML1 (mm)	-	5	5	-	-	-
DS (mm)	0.8	1	1	1	1	1
DS1 (mm)	-	0.8	0.8	-	-	-
Weight (g)	0.7	0.8	1.5	0.65	0.72	0.84
Price	\$54	\$64	\$66	\$57	\$60	\$62

Part number	A-5555-9340	A-5004-1779	A-5004-3188	A-5004-1861	A-5004-0656	A-5555-3855
Zeiss order number	626113-0150-030	626113-0151-040	626113-0200-014	626113-0200-020	626113-0200-030	626113-0021-040
DK (mm)	1.5	1.5	2	2	2	2
L (mm)	30	40	14	20	30	40
DG (mm)	5	5	5	5	5	5
ML (mm)	22.5	31	5	11	21	31
DS (mm)	1	1	1	1	1	1.5
Weight (g)	0.9	1.6	0.66	0.72	0.83	1.7
Price	\$67	\$69	\$59	\$62	\$60	\$64

Part number	A-5555-3856	A-5555-3857	A-5004-3428
Zeiss order number	626113-0250-020	626113-0250-030	626113-0250-040
DK (mm)	2.5	2.5	2.5
L (mm)	20	30	40
DG (mm)	5	5	5
ML (mm)	11	21	31
DS (mm)	1.5	1.5	1.5
Weight (g)	1	1.5	2
Price	\$60	\$62	\$64

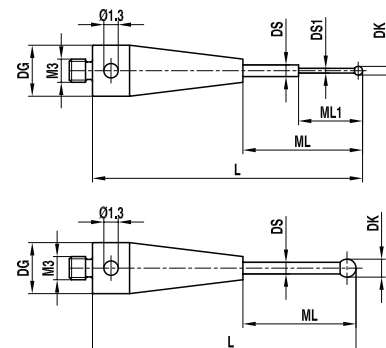

M3 styli for Zeiss probing systems

Reference styli **XXT (red dot)**, titanium base, thermo stable carbon fiber stem, ruby ball

Schematics not shown to scale

Part number	A-5555-2033	A-5555-3858
Zeiss order number	626103-0501-030	626103-0501-050
DK (mm)	5	5
L (mm)	30	50
DG (mm)	5	5
ML (mm)	21	41
DS (mm)	3.5	3.5
Weight (g)	1.1	1.4
Price	\$110	\$106

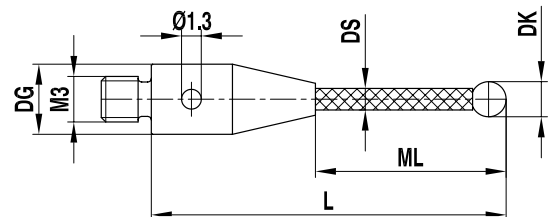

Thermo stable carbon fiber styli XXT, titanium base, thermo stable carbon fiber stem, ruby ball

Schematics not shown to scale

Part number	A-5555-3859	A-5004-0802	A-5555-1251	A-5004-1884	A-5004-0803	A-5555-3860
Zeiss order number	626103-0300-025	626103-0300-033	626103-0300-040	626103-0300-042	626103-0300-050	626103-0300-058
DK (mm)	3	3	3	3	3	3
L (mm)	25	33	40	42	50	58
DG (mm)	5	5	5	5	5	5
ML (mm)	16	24	31	33	41	49
DS (mm)	2	2	2	2	2	2
Weight (g)	0.65	0.7	0.8	0.8	0.8	1
Price	\$89	\$97	\$96	\$99	\$99	\$106

Part number	A-5555-3861	A-5555-3862	A-5004-2786	A-5004-2108	A-5003-0062	A-5004-0806
Zeiss order number	626103-0300-059	626103-0300-075	626103-0401-050	626103-0500-030	626103-0500-040	626103-0500-050
DK (mm)	3	3	4	5	5	5
L (mm)	59	75	50	30	40	50
DG (mm)	5	5	5	5	5	5
ML (mm)	50	66	41	21	31	41
DS (mm)	2	2	2	3.5	3.5	3.5
Weight (g)	1	1	1	1.1	1.2	1.4
Price	\$106	\$108	\$99	\$106	\$74	\$106

Part number	A-5555-3864	A-5555-1114	A-5004-3429	A-5555-3865	A-5555-1115	A-5555-3866
Zeiss order number	626103-0500-060	626103-0501-075	626103-0600-050	626103-0610-070	626103-0600-100	626103-0800-030
DK (mm)	5	5	6	6	6	8
L (mm)	60	75	50	70	100	30
DG (mm)	5	5	5	5	5	5
ML (mm)	51	66	40	61	91	30
DS (mm)	3.5	3.5	3.5	3.5	3.5	5
Weight (g)	1.5	1.8	1.5	1.8	2.4	1.86
Price	\$108	\$113	\$126	\$127	\$129	\$138

Part number	A-5555-3867	A-5555-3868	A-5555-3869	A-5004-0808
Zeiss order number	626103-0830-050	626103-0830-070	626103-0830-100	626103-0800-125
DK (mm)	8	8	8	8
L (mm)	50	70	100	125
DG (mm)	5	5	5	5
ML (mm)	50	70	100	125
DS (mm)	5	5	5	5
Weight (g)	2.1	2.6	2.7	2.9
Price	\$148	\$154	\$159	\$162

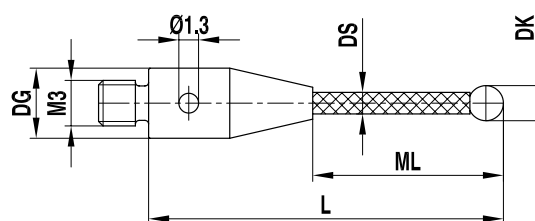

M3 styli for Zeiss probing systems

Thermo stable carbon fiber styli XXT, titanium base, thermo stable carbon fiber stem, silicon nitride ball

Schematics not shown to scale

Part number	A-5555-3870	A-5555-3871	A-5555-3872	A-5004-1858	A-5555-3873	A-5555-3874
Zeiss order number	626103-0301-033	626103-0301-050	626103-0502-050	626103-0500-075	626103-0801-070	626103-0801-125
DK (mm)	3	3	5	5	8	8
L (mm)	33	50	50	75	70	125
DG (mm)	5	5	5	5	5	5
ML (mm)	24	41	41	66	70	125
DS (mm)	2	2	3.5	3.5	5	5
Weight (g)	0.7	0.8	1.4	1.8	2.6	2.9
Price	\$122	\$126	\$134	\$138	\$205	\$212

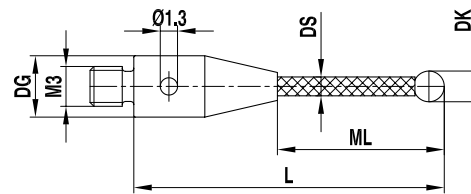

Thermo stable carbon fiber clamping styli XXT, titanium base, thermo stable carbon fiber stem, ruby ball

Part number	A-5555-3875	A-5555-3876	A-5004-3282
Zeiss order number	626103-0301-020	626103-0301-030	626103-0301-040
DK (mm)	3	3	3
L (mm)	20	30	40
DG (mm)	5	5	5
ML (mm)	11	21	31
DS (mm)	2	2	2
Weight (g)	0.7	0.75	0.8
Price	\$99	\$104	\$110

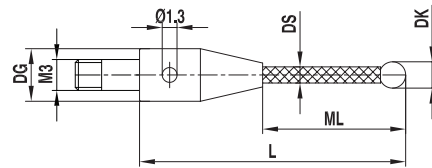

Thermo stable carbon fiber clamping styli XXT, titanium base, thermo stable carbon fiber stem, silicon nitride ball

Part number	A-5555-3877	A-5555-3878	A-5555-3879
Zeiss order number	626103-0311-020	626103-0311-030	626103-0311-040
DK (mm)	3	3	3
L (mm)	20	30	40
DG (mm)	5	5	5
ML (mm)	11	21	31
DS (mm)	2	2	2
Weight (g)	0.7	0.75	0.8
Price	\$104	\$110	\$113

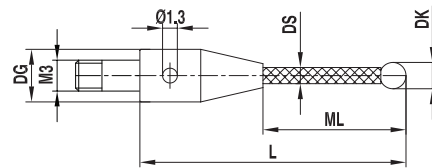

¼ star styli, thermo stable carbon fiber XXT, titanium base, thermo stable carbon fiber stem, ruby ball

Schematics not shown to scale

Part number	A-5555-1273	A-5555-1274	A-5555-1275
Zeiss order number	626103-0302-020	626103-0302-030	626103-0302-040
DK (mm)	3	3	3
L (mm)	20	30	40
DG (mm)	5	5	5
ML (mm)	11	21	31
DS (mm)	2	2	2
Weight (g)	0.8	0.9	1
Price	\$157	\$162	\$168

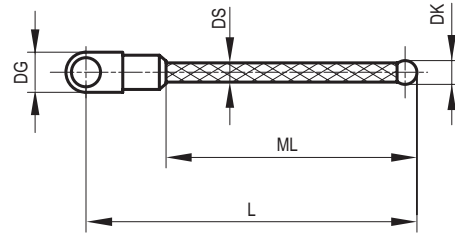

¼ star styli, thermo stable carbon fiber XXT, titanium base, thermo stable carbon fiber stem, silicon nitride ball

Part number	A-5555-3880	A-5555-3881	A-5555-3901
Zeiss order number	626103-0312-020	626103-0312-030	626103-0312-040
DK (mm)	3	3	3
L (mm)	20	30	40
DG (mm)	5	5	5
ML (mm)	11	21	31
DS (mm)	2	2	2
Weight (g)	0.8	0.9	1
Price	\$157	\$162	\$168

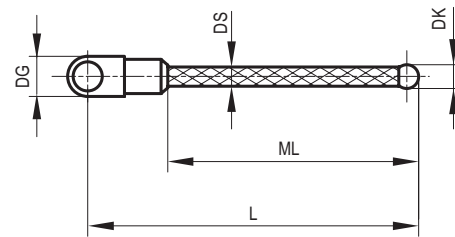

½ star styli, thermo stable carbon fiber XXT, 90 degrees, titanium base, thermo stable carbon fiber stem, ruby ball

Part number	A-5555-3882	A-5555-3883	A-5004-3284							
Zeiss order number	626103-0303-020	626103-0303-030	626103-0303-040							
DK (mm)	3	3	3							
L (mm)	20	30	40							
DG (mm)	5	5	5							
ML (mm)	11	21	31							
DS (mm)	2	2 </tr <tr> <td>Weight (g)</td> <td>1.4</td> <td>1.5</td> <td>1.6</td> </tr> <tr> <td>Price</td> <td>\$309</td> <td>\$314</td> <td>\$319</td> </tr>	Weight (g)	1.4	1.5	1.6	Price	\$309	\$314	\$319
Weight (g)	1.4	1.5	1.6							
Price	\$309	\$314	\$319							

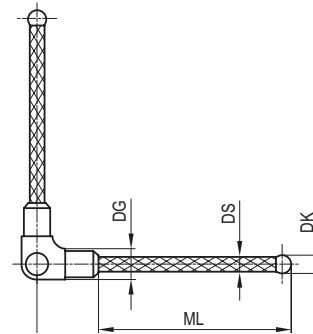

½ star styli, thermo stable carbon fiber XXT, 90 degrees, titanium base, thermo stable carbon fiber stem, silicon nitride ball

Part number	A-5555-3884	A-5555-3885	A-5555-3886
Zeiss order number	626103-0313-020	626103-0313-030	626103-0313-040
DK (mm)	3	3	3
L (mm)	20	30	40
DG (mm)	5	5	5
ML (mm)	11	21	31
DS (mm)	2	2	2
Weight (g)	1.4	1.5	1.6
Price	\$309	\$314	\$319

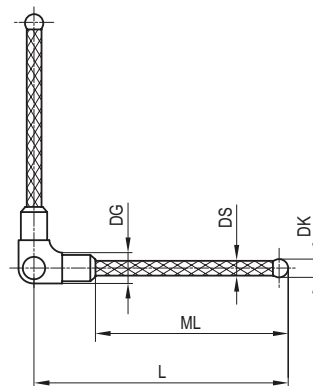

M3 styli for Zeiss probing systems

½ star styli, thermo stable carbon fiber XXT, 180 degrees, titanium base, thermo stable carbon fiber stem, ruby ball

Schematics not shown to scale

Part number	A-5555-3887	A-5555-3888	A-5004-0654
Zeiss order number	626103-0304-020	626103-0304-030	626103-0304-040
DK (mm)	3	3	3
L (mm)	20	30	40
DG (mm)	5	5	5
ML (mm)	11	21	31
DS (mm)	2	2	2
Weight (g)	1.4	1.5	1.6
Price	\$309	\$314	\$235

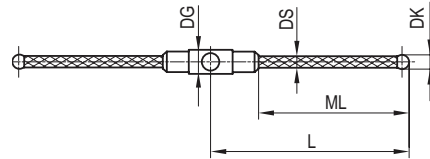

½ star styli, thermo stable carbon fiber XXT, 180 degrees, titanium base, thermo stable carbon fiber stem, silicon nitride ball

Part number	A-5555-3889	A-5555-3890	A-5555-3891
Zeiss order number	626103-0314-020	626103-0314-030	626103-0314-040
DK (mm)	3	3	3
L (mm)	20	30	40
DG (mm)	5	5	5
ML (mm)	11	21	31
DS (mm)	2	2	2
Weight (g)	1.4	1.5	1.6
Price	\$309	\$314	\$319

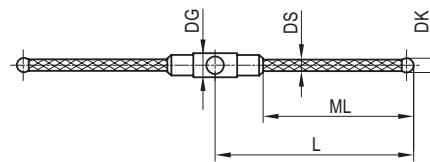

Extension XXT, thermo stable black carbon fiber, titanium ends

Part number	A-5555-3892	A-5555-1947	A-5004-3430	A-5555-3893	A-5004-0002	A-5555-3894
Zeiss order number	626103-5020-000	626103-5025-000	626103-5030-000	626103-5040-000	626103-5050-000	626103-5060-000
D (mm)	5	5	5	5	5	5
L (mm)	20	25	30	40	50	60
Weight (g)	1.2	1.25	1.3	1.4	1.5	1.7
Price	\$73	\$78	\$81	\$71	\$99	\$106

Part number	A-5555-1948	A-5004-2001	A-5004-1859	A-5555-3895	A-5555-1276
Zeiss order number	626103-5075-000	626103-5080-000	626103-5100-000	626103-5130-000	626103-5150-000
D (mm)	5	5	5	5	5
L (mm)	75	80	100	130	150
Weight (g)	1.7	1.8	2	2.5	2.7
Price	\$120	\$124	\$140	\$166	\$182

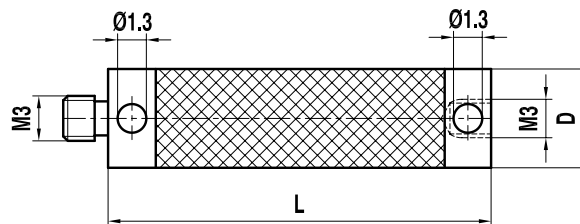

Clamping screw XXT, titanium

Schematics not shown to scale

Part number	A-5004-1856
Zeiss order number	626103-6110-004
DG (mm)	5
L (mm)	8
Weight (g)	0.5
Price	\$18

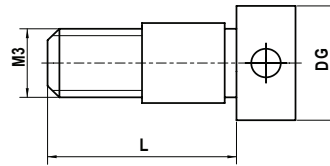

Clamping screw XXT with internal M3 thread, titanium

Part number	A-5004-1857
Zeiss order number	626103-6110-005
DG (mm)	5
L (mm)	8
Weight (g)	0.7
Price	\$18

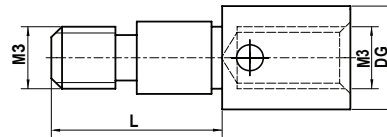

Cube XXT 90 degrees, 1 way, titanium

Part number	A-5004-3437
Zeiss order number	626103-6110-001
B (mm)	5
L (mm)	6.5
Weight (g)	0.64
Price	\$71

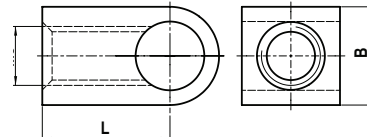

Cube XXT 180 degrees, 2 way, titanium

Part number	A-5555-3896
Zeiss order number	626103-6110-002
B (mm)	5
L (mm)	13
Weight (g)	1.05
Price	\$81

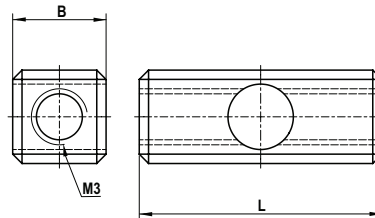

Cube star XXT, titanium

Part number	A-5555-3897
Zeiss order number	626103-6110-003
B (mm)	5
L (mm)	13
Weight (g)	1.8
Price	\$90

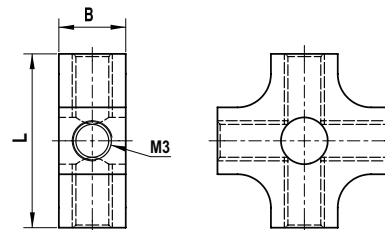

M3 styli for Zeiss probing systems

Cube XXT, 6 star, titanium

Schematics not shown to scale

Part number	A-5555-3898
Zeiss order number	626103-6110-006
B (mm)	5
DG (mm)	12
Weight (g)	1.8
Price	\$113

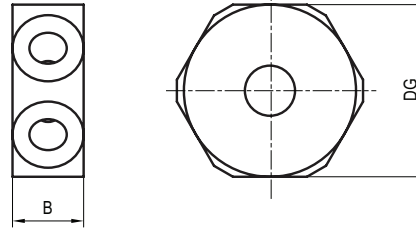

Cube XXT, 8 star, titanium

Part number	A-5555-3899
Zeiss order number	626103-6110-007
B (mm)	5
DG (mm)	14
Weight (g)	2.3
Price	\$131

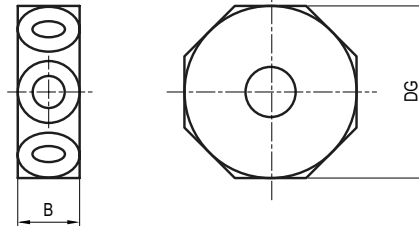

Knuckle XXT, titanium

Part number	A-5004-3285
Zeiss order number	626103-6180-001
B (mm)	5
L (mm)	10
Weight (g)	1.65
Price	\$168

Tungsten carbide styli, stainless steel base, tungsten carbide stem, ruby ball

Schematics not shown to scale

Part number	A-5555-0261	A-5555-0263	A-5555-0265	A-5555-0267	A-5555-0268	A-5555-0269	A-5555-0270	A-5555-0271
Zeiss order number	602030-8104	602030-8113	602030-8112	602030-8115	602030-8116	602030-8117	602030-8118	602030-8119
DK (mm)	2	3	4	0.5	0.6	0.8	1	1.5
L (mm)	22	40	33	22	22	22	22	22
DG (mm)	4	5.5	4	4	4	4	4	4
ML (mm)	9	21.5	23	9	9	9	9	9
ML1 (mm)	-	-	-	2.5	4.6	4.8	5	-
DS (mm)	1	2	2.5	1	1	1	1	1
DS1 (mm)	-	-	-	0.3	0.4	0.6	0.8	-
Weight (g)	1	4	2.5	1	1	1	1	1
Price	\$32	\$43	\$43	\$55	\$55	\$52	\$48	\$41

Part number	A-5555-0272	A-5555-0273	A-5555-0274	A-5555-0276	A-5555-0277
Zeiss order number	602030-8120	602030-8121	602030-8023	602030-8021	602030-8106
DK (mm)	1	0.3	2	3	3
L (mm)	10.5	22	21	21.5	21
DG (mm)	4	4	4	4	4
ML (mm)	5.5	9	15	15.5	13
ML1 (mm)	5	2.3	-	-	-
DS (mm)	10	1	1	1.5	2
DS1 (mm)	0.8	.02	-	-	-
Weight (g)	1	1	1	1	1
Price	\$53	\$74	\$36	\$41	\$39

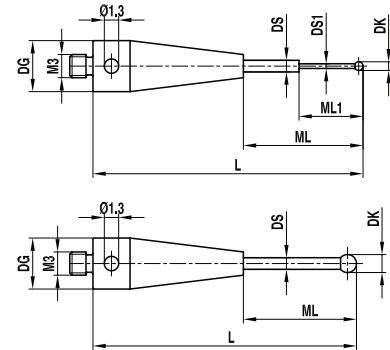

Ceramic styli, stainless steel base, ceramic stem, ruby ball

Part number	A-5555-0264	A-5555-0266	A-5555-0275
Zeiss order number	602030-8102	602030-8101	602030-8020
DK (mm)	4	5	6
L (mm)	32	32	13
DG (mm)	4	4	4
ML (mm)	26	19	9
DS (mm)	2	2	2
Weight (g)	1	1	1
Price	\$43	\$45	\$48

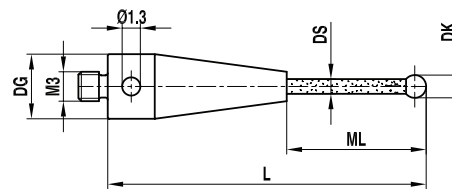

Stainless steel extensions

Part number	A-5004-7609	A-5004-7583	A-5555-0286	A-5555-0287	A-5555-0288
Zeiss order number	602030-8301	602030-8302	602030-8303	602030-8304	602030-8305
L (mm)	10	20	30	40	50
D (mm)	4	4	4	4	4
Weight (g)	0.7	1.6	2.6	3.7	4.7
Price	\$13	\$15	\$18	\$23	\$23

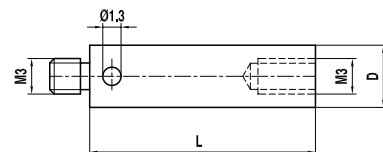

M2 styli, adaptors and accessories for Zeiss analog probe systems

Schematics not shown to scale

Ceramic styli, stainless steel base, ceramic stem, ruby ball

Part number	A-5555-0278	A-5555-0279
Zeiss order number	602030-8002	602030-8004
DK (mm)	6	5
L (mm)	13	22.5
DG (mm)	3	3
ML (mm)	9	16.5
DS (mm)	2	2
Weight (g)	1	1
Price	\$48	\$55

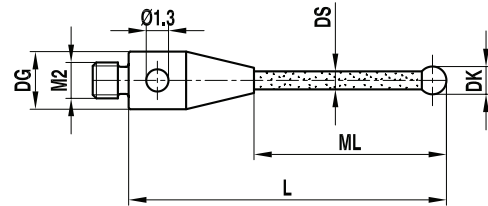

Tungsten carbide styli, stainless steel base, tungsten carbide stem, ruby ball

Part number	A-5555-0308	A-5555-0309	A-5555-0282	A-5555-0310	A-5555-0311	A-5003-3822	A-5003-0938	A-5555-0312
Zeiss order number	602030-8006	602030-8007	602030-8001	602030-8008	602030-8009	602030-8005	602030-8003	602030-8015
DK (mm)	1	1	2	2	2	2	3	4
L (mm)	10.5	15.5	11	11	16	21	21.5	12
DG (mm)	3	3	3	3	3	3	3	3
ML (mm)	6.5	11.5	5	7	12	15	15.5	8
DS (mm)	0.8	0.8	1	1	1	1	1.5	2.5
Weight (g)	0.3	0.3	1	1	1	1	1	1
Price	\$36	\$36	\$25	\$27	\$27	\$27	\$78	\$34

Part number	A-5555-0313	A-5555-0283
Zeiss order number	602030-8016	602030-8034
DK (mm)	4	5
L (mm)	22	22.5
DG (mm)	3	3
ML (mm)	18	16.5
DS (mm)	2.5	2
Weight (g)	1	1
Price	\$36	\$50

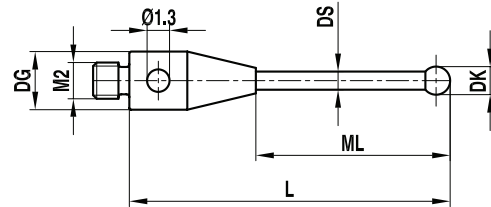

Steel styli, stainless steel base and stem, ruby ball

Part number	A-5555-0314	A-5555-0315	A-5555-0316
Zeiss order number	602030-8017	602030-8018	602030-8019
DK (mm)	6	6	8
L (mm)	13	28	13
DS (mm)	3	3	3
DG (mm)	3	3	3
Weight (g)	0.9	1.8	2
Price	\$45	\$46	\$66

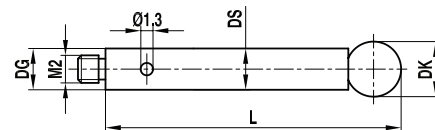

Star styli, stainless steel cube base and stem, ruby ball

Schematics not shown to scale.

Part number	A-5555-0294	A-5555-0295
Zeiss order number	602030-8011	602030-8010
DK (mm)	2	2
L (mm)	32	22
ML (mm)	9.5	4.5
DS (mm)	1.4	1.4
B (mm)	5.5	5.5
Weight (g)	1	1
Price	\$126	\$133

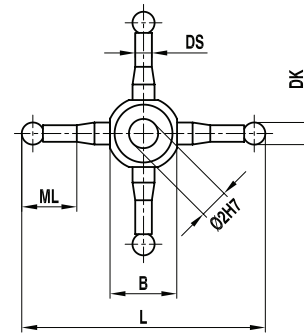

Styli for star configuration, stainless steel base and stem, ruby ball

Part number	A-5555-0296
Zeiss order number	602030-8012
DK (mm)	2
L (mm)	19.5
DG (mm)	3
ML (mm)	13.5
DS (mm)	1.5
Weight (g)	1
Price	\$43

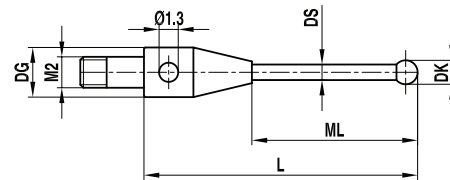

Spherical disk styli, stainless steel base, tungsten carbide stem, ceramic disk

Part number	A-5555-0297	A-5555-0298
Zeiss order number	602030-8201	602030-8202
DK (mm)	8	4
L (mm)	32	32
DG (mm)	3	3
ML (mm)	19	19
DS (mm)	1.5	1
B (mm)	1.5	1
Weight (g)	1	1
Price	\$117	\$87

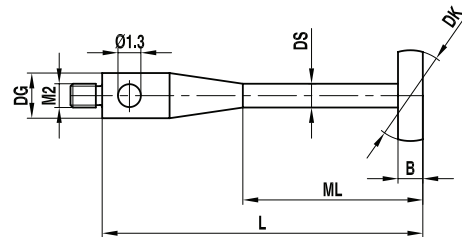

Spherical disk styli, stainless steel base and stem, ceramic disk

Part number	A-5555-0299	A-5555-0300
Zeiss order number	602030-8203	602030-8204
DK (mm)	14	20
L (mm)	5.5	5.5
B (mm)	2	2.5
Weight (g)	1	3
Price	\$157	\$187

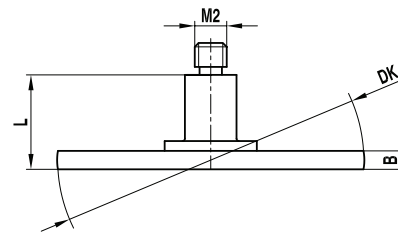

Pointer styli, stainless steel base, cone point, tungsten carbide

Part number	A-5555-0317	A-5555-0318
Zeiss order number	602030-8342	602030-8343
L (mm)	10	10
DG (mm)	3	3
DS (mm)	1.5	1.5
DK	30°	60°
Weight (g)	1	1
Price	\$28	\$28

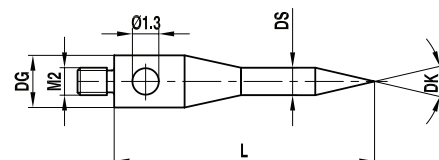

M2 styli for Zeiss probing systems

Stainless steel extension

Schematics not shown to scale

Part number	A-5004-7610	A-5004-7585	A-5004-7586	A-5004-7591	A-5004-7611
Zeiss order number	602030-8321	602030-8322	602030-8323	602030-8324	602030-8325
L (mm)	5	10	20	30	40
D (mm)	3	3	3	3	3
Weight (g)	0.2	0.5	1	1.4	2.2
Price	\$12	\$13	\$15	\$17	\$19

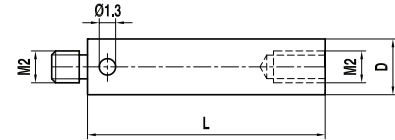

5-way holder, rotary, stainless steel

Part number	A-5000-3627
Zeiss order number	602030-8381
L (mm)	7.5
B (mm)	7
Weight (g)	1.2
Price	\$48

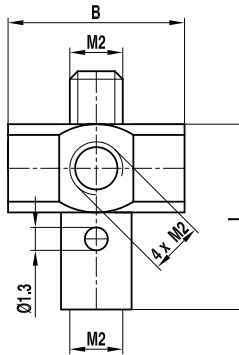

5-way holder, stainless steel

Part number	A-5555-0319	A-5555-0320
Zeiss order number	602030-9104	602030-9103
L (mm)	9.1	5.4
D (mm)	10.5	7
Weight (g)	3.4	1
Price	\$81	\$39

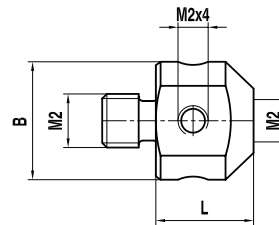

Renishaw tools and accessories for the assembly of M2, M3 and M5 styli to Zeiss measuring probe heads

Schematics not shown to scale

Stylus tool (M2 and M3 styli)

Part number	A-5555-0233
Zeiss order number	602030-0001
DK (mm)	1.2
L (mm)	23
Weight (g)	1
Price	\$10



Allen keys DIN 911

Part number	A-5555-0234	A-5555-0235	A-5555-0236
Zeiss order number	602030-0002	602030-0042	602030-0021
B (mm)	SW1.5	SW0.9	SW2.5
Weight (g)	1	1	2
Price	\$1	\$1	\$1



Tool kit

consisting of:

Part number	A-5555-0237
Zeiss order number	600341-8595
Price	\$30

	1 x offset screwdriver DIN 911-2	1 x offset screwdriver DIN 911-3	1 x offset screwdriver DIN 911-4	2 x pin-type spanner 2.9 mm	1 x single-headed spanner DIN 894
DK (mm)	–	–	–	2.9	–
L (mm)	–	–	–	70	–
D (mm)	–	–	–	5	–
B	SW2	SW3	SW4	–	SW13
Weight (g)	1	5	10	15 each	39

Stylus tool kit (2 x pin-type spanners 2.9 mm for M5)

Part number	A-5555-0238
Zeiss order number	600341-8596
DK (mm)	2.9
L (mm)	70
D (mm)	5
Weight (g)	15
Price	\$23

Stylus tool 1.7 mm for M5

Part number	A-5555-0239
Zeiss order number	602030-0027
DK (mm)	1.7
L (mm)	49
D (mm)	2.5
Weight (g)	1
Price	\$10

Styli tools for Zeiss probing systems

Pin-type spanner 2.9 mm for M5

Part number	A-5555-0240
Zeiss order number	602030-0222
DK (mm)	2.9
L (mm)	70
D (mm)	5
Weight (g)	7.5
Price	\$12

Assortment of screws

Part number	A-5555-0241
Zeiss order number	600341-8590
Weight (g)	27
Price	\$28

Includes:

10 spring-lock washers FS 5x7
2 cheese-head screws M5x12
2 cheese-head screws M5x20
4 grub screws 10 mm long
2 grub screws 25 mm long

Spring-lock washers

Part number	A-5555-0242
Zeiss order number	600341-0042
Price	\$5

Includes:

10 x FS 5.7 spring-lock washers

C spanners DIN 1810

Part number	A-5555-0243	A-5555-0244
Zeiss order number	602030-0045	602030-0044
DK (mm)	11	21
Price	\$14	\$17

Accessories

Stylus knuckles

Part number	A-5000-7534	A-5003-4697	A-5000-9902 Rotary	A-5000-7616	A-5003-4686 Rotary	A-5003-4689 Rotary	* A-5003-5278 Rotary	A-5003-5279 Rotary
Thread size	M2	M2	M2	M3	M3	M4	M5	M5
Effective length mm (in.)	8.0 (0.32)	13.5 (0.54)	16.5 (0.65)	12.0 (0.48)	17.0 (0.67)	33.0 (1.30)	36.5 (1.44)	46.5 (1.84)
Center offset mm (in.)	4.5 (0.18)	N/A	N/A	6.0 (0.24)	N/A	N/A	N/A	N/A
Mass grams	1.6	1.1	1.3	3.7	1.5	9.8	16.5	64.9
Price	\$71	\$108	\$81	\$71	\$130	\$140	\$247	\$86

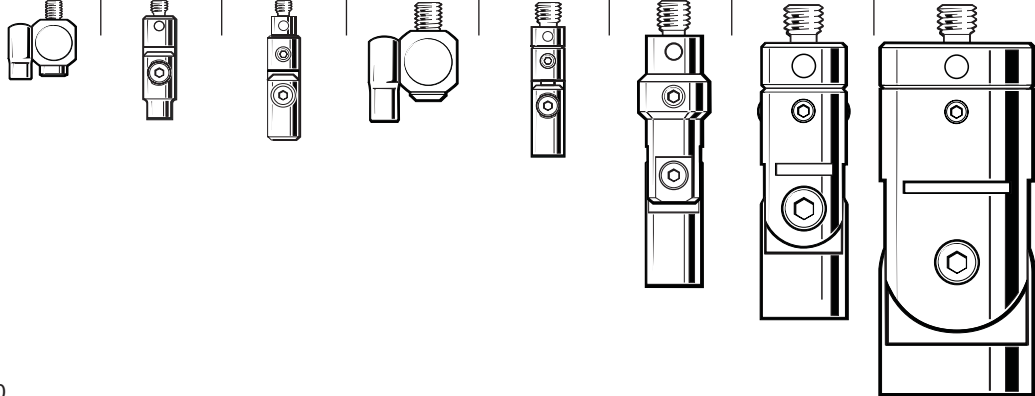

* Not for use with SP80

Stylus centers

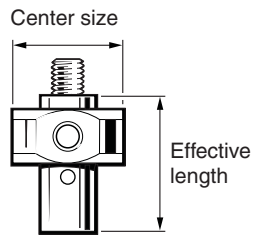



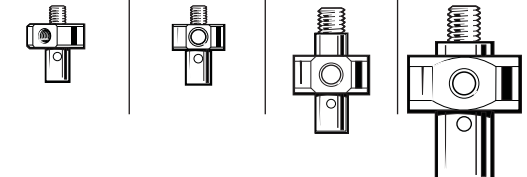





Part number	A-5000-8395 4-way	A-5000-3627 5-way	A-5000-7610 5-way	A-5000-7792 5-way
Thread size	M2	M2	M3	M4
Effective length mm (in.)	7.5 (0.30)	7.5 (0.30)	13.0 (0.52)	18.0 (0.71)
Center size mm (in.)	7.5 (0.30)	7.0 (0.28)	10.0 (0.40)	15.0 (0.60)
Mass grams	1.1	0.8	3.6	12.1
Price	\$64	\$48	\$50	\$60

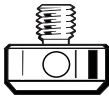
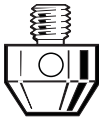
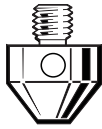

Accessories

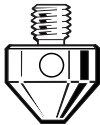
Adaptors

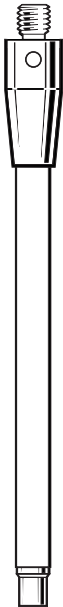
Part number	A-5004-7593 Stainless steel	A-5004-7592 Stainless steel	A-5004-7595 Stainless steel	A-5004-7597 Stainless steel	A-5004-7596 Stainless steel	A-5004-7613 Stainless steel	A-5003-0856 Stainless steel	A-5555-0227 Stainless steel
Male/female thread	M2/M3	M3/M2	M4/M2	M4/M3	M4/M3	M5/M4	M5/M4	M5/M3
Length mm (in.)	7.0 (0.28)	5.0 (0.20)	5.0 (0.20)	9.0 (0.36)	20.0 (0.79)	6.5 (0.26)	9.0 (0.36)	10.0 (0.40)
Mass grams	0.4	0.6	1.5	1.4	3.2	6.0	4.6	5.0
Price	\$12	\$14	\$32	\$32	\$20	\$32	\$29	\$20
								

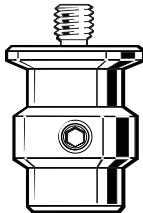
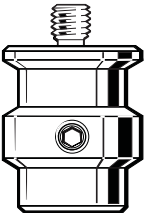
Part number	A-5555-0226 Stainless steel	A-5000-7751 Ceramic	A-5004-7612 Stainless steel	A-5000-7752 Ceramic	A-5000-7753 Ceramic	A-2054-4657 Stainless steel	A-5000-9302 Stainless steel	A-5000-9303 Stainless steel
Male/female thread	M5/M2	M4/M3	TF6/M3	M4/M3	M4/M3	M4/Ø4.5	M5/Ø8.0	M5/Ø10.0
Length mm (in.)	10.0 (0.40)	50.0 (1.97)	18.0 (0.71)	75.0 (2.96)	100.0 (3.94)	10.0 (0.40)	22.0 (0.87)	22.0 (0.87)
Mass grams	5.0	4.4	1.9	5.2	6.3	5.0	18.0	20.0
Price	\$20	\$60	\$35	\$91	\$104	\$34	\$62	\$62
								

Cubes and bolts

Part number	A-5555-0189 Titanium	A-5555-0190 Titanium	A-5555-0194 Titanium	A-5003-5683 Titanium	A-5003-5684 Titanium
Thread size	M5	M5	M5	M5 – M2	M5 – M2
Length mm (in.)	15.0 (0.60)	20.0 (0.79)	20.0 (0.79)	15.0 (0.60)	20.0 (0.79)
Width mm (in.)	15.0 (0.60)	20.0 (0.79)	40.0 (1.58)	15.0 (0.60)	20.0 (0.79)
Mass grams	12.85	32.55	63.50	13.75	35.18
Price	\$50	\$60	\$108	\$86	\$101

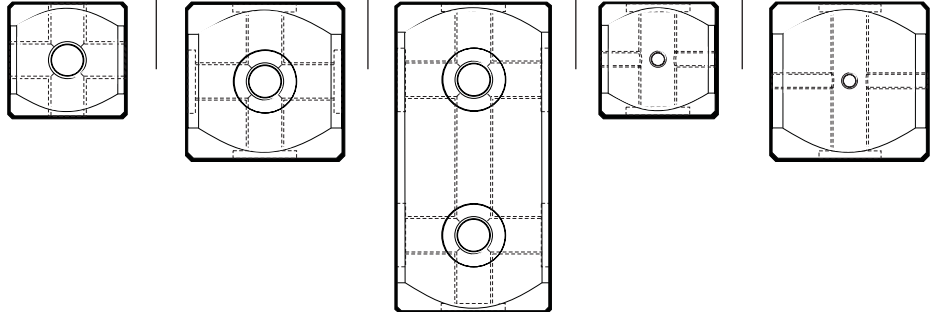

Part number	A-5003-5679 Stainless steel	A-5003-5678 Stainless steel	A-5003-5677 Stainless steel	A-5003-5676 Stainless steel
Thread size	M5 – M2	M5 – M2	M5	M5
Length mm (in.)	28.0 (1.11)	33.0 (1.30)	28.0 (1.11)	33.0 (1.30)
Mass grams	6.7	7.1	6.0	6.4
Price	\$18	\$18	\$18	\$18

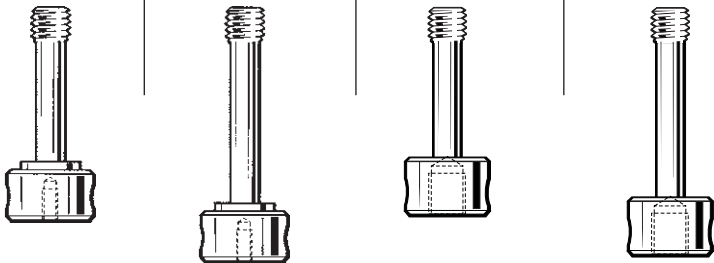

Stylus tools

A-5004-7582
For M2 and M3
threaded styli
Price: \$9

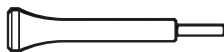

A-5004-7587
For M4
threaded styli
Price: \$12

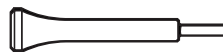

A-5004-7614
For M5
threaded styli
Price: \$15

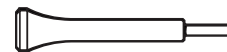

A-5003-2300
For the M2 carbon fiber
range of styli
Price: \$48

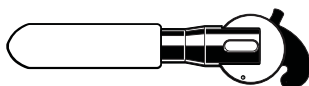

These tools are designed to fit styli to Renishaw probes without causing any internal damage.

Stylus kits

M2 comprehensive stylus kit

A-5000-0001

Price: \$2,808

RENISHAW
apply innovation™

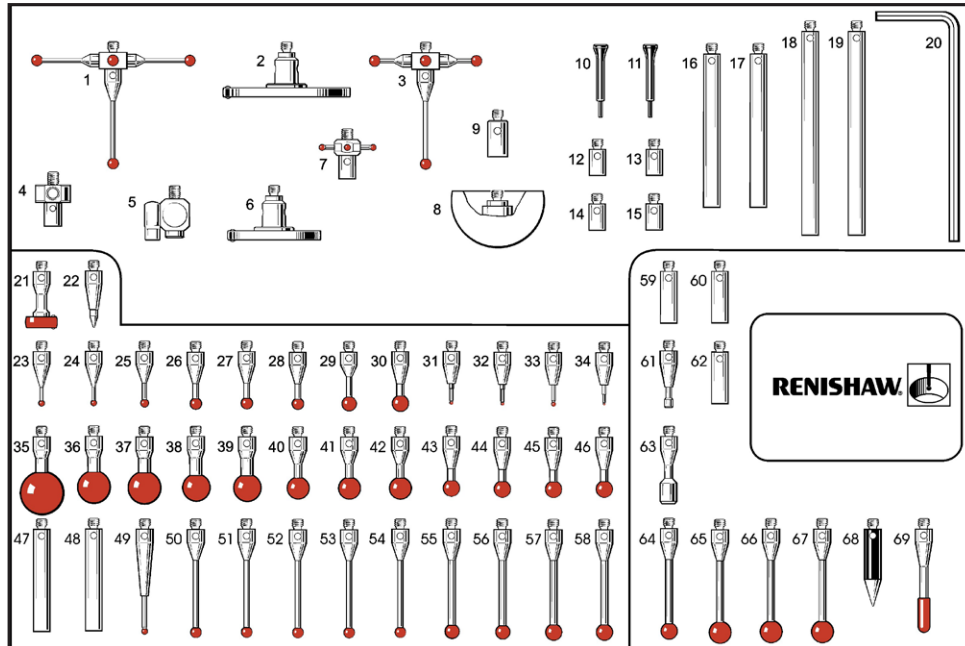

Position	Part number	Description
1	A-5000-3626	M2 STR D2 5BALL L19.2 S30
2	A-5000-7810	M2 DSC D25SLVS T1.5 L8.6 BR-Y2.5
3	A-5000-7629	M2 STR D2 5BALL L19.2 S18
4	A-5000-3627	M2 ACC CENTER 5WAY
5	A-5000-7534	M2 ACC KNUCKLE OFFSET
6	A-5000-7809	M2 DSC D18SLVS T1.5 L8.6 BR-Y2.5
7	A-5000-7811	M2 STR D1 4BALL L7.5T S10
8	A-5000-3614	M2 HEM D18CE
9	A-5004-7593	M2-M3 EXT L7SS
10-11	A-5004-7582	M2-M3 STYLUS TOOL
12-15	A-5004-7610	M2 EXT L5 D3SS
16-17	A-5004-7591	M2 EXT L30 D3SS
18-19	A-5004-7611	M2 EXT L40 D3SS
20	P-TL01-0150	S3 HEX WRENCH 1.5 MM A/F
21	A-5000-3611	M2 DSC D6R T1.2 L10 BR-Y2
22	A-5000-7813	M2 PNT D1.4TC 30DEG L10
23-24	A-5000-7806	M2 STY D1R L10 EWL4.5 D0.7SS
25	A-5000-7802	M2 STY D1.5R L10 EWL4.5 D0.7SS
26-28	A-5000-7807	M2 STY D2R L10 EWL6 D1SS
29	A-5000-7803	M2 STY D2.5R L10 EWL6 D1SS
30	A-5000-3604	M2 STY D3R L10 EWL7.5 D1.5SS
31-32	A-5000-7805	M2 STY D0.5R L10 EWL3 D0.4TC
33	A-5000-7801	M2 STY D0.7R L10 EWL4 D0.5TC
34	A-5000-7800	M2 STY D0.3R L10 EWL2 D0.2TC
35	A-5000-4158	M2 STY D8R L11 EWL11 D2.5SS
36-37	A-5000-4156	M2 STY D6R L10 EWL10 D2.5SS
38-39	A-5000-4155	M2 STY D5R L10 EWL10 D2.5SS
40-42	A-5000-4154	M2 STY D4R L10 EWL10 D1.5SS
43-46	A-5000-3604	M2 STY D3R L10 EWL7.5 D1.5SS
47-48	A-5004-7586	M2 EXT L20 D3SS
49	A-5000-7808	M2 STY D1R L20 EWL7 D0.7TC
50-54	A-5000-3603	M2 STY D2R L20 EWL14 D1.4SS
55-56	A-5000-7804	M2 STY D2.5R L20 EWL16.5 D1.4SS
57-58	A-5000-4160	M2 STY D3R L20 EWL17.5 D1.5SS
59-60	A-5004-7585	M2 EXT L10 D3SS
61	A-5004-7589	M2 CYL D1.5SLVS L11 EWL1.5
62	A-5004-7585	M2 EXT L10 D3SS
63	A-5004-7590	M2 CYL D3SLVS L13 EWL3.8
64	A-5000-4160	M2 STY D3R L20 EWL17.5 D1.5SS
65-67	A-5000-4161	M2 STY D4R L20 EWL20 D1.5SS
68	A-5004-7588	M2 PNT D3SLVS 30DEG L15
69	A-5000-7812	M2 SPH D2R L20 EWL7.2 SS

www.renishaw.com

M2 stylus enhancement kit

A-5000-0002

Price: \$1,032

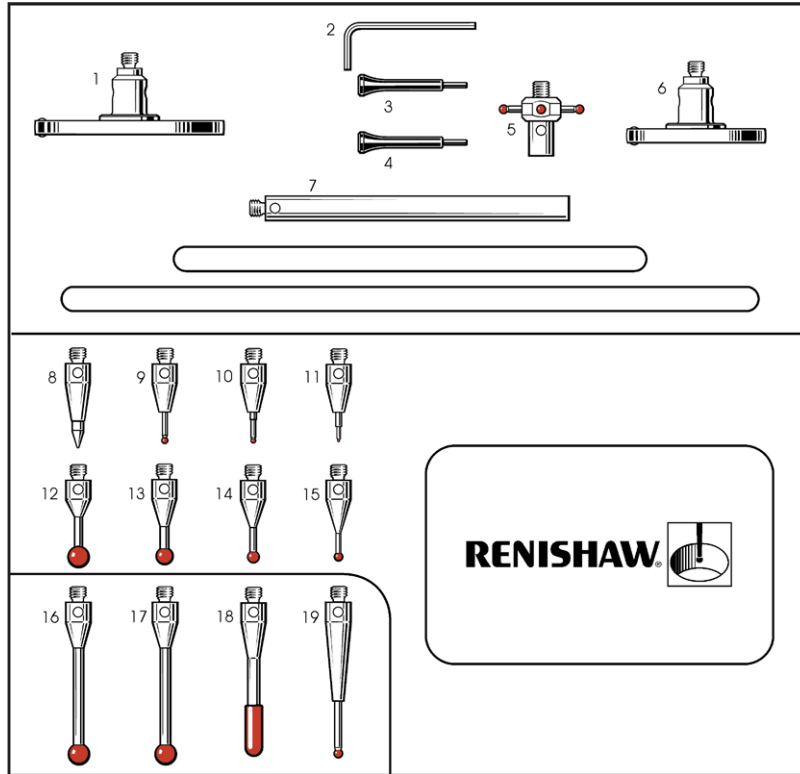

Position	Part number	Description
1	A-5000-7810	M2 DSC D25SLVS T1.5 L8.6 BR-Y2.5
2	P-TL01-0150	S3 HEX WRENCH 1.5 MM A/F
3-4	A-5004-7582	M2-M3 STYLUS TOOL
5	A-5000-7811	M2 STR D1 4BALL L7.5T S10
6	A-5000-7809	M2 DSC D18SLVS T1.5 L8.6 BR-Y2.5
7	A-5004-7611	M2 EXT L40 d3SS
8	A-5000-7813	M2 PNT D1.4TC 30deg L10
9	A-5000-7801	M2 STY D0.7R L10 EWL4 d0.5TC
10	A-5000-7805	M2 STY D0.5R L10 EWL3 d0.4TC
11	A-5000-7800	M2 STY D0.3R L10 EWL2 d0.2TC
12	A-5000-7803	M2 STY D2.5R L10 EWL6 d1SS
13	A-5000-7807	M2 STY D2R L10 EWL6 d1SS
14	A-5000-7802	M2 STY D1.5R L10 EWL4.5 d0.7SS
15	A-5000-7806	M2 STY D1R L10 EWL4.5 d0.7SS
16-17	A-5000-7804	M2 STY D2.5R L20 EWL16.5 d1.4SS
18	A-5000-7812	M2 SPH D2R L20 EWL7.2 SS
19	A-5000-7808	M2 STY D1R L20 EWL7 d0.7TC

Stylus kits

M2 high performance kit

A-5003-2310

Price: \$710

RENISHAW
apply innovation™

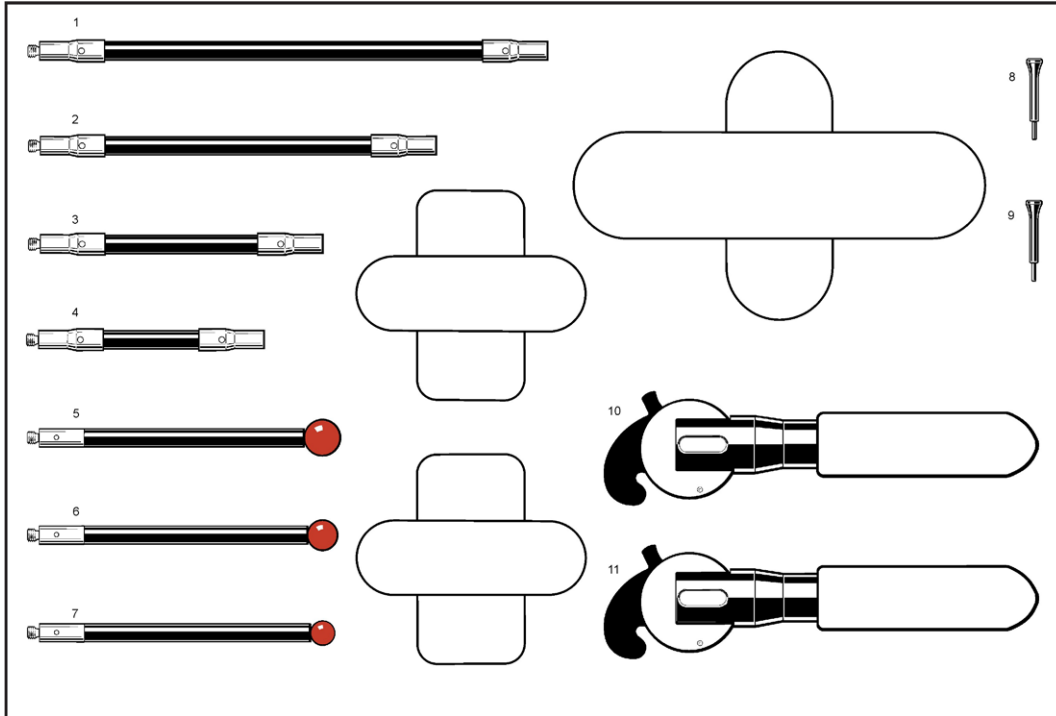

Position	Part number	Description
1	A-5003-2283	M2 EXT L90 d3CF
2	A-5003-2282	M2 EXT L70 d3CF
3	A-5003-2281	M2 EXT L50 d3CF
4	A-5003-2280	M2 EXT L40 d3CF
5	A-5003-2287	M2 STY D6R L50 EWL50 d3CF
6	A-5003-2286	M2 STY D5R L50 EWL50 d3CF
7	A-5003-2285	M2 STY D4R L50 EWL50 d3CF
8-9	A-5004-7582	M2-M3 STYLUS TOOL
10-11	A-5003-2300	M2 STYLUS TOOL CF RANGE

Stylus kit 201 for M2 probes

Price: \$630

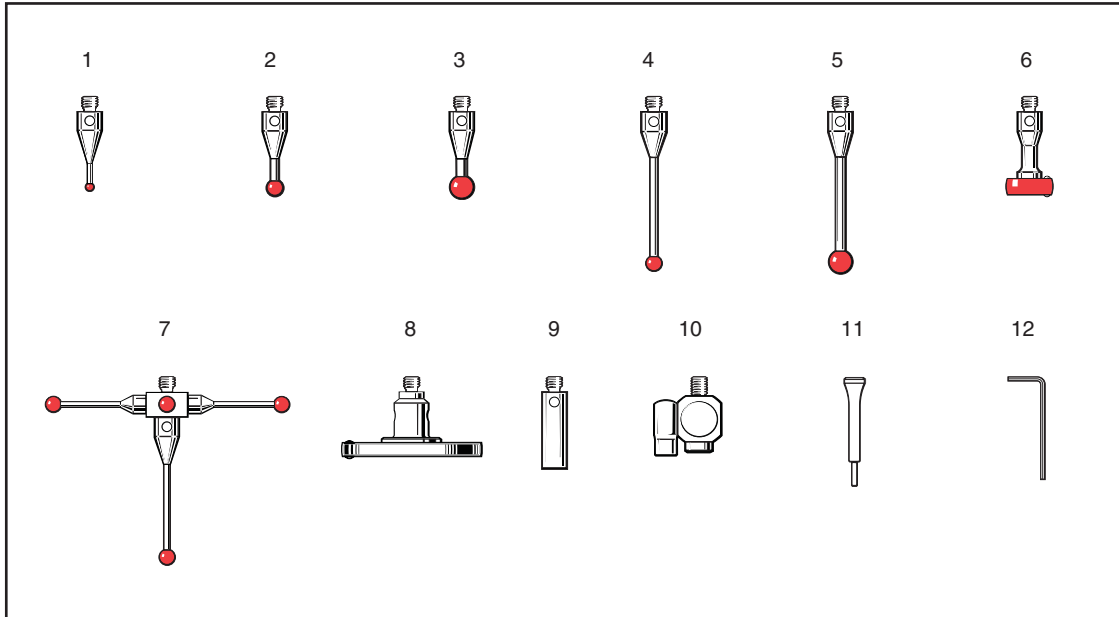

Position	Part number	Quantity	Description
1	A-5000-7806	1	M2 STY D1R L10 EWL4.5 d0.7SS
2	A-5000-7807	1	M2 STY D2R L10 EWL6 d1SS
3	A-5000-3604	1	M2 STY D3R L10 EWL7.5 d1.5SS
4	A-5000-3603	1	M2 STY D2R L20 EWL14 d1.4SS
5	A-5000-4160	1	M2 STY D3R L20 EWL17.5 d1.5SS
6	A-5000-3611	1	M2 DSC D6R T1.2 L10 BR-Y2
7	A-5000-3626	1	M2 STR D2 5BALL L19.2 S30
8	A-5000-7809	1	M2 DSC D18SLVS T1.5 L8.6 BR-Y2.5
9	A-5004-7585	2	M2 EXT L10 d3SS
10	A-5000-7534	1	M2 ACC KNUCKLE OFFSET
11	A-5004-7582	2	M2-M3 STYLUS TOOL
12	P-TL01-0150	1	S3 HEX WRENCH 1.5 MM A/F
13	M-5000-3541	1	S8 TP2 SPANNER (not pictured)
14	A-1015-7658	1	TP2 & STYLI BOX (not pictured)

Stylus kits

Stylus kit 204 for M2 probes

Price: \$1,290

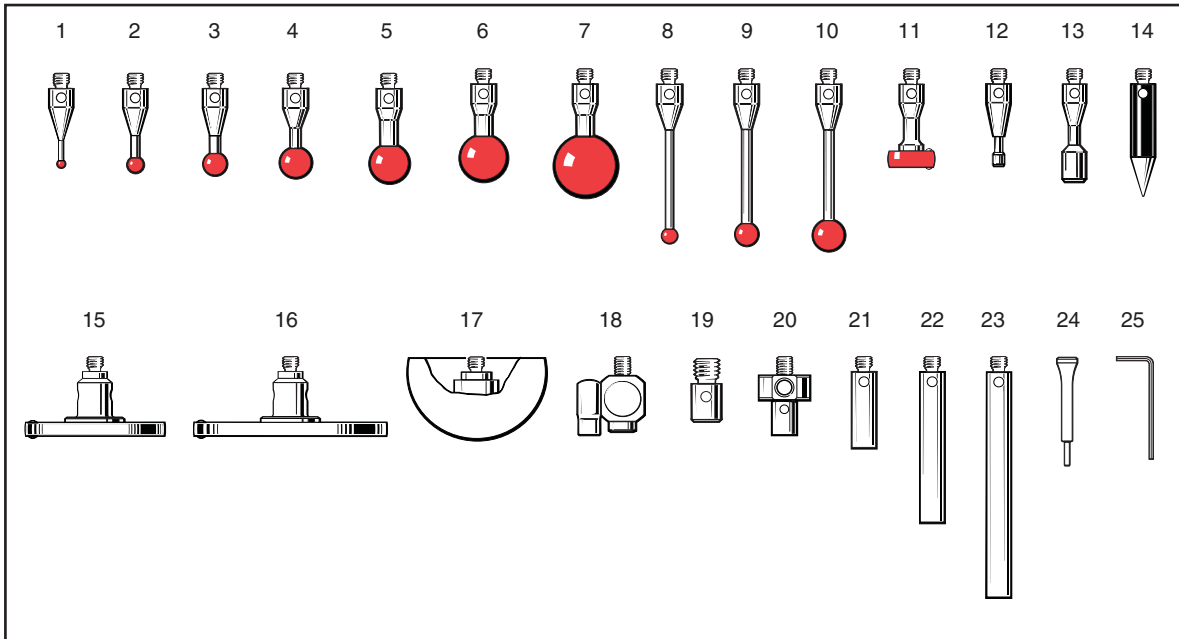

Position	Part number	Quantity	Description
1	A-5000-7806	1	M2 STY D1R L10 EWL4.5 d0.7SS
2	A-5000-7807	1	M2 STY D2R L10 EWL6 d1SS
3	A-5000-3604	1	M2 STY D3R L10 EWL7.5 d1.5SS
4	A-5000-4154	1	M2 STY D4R L10 EWL10 d1.5SS
5	A-5000-4155	1	M2 STY D5R L10 EWL10 d2.5SS
6	A-5000-4156	1	M2 STY D6R L10 EWL10 d2.5SS
7	A-5000-4158	1	M2 STY D8R L11 EWL11 d2.5SS
8	A-5000-3603	1	M2 STY D2R L20 EWL14 d1.4SS
9	A-5000-4160	1	M2 STY D3R L20 EWL17.5 d1.5SS
10	A-5000-4161	1	M2 STY D4R L20 EWL20 d1.5SS
11	A-5000-3611	1	M2 DSC D6R T1.2 L10 BR-Y2
12	A-5004-7589	1	M2 CYL D1.5SLVS L11 EWL1.5
13	A-5004-7590	1	M2 CYL D3SLVS L13 EWL3.8
14	A-5004-7588	1	M2 PNT D3SLVS 30deg L15
15	A-5000-7809	1	M2 DSC D18SLVS T1.5 L8.6 BR-Y2.5
16	A-5000-7810	1	M2 DSC D25SLVS T1.5 L8.6 BR-Y2.5
17	A-5000-3614	1	M2 HEM D18CE
18	A-5000-7534	1	M2 ACC KNUCKLE OFFSET
19	A-5004-7592	1	M3-M2 EXT L5SS
20	A-5000-3627	1	M2 ACC Center 5WAY
21	A-5004-7585	2	M2 EXT L10 d3SS
22	A-5004-7586	2	M2 EXT L20 d3SS
23	A-5004-7591	2	M2 EXT L30 d3SS
24	A-5004-7582	2	M2-M3 STYLUS TOOL
25	P-TL01-0150	1	S3 HEX WRENCH 1.5 MM A/F
26	M-5000-3541	1	S8 TP2 SPANNER (not pictured)
27	A-1015-7749	1	COMP BOX ASSEMBLY (not pictured)

Stylus kit 206 for M2 probes

Price: \$1,972

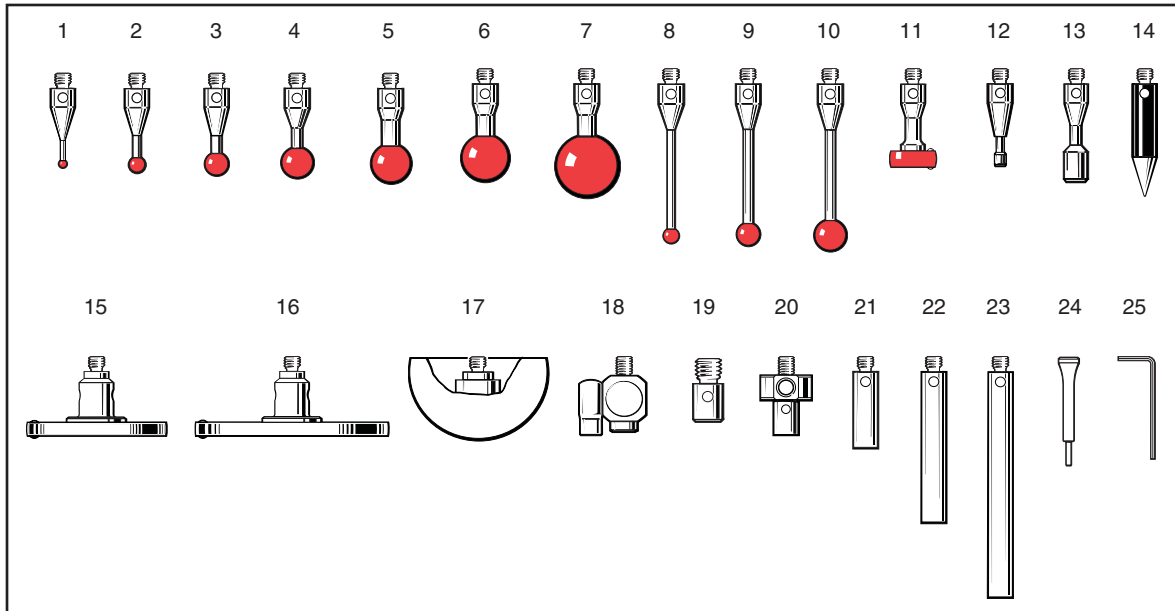

Position	Part number	Quantity	Description
1	A-5000-7806	5	M2 STY D1R L10 EWL4.5 d0.7SS
2	A-5000-7807	3	M2 STY D2R L10 EWL6 d1SS
3	A-5000-3604	5	M2 STY D3R L10 EWL7.5 d1.5SS
4	A-5000-4154	3	M2 STY D4R L10 EWL10 d1.5SS
5	A-5000-4155	2	M2 STY D5R L10 EWL10 d2.5SS
6	A-5000-4156	2	M2 STY D6R L10 EWL10 d2.5SS
7	A-5000-4158	1	M2 STY D8R L11 EWL11 d2.5SS
8	A-5000-3603	5	M2 STY D2R L20 EWL14 d1.4SS
9	A-5000-4160	3	M2 STY D3R L20 EWL17.5 d1.5SS
10	A-5000-4161	3	M2 STY D4R L20 EWL20 d1.5SS
11	A-5000-3611	1	M2 DSC D6R T1.2 L10 BR-Y2
12	A-5004-7589	1	M2 CYL D1.5SLVS L11 EWL1.5
13	A-5004-7590	1	M2 CYL D3SLVS L13 EWL3.8
14	A-5004-7588	1	M2 PNT D3SLVS 30deg L15
15	A-5000-7809	1	M2 DSC D18SLVS T1.5 L8.6 BR-Y2.5
16	A-5000-7810	1	M2 DSC D25SLVS T1.5 L8.6 BR-Y2.5
17	A-5000-3614	1	M2 HEM D18CE
18	A-5000-7534	1	M2 ACC KNUCKLE OFFSET
19	A-5004-7592	1	M3-M2 EXT L5SS
20	A-5000-3627	3	M2 ACC Center 5WAY
21	A-5004-7585	3	M2 EXT L10 d3SS
22	A-5004-7586	2	M2 EXT L20 d3SS
23	A-5004-7591	2	M2 EXT L30 d3SS
24	A-5004-7582	2	M2-M3 STYLUS TOOL
25	P-TL01-0150	1	S3 HEX WRENCH 1.5 MM A/F
26	M-5000-3541	1	S8 TP2 SPANNER (not pictured)
27	A-1015-7749	1	COMP BOX ASSEMBLY (not pictured)

Stylus kits

A-5003-6151 M3 stylus kit for SP25M/SM25-1/SH25-1

Price: \$435

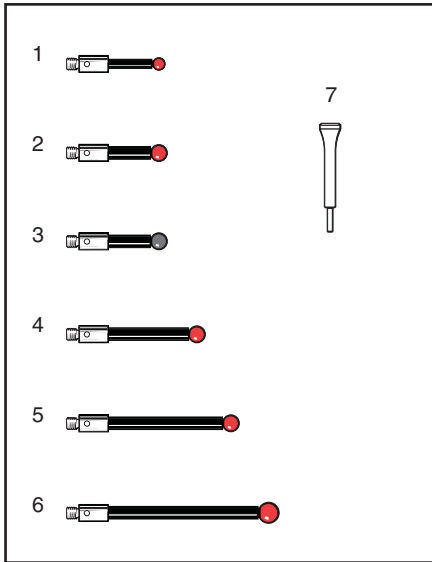

Position	Part number	Description
1	A-5003-5970	M3 STY D3R L21 EWL13.5 d2CF
2	A-5003-5971	M3 STY D4R L21 EWL13.5 d3CF
3	A-5003-5977	M3 STY D4SIN L21 EWL13.5 d3CF
4	A-5003-5972	M3 STY D4R L31 EWL23.5 d3CF
5	A-5003-5973	M3 STY D4R L40 EWL32.5 d3CF
6	A-5003-5974	M3 STY D5R L50 EWL42.5 d3CF
7	A-5004-7582	M2-M3 STYLUS TOOL

www.renishaw.com

A-5003-6152 M3 stylus kit for SP25M/SM25-2/SH25-2

Price: \$455

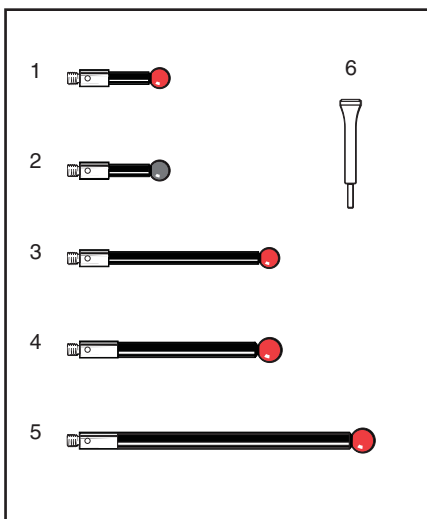

Position	Part number	Description
1	A-5003-5975	M3 STY D5R L21 EWL13.5 d3CF
2	A-5003-5978	M3 STY D5SIN L21 EWL13.5 d3CF
3	A-5003-5974	M3 STY D5F L50 EWL42.5 d3CF
4	A-5003-5976	M3 STY D6R L50 EWL50 d4CF
5	A-5003-4860	M3 STY D6R L75 EWL75 d4CF
6	A-5004-7582	M2-M3 STYLUS TOOL

www.renishaw.com

A-5003-6153 M3 stylus kit for SP25M/SM25-3/SH25-3

Price: \$515

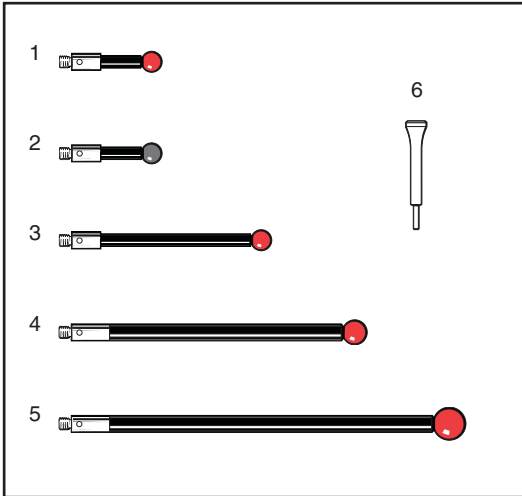

Position	Part number	Description
1	A-5003-5975	M3 STY D5R L21 EWL13.5 d3C/F
2	A-5003-5978	M3 STY D5SIN L21 EWL13.5 d3C/F
3	A-5003-5974	M3 STY D5R L50 EWL42.5 d3C/F
4	A-5003-4860	M3 STY D6R L75 EWL75 d4C/F
5	A-5003-4863	M3 STY D8R L100 EWL100 d4C/F
6	A-5004-7582	M2-M3 STYLUS TOOL

www.renishaw.com

Stylus kits

A-5003-8124 M3 stylus kit for SP25M/SM25-4/SH25-4

Price: \$1,200

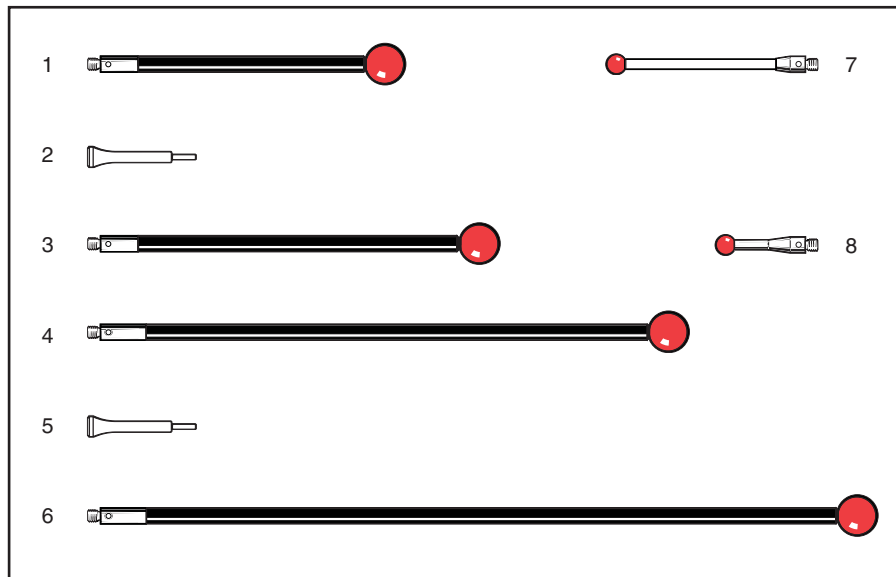

Position	Part number	Description
1	A-5003-7057	M3 STY D10R L25 EWL75 d4C/F
2	A-5004-7582	M2-M3 STYLUS TOOL
3	A-5003-7056	M3 STY D10R L100 EWL100 d4C/F
4	A-5003-7055	M3 STY D10R L150 EWL150 d4C/F
5	A-5004-7582	M2-M3 STYLUS TOOL
6	A-5003-7054	M3 STY D10R L200 EWL200 d4C/F
7	A-5003-0069	M3 STY D5R L50 EWL50 d2.5CER
8	A-5000-7630	M3 STY D5R L21 EWL21 d2.5SS

www.renishaw.com

Stylus kit 101 for M3 probes

Price: \$805

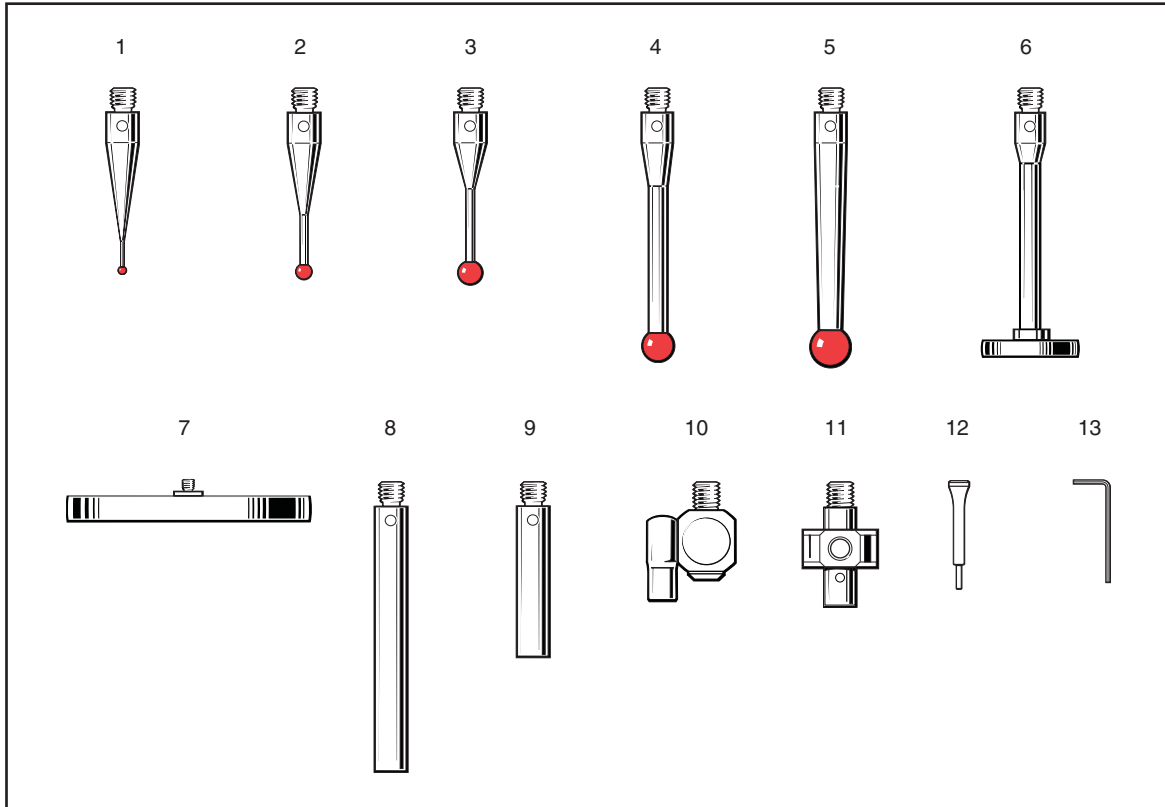

Position	Part number	Quantity	Description
1	A-5000-3551	1	M3 STY D1R L21 EWL4 d0.6SS
2	A-5000-3552	1	M3 STY D2R L21 EWL8 d1.4SS
3	A-5000-3553	1	M3 STY D3R L21 EWL12 d1.5SS
4	A-5000-3554	5	M3 STY D4R L31 EWL27 d2.5SS
5	A-5000-7648	1	M3 STY D5R L31 EWL31 d3.5SS
6	A-5000-3615	1	M3 DSC D12.7SLVS T2 L30.8 BR-N
7	A-5000-7669	1	M3 DSC D63.5CS T6 L4 BR-N
8	A-5004-7584	1	M3 EXT L35 d4SS
9	A-5004-7583	1	M3 EXT L20 d4SS
10	A-5000-7616	1	M3 ACC KNUCKLE OFFSET
11	A-5000-7610	1	M3 ACC Center 5WAY
12	A-5004-7582	2	M2-M3 STYLUS TOOL
13	P-TL01-0150	1	S3 HEX WRENCH 1.5 MM A/F
14	A-1041-7569	1	SA7 ADAPTOR (not pictured)
15	M-5000-3571	2	STYLUS SHANK ADAPTOR (not pictured)
16	A-1015-7650	1	TP1 STYLI BOX (not pictured)

Stylus kits

Stylus kit 102 for M3 probes



Price: \$1,209

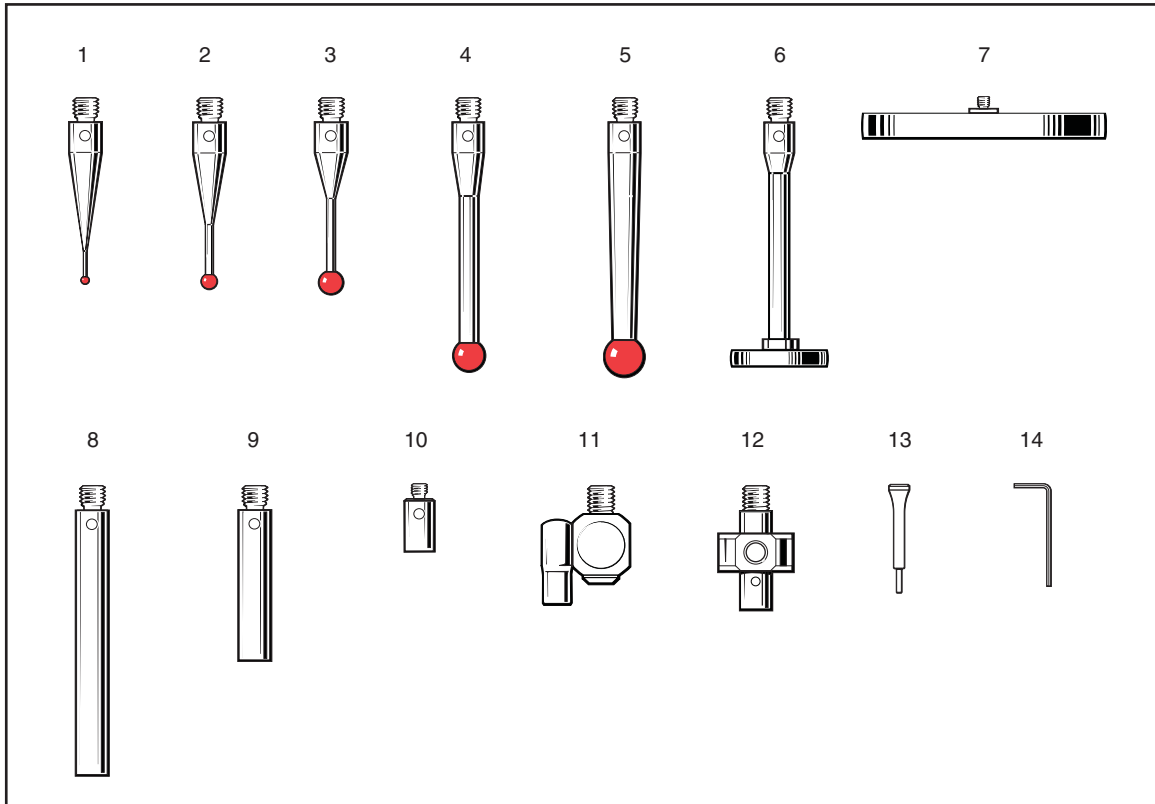

Position	Part number	Quantity	Description
1	A-5000-3551	3	M3 STY D1R L21 EWL4 d0.6SS
2	A-5000-3552	5	M3 STY D2R L21 EWL8 d1.4SS
3	A-5000-3553	3	M3 STY D3R L21 EWL12 d1.5SS
4	A-5000-3554	7	M3 STY D4R L31 EWL27 d2.5SS
5	A-5000-7648	1	M3 STY D5R L31 EWL31 d3.5SS
6	A-5000-3615	1	M3 DSC D12.7SLVS T2 L30.8 BR-N
7	A-5000-7669	1	M3 DSC D63.5CS T6 L4 BR-N
8	A-5004-7584	2	M3 EXT L35 d4SS
9	A-5004-7583	2	M3 EXT L20 d4SS
10	A-5004-7593	1	M2-M3 EXT L7SS
11	A-5000-7616	1	M3 ACC KNUCKLE OFFSET
12	A-5000-7610	2	M3 ACC Center 5WAY
13	A-5004-7582	2	M2-M3 STYLUS TOOL
14	P-TL01-0150	1	S3 HEX WRENCH 1.5 MM A/F
15	A-1041-7569	1	SA7 ADAPTOR (not pictured)
16	M-5000-3571	2	STYLUS SHANK ADAPTOR (not pictured)
17	A-1015-7650	1	TP1 STYLUS BOX (not pictured)

A-5000-7829 M4 stylus kit (TP7M use)

Price: \$1,614

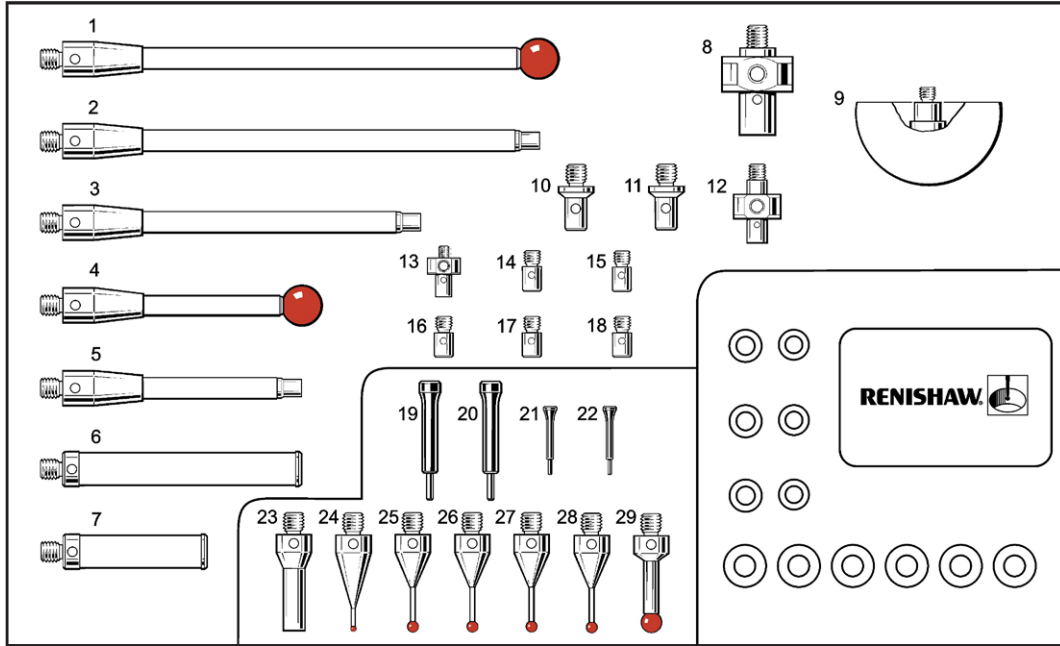

Position	Part number	Description
1	A-5000-7796	M4 STY D8R L100 EWL100 d4.5CE
2	A-5000-7753	M4-M3 EXT L100CE
3	A-5000-7752	M4-M3 EXT L75CE
4	A-5000-7795	M4 STY D8R L50 EWL50 d4.5CE
5	A-5000-7751	M4-M3 EXT L50C
6	A-5000-7755	M4 EXT L50 d7.4CE
7	A-5000-7754	M4 EXT L30 d7.4CE
8	A-5000-7792	M4 ACC Center 5WAY
9	A-5000-7814	M3 HEM D30CE
10-11	A-5004-7597	M4-M3 EXT L9SS
12	A-5000-7610	M3 ACC Center 5WAY
13	A-5000-3627	M2 ACC Center 5WAY
14-18	A-5004-7592	M3-M2 EXT L5SS
19-20	A-5004-7587	M4 STYLUS TOOL
21-22	A-5004-7582	M2-M3 STYLUS TOOL
23	A-5004-7596	M4-M3 EXT L20SS
24	A-5000-7545	M4 STY D1R L19.5 EWL4 d0.7SS
25-28	A-5000-7547	M4 STY D2R L19 EWL8 d1.4SS
29	A-5000-7551	M4 STY D4R L18 EWL13 d3SS

Stylus kits

A-5003-6168 M5 stylus kit SP80

Price: \$900

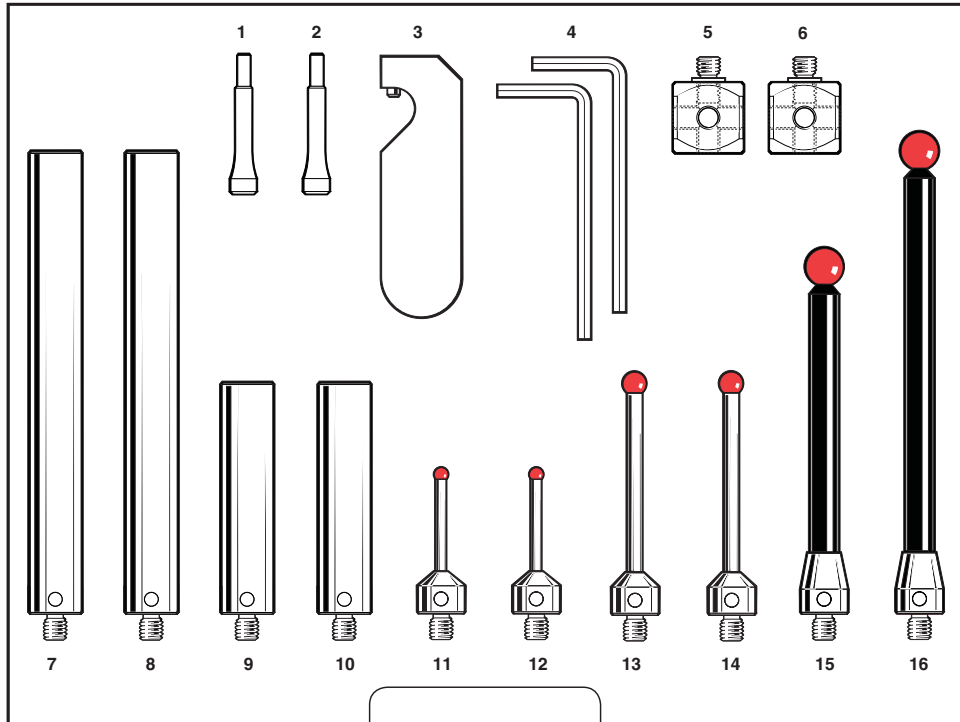

Position	Part number	Description
1-2	A-5004-7614	M5 STYLUS TOOL
3	A-5003-6134	M5 ACC D11 EXTENSION TOOL
4	P-TL01-0250	S3 HEX WRENCH 2.5 MM A/F
5-6	A-5555-0189	M5 ACC 15X15 CUBE
7-8	A-5555-0136	M5 EXT L100 d11SS
9-10	A-5555-0670	M5 EXT L50 d11SS
11-12	A-5003-5218	M5 STY D3R L30 EWL21 d2TC
13-14	A-5003-5236	M5 STY D5R L50 EWL41 d3TC
15	A-5003-5251	M5 STY D8R L75 EWL62 d6CF
16	A-5003-5262	M5 STY D8R L100 EWL87 d6CF

A-5003-5911 M5 stylus kit - standard

Price: \$1,236

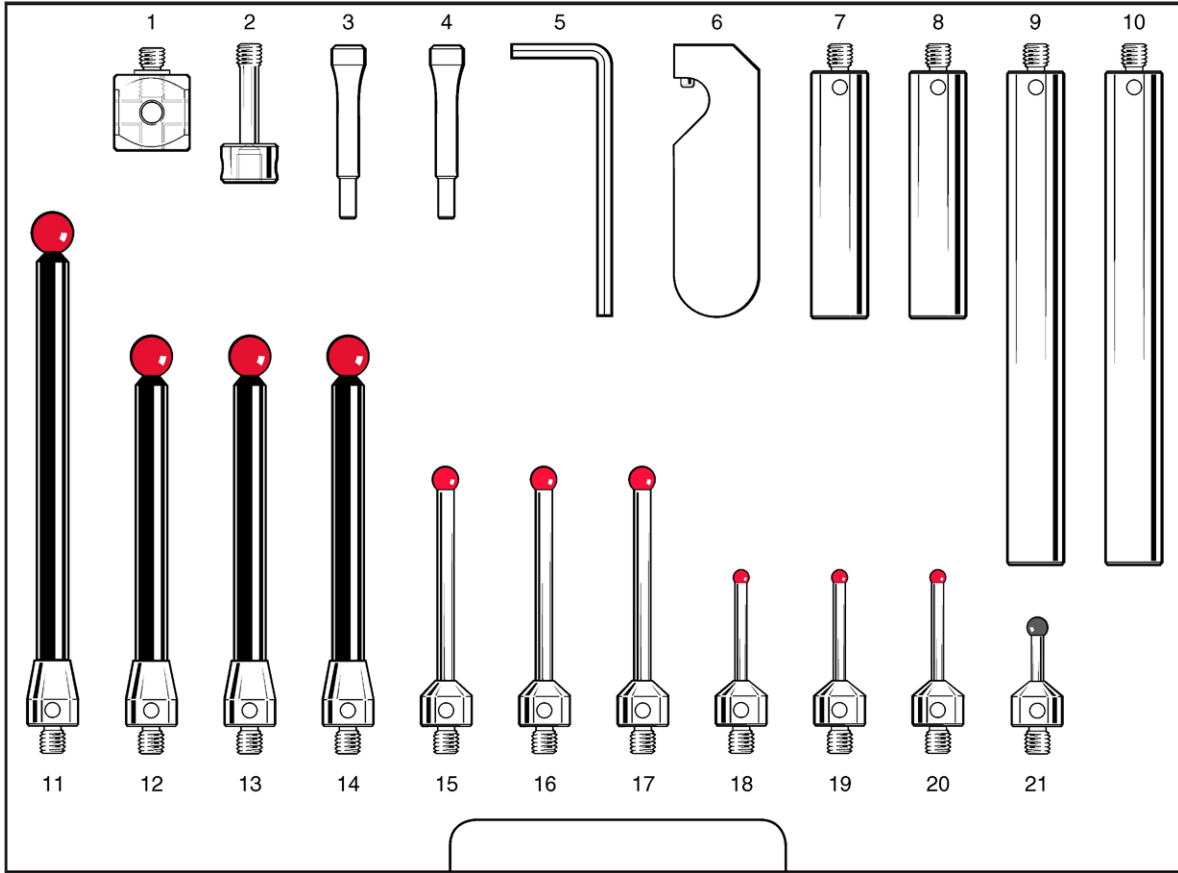

Position	Part number	Description
1	A-5555-0189	M5 ACC 15X15 CUBE
2	A-5003-5677	M5 ACC CUBE BOLT L28
3-4	A-5004-7614	M5 STYLUS TOOL
5	P-TL01-0250	S3 HEX WRENCH 2.5 MM A/F
6	A-5003-6134	M5 ACC D11 EXTENSION TOOL
7-8	A-5555-0670	M5 EXT L50 d11SS
9-10	A-5555-0136	M5 EXT L100 d11SS
11	A-5003-5262	M5 STY D8R L100 EWL87 d6CF
12-14	A-5003-5251	M5 STY D8R L75 EWL62 d6CF
15-17	A-5003-5236	M5 STY D5R L50 EWL41 d3TC
18-20	A-5003-5218	M5 STY D3R L30 EWL21 d2TC
21	A-5003-5733	M5 STY D4SN L20 EWL11 d2TC

Stylus kits

A-5003-5909 M5 stylus kit - comprehensive

Price: \$3,760

RENISHAW
apply innovation™

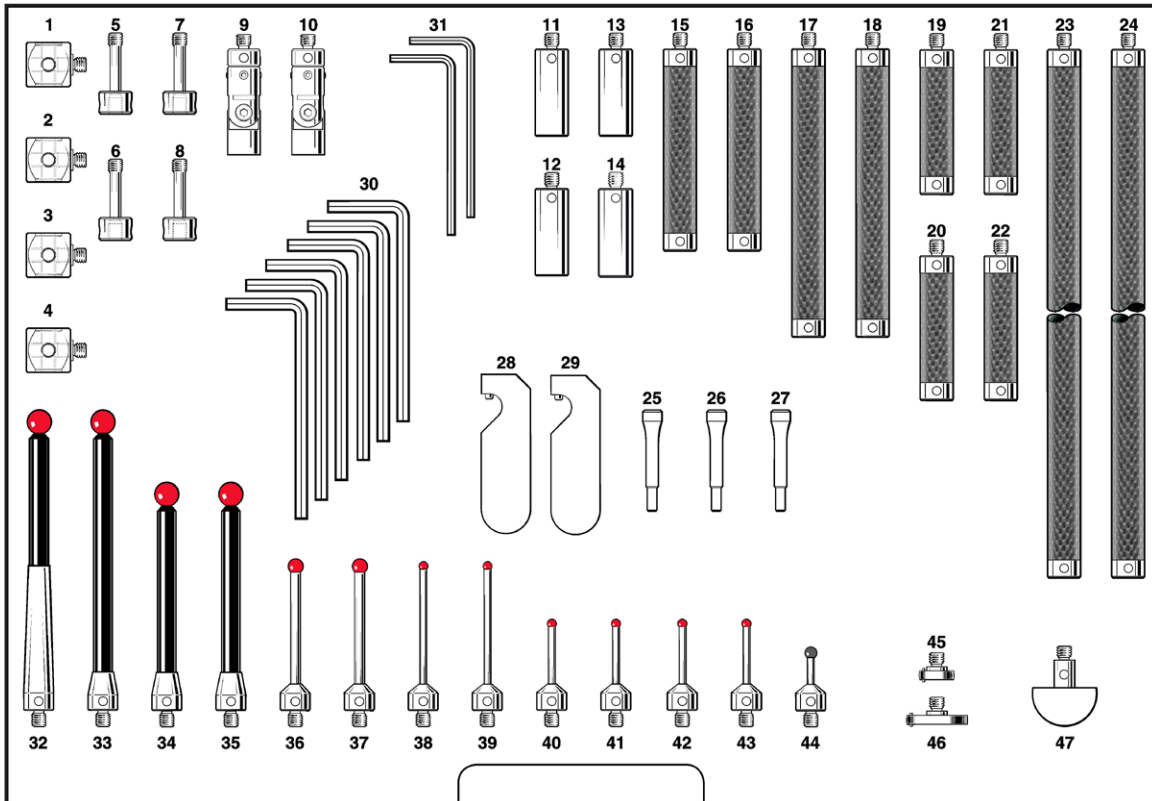

Position	Part number	Description
1-4	A-5555-0189	M5 ACC 15X15 CUBE
5-8	A-5003-5677	M5 ACC CUBE BOLT L28
9-10	A-5003-5278	M5 ACC KNUCKLE d11 ROTARY
11-14	A-5555-0669	M5 EXT L30 d11SS
15-16	A-5555-0623	M5 EXT L70 d11CF
17-18	A-5555-0652	M5 EXT L100 d11CF
19-22	A-5555-0648	M5 EXT L50 d11CF
23-24	A-5555-0654	M5 EXT L200 d11CF
25-27	A-5004-7614	M5 STYLUS TOOL
28-29	A-5003-6134	M5 ACC D11 EXTENSION TOOL
30	P-TL01-0250	S3 HEX WRENCH 2.5 MM A/F
31	P-TL01-0150	S3 HEX WRENCH 1.5 MM A/F
32	A-5003-5261	M5 STY D8R L100 EWL50 d6CF
33	A-5003-5262	M5 STY D8R L100 EWL87 d6CF
34-35	A-5003-5251	M5 STY D8R L75 EWL62 d6CF
36-37	A-5003-5236	M5 STY D5R L50 EWL41 d3TC
38-39	A-5003-5234	M5 STY D3R L50 EWL41 d2TC
40-43	A-5003-5218	M5 STY D3R L30 EWL21 d2TC
44	A-5003-5733	M5 STY D4SN L20 EWL11 d2TC
45	A-5003-5288	M5 DSC D12SLVS T3 L3 BR-Y5
46	A-5003-5289	M5 DSC D21SLVS T3 L3 BR-Y5
47	A-5003-5276	M5 HEM D22CE d7SS

www.renishaw.com

A-5003-5910 M5 stylus kit - general purpose

Price: \$2,575

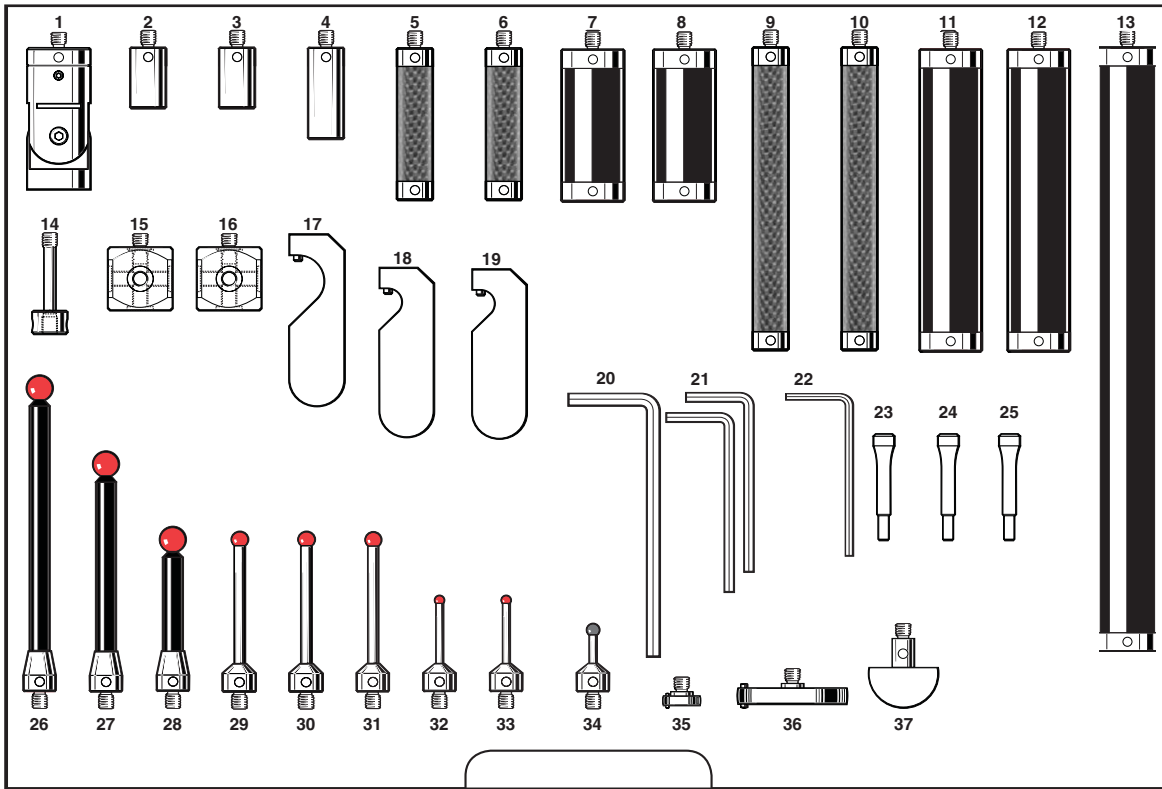

Position	Part number	Description
1	A-5003-5279	M5 ACC KNUCKLE d20 ROTARY
2-3	A-5555-0140	M5 EXT L20 d11SS
4	A-5555-0669	M5 EXT L30 d11SS
5-6	A-5555-0648	M5 EXT L50 d11CF
7-8	A-5555-0671	M5 EXT L50 d20AL
9-10	A-5555-0652	M5 EXT L100 d11CF
11-12	A-5555-0127	M5 EXT L100 d20AL
13	A-5555-0125	M5 EXT L200 d20AL
14	A-5003-5676	M5 ACC CUBE BOLT L33
15-16	A-5555-0190	M5 ACC 20X20 CUBE
17	A-5003-6135	M5 ACC D20 EXTENSION TOOL
18-19	A-5003-6134	M5 ACC D11 EXTENSION TOOL
20	P-TL01-0300	S3 HEX WRENCH 3.0 MM A/F
21	P-TL01-0250	S3 HEX WRENCH 2.5 MM A/F
22	P-TL01-0150	S3 HEX WRENCH 1.5 MM A/F
23-25	A-5004-7614	M5 STYLUS TOOL
26	A-5003-5262	M5 STY D8R L100 EWL87 d6CF
27	A-5003-5251	M5 STY D8R L75 EWL62 d6CF
28	A-5003-5238	M5 STY D8R L50 EWL37 d6CF
29-31	A-5003-5236	M5 STY D5R L50 EWL41 d3TC
32-33	A-5003-5218	M5 STY D3R L30 EWL21 d2TC
34	A-5003-5733	M5 STY D4SN L20 EWL11 d2TC
35	A-5003-5288	M5 DSC D12SLVS T3 L3 BR-Y5
36	A-5003-5290	M5 DSC D35SLVS T5 L4 BR-Y8
37	A-5003-5276	M5 HEM D22CE d7SS

Stylus kits

A-5003-5912 M5 stylus extension kit - 11 mm



Price: \$1,475

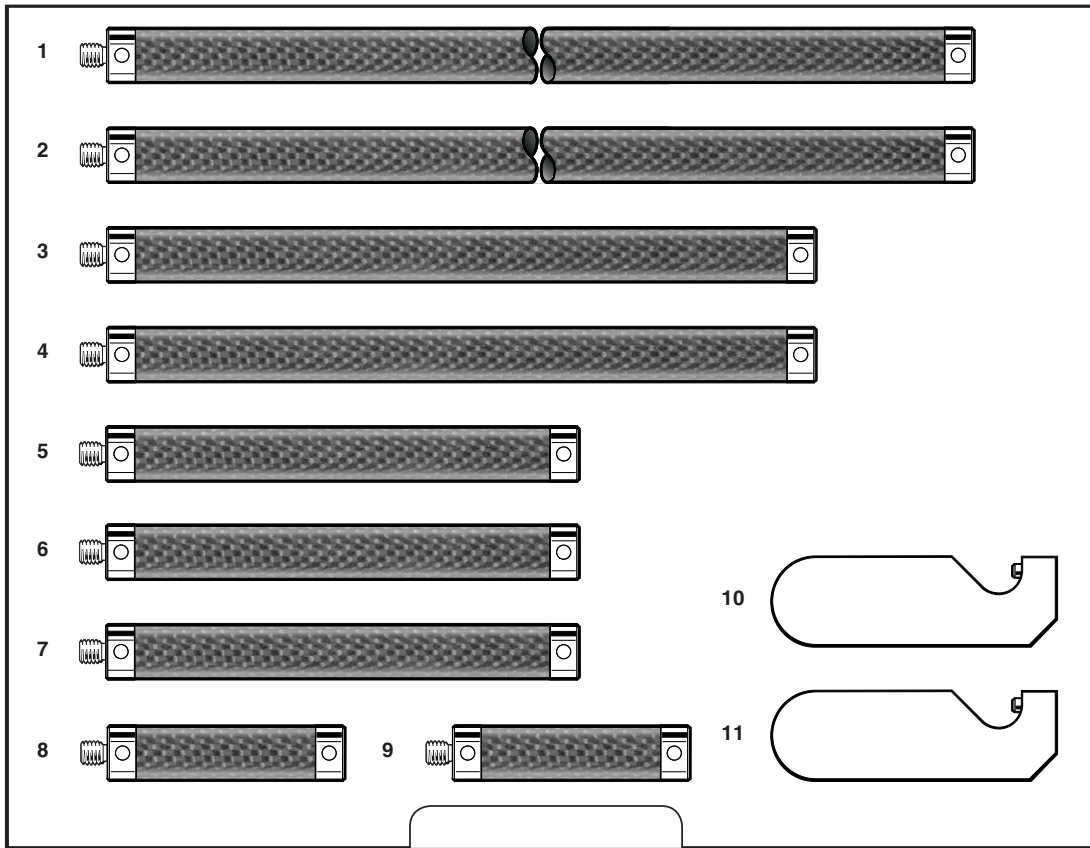

Position	Part number	Description
1-2	A-5555-0654	M5 EXT L200 d11CF
3-4	A-5555-0424	M5 EXT L150 d11CF
5-7	A-5555-0652	M5 EXT L100 d11CF
8-9	A-5555-0648	M5 EXT L50 d11CF
10-11	A-5003-6134	M5 ACC D11 EXTENSION TOOL

A-5003-5913 M5 stylus extension kit - 20 mm

Price: \$2,065

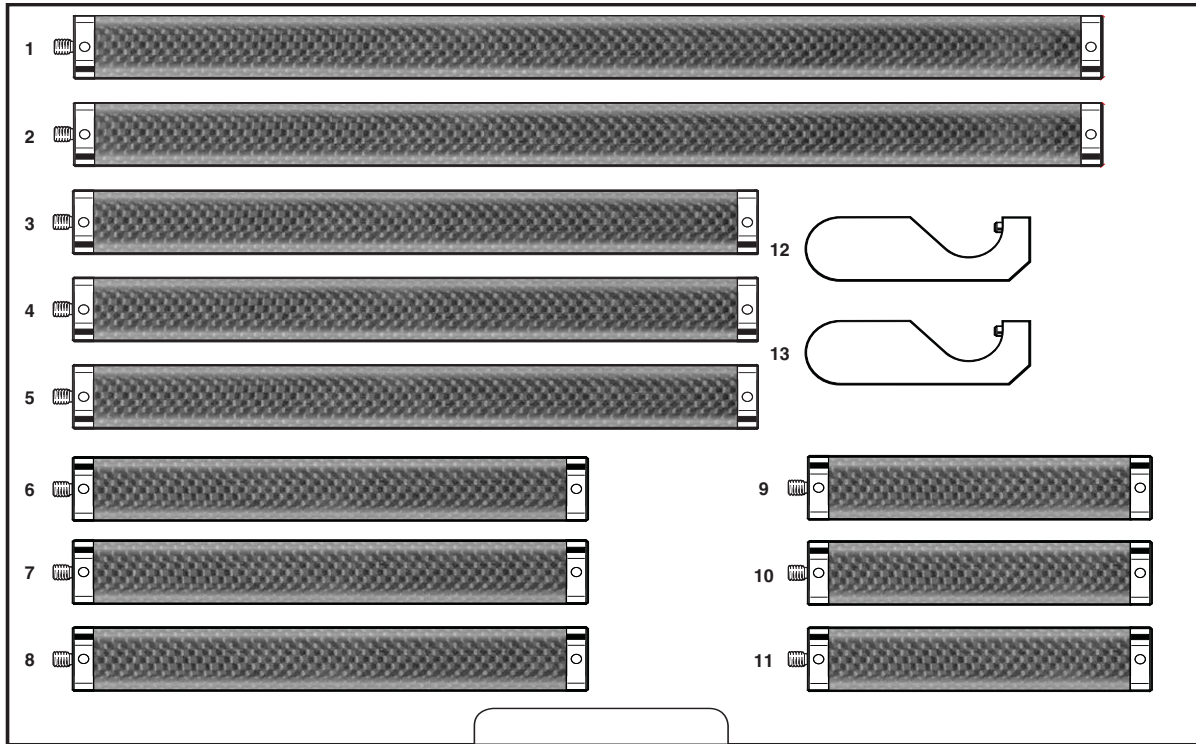

Position	Part number	Description
1-2	A-5555-0664	M5 EXT L300 d20CF
3-5	A-5555-0663	M5 EXT L200 d20CF
6-8	A-5555-0661	M5 EXT L150 d20CF
9-11	A-5555-0659	M5 EXT L100 d20CF
12-13	A-5003-6135	M5 ACC D20 EXTENSION TOOL

Accessories

Datum balls

Datum spheres are made from hard-wearing tungsten carbide and come supplied with individual certificates stating ball diameter and roundness. All sphere measurements are performed on equipment traceable to UK (NPL) standards. Grade 3 sphericity balls are used.

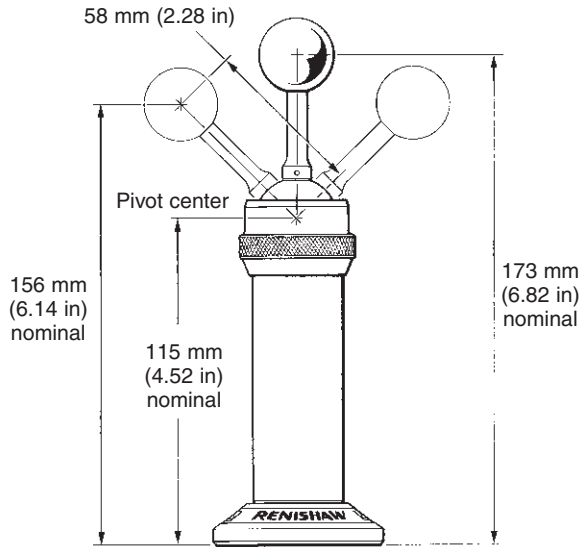

Datum sphere kit	Part number	Price
Ø12 mm datum ball	A-1034-0028	\$545
Ø19 mm datum ball	A-1034-0027	\$545
Ø25 mm datum ball	A-1034-0026	\$545
Ø¾ in datum ball	A-1034-0031	\$545
Ø1 in datum ball	A-1034-0035	\$545

Fixing stud – a fixing stud is required with each kit to attach the pillar to the table surface

Thread size	Part number	Price
M6 x 1	A-1034-0352	\$27
M8 x 1.25	A-1034-0351	\$27
M10 x 1.5	A-1034-0350	\$27
5/16 - 18 x UNC	A-1034-0354	\$27
3/8 - 16 x UNC	A-1034-0353	\$27

Optional extras

Datum ball	Part number	Price
Ø12 mm	A-1034-0005	\$335
Ø19 mm	A-1034-0023	\$335
Ø25 mm	A-1034-0002	\$335
Ø¾ in	A-1034-0032	\$335
Ø1 in	A-1034-0036	\$335

Adaptors/extension	Part number	Price
2 way adaptor	A-1034-0356	\$82
3 way adaptor	A-1034-0357	\$186
Pillar extension 75 mm (2.96 in) long	A-1034-0355	\$82

Gram gage

The gram gage allows the optimum trigger force to be set to maximize probe performance on all standard Renishaw touch trigger probes.

Part number: P-GA01-0001 **Price:** \$374



Overall length	95 mm
Needle length	41 mm
Depth	27 mm
Width	43 mm
Range	4 gram to 35 gram range with 1 gram graduations

Custom stylus fax back form

Fax to: (847) 286 9974

Please fill in your stylus requirements in the space provided and fax back to us. Our design team will carry out a feasibility study and present you with a solution to your application problem.

Thread size	Length	EWL	Ball diameter	Ball material	Stem material	Quantity required

Thread size	Length	EWL	Cylinder diameter	Cylinder material	Quantity required

Thread size	Length	Disk diameter	Disk thickness	Disk material	Disk roller Y or N?	Quantity required

Notes

Probe head: _____ Probing orientation: _____

Application (what are you measuring?) _____

Company name: _____ Date: _____

Address: _____

Telephone: _____

Contact name: _____ Fax: _____

Department: _____ Email: _____

