

**PARLEC**  
Measurably Better  
Your **total** machining solution.

**AHB**  
TOOLING & MACHINERY

COMPLETE  
METALWORKING  
SOLUTIONS

(800) 991-4225  
www.ahbinc.com  
ISO Certified  
customerservice@ahbinc.com

# INTRODUCTORY OFFER

# 30% OFF

## ALL PARLEC SHRINKFIT

OFFER INCLUDES OUR EXPANDED SELECTION  
OF COOLANT-PORTED HEAVY-DUTY HOLDERS.



Our NEW heavy-duty shrinkfit holders deliver the required rigidity and clamping force for heavy chip loads and high metal removal rates.



- Critical dimensions match popular industry standards.
- Coolant supplied directly to the cutting zone drastically improves tool life and chip evacuation.
- Extreme concentricity, 3 Microns.
- Balanced up to 25,000 rpm.

**Offer ends 6/30/2020**



Parlec is a proud member of Techniks Tool Group.  
**CNC TOOLING SOLUTIONS**  
FROM SPINDLE TO WORKPIECE

Connect with Techniks Tool Group



# ShrinkFit Holders

## 2 Extreme Precision Shrinkfit Tools

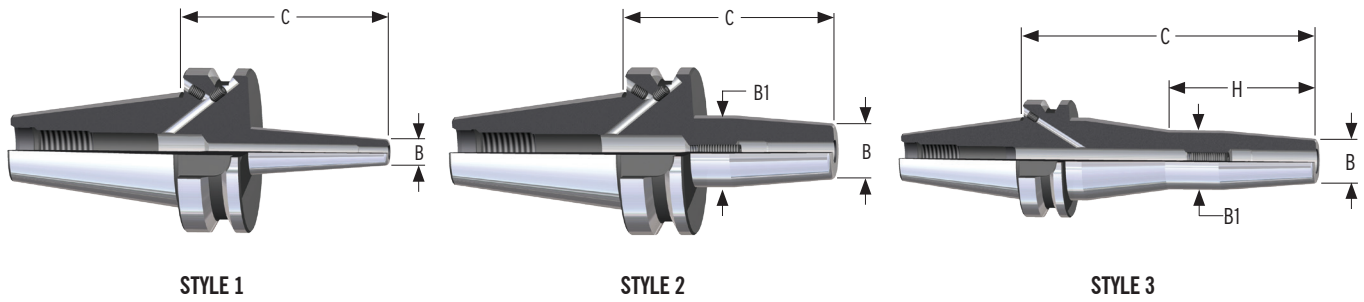

### CAT40 SHRINKFIT | STANDARD | INCH

| Item ID        | Item Description                          | Size   | B     | B1    | C     | Style | List Price | Sale Price      |
|----------------|---|--------|-------|-------|-------|-------|------------|-----------------|
| C40A-01SF315-9 | Shrink-fit 9 Degree Bal AD/B 1/8" x 3.15" | 1/8"   | .39"  | .62"  | 3.15" | 3     | \$280.00   | <b>\$196.00</b> |
| C40A-18SF315-9 | Shrink-fit 9 Degree Bal AD/B 3/16"X3.15"  | 3/16"  | .39"  | .72"  | 3.15" | 3     | \$315.00   | <b>\$220.50</b> |
| C40-18SF315-9  | Shrink-Fit 9 Degree Bal AD/B 3/16"x3.15"  | 3/16"  | 0.39" | 0.72" | 3.15" | 2     | \$267.00   | <b>\$186.90</b> |
| C40-25SF315-9  | Shrink-Fit 9 Degree Bal AD/B 1/4"X 3.15"  | 1/4"   | 0.83" | 1.06" | 3.15" | 2     | \$267.00   | <b>\$186.90</b> |
| C40-25SF630-9  | Shrink-Fit 9 Degree Bal AD/B 1/4"X 6.30"  | 1/4"   | 0.83" | 1.06" | 6.30" | 3     | \$304.00   | <b>\$212.80</b> |
| C40-31SF315-9  | Shrink-Fit 9 Degree Bal AD/B 5/16"x3.15"  | 5/16"  | 0.83" | 1.06" | 3.15" | 2     | \$267.00   | <b>\$186.90</b> |
| C40-31SF630-9  | Shrink-Fit 9 Degree Bal AD/B, 5/16x6.3"   | 5/16"  | 0.83" | 1.06" | 6.30" | 3     | \$304.00   | <b>\$212.80</b> |
| C40-38SF315-9  | Shrink-Fit 9 Degree Bal AD/B 3/8"X 3.15"  | 3/8"   | 0.94" | 1.26" | 3.15" | 2     | \$267.00   | <b>\$186.90</b> |
| C40-38SF630-9  | Shrink-Fit 9 Degree Bal AD/B 3/8"X 6.30"  | 3/8"   | 0.94" | 1.26" | 6.30" | 3     | \$304.00   | <b>\$212.80</b> |
| C40-50SF315-9  | Shrink-Fit 9 Degree Bal AD/B 1/2"X 3.15"  | 1/2"   | 0.94" | 1.26" | 3.15" | 2     | \$267.00   | <b>\$186.90</b> |
| C40-50SF630-9  | Shrink-Fit 9 Degree Bal AD/B 1/2"X 6.30"  | 1/2"   | 0.94" | 1.26" | 6.30" | 3     | \$304.00   | <b>\$212.80</b> |
| C40-62SF315-9  | Shrink-Fit 9 Degree Bal AD/B 5/8"X 3.15"  | 5/8"   | 1.06" | 1.34" | 3.15" | 2     | \$267.00   | <b>\$186.90</b> |
| C40-62SF630-9  | Shrink-Fit 9 Degree Bal AD/B 5/8"X 6.30"  | 5/8"   | 1.06" | 1.34" | 6.30" | 3     | \$304.00   | <b>\$212.80</b> |
| C40-75SF315-9  | Shrink-Fit 9 Degree Bal AD/B 3/4"X 3.15"  | 3/4"   | 1.3"  | 1.65" | 3.15" | 2     | \$267.00   | <b>\$186.90</b> |
| C40F-75SF315-9 | Shrk Fit Bal, AD/B, 3/4" x 3.15", Simul   | 3/4"   | 1.3"  | 1.65" | 3.15" | 2     | \$326.00   | <b>\$228.20</b> |
| C40-75SF630-9  | Shrink-Fit 9 Degree Bal AD/B 3/4"X 6.30"  | 3/4"   | 1.3"  | 1.65" | 6.30" | 2     | \$304.00   | <b>\$212.80</b> |
| C40-10SF394-9  | Shrink-Fit 9 Degree Bal AD/B 1"X 3.94"    | 1"     | 1.73" | 2.09" | 3.94" | 2     | \$267.00   | <b>\$186.90</b> |
| C40F-10SF394-9 | Shrk Fit Bal, AD/B 1" x 3.94", Simul      | 1"     | 1.3"  | 1.65" | 3.94" | 2     | \$348.00   | <b>\$243.60</b> |
| C40-10SF630-9  | Shrink-Fit 9 Degree Bal AD/B 1"X 6.30"    | 1"     | 1.73" | 2.09" | 6.30" | 2     | \$304.00   | <b>\$212.80</b> |
| C40-12SF394-9  | Shrink-Fit 9 Degree Bal AD/B 1-1/4x3.94   | 1-1/4" | 1.73" | 2.09" | 3.94" | 2     | \$267.00   | <b>\$186.90</b> |

### CAT40 SHRINKFIT | STANDARD | METRIC

| Item ID        | Item Description                        | Size  | B     | B1    | C      | Style | List Price | Sale Price      |
|----------------|---|-------|-------|-------|--------|-------|------------|-----------------|
| C40-M06SF80-9  | Shrink-Fit 9 Degree Bal AD/B 6 X 80mm   | 6 mm  | 21 mm | 27 mm | 80 mm  | 2     | \$270.00   | <b>\$189.00</b> |
| C40-M08SF80-9  | Shrink-Fit 9 Degree Bal AD/B 8 X 80mm   | 8 mm  | 21 mm | 27 mm | 80 mm  | 2     | \$270.00   | <b>\$189.00</b> |
| C40-M10SF80-9  | Shrink-Fit 9 Degree Bal AD/B 10 X 80mm  | 10 mm | 24 mm | 32 mm | 80 mm  | 2     | \$270.00   | <b>\$189.00</b> |
| C40-M12SF80-9  | Shrink-Fit 9 Degree Bal AD/B 12 X 80mm  | 12 mm | 24 mm | 32 mm | 80 mm  | 2     | \$270.00   | <b>\$189.00</b> |
| C40-M16SF80-9  | Shrink-Fit 9 Degree Bal AD/B 16 X 80mm  | 16 mm | 27 mm | 34 mm | 80 mm  | 2     | \$270.00   | <b>\$189.00</b> |
| C40-M20SF80-9  | Shrink-Fit 9 Degree Bal AD/B 20 X 80mm  | 20 mm | 33 mm | 42 mm | 80 mm  | 2     | \$270.00   | <b>\$189.00</b> |
| C40-M25SF100-9 | Shrink-Fit 9 Degree Bal AD/B 25 X 100mm | 25 mm | 44 mm | 53 mm | 100 mm | 2     | \$270.00   | <b>\$189.00</b> |
| C40-M32SF100-9 | Shrink-Fit 9 Degree Bal AD/B 32 X 100mm | 32 mm | 44 mm | 53 mm | 100 mm | 2     | \$241.00   | <b>\$168.70</b> |

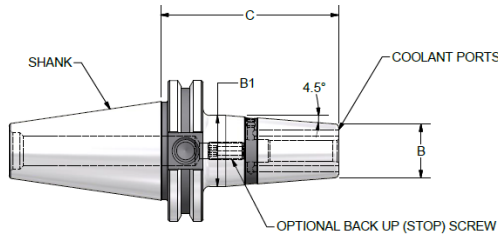

Style 1

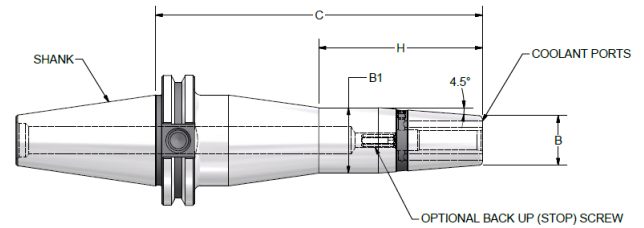

Style 2

### CAT40 SHRINKFIT | COOLANT PORTED | INCH

| Item ID         | Item Description                         | Size   | B     | B1    | C     | Style | List Price | Sale Price      |
|-----------------|--|--------|-------|-------|-------|-------|------------|-----------------|
| C40A-25SF315-9C | Shrink-fit 9° Bal Cool Prt 1/4 x 3.15"   | 1/4"   | .83"  | 1.06" | 3.15" | 1     | \$250.00   | <b>\$175.00</b> |
| C40A-25SF512-9C | Shrink-fit 9° Bal Cool Prt 1/4 x 5.12"   | 1/4"   | .83"  | 1.06" | 5.12" | 1     | \$350.00   | <b>\$245.00</b> |
| C40A-25SF630-9C | Shrink-fit 9° Bal Cool Prt 1/4 x 6.30"   | 1/4"   | .83"  | 1.06" | 6.30" | 2     | \$355.00   | <b>\$248.50</b> |
| C40A-31SF315-9C | Shrink-fit 9° Bal Cool Prt 5/16 x 3.15"  | 5/16"  | .83"  | 1.06" | 3.15" | 1     | \$265.00   | <b>\$185.50</b> |
| C40A-38SF315-9C | Shrink-fit 9° Bal Cool Prt 3/8 x 3.15"   | 3/8"   | .94"  | 1.26" | 3.15" | 1     | \$265.00   | <b>\$185.50</b> |
| C40A-38SF512-9C | Shrink-fit 9° Bal Cool Prt 3/8 x 5.12"   | 3/8"   | .94"  | 1.26" | 5.12" | 1     | \$350.00   | <b>\$245.00</b> |
| C40A-38SF630-9C | Shrink-fit 9° Bal Cool Prt 3/8 x 6.30"   | 3/8"   | .94"  | 1.26" | 6.30" | 2     | \$355.00   | <b>\$248.50</b> |
| C40A-50SF315-9C | Shrink-fit 9° Bal Cool Prt 1/2 x 3.15"   | 1/2"   | .94"  | 1.26" | 3.15" | 1     | \$265.00   | <b>\$185.50</b> |
| C40A-50SF512-9C | Shrink-fit 9° Bal Cool Prt 1/2 x 5.12"   | 1/2"   | .94"  | 1.26" | 5.12" | 1     | \$350.00   | <b>\$245.00</b> |
| C40A-50SF630-9C | Shrink-fit 9° Bal Cool Prt 1/2 x 6.30"   | 1/2"   | .94"  | 1.26" | 6.30" | 2     | \$355.00   | <b>\$248.50</b> |
| C40A-62SF315-9C | Shrink-fit 9° Bal Cool Prt 5/8 x 3.15"   | 5/8"   | 1.06" | 1.34" | 3.15" | 1     | \$265.00   | <b>\$185.50</b> |
| C40A-62SF512-9C | Shrink-fit 9° Bal Cool Prt 5/8 x 5.12"   | 5/8"   | 1.06" | 1.34" | 5.12" | 1     | \$350.00   | <b>\$245.00</b> |
| C40A-62SF630-9C | Shrink-fit 9° Bal Cool Prt 5/8 x 6.30"   | 5/8"   | 1.06" | 1.34" | 6.30" | 2     | \$355.00   | <b>\$248.50</b> |
| C40A-75SF315-9C | Shrink-fit 9° Bal Cool Prt 3/4 x 3.15"   | 3/4"   | 1.30" | 1.65" | 3.15" | 1     | \$265.00   | <b>\$185.50</b> |
| C40A-75SF512-9C | Shrink-fit 9° Bal Cool Prt 3/4 x 5.12"   | 3/4"   | 1.30" | 1.65" | 5.12" | 1     | \$350.00   | <b>\$245.00</b> |
| C40A-75SF630-9C | Shrink-fit 9° Bal Cool Prt 3/4 x 6.30"   | 3/4"   | 1.30" | 1.65" | 6.30" | 2     | \$355.00   | <b>\$248.50</b> |
| C40A-10SF394-9C | Shrink-fit 9° Bal Cool Prt 1 x 3.94"     | 1"     | 1.73" | 2.09" | 3.94" | 1     | \$280.00   | <b>\$196.00</b> |
| C40A-10SF512-9C | Shrink-fit 9° Bal Cool Prt 1 x 5.12"     | 1"     | 1.73" | 2.09" | 5.12" | 1     | \$372.00   | <b>\$260.40</b> |
| C40A-10SF630-9C | Shrink-fit 9° Bal Cool Prt 1 x 6.30"     | 1"     | 1.73" | 2.09" | 6.30" | 2     | \$375.00   | <b>\$262.50</b> |
| C40A-12SF394-9C | Shrink-fit 9° Bal Cool Prt 1-1/4 x 3.94" | 1-1/4" | 1.73" | 2.09" | 3.94" | 1     | \$265.00   | <b>\$185.50</b> |

# ShrinkFit Holders

## 4 Extreme Precision Shrinkfit Tools

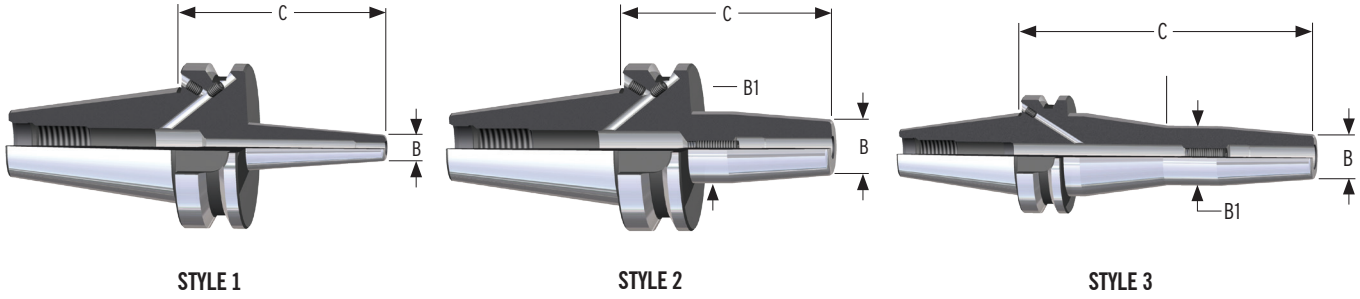

### CAT50 SHRINKFIT | STANDARD | INCH

| Item ID       | Item Description                            | Size   | B     | B1    | C     | Style | List Price | Sale Price      |
|---------------|---|--------|-------|-------|-------|-------|------------|-----------------|
| C50-25SF315-9 | Shrink-Fit 9 Degree Bal AD/B 1/4"X 3.15"    | 1/4"   | 0.83" | 1.06" | 3.15" | 2     | \$337.00   | <b>\$235.90</b> |
| C50-25SF630-9 | Shrink-Fit 9 Degree Bal AD/B 1/4"X 6.30"    | 1/4"   | 0.83" | 1.06" | 6.30" | 3     | \$438.00   | <b>\$306.60</b> |
| C50-31SF315-9 | Shrink-Fit 9 Degree Bal AD/B 5/16"X 3.15"   | 5/16"  | 0.83" | 1.06" | 3.15" | 2     | \$337.00   | <b>\$235.90</b> |
| C50-31SF630-9 | Shrink-Fit 9 Degree Bal AD/B 5/16"X 6.3"    | 5/16"  | 0.83" | 1.06" | 6.30" | 3     | \$438.00   | <b>\$306.60</b> |
| C50-38SF315-9 | Shrink-Fit 9 Degree Bal AD/B 3/8"X 3.15"    | 3/8"   | 0.94" | 1.26" | 3.15" | 2     | \$337.00   | <b>\$235.90</b> |
| C50-38SF630-9 | Shrink-Fit 9 Degree Bal AD/B 3/8"X 6.30"    | 3/8"   | 0.94" | 1.26" | 6.30" | 3     | \$438.00   | <b>\$306.60</b> |
| C50-50SF315-9 | Shrink-Fit 9 Degree Bal AD/B 1/2"X 3.15"    | 1/2"   | 0.94" | 1.26" | 3.15" | 2     | \$337.00   | <b>\$235.90</b> |
| C50-50SF630-9 | Shrink-Fit 9 Degree Bal AD/B 1/2"X 6.30"    | 1/2"   | 0.94" | 1.26" | 6.30" | 3     | \$438.00   | <b>\$306.60</b> |
| C50-62SF315-9 | Shrink-Fit 9 Degree Bal AD/B 5/8"X 3.15"    | 5/8"   | 1.06" | 1.34" | 3.15" | 2     | \$337.00   | <b>\$235.90</b> |
| C50-62SF630-9 | Shrink-Fit 9 Degree Bal AD/B 5/8"X 6.30"    | 5/8"   | 1.06" | 1.34" | 6.30" | 3     | \$438.00   | <b>\$306.60</b> |
| C50-75SF315-9 | Shrink-Fit 9 Degree Bal AD/B 3/4"X 3.15"    | 3/4"   | 1.30" | 1.65" | 3.15" | 2     | \$337.00   | <b>\$235.90</b> |
| C50-75SF630-9 | Shrink-Fit 9 Degree Bal AD/B 3/4"X 6.30"    | 3/4"   | 1.30" | 1.65" | 6.30" | 3     | \$438.00   | <b>\$306.60</b> |
| C50-10SF394-9 | Shrink-Fit 9 Degree Bal AD/B 1"X 3.94"      | 1"     | 1.73" | 2.09" | 3.94" | 2     | \$337.00   | <b>\$235.90</b> |
| C50-10SF630-9 | Shrink-Fit 9 Degree Bal AD/B 1"X 6.30"      | 1"     | 1.73" | 2.09" | 6.30" | 2     | \$438.00   | <b>\$306.60</b> |
| C50-12SF394-9 | Shrink-Fit 9 Degree Bal AD/B 1 1/4" X 3.94" | 1-1/4" | 1.73" | 2.09" | 3.94" | 2     | \$337.00   | <b>\$235.90</b> |
| C50-12SF630-9 | Shrink-Fit 9 Degree Bal AD/B 1 1/4"X 6.3"   | 1-1/4" | 1.73" | 2.09" | 6.30" | 2     | \$438.00   | <b>\$306.60</b> |

### CAT50 SHRINKFIT | STANDARD | METRIC

| Item ID        | Item Description                        | Size  | B     | B1    | C      | Style | List Price | Sale Price      |
|----------------|---|-------|-------|-------|--------|-------|------------|-----------------|
| C50-M06SF160-9 | Shrink-Fit 9 Degree Bal AD/B 6 X 160mm  | 6 mm  | 21 mm | 27 mm | 160 mm | 3     | \$438.00   | <b>\$306.60</b> |
| C50-M06SF80-9  | Shrink-Fit 9 Degree Bal AD/B 6 X 80mm   | 6 mm  | 21 mm | 27 mm | 80 mm  | 2     | \$337.00   | <b>\$235.90</b> |
| C50-M08SF160-9 | Shrink-Fit 9 Degree Bal AD/B 8 X 160mm  | 8 mm  | 21 mm | 27 mm | 160 mm | 3     | \$438.00   | <b>\$306.60</b> |
| C50-M08SF80-9  | Shrink-Fit 9 Degree Bal AD/B 8 X 80mm   | 8 mm  | 21 mm | 27 mm | 80 mm  | 2     | \$337.00   | <b>\$235.90</b> |
| C50-M10SF160-9 | Shrink-Fit 9 Degree Bal AD/B 10 X 160mm | 10 mm | 24 mm | 32 mm | 160 mm | 2     | \$438.00   | <b>\$306.60</b> |
| C50-M10SF80-9  | Shrink-Fit 9 Degree Bal AD/B 10 X 80mm  | 10 mm | 24 mm | 32 mm | 80 mm  | 2     | \$337.00   | <b>\$235.90</b> |
| C50-M12SF160-9 | Shrink-Fit 9 Degree Bal AD/B 12 X 160mm | 12 mm | 24 mm | 32 mm | 160 mm | 2     | \$438.00   | <b>\$306.60</b> |
| C50-M12SF80-9  | Shrink-Fit 9 Degree Bal AD/B 12 X 80mm  | 12 mm | 24 mm | 32 mm | 80 mm  | 2     | \$337.00   | <b>\$235.90</b> |
| C50-M16SF160-9 | Shrink-Fit 9 Degree Bal AD/B 16 X 160mm | 16 mm | 27 mm | 34 mm | 160 mm | 3     | \$438.00   | <b>\$306.60</b> |
| C50-M16SF80-9  | Shrink-Fit 9 Degree Bal AD/B 16 X 80mm  | 16 mm | 27 mm | 34 mm | 80 mm  | 2     | \$337.00   | <b>\$235.90</b> |
| C50-M20SF160-9 | Shrink-Fit 9 Degree Bal AD/B 20 X 160mm | 20 mm | 33 mm | 42 mm | 160 mm | 3     | \$438.00   | <b>\$306.60</b> |
| C50-M20SF80-9  | Shrink-Fit 9 Degree Bal AD/B 20 X 80mm  | 20 mm | 33 mm | 42 mm | 80 mm  | 2     | \$337.00   | <b>\$235.90</b> |
| C50-M25SF100-9 | Shrink-Fit 9 Degree Bal AD/B 25 X 100mm | 25 mm | 44 mm | 53 mm | 100 mm | 2     | \$337.00   | <b>\$235.90</b> |
| C50-M25SF160-9 | Shrink-Fit 9 Degree Bal AD/B 25 X 160mm | 25 mm | 44 mm | 53 mm | 160 mm | 2     | \$337.00   | <b>\$235.90</b> |
| C50-M32SF100-9 | Shrink-Fit 9 DEG, BAL, AD/B 32 X 100MM  | 32 mm | 44 mm | 53 mm | 100 mm | 2     | \$438.00   | <b>\$306.60</b> |
| C50-M32SF160-9 | Shrink-Fit 9 DEG, BAL, AD/B 32 X 160MM  | 32 mm | 44 mm | 53 mm | 160 mm | 2     | \$438.00   | <b>\$306.60</b> |

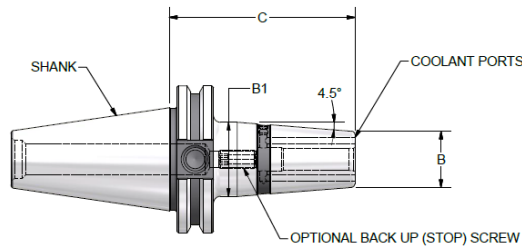

Style 1

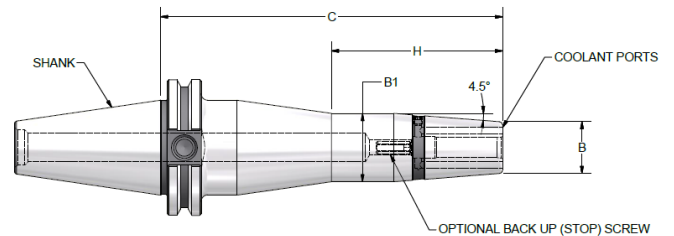

Style 2

### CAT50 SHRINKFIT | COOLANT PORTED | INCH

| Item ID         | Item Description                         | Size   | B     | B1    | C     | Style | List Price | Sale Price          |
|-----------------|--|--------|-------|-------|-------|-------|------------|---------------------|
| C50A-25SF315-9C | Shrink-fit 9° Bal Cool Prt 1/4 x 3.15"   | 1/4"   | .83"  | 1.06" | 3.15" | 1     | \$410.00   | <del>\$287.00</del> |
| C50A-25SF512-9C | Shrink-fit 9° Bal Cool Prt 1/4 x 5.12"   | 1/4"   | .83"  | 1.06" | 5.12" | 1     | \$458.00   | <del>\$320.60</del> |
| C50A-25SF630-9C | Shrink-fit 9° Bal Cool Prt 1/4 x 6.30"   | 1/4"   | .83"  | 1.06" | 6.30" | 2     | \$506.00   | <del>\$354.20</del> |
| C50A-31SF315-9C | Shrink-fit 9° Bal Cool Prt 5/16 x 3.15"  | 5/16"  | .83"  | 1.06" | 3.15" | 1     | \$410.00   | <del>\$287.00</del> |
| C50A-31SF512-9C | Shrink-fit 9° Bal Cool Prt 5/16 x 5.12"  | 5/16"  | .83"  | 1.06" | 5.12" | 1     | \$458.00   | <del>\$320.60</del> |
| C50A-31SF630-9C | Shrink-fit 9° Bal Cool Prt 5/16 x 6.30"  | 5/16"  | .83"  | 1.06" | 6.30" | 2     | \$506.00   | <del>\$354.20</del> |
| C50A-38SF315-9C | Shrink-fit 9° Bal Cool Prt 3/8 x 3.15"   | 3/8"   | .94"  | 1.26" | 3.15" | 1     | \$410.00   | <del>\$287.00</del> |
| C50A-38SF512-9C | Shrink-fit 9° Bal Cool Prt 3/8 x 5.12"   | 3/8"   | .94"  | 1.26" | 5.12" | 1     | \$458.00   | <del>\$320.60</del> |
| C50A-38SF630-9C | Shrink-fit 9° Bal Cool Prt 3/8 x 6.30"   | 3/8"   | .94"  | 1.26" | 6.30" | 2     | \$506.00   | <del>\$354.20</del> |
| C50A-50SF315-9C | Shrink-fit 9° Bal Cool Prt 1/2 x 3.15"   | 1/2"   | .94"  | 1.26" | 3.15" | 1     | \$410.00   | <del>\$287.00</del> |
| C50A-50SF512-9C | Shrink-fit 9° Bal Cool Prt 1/2 x 5.12"   | 1/2"   | .94"  | 1.26" | 5.12" | 1     | \$458.00   | <del>\$320.60</del> |
| C50A-50SF630-9C | Shrink-fit 9° Bal Cool Prt 1/2 x 6.30"   | 1/2"   | .94"  | 1.26" | 6.30" | 2     | \$506.00   | <del>\$354.20</del> |
| C50A-62SF315-9C | Shrink-fit 9° Bal Cool Prt 5/8 x 3.15"   | 5/8"   | 1.06" | 1.34" | 3.15" | 1     | \$410.00   | <del>\$287.00</del> |
| C50A-62SF512-9C | Shrink-fit 9° Bal Cool Prt 5/8 x 5.12"   | 5/8"   | 1.06" | 1.34" | 5.12" | 1     | \$458.00   | <del>\$320.60</del> |
| C50A-62SF630-9C | Shrink-fit 9° Bal Cool Prt 5/8 x 6.30"   | 5/8"   | 1.06" | 1.34" | 6.30" | 2     | \$506.00   | <del>\$354.20</del> |
| C50A-75SF315-9C | Shrink-fit 9° Bal Cool Prt 3/4 x 3.15"   | 3/4"   | 1.30" | 1.65" | 3.15" | 1     | \$410.00   | <del>\$287.00</del> |
| C50A-75SF512-9C | Shrink-fit 9° Bal Cool Prt 3/4 x 5.12"   | 3/4"   | 1.30" | 1.65" | 5.12" | 1     | \$458.00   | <del>\$320.60</del> |
| C50A-75SF630-9C | Shrink-fit 9° Bal Cool Prt 3/4 x 6.30"   | 3/4"   | 1.30" | 1.65" | 6.30" | 2     | \$506.00   | <del>\$354.20</del> |
| C50A-10SF394-9C | Shrink-fit 9° Bal Cool Prt 1 x 3.94"     | 1"     | 1.73" | 2.09" | 3.94" | 1     | \$410.00   | <del>\$287.00</del> |
| C50A-10SF512-9C | Shrink-fit 9° Bal Cool Prt 1 x 5.12"     | 1"     | 1.73" | 2.09" | 5.12" | 1     | \$458.00   | <del>\$320.60</del> |
| C50A-10SF630-9C | Shrink-fit 9° Bal Cool Prt 1 x 6.30"     | 1"     | 1.73" | 2.09" | 6.30" | 2     | \$506.00   | <del>\$354.20</del> |
| C50A-12SF394-9C | Shrink-fit 9° Bal Cool Prt 1-1/4 x 3.94" | 1-1/4" | 1.73" | 2.09" | 3.94" | 1     | \$410.00   | <del>\$287.00</del> |
| C50A-12SF512-9C | Shrink-fit 9° Bal Cool Prt 1-1/4 x 5.12" | 1-1/4" | 1.73" | 2.09" | 5.12" | 1     | \$458.00   | <del>\$320.60</del> |
| C50A-12SF630-9C | Shrink-fit 9° Bal Cool Prt 1-1/4 x 6.30" | 1-1/4" | 1.73" | 2.09" | 6.30" | 2     | \$506.00   | <del>\$354.20</del> |



# ShrinkFit Holders

## 6 Extreme Precision Shrinkfit Tools

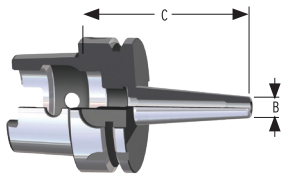

STYLE 1

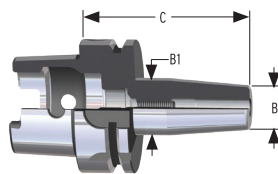

STYLE 2

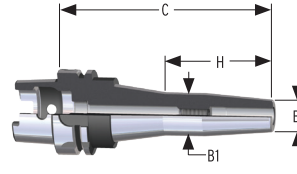

STYLE 3

### HSK 63A SHRINKFIT | STANDARD | INCH

| Item ID        | Item Description                       | Size   | B     | B1    | C     | Style | List Price | Sale Price      |
|----------------|--|--------|-------|-------|-------|-------|------------|-----------------|
| H63A-01SF315-9 | Shrink-Fit 9 Degree Bal 1/8" X 3.15"   | 1/8"   | 0.39" | 0.62" | 3.15" | 2     | \$314.00   | <b>\$219.80</b> |
| H63A-18SF315-9 | Shrink-Fit 9 Degree Bal 3/16" X 3.15"  | 3/16"  | 0.39" | -     | 3.15" | 1     | \$314.00   | <b>\$219.80</b> |
| H63A-25SF315-9 | Shrink-Fit 9 Degree Bal 1/4" X 3.15"   | 1/4"   | 0.83" | 1.06" | 3.15" | 2     | \$290.00   | <b>\$203.00</b> |
| H63A-25SF630-9 | Shrink-Fit 9 Degree Bal 1/4" X 6.30"   | 1/4"   | .83"  | 1.06" | 6.30" | 2     | \$404.00   | <b>\$282.80</b> |
| H63A-31SF315-9 | Shrink-Fit 9 Degree Bal 5/16" X 3.15"  | 5/16"  | .83"  | 1.06" | 3.15" | 2     | \$290.00   | <b>\$203.00</b> |
| H63A-31SF630-9 | Shrink-Fit 9 Degree Bal 5/16" X 6.30"  | 5/16"  | .83"  | 1.06" | 6.30" | 3     | \$380.00   | <b>\$266.00</b> |
| H63A-38SF335-9 | Shrink-Fit 9 Degree Bal 3/8" X 3.35"   | 3/8"   | 0.94" | 1.26" | 3.35" | 2     | \$290.00   | <b>\$203.00</b> |
| H63A-38SF630-9 | Shrink-Fit 9 Degree Bal 3/8" X 6.30"   | 3/8"   | 0.94" | 1.26" | 6.30" | 3     | \$404.00   | <b>\$282.80</b> |
| H63A-50SF354-9 | Shrink-Fit 9 Degree Bal 1/2" X 3.54"   | 1/2"   | 0.94" | 1.26" | 3.54" | 2     | \$290.00   | <b>\$203.00</b> |
| H63A-50SF630-9 | Shrink-Fit 9 Degree Bal 1/2" X 6.30"   | 1/2"   | 0.94" | 1.26" | 6.30" | 3     | \$404.00   | <b>\$282.80</b> |
| H63A-62SF374-9 | Shrink-Fit 9 Degree Bal 5/8" X 3.74"   | 5/8"   | 1.06" | 1.34" | 3.74" | 2     | \$290.00   | <b>\$203.00</b> |
| H63A-62SF630-9 | Shrink-Fit 9 Degree Bal 5/8" X 6.30"   | 5/8"   | 1.06" | 1.34" | 6.30" | 3     | \$404.00   | <b>\$282.80</b> |
| H63A-75SF394-9 | Shrink-Fit 9 Degree Bal 3/4" X 3.94"   | 3/4"   | 1.30" | 1.65" | 3.94" | 2     | \$290.00   | <b>\$203.00</b> |
| H63A-75SF630-9 | Shrink-Fit 9 Degree Bal 3/4" X 6.30"   | 3/4"   | 1.30" | 1.65" | 6.30" | 2     | \$404.00   | <b>\$282.80</b> |
| H63A-10SF453-9 | Shrink-Fit 9 Degree Bal 1" X 4.53"     | 1"     | 1.73" | 2.09" | 4.53" | 2     | \$290.00   | <b>\$203.00</b> |
| H63A-10SF630-9 | Shrink-Fit 9 Degree Bal 1" X 6.30"     | 1"     | 1.73" | 2.09" | 6.30" | 2     | \$404.00   | <b>\$282.80</b> |
| H63A-12SF472-9 | Shrink-Fit 9 Degree Bal 1 1/4" X 4.72" | 1-1/4" | 1.73" | 2.09" | 4.72" | 2     | \$290.00   | <b>\$203.00</b> |
| H63A-12SF630-9 | Shrink-Fit 9 Degree Bal 1 1/4" X 6.30" | 1-1/4" | 1.73" | 2.09" | 6.30" | 2     | \$404.00   | <b>\$282.80</b> |

### HSK 63A SHRINKFIT | STANDARD | METRIC

| Item ID         | Item Description                   | Size  | B     | B1    | C      | Style | List Price | Sale Price      |
|-----------------|------------------------------------|-------|-------|-------|--------|-------|------------|-----------------|
| H63A-M04SF80-9  | Shrink-Fit 9 Degree Bal 4 X 80mm   | 4 mm  | 10 mm | -     | 80 mm  | 1     | \$314.00   | <b>\$219.80</b> |
| H63A-M06SF130-9 | Shrink-Fit 9 Degree Bal 6 X 130mm  | 6 mm  | 21 mm | 27 mm | 130 mm | 2     | \$404.00   | <b>\$282.80</b> |
| H63A-M06SF160-9 | Shrink-Fit 9 Degree Bal 6 X 160mm  | 6 mm  | 21 mm | 27 mm | 160 mm | 3     | \$404.00   | <b>\$282.80</b> |
| H63A-M06SF80-9  | Shrink-Fit 9 Degree Bal 6 X 80mm   | 6 mm  | 21 mm | 27 mm | 80 mm  | 2     | \$290.00   | <b>\$203.00</b> |
| H63A-M08SF130-9 | Shrink-Fit 9 Degree Bal 8 X 130mm  | 8 mm  | 21 mm | 27 mm | 130 mm | 3     | \$404.00   | <b>\$282.80</b> |
| H63A-M08SF160-9 | Shrink-Fit 9 Degree Bal 8 X 160mm  | 8 mm  | 21 mm | 27 mm | 160 mm | 3     | \$404.00   | <b>\$282.80</b> |
| H63A-M08SF80-9  | Shrink-Fit 9 Degree Bal 8 X 80mm   | 8 mm  | 21 mm | 27 mm | 80 mm  | 2     | \$404.00   | <b>\$282.80</b> |
| H63A-M10SF130-9 | Shrink-Fit 9 Degree Bal 10 X 130mm | 10 mm | 24 mm | 32 mm | 130 mm | 2     | \$404.00   | <b>\$282.80</b> |
| H63A-M10SF160-9 | Shrink-Fit 9 Degree Bal 10 X 160mm | 10 mm | 24 mm | 32 mm | 160 mm | 2     | \$404.00   | <b>\$282.80</b> |
| H63A-M10SF85-9  | Shrink-Fit 9 Degree Bal 10 X 85mm  | 10 mm | 24 mm | 32 mm | 85 mm  | 2     | \$295.00   | <b>\$206.50</b> |
| H63A-M12SF130-9 | Shrink-Fit 9 Degree Bal 12 X 130mm | 12 mm | 24 mm | 32 mm | 130 mm | 2     | \$404.00   | <b>\$282.80</b> |
| H63A-M12SF160-9 | Shrink-Fit 9 Degree Bal 12 X 160mm | 12 mm | 24 mm | 32 mm | 160 mm | 2     | \$404.00   | <b>\$282.80</b> |
| H63A-M12SF90-9  | Shrink-Fit 9 Degree Bal 12 X 90mm  | 12 mm | 24 mm | 32 mm | 90mm   | 2     | \$290.00   | <b>\$203.00</b> |
| H63A-M16SF130-9 | Shrink-Fit 9 Degree Bal 16 X 130mm | 16 mm | 27 mm | 34 mm | 130 mm | 3     | \$404.00   | <b>\$282.80</b> |
| H63A-M16SF160-9 | Shrink-Fit 9 Degree Bal 16 X 160mm | 16 mm | 27 mm | 34 mm | 160 mm | 3     | \$404.00   | <b>\$282.80</b> |
| H63A-M16SF95-9  | Shrink-Fit 9 Degree Bal 16 X 95mm  | 16 mm | 27 mm | 34 mm | 95 mm  | 2     | \$290.00   | <b>\$203.00</b> |
| H63A-M20SF100-9 | Shrink-Fit 9 Degree Bal 20 X 100mm | 20 mm | 27 mm | 42 mm | 100 mm | 2     | \$290.00   | <b>\$203.00</b> |
| H63A-M20SF160-9 | Shrink-Fit 9 Degree Bal 20 X 160mm | 20 mm | 27 mm | 42 mm | 160 mm | 2     | \$404.00   | <b>\$282.80</b> |
| H63A-M25SF115-9 | Shrink-Fit 9 Degree Bal 25 X 115mm | 25 mm | 44 mm | 53 mm | 115 mm | 2     | \$290.00   | <b>\$203.00</b> |
| H63A-M25SF160-9 | Shrink-Fit 9 Degree Bal 25 X 160mm | 25 mm | 44 mm | 53 mm | 160 mm | 2     | \$404.00   | <b>\$282.80</b> |
| H63A-M32SF120-9 | Shrink-Fit 9 Degree Bal 32 X 120mm | 32 mm | 44 mm | 53 mm | 120 mm | 2     | \$286.00   | <b>\$200.20</b> |
| H63A-M32SF160-9 | Shrink-Fit 9 Degree Bal 32 X 160mm | 32 mm | 44 mm | 53 mm | 160 mm | 2     | \$404.00   | <b>\$282.80</b> |

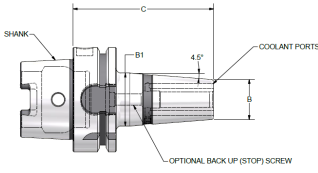

Style 1

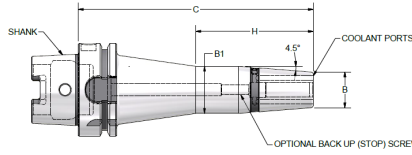

Style 2

### HSK 63A SHRINKFIT | COOLANT PORTED | INCH

\*Style 3: No Coolant Ports

| Item ID         | Item Description                          | Size   | B     | B1    | C     | Style | List Price | Sale Price |
|-----------------|---|--------|-------|-------|-------|-------|------------|------------|
| H63A-25SF315-9C | Shrink-fit 9° Bal Cool Prt 1/4"X 3.15"    | 1/4"   | 0.83  | 1.06" | 3.15" | 2     | \$290.00   | \$203.00   |
| H63A-25SF630-9C | Shrink-fit 9° Bal Cool Prt 1/4"X 6.30"    | 1/4"   | .83"  | 1.06" | 6.30" | 2     | \$404.00   | \$282.80   |
| H63A-31SF315-9C | Shrink-fit 9° Bal Cool Prt 5/16"X 3.15"   | 5/16"  | .83"  | 1.06" | 3.15" | 2     | \$290.00   | \$203.00   |
| H63A-31SF630-9C | Shrink-fit 9° Bal Cool Prt 5/16"X 6.30"   | 5/16"  | .83"  | 1.06" | 6.30" | *3    | \$380.00   | \$266.00   |
| H63A-38SF335-9C | Shrink-fit 9° Bal Cool Prt 3/8"X 3.35"    | 3/8"   | 0.94" | 1.26" | 3.35" | 2     | \$290.00   | \$203.00   |
| H63A-38SF630-9C | Shrink-fit 9° Bal Cool Prt 3/8"X 6.30"    | 3/8"   | 0.94" | 1.26" | 6.30" | *3    | \$404.00   | \$282.80   |
| H63A-50SF354-9C | Shrink-fit 9° Bal Cool Prt 1/2"X 3.54"    | 1/2"   | 0.94" | 1.26" | 3.54" | 2     | \$290.00   | \$203.00   |
| H63A-50SF630-9C | SShrink-fit 9° Bal Cool Prt 1/2"X 6.30"   | 1/2"   | 0.94" | 1.26" | 6.30" | *3    | \$404.00   | \$282.80   |
| H63A-62SF374-9C | Shrink-fit 9° Bal Cool Prt 5/8"X 3.74"    | 5/8"   | 1.06" | 1.34" | 3.74" | 2     | \$290.00   | \$203.00   |
| H63A-62SF630-9C | Shrink-fit 9° Bal Cool Prt 5/8"X 6.30"    | 5/8"   | 1.06" | 1.34" | 6.30" | *3    | \$404.00   | \$282.80   |
| H63A-75SF394-9C | Shrink-fit 9° Bal Cool Prt 3/4"X 3.94"    | 3/4"   | 1.30" | 1.65" | 3.94" | 2     | \$290.00   | \$203.00   |
| H63A-75SF630-9C | Shrink-fit 9° Bal Cool Prt 3/4"X 6.30"    | 3/4"   | 1.30" | 1.65" | 6.30" | 2     | \$404.00   | \$282.80   |
| H63A-10SF453-9C | Shrink-fit 9° Bal Cool Prt 1" X 4.53"     | 1"     | 1.73" | 2.09" | 4.53" | 2     | \$290.00   | \$203.00   |
| H63A-10SF630-9C | Shrink-fit 9° Bal Cool Prt 1" X 6.30"     | 1"     | 1.73" | 2.09" | 6.30" | 2     | \$404.00   | \$282.80   |
| H63A-12SF472-9C | Shrink-fit 9° Bal Cool Prt 1 1/4" X 4.72" | 1-1/4" | 1.73" | 2.09" | 4.72" | 2     | \$290.00   | \$203.00   |
| H63A-12SF630-9C | Shrink-fit 9° Bal Cool Prt 1 1/4" X 6.30" | 1-1/4" | 1.73" | 2.09" | 6.30" | 2     | \$404.00   | \$282.80   |

### HSK 63A SHRINKFIT | COOLANT PORTED | METRIC

| Item ID          | Item Description                      | Size  | B     | B1    | C     | Style | List Price | Sale Price |
|------------------|---------------------------------------|-------|-------|-------|-------|-------|------------|------------|
| H63A-M06SF80-9C  | Shrink-fit 9° Bal Cool Prt 6 x 80mm   | 6 mm  | 21 mm | 27 mm | 80mm  | 1     | \$280.00   | \$196.00   |
| H63A-M06SF130-9C | Shrink-fit 9° Bal Cool Prt 6 x 130mm  | 6 mm  | 21 mm | 27 mm | 130mm | 1     | \$372.00   | \$260.40   |
| H63A-M06SF160-9C | Shrink-fit 9° Bal Cool Prt 6 x 160mm  | 6 mm  | 21 mm | 27 mm | 160mm | 2     | \$408.00   | \$285.60   |
| H63A-M08SF80-9C  | Shrink-fit 9° Bal Cool Prt 8 x 80mm   | 8 mm  | 21 MM | 27 mm | 80mm  | 1     | \$280.00   | \$196.00   |
| H63A-M08SF130-9C | Shrink-fit 9° Bal Cool Prt 8 x 130mm  | 8 mm  | 21 mm | 27 mm | 130mm | 1     | \$372.00   | \$260.40   |
| H63A-M08SF160-9C | Shrink-fit 9° Bal Cool Prt 8 x 160mm  | 8 mm  | 21 mm | 27 mm | 160mm | 2     | \$408.00   | \$285.60   |
| H63A-M10SF85-9C  | Shrink-fit 9° Bal Cool Prt 10 x 85mm  | 10 mm | 24 mm | 32 mm | 85mm  | 1     | \$280.00   | \$196.00   |
| H63A-M10SF130-9C | Shrink-fit 9° Bal Cool Prt 10 x 130mm | 10 mm | 24 mm | 32 mm | 130mm | 1     | \$372.00   | \$260.40   |
| H63A-M10SF160-9C | Shrink-fit 9° Bal Cool Prt 10 x 160mm | 10 mm | 24 mm | 32 mm | 160mm | 2     | \$408.00   | \$285.60   |
| H63A-M12SF90-9C  | Shrink-fit 9° Bal Cool Prt 12 x 90mm  | 12 mm | 24 mm | 32 mm | 90mm  | 1     | \$280.00   | \$196.00   |
| H63A-M12SF130-9C | Shrink-fit 9° Bal Cool Prt 12 x 130mm | 12 mm | 24 mm | 32 mm | 130mm | 1     | \$372.00   | \$260.40   |
| H63A-M12SF160-9C | Shrink-fit 9° Bal Cool Prt 12 x 160mm | 12 mm | 24 mm | 32 mm | 160mm | 2     | \$408.00   | \$285.60   |
| H63A-M16SF95-9C  | Shrink-fit 9° Bal Cool Prt 16 x 95mm  | 16 mm | 27 mm | 34 mm | 95mm  | 1     | \$280.00   | \$196.00   |
| H63A-M16SF130-9C | Shrink-fit 9° Bal Cool Prt 16 x 130mm | 16 mm | 27 mm | 34 mm | 130mm | 1     | \$372.00   | \$260.40   |
| H63A-M16SF160-9C | Shrink-fit 9° Bal Cool Prt 16 x 160mm | 16 mm | 27 mm | 34 mm | 160mm | 2     | \$408.00   | \$285.60   |
| H63A-M20SF100-9C | Shrink-fit 9° Bal Cool Prt 20 x 100mm | 20 mm | 27 mm | 42 mm | 100mm | 1     | \$372.00   | \$260.40   |
| H63A-M20SF130-9C | Shrink-fit 9° Bal Cool Prt 20 x 130mm | 20 mm | 27 mm | 42 mm | 130mm | 1     | \$408.00   | \$285.60   |
| H63A-M20SF160-9C | Shrink-fit 9° Bal Cool Prt 20 x 160mm | 20 mm | 27 mm | 42 mm | 160mm | 2     | \$280.00   | \$196.00   |
| H63A-M25SF115-9C | Shrink-fit 9° Bal Cool Prt 25 x 115mm | 25 mm | 44 mm | 53 mm | 115mm | 1     | \$280.00   | \$196.00   |
| H63A-M25SF130-9C | Shrink-fit 9° Bal Cool Prt 25 x 130mm | 25 mm | 44 mm | 53 mm | 130mm | 1     | \$372.00   | \$260.40   |
| H63A-M25SF160-9C | Shrink-fit 9° Bal Cool Prt 25 x 160mm | 25 mm | 44 mm | 53 mm | 160mm | 2     | \$408.00   | \$285.60   |
| H63A-M32SF120-9C | Shrink-fit 9° Bal Cool Prt 32 x 120mm | 32 mm | 44 mm | 53 mm | 120mm | 2     | \$280.00   | \$196.00   |
| H63A-M32SF160-9C | Shrink-fit 9° Bal Cool Prt 32 x 160mm | 32 mm | 44 mm | 53 mm | 160mm | 1     | \$408.00   | \$285.60   |

# ShrinkFit Holders

## 8 Extreme Precision Shrinkfit Tools

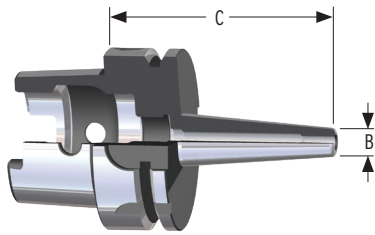

STYLE 1

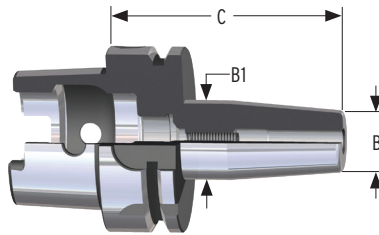

STYLE 2

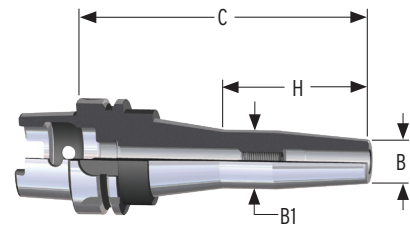

STYLE 3

### HSK 100A SHRINKFIT | STANDARD | INCH

| Item ID         | Item Description                       | Size   | B     | B1    | C     | Style | List Price | Sale Price      |
|-----------------|--|--------|-------|-------|-------|-------|------------|-----------------|
| H100A-25SF335-9 | Shrink-Fit 9 Degree Bal 1/4" X 3.35"   | 1/4"   | 0.83" | 1.06" | 3.35" | 2     | \$458.00   | <b>\$320.60</b> |
| H100A-25SF630-9 | Shrink-Fit 9 Degree Bal 1/4" X 6.30"   | 1/4"   | 0.83" | 1.06" | 6.30" | 3     | \$499.00   | <b>\$349.30</b> |
| H100A-31SF335-9 | Shrink-Fit 9 Degree Bal 5/16" X 3.35"  | 5/16"  | 0.83" | 1.06" | 3.35" | 2     | \$458.00   | <b>\$320.60</b> |
| H100A-31SF630-9 | Shrink-Fit 9 Degree Bal 5/16" X 6.30"  | 5/16"  | 0.83" | 1.06" | 6.30" | 3     | \$499.00   | <b>\$349.30</b> |
| H100A-38SF354-9 | Shrink-Fit 9 Degree Bal 3/8" X 3.54"   | 3/8"   | 0.94" | 1.26" | 3.54" | 2     | \$458.00   | <b>\$320.60</b> |
| H100A-38SF630-9 | Shrink-Fit 9 Degree Bal 3/8" X 6.30"   | 3/8"   | 0.94" | 1.26" | 6.30" | 3     | \$499.00   | <b>\$349.30</b> |
| H100A-50SF374-9 | Shrink-Fit 9 Degree Bal 1/2" X 3.74"   | 1/2"   | 0.94" | 1.26" | 3.74" | 2     | \$458.00   | <b>\$320.60</b> |
| H100A-50SF630-9 | Shrink-Fit 9 Degree Bal 1/2" X 6.30"   | 1/2"   | 0.94" | 1.26" | 6.30" | 3     | \$499.00   | <b>\$349.30</b> |
| H100A-62SF394-9 | Shrink-Fit 9 Degree Bal 5/8" X 3.94"   | 5/8"   | 1.06" | 1.34" | 3.94" | 2     | \$458.00   | <b>\$320.60</b> |
| H100A-62SF630-9 | Shrink-Fit 9 Degree Bal 5/8" X 6.30"   | 5/8"   | 1.06" | 1.34" | 6.30" | 3     | \$499.00   | <b>\$349.30</b> |
| H100A-75SF413-9 | Shrink-Fit 9 Degree Bal 3/4" X 4.13"   | 3/4"   | 1.30" | 1.65" | 4.13" | 2     | \$458.00   | <b>\$320.60</b> |
| H100A-75SF630-9 | Shrink-Fit 9 Degree Bal 3/4" X 6.30"   | 3/4"   | 1.30" | 1.65" | 6.30" | 3     | \$499.00   | <b>\$349.30</b> |
| H100A-10SF453-9 | Shrink-Fit 9 Degree Bal 1" X 4.53"     | 1"     | 1.73" | 2.09" | 4.53" | 2     | \$458.00   | <b>\$320.60</b> |
| H100A-10SF630-9 | Shrink-Fit 9 Degree Bal 1" X 6.30"     | 1"     | 1.73" | 2.09" | 6.30" | 3     | \$499.00   | <b>\$349.30</b> |
| H100A-12SF472-9 | Shrink-Fit 9 Degree Bal 1-1/4" X 4.72" | 1-1/4" | 1.73" | 2.09" | 4.72" | 2     | \$458.00   | <b>\$320.60</b> |
| H100A-12SF630-9 | Shrink-Fit 9 Degree Bal 1-1/4" X 6.30" | 1-1/4" | 1.73" | 2.09" | 6.30" | 3     | \$499.00   | <b>\$349.30</b> |

### HSK 100A SHRINKFIT | COOLANT PORTED | INCH

| Item ID          | Item Description                          | Size   | B     | B1    | C     | Style | List Price | Sale Price      |
|------------------|---|--------|-------|-------|-------|-------|------------|-----------------|
| H100A-25SF335-9C | Shrink-fit 9° Bal Cool Prt 1/4" x 3.35"   | 1/4"   | 0.83" | 1.06" | 3.35" | 2     | \$480.00   | <b>\$336.00</b> |
| H100A-25SF630-9C | Shrink-fit 9° Bal Cool Prt 1/4" x 6.30"   | 1/4"   | 0.83" | 1.06" | 6.30" | 3     | \$618.00   | <b>\$432.60</b> |
| H100A-31SF335-9C | Shrink-fit 9° Bal Cool Prt 5/16" x 3.35"  | 5/16"  | 0.83" | 1.06" | 3.35" | 2     | \$480.00   | <b>\$336.00</b> |
| H100A-31SF630-9C | Shrink-fit 9° Bal Cool Prt 5/16" x 6.30"  | 5/16"  | 0.83" | 1.06" | 6.30" | 3     | \$618.00   | <b>\$432.60</b> |
| H100A-38SF354-9C | Shrink-fit 9° Bal Cool Prt 3/8" x 3.54"   | 3/8"   | 0.94" | 1.26" | 3.54" | 2     | \$480.00   | <b>\$336.00</b> |
| H100A-38SF630-9C | Shrink-fit 9° Bal Cool Prt 3/8" x 6.30"   | 3/8"   | 0.94" | 1.26" | 6.30" | 3     | \$618.00   | <b>\$432.60</b> |
| H100A-50SF374-9C | Shrink-fit 9° Bal Cool Prt 1/2" x 3.74"   | 1/2"   | 0.94" | 1.26" | 3.74" | 2     | \$480.00   | <b>\$336.00</b> |
| H100A-50SF630-9C | Shrink-fit 9° Bal Cool Prt 1/2" x 6.30"   | 1/2"   | 0.94" | 1.26" | 6.30" | 3     | \$618.00   | <b>\$432.60</b> |
| H100A-62SF394-9C | Shrink-fit 9° Bal Cool Prt 5/8" x 3.94"   | 5/8"   | 1.06" | 1.34" | 3.94" | 2     | \$480.00   | <b>\$336.00</b> |
| H100A-62SF630-9C | Shrink-fit 9° Bal Cool Prt 5/8" x 6.30"   | 5/8"   | 1.06" | 1.34" | 6.30" | 3     | \$618.00   | <b>\$432.60</b> |
| H100A-75SF413-9C | Shrink-fit 9° Bal Cool Prt 3/4" x 4.13"   | 3/4"   | 1.30" | 1.65" | 4.13" | 2     | \$480.00   | <b>\$336.00</b> |
| H100A-75SF630-9C | Shrink-fit 9° Bal Cool Prt 3/4" x 6.30"   | 3/4"   | 1.30" | 1.65" | 6.30" | 3     | \$618.00   | <b>\$432.60</b> |
| H100A-10SF453-9C | Shrink-fit 9° Bal Cool Prt 1" x 4.53"     | 1"     | 1.73" | 2.09" | 4.53" | 2     | \$480.00   | <b>\$336.00</b> |
| H100A-10SF630-9C | Shrink-fit 9° Bal Cool Prt 1" x 6.30"     | 1"     | 1.73" | 2.09" | 6.30" | 3     | \$618.00   | <b>\$432.60</b> |
| H100A-12SF472-9C | Shrink-fit 9° Bal Cool Prt 1-1/4" x 4.72" | 1-1/4" | 1.73" | 2.09" | 4.72" | 2     | \$480.00   | <b>\$336.00</b> |
| H100A-12SF630-9C | Shrink-fit 9° Bal Cool Prt 1-1/4" x 6.30" | 1-1/4" | 1.73" | 2.09" | 6.30" | 3     | \$618.00   | <b>\$432.60</b> |



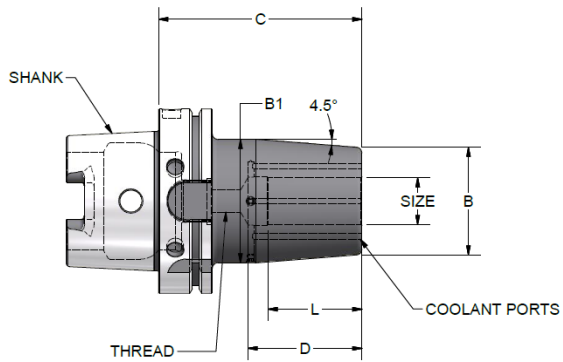

Style 1

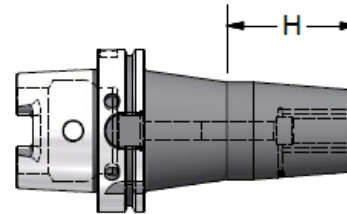

Style 2

### HSK 100A SHRINKFIT | HEAVY DUTY | COOLANT PORTED

| Item ID           | Item Description                        | Size   | B     | B1    | C     | Style | List Price | Sale Price      |
|-------------------|---|--------|-------|-------|-------|-------|------------|-----------------|
| H100A-38SHD512-9C | Heavy Wall HDSF Cool Prt 3/8" x 5.12"   | 3/8"   | 1.50" | 1.78" | 5.12" | 2     | \$658.00   | <b>\$460.60</b> |
| H100A-38SHD630-9C | Heavy Wall HDSF Cool Prt 3/8" x 3.94"   | 3/8"   | 1.50" | 1.78" | 6.30" | 2     | \$723.00   | <b>\$506.00</b> |
| H100A-50SHD374-9C | Heavy Wall HDSF Cool Prt 1/2" x 3.74"   | 1/2"   | 1.06" | 1.34" | 3.74" | 1     | \$658.00   | <b>\$460.60</b> |
| H100A-50SHD630-9C | Heavy Wall HDSF Cool Prt 1/2" x 6.30"   | 1/2"   | 1.50" | 1.78" | 6.30" | 2     | \$724.00   | <b>\$506.80</b> |
| H100A-50SHD787-9C | Heavy Wall HDSF Cool Prt 1/2" x 7.87"   | 1/2"   | 1.06" | 1.34" | 7.87" | 2     | \$788.00   | <b>\$551.60</b> |
| H100A-62SHD394-9C | Heavy Wall HDSF Cool Prt 5/8" x 3.94"   | 5/8"   | 1.97" | 2.36" | 3.94" | 1     | \$658.00   | <b>\$460.60</b> |
| H100A-62SHD630-9C | Heavy Wall HDSF Cool Prt 5/8" x 6.30"   | 5/8"   | 1.97" | 2.36" | 6.30" | 2     | \$723.00   | <b>\$506.10</b> |
| H100A-75SHD394-9C | Heavy Wall HDSF Cool Prt 3/4" x 3.94"   | 3/4"   | 2.28" | 2.64" | 3.94" | 1     | \$658.00   | <b>\$460.60</b> |
| H100A-75SHD413-9C | Heavy Wall HDSF Cool Prt 3/4" x 4.13"   | 3/4"   | 2.28" | 2.64" | 4.13" | 1     | \$658.00   | <b>\$460.60</b> |
| H100A-75SHD512-9C | Heavy Wall HDSF Cool Prt 3/4" x 5.12"   | 3/4"   | 2.28" | 2.64" | 5.12" | 1     | \$709.00   | <b>\$496.30</b> |
| H100A-75SHD630-9C | Heavy Wall HDSF Cool Prt 3/4" x 6.30"   | 3/4"   | 2.28" | 2.64" | 6.30" | 1     | \$723.00   | <b>\$506.10</b> |
| H100A-75SHD787-9C | Heavy Wall HDSF Cool Prt 3/4" x 7.87"   | 3/4"   | 2.28" | 2.64" | 7.87" | 1     | \$748.00   | <b>\$523.60</b> |
| H100A-10SHD433-9C | Heavy Wall HDSF Cool Prt 1" x 4.33"     | 1"     | 2.28" | 2.64" | 4.33" | 1     | \$658.00   | <b>\$460.60</b> |
| H100A-10SHD472-9C | Heavy Wall HDSF Cool Prt 1" x 4.72"     | 1"     | 2.48" | 2.84" | 4.72" | 1     | \$658.00   | <b>\$460.60</b> |
| H100A-10SHD630-9C | Heavy Wall HDSF Cool Prt 1" x 6.30"     | 1"     | 2.48" | 2.84" | 6.30" | 1     | \$723.00   | <b>\$506.10</b> |
| H100A-10SHD787-9C | Heavy Wall HDSF Cool Prt 1" x 7.87"     | 1"     | 2.28" | 2.64" | 7.87" | 1     | \$748.00   | <b>\$523.60</b> |
| H100A-12SHD433-9C | Heavy Wall HDSF Cool Prt 1-1/4" x 4.33" | 1-1/4" | 2.76" | 3.07" | 4.33" | 1     | \$658.00   | <b>\$460.60</b> |
| H100A-12SHD472-9C | Heavy Wall HDSF Cool Prt 1-1/4" x 4.72" | 1-1/4" | 2.76" | 3.07" | 4.72" | 1     | \$658.00   | <b>\$460.60</b> |
| H100A-12SHD512-9C | Heavy Wall HDSF Cool Prt 1-1/4" x 5.12" | 1-1/4" | 2.76" | 3.07" | 5.12" | 1     | \$658.00   | <b>\$460.60</b> |
| H100A-12SHD630-9C | Heavy Wall HDSF Cool Prt 1-1/4" x 6.3"  | 1-1/4" | 2.76" | 3.07" | 6.30" | 1     | \$723.00   | <b>\$506.10</b> |
| H100A-12SHD787-9C | Heavy Wall HDSF Cool Prt 1-1/4" x 7.87" | 1-1/4" | 2.76" | 3.07" | 7.87" | 1     | \$748.00   | <b>\$523.60</b> |