

TUTUCU KATALOĐU
HOLDER CATALOG
HALTER KATALOG

2026



*konuşulan
the spoken kalite...
quality...*



COMPLETE METALWORKING SOLUTIONS
(800) 991-4225 www.ahbinc.com
ISO Certified customerservice@ahbinc.com



- Takım Tutucu Sistemleri
- Tool Holder Systems
- Werkzeugaufnahmen

 **AKKO**[®]

Versiyon
Version 0100/0226
Auflage

 www.akko.com.tr



TS EN ISO 9001:2015

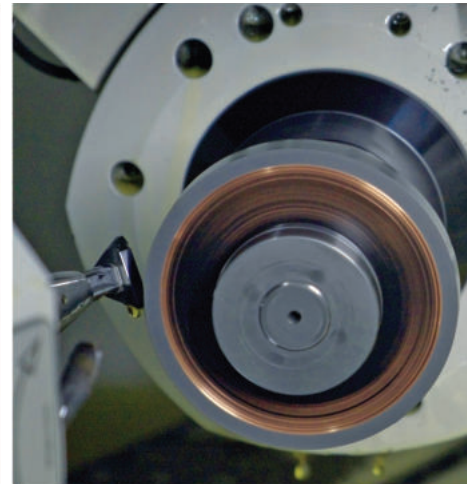
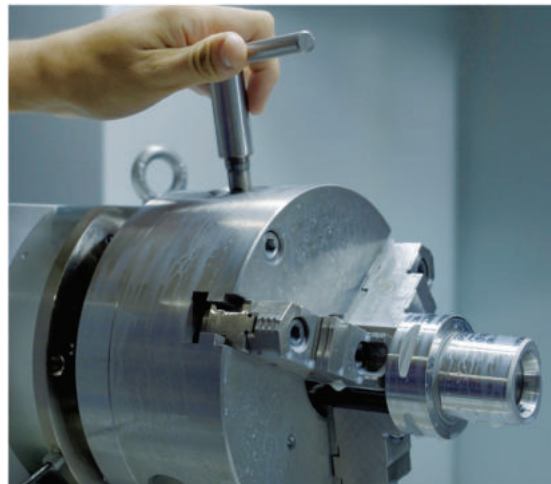

www.akk.com.tr



1986 yılında Abdullah KARAKUŞ tarafından kurulan AKKO Makina Sanayi ve Ticaret A.Ş. Tornalama Takımları, Diş ve Kanal Açma Takımları, Delik Delme Takımları, Frezeleme Takımları ve talebe yönelik Özel Takımlar, Monoblok ve Tutucular ile Profil Uçlar üretmektedir. Şu an 40.000m²'ye yakın bir alanda Türkiye, Japonya, Almanya, İsviçre gibi ülkelerin ürettikleri son teknoloji tezgah ve ekipmanlarıyla yıllık 750.000 adet üretim kapasitesiyle, standart 14.000 çeşit takım üretimi ve 400.000 adet profil uç üretimi yapmaktadır. Avrupa, Asya, Afrika, Güney Amerika, Kuzey Amerika ve Orta Doğu kıtalarında şimdilik düzenli olarak 90 ülkeye ürün sevkiyatına devam etmektedir. Minimum 300.000 adet üretilmiş ürün stoklarında mevcut bulunmaktadır. Firma için özel üretilen çelik hammadde işleme girer ve bütün üretim süreci kendi bünyesinde gerçekleşmektedir. Çeliğin işlenmesi, ısıl işlemi, üzerindeki kaplama ve her türlü üretim operasyonları bir entegre tesis olan AKKO'da yapılmaktadır.

We as AKKO Makina Sanayi ve Ticaret A.Ş. which were founded by Abdullah KARAKUŞ in 1986, produce Turning Tool Holders, Threading and Grooving Tool Holders, U-Drills, Milling Tool Holders, Precision Tool Holders (OEM Tool Holders) on-demand, Monoblocks and Holders, and Profile Inserts. We produce a standard 14.000 kinds of tool holders with a production capacity of 750.000 pieces and 400.000 pieces of special profile inserts per year in an area of about 40.000 square meters. We are going on regularly exporting to 90 countries including European, Asian, African, South American Countries, North American Countries, and Middle Eastern countries. We keep ready about 300.000 pieces produced products in our stock. Steel Raw materials that we make produced especially for us are delivered our factory and all production process are made in our factory. All kinds of operations from machining of steel to heat treatment and coating on our tools are made in our integrated factory AKKO.

Wir die Firma AKKO Makina Sanayi ve Ticaret A.Ş. welches durch Herrn Abdullah Karakuş in 1986 gegründet wurde, produzieren Dreh-, Gewinde- und Stechwerkzeuge für Wendeschneidplatten. Zum Lieferprogramm gehören außerdem Wendeplattenbohrer, Wendeplattenfräser, Halter und auf Anfrage auch Sonderwerkzeuge für Wendeschneidplatten. Alle Werkzeuge sind auch als OEM-Version lieferbar. Wir produzieren 14.000 Standard Arten der Werkzeughalter mit einer Produktionskapazität von 750.000 Stücken und 400.000 Stück Spezialprofileinlagen per annum auf einer Fläche von 40.000 Quadrat Meter. Wir exportieren unsere eigenproduzierten Ware nach 90 Ländern, Europa, Asien, Afrika, Süd amerikanische Länder, Mittlerer Osten. Lieferbereit halten wir 300.000 Stück produzierte Produkte auf Lager. Das eingesetzte Rohmaterial wird speziell für unsere Firma produziert. Alle Produktionsschritte werden auf unseren eigenen Anlagen veranlasst. Alle einzelnen Produktionsschritte wie z.B. mechanische Bearbeitung, Wärmebehandlung und Beschichtung unserer Werkzeuge erfolgen auf unseren eigenen Maschinenanlagen.



BT

**BT TUTUCULAR
KODLAMA SİSTEMİ**
BT HOLDER
DESIGNATION SYSTEM
BT HALTER
BEZEICHNUNGS SYSTEM

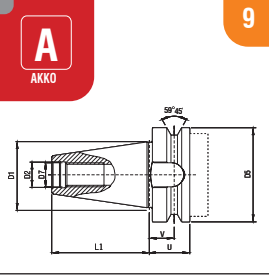

9

**BT VELDON ŞAFTLI
TAKIM TUTUCULAR**
BT END MILL HOLDER
BT FRÄSERAUFNAHMEN



10

JIS B 6339 (MAS 403 BT)

**BT ER SIKMA PENSLİ
TAKIM TUTUCULAR**
BT COLLET CHUCKS ER
BT HALTER
BT SPANNFUTTER ER



12

JIS B 6339 (MAS 403 BT)

**BT ER MİNİ SIKMA PENSLİ
TAKIM TUTUCULAR**
BT COLLET CHUCKS ER MINI
BT SPANNFUTTER ER MINI



13

JIS B 6339 (MAS 403 BT)

**BT YÜZEY FREZE
TAKIM TUTUCULAR**
BT SHELL MILL HOLDER
BT QUERNUT-AUFSTECKDORN



14

JIS B 6339 (MAS 403 BT)

BT MODÜLER PARMK FREZE TUTUCULAR
**BT MILLING CUTTER ARBORS FOR
SCREW-ON TYPE MILLING CUTTERS**
BT MODULARE SCHAFTFRÄSERHALTER



15

JIS B 6339 (MAS 403 BT)

BT KOMBİNE YÜZEY FREZE TUTUCULAR
BT COMBI SHELL MILL HOLDER
BT KOMBİNİERTE FLÄCHENFRÄSHALTER



16

JIS B 6339 (MAS 403 BT)

BT BLANK TUTUCULAR
BT BLANK HOLDERS
BT BLANK HALTER



17

AK-PLUS

**AK-PLUS TUTUCULAR
KODLAMA SİSTEMİ**
AK-PLUS HOLDER
DESIGNATION SYSTEM
AK-PLUS HALTER
BEZEICHNUNGS SYSTEM

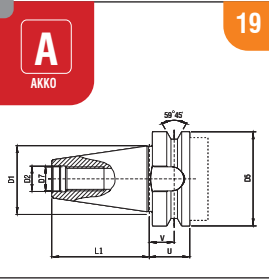

19

**AK-PLUS VELDON ŞAFTLI
TAKIM TUTUCULAR**
AK-PLUS END MILL HOLDER
AK-PLUS FRÄSERAUFNAHMEN



21

JIS B 6339 (MAS 403 BT)

**AK-PLUS ER SIKMA PENSLİ
TAKIM TUTUCULAR**
AK-PLUS COLLET CHUCKS ER
AK-PLUS SPANNFUTTER ER



23

JIS B 6339 (MAS 403 BT)

**AK-PLUS ER MİNİ SIKMA PENSLİ
TAKIM TUTUCULAR**
AK-PLUS COLLET CHUCKS ER MINI
AK-PLUS SPANNFUTTER ER MINI



24

JIS B 6339 (MAS 403 BT)

**AK-PLUS YÜZEY FREZE
TAKIM TUTUCULAR**
AK-PLUS SHELL MILL HOLDER
AK-PLUS QUERNUT-AUFSTECKDORN



25

JIS B 6339 (MAS 403 BT)

AK-PLUS MODÜLER PARMK FREZE TUTUCULAR
**AK-PLUS MILLING CUTTER ARBORS FOR
SCREW-ON TYPE MILLING CUTTERS**
AK-PLUS MODULARE SCHAFTFRÄSERHALTER



26

JIS B 6339 (MAS 403 BT)

AK-PLUS KOMBİNE YÜZEY FREZE TUTUCULAR
AK-PLUS COMBI SHELL MILL HOLDER
AK-PLUS KOMBİNİERTE FLÄCHENFRÄSHALTER



27

JIS B 6339 (MAS 403 BT)

**SK TUTUCULAR
KODLAMA SİSTEMİ**
SK HOLDER
DESIGNATION SYSTEM
SK HALTER
BEZEICHNUNGS SYSTEM

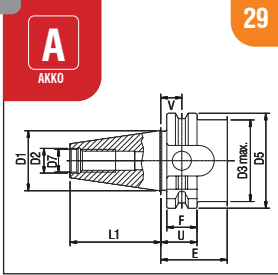

29

**SK VELDON ŞAFTLI
TAKIM TUTUCULAR**
SK END MILL HOLDER
SK FRÄSERAUFNAHMEN



30

DIN ISO 7388-1 (SK DIN 69871)

**SK ER SIKMA PENSLİ
TAKIM TUTUCULAR**
SK COLLET CHUCKS ER
SK SPANNFUTTER ER



31

DIN ISO 7388-1 (SK DIN 69871)

**SK YÜZEY FREZE
TAKIM TUTUCULAR**
SK SHELL MILL HOLDER
SK AUFSTECKFRÄSERDORNE



31

DIN ISO 7388-1 (SK DIN 69871)



Yenilikler için bizi takip edin!
Follow us for news!
Für Neuheiten bitte uns folgen

AKKO Metalworking Tools

www.akk.com.tr

SK

**HSK TUTUCULAR
KODLAMA SİSTEMİ**
HSK HOLDER
DESIGNATION SYSTEM
HSK HALTER
BEZEICHNUNGS SYSTEM

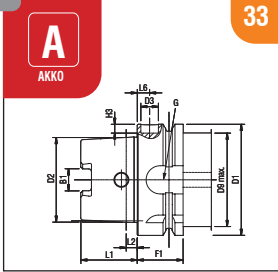

33

**HSK VELDON ŞAFTLI
TAKIM TUTUCULAR**
HSK END MILL HOLDER
HSK FRÄSERAUFNAHMEN



34

ISO 12164-1

**HSK ER SIKMA PENSLİ
TAKIM TUTUCULAR**
HSK COLLET CHUCKS ER
HSK SPANNFUTTER ER



36

ISO 12164-1

**HSK ER MİNİ SIKMA PENSLİ
TAKIM TUTUCULAR**
HSK COLLET CHUCKS ER MINI
HSK SPANNFUTTER ER MINI



37

ISO 12164-1

**HSK YÜZEY FREZE
TAKIM TUTUCULAR**
HSK SHELL MILL HOLDER
HSK AUFSTECKFRÄSERDORNE



38

ISO 12164-1

HSK MODÜLER PARMAK FREZE TUTUCULAR
HSK MILLING CUTTER ARBORS FOR
SCREW-ON TYPE MILLING CUTTERS
HSK MODULARE SCHAFTFRÄSERHALTER



39

ISO 12164-1

HSK KOMBİNE YÜZEY FREZE TUTUCULAR
HSK COMBI SHELL MILL HOLDER
HSK KOMBİNIERTE FLÄCHENFRÄSHALTER



40

ISO 12164-1

HSK BLANK TUTUCULAR
HSK BLANK HOLDERS
HSK BLANK HALTER



41

HSK

**POLİGONAL ŞAFTLI TUTUCULAR
KODLAMA SİSTEMİ**
**POLYGONAL SHANK HOLDER
DESIGNATION SYSTEM**
POLYGONSCHAFT HALTER
BEZEICHNUNGS SYSTEM

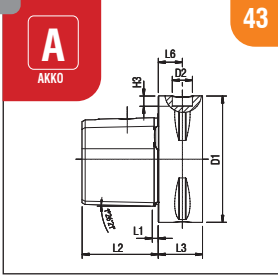

43

**POLİGONAL ŞAFTLI VELDON
TAKIM TUTUCULAR**
**POLYGONAL SHANK END
MILL HOLDER**
POLYGONSCHAFT
HALTER



44

ISO 26623-1

**POLİGONAL ŞAFTLI ER SIKMA
PENSLİ TAKIM TUTUCULAR**
**POLYGONAL SHANK COLLET
CHUCKS ER**
POLYGONSCHAFT HALTER
SPANNFUTTER ER



46

ISO 26623-1

**POLİGONAL ŞAFTLI ER MİNİ SIKMA
PENSLİ TAKIM TUTUCULAR**
**POLYGONAL SHANK COLLET
CHUCKS ER MINI**
POLYGONSCHAFT HALTER
SPANNFUTTER ER MINI



47

ISO 26623-1

**POLİGONAL ŞAFTLI YÜZEY FREZE
TAKIM TUTUCULAR**
**POLYGONAL SHANK SHELL
MILL HOLDER**
POLYGONSCHAFT HALTER
AUFSTECKFRÄ SERDORNE



48

ISO 26623-1

**POLİGONAL ŞAFTLI MODÜLER
PARMAK FREZE TUTUCULAR**
**POLYGONAL SHANK MILLING
CUTTER ARBORS FOR SCREW-ON
TYPE MILLING CUTTERS**
POLYGONSCHAFT MODULARE
SCHAFTFRÄSER HALTER



49

ISO 26623-1

**POLİGONAL ŞAFTLI KOMBİNE
YÜZEY FREZE TUTUCULAR**
**POLYGONAL SHANK COMBI
SHELL MILL HOLDER**
POLYGONSCHAFT HALTER
KOMBINIERTE FLÄCHENFRÄS



50

ISO 26623-1

**POLİGONAL ŞAFTLI DİKDÖRTGEN
SAPLI KATER TUTUCULAR**
**POLYGONAL SHANK
TOOLHOLDER AXIAL**
POLYGON SHANKWERKZEUG-
HALTER AXIAL



51

ISO 26623-1

**POLİGONAL ŞAFTLI UZATMA
ADAPTÖR TUTUCULAR**
**POLYGONAL SHANK EXTENSION
ADAPTER HOLDER**
POLYGONSCHAFT HALTER
SCHRUMPFVERLÄNGERUNGEN



52

ISO 26623-1

**POLİGONAL ŞAFTLI REDÜKSİYON
ADAPTÖR TUTUCULAR**
**POLYGONAL SHANK REDUCER
ADAPTER HOLDER**
REDUZIERADAPTERHALTER



52

POLİGONAL ŞAFTLI BLANK TUTUCULAR
**POLYGONAL SHANK
BLANK HOLDERS**
POLYGONSCHAFT
BLANK HALTER



53

MINI CUT TUTUCULAR
MINI CUT HOLDERS
MINI CUT HALTER



54

VİDALI TAKIM TUTUCULARI
SCREWED TOOL HOLDERS
AUFNAHME FÜR EINSCHRAUBFRÄSER



56

DÖNER BROŞ AÇMA TAKIMLARI
ROTARY BROACH TOOL HOLDER
HALTER FÜR ROTATIONSBRÄUMWERKZEUGE



56

YEDEK PARÇALAR
SPARE PARTS
ERSATZTEILE



57

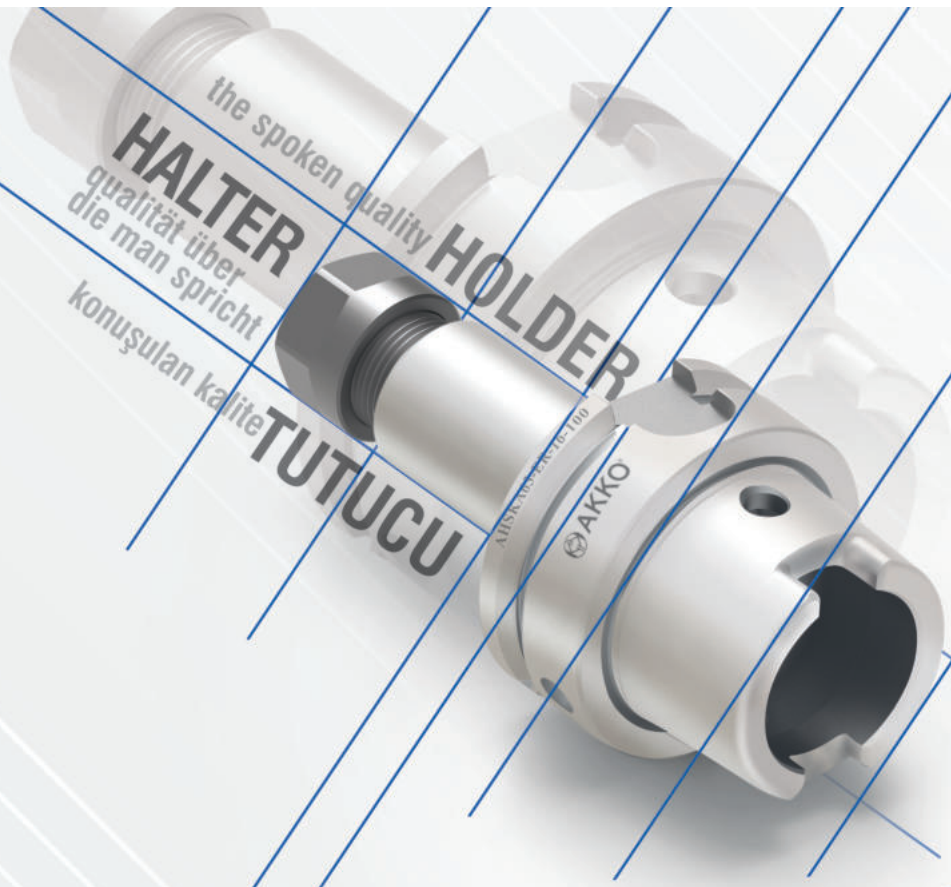

HALTER
the spoken quality
qualitat iber
die man spricht

HOLDER

TUTUCU
konuřulan kalite

THE
SPOKEN
QUALITY

www.akko.com.tr



BİLGİLENDİRME
THE INFORMATION
INFORMIEREN

■ Teknik izim ve fotoęraflar deęiřkenlik gsterebilir.
Illustrations shown may vary from actual product.
Das Produkt kann von dem gezeigten Bild abweichen.



BT TUTUCULAR

BT HOLDERS

BT HALTER



■ Teknik çizim ve fotoğraflar değişiklik gösterebilir.
Illustrations shown may vary from actual product.
Das Produkt kann von dem gezeigten Bild abweichen.



AKKO[®]

*konuşulan
the spoken kalite...
quality...*

www.akkо.com.tr

1	2	3	4	5
A	BT40	EM	06	080
AKKO	GÖVDE TİPİ / SHANK TYPE / KÖRPERTYP	FORMU / FORM / FORM	ÇAP / DIAMETER / DURCHMESSER	TUTUCU BOY / HOLDER SIZE / HALTER GRÖSSE

BT 30-40-50

- EM** : VELDON ŞAFTLI TAKIM TUTUCULAR / END MILL HOLDER / FRÄSERAUFNAHMEN
ER : ER SIKMA PENSLİ TAKIM TUTUCULAR / COLLET CHUCKS (ER) / SPANNFUTTER ER
FM : YÜZEY FREZE TAKIM TUTUCULAR / SHELL MILL HOLDERS / AUFSTECKFRÄSERDORNE
MM : MODÜLER PARMAK FREZE TUTUCULAR / MILLING CUTTER ARBORS FOR SCREW-ON TYPE MILLING CUTTERS / MODULARE SCHAFTFRÄSERHALTER
FMC : KOMBİNE YÜZEY FREZE TAKIM TUTUCULARI / COMBI SHELL MILL HOLDER / KOMBİNIERTE FLÄCHENFRÄSHALTER
BL41 : BLANK TUTUCULAR / BLANK HOLDERS / BLANK HALTER



KALİTE KONTROL

QUALITY CONTROL

QUALITÄTSKONTROLLE

BT 40 BT 30-40-50

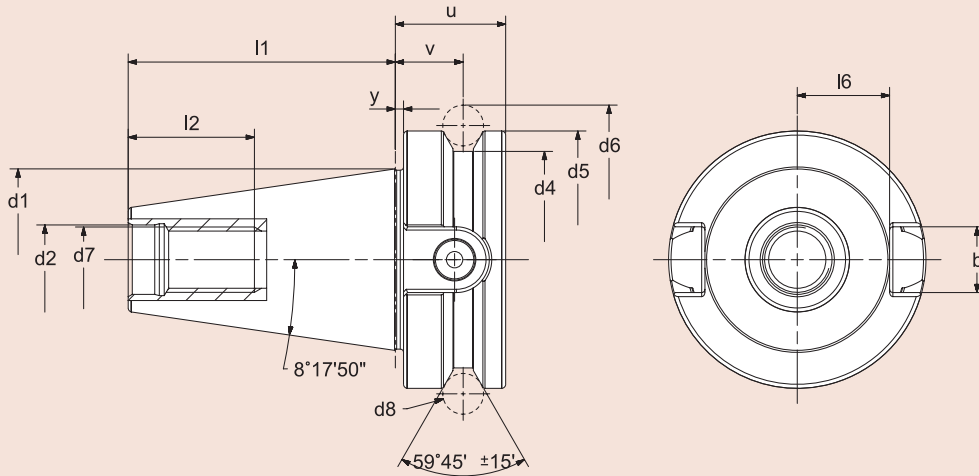

Tasarım:

- Konik açısı: 8° 17' 50" + 4"
- Takım tutucular, yüzeyi sertleştirilmiş 58 ± 2 HRC
- Çekirdekte çekme dayanımı en az 950 N/mm²
- AT3 tolerans kalitesinde koniklik
- Dahili veri çipi için çap Ø 10 mm

Design:

- Angle of cone: 8° 17' 50" + 4"
- Tool holders case-hardened 58 ± 2 HRC
- Tensile strength in the core at least 950 N/mm²
- Taper in tolerance quality AT3
- Incl. bore for data chip Ø 10 mm

Ausführung:

- Kegelwinkel: 8° 17' 50" + 4"
- Aufnahmen einsatzgehärtet 58 ± 2 HRC
- Zugfestigkeit im Kern mindestens 950 N/mm²
- Steilkegel in Kegelwinkel-Toleranzqualität AT3
- Inkl. Codeträgerbohrung Ø 10 mm

BT	d1	d2 H8	d4 0.0 -0.05	d5 h8	d6 ±0.05	d7 6H	d8	u min.	v ±0.1	y ±0.4	l1 ±0.1	l2 min.	l6 0.0 -0.2	b 0.2 0.0
30	31.75	12.5	38	46	56.144	M12x1.75	8	22	13.6	2	48.4	24	16.3	16.1
40	44.45	17	53	63	75.679	M16x2	10	27	16.6	2	65.4	30	22.6	16.1
50	69.85	25	85	100	119.020	M24x3	15	38	23.2	3	101.8	45	35.4	25.7

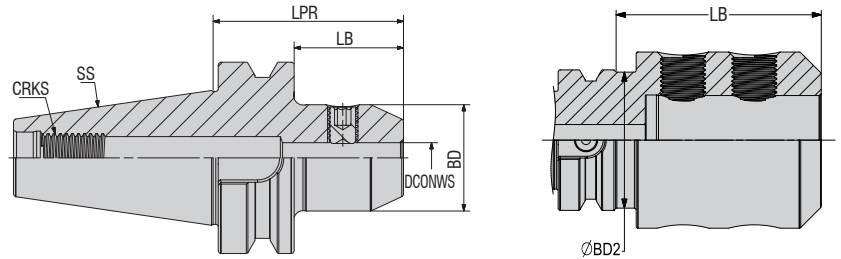

Illustrations shown may vary from actual product.



Sipariş Kodu Ordering Code Bestell-Bezeichnung	Stok Stock Lager	Tutucu Ölçüleri (mm) / Dimension (mm) / Abmessung (mm)							
		SS	DCONWS	LPR	BD	BD2	LB	CRKS	KG
ABT30-EM-06-050	●	30	06	50	25	-	28	M12	0.460
ABT30-EM-08-050	○	30	08	50	28	-	28	M12	0.490
ABT30-EM-10-050	○	30	10	50	35	-	28	M12	0.540
ABT30-EM-12-050	○	30	12	50	42	-	28	M12	0.600
ABT30-EM-14-050	○	30	14	50	44	-	28	M12	0.610
ABT30-EM-16-065	○	30	16	65	48	-	43	M12	0.900
ABT30-EM-18-065	○	30	18	65	50	45	43	M12	0.880
ABT40-EM-06-050	○	40	06	50	25	-	23	M16	1.030
ABT40-EM-06-100	○	40	06	100	25	-	73	M16	1.200
ABT40-EM-06-160	●	40	06	160	25	-	133	M16	1.440
ABT40-EM-08-050	○	40	08	50	28	-	23	M16	1.050
ABT40-EM-08-100	○	40	08	100	28	-	73	M16	1.270
ABT40-EM-08-160	●	40	08	160	28	-	133	M16	1.570
ABT40-EM-10-063	○	40	10	63	35	-	36	M16	1.170
ABT40-EM-10-100	○	40	10	100	35	-	73	M16	1.410
ABT40-EM-10-160	●	40	10	160	35	-	133	M16	1.860
ABT40-EM-12-063	○	40	12	63	42	-	36	M16	1.260
ABT40-EM-12-100	●	40	12	100	42	-	73	M16	1.620
ABT40-EM-12-160	●	40	12	160	42	-	133	M16	2.280
ABT40-EM-14-063	○	40	14	63	44	-	36	M16	1.300
ABT40-EM-14-100	○	40	14	100	44	-	73	M16	1.680
ABT40-EM-14-160	○	40	14	160	44	-	133	M16	2.400
ABT40-EM-16-063	●	40	16	63	48	-	36	M16	1.330
ABT40-EM-16-100	●	40	16	100	48	-	73	M16	1.820
ABT40-EM-16-160	○	40	16	160	48	-	133	M16	2.680
ABT40-EM-18-065	○	40	18	65	50	-	38	M16	1.380
ABT40-EM-18-100	●	40	18	100	50	-	73	M16	1.880
ABT40-EM-18-160	○	40	18	160	50	-	133	M16	2.610
ABT40-EM-20-063	○	40	20	63	52	-	36	M16	1.650
ABT40-EM-20-100	●	40	20	100	52	-	73	M16	1.940
ABT40-EM-20-160	○	40	20	160	52	-	133	M16	2.950
ABT40-EM-25-090	●	40	25	90	63	61	63	M16	2.110
ABT40-EM-25-130	○	40	25	130	63	61	103	M16	3.060
ABT40-EM-25-160	○	40	25	160	63	61	133	M16	3.760
ABT40-EM-32-100	●	40	32	100	72	61	73	M16	2.640
ABT40-EM-32-130	○	40	32	130	72	61	103	M16	3.560
ABT40-EM-32-160	○	40	32	160	72	61	133	M16	4.480
ABT40-EM-40-120	○	40	40	120	79	61	93	M16	3.480

Yedek Parça / Spare Part / Ersatzteile

Sipariş Örneği/Ordering Example/Bestellbeispiel
 1 ad./pcs./stück ABT30-EM-06-050



Veldon Sıkma Civatası DIN 1835 B
 Clamping Screw Weldon DIN 1835 B
 Weldon-Klemmschraube DIN 1835 B



Çektirme Civatası
 Pull Stud
 Anzugsbolzen

● Stokta / In Stock / Auf Lager ○ Stokta Yok / Non Stock Item / Kein Lagerartikel, Lieferzeit auf Anfrage

Siparişe Dahil / Delivered with / In der Bestellung enthalten Siparişe Dahil Değil / Delivered without / Nicht in der Bestellung enthalten

Daha fazla bilgi için, 57-67. sayfalara bakabilirsiniz. / For more info, you can check pages between 57-67. / Weitere Informationen finden Sie auf den Seiten 57-67.

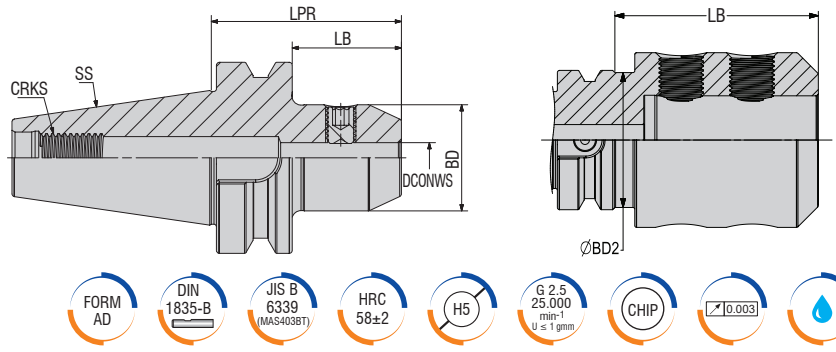

Sipariş Kodu Ordering Code Bestell-Bezeichnung	Stok Stock Lager	Tutucu Ölçüleri (mm) / Dimension (mm) / Abmessung (mm)							
		SS	DCONWS	LPR	BD	BD2	LB	CRKS	KG
ABT50-EM-06-070	○	50	06	70	25	-	32	M24	3.680
ABT50-EM-06-100	○	50	06	100	25	-	62	M24	3.830
ABT50-EM-06-160	○	50	06	160	25	-	122	M24	4.050
ABT50-EM-08-070	○	50	08	70	28	-	32	M24	3.580
ABT50-EM-08-100	○	50	08	100	28	-	62	M24	3.880
ABT50-EM-08-160	○	50	08	160	28	-	122	M24	4.170
ABT50-EM-10-070	○	50	10	70	35	-	32	M24	3.680
ABT50-EM-10-100	○	50	10	100	35	-	62	M24	3.990
ABT50-EM-10-160	○	50	10	160	35	-	122	M24	4.420
ABT50-EM-12-080	○	50	12	80	42	-	42	M24	3.970
ABT50-EM-12-100	○	50	12	100	42	-	62	M24	4.170
ABT50-EM-12-160	●	50	12	160	42	-	122	M24	4.800
ABT50-EM-14-080	○	50	14	80	44	-	42	M24	3.990
ABT50-EM-14-100	●	50	14	100	44	-	62	M24	4.200
ABT50-EM-14-160	●	50	14	160	44	-	122	M24	4.910
ABT50-EM-16-080	○	50	16	80	48	-	42	M24	4.060
ABT50-EM-16-100	○	50	16	100	48	-	62	M24	4.330
ABT50-EM-16-160	○	50	16	160	48	-	122	M24	5.160
ABT50-EM-18-100	○	50	18	100	50	-	62	M24	4.380
ABT50-EM-18-160	○	50	18	160	50	-	122	M24	5.280
ABT50-EM-20-100	●	50	20	100	52	-	62	M24	4.420
ABT50-EM-20-160	○	50	20	160	52	-	122	M24	5.400
ABT50-EM-25-100	○	50	25	100	63	-	62	M24	4.760
ABT50-EM-25-160	○	50	25	160	63	-	122	M24	6.220
ABT50-EM-32-105	●	50	32	105	72	-	67	M24	5.180
ABT50-EM-32-160	○	50	32	160	72	-	122	M24	6.890
ABT50-EM-40-110	●	50	40	110	80	-	72	M24	5.490
ABT50-EM-40-160	●	50	40	160	80	-	122	M24	7.420

Yedek Parça / Spare Part / Ersatzteile

Veldon Sıkma Civatası DIN 1835 B
Clamping Screw Weldon DIN 1835 B
Weldon-Klemmschraube DIN 1835 B

Siparişe Dahil / Delivered with / In der Bestellung enthalten

Çektirme Civatası
Pull Stud
Anzugsbolzen

Siparişe Dahil Değil / Delivered without / Nicht in der Bestellung enthalten

Sipariş Örneği/Ordering Example/Bestellbeispiel

1 ad./pcs./stück ABT50-EM-06-070

● Stokta / In Stock / Auf Lager ○ Stokta Yok / Non Stock Item / Kein Lagerartikel, Lieferzeit auf Anfrage

Daha fazla bilgi için, 57-67. sayfalara bakabilirsiniz. / For more info, you can check pages between 57-67. / Weitere Informationen finden Sie auf den Seiten 57-67.



Illustrations shown may vary from actual product.

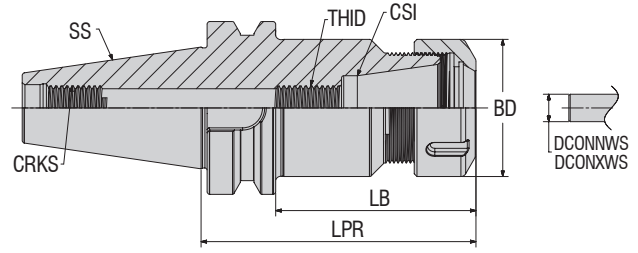

Sipariş Kodu Ordering Code Bestell-Bezeichnung	Stok Stock Lager	Tutucu Ölçüleri (mm) / Dimension (mm) / Abmessung (mm)									
		SS	CSI	DCONNWS	DCONXWS	BD	LPR	LB	THID	CRKS	KG
ABT30-ER-16-060	○	30	ER16	0.5	10	28	60	33	M10	M12	0.500
ABT30-ER-16-100	○	30	ER16	0.5	10	28	100	73	M10	M12	0.670
ABT30-ER-25-060	○	30	ER25	1.0	16	42	60	33	M16	M12	0.610
ABT30-ER-25-100	○	30	ER25	1.0	16	42	100	73	M16	M12	0.970
ABT40-ER-16-063	○	40	ER16	0.5	10	28	63	36	M10	M16	1.060
ABT40-ER-16-100	●	40	ER16	0.5	10	28	100	73	M10	M16	1.210
ABT40-ER-16-130	○	40	ER16	0.5	10	28	130	103	M10	M16	1.330
ABT40-ER-25-060	●	40	ER25	1.0	16	42	60	33	M16	M16	1.090
ABT40-ER-25-100	○	40	ER25	1.0	16	42	100	73	M16	M16	1.490
ABT40-ER-25-130	○	40	ER25	1.0	16	42	130	103	M16	M16	1.800
ABT40-ER-32-070	●	40	ER32	2.0	20	50	70	43	M16	M16	1.250
ABT40-ER-32-100	●	40	ER32	2.0	20	50	100	73	M16	M16	1.680
ABT40-ER-32-160	●	40	ER32	2.0	20	50	160	133	M16	M16	2.580
ABT40-ER-40-080	●	40	ER40	3.0	26	63	80	53	M16	M16	1.610
ABT40-ER-40-100	●	40	ER40	3.0	26	63	100	73	M16	M16	2.080
ABT40-ER-40-160	○	40	ER40	3.0	26	63	160	133	M16	M16	3.480
ABT50-ER-16-070	○	50	ER16	0.5	10	28	70	43	M10	M24	3.690
ABT50-ER-16-100	●	50	ER16	0.5	10	28	100	73	M10	M24	3.810
ABT50-ER-16-160	○	50	ER16	0.5	10	28	160	133	M10	M24	4.100
ABT50-ER-25-070	●	50	ER25	1.0	16	42	70	43	M16	M24	3.730
ABT50-ER-25-100	○	50	ER25	1.0	16	42	100	73	M16	M24	4.030
ABT50-ER-25-130	○	50	ER25	1.0	16	42	130	103	M16	M24	4.330
ABT50-ER-25-160	○	50	ER25	1.0	16	42	160	133	M16	M24	4.700
ABT50-ER-32-070	●	50	ER32	2.0	20	50	70	43	M16	M24	3.750
ABT50-ER-32-100	○	50	ER32	2.0	20	50	100	73	M16	M24	4.170
ABT50-ER-32-130	○	50	ER32	2.0	20	50	130	103	M16	M24	4.610
ABT50-ER-32-160	●	50	ER32	2.0	20	50	160	133	M16	M24	5.120
ABT50-ER-40-080	●	50	ER40	3.0	26	63	80	53	M16	M24	4.000
ABT50-ER-40-100	●	50	ER40	3.0	26	63	100	73	M16	M24	4.490
ABT50-ER-40-160	●	50	ER40	3.0	26	63	160	133	M16	M24	5.990

Yedek Parça / Spare Part / Ersatzteile



Siparişe Dahil / Delivered with / In der Bestellung enthalten

Siparişe Dahil Değil / Delivered without / Nicht in der Bestellung enthalten

Daha fazla bilgi için, 57-67. sayfalara bakabilirsiniz. / For more info, you can check pages between 57-67. / Weitere Informationen finden Sie auf den Seiten 57-67.

Sipariş Örneği/Ordering Example/Bestellbeispiel
 1 ad./pcs./stück ABT30-ER-16-060

● Stokta / In Stock / Auf Lager ○ Stokta Yok / Non Stock Item / Kein Lagerartikel, Lieferzeit auf Anfrage

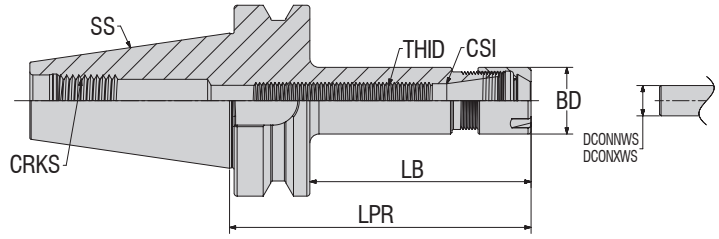

Illustrations shown may vary from actual product.



Sipariş Kodu Ordering Code Bestell-Bezeichnung	Stok Stock Lager	Tutucu Ölçüleri (mm) / Dimension (mm) / Abmessung (mm)									
		SS	CSI	DCONNWS	DCONXWS	BD	LPR	LB	THID	CRKS	KG
ABT40-ER-16-100-M	○	40	ER16	0.5	10	22	100	73	M10	M16	1.110
ABT40-ER-16-130-M	○	40	ER16	0.5	10	22	130	103	M10	M16	1.190
ABT50-ER-16-100-M	●	50	ER16	0.5	10	22	100	62	M10	M24	3.730
ABT50-ER-16-130-M	●	50	ER16	0.5	10	22	130	92	M10	M10	3.810
ABT50-ER-16-160-M	○	50	ER16	0.5	10	22	160	122	M10	M10	3.930

Yedek Parça / Spare Part / Ersatzteile



Pens Kapağı
Clamping Nuts
Spannmutter



ER Tipi Anahtar
Wrench ER
Spannschlüssel ER



Pensler ER DIN6499/ISO 15488-B
Collet Chuck ER DIN6499/ISO 15488-B
Spannschlüssel ER DIN6499/ISO 15488-B



Çekirme Civatası
Pull Stud
Anzugsbolzen

Siparişe Dahil / Delivered with / In der Bestellung enthalten

Siparişe Dahil Değil / Delivered without / Nicht in der Bestellung enthalten

Sipariş Örneği/Ordering Example/Bestellbeispiel
1 ad./pcs./stück ABT40-ER-16-100-M

Daha fazla bilgi için, 57-67. sayfalara bakabilirsiniz. / For more info, you can check pages between 57-67. / Weitere Informationen finden Sie auf den Seiten 57-67.

Daha fazla bilgi için, 57-67. sayfalara bakabilirsiniz.
For more info, you can check pages between 57-67.
Weitere Informationen finden Sie auf den Seiten 57-67.

● Stokta / In Stock / Auf Lager ○ Stokta Yok / Non Stock Item / Kein Lagerartikel, Lieferzeit auf Anfrage



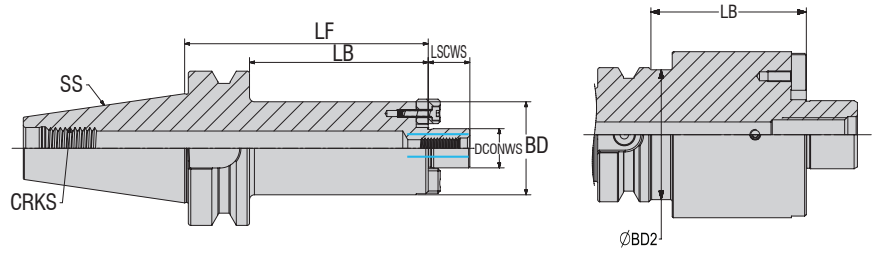

Illustrations shown may vary from actual product.

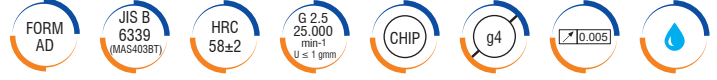

Sipariş Kodu Ordering Code Bestell-Bezeichnung	Stok Stock Lager	Tutucu Ölçüleri (mm) / Dimension (mm) / Abmessung (mm)								
		SS	DCONNWS	LF	BD	BD2	LSCWS	LB	CRKS	KG
ABT30-FM-16-040	●	30	16	40	38	-	17	18	M12	0.580
ABT30-FM-22-040	●	30	22	40	48	45	19	18	M12	0.700
ABT30-FM-27-050	○	30	27	50	60	45	21.5	28	M12	1.060
ABT30-FM-32-050	○	30	32	50	78	45	24	28	M12	1.460
ABT40-FM-16-055	○	40	16	55	38	-	17	28	M16	1.380
ABT40-FM-16-100	○	40	16	100	38	-	17	73	M16	1.670
ABT40-FM-22-040	●	40	22	40	48	-	19	13	M16	1.250
ABT40-FM-22-055	○	40	22	55	48	-	19	28	M16	1.810
ABT40-FM-22-100	○	40	22	100	48	-	19	73	M16	2.100
ABT40-FM-27-055	○	40	27	55	60	-	21.5	28	M16	2.440
ABT40-FM-27-100	●	40	27	100	60	-	21.5	73	M16	2.730
ABT40-FM-32-050	●	40	32	50	78	61	24	23	M16	1.930
ABT40-FM-32-060	○	40	32	60	78	61	24	33	M16	3.500
ABT40-FM-32-100	○	40	32	100	78	61	24	73	M16	3.790
ABT40-FM-40-050	○	40	40	50	88	54	27	23	M16	2.130
ABT40-FM-40-060	○	40	40	60	88	54	27	33	M16	2.250
ABT40-FM-40-100	○	40	40	100	88	54	27	73	M16	4.180
ABT50-FM-16-050	○	50	16	50	38	-	17	12	M24	3.800
ABT50-FM-16-055	○	50	16	55	38	-	17	17	M24	3.850
ABT50-FM-16-100	○	50	16	100	38	-	17	62	M24	4.250
ABT50-FM-16-160	○	50	16	160	38	-	17	122	M24	4.860
ABT50-FM-22-055	●	50	22	55	48	-	19	17	M24	3.980
ABT50-FM-22-100	●	50	22	100	48	-	19	62	M24	4.610
ABT50-FM-22-160	○	50	22	160	48	-	19	122	M24	5.570
ABT50-FM-27-055	○	50	27	55	60	-	21.5	17	M24	4.170
ABT50-FM-27-100	●	50	27	100	60	-	21.5	62	M24	5.170
ABT50-FM-27-160	○	50	27	160	60	-	21.5	122	M24	6.630
ABT50-FM-32-100	●	50	32	100	78	-	24	62	M24	6.200
ABT50-FM-32-160	○	50	32	160	78	-	24	122	M24	8.610
ABT50-FM-40-100	●	50	40	100	88	-	27	62	M24	6.910
ABT50-FM-40-160	●	50	40	160	88	-	27	122	M24	9.970
ABT50-FM-60-080	○	50	60	80	128	80	40	42	M24	8.020

Yedek Parça / Spare Part / Ersatzteile



Tarama Başlık Sıkma Cıvatası DIN 6367
 Bolt For Shell Arbor DIN 6367
 Scankopf-Klemmschraube DIN 6367



Alın Kamalı Malafa Kaması
 Drive Key
 Mitnehmersteine Mit Schraube



Tarama Başlık Cıvatası Sıkma Anahtarı DIN 6368
 Wrench For Shell Arbor DIN 6368
 Spannschlüssel DIN 6368 für Aufsteckdorne



Çektirme Cıvatası
 Pull Stud
 Anzugsbolzen

Siparişe Dahil / Delivered with / In der Bestellung enthalten

Siparişe Dahil Değil / Delivered without / Nicht in der Bestellung enthalten

Daha fazla bilgi için, 57-67. sayfalara bakabilirsiniz. / For more info, you can check pages between 57-67. /
 Weitere Informationen finden Sie auf den Seiten 57-67.

Sipariş Örneği/Ordering Example/Bestellbeispiel
 1 ad./pcs./stück ABT30-FM-16-040

● Stokta / In Stock / Auf Lager ○ Stokta Yok / Non Stock Item / Kein Lagerartikel, Lieferzeit auf Anfrage

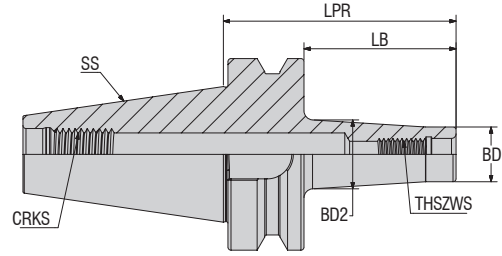

Illustrations shown may vary from actual product.

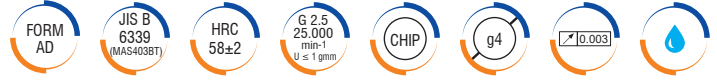

Sipariş Kodu Ordering Code Bestell-Bezeichnung	Stok Stock Lager	Tutucu Ölçüleri (mm) / Dimension (mm) / Abmessung (mm)							
		SS	THSZW	BD	BD2	LPR	LB	CRKS	KG
ABT40-MM-06-052	○	40	M6	10	13	52	25	M16	0.960
ABT40-MM-06-077	○	40	M6	10	19.5	77	50	M16	1.000
ABT40-MM-06-102	○	40	M6	10	22.5	102	75	M16	1.050
ABT40-MM-08-052	○	40	M8	13	15	52	25	M16	0.960
ABT40-MM-08-077	○	40	M8	13	22.5	77	50	M16	1.020
ABT40-MM-08-102	●	40	M8	13	23	102	75	M16	1.070
ABT40-MM-08-127	●	40	M8	13	25	127	100	M16	1.140
ABT40-MM-10-052	○	40	M10	18	20	52	25	M16	0.980
ABT40-MM-10-077	○	40	M10	18	23	77	50	M16	1.050
ABT40-MM-10-102	○	40	M10	18	28	102	75	M16	1.160
ABT40-MM-10-127	○	40	M10	18	32	127	100	M16	1.290
ABT40-MM-12-052	●	40	M12	21	24	52	25	M16	1.000
ABT40-MM-12-077	●	40	M12	21	24	77	50	M16	1.060
ABT40-MM-12-102	●	40	M12	21	31	102	75	M16	1.210
ABT40-MM-12-127	○	40	M12	21	32.5	127	100	M16	1.350
ABT40-MM-12-177	○	40	M12	21	39.5	177	150	M16	1.760
ABT40-MM-16-052	●	40	M16	29	-	52	25	M16	1.030
ABT40-MM-16-077	○	40	M16	29	34	77	50	M16	1.180
ABT40-MM-16-102	○	40	M16	29	34	102	75	M16	1.330
ABT40-MM-16-127	○	40	M16	29	36	127	100	M16	1.520
ABT40-MM-16-152	○	40	M16	29	40	152	125	M16	1.780
ABT40-MM-16-177	○	40	M16	29	42.5	177	150	M16	2.040
ABT50-MM-08-088	○	50	M8	13	22.4	88	50	M24	3.660
ABT50-MM-08-138	○	50	M8	13	24.5	138	100	M24	3.780
ABT50-MM-08-188	○	50	M8	13	29.5	188	150	M24	3.970
ABT50-MM-10-088	○	50	M10	18	23	88	50	M24	3.680
ABT50-MM-10-138	○	50	M10	18	31.5	138	100	M24	3.920
ABT50-MM-10-188	○	50	M10	18	36	188	150	M24	4.150
ABT50-MM-12-088	○	50	M12	21	24	88	50	M24	3.700
ABT50-MM-12-138	○	50	M12	21	32.5	138	100	M24	3.970
ABT50-MM-12-188	○	50	M12	21	39.5	188	150	M24	4.380
ABT50-MM-16-088	○	50	M16	29	34	88	50	M24	3.820
ABT50-MM-16-138	○	50	M16	29	36	138	100	M24	4.150
ABT50-MM-16-188	○	50	M16	29	42.5	188	150	M24	4.660

Yedek Parça / Spare Part / Ersatzteile



Çektirme Civatası
Pull Stud
Anzugsbolzen

Siparişe Dahil Değil /
Delivered without /
Nicht in der Bestellung enthalten

Sipariş Örneği/Ordering Example/Bestellbeispiel
1 ad./pcs./stück ABT40-MM-06-052

● Stokta / In Stock / Auf Lager ○ Stokta Yok / Non Stock Item / Kein Lagerartikel, Lieferzeit auf Anfrage

Daha fazla bilgi için, 57-67. sayfalara bakabilirsiniz. / For more info, you can check pages between 57-67. / Weitere Informationen finden Sie auf den Seiten 57-67.

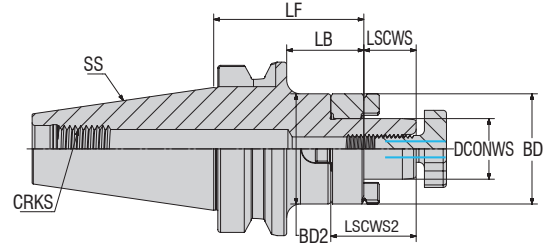

Sipariş Kodu Ordering Code Bestell-Bezeichnung	Stok Stock Lager	Tutucu Ölçüleri (mm) / Dimension (mm) / Abmessung (mm)									
		SS	DCONWS	LF	BD	BD2	LSCWS	LSCWS2	LB	CRKS	KG
ABT30-FMC-16-045	○	30	16	45	32	-	17	27	23	M12	0.560
ABT30-FMC-22-047	○	30	22	47	40	-	19	31	25	M12	0.700
ABT30-FMC-27-049	○	30	27	49	48	-	21	33.5	27	M12	0.870
ABT30-FMC-32-052	○	30	32	52	58	-	24	38	30	M12	1.120
ABT40-FMC-16-055	○	40	16	55	32	-	17	27	28	M16	1.170
ABT40-FMC-16-100	○	40	16	100	32	-	17	27	73	M16	1.430
ABT40-FMC-16-130	○	40	16	130	32	-	17	27	103	M16	1.610
ABT40-FMC-16-160	○	40	16	160	32	38	17	27	133	M16	1.870
ABT40-FMC-22-055	○	40	22	55	40	-	19	31	28	M16	1.280
ABT40-FMC-22-100	●	40	22	100	40	-	19	31	73	M16	1.680
ABT40-FMC-22-130	○	40	22	130	40	-	19	31	103	M16	1.950
ABT40-FMC-22-160	●	40	22	160	40	46.5	19	31	133	M16	2.330
ABT40-FMC-27-055	○	40	27	55	48	-	21	33.5	28	M16	1.440
ABT40-FMC-27-100	○	40	27	100	48	-	21	33.5	73	M16	2.040
ABT40-FMC-27-130	○	40	27	130	48	-	21	33.5	103	M16	2.440
ABT40-FMC-27-160	○	40	27	160	48	55	21	33.5	133	M16	2.980
ABT40-FMC-32-060	○	40	32	60	58	-	24	38	33	M16	1.800
ABT40-FMC-32-100	○	40	32	100	58	-	24	38	73	M16	2.590
ABT40-FMC-32-130	○	40	32	130	58	-	24	38	103	M16	3.180
ABT40-FMC-32-160	○	40	32	160	58	-	24	38	133	M16	3.770
ABT40-FMC-40-060	●	40	40	60	70	-	27	41	33	M16	2.190
ABT50-FMC-16-070	○	50	16	70	32	-	17	27	32	M24	3.850
ABT50-FMC-16-100	○	50	16	100	32	-	17	27	62	M24	4.030
ABT50-FMC-16-130	○	50	16	130	32	-	17	27	92	M24	4.200
ABT50-FMC-16-160	○	50	16	160	32	37	17	27	122	M24	4.430
ABT50-FMC-22-070	●	50	22	70	40	-	19	31	32	M24	3.970
ABT50-FMC-22-100	○	50	22	100	40	-	19	31	62	M24	4.230
ABT50-FMC-22-130	○	50	22	130	40	-	19	31	92	M24	4.500
ABT50-FMC-22-160	○	50	22	160	40	45.5	19	31	122	M24	4.840
ABT50-FMC-27-070	○	50	27	70	48	-	21	33.5	32	M24	4.150
ABT50-FMC-27-100	○	50	27	100	48	-	21	33.5	62	M24	4.550
ABT50-FMC-27-130	○	50	27	130	48	-	21	33.5	92	M24	4.950
ABT50-FMC-27-160	○	50	27	160	48	53.5	21	33.5	122	M24	5.440
ABT50-FMC-32-070	○	50	32	70	58	-	24	38	32	M24	4.430
ABT50-FMC-32-100	○	50	32	100	58	-	24	38	62	M24	5.030
ABT50-FMC-32-130	○	50	32	130	58	-	24	38	92	M24	5.620
ABT50-FMC-32-160	○	50	32	160	58	64	24	38	122	M24	6.340
ABT50-FMC-40-070	○	50	40	70	70	-	27	41	32	M24	4.880
ABT50-FMC-40-100	○	50	40	100	70	-	27	41	62	M24	5.760
ABT50-FMC-40-130	○	50	40	130	70	-	27	41	92	M24	6.640
ABT50-FMC-40-160	○	50	40	160	70	76	27	41	122	M24	7.680

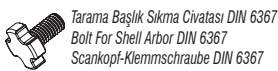

Siparişe Dahil / Delivered with / In der Bestellung enthalten

Siparişe Dahil Değil / Delivered without / Nicht in der Bestellung enthalten

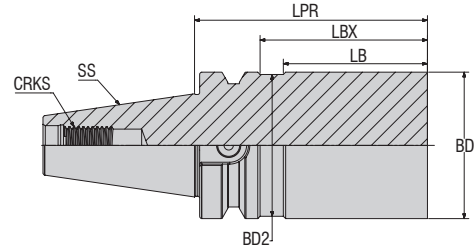

Illustrations shown may vary from actual product.



Sipariş Kodu Ordering Code Bestell-Bezeichnung	Stok Stock Lager	Tutucu Ölçüleri (mm) / Dimension (mm) / Abmessung (mm)							
		SS	BD	BD2	LPR	LBX	LB	CRKS	KG
ABT40-BL41-63-250	●	40	63	61	250	223	213	M16	6.380
ABT50-BL41-97-315	●	50	97	-	315	277	-	M24	19.610

Yedek Parça / Spare Part / Ersatzteile



Çektirme Civatası
Pull Stud
Anzugsbolzen

Siparişe Dahil Değil /
Delivered without /
Nicht in der Bestellung enthalten

Sipariş Örneği/Ordering Example/Bestellbeispiel
1 ad./pcs./stück ABT40-BL41-63-250

Daha fazla bilgi için, 57-67. sayfalara bakabilirsiniz. / For more info, you can check pages between 57-67. /
Weitere Informationen finden Sie auf den Seiten 57-67.

● Stokta / In Stock / Auf Lager ○ Stokta Yok / Non Stock Item / Kein Lagerartikel, Lieferzeit auf Anfrage



AK-PLUS TUTUCULAR

AK-PLUS HOLDERS

AK-PLUS HALTER



■ Teknik çizim ve fotoğraflar değişiklik gösterebilir.
Illustrations shown may vary from actual product.
Das Produkt kann von dem gezeigten Bild abweichen.



AKKO[®]

*konuşulan
the spoken kalite...
quality...*

www.akko.com.tr

1	2	3	4	5
A	BBT40	EM	06	080
AKKO	GÖVDE TİPİ / SHANK TYPE / KÖRPERTYP	FORMU / FORM / FORM	ÇAP / DIAMETER / DURCHMESSER	TUTUCU BOY / HOLDER SIZE / HALTER GRÖSSE

AK-PLUS 30-40-50

- EM : VELDON ŞAFTLI TAKIM TUTUCULAR / END MILL HOLDER / FRÄSERAUFNAHMEN
 ER : ER SIKMA PENSİLİ TAKIM TUTUCULAR / COLLET CHUCKS (ER) / SPANNFUTTER ER
 FM : YÜZEY FREZE TAKIM TUTUCULAR / SHELL MILL HOLDERS / AUFSTECKFRÄSERDORNE
 MM : MODÜLER PARMAK FREZE TUTUCULAR / MILLING CUTTER ARBORS FOR SCREW-ON TYPE MILLING CUTTERS / MODULARE SCHAFTFRÄSERHALTER
 FMC : KOMBİNE YÜZEY FREZE TAKIM TUTUCULARI / COMBI SHELL MILL HOLDER / KOMBİNIERTE FLÄCHENFRÄSHALTER



KALİTE KONTROL

QUALITY CONTROL

QUALITÄTSKONTROLLE

AK-PLUS AK-PLUS 30-40-50

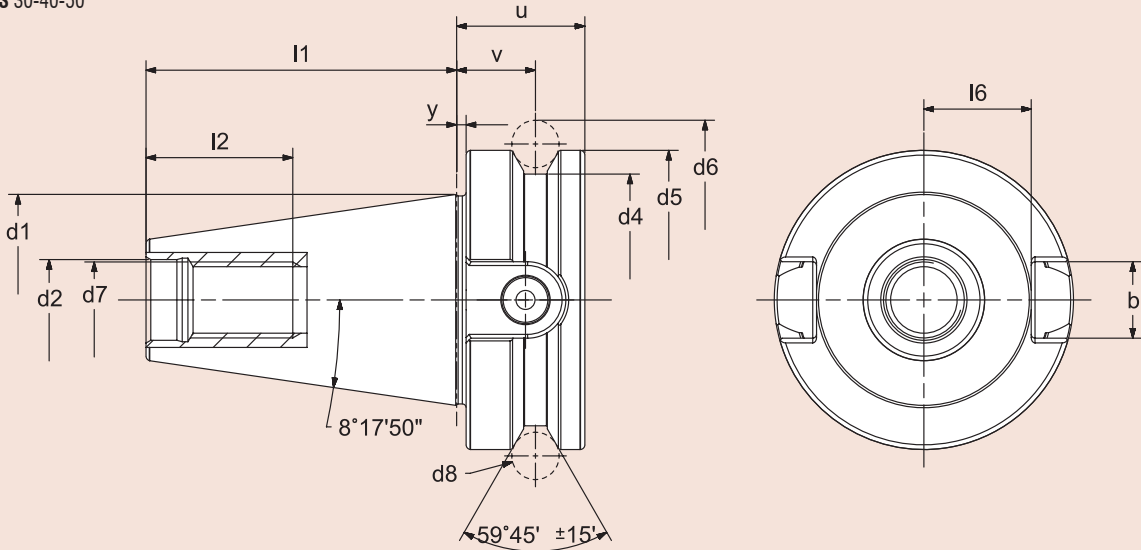

Tasarım:

- Konik açısı: 8° 17'50" + 4"
- Takım tutucular, yüzeyi sertleştirilmiş 58 ± 2 HRC
- Çekirdekte çekme dayanımı en az 950 N/mm²
- AT3 tolerans kalitesinde koniklik
- Dahili veri çipi için çap Ø 10 mm

Design:

- Angle of cone: 8° 17'50" + 4"
- Tool holders case-hardened 58 ± 2 HRC
- Tensile strength in the core at least 950 N/mm²
- Taper in tolerance quality AT3
- Incl. bore for data chip Ø 10 mm

Ausführung:

- Kegelwinkel: 8° 17'50" + 4"
- Aufnahmen einsatzgehärtet 58 ± 2 HRC
- Zugfestigkeit im Kern mindestens 950 N/mm²
- Steilkegel in Kegelwinkel-Toleranzqualität AT3
- Inkl. Codeträgerbohrung Ø 10 mm

AK-PLUS	d1	d2 H8	d4 0.0 -0.05	d5 h8	d6 ±0.05	d7 6H	d8	u min.	v ±0.1	y ±0.005	l1 ±0.1	l2 min.	l6 0.0 -0.2	b 0.2 0.0
30	31.75	12.5	38	46	56.144	M12x1.75	8	22	13.6	1	48.4	24	16.3	16.1
40	44.45	17	53	63	75.679	M16x2	10	27	16.6	1	65.4	30	22.6	16.1
50	69.85	25	85	100	119.020	M24x3	15	38	23.2	1.5	101.8	45	35.4	25.7

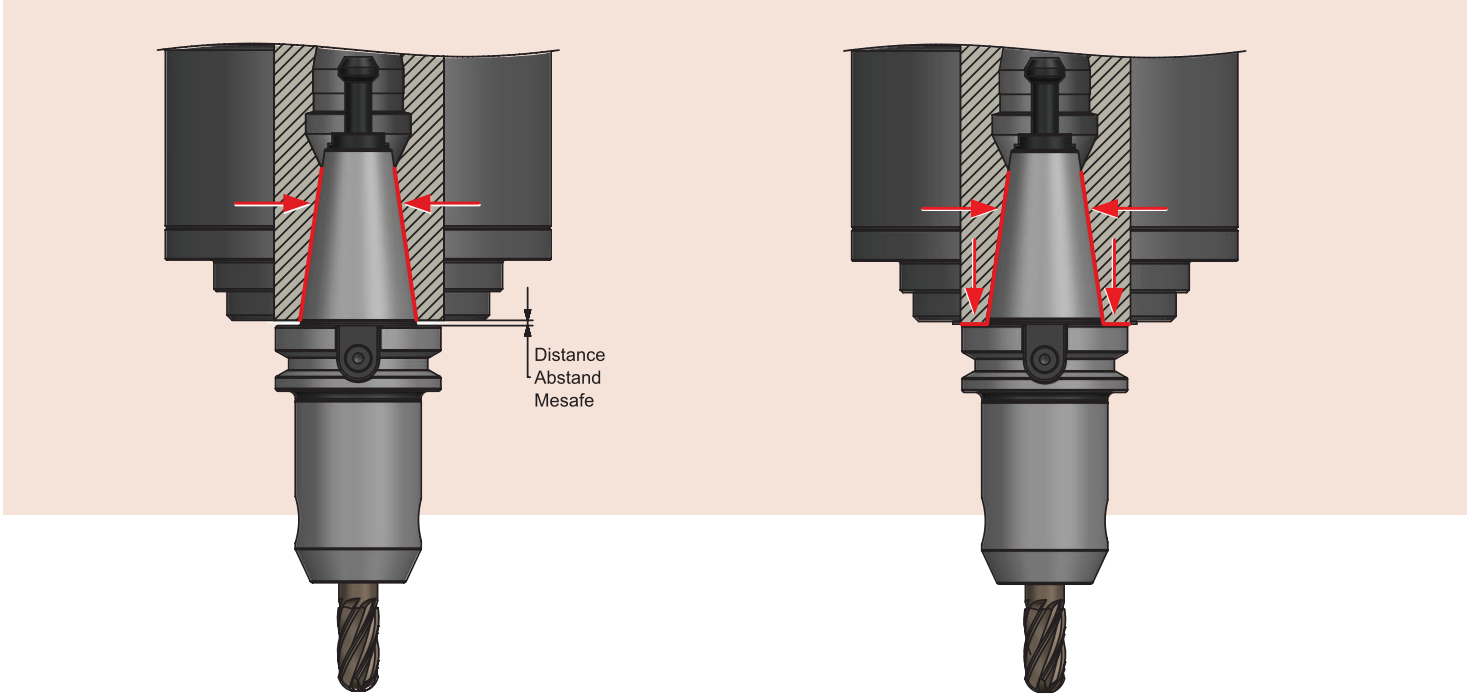

Tasarım:

- Makine tam performans kullanılabilir
- Sabit ve daha büyük tüm yüzey teması
- Tüm yüzey teması sayesinde daha az titreşim
- Daha iyi yüzey kalitesi ve daha yüksek işleme güvenilirliği
- Daha uzun kesici takım kullanım ömrü
- Tekrarlayan takım değişimlerinde yüksek hassasiyet
- Yüksek mil hızında dahi yüksek stabilite

Design:

- Machine performance can be used to the full extent
- Stable and bigger, complete full face contact
- Less vibrations due to large full face contact
- Better surface finish and higher reliability of processing
- Longer service life of the cutting tools
- Better tool change repeat accuracy
- No loss of stability at high spindle speeds

Ausführung:

- Maschinenleistung kann voll genutzt werden
- Stabile und vergrößerte, vollständige Plananlage
- Weniger Vibrationen aufgrund der großen Plananlage
- Verbesserte Oberflächengüte und prozesssichere Maßhaltigkeit am Werkstück
- Höhere Standzeit der Schneidwerkzeuge
- Bessere Werkzeugwechsel-Wiederholgenauigkeit
- Kein Stabilitätsverlust bei hohen Spindeldrehzahlen



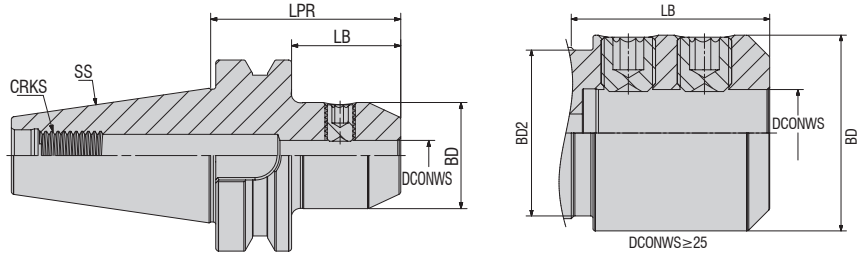

Sipariş Kodu Ordering Code Bestell-Bezeichnung	Stok Stock Lager	Tutucu Ölçüleri (mm) / Dimension (mm) / Abmessung (mm)							
		SS	DCONWS	LPR	BD	BD2	LB	CRKS	KG
ABBT30-EM-06-050	○	30	06	50	25	-	28	M12	0.460
ABBT30-EM-08-050	○	30	08	50	28	-	28	M12	0.490
ABBT30-EM-10-050	○	30	10	50	35	-	28	M12	0.540
ABBT30-EM-12-050	○	30	12	50	42	-	28	M12	0.600
ABBT30-EM-14-050	○	30	14	50	44	-	28	M12	0.610
ABBT30-EM-16-063	○	30	16	63	48	45	41	M12	0.810
ABBT30-EM-18-063	○	30	18	63	50	45	41	M12	0.820
ABBT40-EM-06-100	○	40	06	100	25	-	73	M16	1.200
ABBT40-EM-06-160	○	40	06	160	25	-	133	M16	1.440
ABBT40-EM-08-050	○	40	08	50	28	-	23	M16	1.050
ABBT40-EM-08-100	○	40	08	100	28	-	73	M16	1.270
ABBT40-EM-08-160	○	40	08	160	28	-	133	M16	1.570
ABBT40-EM-10-063	○	40	10	63	35	-	36	M16	1.170
ABBT40-EM-10-100	○	40	10	100	35	-	73	M16	1.410
ABBT40-EM-12-063	○	40	12	63	42	-	36	M16	1.260
ABBT40-EM-12-100	○	40	12	100	42	-	73	M16	1.620
ABBT40-EM-14-063	●	40	14	63	44	-	36	M16	1.280
ABBT40-EM-14-100	●	40	14	100	44	-	73	M16	1.680
ABBT40-EM-16-063	●	40	16	63	48	-	36	M16	1.330
ABBT40-EM-16-100	○	40	16	100	48	-	73	M16	1.820
ABBT40-EM-16-160	○	40	16	160	48	-	133	M16	2.680
ABBT40-EM-18-063	○	40	18	63	50	-	36	M16	1.350
ABBT40-EM-18-100	○	40	18	100	50	-	73	M16	1.880
ABBT40-EM-20-063	○	40	20	63	52	-	36	M16	1.650
ABBT40-EM-20-100	○	40	20	100	52	-	73	M16	1.940
ABBT40-EM-25-090	○	40	25	90	63	61	63	M16	2.110
ABBT40-EM-25-130	○	40	25	130	63	61	103	M16	3.060
ABBT40-EM-25-160	○	40	25	160	63	61	133	M16	3.760
ABBT40-EM-32-100	●	40	32	100	72	61	73	M16	2.640
ABBT40-EM-32-160	○	40	32	160	72	61	133	M16	4.480
ABBT40-EM-40-120	○	40	40	120	79	61	93	M16	3.480

Yedek Parça / Spare Part / Ersatzteile



Siparişe Dahil / Delivered with / In der Bestellung enthalten



Siparişe Dahil Değil / Delivered without / Nicht in der Bestellung enthalten

Sipariş Örneği/Ordering Example/Bestellbeispiel
 1 ad./pcs./stück ABBT30-EM-06-050

Daha fazla bilgi için, 57-67. sayfalara bakabilirsiniz. / For more info, you can check pages between 57-67. / Weitere Informationen finden Sie auf den Seiten 57-67.

● Stokta / In Stock / Auf Lager ○ Stokta Yok / Non Stock Item / Kein Lagerartikel, Lieferzeit auf Anfrage

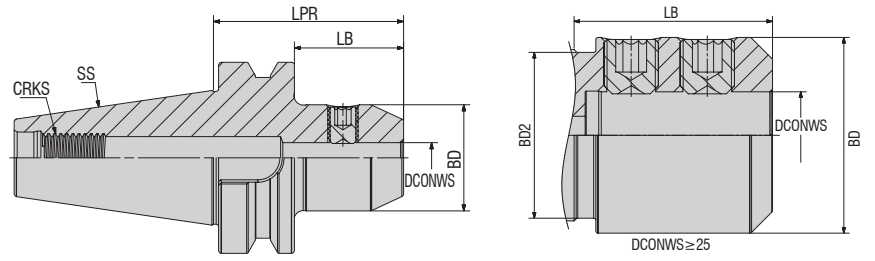

Sipariş Kodu Ordering Code Bestell-Bezeichnung	Stok Stock Lager	Tutucu Ölçüleri (mm) / Dimension (mm) / Abmessung (mm)							
		SS	DCONWS	LPR	BD	BD2	LB	CRKS	KG
ABBT50-EM-06-063	○	50	06	63	25	-	25	M24	3.700
ABBT50-EM-06-100	○	50	06	100	25	-	62	M24	3.830
ABBT50-EM-06-160	○	50	06	160	25	-	122	M24	4.050
ABBT50-EM-08-063	○	50	08	63	28	-	25	M24	3.720
ABBT50-EM-08-100	○	50	08	100	28	-	62	M24	3.880
ABBT50-EM-10-100	○	50	10	100	35	-	62	M24	3.990
ABBT50-EM-10-160	○	50	10	160	35	-	122	M24	4.420
ABBT50-EM-12-080	○	50	12	80	42	-	42	M24	3.970
ABBT50-EM-12-100	○	50	12	100	42	-	62	M24	4.170
ABBT50-EM-12-160	○	50	12	160	42	-	122	M24	4.800
ABBT50-EM-14-080	○	50	14	80	44	-	42	M24	3.990
ABBT50-EM-14-100	○	50	14	100	44	-	62	M24	4.200
ABBT50-EM-16-080	○	50	16	80	48	-	42	M24	4.060
ABBT50-EM-16-100	○	50	16	100	48	-	62	M24	4.330
ABBT50-EM-16-160	○	50	16	160	48	-	122	M24	5.160
ABBT50-EM-18-100	○	50	18	100	50	-	62	M24	4.380
ABBT50-EM-18-160	○	50	18	160	50	-	122	M24	5.280
ABBT50-EM-20-100	○	50	20	100	52	-	62	M24	4.420
ABBT50-EM-20-160	○	50	20	160	52	-	122	M24	5.400
ABBT50-EM-25-100	○	50	25	100	63	-	62	M24	4.760
ABBT50-EM-25-160	○	50	25	160	63	-	122	M24	6.220
ABBT50-EM-32-105	○	50	32	105	72	-	67	M24	5.180
ABBT50-EM-32-160	○	50	32	160	72	-	122	M24	6.890
ABBT50-EM-40-110	○	50	40	110	80	-	72	M24	5.490
ABBT50-EM-40-160	○	50	40	160	80	-	122	M24	7.420

Yedek Parça / Spare Part / Ersatzteile



Veldon Sıkma Civatası DIN 1835 B
 Clamping Screw Weldon DIN 1835 B
 Weldon-Klemmschraube DIN 1835 B

Siparişe Dahil / Delivered with / In der Bestellung enthalten



Çektirme Civatası
 Pull Stud
 Anzugsbolzen

Siparişe Dahil Değil / Delivered without / Nicht in der Bestellung enthalten

Sipariş Örneği/Ordering Example/Bestellbeispiel
 1 ad./pcs./stück ABBT50-EM-06-063

Daha fazla bilgi için, 57-67. sayfalara bakabilirsiniz. / For more info, you can check pages between 57-67. /
 Weitere Informationen finden Sie auf den Seiten 57-67.

● Stokta / In Stock / Auf Lager ○ Stokta Yok / Non Stock Item / Kein Lagerartikel, Lieferzeit auf Anfrage

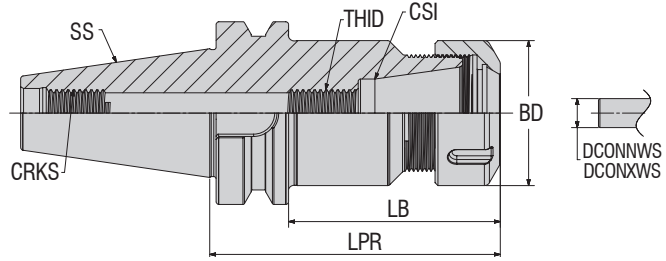

Sipariş Kodu Ordering Code Bestell-Bezeichnung	Stok Stock Lager	Tutucu Ölçüleri (mm) / Dimension (mm) / Abmessung (mm)									
		SS	CSI	DCONWS	DCONXWS	BD	LPR	LB	THID	CRKS	KG
ABBT30-ER-16-070	○	30	ER16	0.5	10	28	70	48	M10	M12	0.540
ABBT30-ER-16-100	○	30	ER16	0.5	10	28	100	73	M10	M12	0.670
ABBT30-ER-25-070	○	30	ER25	1.0	16	42	70	48	M16	M12	0.660
ABBT30-ER-25-100	○	30	ER25	1.0	16	42	100	73	M16	M12	0.970
ABBT40-ER-16-063	○	40	ER16	0.5	10	28	63	36	M10	M16	1.060
ABBT40-ER-16-100	●	40	ER16	0.5	10	28	100	73	M10	M16	1.210
ABBT40-ER-16-130	○	40	ER16	0.5	10	28	130	103	M10	M16	1.330
ABBT40-ER-25-060	○	40	ER25	1.0	16	42	60	33	M16	M16	1.090
ABBT40-ER-25-100	●	40	ER25	1.0	16	42	100	73	M16	M16	1.490
ABBT40-ER-25-130	○	40	ER25	1.0	16	42	130	103	M16	M16	1.800
ABBT40-ER-32-070	●	40	ER32	2.0	20	50	70	43	M16	M16	1.250
ABBT40-ER-32-100	●	40	ER32	2.0	20	50	100	73	M16	M16	1.680
ABBT40-ER-32-160	●	40	ER32	2.0	20	50	160	133	M16	M16	2.580
ABBT40-ER-40-080	●	40	ER40	3.0	26	63	80	53	M16	M16	1.610
ABBT40-ER-40-100	●	40	ER40	3.0	26	63	100	73	M16	M16	2.080
ABBT40-ER-40-160	●	40	ER40	3.0	26	63	160	133	M16	M16	3.480
ABBT50-ER-16-070	○	50	ER16	0.5	10	28	70	43	M10	M24	3.690
ABBT50-ER-16-100	○	50	ER16	0.5	10	28	100	73	M10	M24	3.810
ABBT50-ER-16-160	○	50	ER16	0.5	10	28	160	133	M10	M24	4.100
ABBT50-ER-25-070	○	50	ER25	1.0	16	42	70	43	M16	M24	3.730
ABBT50-ER-25-100	●	50	ER25	1.0	16	42	100	73	M16	M24	4.030
ABBT50-ER-25-160	○	50	ER25	1.0	16	42	160	133	M16	M24	4.700
ABBT50-ER-32-070	○	50	ER32	2.0	20	50	70	43	M16	M24	3.750
ABBT50-ER-32-100	○	50	ER32	2.0	20	50	100	73	M16	M24	4.170
ABBT50-ER-32-130	○	50	ER32	2.0	20	50	130	103	M16	M24	4.610
ABBT50-ER-32-160	○	50	ER32	2.0	20	50	160	133	M16	M24	5.120
ABBT50-ER-40-080	○	50	ER40	3.0	26	63	80	53	M16	M24	4.000
ABBT50-ER-40-100	○	50	ER40	3.0	26	63	100	73	M16	M24	4.490
ABBT50-ER-40-160	○	50	ER40	3.0	26	63	160	133	M16	M24	5.990

Yedek Parça / Spare Part / Ersatzteile



Siparişe Dahil /
Delivered with /
In der Bestellung enthalten

Siparişe Dahil Değil / Delivered without / Nicht in der Bestellung enthalten

Sipariş Örneği/Ordering Example/Bestellbeispiel
1 ad./pcs./stück ABBT30-ER-16-070

Daha fazla bilgi için, 57-67. sayfalara bakabilirsiniz. / For more info, you can check pages between 57-67. /
Weitere Informationen finden Sie auf den Seiten 57-67.

● Stokta / In Stock / Auf Lager ○ Stokta Yok / Non Stock Item / Kein Lagerartikel, Lieferzeit auf Anfrage

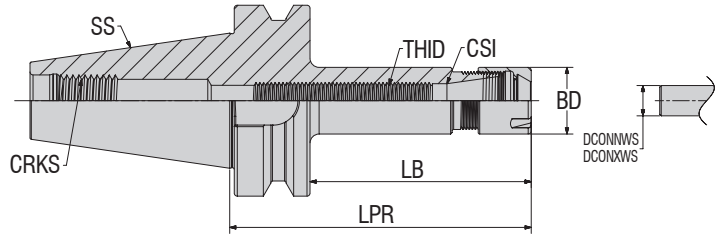

Sipariş Kodu Ordering Code Bestell-Bezeichnung	Stok Stock Lager	Tutucu Ölçüleri (mm) / Dimension (mm) / Abmessung (mm)									
		SS	CSI	DCONWS	DCONXWS	BD	LPR	LB	THID	CRKS	KG
ABBT40-ER-16-100-M	●	40	ER16	0.5	10	22	100	73	M10	M16	1.110
ABBT40-ER-16-130-M	○	40	ER16	0.5	10	22	130	103	M10	M16	1.190
ABBT50-ER-16-130-M	○	50	ER16	0.5	10	22	130	92	M10	M24	3.810
ABBT50-ER-16-160-M	○	50	ER16	0.5	10	22	160	122	M10	M24	3.930

Yedek Parça / Spare Part / Ersatzteile



Siparişe Dahil /
Delivered with /
In der Bestellung enthalten

Siparişe Dahil Değil / Delivered without / Nicht in der Bestellung enthalten

Daha fazla bilgi için, 57-67. sayfalara bakabilirsiniz. / For more info, you can check pages between 57-67. /
Weitere Informationen finden Sie auf den Seiten 57-67.

Sipariş Örneği/Ordering Example/Bestellbeispiel
1 ad./pcs./stück ABBT40-ER-16-100-M

● Stokta / In Stock / Auf Lager ○ Stokta Yok / Non Stock Item / Kein Lagerartikel, Lieferzeit auf Anfrage



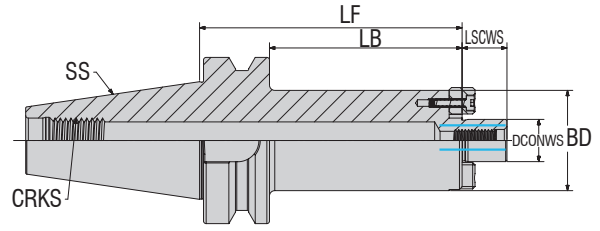

Sipariş Kodu Ordering Code Bestell-Bezeichnung	Stok Stock Lager	Tutucu Ölçüleri (mm) / Dimension (mm) / Abmessung (mm)							
		SS	DCONWS	LF	BD	LSCWS	LB	CRKS	KG
ABBT30-FM-16-040	○	30	16	40	38	17	18	M12	0.580
ABBT30-FM-22-040	○	30	22	40	48	19	18	M12	0.700
ABBT30-FM-27-050	○	30	27	50	60	21.5	28	M12	1.060
ABBT30-FM-32-050	○	30	32	50	78	24	28	M12	1.460
ABBT40-FM-16-100	●	40	16	100	38	17	73	M16	1.670
ABBT40-FM-22-100	○	40	22	100	48	19	73	M16	2.100
ABBT40-FM-27-100	●	40	27	100	60	21.5	73	M16	2.730
ABBT40-FM-32-100	○	40	32	100	78	24	73	M16	3.790
ABBT50-FM-16-050	○	50	16	50	37	17	12	M24	3.800
ABBT50-FM-16-100	○	50	16	100	38	17	62	M24	4.250
ABBT50-FM-16-160	○	50	16	160	38	17	122	M24	4.860
ABBT50-FM-22-055	○	50	22	55	48	19	17	M24	3.980
ABBT50-FM-22-100	○	50	22	100	48	19	62	M24	4.610
ABBT50-FM-22-160	○	50	22	160	48	19	122	M24	5.570
ABBT50-FM-27-055	○	50	27	55	48	19	17	M24	3.980
ABBT50-FM-27-100	○	50	27	100	60	21.5	62	M24	5.170
ABBT50-FM-27-160	○	50	27	160	60	21.5	122	M24	6.630
ABBT50-FM-32-100	○	50	32	100	78	24	62	M24	6.200
ABBT50-FM-32-160	○	50	32	160	78	24	122	M24	8.610
ABBT50-FM-40-100	○	50	40	100	88	27	62	M24	6.910
ABBT50-FM-40-160	○	50	40	160	88	27	122	M24	9.970
ABBT50-FM-60-080	○	50	60	80	128	40	42	M24	8.020

Yedek Parça / Spare Part / Ersatzteile



Tarama Başlık Sıkma Cıvatası DIN 6367
 Bolt For Shell Arbor DIN 6367
 Scankopf-Klemmschraube DIN 6367



Alın Kamalı Malafa Kaması
 Drive Key
 Mitnehmersteine Mit Schraube



Tarama Başlık Cıvatası Sıkma Anahtarını DIN 6368
 Wrench For Shell Arbor DIN 6368
 Spannschlüssel DIN 6368 für Aufsteckdorne



Çektirme Cıvatası
 Pull Stud
 Anzugsbolzen

Siparişe Dahil / Delivered with / In der Bestellung enthalten

Siparişe Dahil Değil / Delivered without / Nicht in der Bestellung enthalten

Daha fazla bilgi için, 57-67. sayfalara bakabilirsiniz. / For more info, you can check pages between 57-67. /
 Weitere Informationen finden Sie auf den Seiten 57-67.

Sipariş Örneği/Ordering Example/Bestellbeispiel
 1 ad./pcs./stück ABBT30-FM-16-040

● Stokta / In Stock / Auf Lager ○ Stokta Yok / Non Stock Item / Kein Lagerartikel, Lieferzeit auf Anfrage

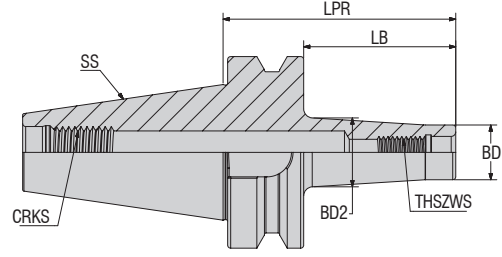

Sipariş Kodu Ordering Code Bestell-Bezeichnung	Stok Stock Lager	Tutucu Ölçüleri (mm) / Dimension (mm) / Abmessung (mm)							
		SS	THSZW	BD	BD2	LPR	LB	CRKS	KG
ABBT40-MM-08-052	○	40	M8	13	15	52	25	M16	0.960
ABBT40-MM-08-077	●	40	M8	13	22.5	77	50	M16	1.020
ABBT40-MM-08-102	○	40	M8	13	23	102	75	M16	1.070
ABBT40-MM-08-127	○	40	M8	13	25	127	100	M16	1.140
ABBT40-MM-10-052	○	40	M10	18	20	52	25	M16	0.980
ABBT40-MM-10-077	○	40	M10	18	23	77	50	M16	1.050
ABBT40-MM-10-102	○	40	M10	18	28	102	75	M16	1.160
ABBT40-MM-10-127	○	40	M10	18	32	127	100	M16	1.290
ABBT40-MM-12-052	○	40	M12	21	24	52	25	M16	1.000
ABBT40-MM-12-077	○	40	M12	21	24	77	50	M16	1.060
ABBT40-MM-12-102	●	40	M12	21	31	102	75	M16	1.210
ABBT40-MM-12-127	○	40	M12	21	32.5	127	100	M16	1.350
ABBT40-MM-12-177	○	40	M12	21	39.5	177	150	M16	1.760
ABBT40-MM-16-052	○	40	M16	29	-	52	25	M16	1.030
ABBT40-MM-16-077	○	40	M16	29	34	77	50	M16	1.180
ABBT40-MM-16-102	○	40	M16	29	34	102	75	M16	1.330
ABBT40-MM-16-127	○	40	M16	29	36	127	100	M16	1.520
ABBT40-MM-16-152	○	40	M16	29	40	152	125	M16	1.780
ABBT40-MM-16-177	○	40	M16	29	42.5	177	150	M16	2.040
ABBT50-MM-08-138	○	50	M8	13	24.5	138	100	M24	3.780
ABBT50-MM-08-188	○	50	M8	13	29.5	188	150	M24	3.970
ABBT50-MM-10-088	○	50	M10	18	23	88	50	M24	3.680
ABBT50-MM-10-138	○	50	M10	18	31.5	138	100	M24	3.920
ABBT50-MM-10-188	○	50	M10	18	36	188	150	M24	4.150
ABBT50-MM-12-088	○	50	M12	21	24	88	50	M24	3.700
ABBT50-MM-12-138	○	50	M12	21	32.5	138	100	M24	3.970
ABBT50-MM-12-188	○	50	M12	21	39.5	188	150	M24	4.380
ABBT50-MM-16-088	○	50	M16	29	34	88	50	M24	3.820
ABBT50-MM-16-138	○	50	M16	29	36	138	100	M24	4.150
ABBT50-MM-16-188	○	50	M16	29	42.5	188	150	M24	4.660

Yedek Parça / Spare Part / Ersatzteile



Çekirme Cıvatası
Pull Stud
Anzugsbolzen

Siparişe Dahil Değil /
Delivered without /
Nicht in der Bestellung enthalten

Sipariş Örneği/Ordering Example/Bestellbeispiel
1 ad./pcs./stück ABBT40-MM-08-052

Daha fazla bilgi için, 57-67. sayfalara bakabilirsiniz. / For more info, you can check pages between 57-67. /
Weitere Informationen finden Sie auf den Seiten 57-67.

● Stokta / In Stock / Auf Lager ○ Stokta Yok / Non Stock Item / Kein Lagerartikel, Lieferzeit auf Anfrage

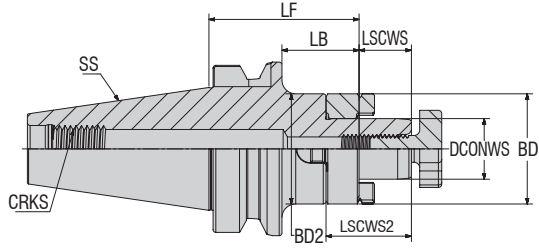

Sipariş Kodu Ordering Code Bestell-Bezeichnung	Stok Stock Lager	Tutucu Ölçüleri (mm) / Dimension (mm) / Abmessung (mm)									
		SS	DCONWS	LF	BD	BD2	LSCWS	LSCWS2	LB	CRKS	KG
ABBT30-FMC-16-045	○	30	16	45	32	-	17	27	23	M12	0.560
ABBT30-FMC-22-047	○	30	22	47	40	-	19	31	25	M12	0.700
ABBT30-FMC-27-049	○	30	27	49	48	-	21	33.5	27	M12	0.870
ABBT30-FMC-32-052	○	30	32	52	58	-	24	38	30	M12	1.120
ABBT40-FMC-16-055	○	40	16	55	32	-	17	27	28	M16	1.170
ABBT40-FMC-16-100	●	40	16	100	32	-	17	27	73	M16	1.430
ABBT40-FMC-16-160	○	40	16	160	32	38	17	27	133	M16	1.870
ABBT40-FMC-22-055	○	40	22	55	40	-	19	31	28	M16	1.280
ABBT40-FMC-22-100	○	40	22	100	40	-	19	31	73	M16	1.680
ABBT40-FMC-27-055	○	40	27	55	48	-	21	33.5	28	M16	1.440
ABBT40-FMC-27-100	○	40	27	100	48	-	21	33.5	73	M16	2.040
ABBT40-FMC-32-060	○	40	32	60	58	-	24	38	33	M16	1.800
ABBT40-FMC-32-100	○	40	32	100	58	-	24	38	73	M16	2.590
ABBT40-FMC-40-060	○	40	40	60	70	-	27	41	33	M16	2.190
ABBT50-FMC-16-070	○	50	16	70	32	-	17	27	32	M24	3.850
ABBT50-FMC-16-100	○	50	16	100	32	-	17	27	62	M24	4.030
ABBT50-FMC-16-130	○	50	16	130	32	-	17	27	92	M24	4.200
ABBT50-FMC-16-160	○	50	16	160	32	37	17	27	122	M24	4.430
ABBT50-FMC-22-070	○	50	22	70	40	-	19	31	32	M24	3.970
ABBT50-FMC-22-100	○	50	22	100	40	-	19	31	62	M24	4.230
ABBT50-FMC-22-130	○	50	22	130	40	-	19	31	92	M24	4.500
ABBT50-FMC-22-160	○	50	22	160	40	45.5	19	31	122	M24	4.840
ABBT50-FMC-27-070	○	50	27	70	48	-	21	33.5	32	M24	4.150
ABBT50-FMC-27-100	○	50	27	100	48	-	21	33.5	62	M24	4.550
ABBT50-FMC-27-130	○	50	27	130	48	-	21	33.5	92	M24	4.950
ABBT50-FMC-27-160	○	50	27	160	48	53.5	21	33.5	122	M24	5.440
ABBT50-FMC-32-070	○	50	32	70	58	-	24	38	32	M24	4.430
ABBT50-FMC-32-100	○	50	32	100	58	-	24	38	62	M24	5.030
ABBT50-FMC-32-130	○	50	32	130	58	-	24	38	92	M24	5.620
ABBT50-FMC-32-160	○	50	32	160	58	64	24	38	122	M24	6.340
ABBT50-FMC-40-070	○	50	40	70	70	-	27	41	32	M24	4.880
ABBT50-FMC-40-100	○	50	40	100	70	-	27	41	62	M24	5.760
ABBT50-FMC-40-130	○	50	40	130	70	-	27	41	92	M24	6.640
ABBT50-FMC-40-160	○	50	40	160	70	76	27	41	122	M24	7.680

Sipariş Örneği/Ordering Example/Bestellbeispiel
 1 ad./pcs./stück ABBT30-FMC-16-045

Yedek Parça / Spare Part / Ersatzteile



Tarama Başlık Sıkma Cıvatası DIN 6367
 Bolt For Shell Arbor DIN 6367
 Scankopf-Klemmschraube DIN 6367



Kama DIN 6885
 Drive Key DIN 6885
 Paßfeder DIN 6885



Tarama Başlık Cıvatası Sıkma Anahtarı DIN 6368
 Wrench For Shell Arbor DIN 6368
 Spannschlüssel DIN 6368 für Aufsteckdorne



Çektirme Cıvatası
 Pull Stud
 Anzugsbolzen



Tırnaklı Pul DIN 6366
 Clutch Drive Rings To DIN 6366
 Mitnehmeringe DIN 6366

Siparişe Dahil / Delivered with / In der Bestellung enthalten

Siparişe Dahil Değil / Delivered without / Nicht in der Bestellung enthalten

● Stokta / In Stock / Auf Lager ○ Stokta Yok / Non Stock Item / Kein Lagerartikel, Lieferzeit auf Anfrage

SK TUTUCULAR

SK HOLDERS

SK HALTER



■ Teknik çizim ve fotoğraflar değişiklik gösterebilir.
Illustrations shown may vary from actual product.
Das Produkt kann von dem gezeigten Bild abweichen.



AKKO[®]

*konusulan
the spoken kalite...
quality...*

www.akkо.com.tr

1
A

AKKO

2
SK40

GÖVDE TİPİ / SHANK TYPE / KÖRPERTYP

3
EM

FORMU / FORM / FORM

4
06

ÇAP / DIAMETER / DURCHMESSER

5
080

TUTUCU BOY / HOLDER SIZE / HALTER GRÖSSE

SK 40

EM : VELDON ŞAFTLI TAKIM TUTUCULAR / END MILL HOLDER / FRÄSERAUFNAHMEN

ER : ER SIKMA PENSLİ TAKIM TUTUCULAR / COLLET CHUCKS (ER) / SPANNFUTTER ER

FM : YÜZEY FREZE TAKIM TUTUCULAR / SHELL MILL HOLDERS / AUFSTECKFRÄSERDORNE



KALİTE KONTROL

QUALITY CONTROL

QUALITÄTSKONTROLLE

SK 40

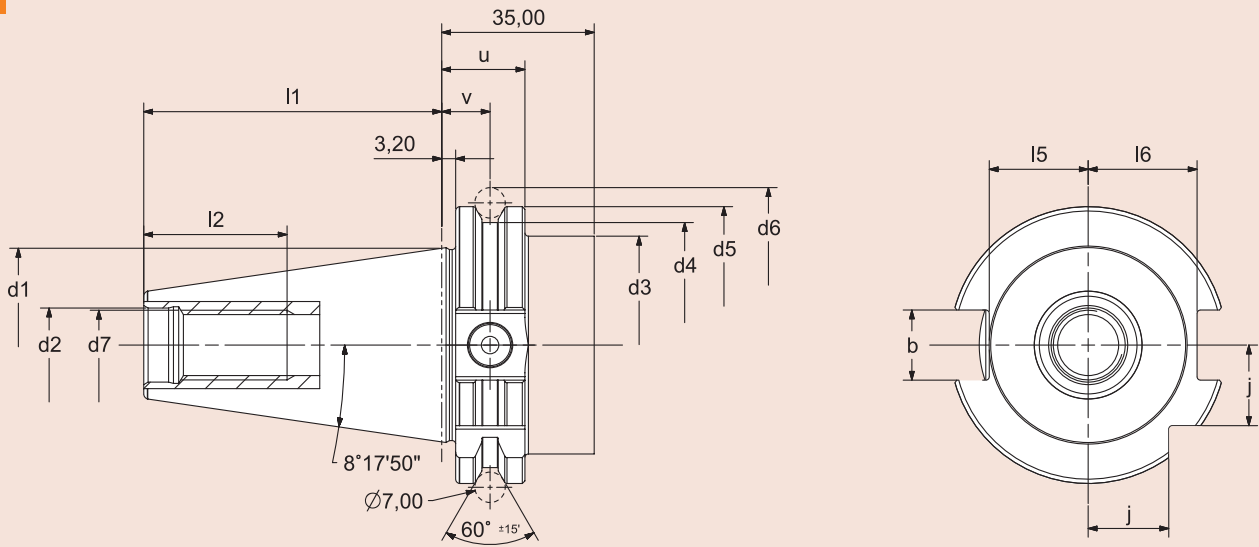

Tasarım:

- Konik açısı: 8° 17'50" + 4"
- Takım tutucular, yüzeyi sertleştirilmiş 58 ± 2 HRC
- Çekirdekte çekme dayanımı en az 950 N/mm²
- AT3 tolerans kalitesinde koniklik
- Dahili veri çipi için çap Ø 10 mm

Design:

- Angle of cone: 8° 17'50" + 4"
- Tool holders case-hardened 58 ± 2 HRC
- Tensile strength in the core at least 950 N/mm²
- Taper in tolerance quality AT3
- Incl. bore for data chip Ø 10 mm

Ausführung:

- Kegelwinkel: 8° 17'50" + 4"
- Aufnahmen einsatzgehärtet 58 ± 2 HRC
- Zugfestigkeit im Kern mindestens 950 N/mm²
- Steilkegel in Kegelwinkel-Toleranzqualität AT3
- Inkl. Codeträgerbohrung Ø 10 mm

SK	d1	d2 H7	d3 max.	d4 0.0 -0.05	d5 0.0 -0.1	d6 ±0.05	d7 6H	u 0.0 -0.1	v ±0.1	l1 0.0 -0.3	l2 min.	l5 0.0 -0.3	l6 0.0 -0.3	b 0.2 0.0	j 0.2 -0.3
SK40	44.45	17	50	56.25	63.55	72.30	X16x2	19.1	11.1	68.4	32	22.7	25	16.1	18.5

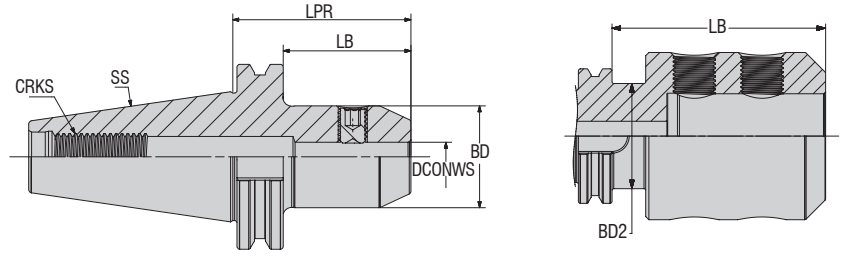

Sipariş Kodu Ordering Code Bestell-Bezeichnung	Stok Stock Lager	Tutucu Ölçüleri (mm) / Dimension (mm) / Abmessung (mm)							
		SS	DCONWS	LPR	BD	BD2	LB	CRKS	KG
ASK40-EM-08-050	○	40	08	50	28	-	30.9	M16	0.930
ASK40-EM-10-063	●	40	10	63	35	-	43.9	M16	1.230
ASK40-EM-12-050	○	40	12	50	42	-	30.9	M16	1.050
ASK40-EM-12-100	○	40	12	100	42	-	80.9	M16	1.550
ASK40-EM-12-063	○	40	12	63	42	-	43.9	M16	1.310
ASK40-EM-16-063	○	40	16	63	42	-	43.9	M16	1.310
ASK40-EM-16-100	○	40	16	100	48	-	80.9	M16	1.770
ASK40-EM-20-063	●	40	20	63	52	49.7	43.9	M16	1.310
ASK40-EM-20-100	○	40	20	100	52	49.7	80.9	M16	1.880
ASK40-EM-25-090	●	40	25	90	63	49.7	80.9	M16	2.200
ASK40-EM-32-100	●	40	32	100	72	49.7	80.9	M16	2.550
ASK40-EM-40-120	○	40	40	120	79	49.7	100.9	M16	3.420

Yedek Parça / Spare Part / Ersatzteile



Veldon Sıkma Civatası DIN 1835 B
Clamping Screw Weldon DIN 1835 B
Weldon-Klemmschraube DIN 1835 B



Çektirme Civatası
Pull Stud
Anzugsbolzen

● Stokta / In Stock / Auf Lager ○ Stokta Yok / Non Stock Item / Kein Lagerartikel, Lieferzeit auf Anfrage

Siparişe Dahil / Delivered with / In der Bestellung enthalten

Siparişe Dahil Değil / Delivered without / Nicht in der Bestellung enthalten

Daha fazla bilgi için, 57-67. sayfalara bakabilirsiniz. / For more info, you can check pages between 57-67. / Weitere Informationen finden Sie auf den Seiten 57-67.

Sipariş Örneği/Ordering Example/Bestellbeispiel
1 ad./pcs./stück ASK40-EM-08-050



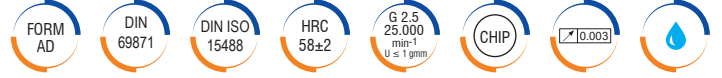
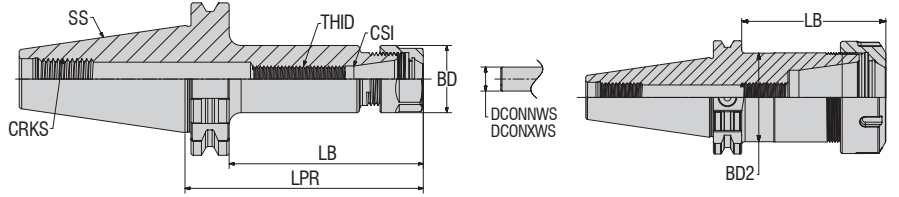
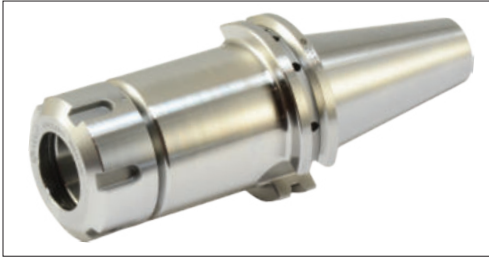

Sipariş Kodu Ordering Code Bestell-Bezeichnung	Stok Stock Lager	Tutucu Ölçüleri (mm) / Dimension (mm) / Abmessung (mm)										
		SS	CSI	DCONNWS	DCONXWS	BD	BD2	LPR	LB	THID	CRKS	KG
ASK40-ER-16-063	○	40	ER16	0.5	10	28	-	63	43.9	M10	M16	0.940
ASK40-ER-25-060	○	40	ER25	1.0	16	42	-	60	40.9	M16	M16	1.020
ASK40-ER-25-100	●	40	ER25	1.0	16	42	-	100	80.9	M16	M16	1.420
ASK40-ER-32-070	●	40	ER32	2.0	20	50	49.7	70	50.9	M16	M16	1.210
ASK40-ER-32-100	●	40	ER32	2.0	20	50	49.7	100	80.9	M16	M16	1.640
ASK40-ER-32-160	●	40	ER32	2.0	20	50	49.7	160	140.9	M16	M16	2.500
ASK40-ER-40-080	●	40	ER40	3.0	26	63	49.7	80	60.9	M16	M16	1.430
ASK40-ER-40-100	●	40	ER40	3.0	26	63	49.7	100	80.9	M16	M16	1.720
ASK40-ER-40-160	○	40	ER40	3.0	26	63	49.7	160	140.9	M16	M16	2.580

Yedek Parça / Spare Part / Ersatzteile



Pens Kapağı
Clamping Nuts
Spannmutter

Siparişe Dahil / Delivered with / In der Bestellung enthalten



Çektirme Civatası
Pull Stud
Anzugsbolzen

Siparişe Dahil Değil / Delivered without / Nicht in der Bestellung enthalten



ER Tipi Anahtar
Wrench ER
Spannschlüssel ER



Pensler ER DIN6499/ISO 15488-B
Collet Chuck ER DIN6499/ISO 15488-B
Spannschlüssel ER DIN6499/ISO 15488-B

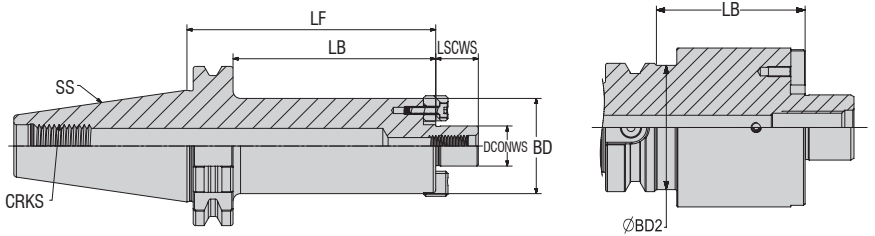

Sipariş Kodu Ordering Code Bestell-Bezeichnung	Stok Stock Lager	Tutucu Ölçüleri (mm) / Dimension (mm) / Abmessung (mm)									
		SS	DCONWS	BD	BD2	LF	LSCWS	LB	CRKS	KG	
ASK40-FM-16-055	○	40	16	38	-	55	17	35.9	M16	1.210	
ASK40-FM-16-100	○	40	16	38	-	100	17	80.9	M16	1.590	
ASK40-FM-22-055	○	40	22	48	-	55	19	35.9	M16	1.350	
ASK40-FM-27-055	○	40	27	60	49.7	55	21.5	35.9	M16	1.620	
ASK40-FM-32-060	○	40	32	78	49.7	60	24	40.9	M16	2.020	
ASK40-FM-40-060	○	40	40	88	49.7	60	27	40.9	M16	2.260	

Yedek Parça / Spare Part / Ersatzteile



Tarama Başlık Sıkma Civatası DIN 6367
Bolt For Shell Arbor DIN 6367
Scankopf-Klemmschraube DIN 6367

Siparişe Dahil / Delivered with / In der Bestellung enthalten



Alın Kamalı Malafa Kaması
Drive Key
Mitnehmersteine Mit Schraube



Tarama Başlık Civatası Sıkma Anahtarı DIN 6368
Wrench For Shell Arbor DIN 6368
Spannschlüssel DIN 6368 für Aufsteckdorne

Siparişe Dahil Değil / Delivered without / Nicht in der Bestellung enthalten



Çektirme Civatası
Pull Stud
Anzugsbolzen

HSK TUTUCULAR

HSK HOLDERS

HSK HALTER



■ Teknik çizim ve fotoğraflar değişiklik gösterebilir.
Illustrations shown may vary from actual product.
Das Produkt kann von dem gezeigten Bild abweichen.



AKKO[®]

*konuşulan
the spoken kalite...
quality...*

www.akko.com.tr

1	2	3	4	5
A	HSK63	EM	06	080
AKKO	GÖVDE TİPİ / SHANK TYPE / KÖRPERTYP	FORMU / FORM / FORM	ÇAP / DIAMETER / DURCHMESSER	TUTUCU BOY / HOLDER SIZE / HALTER GRÖSSE

HSK 32-40-50-63-80-100

EM : VELDON ŞAFTLI TAKIM TUTUCULAR / END MILL HOLDER / FRÄSERAUFNAHMEN
ER : ER SIKMA PENSİLİ TAKIM TUTUCULAR / COLLET CHUCKS (ER) / SPANNFUTTER ER
FM : YÜZEY FREZE TAKIM TUTUCULAR / SHELL MILL HOLDERS / AUFSTECKFRÄSERDORNE
MM : MODÜLER PARMAK FREZE TUTUCULAR / MILLING CUTTER ARBORS FOR SCREW-ON TYPE MILLING CUTTERS / MODULARE SCHAFTFRÄSERHALTER
FMC : KOMBİNE YÜZEY FREZE TAKIM TUTUCULARI / COMBI SHELL MILL HOLDER / KOMBINIERTER FLÄCHENFRÄSHALTER
BL41: BLANK TUTUCULAR / BLANK HOLDERS / BLANK HALTER



KALİTE KONTROL

QUALITY CONTROL

QUALITÄTSKONTROLLE

HSK

HSK 32-40-50-63-80-100

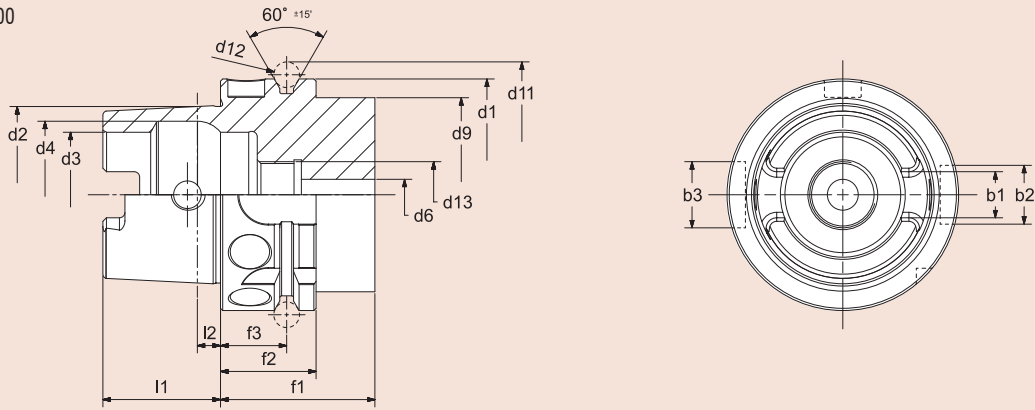

ST'ye kıyasla HSK'nın sahip olduğu avantajlar şu şekildedir:

- Takımları spindl'e bağlarken yüksek oranda tekrarlanabilir doğruluk
- Düz temas yüzeyli sabit aksinel konumlandırma
- Yüksek hızlı kesime uygun
- Çekme saplaması gerekmez
- Dahili veri çipi için delik (yalnızca HSK-A)

Malzeme:

- Yüksek gerilimli parçalar için özel yüzey sertleştirme çeliği
- Yüzey sertliği: 58 ± 2 HRC
- Çekirdekte çekme dayanımı min. 950 N/mm²

Compared to the steep taper the HSK has the following advantages:

- Highly repeatable accuracy when clamping tools into spindle
- Fixed axial positioning with flat contact surface
- Suitable for high speed cutting
- No pull stud necessary
- Incl. bore for data chip (only HSK-A)

Material:

- Special case-hardening steel for highly stressed parts
- Surface hardness: 58 ± 2 HRC
- Tensile strength in core min. 950 N/mm²

Gegenüber dem Steilkegel hat die HSK-Schnittstelle folgende Vorteile:

- Hohe Wiederholgenauigkeit beim Einwechseln von Werkzeugen
- Feste axiale Positionierung durch Plananlage
- Eignung für hohe Drehzahlen
- Kein Anzugsbolzen notwendig
- Inkl. Codeträgerbohrung (nur HSK-A)

Werkstoff:

- Spezieller Einsatzstahl für hoch beanspruchte Bauteile
- Oberflächenhärte: 58 ± 2 HRC
- Zugfestigkeit im Kern mind. 1000 N/mm²

HSK-A	d1 h10	d2	d3 H10	d4 H11	d6 max	d9 max	d11 0 -0.1	d12	d13	l1 0 -0.2	l2	b1 0.04 -0.04	b2 H10	b3 H10	f1 0 -0.1	f2 min.	f3 ±0.1
32	32	24.007	17	20.5	4.2	26	37	4	M10x1	16	3.2	7.05	7	9	20	35	16
40	40	30.007	21	25.5	5	34	45	4	M12x1	20	4	8.05	9	11	20	35	16
50	50	38.008	26	32	6.8	42	59.3	7	M16x1	25	5	10.54	12	14	26	42	18
63	63	48.010	34	40	8.4	53	72.3	7	M18x1	32	6.3	12.54	16	18	26	42	18
80	80	60.012	42	50	10.2	68	88.8	7	M20x1.5	40	8	16.04	18	20	26	42	18
100	100	75.013	53	63	12	88	109.75	7	M24x1.5	50	10	20.02	20	22	29	45	20

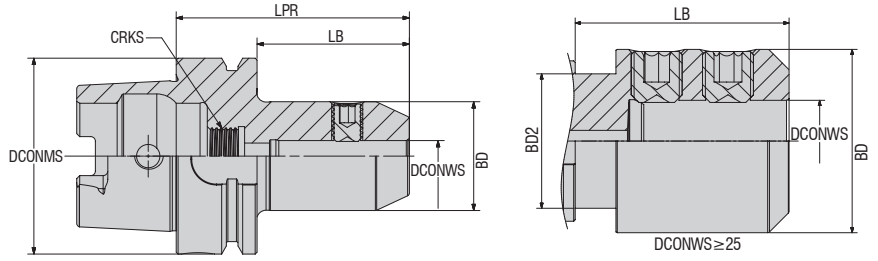

Sipariş Kodu Ordering Code Bestell-Bezeichnung	Stok Stock Lager	Tutucu Ölçüleri (mm) / Dimension (mm) / Abmessung (mm)							
		DCONMS	DCONWS	LPR	BD	BD2	LB	CRKS	KG
AHKA32-EM-06-060	○	32	06	60	25	-	40	M10x1	0.250
AHKA32-EM-08-060	○	32	08	60	28	25	40	M10x1	0.270
AHKA32-EM-10-065	○	32	10	65	34	25	45	M10x1	0.350
AHKA32-EM-12-065	○	32	12	65	42	25	45	M10x1	0.420
AHKA40-EM-06-060	○	40	06	60	25	-	40	M12x1	0.320
AHKA40-EM-08-060	○	40	08	60	28	-	40	M12x1	0.360
AHKA40-EM-10-060	○	40	10	60	35	32.6	40	M12x1	0.430
AHKA40-EM-12-070	○	40	12	70	42	32.6	50	M12x1	0.590
AHKA40-EM-16-075	○	40	16	75	48	32.6	55	M12x1	0.720
AHKA50-EM-06-065	○	50	06	65	25	-	39	M16x1	0.510
AHKA50-EM-08-065	○	50	08	65	28	-	39	M16x1	0.550
AHKA50-EM-10-065	○	50	10	65	35	-	39	M16x1	0.630
AHKA50-EM-12-080	○	50	12	80	42	41.6	54	M16x1	0.880
AHKA50-EM-14-080	○	50	14	80	44	41.6	54	M16x1	0.900
AHKA50-EM-16-080	○	50	16	80	48	41.6	54	M16x1	0.960
AHKA50-EM-18-080	○	50	18	80	50	41.6	54	M16x1	0.980
AHKA50-EM-20-080	○	50	20	80	52	41.6	54	M16x1	0.990
AHKA63-EM-06-065	○	63	06	65	25	-	39	M18x1	0.760
AHKA63-EM-06-075	○	63	06	75	25	-	49	M18x1	0.820
AHKA63-EM-06-100	○	63	06	100	25	-	74	M18x1	0.880
AHKA63-EM-06-160	○	63	06	160	25	-	134	M18x1	1.120
AHKA63-EM-08-075	○	63	08	75	28	-	49	M18x1	0.850
AHKA63-EM-08-100	○	63	08	100	28	-	74	M18x1	0.950
AHKA63-EM-08-160	○	63	08	160	28	-	134	M18x1	1.260
AHKA63-EM-10-075	●	63	10	75	35	-	49	M18x1	0.980
AHKA63-EM-10-100	○	63	10	100	35	-	74	M18x1	1.130
AHKA63-EM-10-160	○	63	10	160	35	-	134	M18x1	1.610
AHKA63-EM-12-080	○	63	12	80	42	-	54	M18x1	1.140
AHKA63-EM-12-130	●	63	12	130	42	-	104	M18x1	1.660
AHKA63-EM-12-160	○	63	12	160	42	-	134	M18x1	2.030
AHKA63-EM-14-080	○	63	14	80	44	-	54	M18x1	1.180
AHKA63-EM-14-130	○	63	14	130	44	-	104	M18x1	1.750
AHKA63-EM-16-080	○	63	16	80	48	-	54	M18x1	1.270
AHKA63-EM-16-130	○	63	16	130	48	-	104	M18x1	1.950
AHKA63-EM-16-160	○	63	16	160	48	-	134	M18x1	2.360

Yedek Parça / Spare Part / Ersatzteile

 Veldon Sıkma Civatası DIN 1835 B
Clamping Screw Weldon DIN 1835 B
Weldon-Klemmschraube DIN 1835 B

 Soğutma Suyu Ünitesi
Cooling Tubes
Kühlmitteleinheit

 Soğutma Suyu Ünitesi Anahtar
Wrench For Delivery Unit For Coolant
Schlüssel Für Kühlmittelübergabeeinheit

Sipariş Örneği/Ordering Example/Bestellbeispiel
1 ad./pcs./stück AHKA32-EM-06-060

Siparişe Dahil / Delivered with / In der Bestellung enthalten

Siparişe Dahil Değil / Delivered without / Nicht in der Bestellung enthalten

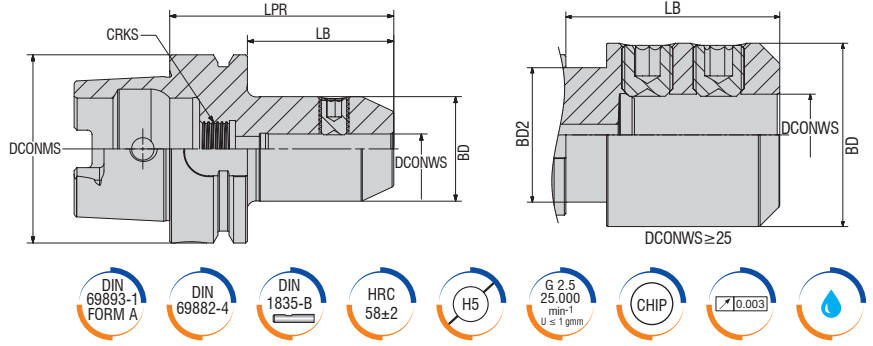

Sipariş Kodu Ordering Code Bestell-Bezeichnung	Stok Stock Lager	Tutucu Ölçüleri (mm) / Dimension (mm) / Abmessung (mm)							
		DCONMS	DCONWS	LPR	BD	BD2	LB	CRKS	KG
AHKA63-EM-18-080	●	63	18	80	50	-	54	M18x1	1.310
AHKA63-EM-20-080	●	63	20	80	52	-	54	M18x1	1.340
AHKA63-EM-20-130	○	63	20	130	52	-	104	M18x1	2.140
AHKA63-EM-20-160	○	63	20	160	52	-	134	M18x1	2.630
AHKA63-EM-25-110	○	63	25	110	63	52.8	84	M18x1	2.220
AHKA63-EM-32-110	○	63	32	110	72	52.8	84	M18x1	2.530
AHKA80-EM-06-080	○	80	06	80	25	-	54	M20x1.5	1.260
AHKA80-EM-08-080	○	80	08	80	28	-	54	M20x1.5	1.320
AHKA80-EM-10-080	○	80	10	80	35	-	54	M20x1.5	1.430
AHKA80-EM-12-080	○	80	12	80	42	-	54	M20x1.5	1.580
AHKA80-EM-14-080	○	80	14	80	44	-	54	M20x1.5	1.610
AHKA80-EM-16-100	○	80	16	100	48	-	74	M20x1.5	1.980
AHKA80-EM-18-100	○	80	18	100	50	-	74	M20x1.5	2.040
AHKA80-EM-20-100	○	80	20	100	52	-	74	M20x1.5	2.100
AHKA80-EM-25-100	○	80	25	100	63	-	74	M20x1.5	2.530
AHKA80-EM-32-110	○	80	32	110	72	67.6	84	M20x1.5	3.140
AHKA100-EM-06-080	○	100	06	80	25	-	51	M24x1.5	2.160
AHKA100-EM-06-160	○	100	06	160	25	-	131	M24x1.5	2.460
AHKA100-EM-08-080	○	100	08	80	28	-	51	M24x1.5	2.210
AHKA100-EM-08-160	○	100	08	160	28	-	131	M24x1.5	2.590
AHKA100-EM-10-080	○	100	10	80	35	-	51	M24x1.5	2.310
AHKA100-EM-10-160	○	100	10	160	35	-	131	M24x1.5	2.880
AHKA100-EM-12-080	○	100	12	80	42	-	51	M24x1.5	2.450
AHKA100-EM-12-160	○	100	12	160	42	-	131	M24x1.5	3.300
AHKA100-EM-14-080	○	100	14	80	44	-	51	M24x1.5	2.490
AHKA100-EM-14-160	○	100	14	160	44	-	131	M24x1.5	3.420
AHKA100-EM-16-100	○	100	16	100	48	-	71	M24x1.5	2.840
AHKA100-EM-16-160	○	100	16	160	48	-	131	M24x1.5	3.700
AHKA100-EM-18-100	○	100	18	100	50	-	71	M24x1.5	2.900
AHKA100-EM-18-160	○	100	18	160	50	-	131	M24x1.5	3.830
AHKA100-EM-20-100	○	100	20	100	52	-	71	M24x1.5	2.950
AHKA100-EM-20-160	○	100	20	160	52	-	131	M24x1.5	3.960
AHKA100-EM-25-100	○	100	25	100	63	-	71	M24x1.5	3.370
AHKA100-EM-25-160	○	100	25	160	63	-	131	M24x1.5	4.850
AHKA100-EM-32-100	●	100	32	100	72	-	71	M24x1.5	3.710
AHKA100-EM-32-160	○	100	32	160	72	-	131	M24x1.5	5.560
AHKA100-EM-40-105	○	100	40	105	80	-	76	M24x1.5	4.100
AHKA100-EM-40-160	○	100	40	160	80	-	131	M24x1.5	6.150

Yedek Parça / Spare Part / Ersatzteile

Veldon Sıkma Civatası DIN 1835 B
Clamping Screw Weldon DIN 1835 B
Welding-Klemmschraube DIN 1835 B

Siparişe Dahil / Delivered with / In der Bestellung enthalten

Soğutma Suyu Ünitesi
Cooling Tubes
Kühlmitteleinheit

Siparişe Dahil Değil / Delivered without / Nicht in der Bestellung enthalten

Soğutma Suyu Ünitesi Anahtarı
Wrench For Delivery Unit For Coolant
Schlüssel Für Kühlmittelübergabeeinheit

Sipariş Örneği/Ordering Example/Bestellbeispiel
1 ad./pcs./stück AHKA63-EM-18-080

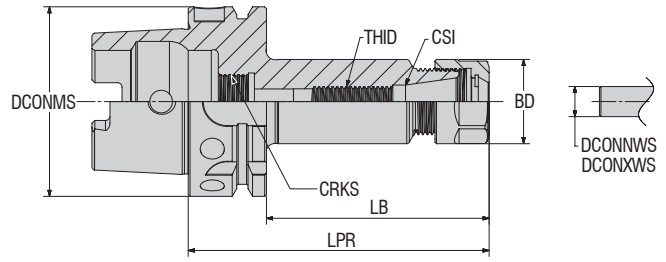

Sipariş Kodu Ordering Code Bestell-Bezeichnung	Stok Stock Lager	Tutucu Ölçüleri (mm) / Dimension (mm) / Abmessung (mm)									
		DCONMS	CSI	DCONWS	DCONXWS	BD	LPR	LB	THID	CRKS	KG
AHKA32-ER-16-080	○	32	ER16	0.5	10	28	80	48	M10	M10x1	0.310
AHKA32-ER-25-080	○	32	ER25	1.0	16	42	80	48	M16	M10x1	0.380
AHKA40-ER-16-060	○	40	ER16	0.5	10	28	60	40	M10	M12x1	0.350
AHKA40-ER-25-060	○	40	ER25	1.0	16	42	60	40	M16	M12x1	0.430
AHKA40-ER-32-100	○	40	ER32	2.0	20	50	100	80	M16	M12x1	0.730
AHKA50-ER-16-100	○	50	ER16	0.5	10	28	100	74	M10	M16x1	0.660
AHKA50-ER-25-100	○	50	ER25	1.0	16	42	100	74	M16	M16x1	0.940
AHKA50-ER-32-100	○	50	ER32	2.0	20	50	100	74	M16	M16x1	0.910
AHKA63-ER-16-075	○	63	ER16	0.5	10	28	75	49	M10	M18x1	0.830
AHKA63-ER-16-100	●	63	ER16	0.5	10	28	100	74	M10	M18x1	0.920
AHKA63-ER-16-160	●	63	ER16	0.5	10	28	160	134	M10	M18x1	1.200
AHKA63-ER-25-100	○	63	ER25	1.0	16	42	100	74	M16	M18x1	1.200
AHKA63-ER-25-160	●	63	ER25	1.0	16	42	160	134	M16	M18x1	1.850
AHKA63-ER-32-075	○	63	ER32	2.0	20	50	75	49	M16	M18x1	1.230
AHKA63-ER-32-100	○	63	ER32	2.0	20	50	100	74	M16	M18x1	1.390
AHKA63-ER-32-160	○	63	ER32	2.0	20	50	160	134	M16	M18x1	2.280
AHKA63-ER-40-085	○	63	ER40	3.0	26	63	85	59	M16	M18x1	1.420
AHKA63-ER-40-100	○	63	ER40	3.0	26	63	100	74	M16	M18x1	1.460
AHKA63-ER-40-160	○	63	ER40	3.0	26	63	160	134	M16	M18x1	2.360
AHKA80-ER-32-100	○	80	ER32	2.0	20	50	100	74	M16	M20x1.5	1.830
AHKA80-ER-40-120	○	80	ER40	3.0	26	63	120	94	M16	M20x1.5	2.720
AHKA100-ER-16-100	○	100	ER16	0.5	10	28	100	71	M10	M24x1.5	2.250
AHKA100-ER-16-160	○	100	ER16	0.5	10	28	160	131	M10	M24x1.5	2.510
AHKA100-ER-25-100	○	100	ER25	1.0	16	42	100	71	M16	M24x1.5	2.510
AHKA100-ER-25-160	○	100	ER25	1.0	16	42	160	131	M16	M24x1.5	3.140
AHKA100-ER-32-100	○	100	ER32	2.0	20	50	100	71	M16	M24x1.5	2.700
AHKA100-ER-32-160	○	100	ER32	2.0	20	50	160	131	M16	M24x1.5	3.590
AHKA100-ER-40-120	○	100	ER40	3.0	26	63	120	91	M16	M24x1.5	3.560
AHKA100-ER-40-160	○	100	ER40	3.0	26	63	160	131	M16	M24x1.5	4.530

Yedek Parça / Spare Part / Ersatzteile



Siparişe Dahil /
Delivered with /
In der Bestellung enthalten

Siparişe Dahil Değil / Delivered without / Nicht in der Bestellung enthalten

Sipariş Örneği/Ordering Example/Bestellbeispiel
1 ad./pcs./stück AHKA32-ER-16-080

Daha fazla bilgi için, 57-67. sayfalara bakabilirsiniz. / For more info, you can check pages between 57-67. /
Weitere Informationen finden Sie auf den Seiten 57-67.

● Stokta / In Stock / Auf Lager ○ Stokta Yok / Non Stock Item / Kein Lagerartikel, Lieferzeit auf Anfrage

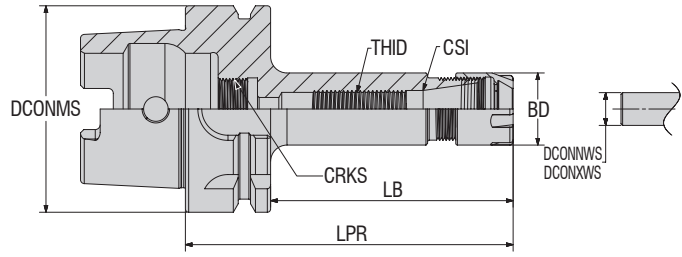

Sipariş Kodu Ordering Code Bestell-Bezeichnung	Stok Stock Lager	Tutucu Ölçüleri (mm) / Dimension (mm) / Abmessung (mm)									
		DCONMS	CSI	DCONNWS	DCONXWS	BD	LPR	LB	THID	CRKS	KG
AHKA50-ER-16-100-M	○	50	ER16	0.5	10	22	100	74	M10	M16x1	0.650
AHKA63-ER-16-100-M	○	63	ER16	0.5	10	22	100	74	M10	M18x1	0.790
AHKA63-ER-16-160-M	○	63	ER16	0.5	10	22	160	74	M10	M18x1	0.970

Yedek Parça / Spare Part / Ersatzteile



Pens Kapağı
Clamping Nuts
Spannmutter



ER Tipi Anahtar Mini (M)
Wrench ER Mini (M)
Spannschlüssel ER Mini (M)



Pensler ER DIN6499/ISO 15488-B
Collet Chuck ER DIN6499/ISO 15488-B
Spannschlüssel ER DIN6499/ISO 15488-B



Soğutma Suyu Ünitesi
Cooling Tubes
Kühlmitteleinheit



Soğutma Suyu Ünitesi Anahtar
Wrench For Delivery Unit For Coolant
Schlüssel Für Kühlmittelübergabeinheit

Siparişe Dahil /
Delivered with /
In der Bestellung enthalten

Siparişe Dahil Değil / Delivered without / Nicht in der Bestellung enthalten

Daha fazla bilgi için, 57-67. sayfalara bakabilirsiniz. / For more info, you can check pages between 57-67. /
Weitere Informationen finden Sie auf den Seiten 57-67.

Sipariş Örneği/Ordering Example/Bestellbeispiel
1 ad./pcs./stück AHKA50-ER-16-100-M

● Stokta / In Stock / Auf Lager ○ Stokta Yok / Non Stock Item / Kein Lagerartikel, Lieferzeit auf Anfrage



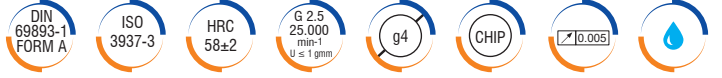
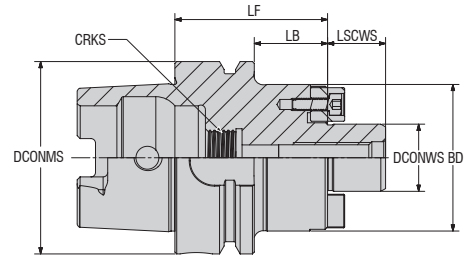

Sipariş Kodu Ordering Code Bestell-Bezeichnung	Stok Stock Lager	Tutucu Ölçüleri (mm) / Dimension (mm) / Abmessung (mm)							
		DCONMS	DCONWS	BD	LF	LSCWS	LB	CRKS	KG
AHKA50-FM-16-050	○	50	16	38	50	17	24	M16x1	0.630
AHKA50-FM-16-100	○	50	16	38	100	17	74	M16x1	0.980
AHKA50-FM-22-060	○	50	22	48	60	19	34	M16x1	0.880
AHKA50-FM-22-100	○	50	22	48	100	19	74	M16x1	1.230
AHKA50-FM-27-060	○	50	27	60	60	21.5	34	M16x1	1.060
AHKA50-FM-32-060	○	50	32	78	60	24	34	M16x1	1.430
AHKA63-FM-16-050	○	63	16	38	50	17	24	M18x1	0.890
AHKA63-FM-16-100	○	63	16	38	100	17	74	M18x1	1.310
AHKA63-FM-22-050	○	63	22	48	50	19	24	M18x1	1.050
AHKA63-FM-22-100	●	63	22	48	100	19	74	M18x1	1.730
AHKA63-FM-27-060	○	63	27	60	60	21.5	34	M18x1	1.430
AHKA63-FM-27-100	●	63	27	60	100	21.5	74	M18x1	2.290
AHKA63-FM-32-060	○	63	32	78	60	24	34	M18x1	1.760
AHKA63-FM-32-100	●	63	32	78	100	24	74	M18x1	2.610
AHKA80-FM-22-100	○	80	22	48	100	19	74	M20x1.5	2.170
AHKA80-FM-27-100	○	80	27	60	100	21.5	74	M20x1.5	2.810
AHKA80-FM-32-100	○	80	32	78	100	24	74	M20x1.5	3.870
AHKA80-FM-40-100	○	80	40	88	100	27	74	M20x1.5	4.090
AHKA100-FM-16-160	○	100	16	38	160	17	131	M24x1.5	3.240
AHKA100-FM-22-100	○	100	22	48	100	19	71	M24x1.5	3.020
AHKA100-FM-22-160	○	100	22	48	160	19	131	M24x1.5	3.960
AHKA100-FM-27-100	○	100	27	60	100	21.5	71	M24x1.5	3.640
AHKA100-FM-27-160	○	100	27	60	160	21.5	131	M24x1.5	5.070
AHKA100-FM-32-100	○	100	32	78	100	24	71	M24x1.5	4.800
AHKA100-FM-32-160	○	100	32	78	160	24	131	M24x1.5	7.210
AHKA100-FM-40-100	○	100	40	88	100	27	71	M24x1.5	5.580
AHKA100-FM-40-160	○	100	40	88	160	27	131	M24x1.5	8.370

Yedek Parça / Spare Part / Ersatzteile



Siparişe Dahil / Delivered with / In der Bestellung enthalten

Siparişe Dahil Değil / Delivered without / Nicht in der Bestellung enthalten

Daha fazla bilgi için, 57-67. sayfalara bakabilirsiniz. / For more info, you can check pages between 57-67. / Weitere Informationen finden Sie auf den Seiten 57-67.

Sipariş Örneği/Ordering Example/Bestellbeispiel
1 ad./pcs./stück AHKA50-FM-16-050

● Stokta / In Stock / Auf Lager ○ Stokta Yok / Non Stock Item / Kein Lagerartikel, Lieferzeit auf Anfrage

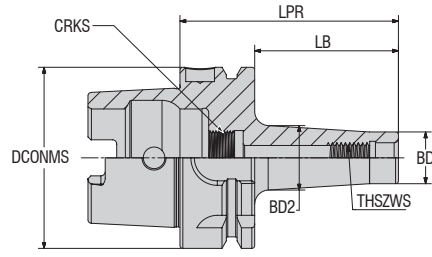

Sipariş Kodu Ordering Code Bestell-Bezeichnung	Stok Stock Lager	Tutucu Ölçüleri (mm) / Dimension (mm) / Abmessung (mm)							
		DCONMS	THSZWS	BD	BD2	LPR	LB	CRKS	KG
AHKA63-MM-10-076	○	63	M10	18	23	76	50	M18x1	0.740
AHKA63-MM-10-126	○	63	M10	18	32	126	100	M18x1	0.990
AHKA63-MM-10-176	○	63	M10	18	36	176	150	M18x1	1.290
AHKA63-MM-12-076	●	63	M12	21	24	76	50	M18x1	0.760
AHKA63-MM-12-101	○	63	M12	21	31	101	75	M18x1	0.910
AHKA63-MM-12-126	○	63	M12	21	33	126	100	M18x1	1.040
AHKA63-MM-12-176	○	63	M12	21	39.5	176	150	M18x1	1.460
AHKA63-MM-16-076	●	63	M16	29	34	76	50	M18x1	0.880
AHKA63-MM-16-101	○	63	M16	29	34	101	75	M18x1	1.030
AHKA63-MM-16-126	○	63	M16	29	36	126	100	M18x1	1.210
AHKA63-MM-16-176	○	63	M16	29	42.5	176	150	M18x1	1.730
AHKA100-MM-10-079	○	100	M10	18	21.5	79	50	M24x1.5	2.120
AHKA100-MM-10-129	○	100	M10	18	31	129	100	M24x1.5	2.340
AHKA100-MM-10-179	○	100	M10	18	35.5	179	150	M24x1.5	2.640
AHKA100-MM-12-079	○	100	M12	21	23.5	79	50	M24x1.5	2.140
AHKA100-MM-12-129	○	100	M12	21	32	129	100	M24x1.5	2.390
AHKA100-MM-12-179	○	100	M12	21	39.5	179	150	M24x1.5	2.780
AHKA100-MM-16-079	○	100	M16	29	33.5	79	50	M24x1.5	2.230
AHKA100-MM-16-129	○	100	M16	29	36	129	100	M24x1.5	2.550
AHKA100-MM-16-179	○	100	M16	29	42.5	179	150	M24x1.5	3.070

Yedek Parça / Spare Part / Ersatzteile

Sipariş Örneği/Ordering Example/Bestellbeispiel
 1 ad./pcs./stück AHKA63-MM-10-076



Soğutma Suyu Ünitesi
 Cooling Tubes
 Kühlmittleinheit



Soğutma Suyu Ünitesi Anahtarı
 Wrench For Delivery Unit For Coolant
 Schlüssel Für Kühlmittelübergabeeinheit

● Stokta / In Stock / Auf Lager ○ Stokta Yok / Non Stock Item / Kein Lagerartikel, Lieferzeit auf Anfrage

Siparişe Dahil Değil / Delivered without / Nicht in der Bestellung enthalten

Daha fazla bilgi için, 57-67. sayfalara bakabilirsiniz. / For more info, you can check pages between 57-67. /
 Weitere Informationen finden Sie auf den Seiten 57-67.



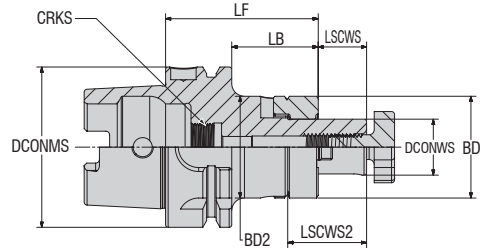

Sipariş Kodu Ordering Code Bestell-Bezeichnung	Stok Stock Lager	Tutucu Ölçüleri (mm) / Dimension (mm) / Abmessung (mm)										KG
		DCONMS	DCONWS	LF	BD	BD2	LSCWS	LSCWS2	LB	CRKS		
AHKA32-FMC-16-055	○	32	16	55	32	-	17	27	35	M10x1	0.320	
AHKA32-FMC-22-055	○	32	22	55	40	-	19	31	35	M10x1	0.430	
AHKA32-FMC-27-065	○	32	27	65	48	-	21	33	45	M10x1	0.700	
AHKA40-FMC-16-050	○	40	16	50	32	-	17	27	30	M12x1	0.410	
AHKA40-FMC-22-050	○	40	22	50	40	-	19	31	30	M12x1	0.500	
AHKA40-FMC-27-065	○	40	27	65	48	-	21	33.5	45	M12x1	0.820	
AHKA50-FMC-16-050	○	50	16	50	32	-	17	27	24	M16x1	0.560	
AHKA50-FMC-22-050	○	50	22	50	40	-	19	31	24	M16x1	0.680	
AHKA50-FMC-27-065	○	50	27	65	48	-	21	33	39	M16x1	0.980	
AHKA50-FMC-32-065	○	50	32	65	58	-	24	38	39	M16x1	1.200	
AHKA63-FMC-16-060	○	63	16	60	32	-	17	27	34	M18x1	0.880	
AHKA63-FMC-16-100	○	63	16	100	32	-	17	27	74	M18x1	1.110	
AHKA63-FMC-16-160	○	63	16	160	32	38.5	17	27	134	M18x1	1.550	
AHKA63-FMC-22-060	○	63	22	60	40	-	19	31	34	M18x1	1.030	
AHKA63-FMC-22-100	○	63	22	100	40	-	19	31	74	M18x1	1.400	
AHKA63-FMC-22-160	○	63	22	160	40	47	19	31	134	M18x1	2.080	
AHKA63-FMC-27-060	○	63	27	60	48	-	21	33.5	34	M18x1	1.220	
AHKA63-FMC-27-100	○	63	27	100	48	-	21	33.5	74	M18x1	1.770	
AHKA63-FMC-32-060	○	63	32	60	58	-	24	38	34	M18x1	1.450	
AHKA63-FMC-32-100	○	63	32	100	58	-	24	38	74	M18x1	2.250	
AHKA63-FMC-32-160	○	63	32	160	58	-	24	38	134	M18x1	3.460	
AHKA63-FMC-40-070	○	63	40	70	70	-	27	41	44	M18x1	2.020	
AHKA63-FMC-40-100	○	63	40	100	70	-	27	41	74	M18x1	2.670	
AHKA63-FMC-40-160	○	63	40	160	70	-	27	41	134	M18x1	3.660	
AHKA80-FMC-16-060	○	80	16	60	32	-	17	27	34	M20x1.5	1.310	
AHKA80-FMC-22-060	○	80	22	60	40	-	19	31	34	M20x1.5	1.470	
AHKA80-FMC-27-060	○	80	27	60	48	-	21	33.5	34	M20x1.5	1.660	
AHKA80-FMC-32-060	○	80	32	60	58	-	24	38	34	M20x1.5	1.940	
AHKA80-FMC-40-070	○	80	40	70	70	-	27	41	44	M20x1.5	2.660	
AHKA100-FMC-16-060	○	100	16	60	32	-	17	27	31	M24x1.5	2.200	
AHKA100-FMC-16-100	○	100	16	100	32	-	17	27	71	M24x1.5	2.440	
AHKA100-FMC-16-130	○	100	16	130	32	-	17	27	101	M24x1.5	2.610	
AHKA100-FMC-16-160	○	100	16	160	32	37.5	17	27	131	M24x1.5	2.880	
AHKA100-FMC-16-200	○	100	16	200	32	38	17	27	171	M24x1.5	3.160	
AHKA100-FMC-22-060	○	100	22	60	40	-	19	31	31	M24x1.5	2.340	
AHKA100-FMC-22-100	○	100	22	100	40	-	19	31	71	M24x1.5	2.700	
AHKA100-FMC-22-130	○	100	22	130	40	-	19	31	101	M24x1.5	2.970	
AHKA100-FMC-22-160	○	100	22	160	40	46	19	31	131	M24x1.5	3.360	
AHKA100-FMC-22-200	○	100	22	200	40	46	19	31	171	M24x1.5	3.780	
AHKA100-FMC-27-060	○	100	27	60	48	-	21	33.5	31	M24x1.5	2.520	
AHKA100-FMC-27-100	○	100	27	100	48	-	21	33.5	71	M24x1.5	3.050	
AHKA100-FMC-27-130	○	100	27	130	48	-	21	33.5	101	M24x1.5	3.450	
AHKA100-FMC-27-160	○	100	27	160	48	54	21	33.5	131	M24x1.5	4.000	
AHKA100-FMC-27-200	○	100	27	200	48	55	21	33.5	171	M24x1.5	4.570	
AHKA100-FMC-32-060	○	100	32	60	58	-	24	38	31	M24x1.5	2.780	
AHKA100-FMC-32-100	○	100	32	100	58	-	24	38	71	M24x1.5	3.580	
AHKA100-FMC-32-130	○	100	32	130	58	-	24	38	101	M24x1.5	4.170	
AHKA100-FMC-32-160	○	100	32	160	58	64.5	24	38	131	M24x1.5	4.960	
AHKA100-FMC-40-070	○	100	40	70	70	-	27	41	41	M24x1.5	3.510	
AHKA100-FMC-40-100	○	100	40	100	70	-	27	41	71	M24x1.5	4.390	
AHKA100-FMC-40-130	○	100	40	130	70	-	27	41	101	M24x1.5	5.270	
AHKA100-FMC-40-160	○	100	40	160	70	-	27	41	131	M24x1.5	6.140	

Yedek Parça / Spare Part / Ersatzteile

Sipariş Örneği/Ordering Example/Bestellbeispiel

1 ad./pcs./stück AHKA32-FMC-16-055



Siparişe Dahil / Delivered with / In der Bestellung enthalten

Siparişe Dahil Değil / Delivered without / Nicht in der Bestellung enthalten

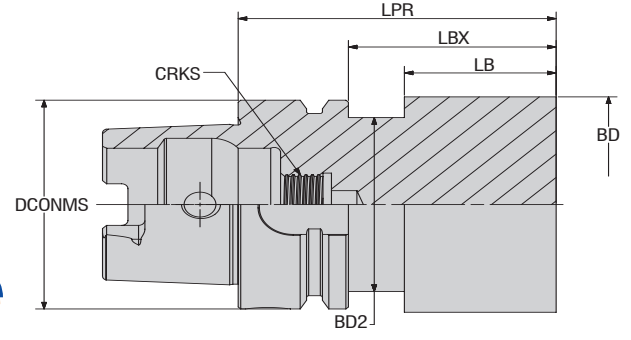

Sipariş Kodu Ordering Code Bestell-Bezeichnung	Stok Stock Lager	BAĞLAMA ÖLÇÜSÜ CONNECTION SIZE BINDUNGSGRÖSSE	Tutucu Ölçüleri (mm) / Dimension (mm) / Abmessung (mm)							
			DCONMS	BD	BD2	LPR	LBX	LB	CRKS	KG
AHSKA32-BL41-025-150	○	32	32	25	-	150	130	-	M10x1	0.610
AHSKA32-BL41-032-100	○		32	32	25	100	80	65	M10x1	0.580
AHSKA40-BL41-040-150	○	40	40	40	32.6	150	130	115	M12x1	1.420
AHSKA40-BL41-070-100	○		40	70	32.6	100	80	65	M12x1	2.240
AHSKA50-BL41-050-150	○	50	50	50	41.6	150	124	108	M16x1	2.210
AHSKA50-BL41-075-070	○		50	75	41.6	70	44	28	M16x1	1.520
AHSKA63-BL41-063-160	○	63	63	63	52.6	160	134	118	M18x1	3.780
AHSKA63-BL41-080-250	○		63	80	52.6	250	224	208	M18x1	9.060
AHSKA63-BL41-120-160	○		63	120	52.6	160	134	118	M18x1	11.320
AHSKA80-BL41-080-250	○	80	80	80	67.6	250	224	208	M20x1.5	9.670
AHSKA80-BL41-090-310	○		80	90	67.6	310	284	268	M20x1.5	14.820
AHSKA100-BL41-097-250	○	100	100	97	87	250	221	205	M24x1.5	14.540
AHSKA100-BL41-120-315	○		100	120	87	315	286	270	M24x1.5	26.540

Yedek Parça / Spare Part / Ersatzteile



Soğutma Suyu Ünitesi
Cooling Tubes
Kühlmittelleinheit



Soğutma Suyu Ünitesi Anahtarı
Wrench For Delivery Unit For Coolant
Schlüssel Für Kühlmittelübergabeeinheit

Siparişe Dahil / Delivered with / In der Bestellung enthalten

Daha fazla bilgi için, 57-67. sayfalara bakabilirsiniz. / For more info, you can check pages between 57-67. / Weitere Informationen finden Sie auf den Seiten 57-67.

Sipariş Örneği/Ordering Example/Bestellbeispiel
1 ad./pcs./stück AHSKA32-BL41-025-150

● Stokta / In Stock / Auf Lager ○ Stokta Yok / Non Stock Item / Kein Lagerartikel, Lieferzeit auf Anfrage

POLİGONAL ŞAFTLI TUTUCULAR

POLYGONAL SHANK HOLDERS

POLYGONSCHAFT HALTER



■ Teknik çizim ve fotoğraflar değişiklik gösterebilir.
Illustrations shown may vary from actual product.
Das Produkt kann von dem gezeigten Bild abweichen.



AKKO®

konuşulan
the spoken kalite...
quality...

www.akkocom.tr

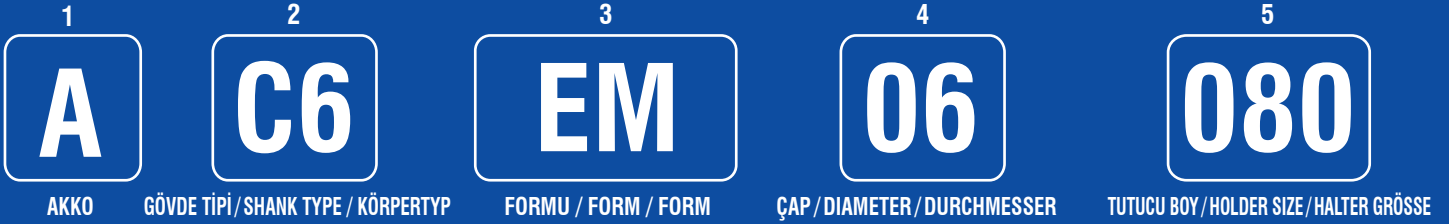

POLYGONAL SHANK 3-4-5-6-8

EM : VELDON ŞAFTLI TAKIM TUTUCULAR / END MILL HOLDER / FRÄSERAUFNAHMEN
ER : ER SIKMA PENSİLİ TAKIM TUTUCULAR / COLLET CHUCKS (ER) / SPANNFUTTER ER
FM : YÜZEY FREZE TAKIM TUTUCULAR / SHELL MILL HOLDERS / AUFSTECKFRÄSERDORNE
MM : MODÜLER PARMAK FREZE TUTUCULAR / MILLING CUTTER ARBORS FOR SCREW-ON TYPE MILLING CUTTERS /
 MODULARE SCHAFTFRÄSERHALTER

FMC : KOMBİNE YÜZEY FREZE TAKIM TUTUCULARI / COMBI SHELL MILL HOLDER / KOMBİNERTE FLÄCHENFRÄSHALTER
ASHR : DİKDÖRTGEN SAPLI KATER TUTUCULAR / TOOLHOLDER AXIAL / WERKZEUGHALTER AXIAL
EX : UZATMA ADAPTÖR TUTUCULAR / EXTENSION / WERKZEUGHALTER AXIAL
RE : REDÜKSİYON ADAPTÖR TUTUCULAR / REDUCER ADAPTER HOLDER / REDUZIERADAPTERHALTER
BL41 : BLANK TUTUCULAR / BLANK HOLDERS / SCHRUMPFVERLÄNGERUNGEN



KALİTE KONTROL

QUALITY CONTROL

QUALITÄTSKONTROLLE

POLYGONAL SHANK

POLYGONAL SHANK 3-4-5-6-8

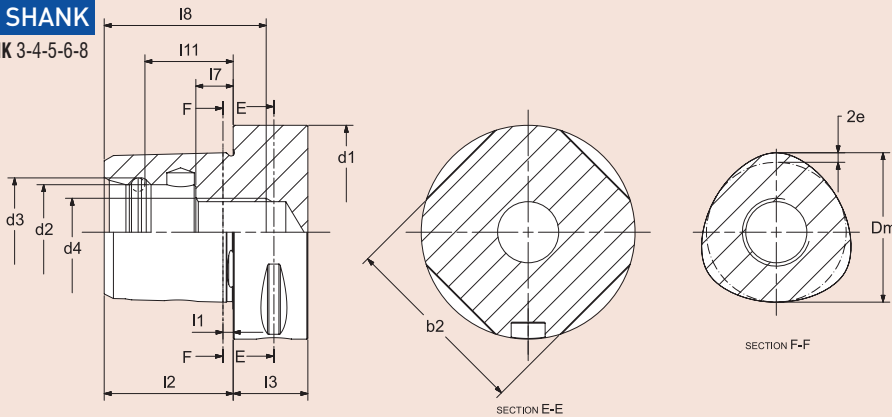

Gegenüber dem Steilkegel hat die POLYGON SHANK Schnittstelle folgende Vorteile:

- Hohe Wiederholgenauigkeit beim Einwechseln von Werkzeugen
- Feste axiale Positionierung durch Plananlage
- Eignung für hohe Drehzahlen
- Kein Anzugsbolzen notwendig
- Schnittstelle mit polygonförmigem Kegel und Plananlage
- Exakte Positionierung in Umfangrichtung
- Sehr hohe Rundlaufgenauigkeit, hohes Drehmoment und hohe Steifigkeit
- Innovatives modulares Werkzeugsystem mit höchster Präzision
- Für Bearbeitung auf Dreh- und Fräszentren gleichermaßen geeignet
- Inkl. Codeträgerbohrung Ø 10 mm

Werkstoff:

- Spezieller Einsatzstahl für hochbeanspruchte Bauteile
- Oberflächenhärte: 58 ± 2 HRC
- Zugfestigkeit im Kern mind. 950 N/mm2

ST'ye kıyasla POLYGON SHANK 'ın sahip olduğu avantajlar şu şekildedir:

- Klempli takımları spindlde bağlarken yüksek oranda tekrarlanabilir doğruluk
- Düz temas yüzeyli sabit eksenel konumlandırma
- Yüksek hızlı kesime uygun
- Çekme saplaması gerekmez
- Arayüz ile eşsiz bir konik poligon ve flanşlı yüz kantağı
- Çevresel yönde tam konumlandırma
- En yüksek salgı hassasiyeti, tork ve sağlamlık
- En yüksek hassasiyete sahip yenilikçi modüler alet sistemi
- Hem torna hem de freze merkezleri için uygun
- Dahili veri çipi için çap Ø 10 mm

Malzeme:

- Yüksek gerilimli parçalar için özel yüzey sertleştirme çeliği
- Yüzey sertliği: 58 ± 2 HRC
- Çekirdekte çekme dayanımı min. 950 N/mm2

Compared to the steep taper the POLYGON SHANK has the following advantages:

- Highly repeatable accuracy when clamping tools into spindle
- Fixed axial positioning with flat contact surface
- Suitable for high speed cutting
- No pull stud necessary
- Interface with a unique tapered polygon and flange face contact
- Exact positioning in the circumferential direction
- Highest runout accuracy, torque and rigidity
- Innovative modular tool system with highest precision
- Suitable for both turning and milling centres
- Incl. bore for data chip Ø 10 mm

Material:

- Special case-hardening steel for highly stressed parts
- Surface hardness: 58 ± 2 HRC
- Tensile strength in core min. 950 N/mm2

POLYGON SHANK	d1 ±0.1	d2 0.1 -0.05	d3 ±0.05	d4	b2	Dm	e	l1	l2 ±0.1	l3 min.	l7 ±0.15	l8 min.	l11 ±0.1
3	32	15	16.5	M12x1.5	28.3	22	0.7	2.5	19	15	6	25	13.5
4	40	18	20	M14x1.5	35.3	28	0.9	2.5	24	20	9	30	17.5
5	50	21	24	M16x1.5	44.4	35	1.12	3	30	20	10	37	22
6	63	28	32	M20x2	55.8	44	1.4	3	38	22	11	47	26
8	80	32	38	M20x2	71.1	55	2	3	48	30	20	48	34

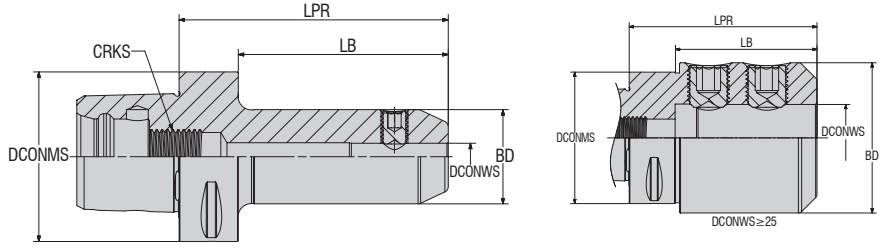

Metrik Ölçüler / Dimensions in Metric / Abmessungen in metrischen

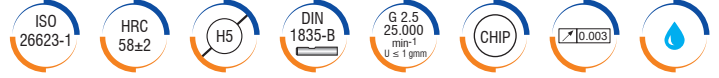

Sipariş Kodu Ordering Code Bestell-Bezeichnung	Stok Stock Lager	Tutucu Ölçüleri (mm) / Dimension (mm) / Abmessung (mm)						
		DCONMS	DCONWS	LPR	BD	LB	CRKS	KG
AC3-EM-06-046	○	32	06	46	25	31	M12x1.5	0.220
AC3-EM-08-046	○	32	08	46	28	31	M12x1.5	0.250
AC3-EM-10-050	○	32	10	50	34	35	M12x1.5	0.330
AC3-EM-12-055	○	32	12	55	42	40	M12x1.5	0.460
AC4-EM-06-050	○	40	06	50	25	30	M14x1.5	0.340
AC4-EM-08-050	○	40	08	50	28	30	M14x1.5	0.370
AC4-EM-10-050	○	40	10	50	35	30	M14x1.5	0.430
AC4-EM-12-055	○	40	12	55	42	35	M14x1.5	0.550
AC4-EM-14-055	○	40	14	55	44	35	M14x1.5	0.550
AC4-EM-16-060	○	40	16	60	48	40	M14x1.5	0.630
AC5-EM-06-050	○	50	06	50	25	30	M16x1.5	0.510
AC5-EM-08-050	○	50	08	50	28	30	M16x1.5	0.540
AC5-EM-10-055	○	50	10	55	35	35	M16x1.5	0.640
AC5-EM-12-060	○	50	12	60	42	40	M16x1.5	0.780
AC5-EM-14-060	○	50	14	60	44	40	M16x1.5	0.800
AC5-EM-16-060	○	50	16	60	48	40	M16x1.5	0.860
AC5-EM-18-060	○	50	18	60	50	40	M16x1.5	0.890
AC5-EM-20-060	○	50	20	60	52	40	M16x1.5	0.900
AC5-EM-25-080	○	50	25	80	65	60	M16x1.5	1.530
AC6-EM-06-075	○	63	06	75	25	53	M20x2	0.900
AC6-EM-06-100	○	63	06	100	25	78	M20x2	1.000
AC6-EM-08-055	○	63	08	55	28	33	M20x2	0.880
AC6-EM-08-075	●	63	08	75	28	53	M20x2	0.960
AC6-EM-08-100	○	63	08	100	28	78	M20x2	1.080
AC6-EM-10-060	●	63	10	60	35	35	M20x2	0.990
AC6-EM-10-075	●	63	10	75	35	53	M20x2	1.100
AC6-EM-10-100	○	63	10	100	35	78	M20x2	1.250
AC6-EM-12-065	●	63	12	65	42	43	M20x2	1.120
AC6-EM-12-100	○	63	12	100	42	78	M20x2	1.480
AC6-EM-14-065	○	63	14	65	44	43	M20x2	1.150
AC6-EM-14-100	●	63	14	100	44	78	M20x2	1.550
AC6-EM-16-065	●	63	16	65	48	43	M20x2	1.240
AC6-EM-16-085	●	63	16	85	48	63	M20x2	1.350

Yedek Parça / Spare Part / Ersatzteile



Veldon Sıkma Civatası DIN 1835 B
Clamping Screw Weldon DIN 1835 B
Weldon-Klemmschraube DIN 1835 B



Soğutma Tüpü
Collant Tube
Kühlmittelschlauch

Siparişe Dahil / Delivered with / In der Bestellung enthalten

Siparişe Dahil Değil / Delivered without / Nicht in der Bestellung enthalten

● Stokta / In Stock / Auf Lager ○ Stokta Yok / Non Stock Item / Kein Lagerartikel, Lieferzeit auf Anfrage

Daha fazla bilgi için, 57-67. sayfalara bakabilirsiniz. / For more info, you can check pages between 57-67. / Weitere Informationen finden Sie auf den Seiten 57-67.

Sipariş Örneği/Ordering Example/Bestellbeispiel
1 ad./pcs./stück AC3-EM-06-046



Metrik Ölçüler / Dimensions in Metric / Abmessungen in metrischen

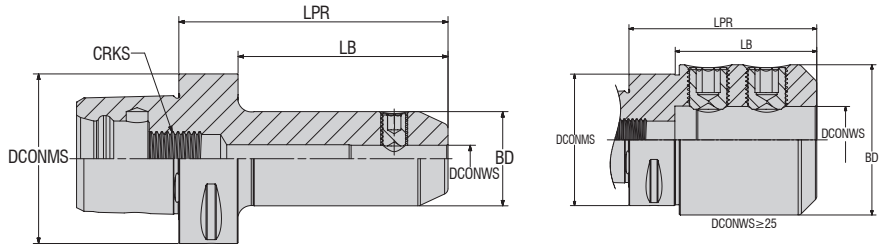

Sipariş Kodu Ordering Code Bestell-Bezeichnung	Stok Stock Lager	Tutucu Ölçüleri (mm) / Dimension (mm) / Abmessung (mm)						
		DCONMS	DCONWS	LPR	BD	LB	CRKS	KG
new AC6-EM-06-055	○	63	06	55	25	33	M20x2	0.880
new AC6-EM-12-080	○	63	12	80	42	58	M20x2	1.185
AC6-EM-16-100	○	63	16	100	48	78	M20x2	1.700
AC6-EM-18-065	●	63	18	65	50	43	M20x2	1.270
new AC6-EM-18-100	○	63	18	100	50	78	M20x2	1.550
AC6-EM-20-065	●	63	20	65	52	43	M20x2	1.290
AC6-EM-20-100	○	63	20	100	52	78	M20x2	1.830
AC6-EM-25-080	●	63	25	80	63	58	M20x2	1.820
AC6-EM-32-090	●	63	32	90	72	68	M20x2	2.350
AC6-EM-40-100	●	63	40	100	79	78	M20x2	2.850
AC8-EM-06-070	○	80	06	70	25	40	M20x2	1.840
AC8-EM-08-070	○	80	08	70	28	40	M20x2	1.880
AC8-EM-10-070	○	80	10	70	35	40	M20x2	1.960
AC8-EM-12-070	○	80	12	70	42	40	M20x2	2.070
AC8-EM-14-070	○	80	14	70	44	40	M20x2	2.090
AC8-EM-16-070	○	80	16	70	48	40	M20x2	2.160
AC8-EM-18-070	○	80	18	70	50	40	M20x2	2.180
AC8-EM-20-070	○	80	20	70	52	40	M20x2	2.190
AC8-EM-25-090	●	80	25	90	63	60	M20x2	2.650
AC8-EM-32-100	●	80	32	100	72	70	M20x2	2.900
AC8-EM-40-110	○	80	40	110	80	80	M20x2	3.920
AC8-EM-50-120	○	80	50	120	100	90	M20x2	5.300

Yedek Parça / Spare Part / Ersatzteile



Veldon Sıkma Civatası DIN 1835 B
Clamping Screw Weldon DIN 1835 B
Weldon-Klemmschraube DIN 1835 B

Siparişe Dahil / Delivered with / In der Bestellung enthalten



Soğutma Tüpü
Coolant Tube
Kühlmittelschlauch

Siparişe Dahil Değil / Delivered without / Nicht in der Bestellung enthalten



İnç Ölçüler/Dimensions in Inches/Abmessungen in Inch

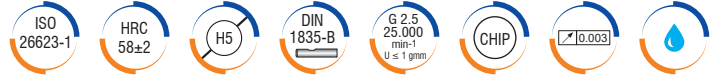
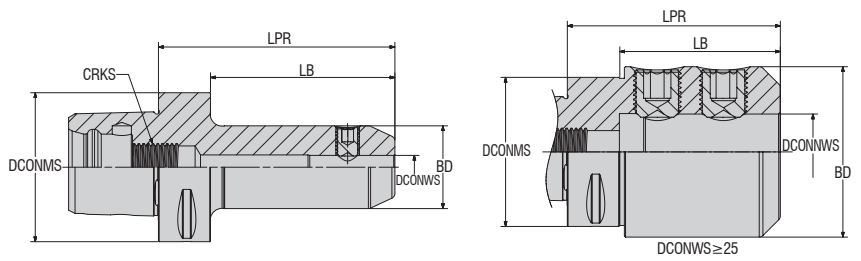

Sipariş Kodu Ordering Code Bestell-Bezeichnung	Stok Stock Lager	Tutucu Ölçüleri (mm) / Dimension (mm) / Abmessung (mm)						
		DCONMS	DCONWS	LPR	BD	LB	CRKS	KG
AC6-EM-0375-237	○	2.480	0.375	2.370	1.000	1.504	M20x2	0.870
AC6-EM-0500-237	○	2.480	0.500	2.370	1.380	1.504	M20x2	0.960
AC6-EM-0625-256	○	2.480	0.625	2.560	1.650	1.694	M20x2	1.100
AC6-EM-0750-256	○	2.480	0.750	2.560	1.890	1.694	M20x2	1.200
AC6-EM-1000-335	○	2.480	1.000	3.350	2.360	2.634	M20x2	1.730
AC6-EM-1250-335	○	2.480	1.250	3.350	2.480	2.634	M20x2	1.690
AC6-EM-1500-354	○	2.480	1.500	3.540	2.755	-	M20x2	-

Yedek Parça / Spare Part / Ersatzteile



Veldon Sıkma Civatası DIN 1835 B
Clamping Screw Weldon DIN 1835 B
Weldon-Klemmschraube DIN 1835 B

Siparişe Dahil / Delivered with / In der Bestellung enthalten



Soğutma Tüpü
Coolant Tube
Kühlmittelschlauch

Siparişe Dahil Değil / Delivered without / Nicht in der Bestellung enthalten



Metrik Ölçüler / Dimensions in Metric / Abmessungen in metrischen

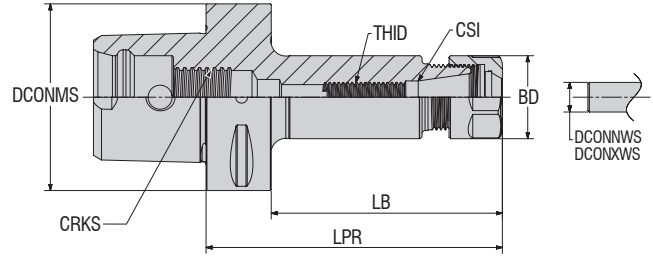

Sipariş Kodu Ordering Code Bestell-Bezeichnung	Stok Stock Lager	Tutucu Ölçüleri (mm) / Dimension (mm) / Abmessung (mm)									
		DCONMS	CSI	DCONNWS	DCONXWS	BD	LPR	LB	THID	CRKS	KG
AC3-ER-16-045	○	32	ER16	1.0	10	28	45	30	M10	M12x1.5	0.190
AC4-ER-16-070	●	40	ER16	1.0	10	28	70	50	M10	M14x1.5	0.410
AC4-ER-25-055	○	40	ER25	1.0	16	42	55	35	M16	M14x1.5	0.400
AC4-ER-32-055	○	40	ER32	2.0	20	50	55	35	M16	M14x1.5	0.440
AC5-ER-16-055	○	50	ER16	1.0	10	28	55	35	M10	M16x1.5	0.520
AC5-ER-16-100	○	50	ER16	1.0	10	28	100	80	M10	M16x1.5	0.710
AC5-ER-16-130	○	50	ER16	1.0	10	28	130	110	M10	M16x1.5	0.820
AC5-ER-25-055	●	50	ER25	1.0	16	42	55	35	M16	M16x1.5	0.600
AC5-ER-25-100	○	50	ER25	1.0	16	42	100	80	M16	M16x1.5	1.030
new AC5-ER-32-055	○	50	ER32	2.0	20	50	55	35	M16	M16x1.5	0.650
AC5-ER-32-100	○	50	ER32	2.0	20	50	100	80	M16	M16x1.5	1.250
AC6-ER-16-060	○	63	ER16	1.0	10	28	60	38	M10	M20x2	0.870
AC6-ER-16-100	○	63	ER16	1.0	10	28	100	78	M10	M20x2	1.030
AC6-ER-16-130	○	63	ER16	1.0	10	28	130	108	M10	M20x2	1.150
AC6-ER-25-060	○	63	ER25	1.0	16	42	60	38	M16	M20x2	0.950
AC6-ER-25-100	●	63	ER25	1.0	16	42	100	78	M16	M20x2	1.340
AC6-ER-25-130	○	63	ER25	1.0	16	42	130	108	M16	M20x2	1.650
AC6-ER-32-060	●	63	ER32	2.0	20	50	60	38	M16	M20x2	1.000
AC6-ER-32-100	●	63	ER32	2.0	20	50	100	78	M16	M20x2	1.560
AC6-ER-32-130	●	63	ER32	2.0	20	50	130	108	M16	M20x2	1.990
AC6-ER-40-065	●	63	ER40	3.0	26	63	65	43	M16	M20x2	1.210
AC6-ER-40-100	●	63	ER40	3.0	26	63	100	78	M16	M20x2	2.010
AC6-ER-40-130	●	63	ER40	3.0	26	63	130	108	M16	M20x2	2.710
AC8-ER-32-070	○	80	ER32	2.0	20	50	70	40	M16	M20x2	1.980
AC8-ER-32-100	○	80	ER32	2.0	20	50	100	70	M16	M20x2	2.420
AC8-ER-32-160	○	80	ER32	2.0	20	50	160	130	M16	M20x2	3.300
AC8-ER-40-070	○	80	ER40	3.0	26	63	70	40	M16	M20x2	2.090
AC8-ER-40-100	○	80	ER40	3.0	26	63	100	70	M16	M20x2	2.800
AC8-ER-40-160	○	80	ER40	3.0	26	63	160	130	M16	M20x2	4.230

Yedek Parça / Spare Part / Ersatzteile



Siparişe Dahil / Delivered with / In der Bestellung enthalten

Siparişe Dahil Değil / Delivered without / Nicht in der Bestellung enthalten

● Stokta / In Stock / Auf Lager ○ Stokta Yok / Non Stock Item / Kein Lagerartikel, Lieferzeit auf Anfrage

Daha fazla bilgi için, 57-67. sayfalara bakabilirsiniz. / For more info, you can check pages between 57-67. / Weitere Informationen finden Sie auf den Seiten 57-67.

Sipariş Örneği/Ordering Example/Bestellbeispiel
1 ad./pcs./stück AC3-ER-16-045



Metrik Ölçüler / Dimensions in Metric / Abmessungen in metrischen

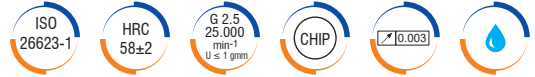
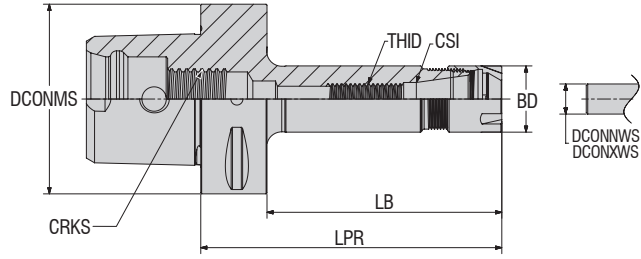

Sipariş Kodu Ordering Code Bestell-Bezeichnung	Stok Stock Lager	Tutucu Ölçüleri (mm) / Dimension (mm) / Abmessung (mm)									
		DCONMS	CSI	DCONNWS	DCONXWS	BD	LPR	LB	THID	CRKS	KG
AC4-ER-16-070-M	●	40	ER16	0.5	10	22	70	50	M10	M14x1.5	0.320
AC5-ER-16-100-M	○	50	ER16	0.5	10	22	100	80	M10	M16x1.5	0.580
AC5-ER-16-130-M	○	50	ER16	0.5	10	22	130	108	M10	M16x1.5	0.754
AC6-ER-16-100-M	○	63	ER16	0.5	10	22	100	78	M10	M20x2	0.910
new AC6-ER-16-130-M	○	63	ER16	0.5	10	22	130	108	M10	M20x2	1.000

Yedek Parça / Spare Part / Ersatzteile



Pens Kapağı
Clamping Nuts
Spannmutter

Siparişe Dahil / Delivered with / In der Bestellung enthalten



ER Tipi Anahtar Mini (M)
Wrench ER Mini (M)
Spannschlüssel ER Mini (M)



Penler ER DIN6499/ISO 15488-B
Collet Chuck ER DIN6499/ISO 15488-B
Spannschlüssel ER DIN6499/ISO 15488-B

Siparişe Dahil Değil / Delivered without / Nicht in der Bestellung enthalten



Soğutma Tüpü
Collant Tube
Kühlmittelschlauch



İnç Ölçüler/Dimensions in Inches/Abmessungen in Inch

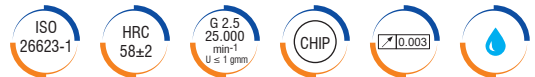
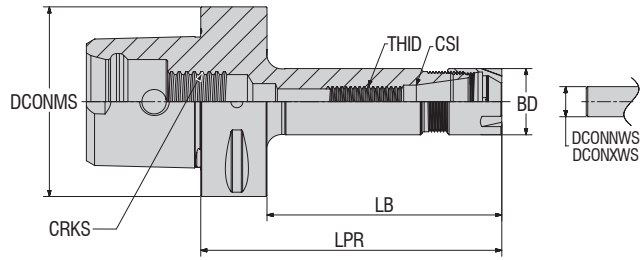

Sipariş Kodu Ordering Code Bestell-Bezeichnung	Stok Stock Lager	Tutucu Ölçüleri (mm) / Dimension (mm) / Abmessung (mm)								
		DCONMS	CSI	DCONNWS	DCONXWS	BD	LPR	LB	THID	KG
AC6-ER-16-3.0	○	2.480	ER16	0.039	0.394	1.102	3.000	2.134	M10	0.930
AC6-ER-32-3.0	○	2.480	ER32	0.079	0.787	1.969	3.000	2.134	-	1.100
AC6-ER-16-6.0	○	2.480	ER16	0.039	0.394	1.102	6.000	5.134	M10	1.333
AC6-ER-32-6.0	○	2.480	ER32	0.079	0.787	1.969	6.000	5.134	-	2.220

Yedek Parça / Spare Part / Ersatzteile



Pens Kapağı
Clamping Nuts
Spannmutter

Siparişe Dahil / Delivered with / In der Bestellung enthalten



ER Tipi Anahtar Mini (M)
Wrench ER Mini (M)
Spannschlüssel ER Mini (M)



Penler ER DIN6499/ISO 15488-B
Collet Chuck ER DIN6499/ISO 15488-B
Spannschlüssel ER DIN6499/ISO 15488-B

Siparişe Dahil Değil / Delivered without / Nicht in der Bestellung enthalten



Soğutma Tüpü
Collant Tube
Kühlmittelschlauch

● Stokta / In Stock / Auf Lager ○ Stokta Yok / Non Stock Item / Kein Lagerartikel, Lieferzeit auf Anfrage

Daha fazla bilgi için, 57-67. sayfalara bakabilirsiniz. / For more info, you can check pages between 57-67. / Weitere Informationen finden Sie auf den Seiten 57-67.

Sipariş Örneği/Ordering Example/Bestellbeispiel
1 ad./pcs./stück AC4-ER-16-070-M

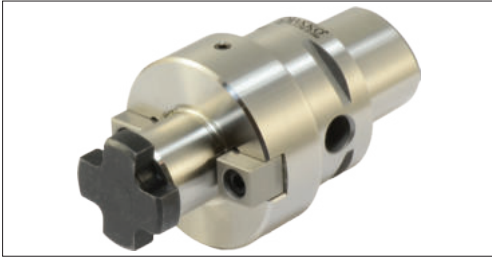

Metrik Ölçüler / Dimensions in Metric / Abmessungen in metrischen

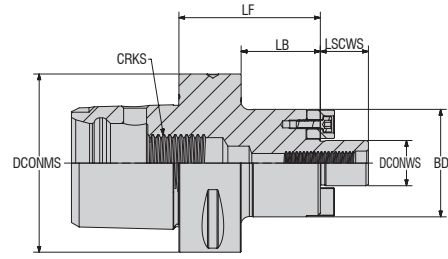

Sipariş Kodu Ordering Code Bestell-Bezeichnung	Stok Stock Lager	Tutucu Ölçüleri (mm) / Dimension (mm) / Abmessung (mm)							
		DCONMS	DCONWS	BD	LSCWS	LB	LF	CRKS	KG
AC3-FM-16-030	○	32	16	38	17	15	30	M12x1.5	0.270
AC4-FM-16-035	●	40	16	38	17	15	35	M14x1.5	0.410
AC4-FM-22-040	●	40	22	48	19	20	40	M14x1.5	0.590
AC5-FM-16-035	●	50	16	38	17	15	35	M16x1.5	0.590
AC5-FM-16-070	○	50	16	36	17	50	70	M16x1.5	0.880
AC5-FM-22-040	●	50	22	48	19	20	40	M16x1.5	0.770
AC5-FM-22-070	●	50	22	48	19	50	70	M16x1.5	1.170
AC5-FM-27-040	●	50	27	60	21.5	20	40	M16x1.5	0.950
AC6-FM-16-035	○	63	16	38	17	13	35	M20x2	0.900
AC6-FM-16-100	○	63	16	38	17	78	100	M20x2	1.450
AC6-FM-22-050	●	63	22	48	19	28	50	M20x2	1.120
AC6-FM-22-100	○	63	22	48	19	78	100	M20x2	1.870
AC6-FM-27-050	●	63	27	60	21.5	28	50	M20x2	1.350
AC6-FM-27-100	○	63	27	60	21.5	78	100	M20x2	2.540
AC6-FM-32-060	●	63	32	78	24	38	60	M20x2	4.800
AC8-FM-27-100	○	80	27	60	21.5	70	100	M20x2	3.340
AC8-FM-32-100	○	80	32	78	24	70	100	M20x2	4.480
AC8-FM-40-060	○	80	40	88	27	30	60	M20x2	3.180

Yedek Parça / Spare Part / Ersatzteile



Alın Kamalı Malafa Kaması
Drive Key
Mitnehmersteine Mit Schraube



Tarama Başlık Sıkma Civatası DIN 6367
Bolt For Shell Arbor DIN 6367
Scankopf-Klemmschraube DIN 6367



Tarama Başlık Civatası Sıkma Anahtarı DIN 6368
Wrench For Shell Arbor DIN 6368
Spannschlüssel DIN 6368 für Aufsteckdorne



Soğutma Tüpü
Collant Tube
Kühlmittelschlauch

Siparişe Dahil / Delivered with / In der Bestellung enthalten

Siparişe Dahil Değil / Delivered without / Nicht in der Bestellung enthalten

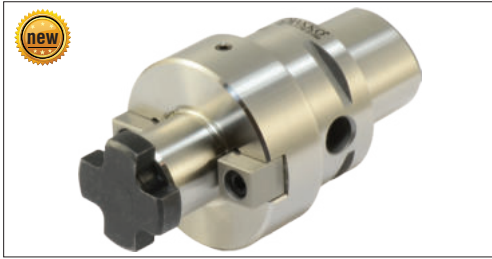

İnç Ölçüler/Dimensions in Inches/Abmessungen in Inch

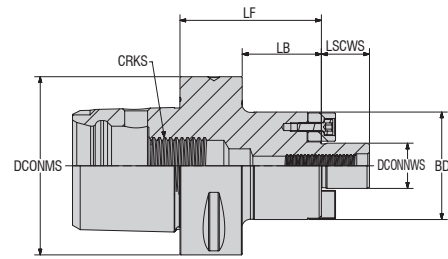

Sipariş Kodu Ordering Code Bestell-Bezeichnung	Stok Stock Lager	Tutucu Ölçüleri (mm) / Dimension (mm) / Abmessung (mm)							
		DCONMS	DCONWS	BD	LSCWS	LB	LF	CRKS	KG
AC6-FM-0750-118	○	2.480	0.750	1.693	3/8-24 UNF	1.180	0.314	M20x2	1.250
AC6-FM-0750-480	○	2.480	0.750	1.693	3/8-24 UNF	4.180	3.314	M20x2	1.900
AC6-FM-0750-756	○	2.480	0.750	1.693	3/8-24 UNF	7.560	5.150	M20x2	2.730
AC6-FM-1000-118	○	2.480	1.000	2.165	1/2-20 UNF	1.180	0.314	M20x2	1.350
AC6-FM-1250-157	○	2.480	1.250	2.756	5/8-18 UNF	1.570	0.704	M20x2	4.500

Yedek Parça / Spare Part / Ersatzteile



Alın Kamalı Malafa Kaması
Drive Key
Mitnehmersteine Mit Schraube



Tarama Başlık Sıkma Civatası DIN 6367
Bolt For Shell Arbor DIN 6367
Scankopf-Klemmschraube DIN 6367



Tarama Başlık Civatası Sıkma Anahtarı DIN 6368
Wrench For Shell Arbor DIN 6368
Spannschlüssel DIN 6368 für Aufsteckdorne



Soğutma Tüpü
Collant Tube
Kühlmittelschlauch

Siparişe Dahil / Delivered with / In der Bestellung enthalten

Siparişe Dahil Değil / Delivered without / Nicht in der Bestellung enthalten



Metrik Ölçüler / Dimensions in Metric / Abmessungen in metrischen

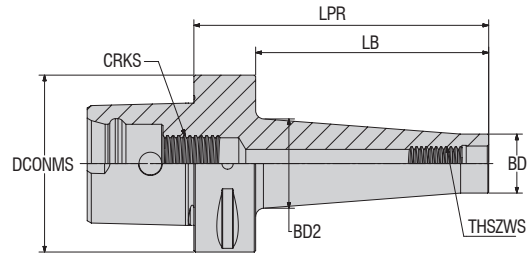

Sipariş Kodu Ordering Code Bestell-Bezeichnung	Stok Stock Lager	Tutucu Ölçüleri (mm) / Dimension (mm) / Abmessung (mm)							
		DCONMS	THSZWS	BD	BD2	LPR	LB	CRKS	KG
AC3-MM-08-030	○	32	M8	13	14.5	30	15	M12x1.5	0.120
AC3-MM-10-030	○	32	M10	18	19.5	30	15	M12x1.5	0.130
AC3-MM-12-035	○	32	M12	21	23.5	35	20	M12x1.5	0.150
AC3-MM-16-040	○	32	M16	29	-	40	25	M12x1.5	0.200
AC4-MM-08-030	○	40	M8	13	14.5	30	10	M14x1.5	0.250
AC4-MM-10-035	○	40	M10	18	19.5	35	15	M14x1.5	0.270
AC4-MM-12-040	○	40	M12	21	23.5	40	20	M14x1.5	0.290
AC4-MM-16-045	○	40	M16	29	-	45	25	M14x1.5	0.330
AC5-MM-08-050	○	50	M8	13	15	50	30	M16x1.5	0.440
AC5-MM-08-075	○	50	M8	13	22.5	75	55	M16x1.5	0.510
AC5-MM-10-050	○	50	M10	18	20	50	30	M16x1.5	0.470
AC5-MM-10-075	○	50	M10	18	23	75	55	M16x1.5	0.540
AC5-MM-12-050	○	50	M12	21	24	50	30	M16x1.5	0.490
AC5-MM-12-075	○	50	M12	21	24	75	55	M16x1.5	0.560
AC5-MM-16-050	○	50	M16	29	-	50	30	M16x1.5	0.520
AC5-MM-16-075	○	50	M16	29	34	75	55	M16x1.5	0.690
AC6-MM-08-050	●	63	M8	13	15	50	28	M16x1.5	0.770
AC6-MM-08-075	●	63	M8	13	22.5	75	53	M16x1.5	0.840
AC6-MM-10-050	●	63	M10	18	20	50	28	M16x1.5	0.790
AC6-MM-10-075	●	63	M10	18	23	75	53	M16x1.5	0.860
AC6-MM-12-050	●	63	M12	21	24	50	28	M16x1.5	0.810
AC6-MM-12-075	●	63	M12	21	24	75	53	M16x1.5	0.880
AC6-MM-16-050	○	63	M16	29	-	50	28	M16x1.5	0.850
AC6-MM-16-075	○	63	M16	29	34	75	53	M16x1.5	1.010
AC8-MM-08-085	○	80	M8	13	22.5	85	55	M20x2	1.810
AC8-MM-10-085	○	80	M10	18	23	85	55	M20x2	1.840
AC8-MM-12-085	○	80	M12	21	24	85	55	M20x2	1.850
AC8-MM-16-085	○	80	M16	29	34	85	55	M20x2	1.990

Yedek Parça / Spare Part / Ersatzteile



Siparişe Dahil Değil / Delivered without / Nicht in der Bestellung enthalten

● Stokta / In Stock / Auf Lager ○ Stokta Yok / Non Stock Item / Kein Lagerartikel, Lieferzeit auf Anfrage

Sipariş Örneği/Ordering Example/Bestellbeispiel
 1 ad./pcs./stück AC3-MM-08-030



Metrik Ölçüler / Dimensions in Metric / Abmessungen in metrischen

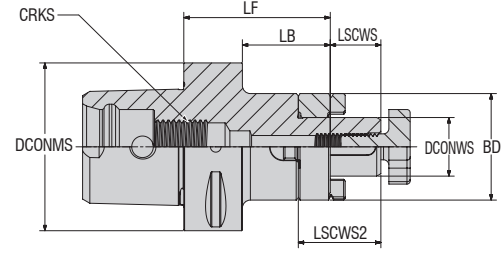

Sipariş Kodu Ordering Code Bestell-Bezeichnung	Stok Stock Lager	Tutucu Ölçüleri (mm) / Dimension (mm) / Abmessung (mm)								
		DCONMS	DCONWS	LF	BD	LSCWS	LSCWS2	LB	CRKS	KG
AC3-FMC-16-045	○	32	16	45	32	17	27	30	M12x1.5	0.320
AC4-FMC-16-045	○	40	16	45	32	17	27	25	M14x1.5	0.430
AC4-FMC-22-050	○	40	22	50	40	19	31	30	M14x1.5	0.590
AC5-FMC-16-045	○	50	16	45	32	17	27	25	M16x1.5	0.600
AC5-FMC-16-070	○	50	16	70	32	17	27	50	M16x1.5	0.750
AC5-FMC-22-045	○	50	22	45	40	19	31	25	M16x1.5	0.720
AC5-FMC-22-070	○	50	22	70	40	19	31	50	M16x1.5	0.950
AC5-FMC-27-055	○	50	27	55	48	21	33.5	35	M16x1.5	1.010
AC5-FMC-32-055	○	50	32	55	58	24	38	35	M16x1.5	1.290
AC6-FMC-16-050	○	63	16	50	32	17	27	28	M20x2	0.950
AC6-FMC-16-100	○	63	16	100	32	17	27	78	M20x2	1.240
AC6-FMC-22-055	○	63	22	55	40	19	31	33	M20x2	1.120
AC6-FMC-22-100	○	63	22	100	40	19	31	78	M20x2	1.530
AC6-FMC-27-055	●	63	27	55	48	21	33.5	33	M20x2	1.310
AC6-FMC-27-100	●	63	27	100	48	21	33.5	78	M20x2	1.910
AC6-FMC-32-055	○	63	32	55	58	24	38	33	M20x2	1.590
AC6-FMC-40-060	●	63	40	60	70	27	41	38	M20x2	2.180
AC8-FMC-16-060	○	80	16	60	32	17	27	30	M20x2	1.930
AC8-FMC-22-060	○	80	22	60	40	19	31	30	M20x2	2.060
AC8-FMC-27-065	○	80	27	65	48	21	33.5	35	M20x2	2.300
AC8-FMC-32-065	○	80	32	65	58	24	38	35	M20x2	2.600
AC8-FMC-40-070	○	80	40	70	70	27	41	40	M20x2	3.210

Yedek Parça / Spare Part / Ersatzteile



Tarama Başlık Sıkma Cıvatası DIN 6367
Bolt For Shell Arbor DIN 6367
Scankopf-Klemmschraube DIN 6367



Kama DIN 6885
Drive Key DIN 6885
Paßfeder DIN 6885



Timaklı Pul DIN 6366
Clutch Drive Rings To DIN 6366
Mitnehmerringe DIN 6366



Tarama Başlık Cıvatası Sıkma Anahtar DIN 6368
Wrench For Shell Arbor DIN 6368
Spannschlüssel DIN 6368 für Aufsteckdorne



Soğutma Tüpü
Coolant Tube
Kühlmittelschlauch

Siparişe Dahil / Delivered with / In der Bestellung enthalten

Siparişe Dahil Değil / Delivered without / Nicht in der Bestellung enthalten

● Stokta / In Stock / Auf Lager ○ Stokta Yok / Non Stock Item / Kein Lagerartikel, Lieferzeit auf Anfrage

Sipariş Örneği/Ordering Example/Bestellbeispiel
1 ad./pcs./stück AC3-FMC-16-045

Daha fazla bilgi için, 57-67. sayfalara bakabilirsiniz. / For more info, you can check pages between 57-67. /
Weitere Informationen finden Sie auf den Seiten 57-67.



Metrik Ölçüler / Dimensions in Metric / Abmessungen in metrischen

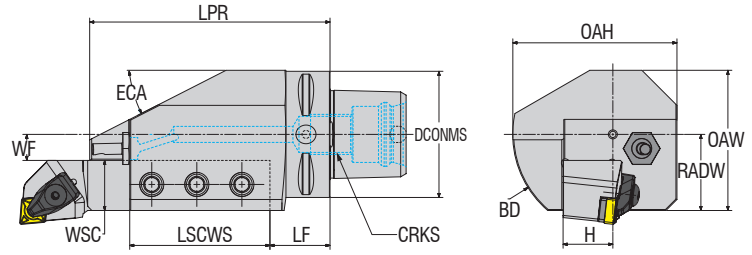

Sipariş Kodu Ordering Code Bestell-Bezeichnung	Stok Stock Lager	Tutucu Ölçüleri (mm) / Dimension (mm) / Abmessung (mm)														
		DCONMS	LPR	LSCWS	LF	WF	H	WSC	OAH	RADW	OAW	BD	ECA	HAND	CRKS	KG
AC4-ASHR-1616-1-H	○	40	104	70	29	7	16	16	48	23	43.5	60	30	R	M14x1.5	1.500
AC5-ASHR-2020-1-H	●	50	98	63.5	24.5	10	20	20	74	30	59	90	30	R	M16x1.5	2.180
AC6-ASHR-2020-1-H	○	63	100	63.5	26.5	10	20	20	74	30	59	90	30	R	M20x2	2.510
AC6-ASHR-2525-1-H	○	63	120	70	30	13	25	25	82	38	70	100	27	R	M20x2	3.630
AC8-ASHR-3232-1-H	○	80	140	90	40	8	32	32	87	40	80	109	27	R	M20x2	6.640
new AC6-ASHL-2020-1-H	○	63	100	63.5	26.5	10	20	20	74	30	59	90	30	L	M20x2	2.510
new AC6-ASHL-2525-1-H	○	63	120	70	30	13	25	25	82	38	70	100	27	L	M20x2	3.630

Yedek Parça / Spare Part / Ersatzteile



Siparişe Dahil Değil / Delivered without / Nicht in der Bestellung enthalten



İnç Ölçüler/Dimensions in Inches/Abmessungen in Inch

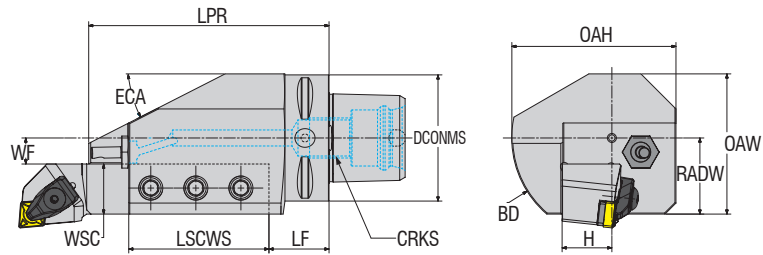

Sipariş Kodu Ordering Code Bestell-Bezeichnung	Stok Stock Lager	Tutucu Ölçüleri (mm) / Dimension (mm) / Abmessung (mm)														
		DCONMS	LPR	LSCWS	LF	WF	H	WSC	OAH	RADW	OAW	BD	ECA	HAND	CRKS	KG
AC6-ASHR-16-1-H	○	2.480	4.724	2.756	1.181	0.504	1.039	0.992	3.228	1.496	2.756	3.937	27	R	M20x2	2.139
AC6-ASHL-16-1-H	○	2.480	4.724	2.756	1.181	0.504	1.039	0.992	3.228	1.496	2.756	3.937	27	L	M20x2	2.139

Yedek Parça / Spare Part / Ersatzteile



Siparişe Dahil Değil / Delivered without / Nicht in der Bestellung enthalten

Sipariş Örneği/Ordering Example/Bestellbeispiel
1 ad./pcs./stück AC4-ASHR-16-1

● Stokta / In Stock / Auf Lager ○ Stokta Yok / Non Stock Item / Kein Lagerartikel, Lieferzeit auf Anfrage



Metrik Ölçüler / Dimensions in Metric / Abmessungen in metrischen

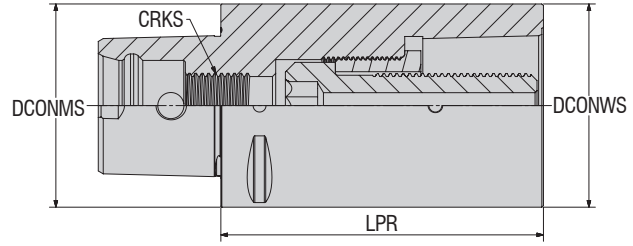

Sipariş Kodu Ordering Code Bestell-Bezeichnung	Stok Stock Lager	Tutucu Ölçüleri (mm) / Dimension (mm) / Abmessung (mm)					Yedek Parça / Spare Parts / Ersatzteile		
		DCONMS	DCONWS	LPR	CRKS	KG	Montaj Vidası Mounting Screw Монтажный Винт	Sıkma Vidası Screw Klemmschraube	Segman Ring Feder
AC3-EX-C3-060	○	32	32	60	M12	0.670	2508-M12x1.5x42	5000-M18x1.5x12	-
AC3-EX-C3-080	○	32	32	80	M12	0.893	2508-M12x1.5x42	5000-M18x1.5x12	-
AC4-EX-C4-060	○	40	40	60	M14	0.892	2510-M14x1.5x48	5000-M22x1.5x14	-
AC4-EX-C4-080	○	40	40	80	M14	1.190	2510-M14x1.5x48	5000-M22x1.5x14	-
AC5-EX-C5-080	○	50	50	80	M16	1.487	2510-M16x1.5x57	5000-M25x1.5x17	-
AC5-EX-C5-100	○	50	50	100	M16	1.858	2510-M16x1.5x57	5000-M25x1.5x17	-
AC6-EX-C6-060	●	63	63	60	M20	1.150	2514-M20x2x62	-	AS-04
AC6-EX-C6-100	○	63	63	100	M20	2.230	2514-M20x2x70	5000-M30x1.5x21	-
AC6-EX-C6-140	○	63	63	140	M20	2.900	2514-M20x2x70	5000-M30x1.5x21	-
AC8-EX-C8-100	○	80	80	100	M20	2.750	2514-M20x2x70	5000-M30x1.5x21	-
AC8-EX-C8-125	○	80	80	125	M20	3.437	2514-M20x2x70	5000-M30x1.5x21	-

Yedek Parça / Spare Part / Ersatzteile



Siparişe Dahil Değil
Delivered without
Nicht in der Bestellung enthalten



Metrik Ölçüler / Dimensions in Metric / Abmessungen in metrischen

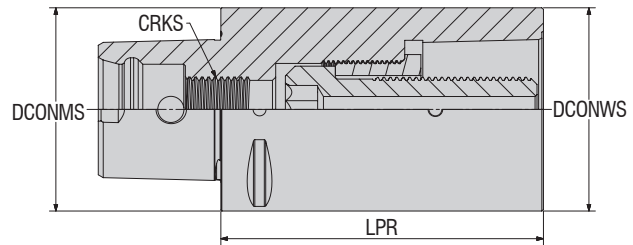

Sipariş Kodu Ordering Code Bestell-Bezeichnung	Stok Stock Lager	Tutucu Ölçüleri (mm) / Dimension (mm) / Abmessung (mm)					Yedek Parça / Spare Parts / Ersatzteile		
		DCONMS	DCONWS	LPR	CRKS	KG	Montaj Vidası Mounting Screw Монтажный Винт	Sıkma Vidası Screw Klemmschraube	Segman Ring Feder
AC5-RE-C3-060	○	50	32	60	M16	1.356	2508-M12x1.5x42	5000-M18x1.5x12	-
AC5-RE-C4-065	○	50	40	65	M16	1.808	2510-M14x1.5x48	5000-M22x1.5x14	-
AC6-RE-C4-080	○	63	40	80	M20	3.270	2510-M14x1.5x48	5000-M22x1.5x14	-
AC6-RE-C5-080	○	63	50	80	M20	3.470	2510-M16x1.5x57	5000-M25x1.5x17	-
AC8-RE-C3-060	○	80	32	60	M20	1.068	2508-M12x1.5x42	5000-M18x1.5x12	-
AC8-RE-C4-070	○	80	40	70	M20	1.424	2510-M14x1.5x48	5000-M22x1.5x14	-
AC8-RE-C5-080	○	80	50	80	M20	1.782	2510-M16x1.5x57	5000-M25x1.5x17	-
AC8-RE-C6-055	○	80	63	55	M20	1.468	2514-M20x2x67-30.8	-	AS-05
AC8-RE-C6-080	○	80	63	80	M20	2.136	2514-M20x2x70	5000-M30x1.5x21	-

Yedek Parça / Spare Part / Ersatzteile



Siparişe Dahil Değil
Delivered without
Nicht in der Bestellung enthalten

Sipariş Örneği/Ordering Example/Bestellbeispiel
1 ad./pcs./stück AC6-EX-C6-100



Metrik Ölçüler / Dimensions in Metric / Abmessungen in metrischen

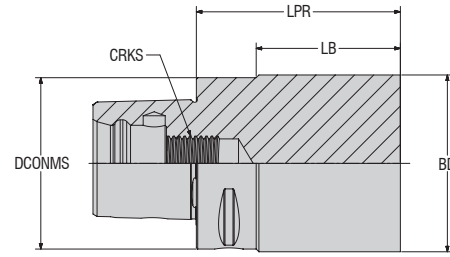

Sipariş Kodu Ordering Code Bestell-Bezeichnung	Stok Stock Lager	BAĞLAMA ÖLÇÜSÜ CONNECTION SIZE BINDUNGSGRÖSSE	Tutucu Ölçüleri (mm) / Dimension (mm) / Abmessung (mm)					
			DCONMS	BD	LPR	LB	CRKS	KG
AC3-BL41-032-090	●	C3	32	32	90	75	M12x1.5	0.600
AC3-BL41-032-125	○		32	32	125	110	M12x1.5	0.800
AC3-BL41-060-090	○		32	60	90	75	M12x1.5	1.780
AC4-BL41-040-045	○	C4	40	40	45	25	M14x1.5	0.500
AC4-BL41-040-165	○		40	40	165	145	M14x1.5	1.670
AC4-BL41-052-065	○		40	52	65	45	M14x1.5	0.990
AC4-BL41-070-100	●		40	70	100	80	M14x1.5	2.610
AC5-BL41-050-050	○	C5	50	50	50	30	M16x1.5	0.900
AC5-BL41-050-175	○		50	50	175	155	M16x1.5	2.800
AC5-BL41-075-070	○		40	75	70	50	M16x1.5	2.110
AC5-BL41-075-175	●		50	75	175	155	M16x1.5	5.790
AC6-BL41-063-048	●	C6	63	63	48	26	M20X2	1.380
AC6-BL41-063-100	○		63	63	100	78	M20X2	2.720
AC6-BL41-063-195	○		63	63	195	175	M20X2	4.960
AC6-BL41-063-310	○		63	63	310	288	M20X2	7.750
AC6-BL41-080-250	○		63	80	250	228	M20X2	9.660
AC8-BL41-080-055	○	C8	80	80	55	24	M20X2	2.710
AC8-BL41-120-160	○		80	120	160	129	M20X2	13.260

Yedek Parça / Spare Part / Ersatzteile

Sipariş Örneği/Ordering Example/Bestellbeispiel
1 ad./pcs./stück AC3-BL41-032-090



Soğutma Tüpü
Coolant Tube
Kühlmittelschlauch

Siparişe Dahil Değil
Delivered without
Nicht in der Bestellung enthalten

● Stokta / In Stock / Auf Lager ○ Stokta Yok / Non Stock Item / Kein Lagerartikel, Lieferzeit auf Anfrage

ISO 26623-1 / POLİGONAL ŞAFTLI DÜZ UZATMA ADAPTÖR TUTUCULAR
ISO 26623-1 / POLYGONAL SHANK FLAT EXTENSION ADAPTER HOLDER
ISO 26623-1 / POLYAGONALER SCHAFT FLACHVERLÄNGERUNGSADAPTERHALTER



Metrik Ölçüler / Dimensions in Metric / Abmessungen in metrischen

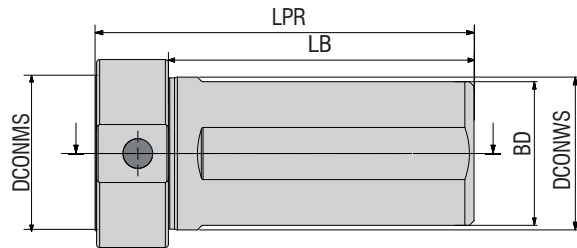

Sipariş Kodu Ordering Code Bestell-Bezeichnung	Stok Stock Lager	Tutucu Ölçüleri (mm) / Dimension (mm) / Abmessung (mm)					
		DCONMS	DCONWS	LPR	BD	LB	CRKS
AC5-NC3000-10024-D050	○	50	50	124	47	100	M16

MINI CUT TUTUCULAR

MINI CUT HOLDERS

MINI-CUT-HALTER



■ Teknik çizim ve fotoğraflar değişkenlik gösterebilir.
Illustrations shown may vary from actual product.
Das Produkt kann von dem gezeigten Bild abweichen.



AKKO[®]

*konuşulan
the spoken kalite...
quality...*

www.akko.com.tr

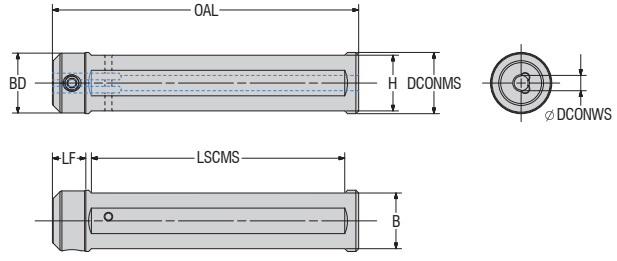

Sipariş Kodu Ordering Code Bestell-Bezeichnung	Stok Stock Lager	Tutucu Ölçüleri (mm) / Dimension (mm) / Abmessung (mm)							
		DCONWS	OAL	DCONMS	BD	LF	LSCMS	B	H
APCH-16-4-L110-H	○	4	110	16	-	-	92	14	14
APCH-16-5-L110-H	○	5	110	16	-	-	92	14	14
APCH-16-6-L110-H	○	6	110	16	21	13	91	14	14
APCH-16-7-L110-H	○	7	110	16	21	13	91	14	14
APCH-20-4-L110-H	○	4	110	20	19.50	11	91	18.80	18.80
APCH-20-5-L110-H	●	5	110	20	19.50	11	91	18.80	18.80
APCH-20-6-L110-H	○	6	110	20	19.50	11	91	18.80	18.80
APCH-20-7-L110-H	○	7	110	20	19.50	11	91	18.80	18.80
new APCH-20-8-L110-H	○	8	110	20	22.50	15	87	18.80	18.80
new APCH-20-10-L110-H	○	10	110	20	26	15	98	18.80	18.80
APCH-22-4-L110-H	○	4	110	22	21.50	12	91	20	20
APCH-22-5-L110-H	●	5	110	22	21.50	12	91	20	20
APCH-22-6-L110-H	○	6	110	22	21.50	12	91	20	20
APCH-22-7-L110-H	○	7	110	22	21.50	12	91	20	20
new APCH-22-8-L110-H	○	8	110	22	22.50	15	87	20	20
new APCH-22-10-L110-H	○	10	110	22	26	15	87	20	20
APCH-25-4-L110-H	●	4	110	25	24.50	12	91	23	23
APCH-25-5-L110-H	○	5	110	25	24.50	12	91	23	23
APCH-25-6-L110-H	○	6	110	25	24.50	12	91	23	23
APCH-25-7-L110-H	○	7	110	25	24.50	12	91	23	23
new APCH-25-8-L110-H	○	8	110	25	24.50	17	86	23	23
new APCH-25-10-L110-H	○	10	110	25	26	15	87	23	23

Yedek Parça / Spare Part / Ersatzteile



Mini Cut Sıkma Civatası
Mini Cut Screw
Mini Cut Spannbolzen



Mini Cut Merkezleme Pimi
Mini Cut Centering Pin
Mini Cut-Zentrierstift

Siparişe Dahil /
Delivered with /
In der Bestellung enthalten

● Stokta / In Stock / Auf Lager ○ Stokta Yok / Non Stock Item / Kein Lagerartikel, Lieferzeit auf Anfrage

Daha fazla bilgi için, 57-67. sayfalara bakabilirsiniz. / For more info, you can check pages between 57-67. / Weitere Informationen finden Sie auf den Seiten 57-67.

Sipariş Örneği/Ordering Example/Bestellbeispiel
1 ad./pcs./stück APCH-16-4-L110-H



➤ VİDALI TAKIM TUTUCULARI
SCREWED TOOL HOLDERS
AUFNAHME FÜR EINSCHRAUBFRÄSER

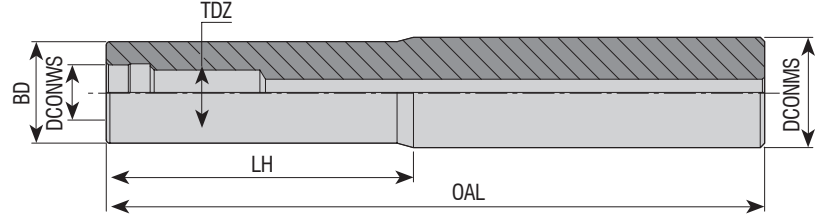

Sipariş Kodu Ordering Code Bestell-Bezeichnung	Stok Stock Lager	Tutucu Ölçüleri (mm) / Dimension (mm) / Abmessung (mm)					
		DCONWS	TDZ	DCONWS	BD	OAL	LH
AVTT-D13-C16-M08-L100-H	●	16	M08	8.5	13	100	40
AVTT-D15-C16-M08-L130-H	●	16	M08	8.5	15	130	70
AVTT-D18-C20-M10-L130-H	●	20	M10	10.5	18	130	70
AVTT-D18-C20-M10-L160-H	●	20	M10	10.5	18	160	80
AVTT-D23-C25-M12-L150-H	●	25	M12	12.5	23	150	70
AVTT-D23-C25-M12-L200-H	●	25	M12	12.5	23	200	100
AVTT-D23-C25-M12-L250-H	●	25	M12	12.5	23	250	150
AVTT-D30-C32-M16-L150-H	●	32	M16	17	30	150	70
AVTT-D30-C32-M16-L200-H	●	32	M16	17	30	200	100
AVTT-D30-C32-M16-L250-H	●	32	M16	17	30	250	150
AVTT-D30-C32-M16-L300-H	○	32	M16	17	30	300	200

➤ DÖNER BRÖŞ AÇMA TAKIMLARI
ROTARY BROACH TOOL HOLDERS
HALTER FÜR ROTATIONSBRÄUHWERKZEUGE

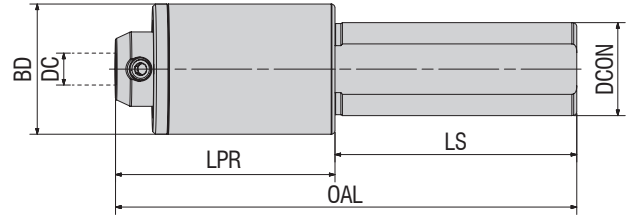

Sipariş Kodu Ordering Code Bestell-Bezeichnung	Stok Stock Lager	Tutucu Ölçüleri (mm) / Dimension (mm) / Abmessung (mm)						
		BD	DC	WD	LPR	LS	OAL	DCON
new ABTH-D08-W22-L125	○	Ø35.00	Ø8.00	15.00	60.00	65.00	125.00	Ø22.00
ABTH-D08-W25-L125	●	Ø35.00	Ø8.00	15.00	60.00	65.00	125.00	Ø25.00
new ABTH-D10-W20-L125	○	Ø35.00	Ø10.00	22.00	60.00	65.00	125.00	Ø20.00
new ABTH-D10-W22-L125	○	Ø35.00	Ø10.00	22.00	60.00	65.00	125.00	Ø22.00
new ABTH-D10-W25-L125	○	Ø35.00	Ø10.00	22.00	60.00	65.00	125.00	Ø25.00
new ABTH-D12-W25-L125	○	Ø53.00	Ø12.00	22.00	70.00	65.00	157.00	Ø25.00

Sipariş Örneği/Ordering Example/Bestellbeispiel
1 ad./pcs./stück AVTT-D13-C16-M08-L100-H

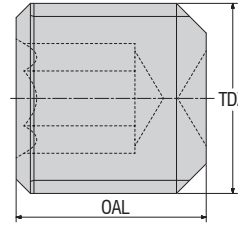

Sipariş Kodu Ordering Code Bestell-Bezeichnung	Tutucu Ölçüleri (mm) / Dimension (mm) / Abmessung (mm)				Ürün Detayı / Product Detail / Produkt-Details	
	TDZ	OAL	SS			
2803-M6x9	M6	9	6	VELDON TUTUCULARI İÇİN / FOR WELDON HOLDERS / FÜR VELDON HALTER	EM6	
2804-M8x9	M8	9	8	VELDON TUTUCULARI İÇİN / FOR WELDON HOLDERS / FÜR VELDON HALTER	EM8	
2805-M10x12	M10	12	10	VELDON TUTUCULARI İÇİN / FOR WELDON HOLDERS / FÜR VELDON HALTER	EM10	
2806-M12x14	M12	14	12.14	VELDON TUTUCULARI İÇİN / FOR WELDON HOLDERS / FÜR VELDON HALTER	EM12, EM14	
2806-M14x16	M14	16	16.18	VELDON TUTUCULARI İÇİN / FOR WELDON HOLDERS / FÜR VELDON HALTER	EM16, EM18	
2808-M16x16	M16	16	20	VELDON TUTUCULARI İÇİN / FOR WELDON HOLDERS / FÜR VELDON HALTER	EM20	
2810-M18x20	M18	20	25	VELDON TUTUCULARI İÇİN / FOR WELDON HOLDERS / FÜR VELDON HALTER	EM25	
2810-M20x20	M20	20	32.40	VELDON TUTUCULARI İÇİN / FOR WELDON HOLDERS / FÜR VELDON HALTER	EM32, EM40	
2812-M24x25	M24	25	50	VELDON TUTUCULARI İÇİN / FOR WELDON HOLDERS / FÜR VELDON HALTER	EM50	

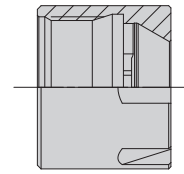
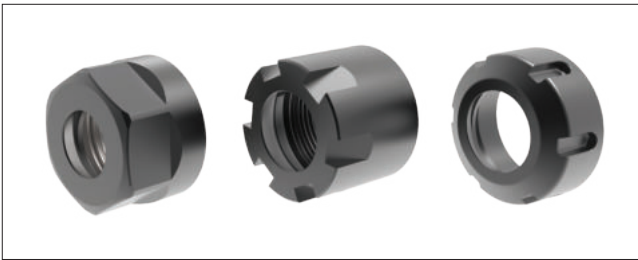

ER 11, 16, 20, 25 Mini

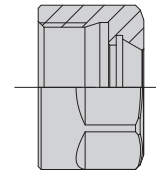

ER 16, 20

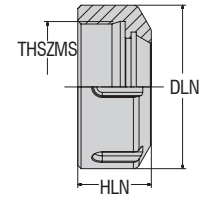

ER 25, 32, 40, 50

Sipariş Kodu Ordering Code Bestell-Bezeichnung	Tutucu Ölçüleri (mm) / Dimension (mm) / Abmessung (mm)				Ürün Detayı / Product Detail / Produkt-Details	
	DLN	HLN	THSZMS	N-m		
ANUT-ER11-M	16.00	12.00	M13x0.75	29.4	PENS TUTUCULARI İÇİN / FOR COLLET CHUCK HOLDERS / FÜR SPANNZANGEAUFNAHME	ER11-M
ANUT-ER16-M	22.00	18.00	M19x1.0	39.2	PENS TUTUCULARI İÇİN / FOR COLLET CHUCK HOLDERS / FÜR SPANNZANGEAUFNAHME	ER16-M
ANUT-ER16	28.00	17.00	M22x1.5	68.7	PENS TUTUCULARI İÇİN / FOR COLLET CHUCK HOLDERS / FÜR SPANNZANGEAUFNAHME	ER16
ANUT-ER20-M	28.00	19.00	M24x1.0	78.5	PENS TUTUCULARI İÇİN / FOR COLLET CHUCK HOLDERS / FÜR SPANNZANGEAUFNAHME	ER20-M
ANUT-ER20	34.00	19.00	M25x1.5	117.7	PENS TUTUCULARI İÇİN / FOR COLLET CHUCK HOLDERS / FÜR SPANNZANGEAUFNAHME	ER20
ANUT-ER25-M	35.00	20.00	M30x1.0	98.1	PENS TUTUCULARI İÇİN / FOR COLLET CHUCK HOLDERS / FÜR SPANNZANGEAUFNAHME	ER25-M
ANUT-ER25	42.00	20.00	M32x1.5	196.2	PENS TUTUCULARI İÇİN / FOR COLLET CHUCK HOLDERS / FÜR SPANNZANGEAUFNAHME	ER25
ANUT-ER32	50.00	22.00	M40x1.5	215.8	PENS TUTUCULARI İÇİN / FOR COLLET CHUCK HOLDERS / FÜR SPANNZANGEAUFNAHME	ER32
ANUT-ER40	63.00	25.00	M50x1.5	245.3	PENS TUTUCULARI İÇİN / FOR COLLET CHUCK HOLDERS / FÜR SPANNZANGEAUFNAHME	ER40
ANUT-ER50	78.00	35.00	M64x2.0	343.4	PENS TUTUCULARI İÇİN / FOR COLLET CHUCK HOLDERS / FÜR SPANNZANGEAUFNAHME	ER50

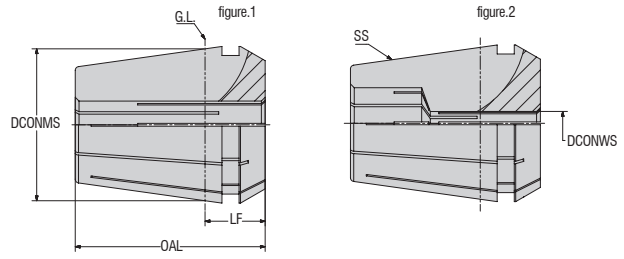

Sipariş Kodu Ordering Code Bestell-Bezeichnung	PENSLER ER DIN 6499 B/ISO 15488-B Formu ER 11-B / COLLET CHUCK ER DIN 6499 B/ISO 15488-B FORM ER 11-B / SPANNZANGEN DIN 6499 B/ISO 15488-B Form ER 11-B						Ürün Detayı / Product Detail / Produkt-Details
	SS	DCONWS	DCONMS	LF	OAL	Fig.	
ER-11S-01	ER11	1	11	6.3	18	2	ER11 PENS TUTUCULAR İÇİN / ER11 FOR COLLET CHUCKS / FÜR ER11 STIFTHALTER
ER-11S-015	ER11	1.5	11	6.3	18	2	ER11 PENS TUTUCULAR İÇİN / ER11 FOR COLLET CHUCKS / FÜR ER11 STIFTHALTER
ER-11S-02	ER11	2	11	6.3	18	2	ER11 PENS TUTUCULAR İÇİN / ER11 FOR COLLET CHUCKS / FÜR ER11 STIFTHALTER
ER-11S-025	ER11	2.5	11	6.3	18	2	ER11 PENS TUTUCULAR İÇİN / ER11 FOR COLLET CHUCKS / FÜR ER11 STIFTHALTER
ER-11S-03	ER11	3	11	6.3	18	1	ER11 PENS TUTUCULAR İÇİN / ER11 FOR COLLET CHUCKS / FÜR ER11 STIFTHALTER
ER-11S-04	ER11	4	11	6.3	18	1	ER11 PENS TUTUCULAR İÇİN / ER11 FOR COLLET CHUCKS / FÜR ER11 STIFTHALTER
ER-11S-05	ER11	5	11	6.3	18	1	ER11 PENS TUTUCULAR İÇİN / ER11 FOR COLLET CHUCKS / FÜR ER11 STIFTHALTER
ER-11S-055	ER11	5.5	11	6.3	18	1	ER11 PENS TUTUCULAR İÇİN / ER11 FOR COLLET CHUCKS / FÜR ER11 STIFTHALTER
ER-11S-06	ER11	6	11	6.3	18	1	ER11 PENS TUTUCULAR İÇİN / ER11 FOR COLLET CHUCKS / FÜR ER11 STIFTHALTER
ER-11S-065	ER11	6.5	11	6.3	18	1	ER11 PENS TUTUCULAR İÇİN / ER11 FOR COLLET CHUCKS / FÜR ER11 STIFTHALTER
ER-11S-07	ER11	7	11	6.3	18	1	ER11 PENS TUTUCULAR İÇİN / ER11 FOR COLLET CHUCKS / FÜR ER11 STIFTHALTER

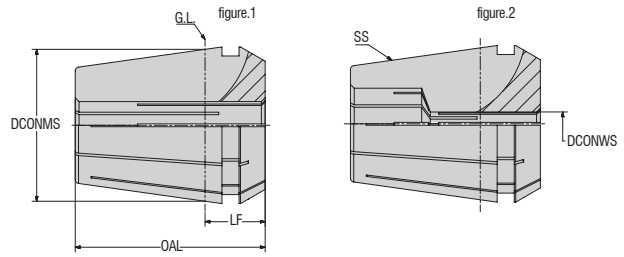

Sipariş Kodu Ordering Code Bestell-Bezeichnung	PENSLER ER DIN 6499 B/ISO 15488-B Formu ER 16-B / COLLET CHUCK ER DIN 6499 B/ISO 15488-B FORM ER 16-B / SPANNZANGEN DIN 6499 B/ISO 15488-B Form ER 16-B						Ürün Detayı / Product Detail / Produkt-Details
	SS	DCONWS	DCONMS	LF	OAL	Fig.	
ER-16S-01	ER16	1	16	10.26	27.5	2	ER16 PENS TUTUCULAR İÇİN / ER16 FOR COLLET CHUCKS / FÜR ER16 STIFTHALTER
ER-16S-02	ER16	2	16	10.26	27.5	2	ER16 PENS TUTUCULAR İÇİN / ER16 FOR COLLET CHUCKS / FÜR ER16 STIFTHALTER
ER-16S-03	ER16	3	16	10.26	27.5	2	ER16 PENS TUTUCULAR İÇİN / ER16 FOR COLLET CHUCKS / FÜR ER16 STIFTHALTER
ER-16S-04	ER16	4	16	10.26	27.5	2	ER16 PENS TUTUCULAR İÇİN / ER16 FOR COLLET CHUCKS / FÜR ER16 STIFTHALTER
ER-16S-05	ER16	5	16	10.26	27.5	1	ER16 PENS TUTUCULAR İÇİN / ER16 FOR COLLET CHUCKS / FÜR ER16 STIFTHALTER
ER-16S-06	ER16	6	16	10.26	27.5	1	ER16 PENS TUTUCULAR İÇİN / ER16 FOR COLLET CHUCKS / FÜR ER16 STIFTHALTER
ER-16S-07	ER16	7	16	10.26	27.5	1	ER16 PENS TUTUCULAR İÇİN / ER16 FOR COLLET CHUCKS / FÜR ER16 STIFTHALTER
ER-16S-08	ER16	8	16	10.26	27.5	1	ER16 PENS TUTUCULAR İÇİN / ER16 FOR COLLET CHUCKS / FÜR ER16 STIFTHALTER
ER-16S-09	ER16	9	16	10.26	27.5	1	ER16 PENS TUTUCULAR İÇİN / ER16 FOR COLLET CHUCKS / FÜR ER16 STIFTHALTER
ER-16S-10	ER16	10	16	10.26	27.5	1	ER16 PENS TUTUCULAR İÇİN / ER16 FOR COLLET CHUCKS / FÜR ER16 STIFTHALTER

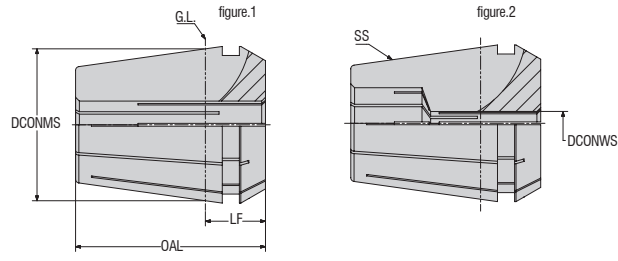

Sipariş Kodu Ordering Code Bestell-Bezeichnung	PENSLER ER DIN 6499 B/ISO 15488-B Formu ER 20-B / COLLET CHUCK ER DIN 6499 B/ISO 15488-B FORM ER 20-B / SPANNZANGEN DIN 6499 B/ISO 15488-B Form ER 20-B						Ürün Detayı / Product Detail / Produkt-Details
	SS	DCONWS	DCONMS	LF	OAL	Fig.	
ER-20S-02	ER20	2	20	11.16	31.5	2	ER20 PENS TUTUCULAR İÇİN / ER20 FOR COLLET CHUCKS / FÜR ER20 STIFTHALTER
ER-20S-03	ER20	3	20	11.16	31.5	2	ER20 PENS TUTUCULAR İÇİN / ER20 FOR COLLET CHUCKS / FÜR ER20 STIFTHALTER
ER-20S-04	ER20	4	20	11.16	31.5	2	ER20 PENS TUTUCULAR İÇİN / ER20 FOR COLLET CHUCKS / FÜR ER20 STIFTHALTER
ER-20S-05	ER20	5	20	11.16	31.5	2	ER20 PENS TUTUCULAR İÇİN / ER20 FOR COLLET CHUCKS / FÜR ER20 STIFTHALTER
ER-20S-06	ER20	6	20	11.16	31.5	2	ER20 PENS TUTUCULAR İÇİN / ER20 FOR COLLET CHUCKS / FÜR ER20 STIFTHALTER
ER-20S-07	ER20	7	20	11.16	31.5	2	ER20 PENS TUTUCULAR İÇİN / ER20 FOR COLLET CHUCKS / FÜR ER20 STIFTHALTER
ER-20S-08	ER20	8	20	11.16	31.5	1	ER20 PENS TUTUCULAR İÇİN / ER20 FOR COLLET CHUCKS / FÜR ER20 STIFTHALTER
ER-20S-09	ER20	9	20	11.16	31.5	1	ER20 PENS TUTUCULAR İÇİN / ER20 FOR COLLET CHUCKS / FÜR ER20 STIFTHALTER
ER-20S-10	ER20	10	20	11.16	31.5	1	ER20 PENS TUTUCULAR İÇİN / ER20 FOR COLLET CHUCKS / FÜR ER20 STIFTHALTER
ER-20S-11	ER20	11	20	11.16	31.5	1	ER20 PENS TUTUCULAR İÇİN / ER20 FOR COLLET CHUCKS / FÜR ER20 STIFTHALTER
ER-20S-12	ER20	12	20	11.16	31.5	1	ER20 PENS TUTUCULAR İÇİN / ER20 FOR COLLET CHUCKS / FÜR ER20 STIFTHALTER
ER-20S-13	ER20	13	20	11.16	31.5	1	ER20 PENS TUTUCULAR İÇİN / ER20 FOR COLLET CHUCKS / FÜR ER20 STIFTHALTER

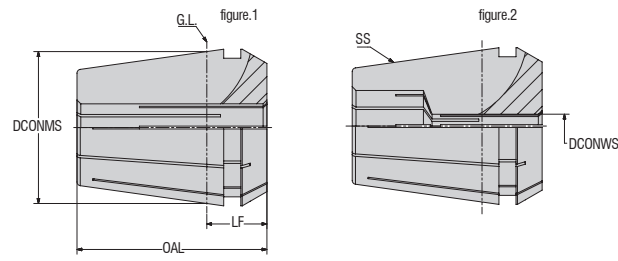
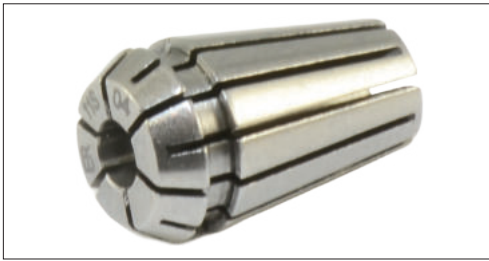

Sipariş Kodu Ordering Code Bestell-Bezeichnung	PENSLER ER DIN 6499 B/ISO 15488-B Formu ER 32-B / COLLET CHUCK ER DIN 6499 B/ISO 15488-B FORM ER 32-B / SPANNZANGEN DIN 6499 B/ISO 15488-B Form ER 32-B						Ürün Detayı / Product Detail / Produkt-Details
	SS	DCONWS	DCONMS	LF	OAL	Fig.	
ER-32S-02	ER32	2	32	12.66	40	2	ER32 PENS TUTUCULAR İÇİN / ER32 FOR COLLET CHUCKS / FÜR ER32 STIFTHALTER
ER-32S-03	ER32	3	32	12.66	40	2	ER32 PENS TUTUCULAR İÇİN / ER32 FOR COLLET CHUCKS / FÜR ER32 STIFTHALTER
ER-32S-04	ER32	4	32	12.66	40	2	ER32 PENS TUTUCULAR İÇİN / ER32 FOR COLLET CHUCKS / FÜR ER32 STIFTHALTER
ER-32S-05	ER32	5	32	12.66	40	2	ER32 PENS TUTUCULAR İÇİN / ER32 FOR COLLET CHUCKS / FÜR ER32 STIFTHALTER
ER-32S-06	ER32	6	32	12.66	40	2	ER32 PENS TUTUCULAR İÇİN / ER32 FOR COLLET CHUCKS / FÜR ER32 STIFTHALTER
ER-32S-07	ER32	7	32	12.66	40	2	ER32 PENS TUTUCULAR İÇİN / ER32 FOR COLLET CHUCKS / FÜR ER32 STIFTHALTER
ER-32S-08	ER32	8	32	12.66	40	1	ER32 PENS TUTUCULAR İÇİN / ER32 FOR COLLET CHUCKS / FÜR ER32 STIFTHALTER
ER-32S-09	ER32	9	32	12.66	40	1	ER32 PENS TUTUCULAR İÇİN / ER32 FOR COLLET CHUCKS / FÜR ER32 STIFTHALTER
ER-32S-10	ER32	10	32	12.66	40	1	ER32 PENS TUTUCULAR İÇİN / ER32 FOR COLLET CHUCKS / FÜR ER32 STIFTHALTER
ER-32S-11	ER32	11	32	12.66	40	1	ER32 PENS TUTUCULAR İÇİN / ER32 FOR COLLET CHUCKS / FÜR ER32 STIFTHALTER
ER-32S-12	ER32	12	32	12.66	40	1	ER32 PENS TUTUCULAR İÇİN / ER32 FOR COLLET CHUCKS / FÜR ER32 STIFTHALTER
ER-32S-13	ER32	13	32	12.66	40	1	ER32 PENS TUTUCULAR İÇİN / ER32 FOR COLLET CHUCKS / FÜR ER32 STIFTHALTER
ER-32S-14	ER32	14	32	12.66	40	1	ER32 PENS TUTUCULAR İÇİN / ER32 FOR COLLET CHUCKS / FÜR ER32 STIFTHALTER
ER-32S-15	ER32	15	32	12.66	40	1	ER32 PENS TUTUCULAR İÇİN / ER32 FOR COLLET CHUCKS / FÜR ER32 STIFTHALTER
ER-32S-16	ER32	16	32	12.66	40	1	ER32 PENS TUTUCULAR İÇİN / ER32 FOR COLLET CHUCKS / FÜR ER32 STIFTHALTER
ER-32S-17	ER32	17	32	12.66	40	1	ER32 PENS TUTUCULAR İÇİN / ER32 FOR COLLET CHUCKS / FÜR ER32 STIFTHALTER
ER-32S-18	ER32	18	32	12.66	40	1	ER32 PENS TUTUCULAR İÇİN / ER32 FOR COLLET CHUCKS / FÜR ER32 STIFTHALTER
ER-32S-19	ER32	19	32	12.66	40	1	ER32 PENS TUTUCULAR İÇİN / ER32 FOR COLLET CHUCKS / FÜR ER32 STIFTHALTER
ER-32S-20	ER32	20	32	12.66	40	1	ER32 PENS TUTUCULAR İÇİN / ER32 FOR COLLET CHUCKS / FÜR ER32 STIFTHALTER

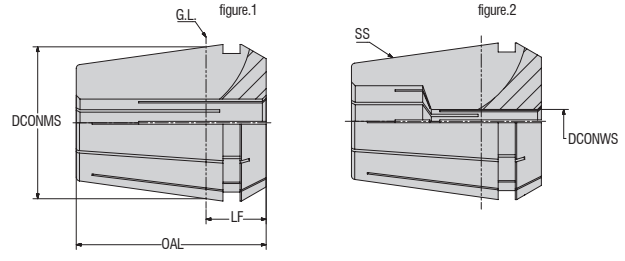

Sipariş Kodu Ordering Code Bestell-Bezeichnung	PENSİLER ER DIN 6499 B/ISO 15488-B Formu ER 40-B / COLLET CHUCK ER DIN 6499 B/ISO 15488-B FORM ER 40-B / SPANNZANGEN DIN 6499 B/ISO 15488-B Form ER 40-B						Ürün Detayı / Product Detail / Produkt-Details
	SS	DCONWS	DCONMS	LF	OAL	Fig.	
ER-40S-03	ER40	3	40	14.66	46	2	ER40 PENS TUTUCULAR İÇİN / ER40 FOR COLLET CHUCKS / FÜR ER40 STIFTHALTER
ER-40S-04	ER40	4	40	14.66	46	2	ER40 PENS TUTUCULAR İÇİN / ER40 FOR COLLET CHUCKS / FÜR ER40 STIFTHALTER
ER-40S-05	ER40	5	40	14.66	46	2	ER40 PENS TUTUCULAR İÇİN / ER40 FOR COLLET CHUCKS / FÜR ER40 STIFTHALTER
ER-40S-06	ER40	6	40	14.66	46	2	ER40 PENS TUTUCULAR İÇİN / ER40 FOR COLLET CHUCKS / FÜR ER40 STIFTHALTER
ER-40S-07	ER40	7	40	14.66	46	2	ER40 PENS TUTUCULAR İÇİN / ER40 FOR COLLET CHUCKS / FÜR ER40 STIFTHALTER
ER-40S-08	ER40	8	40	14.66	46	2	ER40 PENS TUTUCULAR İÇİN / ER40 FOR COLLET CHUCKS / FÜR ER40 STIFTHALTER
ER-40S-09	ER40	9	40	14.66	46	1	ER40 PENS TUTUCULAR İÇİN / ER40 FOR COLLET CHUCKS / FÜR ER40 STIFTHALTER
ER-40S-10	ER40	10	40	14.66	46	1	ER40 PENS TUTUCULAR İÇİN / ER40 FOR COLLET CHUCKS / FÜR ER40 STIFTHALTER
ER-40S-11	ER40	11	40	14.66	46	1	ER40 PENS TUTUCULAR İÇİN / ER40 FOR COLLET CHUCKS / FÜR ER40 STIFTHALTER
ER-40S-12	ER40	12	40	14.66	46	1	ER40 PENS TUTUCULAR İÇİN / ER40 FOR COLLET CHUCKS / FÜR ER40 STIFTHALTER
ER-40S-13	ER40	13	40	14.66	46	1	ER40 PENS TUTUCULAR İÇİN / ER40 FOR COLLET CHUCKS / FÜR ER40 STIFTHALTER
ER-40S-14	ER40	14	40	14.66	46	1	ER40 PENS TUTUCULAR İÇİN / ER40 FOR COLLET CHUCKS / FÜR ER40 STIFTHALTER
ER-40S-15	ER40	15	40	14.66	46	1	ER40 PENS TUTUCULAR İÇİN / ER40 FOR COLLET CHUCKS / FÜR ER40 STIFTHALTER
ER-40S-16	ER40	16	40	14.66	46	1	ER40 PENS TUTUCULAR İÇİN / ER40 FOR COLLET CHUCKS / FÜR ER40 STIFTHALTER
ER-40S-17	ER40	17	40	14.66	46	1	ER40 PENS TUTUCULAR İÇİN / ER40 FOR COLLET CHUCKS / FÜR ER40 STIFTHALTER
ER-40S-18	ER40	18	40	14.66	46	1	ER40 PENS TUTUCULAR İÇİN / ER40 FOR COLLET CHUCKS / FÜR ER40 STIFTHALTER
ER-40S-19	ER40	19	40	14.66	46	1	ER40 PENS TUTUCULAR İÇİN / ER40 FOR COLLET CHUCKS / FÜR ER40 STIFTHALTER
ER-40S-20	ER40	20	40	14.66	46	1	ER40 PENS TUTUCULAR İÇİN / ER40 FOR COLLET CHUCKS / FÜR ER40 STIFTHALTER
ER-40S-21	ER40	21	40	14.66	46	1	ER40 PENS TUTUCULAR İÇİN / ER40 FOR COLLET CHUCKS / FÜR ER40 STIFTHALTER
ER-40S-22	ER40	22	40	14.66	46	1	ER40 PENS TUTUCULAR İÇİN / ER40 FOR COLLET CHUCKS / FÜR ER40 STIFTHALTER
ER-40S-23	ER40	23	40	14.66	46	1	ER40 PENS TUTUCULAR İÇİN / ER40 FOR COLLET CHUCKS / FÜR ER40 STIFTHALTER
ER-40S-24	ER40	24	40	14.66	46	1	ER40 PENS TUTUCULAR İÇİN / ER40 FOR COLLET CHUCKS / FÜR ER40 STIFTHALTER
ER-40S-25	ER40	25	40	14.66	46	1	ER40 PENS TUTUCULAR İÇİN / ER40 FOR COLLET CHUCKS / FÜR ER40 STIFTHALTER
ER-40S-26	ER40	26	40	14.66	46	1	ER40 PENS TUTUCULAR İÇİN / ER40 FOR COLLET CHUCKS / FÜR ER40 STIFTHALTER



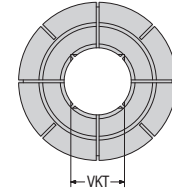
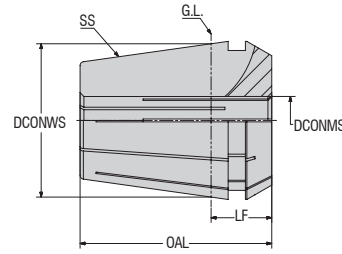

Sipariş Kodu Ordering Code Bestell-Bezeichnung	KILAVUZ PENSİ İÇTEN SOĞUTMALI SİSTEMLER İÇİN KEÇELİ TİP, ER DIN 6499 A FORMU / TAP COLLET COOLANT THRU SYSTEMS FOR SEALING TYPE, ER DIN 6499 A FORM / DICHTUNGSTYP FÜR INNENKÜHLSYSTEME, FORM ER DIN 6499 A						Ürün Detayı / Product Detail / Produkt-Details
	SS	DCONWS	DCONMS	LF	OAL	VKT	
ER-16T-03527	ER16	3.5	16	6,3	27.5	2.7	ER16 PENS TUTUCULAR İÇİN / ER16 FOR COLLET CHUCKS / FÜR ER16 STIFTHALTER
ER-16T-04032	ER16	4	16	6,3	27.5	3.2	ER16 PENS TUTUCULAR İÇİN / ER16 FOR COLLET CHUCKS / FÜR ER16 STIFTHALTER
ER-16T-04534	ER16	4.5	16	6,3	27.5	3.4	ER16 PENS TUTUCULAR İÇİN / ER16 FOR COLLET CHUCKS / FÜR ER16 STIFTHALTER
ER-16T-06049	ER16	6	16	6,3	27.5	4.9	ER16 PENS TUTUCULAR İÇİN / ER16 FOR COLLET CHUCKS / FÜR ER16 STIFTHALTER
ER-16T-07055	ER16	7	16	6,3	27.5	5.5	ER16 PENS TUTUCULAR İÇİN / ER16 FOR COLLET CHUCKS / FÜR ER16 STIFTHALTER
ER-16T-08063	ER16	8	16	6,3	27.5	6.3	ER16 PENS TUTUCULAR İÇİN / ER16 FOR COLLET CHUCKS / FÜR ER16 STIFTHALTER
ER-16T-09071	ER16	9	16	6,3	27.5	7.1	ER16 PENS TUTUCULAR İÇİN / ER16 FOR COLLET CHUCKS / FÜR ER16 STIFTHALTER
ER-20T-03527	ER20	3.5	20	7,2	31.5	2.7	ER20 PENS TUTUCULAR İÇİN / ER20 FOR COLLET CHUCKS / FÜR ER20 STIFTHALTER
ER-20T-04032	ER20	4	20	7,2	31.5	3.2	ER20 PENS TUTUCULAR İÇİN / ER20 FOR COLLET CHUCKS / FÜR ER20 STIFTHALTER
ER-20T-04534	ER20	4.5	20	7,2	31.5	3.4	ER20 PENS TUTUCULAR İÇİN / ER20 FOR COLLET CHUCKS / FÜR ER20 STIFTHALTER
ER-20T-06049	ER20	6	20	7,2	31.5	4.9	ER20 PENS TUTUCULAR İÇİN / ER20 FOR COLLET CHUCKS / FÜR ER20 STIFTHALTER
ER-20T-07055	ER20	7	20	7,2	31.5	5.5	ER20 PENS TUTUCULAR İÇİN / ER20 FOR COLLET CHUCKS / FÜR ER20 STIFTHALTER
ER-20T-08063	ER20	8	20	7,2	31.5	6.3	ER20 PENS TUTUCULAR İÇİN / ER20 FOR COLLET CHUCKS / FÜR ER20 STIFTHALTER
ER-20T-09071	ER20	9	20	7,2	31.5	7.1	ER20 PENS TUTUCULAR İÇİN / ER20 FOR COLLET CHUCKS / FÜR ER20 STIFTHALTER
ER-20T-10080	ER20	10	20	7,2	31.5	8	ER20 PENS TUTUCULAR İÇİN / ER20 FOR COLLET CHUCKS / FÜR ER20 STIFTHALTER
ER-20T-11090	ER20	11	20	7,2	31.5	9	ER20 PENS TUTUCULAR İÇİN / ER20 FOR COLLET CHUCKS / FÜR ER20 STIFTHALTER
ER-20T-12090	ER20	12	20	7,2	31.5	9	ER20 PENS TUTUCULAR İÇİN / ER20 FOR COLLET CHUCKS / FÜR ER20 STIFTHALTER
ER-25T-03527	ER25	3.5	25	7,5	34	2.7	ER25 PENS TUTUCULAR İÇİN / ER25 FOR COLLET CHUCKS / FÜR ER25 STIFTHALTER
ER-25T-04032	ER25	4	25	7,5	34	3.2	ER25 PENS TUTUCULAR İÇİN / ER25 FOR COLLET CHUCKS / FÜR ER25 STIFTHALTER
ER-25T-04534	ER25	4.5	25	7,5	34	3.4	ER25 PENS TUTUCULAR İÇİN / ER25 FOR COLLET CHUCKS / FÜR ER25 STIFTHALTER
ER-25T-06049	ER25	6	25	7,5	34	4.9	ER25 PENS TUTUCULAR İÇİN / ER25 FOR COLLET CHUCKS / FÜR ER25 STIFTHALTER
ER-25T-07055	ER25	7	25	7,5	34	5.5	ER25 PENS TUTUCULAR İÇİN / ER25 FOR COLLET CHUCKS / FÜR ER25 STIFTHALTER
ER-25T-08063	ER25	8	25	7,5	34	6.3	ER25 PENS TUTUCULAR İÇİN / ER25 FOR COLLET CHUCKS / FÜR ER25 STIFTHALTER
ER-25T-09071	ER25	9	25	7,5	34	7.1	ER25 PENS TUTUCULAR İÇİN / ER25 FOR COLLET CHUCKS / FÜR ER25 STIFTHALTER
ER-25T-10080	ER25	10	25	7,5	34	8	ER25 PENS TUTUCULAR İÇİN / ER25 FOR COLLET CHUCKS / FÜR ER25 STIFTHALTER
ER-25T-11090	ER25	11	25	7,5	34	9	ER25 PENS TUTUCULAR İÇİN / ER25 FOR COLLET CHUCKS / FÜR ER25 STIFTHALTER
ER-25T-12090	ER25	12	25	7,5	34	9	ER25 PENS TUTUCULAR İÇİN / ER25 FOR COLLET CHUCKS / FÜR ER25 STIFTHALTER
ER-25T-14112	ER25	14	25	7,5	34	11.2	ER25 PENS TUTUCULAR İÇİN / ER25 FOR COLLET CHUCKS / FÜR ER25 STIFTHALTER
ER-25T-16125	ER25	16	25	7,5	34	12.5	ER25 PENS TUTUCULAR İÇİN / ER25 FOR COLLET CHUCKS / FÜR ER25 STIFTHALTER
ER-32T-04032	ER32	4	32	8,2	40	3.2	ER32 PENS TUTUCULAR İÇİN / ER32 FOR COLLET CHUCKS / FÜR ER32 STIFTHALTER
ER-32T-04534	ER32	4.5	32	8,2	40	3.4	ER32 PENS TUTUCULAR İÇİN / ER32 FOR COLLET CHUCKS / FÜR ER32 STIFTHALTER
ER-32T-06049	ER32	6	32	8,2	40	4.9	ER32 PENS TUTUCULAR İÇİN / ER32 FOR COLLET CHUCKS / FÜR ER32 STIFTHALTER
ER-32T-07055	ER32	7	32	8,2	40	5.5	ER32 PENS TUTUCULAR İÇİN / ER32 FOR COLLET CHUCKS / FÜR ER32 STIFTHALTER
ER-32T-08063	ER32	8	32	8,2	40	6.3	ER32 PENS TUTUCULAR İÇİN / ER32 FOR COLLET CHUCKS / FÜR ER32 STIFTHALTER
ER-32T-09071	ER32	9	32	8,2	40	7.1	ER32 PENS TUTUCULAR İÇİN / ER32 FOR COLLET CHUCKS / FÜR ER32 STIFTHALTER
ER-32T-10080	ER32	10	32	8,2	40	8	ER32 PENS TUTUCULAR İÇİN / ER32 FOR COLLET CHUCKS / FÜR ER32 STIFTHALTER
ER-32T-11090	ER32	11	32	8,2	40	9	ER32 PENS TUTUCULAR İÇİN / ER32 FOR COLLET CHUCKS / FÜR ER32 STIFTHALTER
ER-32T-12090	ER32	12	32	8,2	40	9	ER32 PENS TUTUCULAR İÇİN / ER32 FOR COLLET CHUCKS / FÜR ER32 STIFTHALTER
ER-32T-14112	ER32	14	32	8,2	40	11.2	ER32 PENS TUTUCULAR İÇİN / ER32 FOR COLLET CHUCKS / FÜR ER32 STIFTHALTER
ER-32T-16125	ER32	16	32	8,2	40	12.5	ER32 PENS TUTUCULAR İÇİN / ER32 FOR COLLET CHUCKS / FÜR ER32 STIFTHALTER
ER-32T-18145	ER32	18	32	8,2	40	14.5	ER32 PENS TUTUCULAR İÇİN / ER32 FOR COLLET CHUCKS / FÜR ER32 STIFTHALTER
ER-32T-20160	ER32	20	32	8,2	40	16	ER32 PENS TUTUCULAR İÇİN / ER32 FOR COLLET CHUCKS / FÜR ER32 STIFTHALTER
ER-40T-06049	ER40	6	40	10,5	46	4.9	ER40 PENS TUTUCULAR İÇİN / ER40 FOR COLLET CHUCKS / FÜR ER40 STIFTHALTER
ER-40T-07055	ER40	7	40	10,5	46	5.5	ER40 PENS TUTUCULAR İÇİN / ER40 FOR COLLET CHUCKS / FÜR ER40 STIFTHALTER
ER-40T-08063	ER40	8	40	10,5	46	6.3	ER40 PENS TUTUCULAR İÇİN / ER40 FOR COLLET CHUCKS / FÜR ER40 STIFTHALTER
ER-40T-09071	ER40	9	40	10,5	46	7.1	ER40 PENS TUTUCULAR İÇİN / ER40 FOR COLLET CHUCKS / FÜR ER40 STIFTHALTER
ER-40T-10080	ER40	10	40	10,5	46	8	ER40 PENS TUTUCULAR İÇİN / ER40 FOR COLLET CHUCKS / FÜR ER40 STIFTHALTER
ER-40T-11090	ER40	11	40	10,5	46	9	ER40 PENS TUTUCULAR İÇİN / ER40 FOR COLLET CHUCKS / FÜR ER40 STIFTHALTER
ER-40T-12090	ER40	12	40	10,5	46	9	ER40 PENS TUTUCULAR İÇİN / ER40 FOR COLLET CHUCKS / FÜR ER40 STIFTHALTER
ER-40T-14112	ER40	14	40	10,5	46	11.2	ER40 PENS TUTUCULAR İÇİN / ER40 FOR COLLET CHUCKS / FÜR ER40 STIFTHALTER
ER-40T-16125	ER40	16	40	10,5	46	12.5	ER40 PENS TUTUCULAR İÇİN / ER40 FOR COLLET CHUCKS / FÜR ER40 STIFTHALTER
ER-40T-18145	ER40	18	40	10,5	46	14.5	ER40 PENS TUTUCULAR İÇİN / ER40 FOR COLLET CHUCKS / FÜR ER40 STIFTHALTER
ER-40T-20160	ER40	20	40	10,5	46	16	ER40 PENS TUTUCULAR İÇİN / ER40 FOR COLLET CHUCKS / FÜR ER40 STIFTHALTER
ER-40T-22180	ER40	22	40	10,5	46	18	ER40 PENS TUTUCULAR İÇİN / ER40 FOR COLLET CHUCKS / FÜR ER40 STIFTHALTER
ER-40T-25200	ER40	25	40	10,5	46	20	ER40 PENS TUTUCULAR İÇİN / ER40 FOR COLLET CHUCKS / FÜR ER40 STIFTHALTER

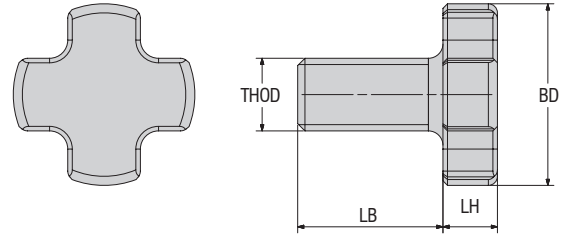
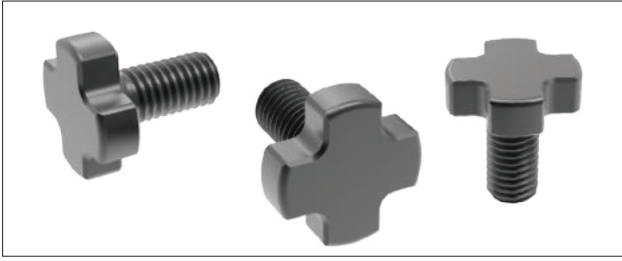

Sipariş Kodu Ordering Code Bestell-Bezeichnung	TARAMA BAŞLIK SIKMA ÇİVATASI DIN 6367 / BOLT FOR SHELL ARBOR DIN 6367 / SCANKOPF-KLEMMSCHRAUBE DIN 6367					
	THID	BD	LH	LB	Ürün Detayı / Product Detail / Produkt-Details	
2400-M8x16	M08	20.00	6.0	16.00	YÜZEY FREZE TAKIM TUTUCULARI İÇİN / FOR FACE MILLING TOOL HOLDERS / FÜR PLANFRÄSE HALTER	FM-16
2500-M10x18	M10	28.00	7.0	18.00	YÜZEY FREZE TAKIM TUTUCULARI İÇİN / FOR FACE MILLING TOOL HOLDERS / FÜR PLANFRÄSE HALTER	FM-22
2500-M12x22	M12	35.00	9.0	22.00	YÜZEY FREZE TAKIM TUTUCULARI İÇİN / FOR FACE MILLING TOOL HOLDERS / FÜR PLANFRÄSE HALTER	FM-27
2500-M16x26	M12	35.00	8.0	22.00	YÜZEY FREZE TAKIM TUTUCULARI İÇİN / FOR FACE MILLING TOOL HOLDERS / FÜR PLANFRÄSE HALTER	FM-32
2500-M20x30	M16	42.00	9.0	26.00	YÜZEY FREZE TAKIM TUTUCULARI İÇİN / FOR FACE MILLING TOOL HOLDERS / FÜR PLANFRÄSE HALTER	FM-40
2500-M24X36	M24	63.00	12.0	36.00	YÜZEY FREZE TAKIM TUTUCULARI İÇİN / FOR FACE MILLING TOOL HOLDERS / FÜR PLANFRÄSE HALTER	FM-50

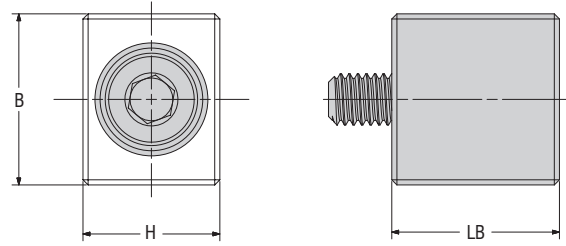
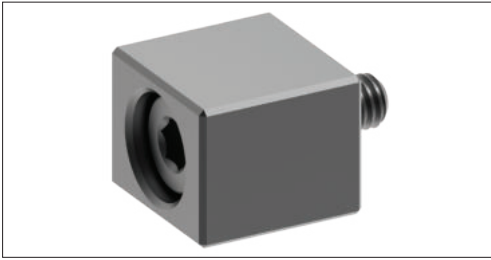

Sipariş Kodu Ordering Code Bestell-Bezeichnung	ALIN KAMALI MALAFA KAMASI / DRIVE KEY / MITNEHMERSTEINE MIT SCHRAUBE					
	B	H	LB	SCREW	Ürün Detayı / Product Detail / Produkt-Details	
AHW-16-01	10	8	10	M3x12	YÜZEY FREZE TAKIM TUTUCULARI İÇİN / FOR FACE MILLING TOOL HOLDERS / FÜR PLANFRÄSE HALTER	FM-16
AHW-22-01	11	10	11.20	M4x12	YÜZEY FREZE TAKIM TUTUCULARI İÇİN / FOR FACE MILLING TOOL HOLDERS / FÜR PLANFRÄSE HALTER	FM-22
AHW-27-01	14	12	12.60	M4x15	YÜZEY FREZE TAKIM TUTUCULARI İÇİN / FOR FACE MILLING TOOL HOLDERS / FÜR PLANFRÄSE HALTER	FM-27
AHW-32-01	21	14	14	M5x16	YÜZEY FREZE TAKIM TUTUCULARI İÇİN / FOR FACE MILLING TOOL HOLDERS / FÜR PLANFRÄSE HALTER	FM-32
AHW-40-01	21	16	16	M5x16	YÜZEY FREZE TAKIM TUTUCULARI İÇİN / FOR FACE MILLING TOOL HOLDERS / FÜR PLANFRÄSE HALTER	FM-40

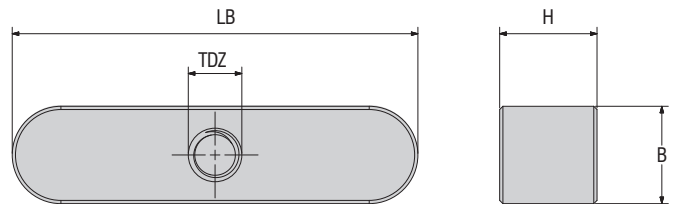
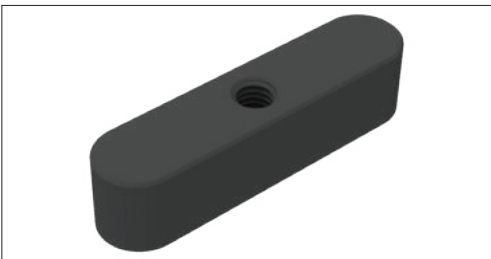

Sipariş Kodu Ordering Code Bestell-Bezeichnung	KAMA DIN 6885 / DRIVE KEY DIN 6885 / FAßEDER DIN 6885					
	B	H	LB	SCREW	Ürün Detayı / Product Detail / Produkt-Details	
AHW-16-4x4x20	4	4	20	M2x4	KOMBİNE YÜZEY FREZE TUTUCULAR İÇİN / FOR COMBI SHELL MILL HOLDER / FÜR KOMBINIERTER FLÄCHENFRÄSHALTER	
AHW-22-6x6x25	6	6	25	M3x5	KOMBİNE YÜZEY FREZE TUTUCULAR İÇİN / FOR COMBI SHELL MILL HOLDER / FÜR KOMBINIERTER FLÄCHENFRÄSHALTER	
AHW-27-7x7x25	7	7	25	M3x6	KOMBİNE YÜZEY FREZE TUTUCULAR İÇİN / FOR COMBI SHELL MILL HOLDER / FÜR KOMBINIERTER FLÄCHENFRÄSHALTER	
AHW-32-8x7x28	8	7	28	M3x6	KOMBİNE YÜZEY FREZE TUTUCULAR İÇİN / FOR COMBI SHELL MILL HOLDER / FÜR KOMBINIERTER FLÄCHENFRÄSHALTER	
AHW-40-10x8x32	10	8	32	M3x6	KOMBİNE YÜZEY FREZE TUTUCULAR İÇİN / FOR COMBI SHELL MILL HOLDER / FÜR KOMBINIERTER FLÄCHENFRÄSHALTER	

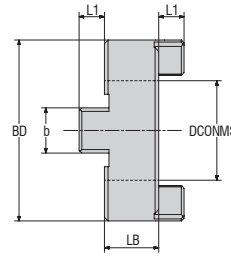
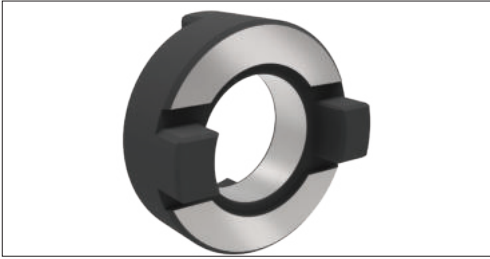

Sipariş Kodu Ordering Code Bestell-Bezeichnung	TIRNAKLI PUL DIN 6366 / CLUTCH DRIVE RINGS TO DIN 6366 / MITNEHMERRINGE DIN 6366						Ürün Detayı / Product Detail / Produkt-Details
	BD	DCONMS	LB	b	L1		
ADR-FMC-16	32	16	10	8	5	KOMBİNE YÜZEY FREZE TUTUCULARI İÇİN / FOR COMBI SHELL MILL HOLDER / FÜR KOMBİNIERTE FLÄCHENFRÄSHALTER	
ADR-FMC-22	40	22	12	10	5.6	KOMBİNE YÜZEY FREZE TUTUCULARI İÇİN / FOR COMBI SHELL MILL HOLDER / FÜR KOMBİNIERTE FLÄCHENFRÄSHALTER	
ADR-FMC-27	48	27	12	12	6.3	KOMBİNE YÜZEY FREZE TUTUCULARI İÇİN / FOR COMBI SHELL MILL HOLDER / FÜR KOMBİNIERTE FLÄCHENFRÄSHALTER	
ADR-FMC-32	58	32	14	14	7	KOMBİNE YÜZEY FREZE TUTUCULARI İÇİN / FOR COMBI SHELL MILL HOLDER / FÜR KOMBİNIERTE FLÄCHENFRÄSHALTER	
ADR-FMC-40	70	40	14	16	8	KOMBİNE YÜZEY FREZE TUTUCULARI İÇİN / FOR COMBI SHELL MILL HOLDER / FÜR KOMBİNIERTE FLÄCHENFRÄSHALTER	

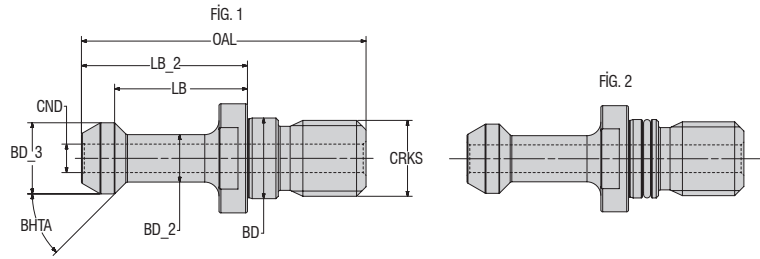

Sipariş Kodu Ordering Code Bestell-Bezeichnung	JIS B 6339 (MAS 403 BT) ÇEKTİRME CİVATASI / PULL STUD / ANZUGSBOLZEN											Ürün Detayı / Product Detail / Produkt-Details
	SS	CRKS	BD_3	BD_2	BD	CND	LB	OAL	LB_2	BHTA	Fig.	
APS-BT30-45-M12-JIS-O-H	30	M12	11	8	12.50	2.50	18	43	23	45	2	ABT30 TUTUCULARI İÇİN - JIS FORMU / FOR ABT30 HOLDERS - JIS FORM / FÜR ABT30 HALTER - JIS FORMULAR
APS-BT30-45-M12-JIS	30	M12	11	7	12.50	-	18	43	23	45	1	ABT30 TUTUCULARI İÇİN - JIS FORMU / FOR ABT30 HOLDERS - JIS FORM / FÜR ABT30 HALTER - JIS FORMULAR
APS-BT40-45-M16-JIS-O	40	M16	15	10	17	-	28	60	35	45	2	ABT40 TUTUCULARI İÇİN - JIS FORMU / FOR ABT40 HOLDERS - JIS FORM / FÜR ABT40 HALTER - JIS FORMULAR
APS-BT50-45-M24-JIS-O	50	M24	23	17	25	-	35	85	45	45	2	ABT50 TUTUCULARI İÇİN - JIS FORMU / FOR ABT50 HOLDERS - JIS FORM / FÜR ABT50 HALTER - JIS FORMULAR
APS-BT50-45-M24-JIS-O-H	50	M24	23	17	25	6	35	85	45	45	2	ABT50 TUTUCULARI İÇİN - JIS FORMU / FOR ABT50 HOLDERS - JIS FORM / FÜR ABT50 HALTER - JIS FORMULAR
APS-BT30-60-M12-JIS	30	M12	11	7	12.50	-	18	43	23	60	1	ABT30 TUTUCULARI İÇİN - JIS FORMU / FOR ABT30 HOLDERS - JIS FORM / FÜR ABT30 HALTER - JIS FORMULAR
APS-BT40-45-M16-JIS-O-H	40	M16	15	10	17	3	28	60	35	45	2	ABT40 TUTUCULARI İÇİN - JIS FORMU / FOR ABT40 HOLDERS - JIS FORM / FÜR ABT40 HALTER - JIS FORMULAR
APS-BT40-60-M16-JIS-O-H	40	M16	15	10	17	3	28	60	35	60	2	ABT40 TUTUCULARI İÇİN - JIS FORMU / FOR ABT40 HOLDERS - JIS FORM / FÜR ABT40 HALTER - JIS FORMULAR
APS-BT50-60-M24-JIS-O	50	M24	23	17	25	-	35	85	45	60	2	ABT50 TUTUCULARI İÇİN - JIS FORMU / FOR ABT50 HOLDERS - JIS FORM / FÜR ABT50 HALTER - JIS FORMULAR
APS-BT50-60-M24-JIS-O-H	50	M24	23	17	25	6	35	85	45	60	2	ABT50 TUTUCULARI İÇİN - JIS FORMU / FOR ABT50 HOLDERS - JIS FORM / FÜR ABT50 HALTER - JIS FORMULAR
APS-BT40-90-M16-JIS-O	40	M16	15	10	17	-	28	60	35	90	2	ABT40 TUTUCULARI İÇİN - JIS FORMU / FOR ABT40 HOLDERS - JIS FORM / FÜR ABT40 HALTER - JIS FORMULAR
APS-BT40-90-M16-JIS-O-H	40	M16	15	10	17	3	28	60	35	90	2	ABT40 TUTUCULARI İÇİN - JIS FORMU / FOR ABT40 HOLDERS - JIS FORM / FÜR ABT40 HALTER - JIS FORMULAR
APS-BT50-90-M24-JIS-O	50	M24	23	17	25	-	35	85	45	90	2	ABT50 TUTUCULARI İÇİN - JIS FORMU / FOR ABT50 HOLDERS - JIS FORM / FÜR ABT50 HALTER - JIS FORMULAR
APS-BT50-90-M24-JIS-O-H	50	M24	23	17	25	6	35	85	45	90	2	ABT50 TUTUCULARI İÇİN - JIS FORMU / FOR ABT50 HOLDERS - JIS FORM / FÜR ABT50 HALTER - JIS FORMULAR

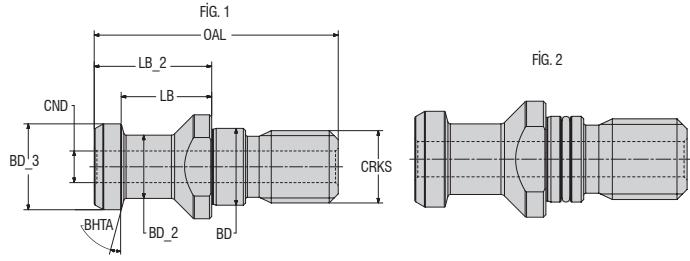

Sipariş Kodu Ordering Code Bestell-Bezeichnung	DIN 69872-A ÇEKTİRME CİVATASI / PULL STUD / ANZUGSBOLZEN											Ürün Detayı / Product Detail / Produkt-Details
	SS	CRKS	BD_3	BD_2	BD	CND	LB	OAL	LB_2	BHTA	Fig.	
APS-BT40-15-M16-DIN-O-H	40	M16	19	14	17	7	23	54	29	15	2	ABT40 TUTUCULARI İÇİN - DIN FORMU /FOR ABT40 HOLDERS - DIN FORM / FÜR ABT40 HALTER - DIN FORMULAR
APS-SK40-15-M16-DIN-O-H	40	M16	19	14	17	7	20	54	26	15	2	ABT40 TUTUCULARI İÇİN - DIN FORMU /FOR ABT40 HOLDERS - DIN FORM / FÜR ABT40 HALTER - DIN FORMULAR
APS-SK40-15-M16-DIN-O	40	M16	19	14	17	-	20	54	26	15	2	ABT40 TUTUCULARI İÇİN - DIN FORMU /FOR ABT40 HOLDERS - DIN FORM / FÜR ABT40 HALTER - DIN FORMULAR
APS-BT40-15-M16-OKU-O-H	40	M16	19	14	17	4	23	54	29	15	2	ABT40 TUTUCULARI İÇİN - DIN FORMU /FOR ABT40 HOLDERS - DIN FORM / FÜR ABT40 HALTER - DIN FORMULAR
APS-SK50-15-M24-DIN-O-H	50	M24	28	21	25	11.50	25	74	34	15	2	ASK50 TUTUCULARI İÇİN - DIN FORMU /FOR ASK50 HOLDERS - DIN FORM / FÜR ABT50 HALTER - DIN FORMULAR
APS-SK50-15-M24-DIN-O	50	M24	28	21	25	-	25	74	34	15	2	ASK50 TUTUCULARI İÇİN - DIN FORMU /FOR ASK50 HOLDERS - DIN FORM / FÜR ABT50 HALTER - DIN FORMULAR

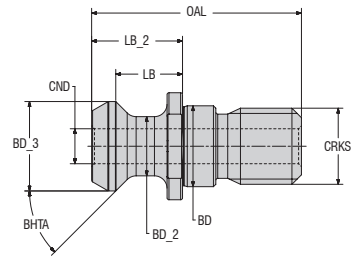

Sipariş Kodu Ordering Code Bestell-Bezeichnung	ISO 7388-CAT ÇEKTİRME CİVATASI / PULL STUD / ANZUGSBOLZEN											Ürün Detayı / Product Detail / Produkt-Details
	SS	CRKS	BD_3	BD_2	BD	CND	LB	OAL	LB_2	BHTA	Fig.	
APS-BT40-45-M16-MAZ-H	40	M16	18.80	12.45	17	7.35	14.03	44.11	19.11	45	2	ABT40 TUTUCULARI İÇİN - MAZAK / FOR ABT40 HOLDERS - MAZAK / FÜR ABT40 HALTER - MAZAK
APS-CAT40-45-M16-MAZ-H	40	M16	18.80	12.45	17	7.35	11.18	41.26	16.40	45	2	CAT 40 TUTUCULARI İÇİN - MAZAK / FOR CAT40 HOLDERS - MAZAK / FÜR ABT40 HALTER - MAZAK

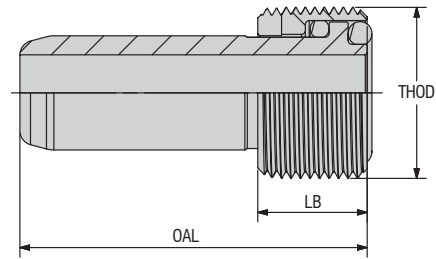

Sipariş Kodu Ordering Code Bestell-Bezeichnung	SOĞUTMA SUYU ÜNİTESİ / COOLING TUBES / KÜHLMITTELEINHEIT				Ürün Detayı / Product Detail / Produkt-Details
	OAL	LB	THID		
AHSK32-CT	26	5.5	M10x1	AHSK TAKIM TUTUCULARI İÇİN / FOR AHSK TOOL HOLDERS / FÜR AHSK WERKZEUGHALTER	AHSK32
AHSK40-CT	29.5	7.5	M12x1	AHSK TAKIM TUTUCULARI İÇİN / FOR AHSK TOOL HOLDERS / FÜR AHSK WERKZEUGHALTER	AHSK40
AHSK50-CT	33	9.5	M16x1	AHSK TAKIM TUTUCULARI İÇİN / FOR AHSK TOOL HOLDERS / FÜR AHSK WERKZEUGHALTER	AHSK50
AHSK63-CT	36.5	11.5	M18x1	AHSK TAKIM TUTUCULARI İÇİN / FOR AHSK TOOL HOLDERS / FÜR AHSK WERKZEUGHALTER	AHSK63
AHSK80-CT	40	13.5	M20x1.5	AHSK TAKIM TUTUCULARI İÇİN / FOR AHSK TOOL HOLDERS / FÜR AHSK WERKZEUGHALTER	AHSK80
AHSK100-CT	44	15.5	M24x1.5	AHSK TAKIM TUTUCULARI İÇİN / FOR AHSK TOOL HOLDERS / FÜR AHSK WERKZEUGHALTER	AHSK100

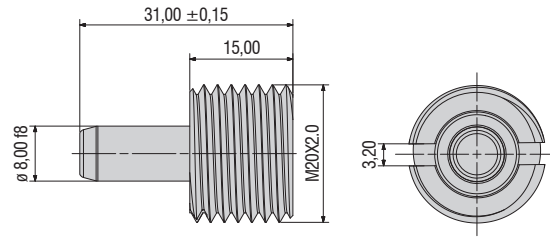

Sipariş Kodu Ordering Code Bestell-Bezeichnung	SOĞUTMA TÜPÜ / COOLANT TUBE / KÜHLMITTELSCHLAUCH			
	OAL	LB	THID	Ürün Detayı / Product Detail / Produkt-Details
AC6-CT-01	31	15	M20x2	POLİGONAL ŞAFTLI TUTUCULAR İÇİN / FOR POLYGONAL SHANK HOLDERS / FÜR POLYGONALE SCHAFTHALTER

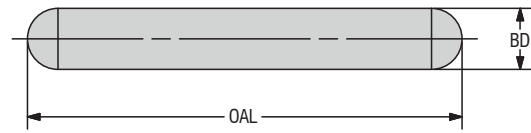
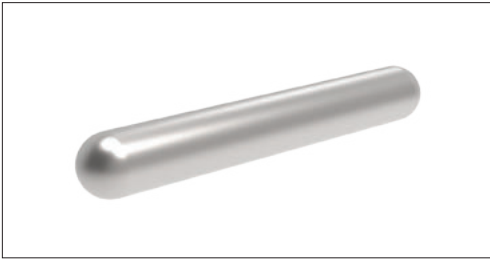

Sipariş Kodu Ordering Code Bestell-Bezeichnung	MINI CUT MERKEZLEME PİMİ / MINI CUT CENTERING PIN / MINI CUT-ZENTRIERSTIFT			
	OAL	LB	Ürün Detayı / Product Detail / Produkt-Details	
APM-28	17.80	2.5	MINI CUT TUTUCULARI İÇİN / FOR MINI CUT TOOL HOLDERS / FÜR MINI CUT WERKZEUGHALTER	APCH20-APCH22

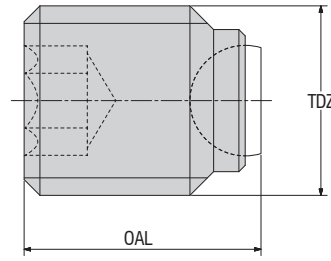
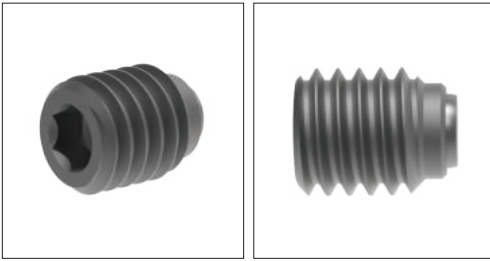

Sipariş Kodu Ordering Code Bestell-Bezeichnung	MINI CUT SIKMA ÇİVATASI / MINI CUT SCREW / MINI CUT SPANNBOLZEN			
	TDZ	OAL	Ürün Detayı / Product Detail / Produkt-Details	
4225-M6X7.5	M6	7.5	MINI CUT TUTUCULARI İÇİN / FOR MINI CUT TOOL HOLDERS / FÜR MINI CUT WERKZEUGHALTER	APCH20-APCH22
4225-M5x6	M5	6	MINI CUT TUTUCULARI İÇİN / FOR MINI CUT TOOL HOLDERS / FÜR MINI CUT WERKZEUGHALTER	APCH16

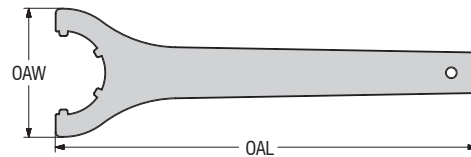

Sipariş Kodu Ordering Code Bestell-Bezeichnung	ER TİPİ ANAHTAR / WRENCH ER / SPANNSCHLÜSSEL ER			
	OAW	OAL	Ürün Detayı / Product Detail / Produkt-Details	
AWER-16	42.80	143.00	PENS TUTUCULARI İÇİN / FOR COLLET CHUCK HOLDERS / FÜR SPANNZANGAUFNAHME	ER16
AWER-20	53.50	172.00	PENS TUTUCULARI İÇİN / FOR COLLET CHUCK HOLDERS / FÜR SPANNZANGAUFNAHME	ER20
AWER-25	70.00	207.00	PENS TUTUCULARI İÇİN / FOR COLLET CHUCK HOLDERS / FÜR SPANNZANGAUFNAHME	ER25
AWER-32	78.00	255.00	PENS TUTUCULARI İÇİN / FOR COLLET CHUCK HOLDERS / FÜR SPANNZANGAUFNAHME	ER32
AWER-40	95.00	285.00	PENS TUTUCULARI İÇİN / FOR COLLET CHUCK HOLDERS / FÜR SPANNZANGAUFNAHME	ER40

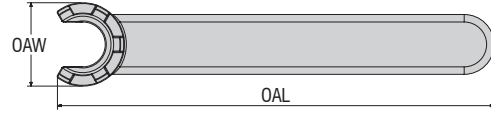

Sipariş Kodu Ordering Code Bestell-Bezeichnung	ER TİPİ ANAHTAR MİNİ / WRENCH ER MINI / SPANNSCHLÜSSEL ER MINI			
	OAW	OAL	Ürün Detayı / Product Detail / Produkt-Details	
AWER-11-M	16.80	95.00	PENS TUTUCULARI İÇİN / FOR COLLET CHUCK HOLDERS / FÜR SPANNZANGEAUFNAHME ER11-M	
AWER-16-M	22.50	117.00	PENS TUTUCULARI İÇİN / FOR COLLET CHUCK HOLDERS / FÜR SPANNZANGEAUFNAHME ER16-M	
AWER-20-M	28.00	128.00	PENS TUTUCULARI İÇİN / FOR COLLET CHUCK HOLDERS / FÜR SPANNZANGEAUFNAHME ER20-M	
AWER-25-M	36.00	140.00	PENS TUTUCULARI İÇİN / FOR COLLET CHUCK HOLDERS / FÜR SPANNZANGEAUFNAHME ER25-M	

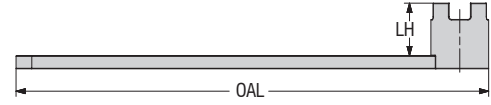
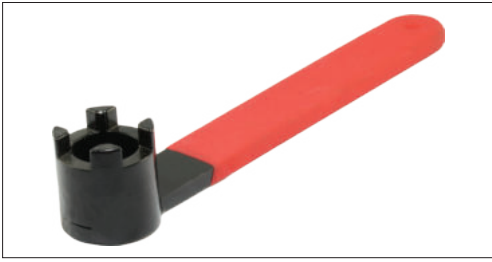

Sipariş Kodu Ordering Code Bestell-Bezeichnung	TARAMA BAŞLIK CİVATASI SIKMA ANAHTARI DIN 6368 / WRENCH FOR SHELL ARBOR DIN 6368 / SPANNSCHLÜSSEL DIN 6368 FÜR AUFSTECKDORNE				
	DRVS	FTDZ	OAL	LH	Ürün Detayı / Product Detail / Produkt-Details
AWFM-16	16.0	M8	180.00	20.0	YÜZEY FREZE TAKIM TUTUCULARI İÇİN / FOR FACE MILLING TOOL HOLDERS / FÜR PLANFRÄSE HALTER FM-16
AWFM-22	22.0	M10	200.00	25.0	YÜZEY FREZE TAKIM TUTUCULARI İÇİN / FOR FACE MILLING TOOL HOLDERS / FÜR PLANFRÄSE HALTER FM-22
AWFM-27	27.0	M12	225.00	32.0	YÜZEY FREZE TAKIM TUTUCULARI İÇİN / FOR FACE MILLING TOOL HOLDERS / FÜR PLANFRÄSE HALTER FM-27
AWFM-32	32.0	M16	250.00	36.0	YÜZEY FREZE TAKIM TUTUCULARI İÇİN / FOR FACE MILLING TOOL HOLDERS / FÜR PLANFRÄSE HALTER FM-32
AWFM-40	40.0	M20	280.00	40.0	YÜZEY FREZE TAKIM TUTUCULARI İÇİN / FOR FACE MILLING TOOL HOLDERS / FÜR PLANFRÄSE HALTER FM-40
AWFM-50	50.0	M24	315.00	50.0	YÜZEY FREZE TAKIM TUTUCULARI İÇİN / FOR FACE MILLING TOOL HOLDERS / FÜR PLANFRÄSE HALTER FM-50

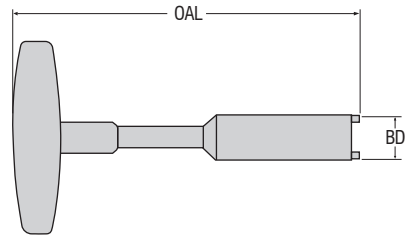

Sipariş Kodu Ordering Code Bestell-Bezeichnung	SOĞUTMA SUYU ÜNİTESİ ANAHTARI / WRENCH FOR DELIVERY UNIT FOR COOLANT / SCHLÜSSEL FÜR KÜHLMITTELÜBERGABEEINHEIT			
	OAL	BD	Ürün Detayı / Product Detail / Produkt-Details	
AWHSK-32	115	8.50	AHSK TAKIM TUTUCULARI İÇİN / FOR AHSK TOOL HOLDERS / FÜR AHSK WERKZEUGHALTER AHSK32	
AWHSK-40	115	10.50	AHSK TAKIM TUTUCULARI İÇİN / FOR AHSK TOOL HOLDERS / FÜR AHSK WERKZEUGHALTER AHSK40	
AWHSK-50	115	14.50	AHSK TAKIM TUTUCULARI İÇİN / FOR AHSK TOOL HOLDERS / FÜR AHSK WERKZEUGHALTER AHSK50	
AWHSK-63	136	16.50	AHSK TAKIM TUTUCULARI İÇİN / FOR AHSK TOOL HOLDERS / FÜR AHSK WERKZEUGHALTER AHSK63	
AWHSK-80	136	18.50	AHSK TAKIM TUTUCULARI İÇİN / FOR AHSK TOOL HOLDERS / FÜR AHSK WERKZEUGHALTER AHSK80	
AWHSK-100	136	22.00	AHSK TAKIM TUTUCULARI İÇİN / FOR AHSK TOOL HOLDERS / FÜR AHSK WERKZEUGHALTER AHSK100	



Veldon takım tutucular DIN 1835-B normuna uygun silindirik şaftlı kesici takımları sıkılamak için kullanılır. Lütfen sıkma tork değerlerine uyunuz.

End mill holders are used to clamp cylindrical shank cutting tools in accordance with DIN 1835-B standard. Please pay attention to the torque values.

Veldon Werkzeughalter werden zum Spannen von Zylinderschaft-Zerspanungswerkzeugen nach DIN 1835-B verwendet. Bitte beachten Sie die Anzugsdrehmomente.

SIKMA ÇAPI CLAMPING DIAMETER SPANNDURCHMÉR	VELDON SIKMA CİVATASI CLAMPING SCREW WELDON WELDON-KLEMMSCHRAUBE	SW (mm)	SIKMA TORKU (Nm) CLAMPING TORQUE (Nm) ANZUGSKRAFT (Nm)
Ø 6 mm	M6	3	10 Nm
Ø 8 mm	M8	4	10 Nm
Ø 10 mm	M10	5	16 Nm
Ø 12 mm	M12	6	28 Nm
Ø 14 mm	M12	6	28 Nm
Ø 16 mm	M14	6	42 Nm
Ø 18 mm	M14	6	42 Nm
Ø 20 mm	M16	8	50 Nm
Ø 25 mm	M18x2	10	60 Nm
Ø 32 mm	M20x2	10	72 Nm
Ø 40 mm	M20x2	10	72 Nm
Ø 50 mm	M24x2	12	90 Nm
Ø 63 mm	M24x2	12	90 Nm

PENS TUTUCULAR TEKNİK BİLGİ
COLLET CHUCK TECHNICAL DATA
SPANNZANGEN TECHNISCHE DATEN

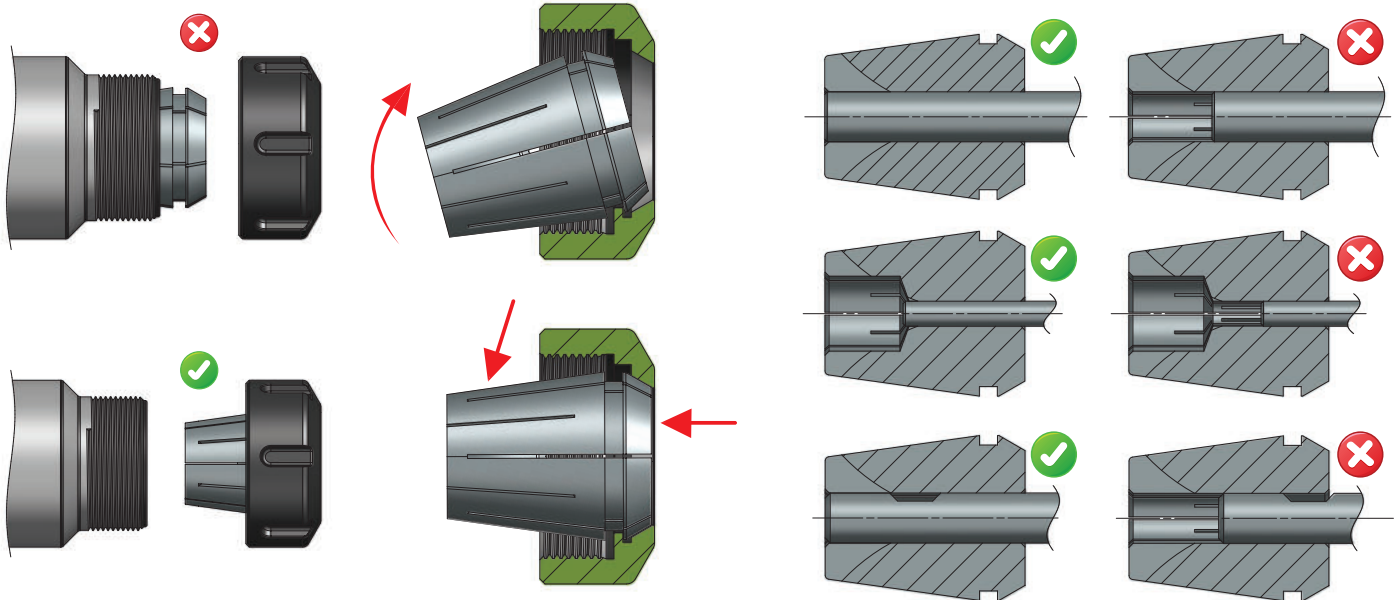

PENS ÖLÇÜSÜ COLLET CHUCKS DIMENSION ABMESSUNGEN DER SPANNFUTTER	PENS KAPAĞI CLAMPING NUTS SPANNMUTTER	SIKMA TORKU CLAMPING TORQUE ANZUGSKRAFT
ER 16 M	M19 x 1	28 Nm
ER 16	M22 x 1.5	50 Nm
ER 20	M25 x 1.5	75 Nm
ER 25	M32 x 1.5	85 Nm
ER 32	M40 x 1.5	105 Nm
ER 40	M50 x 1.5	150 Nm

Maksimum performans için, sıkma somunu dışı ve pens konik kullanılmadan önce temizlenmeli ve yağlanmalıdır. En iyi sonuç için, kesici takımı pensin sıkma boyunun tamamına yerleştiriniz.

Locking nut thread and collet taper for maximum performance must be cleaned and lubricated before use. For best performance, put the cutting tool over the entire clamping length of the collet.

Sicherungsmuttergewinde und Spannzangenkonus für maximale Leistung müssen vor Gebrauch gereinigt und geschmiert werden. Für beste Ergebnisse, setzen Sie das Schneidwerkzeug über die gesamte Spannlänge der Spannzange ein.



the spoken
quality...
konuşulan
kalite...
qualität über die
man spricht...
akko.com.tr



**THE
SPOKEN
QUALITY**

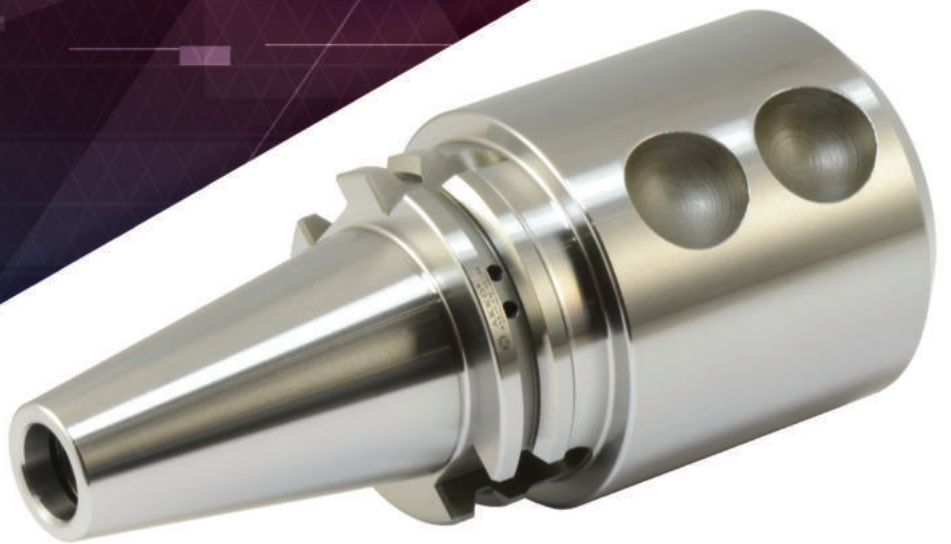

www.akko.com.tr

konusulan
the spoken kalite...
quality...

Değiştirilebilir Uçlu Takımlar,
Takım Tutucu Sistemler ve Kesici Uçlar
Indexable Tools, Tool Holder Systems and Cutting Inserts
Zerpanungswerkzeuge, Werkzeugaufnahmen
und Zerspanungswerkzeuge

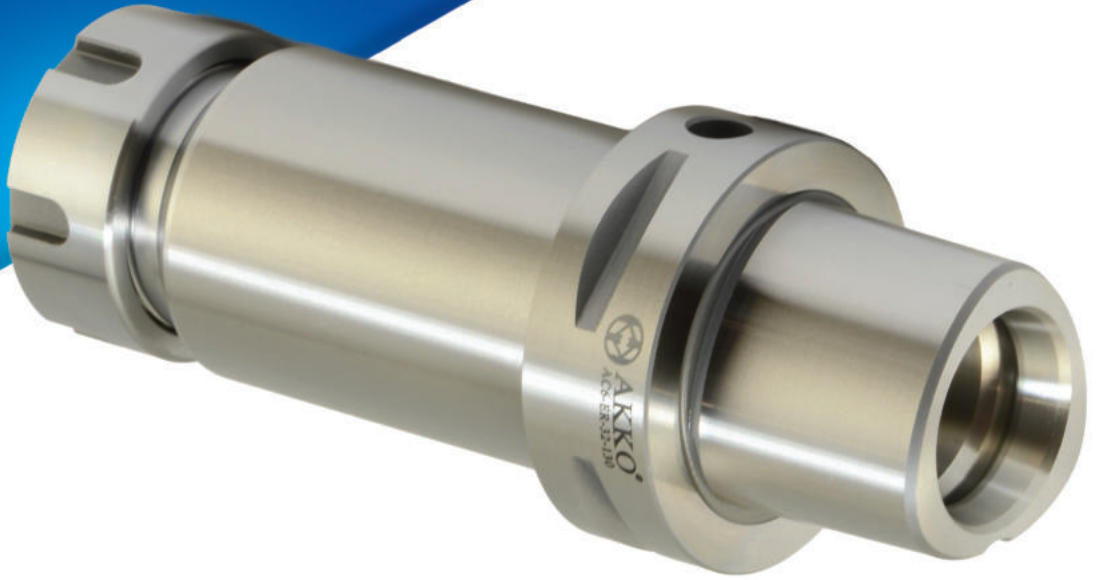

TS EN ISO 9001:2015



AKKO Metalworking Tools

AKKO GLOBAL NETWORK

Europe's Largest Integrated Tool and Holder Facility

KONUŞULAN
KALİTE

THE SPOKEN
QUALITY



Konya 5. Organize Sanayi Bölgesi
Asağınarbaşı Osb Mh. 526 Nolu Sk. No:1
Selçuklu / KONYA / TÜRKİYE

Tel : +90 332 239 17 57 (pbx)
Fax : +90 332 239 17 52
GPS : 38.005409, 32.635734

www.akk.com.tr
akko@akko.com.tr
export@akko.com.tr



AKKO Metalworking Tools

Yenilikler için bizi takip edin!
Follow us for news!
Für Neuheiten bitte uns folgen!



Balgheimer Str. 40 78549 Spaichingen
GERMANY

Phone : +49 7424 905 4013
GPS : 48.06906079976586, 8.754463836369949

www.akkoeurope.eu / office@akkoeurope.eu / info@akkoeurope.eu



AKKO Metalworking Tools

Für Neuheiten bitte uns folgen!



Office: 900 N Arlington Heights Rd Itasca, IL 60143
Warehouse: 1055 W Devon Avenue Suite 300
Itasca IL 60143 Illinois, USA

Phone: +1 847 600 9606
GPS : 41.982969625099386, -88.00574353196833



AKKO USA INC.

Follow us for news!
www.akkousa.us
info@akkousa.us



No.998,Baicao Road,Gaoxinxi District,
Chengdu China

Phone: +86 18328589975