

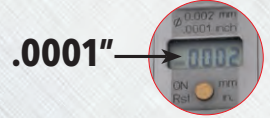

**Diameter Range:**  
 Ø .098" - 106.299"  
 (2.5mm - 2700mm)

**Connection Size**  
 MHD-32, MHD-40, MHD-50,  
 MHD-63, MHD-80  
 Fully compatible with  
 existing MHD product line

**Precision / Accuracy**  
 .0001" (.002mm)  
 Direct measurement system  
 displays actual movement of slide



## Digital Finish Boring Head with .0001" (0.002mm) Ø Setting Accuracy

The TRE fine boring head family is a system in which the radial slide traverse is now viewable on a built-in digital display, ensuring the ability to adjust quickly, precisely and accurately. Unlike traditional fine boring heads that feature a dial adjusting mechanism, the TRE family features a direct drive measuring system that shows the exact measurement of adjustment. This is particularly helpful when overcoming fine adjustment backlash issues that cannot be seen with the naked eye. With the digital readout, what you see is what you get.

The entire TRE family is fully compatible with our existing MHD system, and can also be purchased in kit form.

### **General Features:**

- **NEW** TRE32 and TRE40 heads for diameters as small as 1.377"
- Minimal backlash compensation
- Single button operation for functions 'On', 'Reset', and to change between inch and metric
- Display resolution .0001" (.002mm)
- Energy saving function. Display switches off automatically after 30 seconds and stores last display value
- Internal coolant thru
- High level of resistance to dust and water rated at IP67



**TRE OVERVIEW - .098" - 7.874" (2.5~200)**

**NEW** **TRE32**  
 Ø 1.377" - 2.007" (35 ~ 51)



**NEW** **TRE40**  
 Ø 1.889" - 2.519" (48 ~ 64)



**TRE50**  
 Ø .098" - 4.330" (2.5 ~ 110)



**TRE63**  
 Ø .236" - 4.921" (6 ~ 125)



**TRE80**  
 Ø .236" - 7.874" (6 ~ 200)



**TRE200**  
 Ø 7.874" - 106.299" (200 ~ 2700)

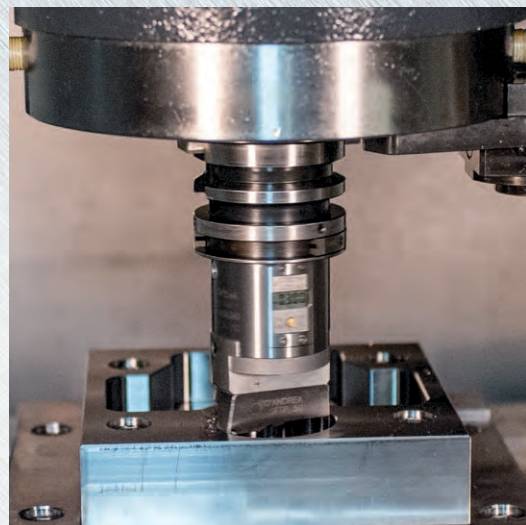

\*NOTE: Dimensions in parenthesis indicate Metric.

**NEW**

**TRE 32 - Ø 1.377" - 2.007" (35~51)**

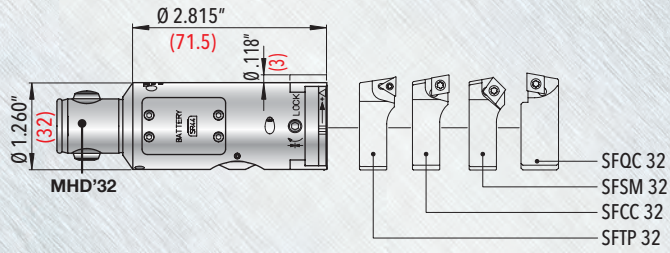

Ø 1.377" - 2.007"  
(35 ~ 51)

MHD'	REF.	CODE	Lbs
32	TRE32	455200320320	0.220

**NEW**

**TRE 40 - Ø 1.889" - 2.519" (48~64)**

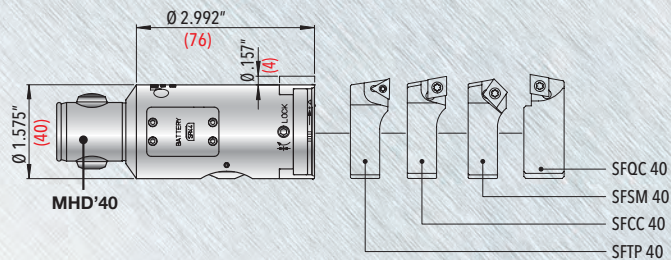

Ø 1.889" - 2.519"  
(48 ~ 54)

MHD'	REF.	CODE	Lbs
40	TRE40	455200400400	0.440

\*NOTE: Dimensions in parenthesis indicate Metric.

# TRE 50 - Ø .098" - 4.330" (2.5~110)

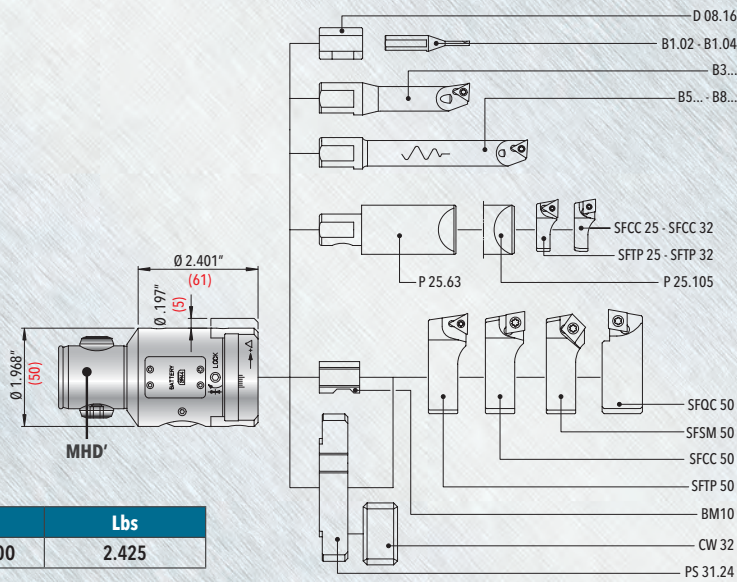

Ø 0.098" - 1.181"  
(2.5 ~ 30)

Ø 1.102" - 2.205"  
(28 ~ 56)

Ø 2.126" - 4.330"  
(54 ~ 110)

MHD'	REF.	CODE	Lbs
50	TRE50	455200500500	2.425

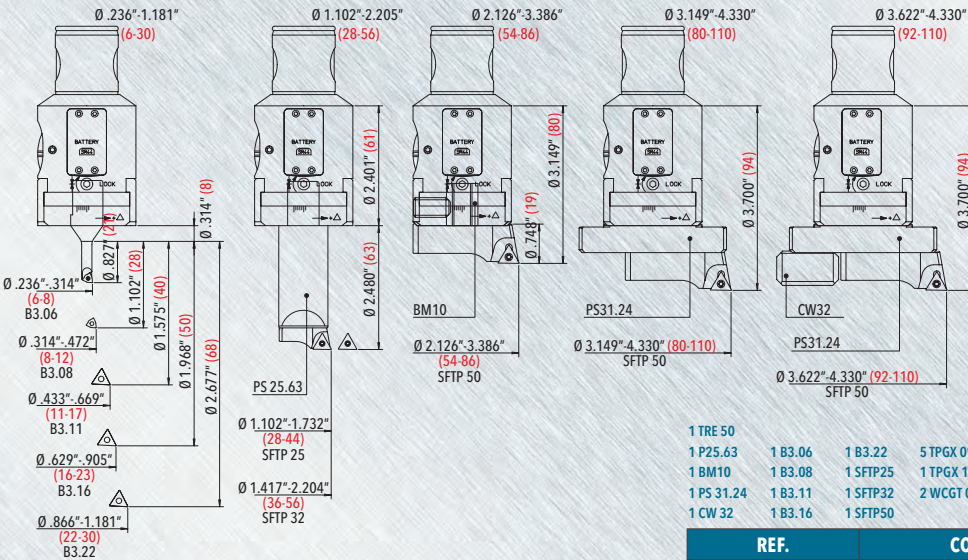

**KIT K01**  
Ø 0.236" - 4.330"  
(6 ~ 110)



- 1 TRE 50
- 1 P25.63
- 1 BM10
- 1 PS 31.24
- 1 CW 32
- 1 B3.06
- 1 B3.08
- 1 B3.11
- 1 B3.16
- 1 B3.22
- 5 TPGX 090202L
- 1 TPGX 110302L
- 2 WCGT 020102L

REF.	CODE	Ø
K01TRE50	655200500500	0.236" - 4.330" (6 ~ 110)

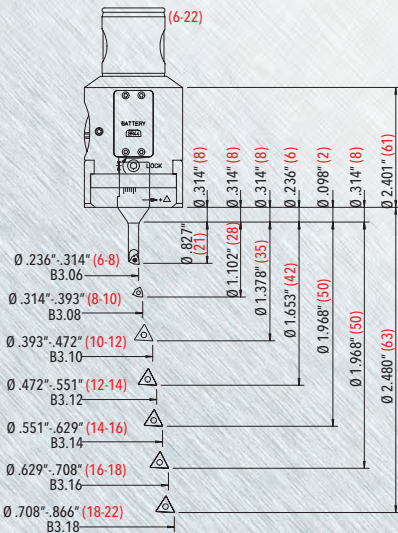

**KIT K00**  
Ø 0.236" - .866"  
(6 ~ 22)



- 1 TRE 50
- 1 B3.06
- 1 B3.08
- 1 B3.10
- 1 B3.12
- 1 B3.14
- 1 B3.16
- 1 B3.18
- 5 TPGX 090202L
- 2 WCGT 020102L

REF.	CODE	Ø
K00TRE50	655200500501	0.236" - .866" (6 ~ 22)

\*NOTE: Dimensions in parenthesis indicate Metric.

# TRE 63 - Ø.236" - 4.921" (6~125)

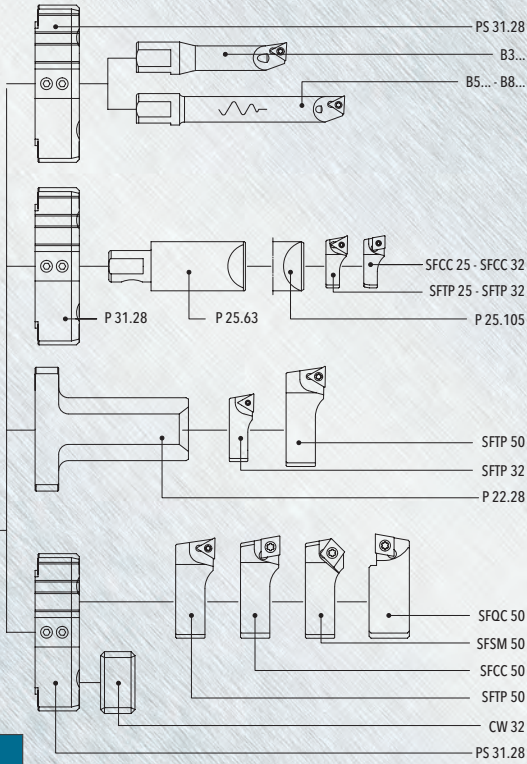
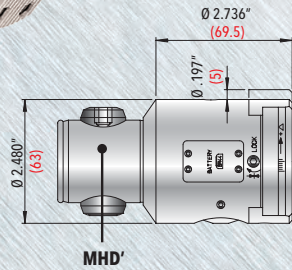

Ø.236" - 1.181"  
(6 ~ 30)

Ø 1.102" - 2.205"  
(28 ~ 56)

Ø 1.575" - 2.913"  
(40 ~ 74)

Ø 2.834" - 4.921"  
(72 ~ 125)

MHD'	REF.	CODE	Lbs
63	TRE63	455200630630	4.85

## KIT K01

Ø 0.236" - 4.921"  
(6 ~ 125)

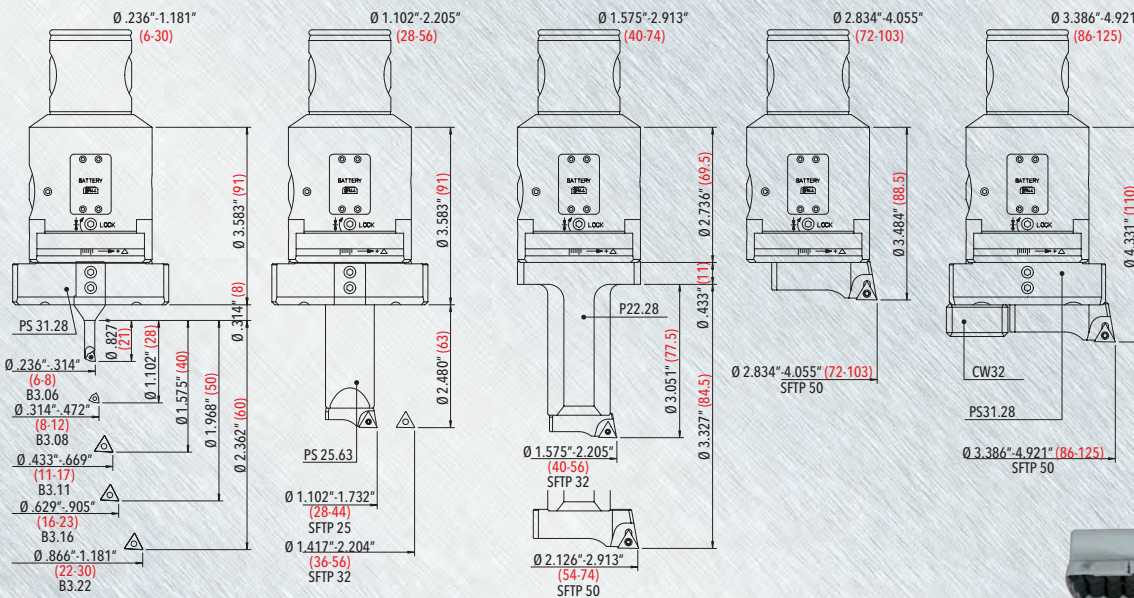

- 1 TRE 63
- 1 P25.63
- 1 P22.28
- 1 PS 31.28
- 1 CW 32
- 1 B3.06
- 1 B3.08
- 1 B3.11
- 1 B3.16
- 1 B3.22
- 5 TPGX 090202L
- 1 TPGX 110302L
- 2 WCGT 020102L

REF.	CODE	Ø
K01TRE63	655200500630	0.236" - 4.921" (6 ~ 125)

\*NOTE: Dimensions in parenthesis indicate Metric.

# TRE 80 - Ø .236" - 7.874" (6~200)

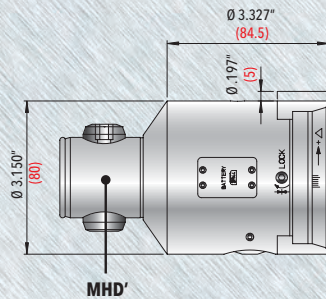

MHD'

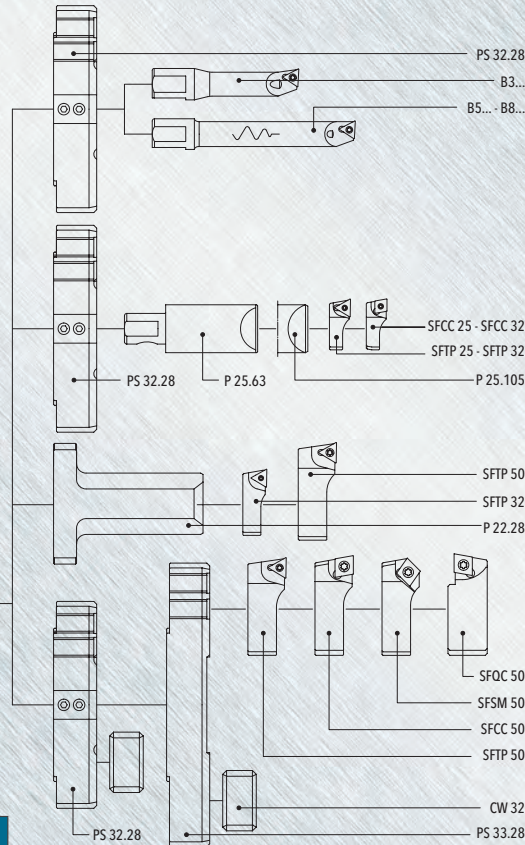

Ø .236" - 1.181"  
(6 ~ 30)

Ø 1.102" - 2.205"  
(28 ~ 56)

Ø 1.575" - 3.386"  
(40 ~ 86)

Ø 3.346" - 7.874"  
(85 ~ 200)

MHD'	REF.	CODE	Lbs.
80	TRE 80	455200800800	8.60

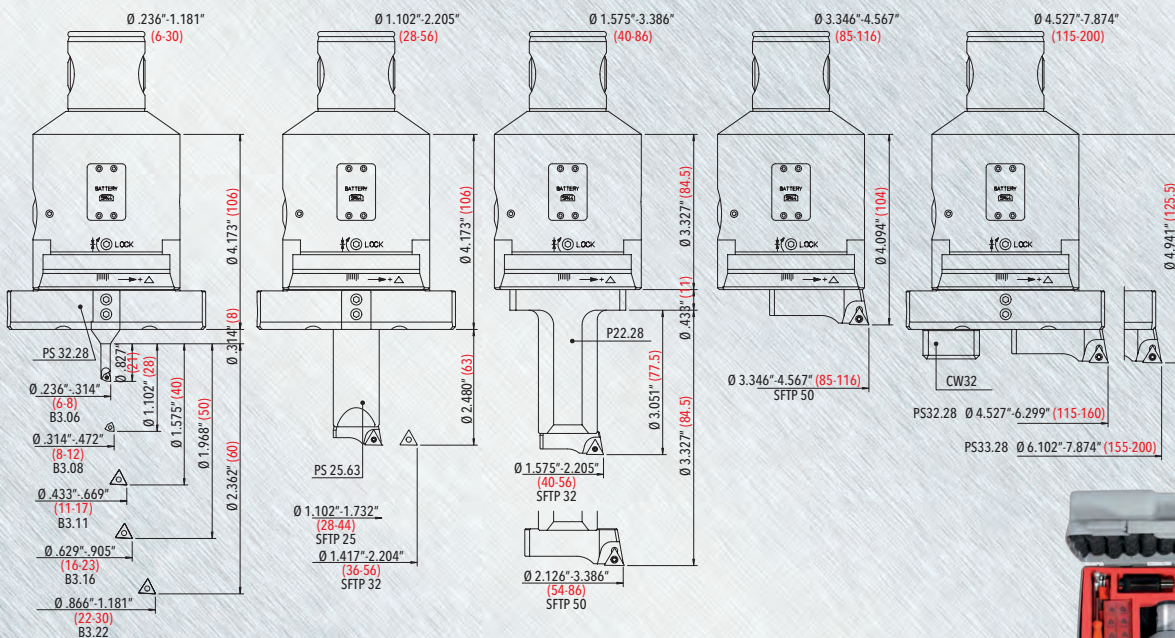

## KIT K01

Ø 0.236" - 7.874"  
(6 ~ 200)

- 1 TRE 80
- 1 P25.63
- 1 P22.28
- 1 PS 32.28
- 1 PS 33.28
- 1 CW 32
- 1 B3.06
- 1 B3.22
- 1 B3.08
- 1 B3.11
- 1 B3.16
- 1 SFTP50
- 5 TPGX 090202L
- 1 TPGX 110302L
- 2 WCGT 020102L



\*NOTE: Dimensions in parenthesis indicate Metric.

REF.	CODE	Ø
K01TRE80	655200500800	0.236" - 7.874" (6 ~ 200)

# TRE 200 - Ø 7.874" - 106.299" (200~2700)

TRE200 is for use with BPS Crossbar - Found in Precision Boring Catalog

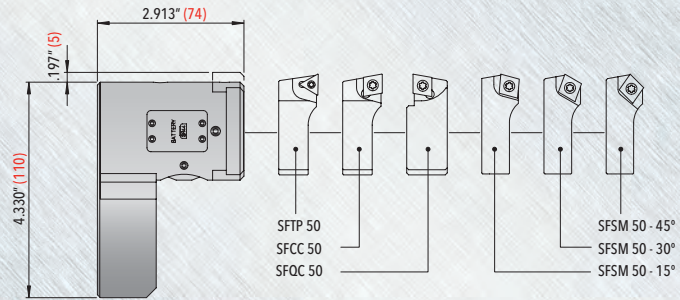

REF.	CODE	Lbs
TRE200	455220002000	3.75

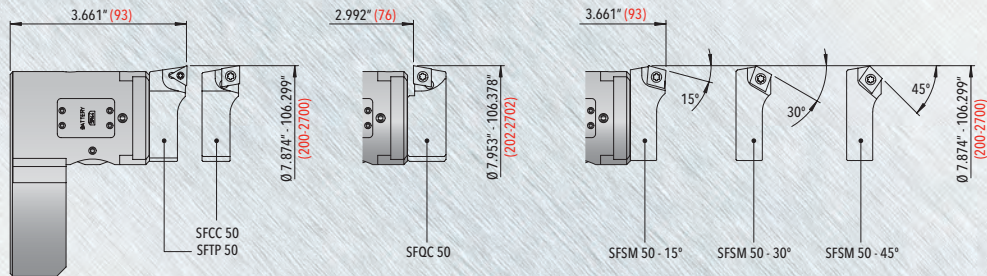

## CW

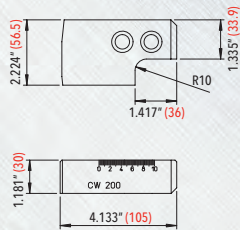

REF.	CODE	Lbs.
CW 200	392011010501	2.86

## PRL

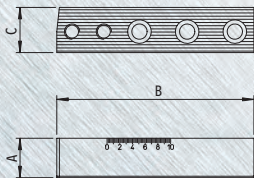

REF.	CODE	A	B	C	Lbs.
PRL 100	392011015501	1.220" (31)	6.102" (155)	1.397" (35.5)	2.42
PRL 300	392011030001	1.614" (41)	10.039" (255)		6.17

\*NOTE: Dimensions in parenthesis indicate Metric.

# TRE COMPONENTS

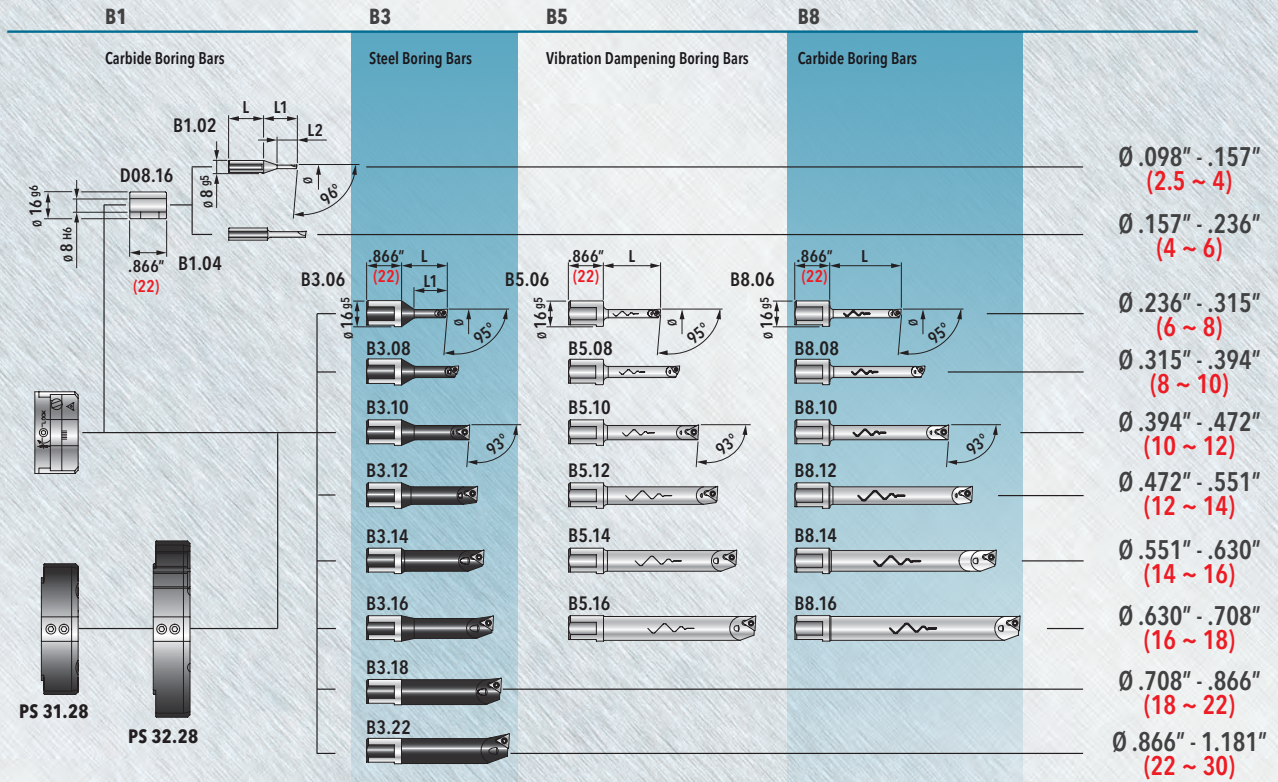

REF.	CODE	Lbs.
D08.16	200560116082	.044

REF.	CODE	Ø	L	L1	L2	Lbs.
B1.02	572010502001	.098"-.157" (2.5 ~ 4)	.87" (22)	.83" (21)	.49" (12.5)	.044
B1.04	572010504001	.157"-.236" (4 ~ 6)	.95" (24)	.95" (24)	-	

REF.	CODE	Ø	L	L1	⚙️	⚙️	🔩	🔩	Lbs.
B3.06	572010506001	.236"-.315" (6 ~ 8)	1.14" (29)	.83" (21)	WCGT 0201..	-	TS 21	TORX T06	.077
B3.08	572010508001	.315"-.394" (8 ~ 10)	1.41" (36)	1.10" (28)			TS 211		.088
B3.10	572010510001	.394"-.472" (10 ~ 12)	1.69" (43)	1.38" (35)					.110
B3.11	572010511001	.430"-.510" (11 ~ 13)	1.89" (48)	1.57" (40)					.121
B3.12	572010512001	.472"-.551" (12 ~ 14)	2.05" (52)	1.65" (42)					.132
B3.14	572010514001	.551"-.630" (14 ~ 16)	2.28" (58)	1.97" (50)	-	TPGX 0902..	CS 250 T	TORX T08	.154
B3.16	572010516001	.630"-.708" (16 ~ 18)	2.48" (63)	-					.220
B3.18	572010518001	.708"-.866" (18 ~ 22)	2.68" (68)	-					.220
B3.22	572010522001	.866"-.1.181" (22 ~ 30)	2.68" (68)	-					.220

B5.06	572010506105	.236"-.315" (6 ~ 8)	1.42" (36)		WCGT 0201..	-	TS 21	TORX T06	.165
B5.08	572010508105	.315"-.394" (8 ~ 10)	1.89" (48)				TS 211		.198
B5.10	572010510105	.394"-.472" (10 ~ 12)	2.36" (60)						.220
B5.12	572010512105	.472"-.551" (12 ~ 14)	2.83" (72)		-	TPGX 0902..	CS 250 T	TORX T08	.440
B5.14	572010514105	.551"-.630" (14 ~ 16)	3.31" (84)						.661
B5.16	572010516105	.630"-.708" (16 ~ 18)	3.78" (96)						.661

B8.06	572010506108	.236"-.315" (6 ~ 8)	1.77" (45)		WCGT 0201..	-	TS 21	TORX T06	.143
B8.08	572010508108	.315"-.394" (8 ~ 10)	2.36" (60)				TS 211		.176
B8.10	572010510108	.394"-.472" (10 ~ 12)	2.95" (75)						.220
B8.12	572010512108	.472"-.551" (12 ~ 14)	3.54" (90)		-	TPGX 0902..	CS 250 T	TORX T08	.440
B8.14	572010514108	.551"-.630" (14 ~ 16)	4.13" (105)						.661
B8.16	572010516108	.630"-.708" (16 ~ 18)	4.72" (120)						.661

\*NOTE: Dimensions in parenthesis indicate Metric.



# TRE COMPONENTS

## Toolholders for TRE

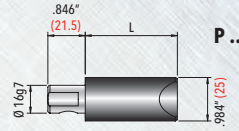
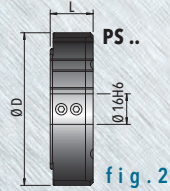
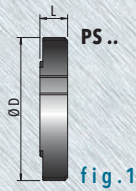

REF.	CODE	ØD	L	Lbs.	fig.
PS31.24	433024140751	2.953" (75)	.571" (14.5)	.440	1
PS31.28	433028220801	3.150" (80)		.661	2
PS32.28	433028221081	4.251" (108)	.886" (22.5)	1.102	
PS33.28	433028221481	5.827" (148)		1.322	1
CW32	392011003201	-	-	1.102	-

REF.	CODE	L	Lbs.
P25.63	435116250630	2.087" (53)	1.102
P25.105	435116251050	3.740" (95)	1.764

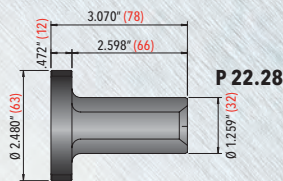

REF.	CODE	Lbs.
P 22.28	433028220631	0.992

## Bit-holders for TRE

SF

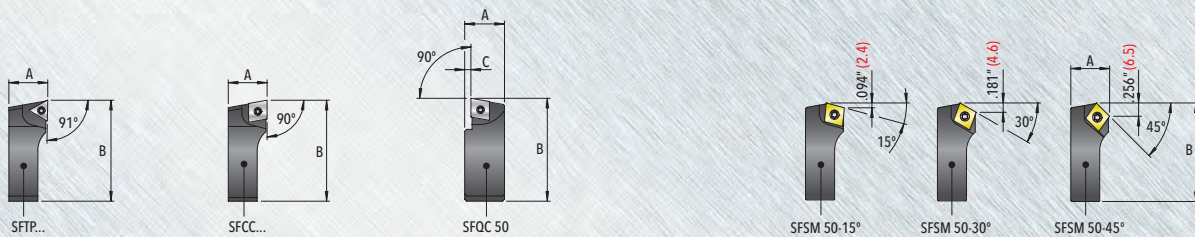

REF.	CODE	A	B	C	△	□	⊥	⌘	Lbs.
SFTP 25	470500525001	.394" (10)	1.043" (26.5)	-	TPGX 0902..	-	CS 250T	TORX T08	.022
SFTP 32	470500532001	.453" (11.5)	1.358" (34.5)	-	-	-	-	TORX T08	.044
SFTP 50	470500550001	.748" (19)	2.047" (52)	-	TPGX 1103..	-	CS 300890T	TORX T15	.176
SFCC 25	470500525002	.394" (10)	1.043" (26.5)	-	-	CCGT 0602..	TS 25	TORX T08	.022
SFCC 32	470500532002	.453" (11.5)	1.358" (34.5)	-	-	CCGT 09T3..	TS 4	TORX T15	.176
SFCC 50	470500550002	.748" (19)	2.047" (52)	-	-	CCGT 09T3..	TS 4	TORX T15	.176
SFQC 50	470500550062	.807" (20.5)	2.086" (53)	.118" (3)	-	CCMT 09T3..	TS 4	TORX T15	.220
SFSM 50-15°	470500550011	.748" (19)	1.988" (50.5)	-	-	CCMT 09T3..	TS 4	TORX T15	.154
SFSM 50-30°	470500550013								
SFSM 50-45°	470500550015								

\*NOTE: Dimensions in parenthesis indicate Metric.

# OPERATING INSTRUCTIONS FINISH BORING HEAD with .0001" (0.002 mm) Ø Setting Accuracy

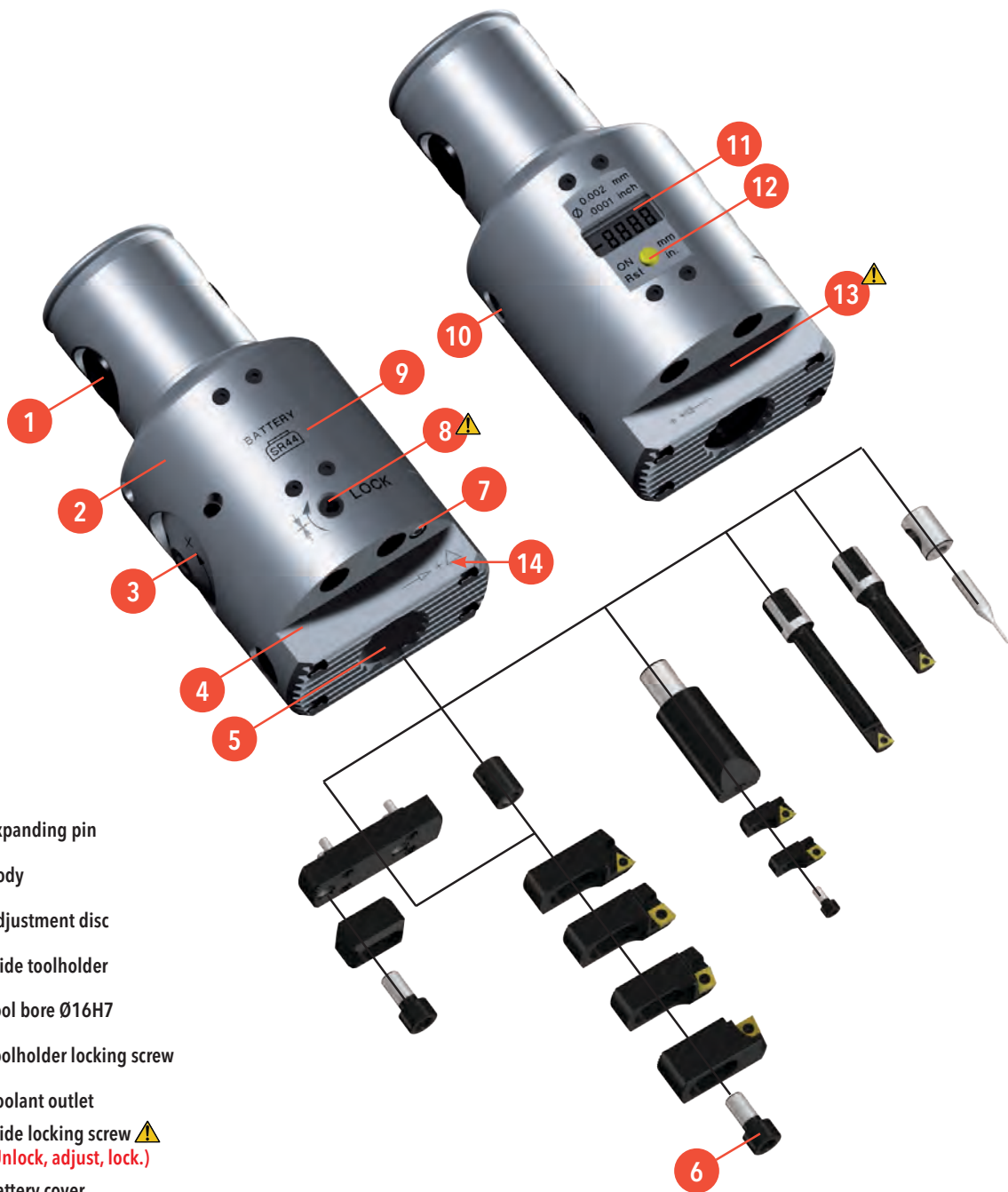

- 1 Expanding pin
- 2 Body
- 3 Adjustment disc
- 4 Slide toolholder
- 5 Tool bore Ø16H7
- 6 Toolholder locking screw
- 7 Coolant outlet
- 8 Slide locking screw ⚠  
(Unlock, adjust, lock.)
- 9 Battery cover
- 10 Oiling nipple
- 11 Digital display
- 12 Selection button
- 13 Slide adjusting range ⚠  
(Do not exceed the range marked.)
- 14 Cutting edge position mark

## ASSEMBLY - REFERENCE PREVIOUS PAGE FOR (#)

### ASSEMBLY

- Before mounting the TRE boring head, make sure that expanding pin (1), does not protrude from the cylindrical body part
- Insert TRE into the shank
- Tighten pin (1) by turning clockwise  
(Recommended torque: **30-35 Nm/ 22-25 ft. lbs.**)
- Insert the screw (6). If it protrudes, the sleeve should be rotated until the screw can enter the recess in the sleeve nut, reduction sleeve or boring bar.  
(Recommended torque: **35-50 Nm/ 22-25 ft. lbs.**)

### DISASSEMBLY

In order to separate the TRE from the shank, loosen the expanding pin (1) by turning counterclockwise.

### OPERATION

The tool slide (4) allows for a .1968" (5mm) adjustment, by turning adjusting disc (3) counterclockwise .

- Switch on the device by pushing the selection button (12).  
The display will show the value of the previous adjustment.
- To reset this value, push button (12) for 2 seconds.
- Unscrew the slide locking screw (8) ( **fig. a** ).
- Perform the adjustment. The display (11) shows the dimensional change to the previously set value or to "0", with a .0001" (.002mm) screen resolution ( **fig. b** ).
- After positioning, lock the tool slide with clamp screw (8).  
(Recommended torque: **1-1.2 Nm/ .73-.88 ft. lbs.**) ( **fig. c** )
- The display switches off automatically if the device is unused for more than 30 seconds.
- **Loosen screw (8) before making any slide adjustment!**

### SETTING inch (mm)

By pressing the selection button (12) for 10 seconds, the measurement unit changes from "mm" to "inch" and back. This process resets the value on the display.

### BATTERY CHANGE

In case of low battery the message "batt" appears on the display, please replace the batteries as soon as possible.

- Open battery cover (9) by loosening screws.
- Remove the batteries and dispose them correctly.
- Put in new batteries; make sure the positive and negative ends are facing the correct direction.
- Replace battery cover and fasten screws.  
(Use two SR44 1.55V batteries)

### MAINTENANCE

Weekly:

- Lubricate through the nipple (10) with ISO UN G220 oil.

### PERIODICALLY

- Clean and lubricate the conical and cylindrical matching surfaces.
- Treat expanding pin (1) with anti-friction lubricant.
- Clean and lubricate the tool slide guideway.

### IMPORTANT NOTES:

- Toolholder should be firmly affixed to the slide.
- **DO NOT perform any movement of the slide when the display (11) is switched off!**

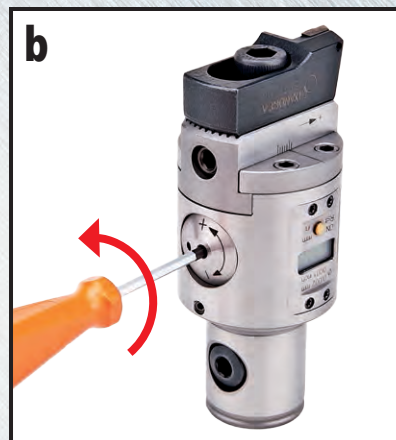
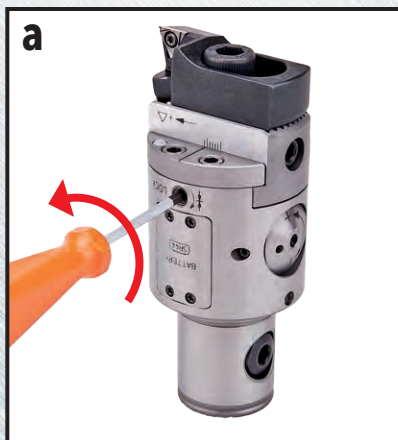

**Failure to follow adjusting sequence pictured above will result in internal damage to the head and void the warranty.**

**AHB** Tooling & Machinery, Inc.  
Complete Metalworking Solutions  
Roseville Saginaw & Jackson, MI

ISO Certified  
(800) 991-4225  
www.ahbinc.com  
customerservice@ahbinc.com