

# Hypertherm®

## Abrasive Regulator II™

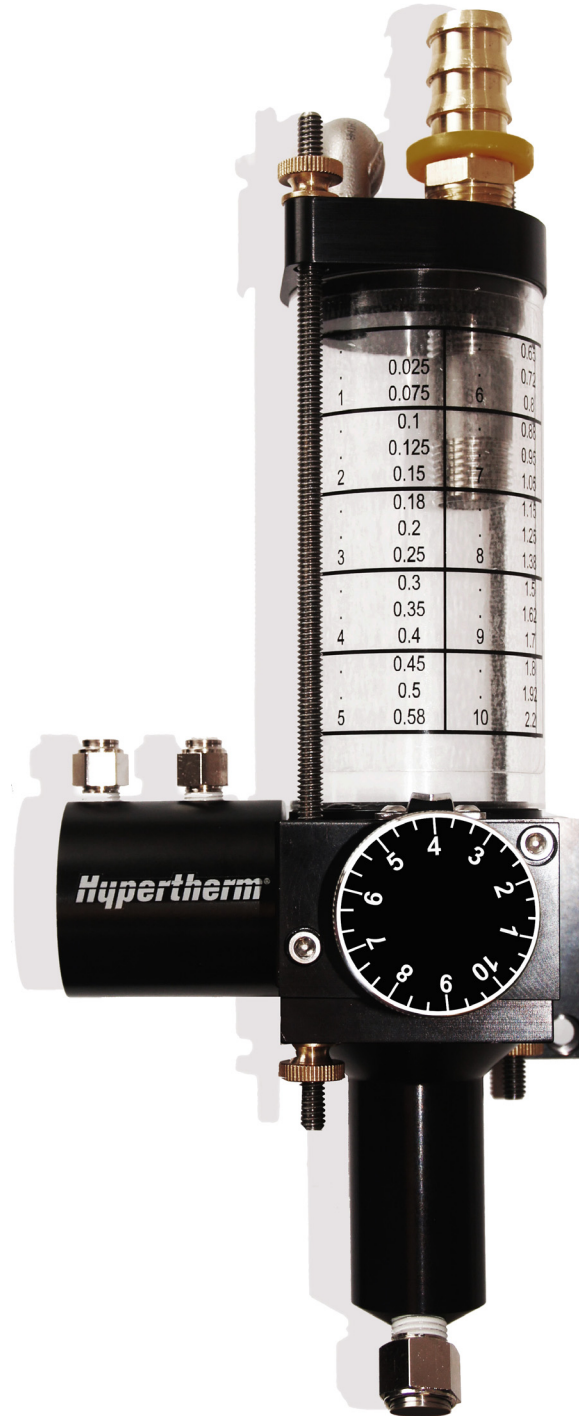

Instruction Manual

809030 | Revision 0 | English

## North America

### **USA and Canada**

Technical service

800-643-9878 Toll-free

TechnicalService-Hanover@Hypertherm.com

Customer service

800-737-2978 Toll-free

Return materials

866-643-7711 Toll-free

## Asia Pacific

TechnicalService-Asia@Hypertherm.com

### **Singapore**

65 6841 2489

65 6841 2490 Fax

### **China**

86-21-60740003

86-21- 60740393 Fax

### **Japan**

+81-6-6225-1183

+81-6-6225-1184 Fax

### **India**

+91-11-40521201/ 2/ 3/

+91 7838908053 Mobile

+91-11 40521204 Fax

### **Korea**

+82-51-747-0358

+82-51-701-0358 Fax

## Australia and New Zealand

+61 (0) 7 3103 1695

+61 (0) 4 3760 6995 Mobile

+61 (0) 7 3219 9012 Fax

## Europe, Middle East, and Africa

Technical service

00 800 4973 7843 Toll-free

+31(0) 165 596900

+31(0) 165 596906 Fax

TechnicalService-HyperthermEurope@Hypertherm.com

Customer service

00 800 3324 9737 Toll-free

+31 (0) 165 526156

00 800 4973 7329 Toll-free fax

+31 (0) 165 596948 Fax

Return materials

+31 (0) 165 596936

+31 (0) 165 596906 Fax

## South America

TechnicalService-SA@Hypertherm.com

### **Brazil**

55 11 2409 2636

55 11 2408 0462 Fax

### **Argentina**

+54 (11) 5199-4668

### **Peru**

+51 (1) 718-5090

### **Chile**

+56 (2) 495-7369

### **Venezuela**

+58 (212) 335-7522

## México

52 55 5681 8109

52 55 5681 7978

52 55 5683 2127 Fax

# ***Abrasive Regulator II***

## **Instruction Manual**

809030  
Revision 0

English  
Original Instructions

October 2015

Hypertherm Inc.  
Hanover, NH 03755 USA  
[www.hypertherm.com](http://www.hypertherm.com)



<b>Warranty .....</b>	<b>SC-7</b>
<b>Environmental stewardship .....</b>	<b>SC-9</b>
Proper disposal of Hypertherm products .....	SC-9
Particle emission and wastewater quality .....	SC-9
<b>Safety .....</b>	<b>SC-11</b>
National and local safety regulations .....	SC-11
User qualification and training .....	SC-11
<b>Symbols and marks .....</b>	<b>SC-13</b>
<b>1 Terminology .....</b>	<b>15</b>
<b>2 Product description .....</b>	<b>17</b>
<b>3 Operation .....</b>	<b>19</b>
Safety .....	19
Inspect the regulator before operation .....	19
Operate the regulator .....	19
Adjust the regulator for a new abrasive .....	21
<b>4 Preventive maintenance .....</b>	<b>23</b>
Safety .....	24
Replace worn plates .....	25
Recalibrate the control knob .....	30
<b>5 Parts lists .....</b>	<b>31</b>
Replacement parts .....	32
Other parts .....	32
Complete list of preventive maintenance parts, tools, and materials .....	33
<b>6 Troubleshooting .....</b>	<b>35</b>
<b>7 Installation .....</b>	<b>37</b>
Safety .....	37
Buyer obligations .....	37
Requirements .....	38
Attach the abrasive regulator to the cutting table .....	38
Connect the abrasive regulator to the solenoid valve .....	40
Connect the abrasive regulator to the abrasive pot .....	41
Do the first startup .....	41
Recycling and end of product life .....	42



**Waterjet product warranty coverage**

<b>Product</b>	<b>Parts coverage</b>
<b>HyPrecision pumps</b>	27 months from the ship date, or 24 months from the date of proven installation, or 4,000 hours, whichever occurs first
<b>Bulk abrasive hoppers</b>	15 months from the ship date or 12 months from the date of proven installation, whichever occurs first
<b>Abrasive metering devices</b>	15 months from the ship date or 12 months from the date of proven installation, whichever occurs first
<b>On/off valve air actuators</b>	15 months from the ship date or 12 months from the date of proven installation, whichever occurs first
<b>Diamond orifices</b>	600 hours of use with the use of a thimble filter and compliance with Hypertherm's water quality requirements

Consumable parts are not covered by this warranty. Consumable parts include, but are not limited to, high-pressure water seals, check valves, cylinders, bleed-down valves, low-pressure seals, high-pressure tubing, and low- and high-pressure water filters.

## Warranty

---



### **Proper disposal of Hypertherm products**

Hypertherm waterjet cutting systems, like all products with electronics, can contain materials or parts, such as printed circuit boards, that can not be discarded with ordinary waste. It is your responsibility to dispose of Hypertherm product or part in an environmentally suitable manner and in compliance with national and local codes.

In the United States, check all federal, state, and local laws. In the European Union (EU), check the EU directives, national, and local laws. For more information, go to [www.hypertherm.com/weee](http://www.hypertherm.com/weee). In other countries, check national and local laws. Consult with legal or other compliance experts when applicable.

### **Particle emission and wastewater quality**

Hypertherm does not manufacture or supply the materials that are cut and has no knowledge whether the particles released from materials that are cut will pose a physical hazard or health risk. Consult with your supplier or other technical advisor if you need guidance concerning the properties of the material you will cut using a Hypertherm product.

If you are not fully aware of and up to date on all applicable government regulations and legal standards for the installation site, consult a local expert before purchasing, installing, and operating the equipment.

## Environmental stewardship

---

## **National and local safety regulations**

National and local safety regulations shall take precedence over instructions supplied with the product. The product shall be imported, installed, operated, and disposed of in accordance with national and local regulations applicable to the installed site.

## **User responsibilities**

The end user is responsible for the safe operation of this equipment.

The safety precautions in this manual are general and can not anticipate every situation. Hypertherm Inc. acknowledges that unforeseen situations due to equipment failure, site variability, insufficient maintenance, failure of control equipment, and other events can cause equipment damage, injuries, or death. It is the user's responsibility to identify hazards and take the steps necessary to minimize risks.

Keep these instructions near the equipment. This manual is intended to familiarize the user with the equipment and its parts, operation, and maintenance.

All people who operate or are exposed to this equipment must know this information:

- Applicable safety standards
- The use, limitations, and care of personal protective equipment
- The location of the written hazard communication program and safety data sheets

## **User qualification and training**

All users must read and understand these instructions before installing, operating, or doing maintenance on this equipment.

Operators must be qualified to install, operate, and maintain this equipment. Training should include this information:

- How to start and stop the equipment during routine operation and in an emergency situation
- The conditions and actions that can lead to injuries to people and damage to the equipment
- How to operate all controls
- How to do maintenance procedures
- A copy of this manual

This list is not all-inclusive.













Specific safety messages are included in the relevant sections of this manual.

## Safety

---

## Information and hazard symbols

Some symbols in this table could be relevant to other products.

 <b>DANGER</b>	<p>This symbol identifies an imminently hazardous situation, which, if not avoided, will result in death or serious injury.</p>
 <b>WARNING</b>	<p>This symbol identifies a potentially hazardous situation, which, if not avoided, could result in death or serious injury.</p>
 <b>CAUTION</b>	<p>This symbol identifies a potentially hazardous situation, which, if not avoided, could result in minor or moderate injury, or property damage.</p>
 <b>WARNING</b>	<p>A waterjet is a cutting tool. A high-pressure injection injury is a surgical emergency. Seek immediate medical treatment for all high-pressure waterjet injuries. Delayed treatment can lead to serious injuries or death.</p>
	<p>High-pressure water can cause eye injuries. Wear approved eye protection when operating or working near this equipment.</p>
	<p>Prolonged exposure to noise can cause permanent hearing loss. Wear approved ear protection and control exposure time when operating or working near this equipment.</p>
	<p>High-pressure water can cause severe cuts or lacerations, abrasions, and punctures. Wear approved hand protection when operating or working near this equipment. Precision parts have sharp corners or edges. Wear protective gloves when handling parts.</p>
	<p>Some materials can produce airborne contaminants or suspended particles when cut. Wear approved respiratory protection.</p>
	<p>Refer to the instruction manual. Read and understand all of the safety guidelines in this manual.</p>
	<p>This symbol identifies a mandatory action.</p>
	<p>This symbol identifies a prohibited action.</p>
	<p>This symbol identifies tools or materials that are required or recommended for a procedure.</p>
	<p>This symbol identifies a note or helpful information.</p>

## Symbols and marks

---

## Section 1

### Terminology

---

Some terms could be relevant to other products.

**abrasive**

Fine mesh particles, typically garnet, used in the waterjet cutting process

**abrasive delivery pot**

Where abrasive is held before it goes to the abrasive regulator

**bar**

A unit of pressure; 1 bar equals 100 kPa or 14.5 psi or 100,000 N·m<sup>2</sup>

**control knob**

A device used to adjust the abrasive flow rate to the cutting head

**fitting**

A coupling, valve, or gauge that stops, regulates, or directs the flow of water in a hose or a tube

**flow rate**

Measured in grams per minute 1 g/min = 0.0022 lb/min, or pounds per minute 1 lb/min = 453.6 g/min

**high-pressure water**

Water that has been pressurized by the intensifier for cutting or piercing

**hose**

A flexible hollow cylinder; dimensions are based on its inside diameter (ID)

**inside diameter**

The diameter measurement of the inside of a cylinder

**ISO**

The International Organization for Standardization is an independent membership organization that develops voluntary standards

## Terminology

---

**kPa**

A kilopascal is a unit of pressure; 1 kPa equals 0.01 bar or 0.15 psi or 1,000 N·m<sup>2</sup>

**low-pressure water**

Water that is not pressurized by the intensifier

**NPT**

National pipe thread taper, a common United States standard for tapered threads that are used on fittings and pipes

**OEM**

An original equipment manufacturer of machines that include Hypertherm products that are sold directly to end users

**outside diameter**

The diameter measurement of the outside of a cylinder

**psi**

Pound-force per square inch is a unit of pressure; 1 psi equals 0.07 bar or 7 kPa or 6,894 N·m<sup>2</sup>

**regulator**

The abrasive regulator

**SAE**

SAE International is a professional association of engineers and technical experts that coordinates the development of technical standards based on best practices in the aerospace, commercial vehicle, and automotive engineering; SAE Code 61 fittings are designed for 207 bar or 20,684 kPa (3000 psi) applications; SAE Code 62 fittings are designed for 414 bar or 41,369 kPa (6,000 psi) applications

**tube**

A flexible hollow cylinder; dimensions are based on its outside diameter (OD); the inside diameter depends on the thickness of the tube

**valve**

A device used to control the rate of flow in a hose or a tube



## Section 2

### Product description

HyPrecision cutting systems use an abrasive during the cutting process to maximize cutting performance and ensure quality results. The abrasive regulator is designed to be positioned above the cutting head and to receive abrasive from a separate abrasive pot.

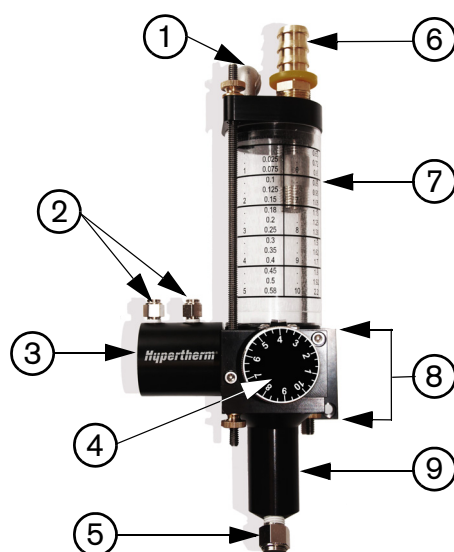

- |                         |                  |
|-------------------------|------------------|
| 1 Vent fitting          | 6 Feed hose barb |
| 2 Air cylinder fittings | 7 Acrylic tube   |
| 3 Air cylinder          | 8 Regulator body |
| 4 Control knob          | 9 Regulator base |
| 5 Delivery tube fitting |                  |

The abrasive moves from the pot through a feed hose to the regulator. Abrasive collects in the acrylic tube and then it moves through the metering aperture, which permits abrasive to go to the cutting head.



The control knob changes the flow rate of abrasive to the cutting head. The control knob is marked from 1 to 10.

 The flow rate is adjustable during cutting.

## Product description

---

## Safety

	Refer to the instruction manual. Read and understand all of the safety guidelines in this manual.
	Examine and clean the regulator regularly. Make repairs immediately.
	Keep the work area clean and free of fluid spills.

## Inspect the regulator before operation

- Look for air leaks, deterioration, damage, or other conditions that can interfere with operation.
- Make sure that all connections and fasteners are tight, including locking devices, hoses, hose clamps, and fittings.
- Make sure that all operational and instructional marks are present and legible.

## Operate the regulator

The regulator is air operated. Air is typically supplied by a 4-way 2-position solenoid valve. Refer to the diagram on page 40.

### Open the regulator

When air enters the cylinder's outer connection the gate opens to permit abrasive to flow to the cutting head. The air leaves the regulator through the inner connection to a vent.

### Close the regulator

When air enters the cylinder's inner connection the gate closes and the abrasive stops flowing. The air leaves the regulator through the outer connection to a vent.

## Operation

### Adjust the flow rate

Adjust the control knob to set the flow rate in pounds.

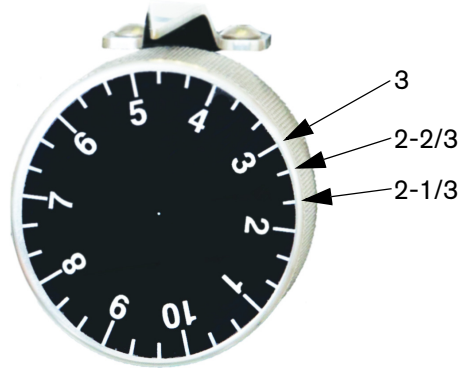

Control knob setting	Pounds per minute (lb/min)	Grams per minute (g/min)	Control knob setting	Pounds per minute (lb/min)	Grams per minute (g/min)
1/3	0	0	5-1/3	0.65	295
2/3	0.025	11	5-2/3	0.72	327
1	0.075	34	6	0.8	363
1-1/3	0.1	45	6-1/3	0.88	399
1-2/3	0.125	57	6-2/3	0.95	431
2	0.15	68	7	1.05	476
2-1/3	0.18	82	7-1/3	1.15	522
2-2/3	0.2	91	7-2/3	1.25	567
3	0.25	113	8	1.38	626
3-1/3	0.3	136	8-1/3	1.5	680
3-2/3	0.35	159	8-2/3	1.62	735
4	0.4	181	9	1.7	771
4-1/3	0.45	204	9-1/3	1.8	816
4-2/3	0.5	227	9-2/3	1.92	871
5	0.58	263	10	2.2	998



This chart is based on 80-mesh alluvial abrasive. Flow rates can vary due to grit size.

### Suggested setpoints

Orifice/nozzle	.010/.030	.011/.030	.012/.030	.014/.040	.016/.040
Control knob setting	5-1/3	5-2/3	6	7-1/3	7-2/3

## Adjust the regulator for a new abrasive

The regulator is set at the factory for 80-mesh alluvial. Follow this procedure for other abrasives.

 Recalibrate the control knob when using other abrasives and after doing maintenance activities. Refer to page 30 for instructions.



### Required tools, materials, and parts

Container for measuring abrasive

Scale

Stopwatch

1. Weigh the empty container.
2. Choose a knob setting based on the control knob setting chart on page 20.
3. Disconnect the delivery tube from the regulator base.
4. Open the regulator.
5. Point the stream of abrasive into a container for 1 minute.
6. Weigh the filled container.
7. Subtract the weight of the empty container from the weight of the filled container.
8. Use this chart to convert grams or ounces to pounds.

Ounces	Grams	Pounds	Ounces	Grams	Pounds	Ounces	Grams	Pounds
1.6	45	0.1	14.4	408	0.9	27.2	771	1.7
3.2	91	0.2	16.0	453	1	28.8	816	1.8
4.8	136	0.3	17.6	499	1.1	30.4	861	1.9
6.4	181	0.4	19.2	544	1.2	32.0	907	2
8.0	227	0.5	20.8	589	1.3	33.6	952	2.1
9.6	272	0.62	22.4	635	1.4	35.2	997	2.2
11.2	318	0.7	24.0	680	1.5	36.8	1043	2.3
12.8	362	0.8	25.6	725	1.6	38.4	1089	2.4

9. Turn the control knob clockwise to increase the flow rate. Turn the control knob anticlockwise to decrease the flow rate.
10. Repeat this procedure until the flow rate is acceptable.

## Operation

---

Use this table to record calibration details for other abrasives.

Abrasive material	Pounds per minute (lb/min)	Grams per minute (g/min)	Control knob setting

## Section 4

### Preventive maintenance

---





Hypertherm products are designed and manufactured with a commitment to continuous quality control and safety. Contact a Hypertherm Technical Service Associate or an OEM for information about the installation, operation, maintenance, and repair of this equipment.

Hypertherm Inc. recommends preventive and scheduled maintenance for all equipment. High-quality equipment that is serviced on a schedule lasts longer than equipment that is not regularly maintained. This maintenance includes, but is not limited to, adjustments, cleaning, lubrication, repairs, and replacement of parts.

#### Benefits of preventive maintenance

- Improves reliability
- Finds potential problems before they cause unplanned downtime and expensive repairs
- Extends the life of equipment and decreases the frequency of replacement
- Contributes positively to reputation and profits
- Creates traceability through records

### Safety

	Refer to the instruction manual. Read and understand all of the safety guidelines in this manual.
	Follow all safety requirements and applicable safety laws and regulations.
	Coordinate preventive maintenance and repair activities with operations and safety staff.
	Examine and clean the equipment regularly. Make repairs promptly.
	Repair or replace parts identified in the preventive maintenance schedule or if the parts show signs of deterioration, corrosion, or damage.

### Tips

- Keep the work area clean and free of fluid spills. Use catch basins under areas where water or abrasive can spill during maintenance or repair procedures.
- Keep accurate maintenance records.
- Keep parts available so that they are ready when required.
- Follow local protocols for recycling or disposal of parts and materials. Refer to Recycling and end of product life on page 42.



## Replace worn plates

The plates can wear and require replacement.



### Required tools, materials, and parts

11411 Exit plate

11318 Sandwich plate

5/64-inch hex wrench

7/64-inch hex wrench

1/8-inch hex wrench

5/32-inch hex wrench

3/16-inch hex wrench

Air supply

### Recommended materials

Alignment tool such as a dowel

## Disassemble the regulator

1. Remove the thumb nuts from the bottoms of the threaded rods.
2. Remove the regulator base.

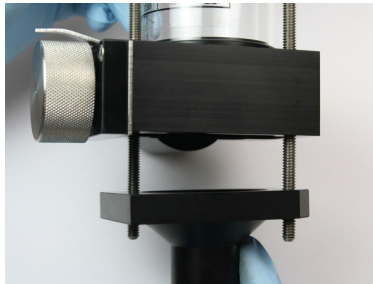

3. Remove the 2 socket-head cap screws from the control knob mounting plate.

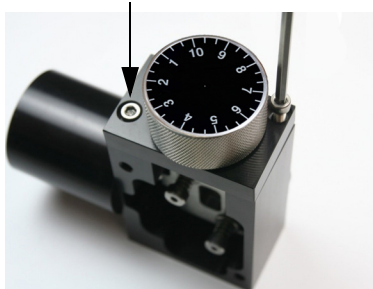

## Preventive maintenance

---

4. Turn the knob anticlockwise until it separates from the regulator body.



5. Remove the divider.

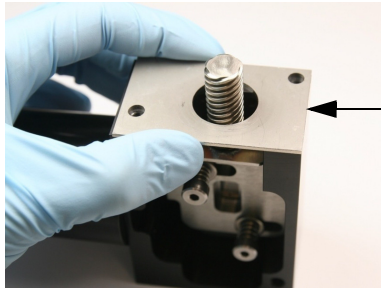

6. Remove the shoulder bolts from the housing base.

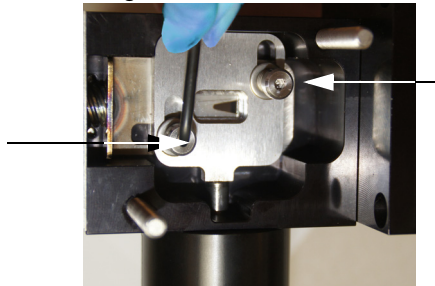

7. Remove the 4 socket-head cap screws from the air cylinder.

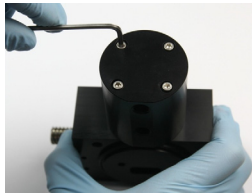

8. Remove the aperture plate, the sandwich plate, and the exit plate. The gate stays in place.

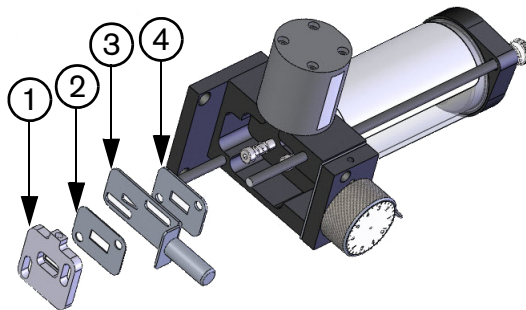

- 1 Gate  
2 Sandwich plate

- 3 Aperture plate  
4 Exit plate

## Assemble the regulator



Before reassembling the regulator, clean the parts with compressed air to remove dirt and other contaminants.

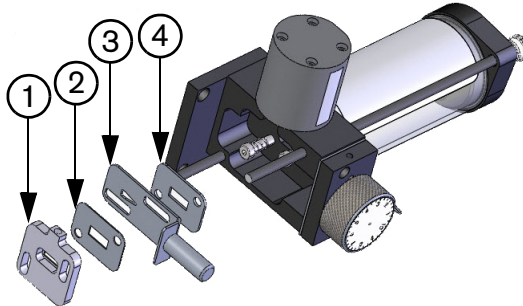

- |   |   |
|---|---|
| <p><b>1</b> Gate</p> <p><b>2</b> Sandwich plate</p> | <p><b>3</b> Aperture plate</p> <p><b>4</b> Exit plate</p> |
|---|---|

The exit plate is thicker than the sandwich plate.

- Put the exit plate on the housing base under the gate.

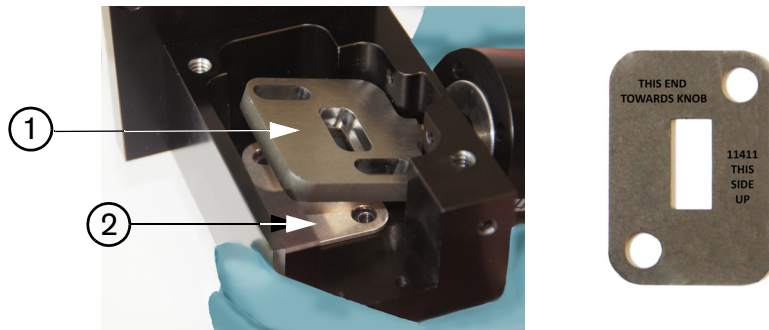

- |                      |                            |
|----------------------|----------------------------|
| <p><b>1</b> Gate</p> | <p><b>2</b> Exit plate</p> |
|----------------------|----------------------------|

Put the face with THIS SIDE UP toward the housing base. Put the end with THIS END TOWARDS KNOB toward the knob on the housing base.

- Put the aperture plate between the exit plate and the gate.

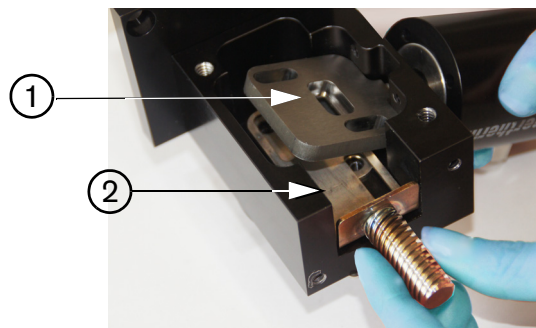

- |                      |                                |
|----------------------|--------------------------------|
| <p><b>1</b> Gate</p> | <p><b>2</b> Aperture plate</p> |
|----------------------|--------------------------------|

## Preventive maintenance

---

- Put the sandwich plate between the aperture plate and the gate.

 Put the face with THIS SIDE UP LOWER PLATE toward the housing base. Put the end reading THIS END TOWARDS KNOB toward the knob on the housing base.



- Align the holes in the aperture assembly with an alignment tool such as a dowel.

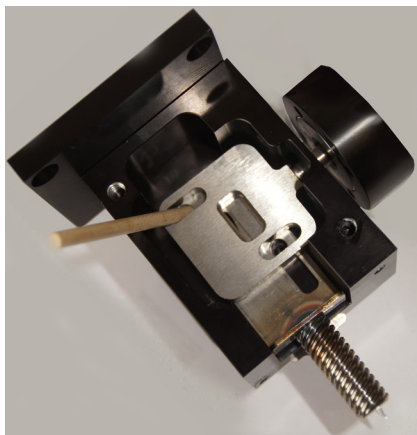

- Install the washers, springs, and shoulder bolts in the aperture assembly holes. Tighten the bolts.



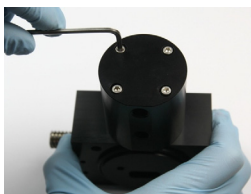

 Put the washer in with the flat side down.

- Install the socket-head cap screws in the air cylinder body. Tighten the screws.

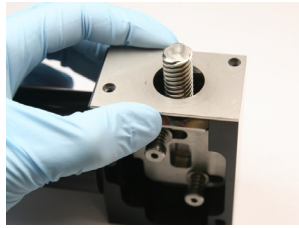

- Put the divider on the side of the housing base.



 Make sure that the beveled side of the divider faces out.

- Blow compressed air into 1 air cylinder fitting to make sure that the gate slides back and forth. Repeat this procedure on the other air cylinder fitting.

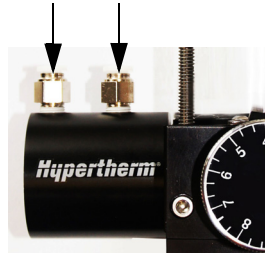

- Put the control knob mounting plate onto the divider so that the holes line up. Turn the control knob clockwise until it is tight on the regulator base.

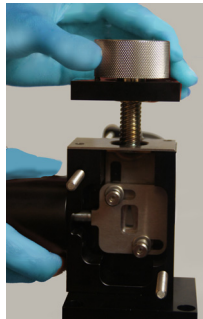

- Install the socket-head cap screws. Tighten the screws.



- Put the regulator base on the threaded rods.

- Reassemble the thumb nuts on the threaded rods. Hand tighten the thumb nuts with the knurled side toward the end of the threaded rod.

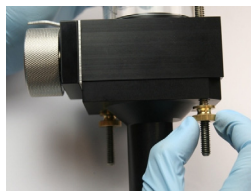

### Recalibrate the control knob

Recalibrate the control knob when using other abrasives and after doing maintenance activities.



#### Required tools, materials, and parts

11485 Dial label

0.038-inch diameter gauge pin

1. Turn the control knob clockwise until it stops. This puts the aperture in its fully open position.
2. Hold the gauge pin in the wider end of the metering aperture and turn the control knob anticlockwise until the metering aperture is open just enough to pull the gauge pin out.



Make sure that the control knob does not move when pulling the gauge pin out.

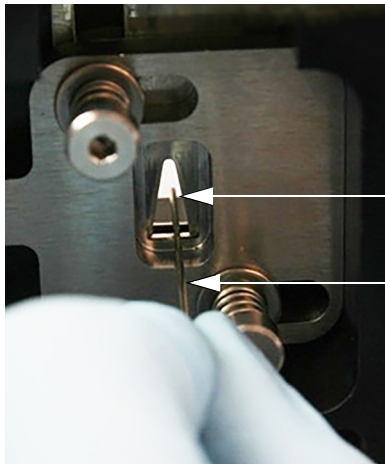

1 Metering aperture

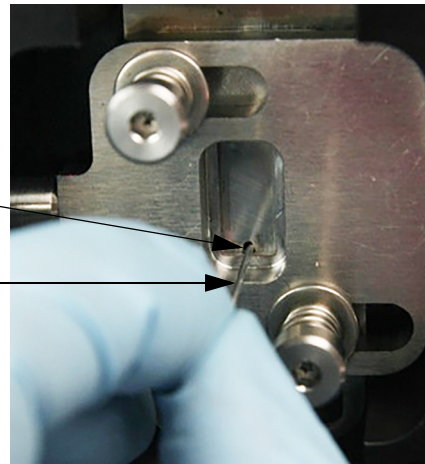

2 Gauge pin

3. Remove the dial label from the control knob.
4. Put a new dial label on the control knob so that the pointer lines up with the 1.



## Section 5

### Parts lists

---

Genuine Hypertherm parts are the factory-recommended replacement parts for this pump. The Hypertherm warranty might not cover damage caused by using nongenuine Hypertherm parts.

To order parts, contact the original equipment manufacturer (OEM) or Hypertherm Inc. with the part numbers and quantities.

Hypertherm Waterjet  
305 2nd Street NW, Suite 115  
New Brighton, MN 55112 USA  
+1 866-566-7099  
+1 651-294-8620 fax

## Parts lists

---

### Replacement parts

Part number	Description
11411	Exit plate
12318	Sandwich plate
11414	Aperture assembly
12251	Acrylic tube
11751	Thumb nut
12255	Shoulder bolt
12256	Spring
12257	Washer
12075	1/4-inch × 3/8-inch delivery tube fitting
13128	1/2-inch NPT × 3/4-inch hose barb fitting
12736	1/8-inch NPT × 1/4-inch air tube fitting
13615	3/8-inch OD × 1/4-inch ID polyurethane delivery tube (9.53 mm OD × 6.35 mm ID tube)
11485	Dial label

### Other parts

13727	Coned rubber splash guard
-------	---------------------------



---

## Complete list of preventive maintenance parts, tools, and materials

### Parts

12318 Sandwich plate

11411 Exit plate

11485 Dial label

### Tools

**All wrenches and sockets are SAE**

5/64-inch hex wrench

7/64-inch hex wrench

1/8-inch hex wrench

5/32-inch hex wrench

3/16-inch hex wrench (or 5 mm wrench)

Compressed air source

0.038-inch diameter gauge pin

Alignment tool such as a dowel (recommended)

### Materials

Scale

Stopwatch

Container for measuring abrasive



## Safety



Refer to the instruction manual. Read and understand all of the safety guidelines in this manual.

## The abrasive does not flow

If the abrasive does not flow, check for moisture in the abrasive or too much air in the feed hose.

### Moisture in the abrasive

 Prevent humidity in the abrasive with an air dryer on the supply air.

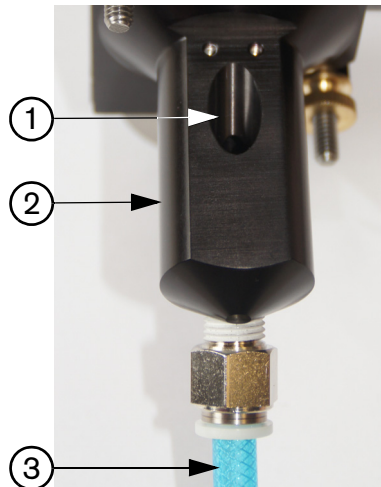

- 1 Vent hole
- 2 Regulator base

3 Delivery tube

## Troubleshooting

---

When the cutting head nozzle is clogged, water moves up the delivery tube, blocks the regulator, and discharges from the vent hole.



Before unclogging the regulator, make sure that the nozzle is not blocked. Refer to the cutting head manufacturer's instructions.



Use a coned rubber splash guard during piercing to minimize moisture in the regulator. Refer to the Parts lists section, which begins on page 31.

1. Follow the abrasive pot manufacturer's instructions to stop abrasive delivery to the regulator.
2. Disconnect the delivery tube from the cutting head.
3. Loosen the 2 thumb nuts on the regulator base.
4. Lower and turn the base.



5. Dry the delivery tube and the regulator base with compressed air.
6. Dry the aperture assembly with compressed air.
7. Wipe out the acrylic tube with a lint-free towel or blow it dry with compressed air.



Do not use soap, detergent, or solvents.



8. Reassemble the regulator.
9. Reconnect the delivery tube to the cutting head.

## Section 7

### Installation

---

#### Safety

	Refer to the instruction manual. Read and understand all of the safety guidelines in this manual.
	Keep the work area clean and free of fluid spills.

Hypertherm products are designed and manufactured with a commitment to continuous quality control and safety. Contact a Hypertherm Technical Service Associate for information and support regarding the installation, operation, maintenance, and repair of this equipment.

#### Buyer obligations

The buyer is responsible for these obligations:

- Cooperate with Hypertherm and the Hypertherm original equipment manufacturer (OEM) regarding the installation of the equipment.
- Research and comply with all local codes.
- Make all connections to the equipment.

## Installation

---

### Requirements

#### Location

Mount the abrasive regulator above the cutting head a maximum of 1.83 m (6 feet) from the floor. This will keep the regulator out of the spray-back area from the cutting head and within reach for adjusting the flow rate.

#### Air

The recommended air pressure is 4 bar to 5.5 bar or 441 kPa to 552 kPa (60 psi to 80 psi).

### Attach the abrasive regulator to the cutting table

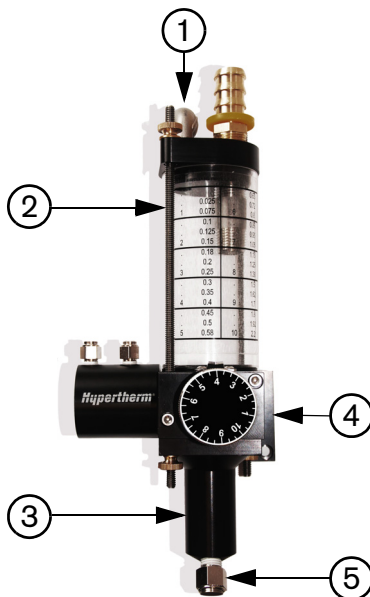

- |                  |                         |
|------------------|-------------------------|
| 1 Vent fitting   | 4 Mounting plate        |
| 2 Threaded rod   | 5 Delivery tube fitting |
| 3 Regulator base |                         |



#### Required tools, materials, and parts

Drill

#7 drill bit (5 mm drill bit)

1/4-20 tap (M6 × 1 tap)

3/16-inch hex wrench (5 mm wrench)

Two 1/4-20 socket head cap screws (M6 socket head cap screws)

13615 3/8-inch OD × 1/4-inch ID polyurethane delivery tube (9.53 mm OD × 6.35 mm ID tube)

1. Remove the mounting plate from the regulator.
2. Use the mounting plate as a template to position and drill 2 holes on the mounting surface.
3. Tap the holes in the mounting surface.
4. Replace the mounting plate on the regulator.
5. Remove the thumb nuts on the bottom of the threaded rods to remove the regulator base from the regulator.

 Turn the threaded rods upward to get them out of the way for the mounting cap screw.

6. Mount the regulator to the mounting surface above the cutting head using 2 socket head cap screws.
7. If the thumb nuts and threaded rods were moved, adjust the threaded rod so that about 2.5 cm (1 inch) of rod shows on each end. Hand tighten the thumb nuts with the knurled part toward the end of the threaded rod.

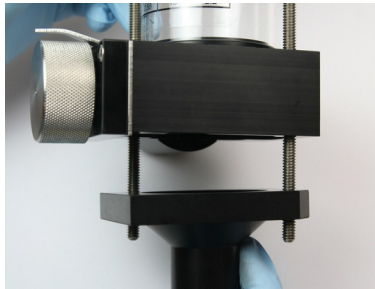

8. Connect the polyurethane delivery tube to the delivery tube fitting.

## Connect the abrasive regulator to the solenoid valve



### Required tools, materials, and parts

Two 1/4-inch OD nylon or polyethylene air tubes

Compressed air source

2-position 4-way solenoid valve (other solenoid valves can be used)

1. Do a functional test of the abrasive regulator.
2. Make the connections to the solenoid valve.

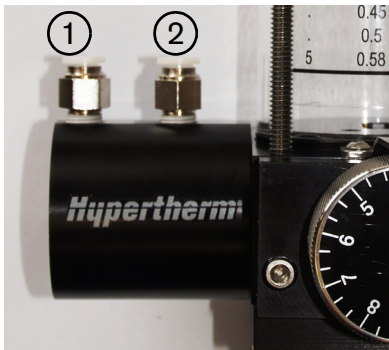

- 1 Open
- 2 Close

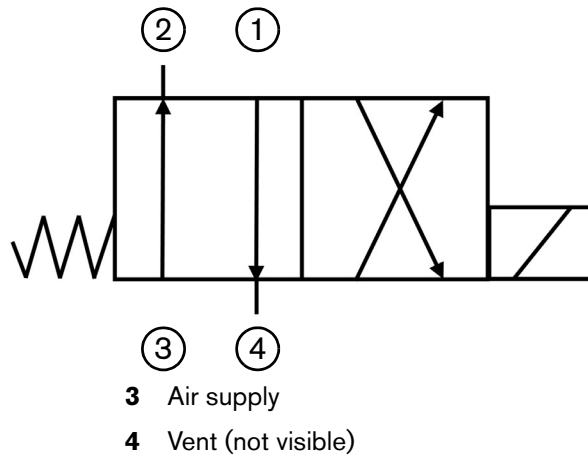

- 3 Air supply
- 4 Vent (not visible)



The diagram shows a 2-position 4-way solenoid valve in the typical position. Refer to the solenoid valve manufacturer's instructions to connect the solenoid valve to the abrasive regulator.

3. Make sure that the abrasive regulator operates properly.



## Connect the abrasive regulator to the abrasive pot

	Make sure that the feed hoses have minimal elevation changes. Do not install the feed hose higher than 3.05 m (10 feet) above the floor.
---	--



### Required tools, materials, and parts

3/4-inch (1.9 cm) feed hose

Hose clamp

1. Attach the feed hose to the hose barb fitting on the top of the abrasive regulator. Use a hose clamp to secure the hose to the fitting.



Make sure that the feed hose is between 15.24 cm (6 inches) and 0.61 m (2 feet) above the abrasive regulator to supply a balanced flow rate.

2. Refer to the abrasive pot manufacturer's instructions to attach the other end of the feed hose to the pot.

## Install more than one abrasive regulator

	Use 1 abrasive regulator for each cutting head.
--	---

	When feeding multiple abrasive regulators from 1 pot, make sure that the path to each regulator is the same length so each regulator receives the same amount and flow rate of abrasive.
---	--

1. Install a feed hose from the pot to a location near the abrasive regulators. Use elbow fittings where the feed hose from the pot attaches to the feed hoses to the abrasive regulators.
2. Split the abrasive flow evenly between the feed hoses.

## Do the first startup

1. Make sure that the abrasive regulator is installed correctly and that all of the feed hose connections are tight.
2. Set up and fill the abrasive pot according to the manufacturer's instructions.
3. Make sure that the abrasive regulator is closed.
4. Permit the regulator to fill with abrasive.



It can take as much as 15 minutes to remove the air from the hose and to fill the regulator. Abrasive can feed from the pot unevenly until the air in the feed hose is replaced with abrasive.



For longer delivery lengths, increase the pot pressure. Refer to the abrasive pot manufacturer's instructions to adjust the pot pressure.

5. Disconnect the delivery tube from the regulator base.
6. Open and close the abrasive regulator to make sure that abrasive comes out.

### Recycling and end of product life

At the end of the life of the product or its parts, recycle or dispose of relevant materials and parts using an environmentally satisfactory method and in accordance with local regulations. If the product contains substances that are harmful to the environment, remove and dispose of them in accordance with current local regulations.

HyPrecision and Hypertherm are trademarks of Hypertherm Inc. and may be registered in the United States and other countries. All other trademarks are the property of their respective holders.

© 2015 Hypertherm Inc.