



High Pressure Valves, Fittings and Tubing Pressures to 65,000 psi

MAXIMATOR has been designing and manufacturing high pressure equipment for more than thirty years and has a worldwide reputation for quality and reliability, backed by one of the best service organizations in the industry.

High Pressure Valves feature:

- ▶ Rising stem design.
- ▶ 316SS wetted parts with a 17-4 PH stem provides excellent corrosion resistance.
- ▶ Metal-to-metal seating achieves bubble-tight shut-off, longer stem and seat life, greater durability for repeated open and close cycles.
- ▶ PTFE and carbon packing with metal back-up rings offers reliable stem to body sealing.
- ▶ Non-rotating stem prevents stem to seat galling.
- ▶ Stem sleeve and packing gland materials have been selected to achieve optimum thread cycle life and reduced handle torque. All stem sleeve threads are rolled, assuring smooth operation.
- ▶ Safety weep holes for all pressure connections and packing area.
- ▶ Six different valve body patterns, with choice of vee or regulating type stem tip.

MAXPRO offers a complete line of high pressure fittings, tubing, check valves, line filters, anti-vibration fittings and safety head assemblies. All high pressure valves and fittings use the high pressure style connection.

Note: When selecting multiple items, the pressure rating would be that of the lowest rated component.

High Pressure Index

Valves rated to 36,000 psi	2-3
Valves rated to 43,000 psi	4-5
Valves rated to 65,000 psi	6-7
Fittings	8
Anti-Vibration Collet Gland Assemblies	9
Tubing	10
Coned and Threaded Nipples	11
Check Valves	12
Line Filters	13
Angle Filters	14
Safety Head Assemblies and Rupture Discs	15

Maxpro Technologies, Inc.

7728 Klier Drive South · Fairview Pennsylvania 16415
Phone: 814-474-9191 · Fax: 814-474-9391
website: www.maxprotech.com

All general terms and conditions of sale, including limitations of our liability, apply to all products and services sold.
MT R5 0316



Printed in the USA

High Pressure Valves

Pressures to 36,000 psi



Ordering Information

Typical catalog number: **36V4H071**

36V	4H	07	1	OPTIONS
Valve Series	O.D. Tube Size	Stem Type	Body Pattern	Extreme temperature option, see below.
36V	4H - 1/4" 6H - 3/8" 9H - 9/16"	07 - VEE stem 08 - regulating stem (tapered tip for regulating and shutoff) 87 - VEE stem with replaceable seat 88 - regulating stem with replaceable seat	1 - two-way straight 2 - two-way angle 3 - three-way, two on pressure 4 - three-way, one on pressure 5 - three-way, two-stem manifold	

Special Designs for Extreme Temperatures

Standard valves are supplied with Teflon/Carbon packing and may be operated to 450°F. High temperature packing and/or extended stuffing box are available for service from -423°F to 1200°F by adding the following suffixes to catalog order number.

- **TG** standard valve with teflon glass packing to 600°F.
- **GY** standard valve with graphite braided yarn packing to 800°F.
- **HT** extended stuffing box valve with graphite braided yarn packing to 1200°F.
- **B** standard valve with cryogenic trim materials and teflon packing to -100°F.
- **LT** extended stuffing box valve with teflon packing and cryogenic trim materials to -423°F.

Repair Kits

Consult your **MAXPRO** representative for repair kits and valve bodies. Refer to the Tools and Installation section for proper maintenance procedures.

MAXIMATOR high pressure valves with metal to metal seats have a high level of safety and reliability under adverse operating conditions. These valves may be used both with gases and liquids.

Traceability is ensured through extensively documented data (batch number, max. pressure, material number, type designation). All high pressure valves include glands and collars.

O.D. Size (in.)	Connection Type	Orifice Size (in.)	Rated Cv*	Pressure/Temp. Rating (psi @ R.T.)**
1/4	4HF	0.094	0.12	36,000
3/8	6HF	0.125	0.23	36,000
9/16	9HF	0.125	0.33	36,000

* Cv values shown are for 2-way straight pattern vee stem valves.

For 2-way angle patterns, increase the Cv value by 50%.

** See page 2 in the Technical Section for Pressure/Temperature Rating Chart.

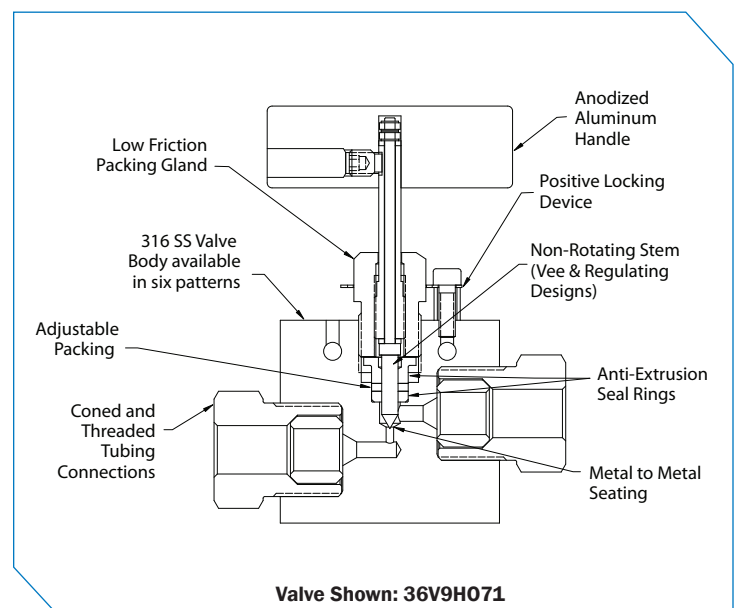
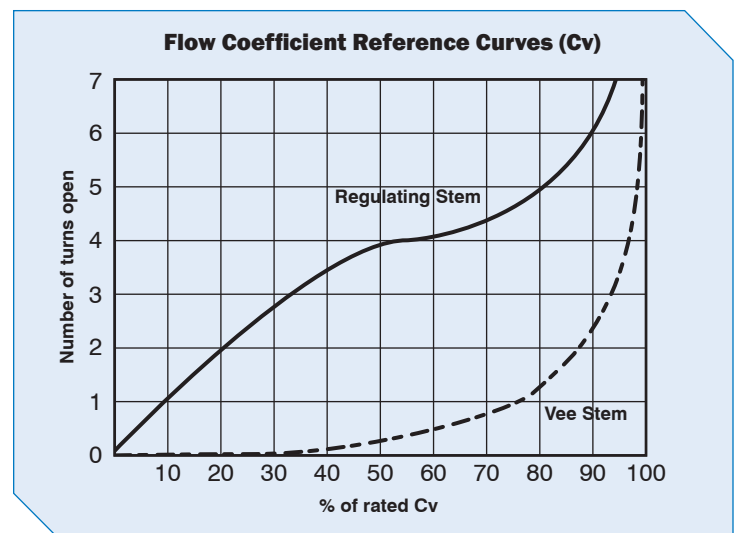

Valve Shown: **36V9H071**

All general terms and conditions of sale, including limitations of our liability, apply to all products and services sold.
MT R5 0316

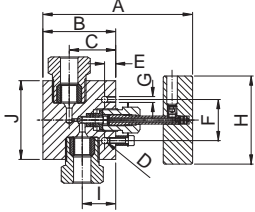
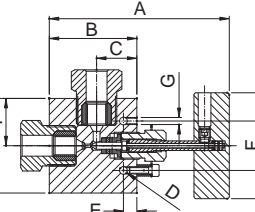
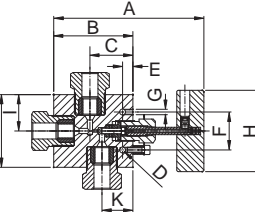
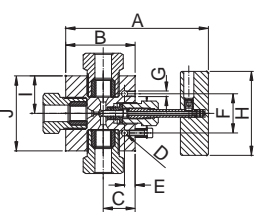
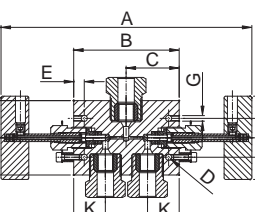
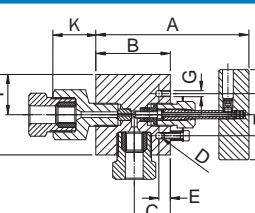
Valve Pattern	Catalog Number	Stem Type	O.D. Tube (in.)	Orifice (in.)	Dimensions (in.)										Valve Panel Hole	Block Thickness
					A	B	C	D	E	F	H	I	J	K		
2-Way Straight																
	36V4H071	Vee	1/4	0.094	4.96	2.01	1.50	0.22	0.37	1.38	2.95	1.12	2.01		1.00	1.02
	36V4H081	Reg														
	36V6H071	Vee	3/8	0.125	4.96	2.01	1.50	0.22	0.37	1.38	2.95	1.12	2.01		1.00	1.02
	36V6H081	Reg														
	36V9H071	Vee	9/16	0.125	5.00	2.44	1.56	0.22	0.37	1.38	2.95	1.12	2.64		1.00	1.54
	36V9H081	Reg														
2-Way Angle																
	36V4H072	Vee	1/4	0.094	4.96	2.01	1.12	0.22	0.37	1.38	2.95	1.00	2.01		1.00	1.02
	36V4H082	Reg														
	36V6H072	Vee	3/8	0.125	4.78	2.20	1.10	0.22	0.37	1.38	2.95	1.00	2.01		1.00	1.02
	36V6H082	Reg														
	36V9H072	Vee	9/16	0.125	5.00	2.44	1.12	0.22	0.37	1.38	2.95	1.32	2.64		1.00	1.54
	36V9H082	Reg														
3-Way / 2 on Pressure																
	36V4H073	Vee	1/4	0.094	4.69	2.13	1.50	0.22	0.37	1.38	2.95	1.00	2.01	1.12	1.00	1.02
	36V4H083	Reg														
	36V6H073	Vee	3/8	0.125	5.08	2.50	1.50	0.22	0.37	1.38	2.95	1.00	2.01	1.12	1.00	1.02
	36V6H083	Reg														
	36V9H073	Vee	9/16	0.125	5.45	2.87	1.56	0.22	0.37	1.38	2.95	1.32	2.64	1.12	1.00	1.54
	36V9H083	Reg														
3-Way / 1 on Pressure																
	36V4H074	Vee	1/4	0.094	4.96	2.01	1.12	0.22	0.37	1.38	2.95	1.00	2.01		1.00	1.02
	36V4H084	Reg														
	36V6H074	Vee	3/8	0.125	4.76	2.20	1.12	0.22	0.37	1.38	2.95	1.00	2.01		1.00	1.02
	36V6H084	Reg														
	36V9H074	Vee	9/16	0.125	5.00	2.44	1.12	0.22	0.37	1.38	2.95	1.32	2.64		1.00	1.54
	36V9H084	Reg														
3-Way / 2-Stem Manifold																
	36V4H075	Vee	1/4	0.094	8.23	3.07	1.54	0.22	0.37	1.38	2.95	1.00	2.01	1.12	1.00	1.02
	36V4H085	Reg														
	36V6H075	Vee	3/8	0.125	8.39	3.25	1.61	0.22	0.37	1.38	2.95	1.00	2.01	1.12	1.00	1.02
	36V6H085	Reg														
	36V9H075	Vee	9/16	0.125	8.90	3.74	1.88	0.22	0.37	1.38	2.95	1.32	2.64	1.12	1.00	1.54
	36V9H085	Reg														
2-Way Angle / Replaceable Seat																
	36V4H872	Vee	1/4	0.094	4.96	2.38	1.12	0.22	0.37	1.38	2.95	1.00	2.01	0.90	1.00	1.02
	36V4H882	Reg														
	36V6H872	Vee	3/8	0.125	4.96	2.38	1.12	0.22	0.37	1.38	2.95	1.00	2.01	1.15	1.00	1.02
	36V6H882	Reg														
	36V9H872	Vee	9/16	0.125	5.00	2.44	1.18	0.22	0.37	1.38	2.95	1.32	2.64	1.48	1.00	1.54
	36V9H882	Reg														

G - Panel mounting screw thread size 10-24 UNC.

All dimensions are for reference only and subject to change.

High Pressure Valves

Pressures to 43,000 psi



MAXIMATOR high pressure valves with metal to metal seats have a high level of safety and reliability under adverse operating conditions. These valves may be used both with gases and liquids.

Traceability is ensured through extensively documented data (batch number, max. pressure, material number, type designation). All high pressure valves include glands and collars.

O.D. Size (in.)	Connection Type	Orifice Size (in.)	Rated Cv*	Pressure/Temp. Rating (psi @ R.T.)**
1"	16MF	0.438	2.6	43,000

* Cv values shown are for 2-way straight pattern vee stem valves.
For 2-way angle patterns, increase the Cv value by 50%.

** See page 2 in the Technical Section for Pressure/Temperature Rating Chart.

Ordering Information

Typical catalog number: **43V16M071**

43V	16M	07	1
Valve Series	O.D. Tube Size	Stem Type	Body Pattern
43V	16M - 1"	07 - VEE stem 08 - regulating stem (tapered tip for regulating and shutoff) 87 - VEE stem with replaceable seat 88 - regulating stem with replaceable seat	1 - two-way straight 2 - two-way angle 3 - three-way, two on pressure 4 - three-way, one on pressure 5 - three-way, two-stem manifold

Repair Kits

Consult your **MAXPRO** representative for repair kits and valve bodies. Refer to the Tools and Installation section for proper maintenance procedures.

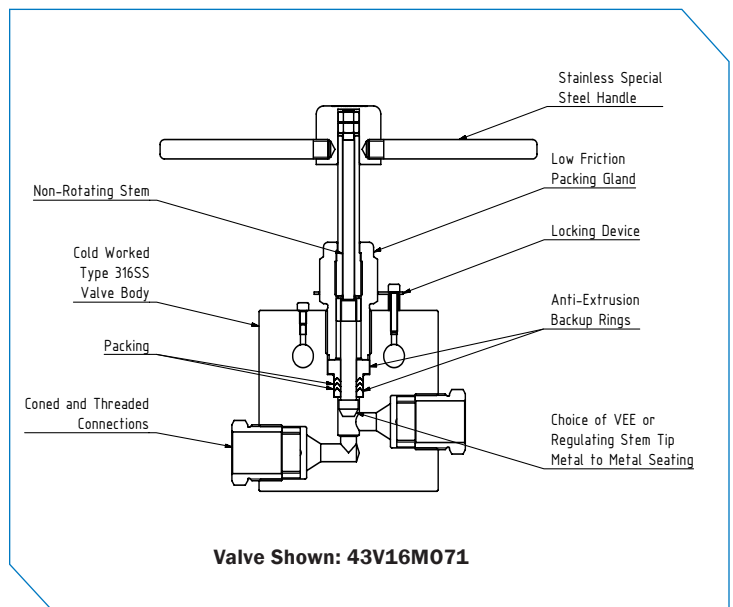
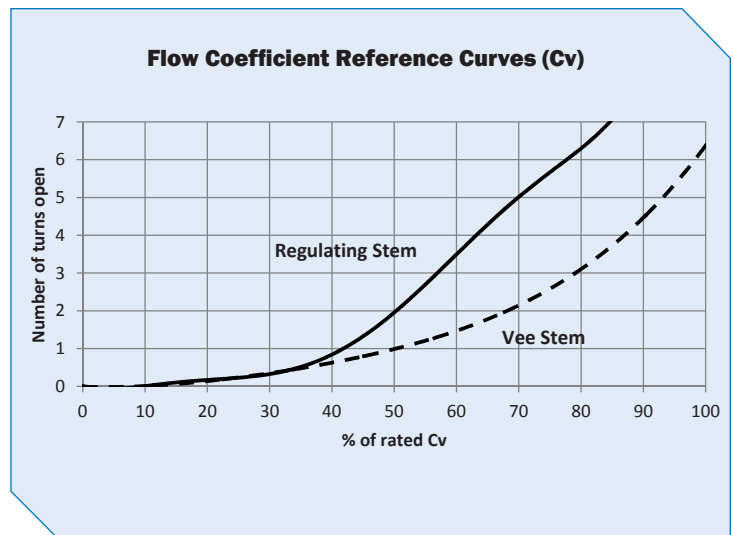

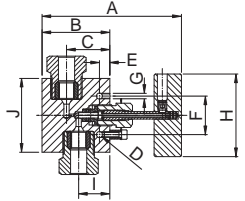
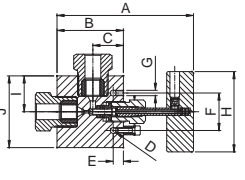
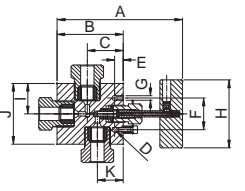
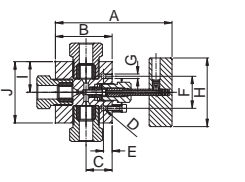
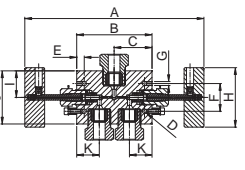
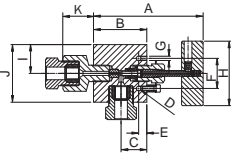
Valve Pattern	Catalog Number	Stem Type	O.D. Tube (in.)	Orifice (in.)	Dimensions (in.)										Valve Panel Hole	Block Thickness
					A	B	C	D	E	F	H	I	J	K		
2-Way Straight																
	43V16M071	Vee	1"	0.438	9.47	4.45	3.50	0.57	1.12	2.50	10.35	2.74	4.92	1.61	2.24	
	43V16M081	Reg														
2-Way Angle																
	43V16M072	Vee	1"	0.438	10.19	5.12	2.74	0.57	1.12	2.50	10.35	2.43	4.92	1.61	2.24	
	43V16M082	Reg														
3-Way / 2 on Pressure																
	43V16M073	Vee	1"	0.438	10.19	5.87	3.75	0.57	1.12	2.50	10.35	2.43	4.92	2.81	1.61	2.24
	43V16M083	Reg														
3-Way / 1 on Pressure																
	43V16M074	Vee	1"	0.438	9.52	5.20	2.81	0.57	1.12	2.50	10.35	2.43	4.92	1.61	2.24	
	43V16M084	Reg														
3-Way / 2-Stem Manifold																
	43V16M075	Vee	1"	0.438	16.18	7.52	3.76	0.57	1.12	2.50	10.35	2.43	4.92	2.81	1.61	2.24
	43V16M085	Reg														
2-Way Angle / Replaceable Seat																
	43V16M872	Vee	1"	0.438	9.61	5.25	2.81	0.57	1.12	2.50	10.35	2.43	4.92	1.61	2.24	
	43V16M882	Reg														

G - Panel mounting screw thread size 10-24 UNC.
All dimensions are for reference only and subject to change.

High Pressure Valves

Pressures to 65,000 psi



Ordering Information

Typical catalog number: **65V4H071**

65V	4H	07	1	OPTIONS
Valve Series	O.D. Tube Size	Stem Type	Body Pattern	Extreme temperature option, see below.
65V	4H - 1/4" 6H - 3/8" 9H - 9/16"	07 - VEE stem 08 - regulating stem (tapered tip for regulating and shutoff) 87 - VEE stem with replaceable seat 88 - regulating stem with replaceable seat	1 - two-way straight 2 - two-way angle 3 - three-way, two on pressure 4 - three-way, one on pressure 5 - three-way, two-stem manifold	

Special Designs for Extreme Temperatures

Standard valves are supplied with Teflon/Carbon packing and may be operated to 450°F. High temperature packing and/or extended stuffing box are available for service from -423°F to 1200°F by adding the following suffixes to catalog order number.

- **TG** standard valve with teflon glass packing to 600°F.
- **GY** standard valve with graphite braided yarn packing to 800°F.
- **HT** extended stuffing box valve with graphite braided yarn packing to 1200°F.
- **B** standard valve with cryogenic trim materials and teflon packing to -100°F.
- **LT** extended stuffing box valve with teflon packing and cryogenic trim materials to -423°F.

Repair Kits

Consult your **MAXPRO** representative for repair kits and valve bodies. Refer to the Tools and Installation section for proper maintenance procedures.

MAXIMATOR high pressure valves with metal to metal seats have a high level of safety and reliability under adverse operating conditions. These valves may be used both with gases and liquids.

Traceability is ensured through extensively documented data (batch number, maximum pressure, material number, type designation). All high pressure valves include glands and collars.

O.D. Size (in.)	Connection Type	Orifice Size (in.)	Rated Cv*	Pressure/Temp. Rating (psi @ R.T.)**
1/4	4HF	0.062	0.08	65,000
3/8	6HF	0.062	0.09	65,000
9/16	9HF	0.078	0.14	65,000

* Cv values shown are for 2-way straight pattern vee stem valves.
For 2-way angle patterns, increase the Cv value by 50%.

** See page 2 in the Technical Section for Pressure/Temperature Rating Chart.

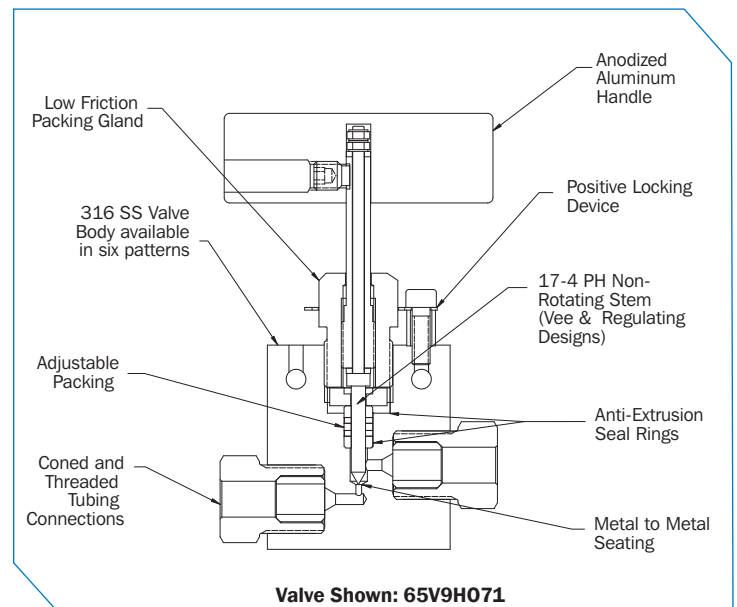
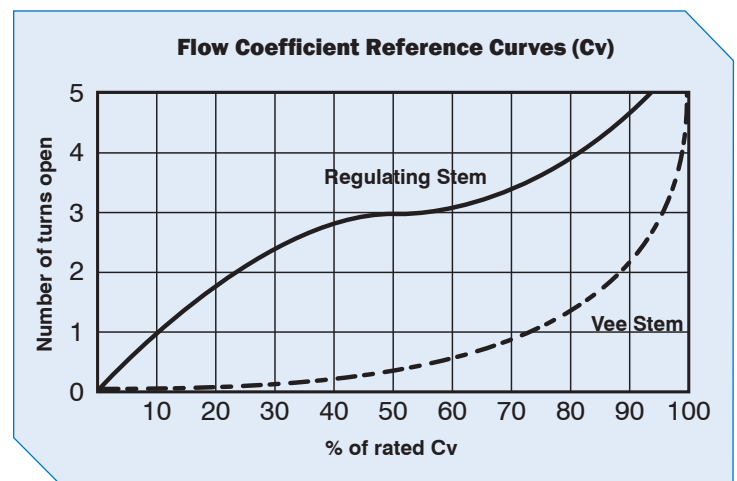

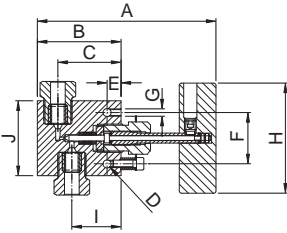
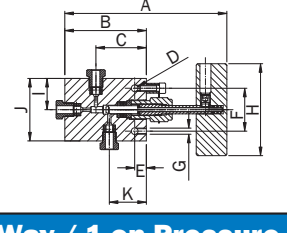
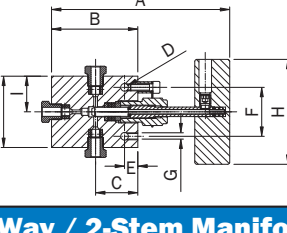
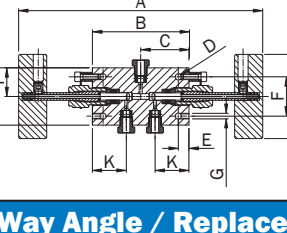
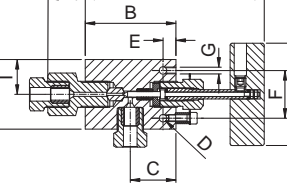
Valve Pattern	Catalog Number	Stem Type	O.D. Tube (in.)	Orifice (in.)	Dimensions (in.)										Valve Panel Hole	Block Thickness
					A	B	C	D	E	F	H	I	J	K		
2-Way Straight																
	65V4H071	Vee	1/4	0.062	4.67	2.13	1.69	0.22	0.37	1.38	2.95	1.32	2.01		1.00	1.02
	65V4H081	Reg														
	65V6H071	Vee	3/8	0.062	4.80	2.24	1.69	0.22	0.37	1.38	2.95	1.32	2.01		1.00	1.02
	65V6H081	Reg														
	65V9H071	Vee	9/16	0.078	5.04	2.50	1.75	0.22	0.37	1.38	2.95	1.30	2.64		1.00	1.54
	65V9H081	Reg														
2-Way Angle																
	65V4H072	Vee	1/4	0.062	4.96	2.38	1.34	0.22	0.37	1.38	2.95	1.00	2.01		1.00	1.02
	65V4H082	Reg														
	65V6H072	Vee	3/8	0.062	5.16	2.62	1.32	0.22	0.37	1.38	2.95	1.00	2.01		1.00	1.02
	65V6H082	Reg														
	65V9H072	Vee	9/16	0.078	5.35	2.80	1.32	0.22	0.37	1.38	2.95	1.32	2.64		1.00	1.54
	65V9H082	Reg														
3-Way / 2 on Pressure																
	65V4H073	Vee	1/4	0.062	4.96	2.38	1.69	0.22	0.37	1.38	2.95	1.00	2.01	1.32	1.00	1.02
	65V4H083	Reg														
	65V6H073	Vee	3/8	0.062	5.31	2.76	1.69	0.22	0.37	1.38	2.95	1.00	2.01	1.32	1.00	1.02
	65V6H083	Reg														
	65V9H073	Vee	9/16	0.078	5.71	3.15	1.75	0.22	0.37	1.38	2.95	1.32	2.64	1.30	1.00	1.54
	65V9H083	Reg														
3-Way / 1 on Pressure																
	65V4H074	Vee	1/4	0.062	4.96	2.38	1.32	0.22	0.37	1.38	2.95	1.00	2.01		1.00	1.02
	65V4H084	Reg														
	65V6H074	Vee	3/8	0.062	5.16	2.62	1.32	0.22	0.37	1.38	2.95	1.00	2.01		1.00	1.02
	65V6H084	Reg														
	65V9H074	Vee	9/16	0.078	5.35	2.80	1.32	0.22	0.37	1.38	2.95	1.32	2.64		1.00	1.54
	65V9H084	Reg														
3-Way / 2-Stem Manifold																
	65V4H075	Vee	1/4	0.062	8.56	3.44	1.72	0.22	0.37	1.38	2.95	1.00	2.01	1.32	1.00	1.02
	65V4H085	Reg														
	65V6H075	Vee	3/8	0.062	8.56	3.76	1.89	0.22	0.37	1.38	2.95	1.00	2.01	1.32	1.00	1.02
	65V6H085	Reg														
	65V9H075	Vee	9/16	0.078	9.25	4.13	2.07	0.22	0.37	1.38	2.95	1.32	2.64	1.30	1.00	1.54
	65V9H085	Reg														
2-Way Angle / Replaceable Seat																
	65V4H872	Vee	1/4	0.062	5.16	2.62	1.32	0.22	0.37	1.38	2.95	1.00	2.01	0.83	1.00	1.02
	65V4H882	Reg														
	65V6H872	Vee	3/8	0.062	5.16	2.62	1.32	0.22	0.37	1.38	2.95	1.00	2.01	1.07	1.00	1.02
	65V6H882	Reg														
	65V9H872	Vee	9/16	0.078	5.16	2.62	1.32	0.22	0.37	1.38	2.95	1.32	2.64	1.47	1.00	1.54
	65V9H882	Reg														

G - Panel Mounting Screw Thread Size 10-24 UNC.
All dimensions are for reference only and subject to change.

High Pressure Fittings

Pressures to 65,000 psi



MAXIMATOR high pressure fittings are designed to be used with the 36V, 43V and 65V series high pressure valves and high pressure tubing. All high pressure fittings have coned and threaded type connections. Mounting holes are standard on all elbows, tees, and crosses.

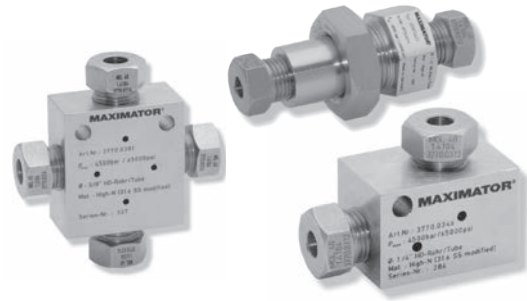

Tubing Size	Gland	Collar	Plug	Tubing Cap
1/4	65G4H	65C4H	65P4H	65TC4H
3/8	65G6H	65C6H	65P6H	65TC6H
9/16	65G9H	65C9H	65P9H	65TC9H
1	43G16M	43C16M	43P16M	43TC16M

Connection Components

All high pressure fittings are supplied with glands and collars. Refer to the adjacent chart for ordering any of the connection components individually. When using the plug, the collar is not needed.

Fitting Pattern	Catalog Number	Pressure Rating (PSI)	Connection Type	O.D. Tube Size (in.)	Orifice (in.)	Dimensions (in.)							Block Thickness
						A	B	C	D	E	F	G	
Elbow													
	65L4H	65,000	4HF	1/4	0.094	0.89	1.02	1.54	0.63	0.46	0.65	0.22	1.02
	65L6H	65,000	6HF	3/8	0.125	1.26	1.50	2.01	0.98	0.72	0.69	0.26	1.02
	65L9H	65,000	9HF	9/16	0.188	1.89	1.89	2.64	1.10	0.83	0.94	0.33	1.54
	43L16M	43,000	16MF	1	0.438	2.07	3.00	4.13	2.06	1.38	1.38	0.53	1.77
Tee													
	65T4H	65,000	4HF	1/4	0.094	1.00	1.26	2.01	0.89	0.46	1.30	0.22	1.02
	65T6H	65,000	6HF	3/8	0.125	1.00	1.57	2.01	1.06	0.72	1.38	0.26	1.02
	65T9H	65,000	9HF	9/16	0.188	1.32	2.13	2.64	1.38	0.83	1.89	0.33	1.54
	43T16M	43,000	16MF	1	0.438	2.07	3.00	4.13	2.06	1.38	2.76	0.53	1.77
Cross													
	65X4H	65,000	4HF	1/4	0.094	1.00	1.26	2.01	0.63	0.46	1.30	0.22	1.02
	65X6H	65,000	6HF	3/8	0.125	1.00	2.13	2.01	1.06	0.72	1.38	0.26	1.02
	65X9H	65,000	9HF	9/16	0.188	1.32	2.76	2.64	1.38	0.83	1.89	0.33	1.54
	43X16M	43,000	16MF	1	0.438	2.07	4.13	4.13	2.07	1.38	2.75	0.53	1.77
Straight Coupling / Union Coupling													
	65F4H	65,000	4HF	1/4	0.094	1.38	1.06	Straight Coupling					
	65UF4H							Union Coupling					
	65F6H	65,000	6HF	3/8	0.125	1.77	1.06	Straight Coupling					
	65UF6H							Union Coupling					
	65F9H	65,000	9HF	9/16	0.188	2.19	1.44	Straight Coupling					
	65UF9H							Union Coupling					
	43F16M	43,000	16MF	1	0.438	3.50	2.00	Straight Coupling					
43UF16M	Union Coupling												
Bulkhead Coupling													
	65BF4H	65,000	4HF	1/4	0.094	1.89	1.06	1.06	0.94	0.25			
	65BF6H	65,000	6HF	3/8	0.125	2.38	1.44	1.44	1.18	0.35			
	65BF9H	65,000	9HF	9/16	0.188	2.76	1.63	1.63	1.43	0.67			
	43BF16M	43,000	16MF	1	0.438	3.50	2.00	2.36	1.69	0.47			

See page 2 in the Technical Section for pressure/temperature rating chart. All dimensions are for reference only and are subject to change.

All general terms and conditions of sale, including limitations of our liability, apply to all products and services sold. MT R5 0316

MAXIMATOR anti-vibration collet gland assemblies are for use in applications where there could be extreme external mechanical vibrations or shock in tubing lines. These collet gland assemblies are interchangeable with the standard high pressure coned and threaded tube connections.

In a normal coned and threaded tube connection, any external mechanical loading on the tubing lines, valves or fittings, would be concentrated on the first thread of the tube. This can cause failure of the tube at this thinner cross-section. The anti-vibration collet gland assembly grips the tube behind the connection, supporting the tube at the full cross-section and straight area, moving the loading away from the threaded area.

The anti-vibration collet gland assembly, when tightened properly, compresses a split collet on the tube, providing the beneficial gripping action.

All anti-vibration collet gland assemblies come with a Molybdenum Disulfide Coating to guard against galling of the stainless components.



Gland Pattern	Catalog Number	Pressure Rating (PSI)	Part	O.D. Tubing Size (in.)	Dimensions (in.)	
					A	B (Hex.)
	65AVA4H	65,000 PSI	Complete Assembly	1/4	0.83	0.62
	65AVFC4H		Flat Collar			
	65AVC4H		Slotted Collet			
	65AVG4H		Gland Nut			
	65AVA6H	65,000 PSI	Complete Assembly	3/8	1.16	0.81
	65AVFC6H		Flat Collar			
	65AVC6H		Slotted Collet			
	65AVG6H		Gland Nut			
	65AVA9H	65,000 PSI	Complete Assembly	9/16	1.50	1.19
	65AVFC9H		Flat Collar			
	65AVC9H		Slotted Collet			
	65AVG9H		Gland Nut			
	43AVA16M	43,000 PSI	Complete Assembly	1	2.44	1.50
	43AVB16M		Collet Body			
	43AVC16M		Slotted Collet			
	43AVG16M		Gland Nut			

All dimensions are for reference only and are subject to change.

See page 2 in the Technical Section for determining operating pressures above room temperature.

High Pressure Tubing

Pressures to 65,000 psi

MAXPRO offers a line of cold drawn thick wall tubing, with flow areas to compliment the high pressure valves and fittings. This tubing is made under strict manufacturing and quality control standards and inspections, with dimensional tolerances to match the requirements of the high pressure coned and threaded connections.

The standard materials are 304 and 316 stainless steels. Other materials may be provided on special request, depending on the specific material, diameters and lengths.

MAXPRO also offers this tubing with the “Autofrettage” process. Autofrettage is the practice of subjecting the internal bore of the tubing to a pressure sufficiently high enough to plastically deform the bore, resulting in a residual compressive stress once the pressure is released. Autofrettage produces improved fatigue life of the tube, important in waterjet cutting and other production environments, reducing down time.

Add suffix *-AF* to tubing catalog number to specify Autofrettage process.



Tubing Tolerances

Normal Tubing Size (in.)	Tolerance O.D. (in.)
1/4	0.248 / 0.243
3/8	0.370 / 0.365
9/16	0.557 / 0.552
1	0.995/0.990

Catalog Number	Tube Material	Fits Connection Type	Tube Size (in.)		Working Pressure (psi)				
			O.D.	I.D.	-325 to 100°F	200°F	400°F	600°F	800°F
65TU4H-316	316SS	4HF	1/4	0.083	65,000	58,500	53,950	49,400	46,800
65TU4H-304	304SS								
65TU6H-316	316SS	6HF	3/8	0.125	65,000	58,500	53,950	49,400	46,800
65TU6H-304	304SS								
65TU9H-316	316SS	9HF	9/16	0.188	65,000	58,500	53,950	49,400	46,800
65TU9H-304	304SS								
43TU16M-316	316SS	16MF	1	0.438	43,000	38,700	35,830	32,480	31,050

All dimensions are for reference only and are subject to change.



MAXPRO offers a line of coned and threaded high pressure tube nipples in a variety of lengths for all standard tube sizes.

The coned and threaded high pressure tube nipples are available in 316 stainless steel. See chart below for ordering information.

Special length coned and threaded nipples are available upon request. Consult **MAXPRO** for availability and price.

Catalog Numbers are 316 Stainless Steel material							Fits Connection Type	Tube Size (in.)		Working Pressure at 100 °F (psi)
2.75" Length	3" Length	4" Length	6" Length	8" Length	10" Length	12" Length		O.D.	I.D.	
65N4H-2.75-316	65N4H-3-316	65N4H-4-316	65N4H-6-316	65N4H-8-316	65N4H-10-316	65N4H-12-316	4HF	1/4	0.083	65,000
	65N6H-3-316	65N6H-4-316	65N6H-6-316	65N6H-8-316	65N6H-10-316	65N6H-12-316	6HF	3/8	0.125	65,000
		65N9H-4-316	65N9H-6-316	65N9H-8-316	65N9H-10-316	65N9H-12-316	9HF	9/16	0.188	65,000
			43N16M-6-316	43N16M-8-316	43N16M-10-316	43N16M-12-316	16MF	1	0.438	43,000

Standard nipples are not supplied with glands and collars, see Fittings on page 6 for these components.

See adjacent Tubing page 8, for pressure/temperature rating chart.

All dimensions are for reference only and subject to change.

O-Ring Check Valves



O-Ring Check Valves

MAXIMATOR o-ring check valves provide high quality directional flow control and tight shutoff for liquids and gases. All check valves are supplied with glands and collars. These check valves are not to be used as a relief device. The opening pressure of the O-Ring check valves is approximately 20 psi.

Materials.

Body, cover, poppet, cover gland: 316 series stainless steel
 Spring: 300 series stainless steel
 O-ring: Viton "A" (-4 °F to 392 °F)*

Ball Check Valves



Ball Check Valves

MAXIMATOR ball check valves prevent reverse flow where bubble tight shutoff is not mandatory. These check valves are designed with a ball cradled floating poppet to assure positive inline seating. This poppet design allows full flow around the ball to minimize pressure drop. Check valves are rated to 660 °F*. All check valves are supplied with glands and collars. These check valves are not to be used as a relief device. The opening pressure of the ball check valves is approximately 20 psi.

Materials.

Body, cover, poppet, cover gland: 316 series stainless steel
 Ball and spring: 300 series stainless steel

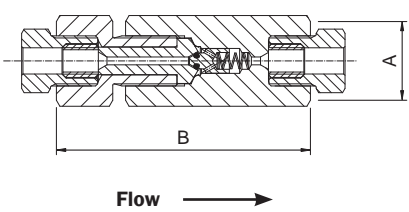
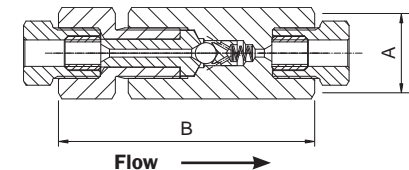
Valve Pattern	Catalog Number	Pressure Rating (psi)	O.D. Tube (in.)	Connec-tion Type	Orifice (in.)	Rated (Cv)	Dimensions (in.)	
							A (Hex.)	B
O-Ring Check Valves								
	650C4H	65,000	1/4	4HF	0.094	0.15	1.19	3.40
	650C6H	65,000	3/8	6HF	0.125	0.28	1.19	3.81
	650C9H	65,000	9/16	9HF	0.188	0.63	1.63	4.61
	430C16M	43,000	1	16MF	0.438	4.30	2.00	6.43
Ball Check Valves								
	65BC4H	65,000	1/4	4HF	0.094	0.15	1.19	3.40
	65BC6H	65,000	3/8	6HF	0.125	0.28	1.19	3.81
	65BC9H	65,000	9/16	9HF	0.188	0.63	1.63	4.61
	43BC16M	43,000	1	16MF	0.438	4.30	2.00	6.43

CAUTION: FREQUENT INSPECTIONS OF O-Rings are necessary to ensure proper service of the check valve. O-Rings have shown satisfactory service life in testing, however different service conditions may lead to variations in cycle and shelf life.

All dimensions are for reference only and subject to change.

*See page 2 in the Technical Section for determining operating pressures above room temperature.

Dual-Disc Line Filters

MAXIMATOR dual-disc line filters are used to filter process fluids in high pressure systems. This design helps remove the large particles first through a coarse primary disc, which then allows a secondary disc to provide a smaller micron filtration. These filter elements are designed to withstand pressure surges without cracking, flaking, or rupturing. Filter elements come standard in the following micron sizes: 5/8, 8/30, 30/56 (secondary/primary). Filters are rated for temperatures -60 °F to 660 °F*. All line filters come with glands and collars.

Materials

Body, cover, cover gland: 316 series stainless steel
Element: 300 series stainless steel

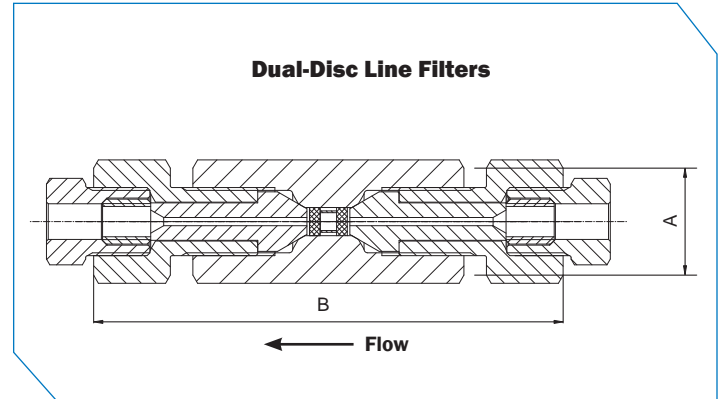

Cup-Type Line Filters

MAXIMATOR cup-type line filters are used when maximum filtration surface area and a single micron size element is preferred. This design increases the filter area as much as 6 times the area of the disc type filter, and will permit higher flow rates with a lower pressure drop, and longer intervals between element changes. Filter elements come standard in 5, 30, or 56 micron sizes and are easily replaced. Filters are rated for temperatures -60 °F to 660 °F*. All line filters come with glands and collars.

Materials:

Body, cover, cover gland: 316 series stainless steel
Element: 300 series stainless steel

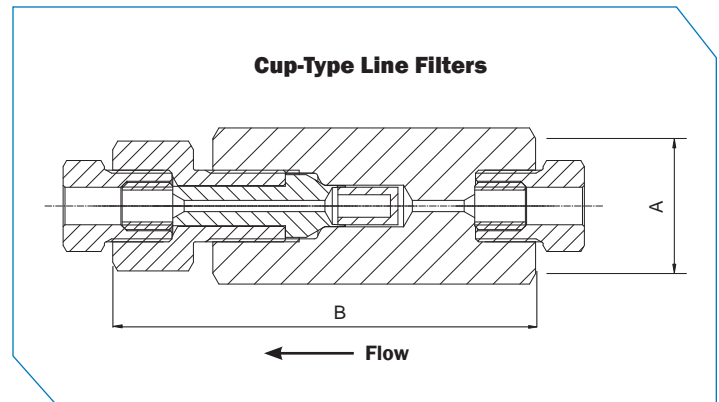

Catalog Number	Pressure Rating (psi)	O.D. Tube (in.)	Connection Type	Orifice (in.)	Micron Size	Filter Element Area (in. ²)	Dimensions (in.)	
							A (Hex.)	B
Dual-Disc Line Filters								
65DF4H-5/8	65,000	1/4	4HF	0.094	5/8	0.07	1.19	4.81
65DF4H-8/30					8/30			
65DF4H-30/56					30/56			
65DF6H-5/8	65,000	3/8	6HF	0.125	5/8	0.07	1.19	5.18
65DF6H-8/30					8/30			
65DF6H-30/56					30/56			
65DF9H-5/8	65,000	9/16	9HF	0.188	5/8	0.15	1.44	5.73
65DF9H-8/30					8/30			
65DF9H-30/56					30/56			

Cup-Type Line Filters								
65CF4H-5	65,000	1/4	4HF	0.094	5	0.82	1.44	4.25
65CF4H-30					30			
65CF4H-56					56			
65CF6H-5	65,000	3/8	6HF	0.125	5	0.82	1.44	4.41
65CF6H-30					30			
65CF6H-56					56			
65CF9H-5	65,000	9/16	9HF	0.188	5	0.82	1.63	5.28
65CF9H-30					30			
65CF9H-56					56			

It is recommended that all fluids entering a high pressure system be thoroughly cleaned. Maximator filters are designed to remove small amounts of process particles. Pressure differential should not exceed 1000 psi across the filter elements.

All dimensions for reference only and are subject to change.

*See page 2 in the Technical Section for determining operating pressures above room temperature.

Angle Filters

MAXIMATOR angle filters are used to filter gases or liquids in high pressure systems. The filter elements can be easily changed. The special design allows the exchange of the filter element without the need to first disassemble the filter in front of the tubing. Filter elements are made of sintered material with pore sizes of 5µm, 30 µm or 56 µm. Filters are rated for temperatures -423 °F to 660 °F. All angle filters come with glands and collars.

Materials

Body: cover, cover gland: 316L series stainless steel

Element: 316 stainless steel

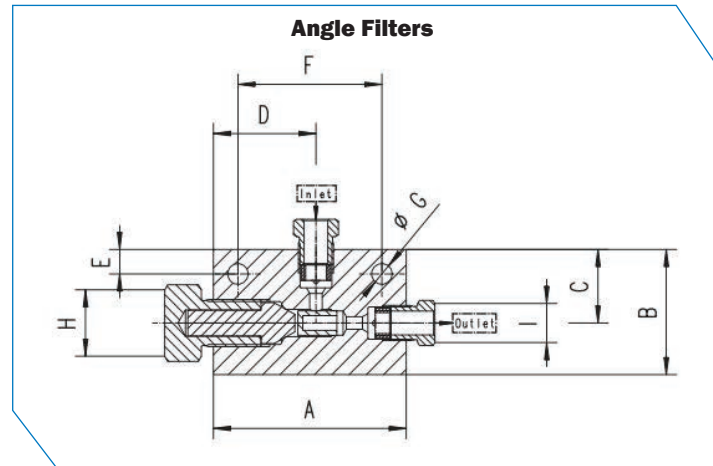

Catalog Number	Pressure Rating psi	Orifice inches	Con-nection Type	Micron Size	Filter Element Areas in ²	Dimensions (in.)										Block Thick-ness
						A	B	C	D	E	F	G	H (Hex)	I (Hex)		
65AF4M-5	65,000	0.094	4H	5	0.82	2.8	2.01	1.18	1.65	0.39	2.01	0.34	1.06	0.63	1.02	
65AF4M-30				30												
65AF4M-56				56												
65AF6M-5	65,000	0.125	6H	5	0.82	3.11	2.01	1.18	1.65	0.39	2.32	0.34	1.06	0.81	1.02	
65AF6M-30				30												
65AF6M-56				56												
65AF9M-5	65,000	0.188	9H	5	0.82	3.23	2.64	1.32	1.65	0.39	2.44	0.34	1.06	1.19	1.54	
65AF9M-30				30												
65AF9M-56				56												

It is recommended that all fluids entering a high pressure system be thoroughly cleaned. Maximator filters are designed to remove small amounts of process particles. Pressure differential should not exceed 1000 psi across the filter elements.

MAXIMATOR safety head assemblies are used to provide over-pressure protection to high pressure systems. These safety head assemblies are to be used with the appropriate 1/4" angular rupture disc listed in the chart below.

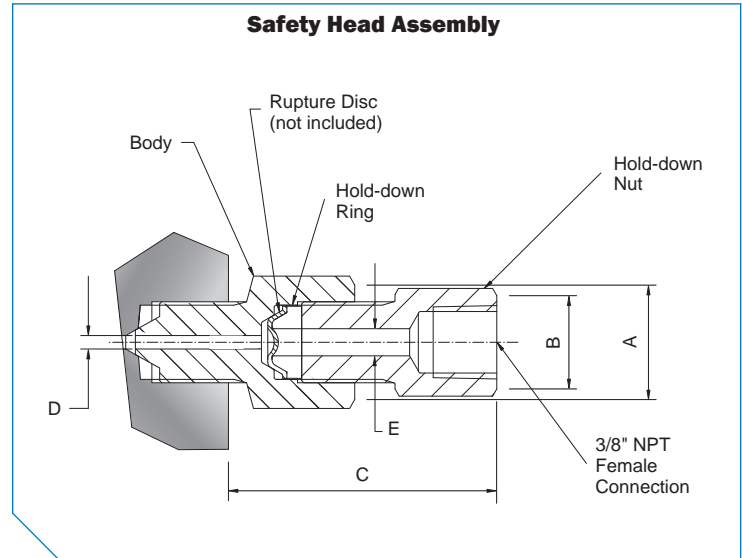
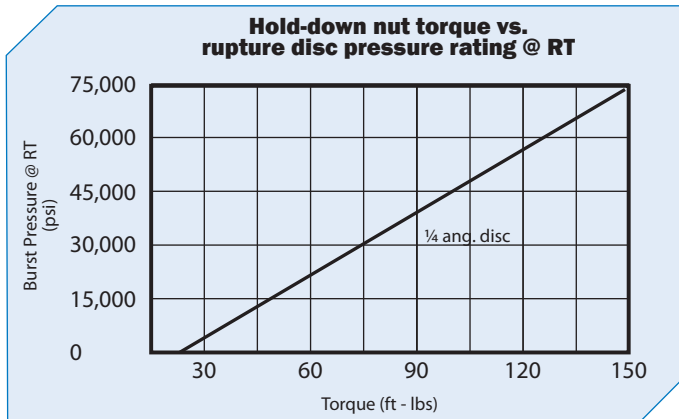

Safety Head Assembly Catalog Number without Disc	Fits Connection Type	O.D. Tube (in.)	Pressure Rating (psi)	Body Torque (ft - lbs.)	Dimensions (in.)				
					A (Hex.)	B (Hex.)	C (LG.)	D (I.D.)	E (I.D.)
65SH4H	4HF	1/4	65,000	25	1.06	0.88	2.56	0.083	0.250
65SH6H	6HF	3/8	65,000	50	1.06	0.88	2.58	0.125	0.250
65SH9H	9HF	9/16	65,000	110	1.19	0.88	2.47	0.188	0.250
43SH16M	16MF	1	43,000	150	1.44	0.88	2.72	0.307	0.250

See page 2 in the Technical Section for determining operating pressures above room temperature.

All dimensions are for reference only and are subject to change.

1/4" Angular Rupture Discs



1/4" angular seat rupture discs are designed to be used with the safety head assemblies that are shown above. Minimum rupture disc pressure ratings should be at least 110% of system operating pressure. The standard rupture disc material is Inconel. The pressure ranges indicated in the table below are at room temperature (72 °F). Other materials and pressure ranges are available upon request.

Catalog Number	Pressure range (psi)	Catalog Number	Pressure range (psi)	Catalog Number	Pressure range (psi)	Catalog Number	Pressure range (psi)
RD-1200	1,164 - 1,272	RD-7000	6,790 - 7,420	RD-17000	16,490 - 18,020	RD-30000	29,100 - 31,800
RD-1500	1,455 - 1,590	RD-7500	7,275 - 7,950	RD-18000	17,460 - 19,080	RD-32500	31,525 - 34,450
RD-1750	1,697 - 1,855	RD-8000	7,760 - 8,480	RD-19000	18,430 - 20,140	RD-35000	33,950 - 37,100
RD-2000	1,940 - 2,120	RD-8500	8,245 - 9,010	RD-20000	19,400 - 21,200	RD-37500	36,375 - 39,750
RD-2500	2,425 - 2,650	RD-9000	8,730 - 9,540	RD-21000	20,370 - 22,260	RD-40000	38,880 - 42,400
RD-3000	2,910 - 3,180	RD-9500	9,215 - 10,070	RD-22000	21,340 - 23,320	RD-42500	41,255 - 45,050
RD-3500	3,395 - 3,710	RD-10000	9,700 - 10,600	RD-23000	22,310 - 24,380	RD-45000	43,650 - 47,700
RD-4000	3,880 - 4,240	RD-11000	10,670 - 11,660	RD-24000	23,280 - 25,440	RD-47500	46,075 - 50,350
RD-4500	4,365 - 4,770	RD-12000	11,640 - 12,720	RD-25000	24,250 - 26,500	RD-50000	48,500 - 53,000
RD-5000	4,850 - 5,300	RD-13000	12,610 - 13,780	RD-26000	25,220 - 27,560	RD-55000	53,350 - 58,300
RD-5500	5,335 - 5,830	RD-14000	13,580 - 14,840	RD-27000	26,190 - 28,620	RD-60000	58,200 - 63,600
RD-6000	5,820 - 6,360	RD-15000	14,550 - 15,900	RD-28000	27,160 - 29,680	RD-67500	65,475 - 71,550
RD-6500	6,305 - 6,890	RD-16000	15,520 - 16,960	RD-29000	28,130 - 30,740	RD-70000	67,900 - 74,200