



MILLING | TURNING | CUT-OFF

AHB

TOOLING & MACHINERY

COMPLETE METALWORKING SOLUTIONS

(800) 991-4225

www.ahbinc.com

ISO Certified

customerservice@ahbinc.com

2024 FALL - 2025 WINTER

PROMO PACK

Offers valid through
March 31, 2025

KYOCERA PRECISION TOOLS (KPT)

KYOCERA Precision Tools (KPT) is a division of the KYOCERA SGS Precision Tools Group specializing in the manufacturing, servicing, and marketing of Indexable Cutting Tools. With over 40 years of cutting tool expertise, KYOCERA has become the market-leader in Japan and has an established global presence with manufacturing, technical centers and sales offices in the Americas, Europe, and Asia.



CUTTING-EDGE, COST-EFFICIENT SOLUTIONS

At KYOCERA Precision Tools, we craft cutting-edge indexable tools that elevate your machining prowess to unparalleled heights. Our creations not only meet but surpass the lofty standards of the modern metalworking aficionado, delivering the pinnacle of quality while respecting the bottom line.

From our origins rooted in ceramic technologies, we've evolved into a global powerhouse in metal removal innovation. Our arsenal includes carbide, cermet, CBN, and PCD solutions, each meticulously designed to outshine the competition.

For over four decades, we've relentlessly pursued perfection, birthing groundbreaking tools that redefine industry standards, including the **MEC Ultra-Hurricane 90° Milling Cutters**, the **MFH-Raptor High-Feed Milling Cutters**, the peerless **DRZ & DRV Family of Magic Drills**, and the trailblazing **CCX, the world's premier CVD Coated Cermet**.

Join the elite league of machinists who demand nothing but the best. Embrace KYOCERA Precision Tools and let your craftsmanship shine brighter than ever before.



PRODUCTS



Turning & Boring



Holemaking



Indexable Milling



Small Tools for Swiss Lathes



Quick-Change Tooling & Specialty Tools



Grooving & Cut-Off

MARKETS SERVED



Aerospace



Automotive



Medical & Dental



Power Generation



Oil & Gas

Milling Solutions

Cost-Efficient Kits Featuring (1) Milling Cutter and (10) Inserts

MA90 Series P M K S H

Multi-Functional 90° Milling with Tangential Inserts

Page 4

MB45 Series P M K N S H

General Purpose 45° Milling with Economical 8-Edge Inserts

Page 10

Turning Solutions

Cost-Efficient Kits Featuring (1) Toolholder and (10) Inserts

CA115P / CA125P P

Steel Turning Grades with Next-Generation CVD Coating Technology

Page 18

PR115S / PR120S M S

Stainless Steel and Heat-Resistant Alloy Turning with New PVD Coating Technology

Page 24

Small Part Cut-Off Solutions

Cost-Efficient Kits Featuring (1) Toolholder and (10) Inserts

KGZ P M

Cut-Off System for Small Parts Machining

Page 28

MA90 Series

Tangential 90° Milling with 4-Edge Inserts



View Online



Product Video



Product Brochure

Original tangential 90° end mill with economical 4-edge inserts

New grade PR18 Series and unique insert cutting edge design creates high-quality machining with longer tool life

The MA90 tangential end mills provide a large variety of machining operations

Challenges

Conventional end mill

- Sudden fractures can cause damage to the holder
- Insert defects preventing use of all four edges

Tangential end mill

- Premature tool wear can quickly deteriorate the surface finish quality
- Poor wall accuracy

SOLUTION

Kyocera's MA90 tangential end mill solves these problems with a unique insert shape and PR18 Series grade coating technology.

Large web thickness

High rigidity

Peripheral grinding specifications

Excellent wall accuracy

Special wiper edge

Large relief angle suppresses wear
High-quality surface finish



2024 Fall - 2025 Winter Promo Pack Offers valid through March 31, 2025

All promotional items are available exclusively through Authorized North American KYOCERA Precision Tool Distributors.

PR18 Series

Next-generation insert grade for milling

Kyocera's Nano Layer Coating Technology

Longer Tool Life with Next-generation Coating for Milling

New insert grades PR18 Series provides significantly longer tool life



**Double Lamination Technology
Maintains Longer Tool Life**

Multi-layer structure with two unique nano layers
Superior abrasion resistance and fracture resistance

Multi-functional (G-class insert)

Supports three-dimensional machining

Unique cutting edge design

Excellent fracture resistance and low cutting force design

Newly developed insert grade

MEGACOAT NANO EX

PR18 Series delivers longer tool life

MA90 MILLING KITS

MB45 MILLING KITS

TURNING KITS

CUT-OFF KITS

MA90 Face Mill Kits

Includes (1) Cutter and (10) Inserts

Choose your Cutter, Insert Grade, and Chipbreaker



MA90 MILLING KITS

MB45 MILLING KITS

TURNING KITS

CUT-OFF KITS

	Pick 1 Cutter Part Number	Cutting Dia.	No. of Insert Pockets	Pick 1			Kit Part Number (Use when Ordering)	\$USD Kit Price	\$CAD Kit Price
				Insert Part Number	Material	Application			
09 Size (LOGU09 Inserts)	MA90-1500R-09T5C	1.500"	5	LOGU 090408ER-GM PR1825	Steel	General Purpose	THN08778KIT1825GM	\$450.00	\$630.00
				LOGU 090408ER-GH PR1810	Cast Iron		THN08778KIT1810GH		
				LOGU 090408ER-GH PR0155	Hardened Material		THN08778KIT0155GH		
				LOGU 090408ER-SM CA6535	Stainless Steel	Wear Resistance	THN08778KIT6535SM		
				LOGU 090408ER-SM PR1835		Stable Machining	THN08778KIT1835SM		
	MA90-1500R-09T6C	1.500"	6	LOGU 090408ER-GM PR1825	Steel	General Purpose	THN08779KIT1825GM	\$450.00	\$630.00
				LOGU 090408ER-GH PR1810	Cast Iron		THN08779KIT1810GH		
				LOGU 090408ER-GH PR0155	Hardened Material		THN08779KIT0155GH		
	MA90-2000R-09T6C	2.000"	6	LOGU 090408ER-SM CA6535	Stainless Steel	Wear Resistance	THN08779KIT6535SM	\$525.00	\$740.00
				LOGU 090408ER-SM PR1835		Stable Machining	THN08779KIT1835SM		
LOGU 090408ER-GM PR1825				Steel	General Purpose	THN08780KIT1825GM			
LOGU 090408ER-GH PR1810	Cast Iron	THN08780KIT1810GH							
LOGU 090408ER-GH PR0155	Hardened Material	THN08780KIT0155GH							
MA90-2000R-09T7C	2.000"	7	LOGU 090408ER-SM CA6535	Stainless Steel	Wear Resistance	THN08781KIT6535SM	\$525.00	\$740.00	
			LOGU 090408ER-SM PR1835		Stable Machining	THN08781KIT1835SM			
			LOGU 090408ER-GM PR1825	Steel	General Purpose	THN08781KIT1825GM			
LOGU 090408ER-GH PR1810	Cast Iron	THN08781KIT1810GH							
LOGU 090408ER-GH PR0155	Hardened Material	THN08781KIT0155GH							
MA90-2500R-09T7C	2.500"	7	LOGU 090408ER-SM CA6535	Stainless Steel	Wear Resistance	THN08782KIT6535SM	\$575.00	\$810.00	
			LOGU 090408ER-SM PR1835		Stable Machining	THN08782KIT1835SM			
			LOGU 090408ER-GM PR1825	Steel	General Purpose	THN08782KIT1825GM			
LOGU 090408ER-GH PR1810	Cast Iron	THN08782KIT1810GH							
LOGU 090408ER-GH PR0155	Hardened Material	THN08782KIT0155GH							
MA90-2500R-09T9C	2.500"	9	LOGU 090408ER-SM CA6535	Stainless Steel	Wear Resistance	THN08783KIT6535SM	\$575.00	\$810.00	
			LOGU 090408ER-SM PR1835		Stable Machining	THN08783KIT1835SM			
			LOGU 090408ER-GM PR1825	Steel	General Purpose	THN08783KIT1825GM			
LOGU 090408ER-GH PR1810	Cast Iron	THN08783KIT1810GH							
LOGU 090408ER-GH PR0155	Hardened Material	THN08783KIT0155GH							
12 Size (LOGU12 Inserts)	MA90-1500R-12T3C	1.500"	3	LOGU 120608ER-GM PR1825	Steel	General Purpose	THN08797KIT1825GM	\$450.00	\$630.00
				LOGU 120608ER-GH PR1810	Cast Iron		THN08797KIT1810GH		
				LOGU 120608ER-GH PR0155	Hardened Material		THN08797KIT0155GH		
				LOGU 120608ER-SM CA6535	Stainless Steel	Wear Resistance	THN08797KIT6535SM		
				LOGU 120608ER-SM PR1835		Stable Machining	THN08797KIT1835SM		
	MA90-1500R-12T4C	1.500"	4	LOGU 120608ER-GM PR1825	Steel	General Purpose	THN08798KIT1825GM	\$450.00	\$630.00
				LOGU 120608ER-GH PR1810	Cast Iron		THN08798KIT1810GH		
				LOGU 120608ER-GH PR0155	Hardened Material		THN08798KIT0155GH		
	MA90-2000R-12T4C	2.000"	4	LOGU 120608ER-SM CA6535	Stainless Steel	Wear Resistance	THN08798KIT6535SM	\$525.00	\$740.00
				LOGU 120608ER-SM PR1835		Stable Machining	THN08798KIT1835SM		
LOGU 120608ER-GM PR1825				Steel	General Purpose	THN08799KIT1825GM			
LOGU 120608ER-GH PR1810	Cast Iron	THN08799KIT1810GH							
LOGU 120608ER-GH PR0155	Hardened Material	THN08799KIT0155GH							
MA90-2000R-12T6C	2.000"	6	LOGU 120608ER-SM CA6535	Stainless Steel	Wear Resistance	THN08799KIT6535SM	\$525.00	\$740.00	
			LOGU 120608ER-SM PR1835		Stable Machining	THN08799KIT1835SM			
			LOGU 120608ER-GM PR1825	Steel	General Purpose	THN08800KIT1825GM			
LOGU 120608ER-GH PR1810	Cast Iron	THN08800KIT1810GH							
LOGU 120608ER-GH PR0155	Hardened Material	THN08800KIT0155GH							
MA90-2500R-12T6C	2.500"	6	LOGU 120608ER-SM CA6535	Stainless Steel	Wear Resistance	THN08800KIT6535SM	\$575.00	\$810.00	
			LOGU 120608ER-SM PR1835		Stable Machining	THN08800KIT1835SM			
			LOGU 120608ER-GM PR1825	Steel	General Purpose	THN08801KIT1825GM			
LOGU 120608ER-GH PR1810	Cast Iron	THN08801KIT1810GH							
LOGU 120608ER-GH PR0155	Hardened Material	THN08801KIT0155GH							
MA90-2500R-12T8C	2.500"	8	LOGU 120608ER-SM CA6535	Stainless Steel	Wear Resistance	THN08801KIT6535SM	\$575.00	\$810.00	
			LOGU 120608ER-SM PR1835		Stable Machining	THN08801KIT1835SM			
			LOGU 120608ER-GM PR1825	Steel	General Purpose	THN08802KIT1825GM			
LOGU 120608ER-GH PR1810	Cast Iron	THN08802KIT1810GH							
LOGU 120608ER-GH PR0155	Hardened Material	THN08802KIT0155GH							
MA90-3000R-12T8C	3.000"	8	LOGU 120608ER-SM CA6535	Stainless Steel	Wear Resistance	THN08802KIT6535SM	\$625.00	\$880.00	
			LOGU 120608ER-SM PR1835		Stable Machining	THN08802KIT1835SM			
			LOGU 120608ER-GM PR1825	Steel	General Purpose	THN08803KIT1825GM			
LOGU 120608ER-GH PR1810	Cast Iron	THN08803KIT1810GH							
LOGU 120608ER-GH PR0155	Hardened Material	THN08803KIT0155GH							
MA90-3000R-12T10C	3.000"	10	LOGU 120608ER-SM CA6535	Stainless Steel	Wear Resistance	THN08803KIT6535SM	\$625.00	\$880.00	
			LOGU 120608ER-SM PR1835		Stable Machining	THN08803KIT1835SM			
			LOGU 120608ER-GM PR1825	Steel	General Purpose	THN08804KIT1825GM			
LOGU 120608ER-GH PR1810	Cast Iron	THN08804KIT1810GH							
LOGU 120608ER-GH PR0155	Hardened Material	THN08804KIT0155GH							
				LOGU 120608ER-SM CA6535	Stainless Steel	Wear Resistance	THN08804KIT6535SM		
				LOGU 120608ER-SM PR1835		Stable Machining	THN08804KIT1835SM		

2024 Fall - 2025 Winter Promo Pack Offers valid through March 31, 2025

All promotional items are available exclusively through Authorized North American KYOCERA Precision Tool Distributors.

MA90 Weldon Shank End Mill Kits

Includes (1) Cutter and (10) Inserts

Choose your Cutter, Insert Grade, and Chipbreaker



	Pick 1 Cutter Part Number	Cutting Dia.	No. of Insert Pockets	Pick 1			Kit Part Number (Use when Ordering)	\$USD Kit Price	\$CAD Kit Price
				Insert Part Number	Material	Application			
09 Size (LOGU09 Inserts)	MA90-0625-W625-09T2C	0.625"	2	LOGU 090408ER-GM PR1825	Steel	General Purpose	THN08764KIT1825GM	\$300.00	\$420.00
				LOGU 090408ER-GH PR1810	Cast Iron		THN08764KIT1810GH		
				LOGU 090408ER-GH PR0155	Hardened Material		THN08764KIT0155GH		
				LOGU 090408ER-SM CA6535	Stainless Steel		THN08764KIT6535SM		
	LOGU 090408ER-SM PR1835	THN08764KIT1835SM							
	MA90-0750-W750-09T3C	0.750"	3	LOGU 090408ER-GM PR1825	Steel	General Purpose	THN08765KIT1825GM	\$325.00	\$460.00
				LOGU 090408ER-GH PR1810	Cast Iron		THN08765KIT1810GH		
				LOGU 090408ER-GH PR0155	Hardened Material		THN08765KIT0155GH		
				LOGU 090408ER-SM CA6535	Stainless Steel		THN08765KIT6535SM		
	LOGU 090408ER-SM PR1835	THN08765KIT1835SM							
MA90-1000-W100-09T4C	1.000"	4	LOGU 090408ER-GM PR1825	Steel	General Purpose	THN08766KIT1825GM	\$375.00	\$530.00	
			LOGU 090408ER-GH PR1810	Cast Iron		THN08766KIT1810GH			
			LOGU 090408ER-GH PR0155	Hardened Material		THN08766KIT0155GH			
			LOGU 090408ER-SM CA6535	Stainless Steel		THN08766KIT6535SM			
LOGU 090408ER-SM PR1835	THN08766KIT1835SM								
MA90-1250-W100-09T4C	1.250"	4	LOGU 090408ER-GM PR1825	Steel	General Purpose	THN08767KIT1825GM	\$400.00	\$560.00	
			LOGU 090408ER-GH PR1810	Cast Iron		THN08767KIT1810GH			
			LOGU 090408ER-GH PR0155	Hardened Material		THN08767KIT0155GH			
			LOGU 090408ER-SM CA6535	Stainless Steel		THN08767KIT6535SM			
LOGU 090408ER-SM PR1835	THN08767KIT1835SM								
MA90-1250-W100-09T5C	1.250"	5	LOGU 090408ER-GM PR1825	Steel	General Purpose	THN08768KIT1825GM	\$400.00	\$560.00	
			LOGU 090408ER-GH PR1810	Cast Iron		THN08768KIT1810GH			
			LOGU 090408ER-GH PR0155	Hardened Material		THN08768KIT0155GH			
			LOGU 090408ER-SM CA6535	Stainless Steel		THN08768KIT6535SM			
LOGU 090408ER-SM PR1835	THN08768KIT1835SM								
MA90-1250-W125-09T5C	1.250"	5	LOGU 090408ER-GM PR1825	Steel	General Purpose	THN08769KIT1825GM	\$425.00	\$600.00	
			LOGU 090408ER-GH PR1810	Cast Iron		THN08769KIT1810GH			
			LOGU 090408ER-GH PR0155	Hardened Material		THN08769KIT0155GH			
			LOGU 090408ER-SM CA6535	Stainless Steel		THN08769KIT6535SM			
LOGU 090408ER-SM PR1835	THN08769KIT1835SM								
MA90-1500-W125-09T5C	1.500"	5	LOGU 090408ER-GM PR1825	Steel	General Purpose	THN08770KIT1825GM	\$450.00	\$630.00	
			LOGU 090408ER-GH PR1810	Cast Iron		THN08770KIT1810GH			
			LOGU 090408ER-GH PR0155	Hardened Material		THN08770KIT0155GH			
			LOGU 090408ER-SM CA6535	Stainless Steel		THN08770KIT6535SM			
LOGU 090408ER-SM PR1835	THN08770KIT1835SM								
MA90-1500-W125-09T6C	1.500"	6	LOGU 090408ER-GM PR1825	Steel	General Purpose	THN08771KIT1825GM	\$450.00	\$630.00	
			LOGU 090408ER-GH PR1810	Cast Iron		THN08771KIT1810GH			
			LOGU 090408ER-GH PR0155	Hardened Material		THN08771KIT0155GH			
			LOGU 090408ER-SM CA6535	Stainless Steel		THN08771KIT6535SM			
LOGU 090408ER-SM PR1835	THN08771KIT1835SM								
12 Size (LOGU12 Inserts)	MA90-1000-W100-12T2C	1.000"	2	LOGU 120608ER-GM PR1825	Steel	General Purpose	THN08787KIT1825GM	\$350.00	\$490.00
				LOGU 120608ER-GH PR1810	Cast Iron		THN08787KIT1810GH		
				LOGU 120608ER-GH PR0155	Hardened Material		THN08787KIT0155GH		
				LOGU 120608ER-SM CA6535	Stainless Steel		THN08787KIT6535SM		
	LOGU 120608ER-SM PR1835	THN08787KIT1835SM							
	MA90-1250-W100-12T2C	1.250"	2	LOGU 120608ER-GM PR1825	Steel	General Purpose	THN08788KIT1825GM	\$400.00	\$560.00
				LOGU 120608ER-GH PR1810	Cast Iron		THN08788KIT1810GH		
				LOGU 120608ER-GH PR0155	Hardened Material		THN08788KIT0155GH		
				LOGU 120608ER-SM CA6535	Stainless Steel		THN08788KIT6535SM		
	LOGU 120608ER-SM PR1835	THN08788KIT1835SM							
MA90-1250-W100-12T3C	1.250"	3	LOGU 120608ER-GM PR1825	Steel	General Purpose	THN08789KIT1825GM	\$400.00	\$560.00	
			LOGU 120608ER-GH PR1810	Cast Iron		THN08789KIT1810GH			
			LOGU 120608ER-GH PR0155	Hardened Material		THN08789KIT0155GH			
			LOGU 120608ER-SM CA6535	Stainless Steel		THN08789KIT6535SM			
LOGU 120608ER-SM PR1835	THN08789KIT1835SM								
MA90-1250-W125-12T3C	1.250"	3	LOGU 120608ER-GM PR1825	Steel	General Purpose	THN08790KIT1825GM	\$400.00	\$560.00	
			LOGU 120608ER-GH PR1810	Cast Iron		THN08790KIT1810GH			
			LOGU 120608ER-GH PR0155	Hardened Material		THN08790KIT0155GH			
			LOGU 120608ER-SM CA6535	Stainless Steel		THN08790KIT6535SM			
LOGU 120608ER-SM PR1835	THN08790KIT1835SM								
MA90-1500-W125-12T3C	1.500"	3	LOGU 120608ER-GM PR1825	Steel	General Purpose	THN08791KIT1825GM	\$425.00	\$600.00	
			LOGU 120608ER-GH PR1810	Cast Iron		THN08791KIT1810GH			
			LOGU 120608ER-GH PR0155	Hardened Material		THN08791KIT0155GH			
			LOGU 120608ER-SM CA6535	Stainless Steel		THN08791KIT6535SM			
LOGU 120608ER-SM PR1835	THN08791KIT1835SM								
MA90-1500-W125-12T4C	1.500"	4	LOGU 120608ER-GM PR1825	Steel	General Purpose	THN08792KIT1825GM	\$450.00	\$630.00	
			LOGU 120608ER-GH PR1810	Cast Iron		THN08792KIT1810GH			
			LOGU 120608ER-GH PR0155	Hardened Material		THN08792KIT0155GH			
			LOGU 120608ER-SM CA6535	Stainless Steel		THN08792KIT6535SM			
LOGU 120608ER-SM PR1835	THN08792KIT1835SM								

MA90 MILLING KITS

MB45 MILLING KITS

TURNING KITS

CUT-OFF KITS

MA90 Straight Shank End Mill Kits

Includes (1) Cutter and (10) Inserts

Choose your Cutter, Insert Grade, and Chipbreaker



	Pick 1 Cutter Part Number	Cutting Dia.	No. of Insert Pockets	Pick 1			Kit Part Number (Use when Ordering)	\$USD Kit Price	\$CAD Kit Price		
				Insert Part Number	Material	Application					
Straight - Standard Shank	09 Size (LOGU09 Inserts)	MA90-0625-S625-09T2C	0.625"	2	LOGU 090408ER-GM PR1825	Steel	General Purpose	THN08759KIT1825GM	\$300.00	\$420.00	
					LOGU 090408ER-GH PR1810	Cast Iron		THN08759KIT1810GH			
					LOGU 090408ER-GH PR0155	Hardened Material		THN08759KIT0155GH			
					LOGU 090408ER-SM CA6535	Stainless Steel		Wear Resistance			THN08759KIT6535SM
					LOGU 090408ER-SM PR1835			Stable Machining			THN08759KIT1835SM
	MA90-0750-S750-09T3C	0.750"	3	LOGU 090408ER-GM PR1825	Steel	General Purpose	THN08760KIT1825GM	\$325.00	\$460.00		
				LOGU 090408ER-GH PR1810	Cast Iron		THN08760KIT1810GH				
				LOGU 090408ER-GH PR0155	Hardened Material		THN08760KIT0155GH				
	MA90-1000-S100-09T4C	1.000"	4	LOGU 090408ER-SM CA6535	Stainless Steel	Wear Resistance	THN08760KIT6535SM	\$375.00	\$530.00		
				LOGU 090408ER-SM PR1835		Stable Machining	THN08760KIT1835SM				
				LOGU 090408ER-GM PR1825	Steel	General Purpose	THN08761KIT1825GM				
	LOGU 090408ER-GH PR1810	Cast Iron	THN08761KIT1810GH								
LOGU 090408ER-GH PR0155	Hardened Material	THN08761KIT0155GH									
MA90-1250-S100-09T5C	1.250"	5	LOGU 090408ER-SM CA6535	Stainless Steel	Wear Resistance	THN08761KIT6535SM	\$425.00	\$600.00			
			LOGU 090408ER-SM PR1835		Stable Machining	THN08761KIT1835SM					
			LOGU 090408ER-GM PR1825	Steel	General Purpose	THN08762KIT1825GM					
			LOGU 090408ER-GH PR1810	Cast Iron		THN08762KIT1810GH					
			LOGU 090408ER-GH PR0155	Hardened Material		THN08762KIT0155GH					
MA90-1500-S125-09T5C	1.500"	5	LOGU 090408ER-SM CA6535	Stainless Steel	Wear Resistance	THN08762KIT6535SM	\$450.00	\$630.00			
			LOGU 090408ER-SM PR1835		Stable Machining	THN08762KIT1835SM					
			LOGU 090408ER-GM PR1825	Steel	General Purpose	THN08763KIT1825GM					
LOGU 090408ER-GH PR1810	Cast Iron	THN08763KIT1810GH									
LOGU 090408ER-GH PR0155	Hardened Material	THN08763KIT0155GH									
Straight - Standard Shank	12 Size (LOGU12 Inserts)	MA90-1000-S100-12T2C	1.000"	2	LOGU 120608ER-GM PR1825	Steel	General Purpose	THN08784KIT1825GM	\$350.00	\$490.00	
					LOGU 120608ER-GH PR1810	Cast Iron		THN08784KIT1810GH			
					LOGU 120608ER-GH PR0155	Hardened Material		THN08784KIT0155GH			
					LOGU 120608ER-SM CA6535	Stainless Steel		Wear Resistance			THN08784KIT6535SM
					LOGU 120608ER-SM PR1835			Stable Machining			THN08784KIT1835SM
	MA90-1250-S100-12T3C	1.250"	3	LOGU 120608ER-GM PR1825	Steel	General Purpose	THN08785KIT1825GM	\$400.00	\$260.00		
				LOGU 120608ER-GH PR1810	Cast Iron		THN08785KIT1810GH				
				LOGU 120608ER-GH PR0155	Hardened Material		THN08785KIT0155GH				
	MA90-1500-S125-12T4C	1.500"	4	LOGU 120608ER-SM CA6535	Stainless Steel	Wear Resistance	THN08785KIT6535SM	\$450.00	\$630.00		
				LOGU 120608ER-SM PR1835		Stable Machining	THN08785KIT1835SM				
				LOGU 120608ER-GM PR1825	Steel	General Purpose	THN08786KIT1825GM				
	LOGU 120608ER-GH PR1810	Cast Iron	THN08786KIT1810GH								
LOGU 120608ER-GH PR0155	Hardened Material	THN08786KIT0155GH									
Straight - Long Shank	09 Size (LOGU09 Inserts)	MA90-0750-S750-09T3CL	0.750"	3	LOGU 090408ER-SM CA6535	Stainless Steel	Wear Resistance	THN08772KIT6535SM	\$350.00	\$490.00	
					LOGU 090408ER-SM PR1835		Stable Machining	THN08772KIT1835SM			
					LOGU 090408ER-GM PR1825	Steel	General Purpose	THN08773KIT1825GM			
					LOGU 090408ER-GH PR1810	Cast Iron		THN08773KIT1810GH			
					LOGU 090408ER-GH PR0155	Hardened Material		THN08773KIT0155GH			
	MA90-1000-S100-09T3CL	1.000"	3	LOGU 090408ER-SM CA6535	Stainless Steel	Wear Resistance	THN08773KIT6535SM	\$375.00	\$530.00		
				LOGU 090408ER-SM PR1835		Stable Machining	THN08773KIT1835SM				
				LOGU 090408ER-GM PR1825	Steel	General Purpose	THN08774KIT1825GM				
	LOGU 090408ER-GH PR1810	Cast Iron	THN08774KIT1810GH								
	LOGU 090408ER-GH PR0155	Hardened Material	THN08774KIT0155GH								
	MA90-1500-S125-09T3CL	1.500"	3	LOGU 090408ER-SM CA6535	Stainless Steel	Wear Resistance	THN08774KIT6535SM	\$425.00	\$600.00		
				LOGU 090408ER-SM PR1835		Stable Machining	THN08774KIT1835SM				
LOGU 090408ER-GM PR1825				Steel	General Purpose	THN08774KIT1825GM					
LOGU 090408ER-GH PR1810	Cast Iron	THN08774KIT1810GH									
LOGU 090408ER-GH PR0155	Hardened Material	THN08774KIT0155GH									
MA90-1000-S100-12T2CL	1.000"	2	LOGU 120608ER-SM CA6535	Stainless Steel	Wear Resistance	THN08793KIT6535SM	\$375.00	\$530.00			
			LOGU 120608ER-SM PR1835		Stable Machining	THN08793KIT1835SM					
			LOGU 120608ER-GM PR1825	Steel	General Purpose	THN08793KIT1825GM					
			LOGU 120608ER-GH PR1810	Cast Iron		THN08793KIT1810GH					
			LOGU 120608ER-GH PR0155	Hardened Material		THN08793KIT0155GH					
MA90-1500-S125-12T3CL	1.500"	3	LOGU 120608ER-SM CA6535	Stainless Steel	Wear Resistance	THN08793KIT6535SM	\$450.00	\$630.00			
			LOGU 120608ER-SM PR1835		Stable Machining	THN08793KIT1835SM					
			LOGU 120608ER-GM PR1825	Steel	General Purpose	THN08794KIT1825GM					
LOGU 120608ER-GH PR1810	Cast Iron	THN08794KIT1810GH									
LOGU 120608ER-GH PR0155	Hardened Material	THN08794KIT0155GH									

2024 Fall - 2025 Winter Promo Pack Offers valid through March 31, 2025

All promotional items are available exclusively through Authorized North American KYOCERA Precision Tool Distributors.

MA90 Modular End Mill Kits

Includes (1) Cutter and (10) Inserts

Choose your Cutter, Insert Grade, and Chipbreaker



Pick 1	Cutter Part Number	Cutting Dia.	No. of Insert Pockets	Pick 1			Kit Part Number (Use when Ordering)	\$USD Kit Price	\$CAD Kit Price	
				Insert Part Number	Material	Application				
09 Size (LOGU09 Inserts)	MA90-0750M10-09T3C	0.750"	3	LOGU 090408ER-GM PR1825	Steel	General Purpose	THN08775KIT1825GM	\$325.00	\$460.00	
				LOGU 090408ER-GH PR1810	Cast Iron		THN08775KIT1810GH			
				LOGU 090408ER-GH PR0155	Hardened Material		THN08775KIT0155GH			
				LOGU 090408ER-SM CA6535	Stainless Steel		THN08775KIT6535SM			
	LOGU 090408ER-SM PR1835	Stable Machining	THN08775KIT1835SM							
	MA90-1000M12-09T4C	1.000"	4	LOGU 090408ER-GM PR1825	Steel	General Purpose	THN08776KIT1825GM	\$375.00	\$530.00	
				LOGU 090408ER-GH PR1810	Cast Iron		THN08776KIT1810GH			
				LOGU 090408ER-SM CA6535	Stainless Steel		THN08776KIT0155GH			
				LOGU 090408ER-SM PR1835			Wear Resistance			THN08776KIT6535SM
	MA90-1250M16-09T5C	1.250"	5	LOGU 090408ER-GM PR1825	Steel	General Purpose	THN08776KIT1825GM	\$400.00	\$560.00	
				LOGU 090408ER-GH PR1810	Cast Iron		THN08777KIT1810GH			
				LOGU 090408ER-SM CA6535	Stainless Steel		THN08777KIT0155GH			
LOGU 090408ER-SM PR1835				Wear Resistance			THN08777KIT6535SM			
12 Size (LOGU12 Inserts)	MA90-1000M12-12T2C	1.000"	2	LOGU 120608ER-GM PR1825	Steel	General Purpose	THN08795KIT1825GM	\$325.00	\$460.00	
				LOGU 120608ER-GH PR1810	Cast Iron		THN08795KIT1810GH			
				LOGU 120608ER-GH PR0155	Hardened Material		THN08795KIT0155GH			
				LOGU 120608ER-SM CA6535	Stainless Steel		THN08795KIT6535SM			
	LOGU 120608ER-SM PR1835	Wear Resistance	THN08795KIT1835SM							
	MA90-1250M16-12T3C	1.250"	3	LOGU 120608ER-GM PR1825	Steel	General Purpose	THN08796KIT1825GM	\$375.00	\$530.00	
				LOGU 120608ER-GH PR1810	Cast Iron		THN08796KIT1810GH			
				LOGU 120608ER-GH PR0155	Hardened Material		THN08796KIT0155GH			
				LOGU 120608ER-SM CA6535	Stainless Steel		THN08796KIT6535SM			
	LOGU 120608ER-SM PR1835	Wear Resistance	THN08796KIT1835SM							

Applicable Inserts

Shape	Description	Usage Classification						Dimensions (in)				MEGACOAT NANO EX (PVD Coating)		CVD Coating			
		P	M	K	S	H	W1	S	D1	INSL	BS	RE	PR1825	PR1835	PR0155	CA6535	
													PR1825	PR1835	PR0155	CA6535	
<p>Unmarked : GM △ : SM □ : GH</p>	LOGU 090408ER-GM	★										●					
	LOGU 090408ER-SM						0.169	0.264	0.131	0.350	0.035	0.031		●			●
	LOGU 090408ER-GH														●	●	-
	LOGU 120608ER-GM																
	LOGU 120608ER-SM						0.260	0.395	0.179	0.523	0.084	0.031			●		●
	LOGU 120608ER-GH															●	●

See [MA90 Brochure](#) for other available insert sizes and grades

● : Available in Promo Kits

MB45

45° General Purpose Milling Series



View Online



Product Video



Product Brochure

Provides high quality and high performance machining solutions with long tool life

Delivers the low cutting force benefits of positive inserts and the fracture resistance benefits of negative inserts, and provides excellent surface finish

Extreme versatility

General-purpose milling cutters must strike a balance between quality, performance, long tool life, economy, and versatility to effectively handle a wide range of machining tasks.

The MB45 achieves all these qualities without compromise. These next-generation cutters are durable, ensuring reliability whether used for general machining applications or for discovering innovative machining solutions.

MA90 MILLING KITS

MB45 MILLING KITS

TURNING KITS

CUT-OFF KITS

01

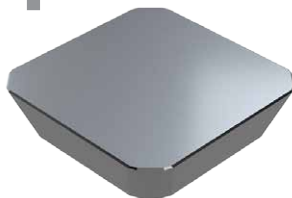

ISO Standard SEKN Type
(No breaker)

02



Positive (Single-sided) Type

Advantage

- Low cutting force
- Excellent finished surface and machining accuracy

03



Negative (Double-sided) Type

Advantage

- Excellent fracture resistance
- Economical with multiple cutting edges



MA90 MILLING KITS

MB45 MILLING KITS

TURNING KITS

CUT-OFF KITS

04

MB45

Delivers the “low cutting force” benefits of positive inserts and the “fracture resistance” benefits of negative inserts

High Quality

High quality results and excellent surface finish

- Lineup of E class inserts
- Long arc wiper edge
- Back coolant hole

High Performance

Unique low cutting force design with fracture resistance

- Double edge structure and helical cutting edge (A.R. max + 13°)

Long Tool Life

Next-generation PVD coating for milling PR18 Series **NEW**

- Double lamination technology maintains longer tool life
- Double-sided 8-edge design reduces tool costs

Solution

Find new value with excellent versatility

- Integrated tooling: Roughing and finishing with E class inserts
- For a wide variety of machining applications: Small machines (BT30, etc.) with ø40mm cutter
- For a variety of workpieces: Cost-cutting with multiple cutting edges for aluminum machining
- Enhanced Quality: Gain excellent surface finish with Cermet inserts (TN620M)

MB45 Coarse Pitch Face Mill Kits

Includes (1) Cutter and (10) Inserts

Choose your Cutter, Insert Grade, and Chipbreaker



	Pick 1 Cutter Part Number	Cutting Dia.	No. of Insert Pockets	Pick 1			Kit Part Number (Use when Ordering)	\$USD Kit Price	\$CAD Kit Price
				Insert Part Number	Material	Application			
Coarse Pitch Face Mills	MB45--200R--14T3C	2.000"	3	SNMU 1406ANER-GM PR1825	Steel	General Purpose	THN08901KITM1825GM	\$400.00	\$560.00
				SNEU 1406ANER-GM PR1825		Good Surface Finish	THN08901KITE1825GM		
				SNEU 1406ANER-SM PR1835	Stainless Steel	Stable Machining	THN08901KITE1835SM		
				SNEU 1406ANER-SM CA6535		Wear Resistance	THN08901KITE6535SM		
				SNMU 1406ANER-GH PR1810	Cast Iron	General Purpose	THN08901KITM1810GH		
				SNMU 1406ANER-GH PR0155	Hardened Material	General Purpose	THN08901KITM0155GH		
				SNEU 1406ANER-AM PDL025	Non-Ferrous	General Purpose	THN08901KITELO25AM		
	MB45-2500R-14T4C	2.500"	4	SNMU 1406ANER-GM PR1825	Steel	General Purpose	THN08902KITM1825GM	\$500.00	\$700.00
				SNEU 1406ANER-GM PR1825		Good Surface Finish	THN08902KITE1825GM		
				SNEU 1406ANER-SM PR1835	Stainless Steel	Stable Machining	THN08902KITE1835SM		
				SNEU 1406ANER-SM CA6535		Wear Resistance	THN08902KITE6535SM		
				SNMU 1406ANER-GH PR1810	Cast Iron	General Purpose	THN08902KITM1810GH		
				SNMU 1406ANER-GH PR0155	Hardened Material	General Purpose	THN08902KITM0155GH		
				SNEU 1406ANER-AM PDL025	Non-Ferrous	General Purpose	THN08902KITELO25AM		
	MB45-3000R-14T5C	3.000"	5	SNMU 1406ANER-GM PR1825	Steel	General Purpose	THN08903KITM1825GM	\$550.00	\$770.00
				SNEU 1406ANER-GM PR1825		Good Surface Finish	THN08903KITE1825GM		
				SNEU 1406ANER-SM PR1835	Stainless Steel	Stable Machining	THN08903KITE1835SM		
				SNEU 1406ANER-SM CA6535		Wear Resistance	THN08903KITE6535SM		
				SNMU 1406ANER-GH PR1810	Cast Iron	General Purpose	THN08903KITM1810GH		
				SNMU 1406ANER-GH PR0155	Hardened Material	General Purpose	THN08903KITM0155GH		
				SNEU 1406ANER-AM PDL025	Non-Ferrous	General Purpose	THN08903KITELO25AM		
	MB45-4000R-14T5C	4.000"	5	SNMU 1406ANER-GM PR1825	Steel	General Purpose	THN08904KITM1825GM	\$600.00	\$840.00
				SNEU 1406ANER-GM PR1825		Good Surface Finish	THN08904KITE1825GM		
				SNEU 1406ANER-SM PR1835	Stainless Steel	Stable Machining	THN08904KITE1835SM		
				SNEU 1406ANER-SM CA6535		Wear Resistance	THN08904KITE6535SM		
				SNMU 1406ANER-GH PR1810	Cast Iron	General Purpose	THN08904KITM1810GH		
				SNMU 1406ANER-GH PR0155	Hardened Material	General Purpose	THN08904KITM0155GH		
				SNEU 1406ANER-AM PDL025	Non-Ferrous	General Purpose	THN08904KITELO25AM		
MB45-5000R-14T6C	5.000"	6	SNMU 1406ANER-GM PR1825	Steel	General Purpose	THN08905KITM1825GM	\$700.00	\$980.00	
			SNEU 1406ANER-GM PR1825		Good Surface Finish	THN08905KITE1825GM			
			SNEU 1406ANER-SM PR1835	Stainless Steel	Stable Machining	THN08905KITE1835SM			
			SNEU 1406ANER-SM CA6535		Wear Resistance	THN08905KITE6535SM			
			SNMU 1406ANER-GH PR1810	Cast Iron	General Purpose	THN08905KITM1810GH			
			SNMU 1406ANER-GH PR0155	Hardened Material	General Purpose	THN08905KITM0155GH			
			SNEU 1406ANER-AM PDL025	Non-Ferrous	General Purpose	THN08905KITELO25AM			

2024 Fall - 2025 Winter Promo Pack Offers valid through March 31, 2025

All promotional items are available exclusively through Authorized North American KYOCERA Precision Tool Distributors.

MA90 MILLING KITS

MB45 MILLING KITS

TURNING KITS

CUT-OFF KITS

MB45 Fine Pitch Face Mill Kits

Includes (1) Cutter and (10) Inserts

Choose your Cutter, Insert Grade, and Chipbreaker



	Pick 1 Cutter Part Number	Cutting Dia.	No. of Insert Pockets	Pick 1			Kit Part Number (Use when Ordering)	\$USD Kit Price	\$CAD Kit Price
				Insert Part Number	Material	Application			
Fine Pitch Face Mills	MB45-2000R-14T4C	2.000"	4	SNMU 1406ANER-GM PR1825	Steel	General Purpose	THN08907KITM1825GM	\$400.00	\$560.00
				SNEU 1406ANER-GM PR1825		Good Surface Finish	THN08907KITE1825GM		
				SNEU 1406ANER-SM PR1835	Stainless Steel	Stable Machining	THN08907KITE1835SM		
				SNEU 1406ANER-SM CA6535		Wear Resistance	THN08907KITE6535SM		
				SNMU 1406ANER-GH PR1810	Cast Iron	General Purpose	THN08907KITM1810GH		
				SNMU 1406ANER-GH PR0155	Hardened Material	General Purpose	THN08907KITM0155GH		
				SNEU 1406ANER-AM PDL025	Non-Ferrous	General Purpose	THN08907KITEL025AM		
	MB45-2500R-14T5C	2.500"	5	SNMU 1406ANER-GM PR1825	Steel	General Purpose	THN08908KITM1825GM	\$500.00	\$700.00
				SNEU 1406ANER-GM PR1825		Good Surface Finish	THN08908KITE1825GM		
				SNEU 1406ANER-SM PR1835	Stainless Steel	Stable Machining	THN08908KITE1835SM		
				SNEU 1406ANER-SM CA6535		Wear Resistance	THN08908KITE6535SM		
				SNMU 1406ANER-GH PR1810	Cast Iron	General Purpose	THN08908KITM1810GH		
				SNMU 1406ANER-GH PR0155	Hardened Material	General Purpose	THN08908KITM0155GH		
				SNEU 1406ANER-AM PDL025	Non-Ferrous	General Purpose	THN08908KITEL025AM		
	MB45-3000R-14T6C	3.000"	6	SNMU 1406ANER-GM PR1825	Steel	General Purpose	THN08909KITM1825GM	\$550.00	\$770.00
				SNEU 1406ANER-GM PR1825		Good Surface Finish	THN08909KITE1825GM		
				SNEU 1406ANER-SM PR1835	Stainless Steel	Stable Machining	THN08909KITE1835SM		
				SNEU 1406ANER-SM CA6535		Wear Resistance	THN08909KITE6535SM		
				SNMU 1406ANER-GH PR1810	Cast Iron	General Purpose	THN08909KITM1810GH		
				SNMU 1406ANER-GH PR0155	Hardened Material	General Purpose	THN08909KITM0155GH		
				SNEU 1406ANER-AM PDL025	Non-Ferrous	General Purpose	THN08909KITEL025AM		
	MB45-4000R-14T8C	4.000"	8	SNMU 1406ANER-GM PR1825	Steel	General Purpose	THN08910KITM1825GM	\$700.00	\$980.00
				SNEU 1406ANER-GM PR1825		Good Surface Finish	THN08910KITE1825GM		
				SNEU 1406ANER-SM PR1835	Stainless Steel	Stable Machining	THN08910KITE1835SM		
				SNEU 1406ANER-SM CA6535		Wear Resistance	THN08910KITE6535SM		
				SNMU 1406ANER-GH PR1810	Cast Iron	General Purpose	THN08910KITM1810GH		
				SNMU 1406ANER-GH PR0155	Hardened Material	General Purpose	THN08910KITM0155GH		
				SNEU 1406ANER-AM PDL025	Non-Ferrous	General Purpose	THN08910KITEL025AM		
MB45-5000R-14T10C	5.000"	10	SNMU 1406ANER-GM PR1825	Steel	General Purpose	THN08911KITM1825GM	\$800.00	\$1,120.00	
			SNEU 1406ANER-GM PR1825		Good Surface Finish	THN08911KITE1825GM			
			SNEU 1406ANER-SM PR1835	Stainless Steel	Stable Machining	THN08911KITE1835SM			
			SNEU 1406ANER-SM CA6535		Wear Resistance	THN08911KITE6535SM			
			SNMU 1406ANER-GH PR1810	Cast Iron	General Purpose	THN08911KITM1810GH			
			SNMU 1406ANER-GH PR0155	Hardened Material	General Purpose	THN08911KITM0155GH			
			SNEU 1406ANER-AM PDL025	Non-Ferrous	General Purpose	THN08911KITEL025AM			

MA90 MILLING KITS
MB45 MILLING KITS
TURNING KITS
CUT-OFF KITS

MB45 Extra Fine Pitch Face Mill Kits

Includes (1) Cutter and (10) Inserts

Choose your Cutter, Insert Grade, and Chipbreaker



	Pick 1 Cutter Part Number	Cutting Dia.	No. of Insert Pockets	Pick 1			Kit Part Number (Use when Ordering)	\$USD Kit Price	\$CAD Kit Price
				Insert Part Number	Material	Application			
Extra Fine Pitch Face Mills	MB45-2000R-14T5C	2.000"	5	SNMU 1406ANER-GM PR1825	Steel	General Purpose	THN08913KITM1825GM	\$500.00	\$700.00
				SNEU 1406ANER-GM PR1825		Good Surface Finish	THN08913KITE1825GM		
				SNEU 1406ANER-SM PR1835	Stainless Steel	Stable Machining	THN08913KITE1835SM		
				SNEU 1406ANER-SM CA6535		Wear Resistance	THN08913KITE6535SM		
				SNMU 1406ANER-GH PR1810	Cast Iron	General Purpose	THN08913KITM1810GH		
				SNMU 1406ANER-GH PR0155	Hardened Material	General Purpose	THN08913KITM0155GH		
				SNEU 1406ANER-AM PDL025	Non-Ferrous	General Purpose	THN08913KITELO25AM		
	MB45-2500R-14T6C	2.500"	6	SNMU 1406ANER-GM PR1825	Steel	General Purpose	THN08914KITM1825GM	\$550.00	\$770.00
				SNEU 1406ANER-GM PR1825		Good Surface Finish	THN08914KITE1825GM		
				SNEU 1406ANER-SM PR1835	Stainless Steel	Stable Machining	THN08914KITE1835SM		
				SNEU 1406ANER-SM CA6535		Wear Resistance	THN08914KITE6535SM		
				SNMU 1406ANER-GH PR1810	Cast Iron	General Purpose	THN08914KITM1810GH		
				SNMU 1406ANER-GH PR0155	Hardened Material	General Purpose	THN08914KITM0155GH		
				SNEU 1406ANER-AM PDL025	Non-Ferrous	General Purpose	THN08914KITELO25AM		
	MB45-3000R-14T8C	3.000"	8	SNMU 1406ANER-GM PR1825	Steel	General Purpose	THN08915KITM1825GM	\$600.00	\$840.00
				SNEU 1406ANER-GM PR1825		Good Surface Finish	THN08915KITE1825GM		
				SNEU 1406ANER-SM PR1835	Stainless Steel	Stable Machining	THN08915KITE1835SM		
				SNEU 1406ANER-SM CA6535		Wear Resistance	THN08915KITE6535SM		
				SNMU 1406ANER-GH PR1810	Cast Iron	General Purpose	THN08915KITM1810GH		
				SNMU 1406ANER-GH PR0155	Hardened Material	General Purpose	THN08915KITM0155GH		
				SNEU 1406ANER-AM PDL025	Non-Ferrous	General Purpose	THN08915KITELO25AM		
	MB45-4000R-14T10C	4.000"	10	SNMU 1406ANER-GM PR1825	Steel	General Purpose	THN08916KITM1825GM	\$800.00	\$1,120.00
				SNEU 1406ANER-GM PR1825		Good Surface Finish	THN08916KITE1825GM		
				SNEU 1406ANER-SM PR1835	Stainless Steel	Stable Machining	THN08916KITE1835SM		
				SNEU 1406ANER-SM CA6535		Wear Resistance	THN08916KITE6535SM		
				SNMU 1406ANER-GH PR1810	Cast Iron	General Purpose	THN08916KITM1810GH		
				SNMU 1406ANER-GH PR0155	Hardened Material	General Purpose	THN08916KITM0155GH		
				SNEU 1406ANER-AM PDL025	Non-Ferrous	General Purpose	THN08916KITELO25AM		

2024 Fall - 2025 Winter Promo Pack Offers valid through March 31, 2025

All promotional items are available exclusively through Authorized North American KYOCERA Precision Tool Distributors.

MA90 MILLING KITS

MB45 MILLING KITS

TURNING KITS

CUT-OFF KITS

MB45 End Mill Kits

Includes (1) Cutter and (10) Inserts

Choose your Cutter, Insert Grade, and Chipbreaker



	Pick 1 Cutter Part Number	Cutting Dia.	No. of Insert Pockets	Pick 1			Kit Part Number (Use when Ordering)	\$USD Kit Price	\$CAD Kit Price
				Insert Part Number	Material	Application			
End Mills	MB45-1500-S125-14T2C	1.500"	2	SNMU 1406ANER-GM PR1825	Steel	General Purpose	THN08918KITM1825GM	\$350.00	\$490.00
				SNEU 1406ANER-GM PR1825		Good Surface Finish	THN08918KITE1825GM		
				SNEU 1406ANER-SM PR1835	Stainless Steel	Stable Machining	THN08918KITE1835SM		
				SNEU 1406ANER-SM CA6535		Wear Resistance	THN08918KITE6535SM		
				SNMU 1406ANER-GH PR1810	Cast Iron	General Purpose	THN08918KITM1810GH		
				SNMU 1406ANER-GH PR0155	Hardened Material	General Purpose	THN08918KITM0155GH		
				SNEU 1406ANER-AM PDL025	Non-Ferrous	General Purpose	THN08918KITEL025AM		
	MB45-1500-S125-14T3C	1.500"	3	SNMU 1406ANER-GM PR1825	Steel	General Purpose	THN08919KITM1825GM	\$350.00	\$490.00
				SNEU 1406ANER-GM PR1825		Good Surface Finish	THN08919KITE1825GM		
				SNEU 1406ANER-SM PR1835	Stainless Steel	Stable Machining	THN08919KITE1835SM		
				SNEU 1406ANER-SM CA6535		Wear Resistance	THN08919KITE6535SM		
				SNMU 1406ANER-GH PR1810	Cast Iron	General Purpose	THN08919KITM1810GH		
				SNMU 1406ANER-GH PR0155	Hardened Material	General Purpose	THN08919KITM0155GH		
				SNEU 1406ANER-AM PDL025	Non-Ferrous	General Purpose	THN08919KITEL025AM		
	MB45-2000-S125-14T3C	2.000"	3	SNMU 1406ANER-GM PR1825	Steel	General Purpose	THN08920KITM1825GM	\$400.00	\$560.00
				SNEU 1406ANER-GM PR1825		Good Surface Finish	THN08920KITE1825GM		
				SNEU 1406ANER-SM PR1835	Stainless Steel	Stable Machining	THN08920KITE1835SM		
				SNEU 1406ANER-SM CA6535		Wear Resistance	THN08920KITE6535SM		
				SNMU 1406ANER-GH PR1810	Cast Iron	General Purpose	THN08920KITM1810GH		
				SNMU 1406ANER-GH PR0155	Hardened Material	General Purpose	THN08920KITM0155GH		
				SNEU 1406ANER-AM PDL025	Non-Ferrous	General Purpose	THN08920KITEL025AM		
	MB45-2500-S125-14T4C	2.500"	4	SNMU 1406ANER-GM PR1825	Steel	General Purpose	THN08921KITM1825GM	\$450.00	\$630.00
				SNEU 1406ANER-GM PR1825		Good Surface Finish	THN08921KITE1825GM		
				SNEU 1406ANER-SM PR1835	Stainless Steel	Stable Machining	THN08921KITE1835SM		
				SNEU 1406ANER-SM CA6535		Wear Resistance	THN08921KITE6535SM		
				SNMU 1406ANER-GH PR1810	Cast Iron	General Purpose	THN08921KITM1810GH		
				SNMU 1406ANER-GH PR0155	Hardened Material	General Purpose	THN08921KITM0155GH		
				SNEU 1406ANER-AM PDL025	Non-Ferrous	General Purpose	THN08921KITEL025AM		

MA90 MILLING KITS

MB45 MILLING KITS

TURNING KITS

CUT-OFF KITS

Versatility + Quality

Large insert lineup supports a wide variety of machining applications

Five insert designs for various machining applications

Economical inserts with 8 cutting edges

General purpose GM insert with E-Class and M-Class options based on required machining accuracy

SM (E Class) - Low Cutting Force

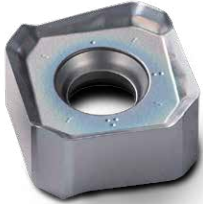

- Sharpness oriented with a low cutting force design
- -10% cutting resistance compared to general purpose GM insert
- Recommended for small machines (BT30)

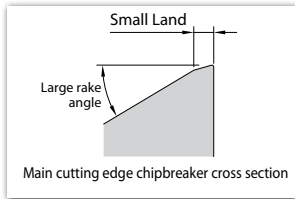

GM (E/M Class) - General

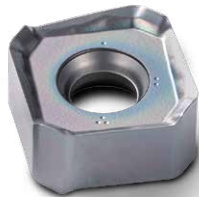

- 1st recommendation for steel machining
- Low cutting force and fracture resistance
- E-Class or M-Class selectable

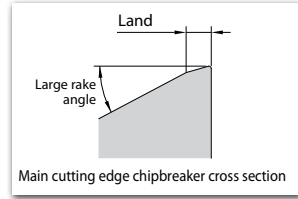

GH (M Class) - Tough Edge



- Tough cutting edge and excellent fracture resistance
- Obtuse edge design is resistant to chipping
- Recommended for intermittent machining

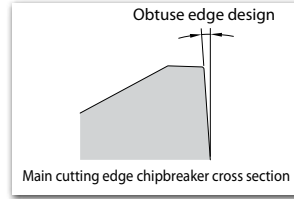

AM for Aluminum Alloys

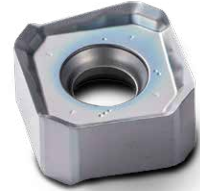



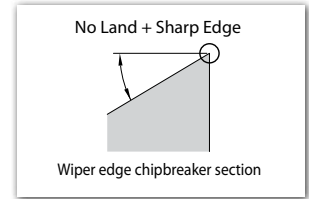



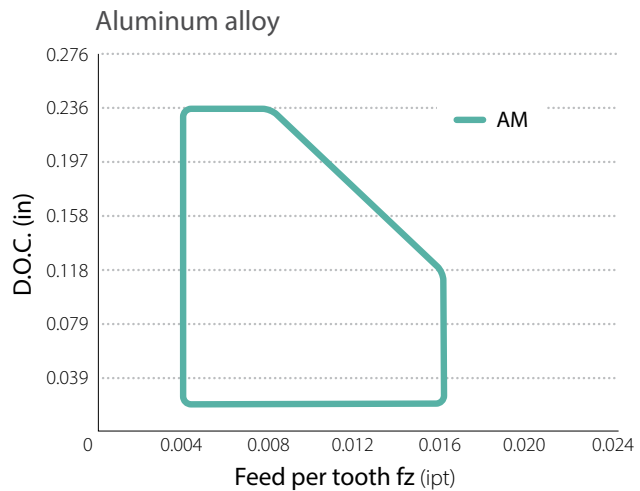
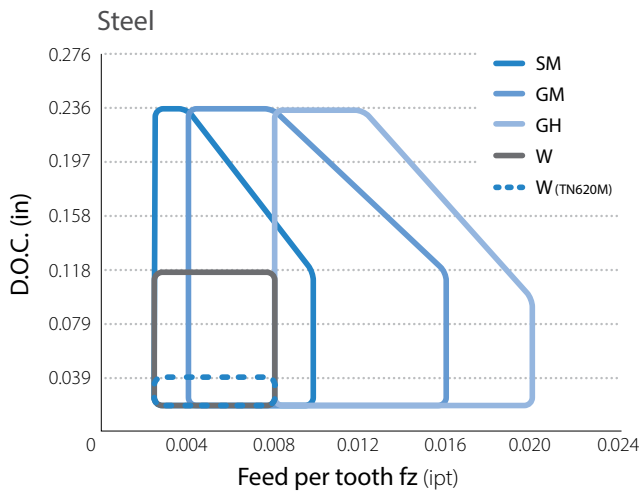

- No Land + Sharp Edge Specifications
- Excellent sharpness

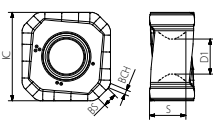

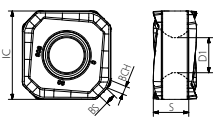
Applicable Insert Range

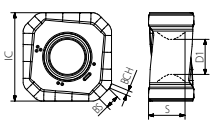
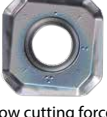
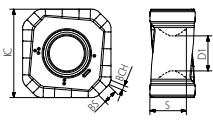

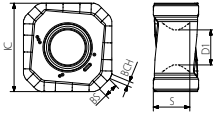
Applicable Inserts

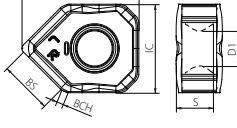
Usage Classification	P	Steel	★	☆													
		Mold steel	★	☆													
★: Roughing/ 1st recommendation	M	Austenitic stainless steel	☆	★													
		Martensitic stainless steel		☆													
☆: Roughing/ 2nd recommendation		Precipitation hardened stainless steel		★													
		Gray cast iron			★												
■: Finishing/ 1st recommendation	K	Ductile cast iron															
		Nonferrous metal															
□: Finishing/ 2nd recommendation (Hardened material is 40 HRC or less)	S	Heat resistant alloys (Ni-based heat resistant alloys)															
		Titanium alloy		★													
	H	Hardened material															
Shape	Description	Dimensions (in)							MEGACOAT NANO EX		NEW	MEGACOAT HARD	CVD Coated	Cermet	DLC Coated	Carbide	
		IC	S	BCH	BS	D1	INSL	PR1825	PR1835	PR1810		PR0155	CA6535	TN620M	PDL025	GW25	
		SNMU1406AER-GM	0.579	0.239	0.031	0.091	0.228	-	●	○	○	-	○	○	-	-	
		SNMU1406AER-GH	0.579	0.232	0.055	0.067	0.228	-	○	○	●	●	○	-	-	-	
		SNEU1406AER-GM	0.579	0.239	0.031	0.091	0.228	-	●	○	○	-	○	○	-	-	
		SNEU1406ANER-SM	0.579	0.239	0.031	0.091	0.228	-	○	●	-	-	●	-	-	-	
		SNEU1406AFR-AM	0.579	0.239	0.031	0.091	0.228	-	-	-	-	-	-	-	●	○	
		SNEU1406ANEN-W	0.579	0.242	0.043	0.346	0.228	0.764	○	○	○	-	○	○	-	-	

● : Available in Promo Kits
○ : Available to be purchased separately

New CVD Coated Carbide Grade for Steel

CA115P/CA125P

The new standard for steel machining

Longer tool life in a wide range of machining environments

Expanded lineup of chipbreakers for steel machining in various applications



View Online



Product Video



Product Brochure

Application Map

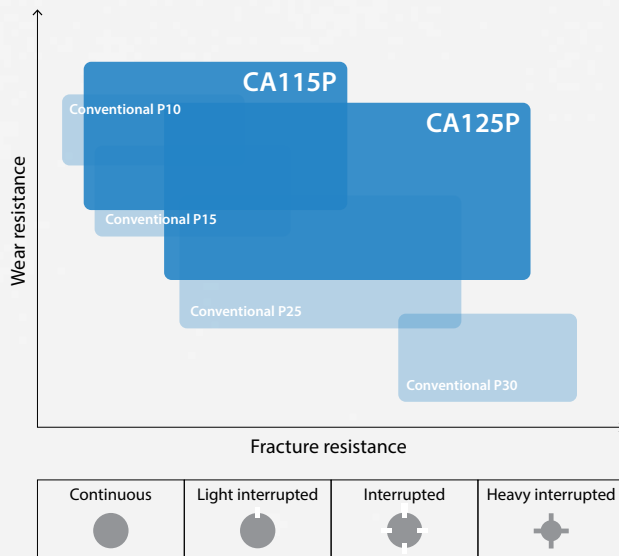

CA115P

Continuous-light interrupted machining of steel

For high-efficiency machining with wear and chipping resistance

CA125P

Continuous-heavy interrupted steel machining

First recommendation for steel machining
High versatility



MA90 MILLING KITS
MB45 MILLING KITS
TURNING KITS
CUT-OFF KITS

Advanced Technology

New coating & carbide substrate



Black & Gold

Excellent wear and fracture resistance

Innovative Layering Technology

Ultra-uniform alumina layering

Proprietary crystal forming technology

Achieving significant crystal growth uniformity and direction

Reduces crater wear and extends tool life



New Chipbreaker Design

PMG Chipbreaker for Medium-Roughing

Unique design covers a wide range of machining applications

Maintains excellent chip control

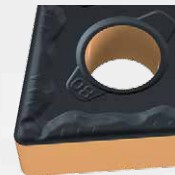

MA90 MILLING KITS

MB45 MILLING KITS

TURNING KITS

CUT-OFF KITS

For medium-roughing

PMG Chipbreaker

Covers a wide range of machining applications from medium machining to roughing
 Excellent wear resistance with low cutting force design
 Reduces chip shape inconsistencies and improves tool life

Step breaker structure

Suppresses chip entanglement during large D.O.C. machining with a gently rising surface

Circular Dot

Control chips during small D.O.C. machining

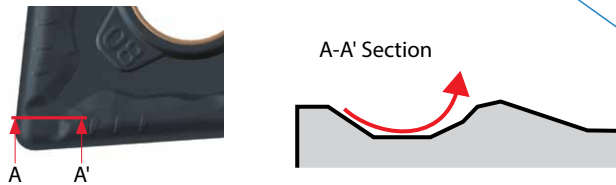

High Rake Perimeter

Low resistance design suppresses rake face temperature rise
 Reduces chipbreakers wear and chip shape changes

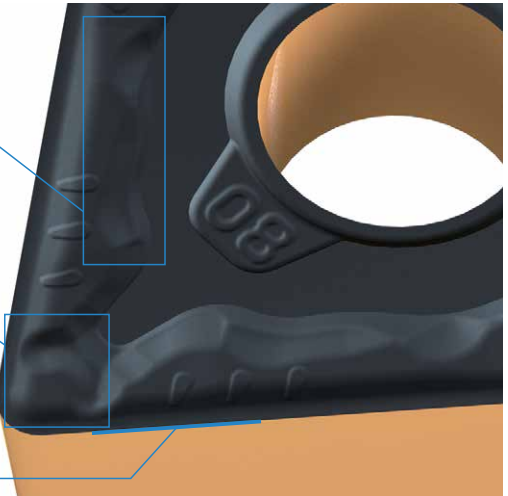

For finishing

PP Chipbreaker

For Finishing
 Low Resistance



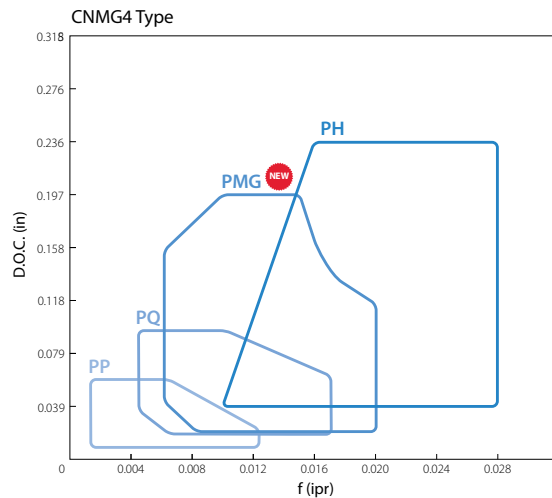

Applicable Chipbreaker Range

(D.O.C. indicates radial depth of cut)

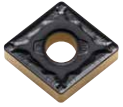
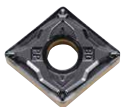
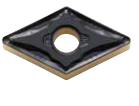
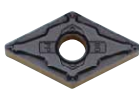
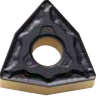

CA115P & CA125P Inserts

Usage Classification		P	Carbon Steel / Alloy Steel				★	☆
★ Continuous-Light Interrupted / 1st Choice ☆ Continuous-Heavy Interrupted / 1st Choice			Mold Steel				★	☆
Insert	Part Number	Dimensions (in)				CVD Coating	CVD Coating	
		IC	Thickness	Hole	Corner-R (RE)	CA115P	CA125P	
Medium-Roughing		CNMG 432PMG	1/2	3/16	0.203	1/32	●	●
Finishing							●	●
Medium-Roughing		DNMG 432PMG	1/2	3/16	0.203	1/32	●	●
Finishing							●	●
Medium-Roughing		WNMG 432PMG	1/2	3/16	0.203	1/32	●	●
Finishing							●	●
Finishing		VNMG 331PP	3/8	3/16	0.150	1/64	●	●

Recommended Cutting Conditions



Vc (sfm)

Insert		Low Carbon Steel Low Carbon Alloy Steel	Medium Carbon Steel Medium Carbon Alloy Steel	High Carbon Alloy Steel
		Up to 25 HRC		Up to 32 HRC
CA115P	Negative	490 ~ 980 ~ 1310		490 ~ 920 ~ 1180
	Positive	390 ~ 790 ~ 1050		360 ~ 720 ~ 950
CA125P	Negative	490 ~ 790 ~ 1050		490 ~ 720 ~ 920
	Positive	390 ~ 620 ~ 850		360 ~ 560 ~ 750

Steel Turning Kits

Includes (1) Double-Clamp Turning Toolholder and (10) Inserts

Choose your Toolholder, Insert Chipbreaker, and Insert Grade

Pick 1 Toolholder Part Number		Shank Size (Square)	Overall Length	Insert	Pick 1 Chipbreaker	Pick 1 Grade	Kit Part Number (Use when Ordering)	\$USD Kit Price	\$CAD Kit Price
 <p>DCLN... Double-Clamp Turning Holder</p>	DCLNR 12-4B	0.750"	4.500"	CNMG432	PMG	CA115P	THC89560KITMGCA115	\$120.00	\$170.00
						CA125P	THC89560KITMGCA125		
					PP	CA115P	THC89560KITPPCA115		
						CA125P	THC89560KITPPCA125		
					PMG	CA115P	THC89600KITMGCA115		
						CA125P	THC89600KITMGCA125		
	DCLNR 16-4D	1.000"	6.000"		PMG	CA115P	THC89561KITMGCA115		
						CA125P	THC89561KITMGCA125		
					PP	CA115P	THC89561KITPPCA115		
						CA125P	THC89561KITPPCA125		
					PMG	CA115P	THC89601KITMGCA115		
						CA125P	THC89601KITMGCA125		
PP	CA115P	THC89601KITPPCA115							
	CA125P	THC89601KITPPCA125							
 <p>DDJN... Double-Clamp Turning Holder</p>	DDJNR 12-4B	0.750"	4.500"	DNMG432	PMG	CA115P	THC89568KITMGCA115	\$140.00	\$200.00
						CA125P	THC89568KITMGCA125		
					PP	CA115P	THC89568KITPPCA115		
						CA125P	THC89568KITPPCA125		
	PMG	CA115P	THC89608KITMGCA115						
		CA125P	THC89608KITMGCA125						
	PP	CA115P	THC89608KITPPCA115						
		CA125P	THC89608KITPPCA125						
	DDJNR 16-4D	1.000"	6.000"		PMG	CA115P	THC89569KITMGCA115		
						CA125P	THC89569KITMGCA125		
					PP	CA115P	THC89569KITPPCA115		
						CA125P	THC89569KITPPCA125		
DDJNL 16-4D	1.000"	6.000"	PMG	CA115P	THC89609KITMGCA115				
				CA125P	THC89609KITMGCA125				
			PP	CA115P	THC89609KITPPCA115				
				CA125P	THC89609KITPPCA125				

2024 Fall - 2025 Winter Promo Pack Offers valid through March 31, 2025

All promotional items are available exclusively through Authorized North American KYOCERA Precision Tool Distributors.

Steel Turning Kits

Includes (1) Double-Clamp Turning Toolholder and (10) Inserts

Choose your Toolholder, Insert Chipbreaker, and Insert Grade

Pick 1 Toolholder Part Number		Shank Size (Square)	Overall Length	Insert	Pick 1 Chipbreaker	Pick 1 Grade	Kit Part Number (Use when Ordering)	\$USD Kit Price	\$CAD Kit Price
 <p>DWLN... Double-Clamp Turning Holder</p>	DWLNR 12-4B	0.750"	4.500"	WNMG432	PMG	CA115P	THC89590KITMGCA115	\$120.00	\$170.00
						CA125P	THC89590KITMGCA125		
					PP	CA115P	THC89590KITPPCA115		
						CA125P	THC89590KITPPCA125		
	PMG	CA115P	THC89630KITMGCA115						
		CA125P	THC89630KITMGCA125						
	PP	CA115P	THC89630KITPPCA115						
		CA125P	THC89630KITPPCA125						
	DWLNR 16-4D	1.000"	6.000"		PMG	CA115P	THC89592KITMGCA115		
						CA125P	THC89592KITMGCA125		
					PP	CA115P	THC89592KITPPCA115		
						CA125P	THC89592KITPPCA125		
DWLNL 16-4D	1.000"	6.000"	PMG	CA115P	THC89632KITMGCA115				
				CA125P	THC89632KITMGCA125				
			PP	CA115P	THC89632KITPPCA115				
				CA125P	THC89632KITPPCA125				
 <p>DVJN... Double-Clamp Turning Holder</p>	DVJNR 12-3B	0.750"	4.500"	VNMG331	PP	CA115P	THC89585KITPPCA115	\$140.00	\$200.00
						CA125P	THC89585KITPPCA125		
	DVJNL 12-3B	0.750"	4.500"		PP	CA115P	THC89625KITPPCA115		
						CA125P	THC89625KITPPCA125		
	DVJNR 16-3D	1.000"	6.000"		PP	CA115P	THC89586KITPPCA115		
						CA125P	THC89586KITPPCA125		
	DVJNL 16-3D	1.000"	6.000"		PP	CA115P	THC89626KITPPCA115		
						CA125P	THC89626KITPPCA125		

MA90 MILLING KITS

MB45 MILLING KITS

TURNING KITS

CUT-OFF KITS

PVD Coating for Heat-Resistant Alloy

PR115S/PR120S NEW



View Online



Product Video



Product Brochure

Unique carbide substrate with excellent heat-resistant properties and new coating technology “MEGACOAT TOUGH” provides longer tool life for heat-resistant alloy machining. Low cutting force and stable machining with specialized chipbreakers.

PR115S

Covers a wide range of difficult-to-cut material machining applications
1st recommendation for continuous finishing of heat-resistant alloys

PR120S

Long tool life and stable machining in interrupted machining of heat-resistant alloys
1st recommendation for continuous finishing to light interrupted machining of stainless steel
Longer tool life extension possible for stainless steel machining

S Heat-Resistant Alloys Application map

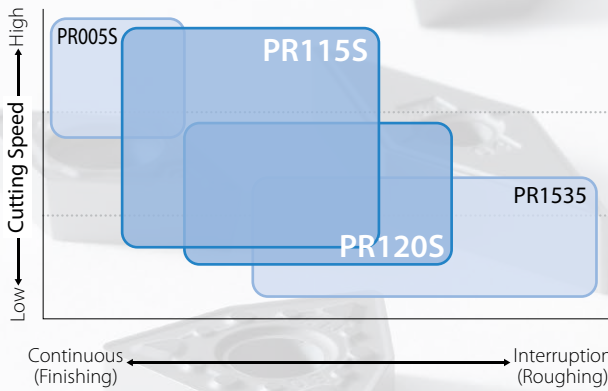

M Stainless Steel Application map

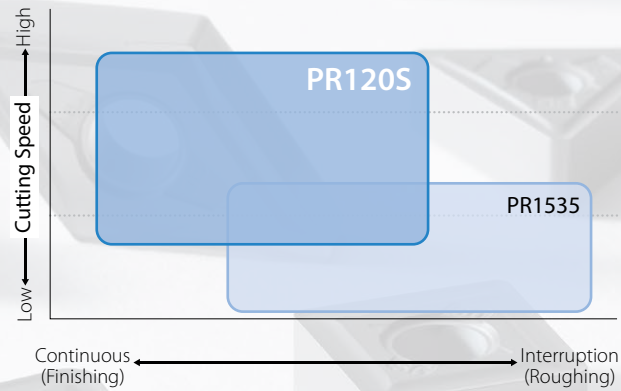

Applicable Chipbreaker Range (D.O.C. Indicates radial depth of cut per side)

Heat-Resistant Alloys

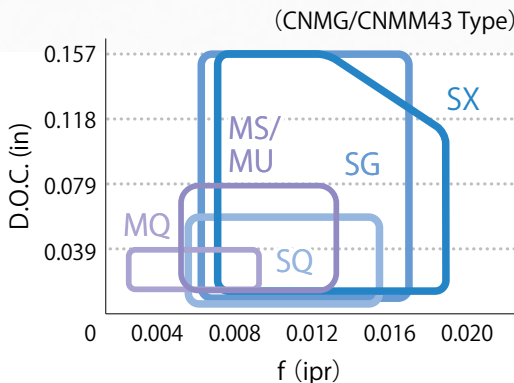



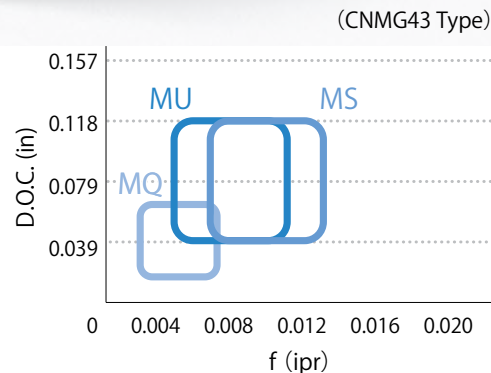









Stainless Steel

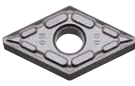

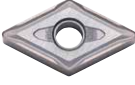
2024 Fall - 2025 Winter Promo Pack Offers valid through March 31, 2025

All promotional items are available exclusively through Authorized North American KYOCERA Precision Tool Distributors.

MA90 MILLING KITS
MB45 MILLING KITS
TURNING KITS
CUT-OFF KITS



PR115S & PR120S Inserts								
Usage Classification								
★ 1st Choice ☆ 2nd Choice	M	Stainless Steel					☆	★
	S	Heat-Resistant Alloy					★	☆
Insert	Part Number	Dimensions (in)				PVD Coating		
		IC	Thickness	Hole	Corner-R (RE)	PR115S	PR120S	
Finishing-Medium	 CNMG 432MQ	1/2	3/16	0.203	1/32	●	●	
Medium-Roughing	 CNMG 432MS					●	●	
Roughing	 CNMG 432SG					●	●	
Finishing-Medium	 CNMG432SQ					●	●	
Finishing-Medium	 DNMG 432MQ	1/2	3/16	0.203	1/32	●	●	
Medium-Roughing	 DNMG 432MS					●	●	
Roughing	 DNMG 432SG					●	●	
Finishing-Medium	 DNMG 432SQ					●	●	
Finishing-Medium	 WNMG 432MQ	1/2	3/16	0.203	1/32	●	●	
Medium-Roughing	 WNMG 432MS					●	●	
Roughing	 WNMG 432SG					●	●	
Finishing-Medium	 VNMG331 MQ	3/8	3/16	0.150	1/64	●	●	
Medium-Roughing	 VNMG331 MS					●	●	

MA90 MILLING KITS
MB45 MILLING KITS
TURNING KITS
CUT-OFF KITS

Stainless & Heat-Resistant Alloy Turning Kits

Includes (1) Double-Clamp Turning Toolholder and (10) Inserts

Choose your Toolholder, Insert Chipbreaker, and Insert Grade

Pick 1 Toolholder Part Number		Shank Size (Square)	Overall Length	Pick 1 Insert	Pick 1 Chipbreaker	Grade	Kit Part Number (Use when Ordering)	\$USD Kit Price	\$CAD Kit Price	
 <p>DCLN... Double-Clamp Turning Holder</p>	DCLNR 12-4B	0.750"	4.500"	CNMG432	MQ	PR115S	THC89560KITMQPR115	\$120.00	\$170.00	
						PR120S	THC89560KITMQPR120			
						MS	PR115S			THC89560KITMSPR115
							PR120S			THC89560KITMSPR120
						SG	PR115S			THC89560KITSGPR115
							PR120S			THC89560KITSGPR120
	SQ	PR115S	THC89560KITSQPR115							
		PR120S	THC89560KITSQPR120							
	DCLNL 12-4B	0.750"	4.500"		MQ	PR115S	THC89600KITMQPR115			
						PR120S	THC89600KITMQPR120			
						MS	PR115S			THC89600KITMSPR115
							PR120S			THC89600KITMSPR120
						SG	PR115S			THC89600KITSGPR115
							PR120S			THC89600KITSGPR120
	SQ	PR115S	THC89600KITSQPR115							
		PR120S	THC89600KITSQPR120							
	DCLNR 16-4D	1.000"	6.000"		MQ	PR115S	THC89561KITMQPR115			
						PR120S	THC89561KITMQPR120			
MS				PR115S		THC89561KITMSPR115				
				PR120S		THC89561KITMSPR120				
SG				PR115S		THC89561KITSGPR115				
				PR120S		THC89561KITSGPR120				
SQ	PR115S	THC89561KITSQPR115								
	PR120S	THC89561KITSQPR120								
DCLNL 16-4D	1.000"	6.000"	MQ	PR115S	THC89601KITMQPR115					
				PR120S	THC89601KITMQPR120					
				MS	PR115S	THC89601KITMSPR115				
					PR120S	THC89601KITMSPR120				
				SG	PR115S	THC89601KITSGPR115				
					PR120S	THC89601KITSGPR120				
SQ	PR115S	THC89601KITSQPR115								
	PR120S	THC89601KITSQPR120								
 <p>DDJN... Double-Clamp Turning Holder</p>	DDJNR 12-4B	0.750"	4.500"	DNMG432	MQ	PR115S	THC89568KITMQPR115	\$140.00	\$200.00	
						PR120S	THC89568KITMQPR120			
						MS	PR115S			THC89568KITMSPR115
							PR120S			THC89568KITMSPR120
						SG	PR115S			THC89568KITSGPR115
							PR120S			THC89568KITSGPR120
	SQ	PR115S	THC89568KITSQPR115							
		PR120S	THC89568KITSQPR120							
	DDJNL 12-4B	0.750"	4.500"		MQ	PR115S	THC89608KITMQPR115			
						PR120S	THC89608KITMQPR120			
						MS	PR115S			THC89608KITMSPR115
							PR120S			THC89608KITMSPR120
						SG	PR115S			THC89608KITSGPR115
							PR120S			THC89608KITSGPR120
	SQ	PR115S	THC89608KITSQPR115							
		PR120S	THC89608KITSQPR120							
	DDJNR 16-4D	1.000"	6.000"		MQ	PR115S	THC89569KITMQPR115			
						PR120S	THC89569KITMQPR120			
MS				PR115S		THC89569KITMSPR115				
				PR120S		THC89569KITMSPR120				
SG				PR115S		THC89569KITSGPR115				
				PR120S		THC89569KITSGPR120				
SQ	PR115S	THC89569KITSQPR115								
	PR120S	THC89569KITSQPR120								
DDJNL 16-4D	1.000"	6.000"	MQ	PR115S	THC89609KITMQPR115					
				PR120S	THC89609KITMQPR120					
				MS	PR115S	THC89609KITMSPR115				
					PR120S	THC89609KITMSPR120				
				SG	PR115S	THC89609KITSGPR115				
					PR120S	THC89609KITSGPR120				
SQ	PR115S	THC89609KITSQPR115								
	PR120S	THC89609KITSQPR120								

2024 Fall - 2025 Winter Promo Pack Offers valid through March 31, 2025



All promotional items are available exclusively through Authorized North American KYOCERA Precision Tool Distributors.

MA90 MILLING KITS
MB45 MILLING KITS
TURNING KITS
CUT-OFF KITS

Stainless & Heat-Resistant Alloy Turning Kits

Includes (1) Double-Clamp Turning Toolholder and (10) Inserts

Choose your Toolholder, Insert Chipbreaker, and Insert Grade

Pick 1 Toolholder Part Number		Shank Size (Square)	Overall Length	Pick 1 Insert	Pick 1 Chipbreaker	Grade	Kit Part Number (Use when Ordering)	\$USD Kit Price	\$CAD Kit Price			
 <p>DWLN... Double-Clamp Turning Holder</p>	DWLNR 12-4B	0.750"	4.500"	WNMG432	MQ	PR115S	THC89590KITMQPR115	\$120.00	\$170.00			
						PR120S	THC89590KITMQPR120					
					MS	PR115S	THC89590KITMSPR115					
						PR120S	THC89590KITMSPR120					
					SG	PR115S	THC89590KITSGPR115					
						PR120S	THC89590KITSGPR120					
	DWLNR 16-4D	MQ	1.000"		6.000"	PR115S	THC89630KITMQPR115					
						PR120S	THC89630KITMQPR120					
		MS				PR115S	THC89630KITMSPR115					
						PR120S	THC89630KITMSPR120					
		SG				PR115S	THC89630KITSGPR115					
						PR120S	THC89630KITSGPR120					
		DWLNL 12-4B				MQ	0.750"			4.500"	PR115S	THC89630KITMQPR115
											PR120S	THC89630KITMQPR120
MS	PR115S		THC89630KITMSPR115									
	PR120S		THC89630KITMSPR120									
SG	PR115S		THC89630KITSGPR115									
	PR120S		THC89630KITSGPR120									
 <p>DVJN... Double-Clamp Turning Holder</p>	DVJNR 12-3B	0.750"	4.500"	VNMG331	MQ	PR115S	THC89585KITMQPR115	\$140.00	\$200.00			
						PR120S	THC89585KITMQPR120					
					MS	PR115S	THC89585KITMSPR115					
						PR120S	THC89585KITMSPR120					
	SG	PR115S	THC89585KITSGPR115									
		PR120S	THC89585KITSGPR120									
	DVJNR 16-3D	MQ	1.000"		6.000"	PR115S	THC89625KITMQPR115					
						PR120S	THC89625KITMQPR120					
		MS				PR115S	THC89625KITMSPR115					
						PR120S	THC89625KITMSPR120					
SG		PR115S		THC89625KITSGPR115								
		PR120S		THC89625KITSGPR120								
DVJNL 12-3B	MQ	0.750"	4.500"	PR115S	THC89626KITMQPR115							
				PR120S	THC89626KITMQPR120							
	MS			PR115S	THC89626KITMSPR115							
				PR120S	THC89626KITMSPR120							
SG	PR115S	THC89626KITSGPR115										
	PR120S	THC89626KITSGPR120										
DVJNL 16-3D	MQ	1.000"	6.000"	PR115S	THC89626KITMQPR115							
				PR120S	THC89626KITMQPR120							
	MS			PR115S	THC89626KITMSPR115							
				PR120S	THC89626KITMSPR120							
SG	PR115S	THC89626KITSGPR115										
	PR120S	THC89626KITSGPR120										

MA90 MILLING KITS

MB45 MILLING KITS

TURNING KITS

CUT-OFF KITS

Cut-Off Solutions for Small Parts Machining

KGZ NEW



View Online



Product Video



Product Brochure

Provides stable machining and is easy to use with unique clamp design

New coating PR20 series provides longer tool life and supports a wide range of applications

Stable machining with sturdy clamp design

- Greater chatter resistance provides excellent surface finish and stable tool life
- Toolholder durability reduces down-time and cuts cost
- Supports high efficiency machining and reduces cycle time

Easy insert management

- Fast and secure insert installation
- Inserts are more resistant to wear and reduce the frequency of tool changes



Toolholder Sturdy clamps

Three unique features

1. Gap section
Tapered slit

2. Top clamp
Pulls insert down and back

3. Stopper
Obtuse angle stopper

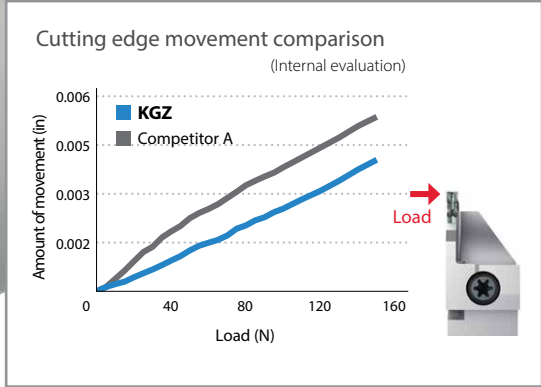

MA90 MILLING KITS

MB45 MILLING KITS

TURNING KITS

CUT-OFF KITS

Insert Ease insert installation

Top V Shape Different groove angles at ends and center

Groove End

Small groove angle on top of insert

These grooves prevent the insert from shifting and provide fast and accurate insert mounts

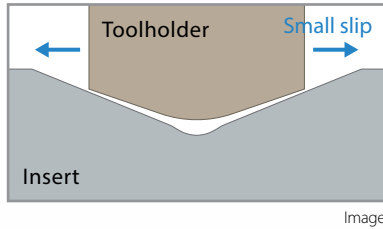

Center of groove

Large groove angle on top of insert

Firmly engages the toolholder to increase hold

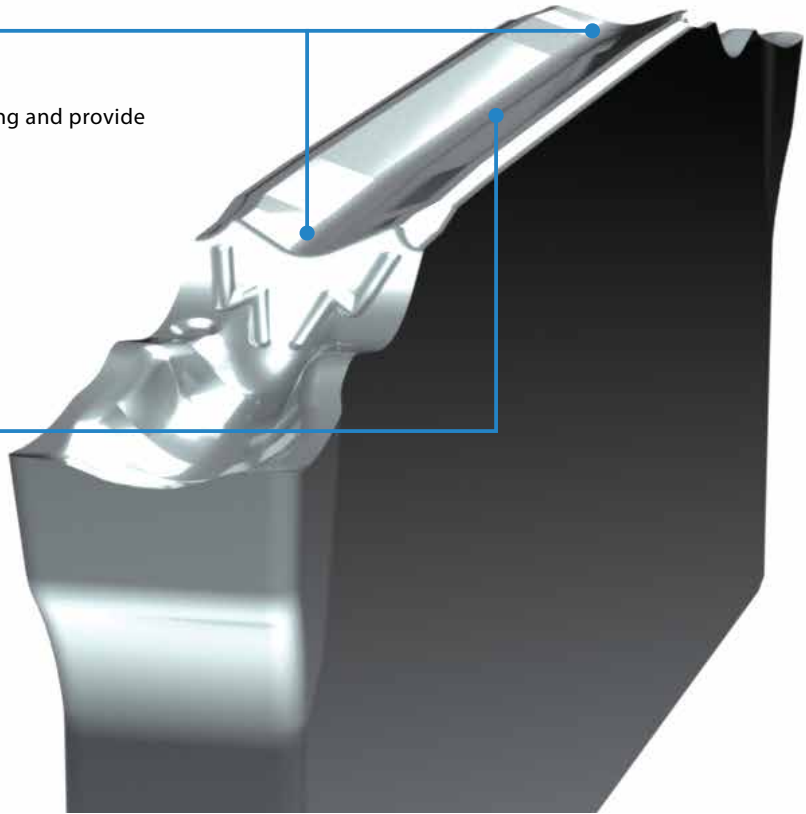
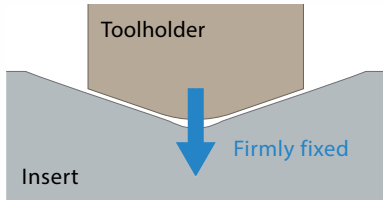

New insert grades for grooving and cut-off solutions

PR20 Series

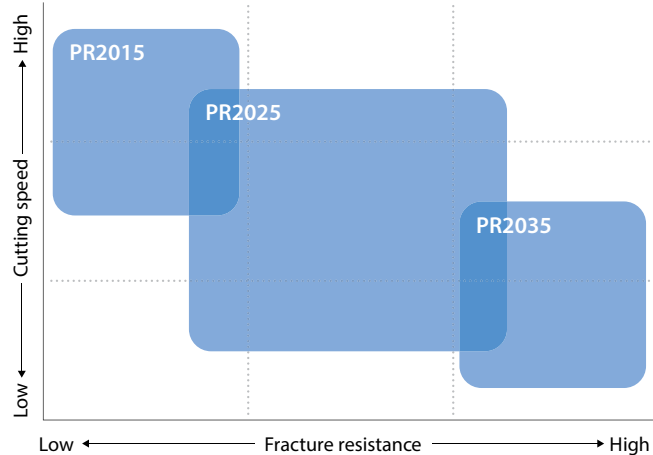

- PR2015** 1st recommendation for cast iron
Also available for steel and stainless steel
- PR2025** 1st recommendation for steel
Also available for stainless steel
- PR2035** 1st recommendation for stainless steel
Also available for steel

Insert CW : 0.051" - 0.118"	Low feed PF	Medium feed PM	High feed PH	Low cutting force PG	PVD coating P M K PR2015 / PR2025 / PR2035 NEW
					DLC coating N Non-coated carbide K N PDL025 GW15

Toolholder Styles	Internal coolant JCTM Series for direct coolant	External coolant Standard type / for Sub-spindle tooling
--------------------------	---	--

KGZ (Standard Toolholder) Kits

Includes (1) Toolholder and (10) Inserts

Choose your Toolholder and Insert



Cutting Width (CW)	Pick 1 Toolholder	Hand	Shank Size (Square)	CUTDIA	Pick 1 Insert	Insert Lead Angle	Application	Grade	Kit Part Number (Use when Ordering)	\$USD Kit Price	\$CAD Kit Price
0.0591" (1.5mm)	KGZL 8-1.5JX	Left	0.500"	0.945"	GZM1516L-003PF-15D	15° Left-Hand	Low Feed	PR2035	THC89890KIT1_15L35	\$175.00	\$250.00
					GZM1516N-015PF	Neutral	Low Feed		THC89890KIT2_15N35		
	KGZR 8-1.5JX	Right	0.500"	0.945"	GZM1516R-015PF-15D	15° Right-Hand	Low Feed		THC89889KIT3_15R35		
					GZM1516N-015PF	Neutral	Low Feed		THC89889KIT4_15N35		
0.079" (2.00mm)	KGZL 8-2JX	Left	0.500"	0.945"	GZM2020N-015PF	Neutral	Low Feed	PR2035	THC89894KIT1_20N35	\$175.00	\$250.00
					GZM2020N-020PH	Neutral	High Feed		THC89894KIT2_20N35		
					GZM2020N-020PM	Neutral	Medium Feed		THC89894KIT3_20N35		
					GZM2020R-015PF-15D	15° Right-Hand	Low Feed		THC89894KIT4_20R35		
	KGZR 8-2JX	Right	0.500"	0.945"	GZM2020N-015PF	Neutral	Low Feed	PR2035	THC89893KIT1_20N35	\$175.00	\$250.00
					GZM2020N-020PH	Neutral	High Feed		THC89893KIT2_20N35		
					GZM2020N-020PM	Neutral	Medium Feed		THC89893KIT3_20N35		
					GZM2020R-015PF-15D	15° Right-Hand	Low Feed		THC89893KIT4_20R35		
	KGZL 10-2JX	Left	0.625"	1.260"	GZM2020N-015PF	Neutral	Low Feed	PR2035	THC89896KIT1_20N35	\$175.00	\$250.00
					GZM2020N-020PH	Neutral	High Feed		THC89896KIT2_20N35		
					GZM2020N-020PM	Neutral	Medium Feed		THC89896KIT3_20N35		
					GZM2020R-015PF-15D	15° Right-Hand	Low Feed		THC89896KIT4_20R35		
	KGZR 10-2JX	Right	0.625"	1.260"	GZM2020N-015PF	Neutral	Low Feed	PR2035	THC89895KIT1_20N35	\$175.00	\$250.00
					GZM2020N-020PH	Neutral	High Feed		THC89895KIT2_20N35		
					GZM2020N-020PM	Neutral	Medium Feed		THC89895KIT3_20N35		
					GZM2020R-015PF-15D	15° Right-Hand	Low Feed		THC89895KIT4_20R35		
0.118" (3.00mm)	KGZL 8-3JX	Left	0.500"	0.945"	GZM3020N-015PF	Neutral	Low Feed	PR2035	THC89904KIT1_30N35	\$175.00	\$250.00
					GZM3020N-025PM	Neutral	Medium Feed		THC89904KIT2_30N35		
					GZM3020N-030PH	Neutral	High Feed		THC89904KIT3_30N35		
					GZM3020R-015PF-15D	15° Right-Hand	Low Feed		THC89904KIT4_30R35		
	KGZR 8-3JX	Right	0.500"	0.945"	GZM3020N-015PF	Neutral	Low Feed	PR2035	THC89903KIT1_30N35	\$175.00	\$250.00
					GZM3020N-025PM	Neutral	Medium Feed		THC89903KIT2_30N35		
					GZM3020N-030PH	Neutral	High Feed		THC89903KIT3_30N35		
					GZM3020R-015PF-15D	15° Right-Hand	Low Feed		THC89903KIT4_30R35		
	KGZL 10-3JX	Left	0.625"	1.260"	GZM3020N-015PF	Neutral	Low Feed	PR2035	THC89906KIT1_30N35	\$175.00	\$250.00
					GZM3020N-025PM	Neutral	Medium Feed		THC89906KIT2_30N35		
					GZM3020N-030PH	Neutral	High Feed		THC89906KIT3_30N35		
					GZM3020R-015PF-15D	15° Right-Hand	Low Feed		THC89906KIT4_30R35		
	KGZR 10-3JX	Right	0.625"	1.260"	GZM3020N-015PF	Neutral	Low Feed	PR2035	THC89905KIT1_30N35	\$175.00	\$250.00
					GZM3020N-025PM	Neutral	Medium Feed		THC89905KIT2_30N35		
					GZM3020N-030PH	Neutral	High Feed		THC89905KIT3_30N35		
					GZM3020R-015PF-15D	15° Right-Hand	Low Feed		THC89905KIT4_30R35		

2024 Fall - 2025 Winter Promo Pack Offers valid through March 31, 2025

All promotional items are available exclusively through Authorized North American KYOCERA Precision Tool Distributors.

KGZ-JCTM (Jet Coolant-Through) Kits

Includes (1) Toolholder and (10) Inserts

Choose your Toolholder and Insert



Cutting Width (CW)	Pick 1 Toolholder	Hand	Shank Size (Square)	CUTDIA	Pick 1 Insert	Insert Lead Angle	Application	Grade	Kit Part Number (Use when Ordering)	\$USD Kit Price	\$CAD Kit Price
0.079" (2.00mm)	KGZL 8-2JCTM	Left	0.500"	0.945"	GZM2020N-015PF	Neutral	Low Feed	PR2035	THC89926KIT1_20N35	\$195.00	\$280.00
					GZM2020N-020PH	Neutral	High Feed		THC89926KIT2_20N35		
					GZM2020N-020PM	Neutral	Medium Feed		THC89926KIT3_20N35		
					GZM2020R-015PF-15D	15° Right-Hand	Low Feed		THC89926KIT4_20R35		
	KGZR 8-2JCTM	Right	0.500"	0.945"	GZM2020N-015PF	Neutral	Low Feed	PR2035	THC89925KIT1_20N35	\$195.00	\$280.00
					GZM2020N-020PH	Neutral	High Feed		THC89925KIT2_20N35		
					GZM2020N-020PM	Neutral	Medium Feed		THC89925KIT3_20N35		
					GZM2020R-015PF-15D	15° Right-Hand	Low Feed		THC89925KIT4_20R35		
	KGZL 10-2JCTM	Left	0.625"	1.260"	GZM2020N-015PF	Neutral	Low Feed	PR2035	THC89928KIT1_20N35	\$195.00	\$280.00
					GZM2020N-020PH	Neutral	High Feed		THC89928KIT2_20N35		
					GZM2020N-020PM	Neutral	Medium Feed		THC89928KIT3_20N35		
					GZM2020R-015PF-15D	15° Right-Hand	Low Feed		THC89928KIT4_20R35		
	KGZR 10-2JCTM	Right	0.625"	1.260"	GZM2020N-015PF	Neutral	Low Feed	PR2035	THC89927KIT1_20N35	\$195.00	\$280.00
					GZM2020N-020PH	Neutral	High Feed		THC89927KIT2_20N35		
					GZM2020N-020PM	Neutral	Medium Feed		THC89927KIT3_20N35		
					GZM2020R-015PF-15D	15° Right-Hand	Low Feed		THC89927KIT4_20R35		
0.118" (3.00mm)	KGZL 8-3JCTM	Left	0.500"	0.945"	GZM3020N-015PF	Neutral	Low Feed	PR2035	THC89934KIT1_30N35	\$195.00	\$280.00
					GZM3020N-025PM	Neutral	Medium Feed		THC89934KIT2_30N35		
					GZM3020N-030PH	Neutral	High Feed		THC89934KIT3_30N35		
					GZM3020R-015PF-15D	15° Right-Hand	Low Feed		THC89934KIT4_30R35		
	KGZR 8-3JCTM	Right	0.500"	0.945"	GZM3020N-015PF	Neutral	Low Feed	PR2035	THC89933KIT1_30N35	\$195.00	\$280.00
					GZM3020N-025PM	Neutral	Medium Feed		THC89933KIT2_30N35		
					GZM3020N-030PH	Neutral	High Feed		THC89933KIT3_30N35		
					GZM3020R-015PF-15D	15° Right-Hand	Low Feed		THC89933KIT4_30R35		
	KGZL 10-3JCTM	Left	0.625"	1.260"	GZM3020N-015PF	Neutral	Low Feed	PR2035	THC89936KIT1_30N35	\$195.00	\$280.00
					GZM3020N-025PM	Neutral	Medium Feed		THC89936KIT2_30N35		
					GZM3020N-030PH	Neutral	High Feed		THC89936KIT3_30N35		
					GZM3020R-015PF-15D	15° Right-Hand	Low Feed		THC89936KIT4_30R35		
	KGZR 10-3JCTM	Right	0.625"	1.260"	GZM3020N-015PF	Neutral	Low Feed	PR2035	THC89935KIT1_30N35	\$195.00	\$280.00
					GZM3020N-025PM	Neutral	Medium Feed		THC89935KIT2_30N35		
					GZM3020N-030PH	Neutral	High Feed		THC89935KIT3_30N35		
					GZM3020R-015PF-15D	15° Right-Hand	Low Feed		THC89935KIT4_30R35		









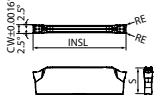

MA90 MILLING KITS

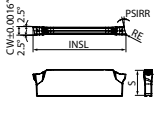
MB45 MILLING KITS

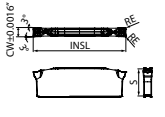
TURNING KITS

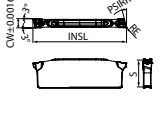
CUT-OFF KITS

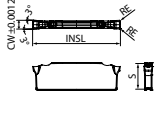
GZM Inserts

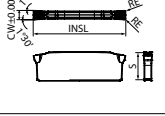
Shape	Description	No. of Edges	Dimensions (mm)						Angle	MEGACOAT NANO EX		
			CW			S	RE	INSL	PSIR $\frac{R}{L}$	PR2035		
			inch	mm	Tolerance							
Handed insert shows Right-hand												
Low Feed			GZM 1516N-015PF	2	0.059	1.5	+0.0016" -0.0016"	4.4	0.15	16	-	●
			GZM 1516L-003PF-15D	2	0.059	1.5	+0.0016" -0.0016"	4.4	0.03	16	15°	●
			1516R-015PF-15D						0.15			●
			GZM 2020N-015PF	2	0.079	2	+0.0016" -0.0016"	5.9	0.15	20	-	●
3020N-015PF			0.118		3	●						
		GZM 2020R-015PF-15D	2	0.079	2	+0.0016" -0.0016"	5.9	0.15	20	15°	●	
		3020R-015PF-15D		0.118	3						●	
Medium Feed			GZM 2020N-020PM	2	0.079	2	+0.0012" -0.0012"	5.9	0.2	20	-	●
			3020N-025PM		0.118	3	+0.0012" -0.0012"		0.25			●
High Feed			GZM 2020N-020PH	2	0.079	2	+0.0012" -0.0012"	5.9	0.2	20	-	●
			3020N-030PH		0.118	3			0.3			●

Using PF or PM chipbreaker for grooving will not create a flat bottom.

●: Standard Stock

Recommended Cutting Conditions ★1st recommendation ☆2nd recommendation

Workpiece	Vc (sfm)	f (ipr)								Notes
		PF (RE = 0.0012")			PF (RE = 0.0059")			PM	PH	
		CW								
MEGACOAT NANO EX	PR2035	0.051"~0.059" (1.3mm~1.5mm)	0.079" (2mm)	0.098"~0.118" (2.5mm~3.0mm)	0.051~0.059 (1.3mm~1.5mm)	0.079" (2mm)	0.098"~0.118" (2.5mm~3.0mm)	0.079~0.118" (2mm~3mm)	0.079~0.118" (2mm~3mm)	
Carbon Steel	230~490	0.0004~0.0016	0.0008~0.0024	0.0008~0.0031	0.0004~0.002	0.0012~0.0031	0.0016~0.0031	0.0020~0.0059	0.0039~0.0079	Wet
Alloy Steel	230~490									
Stainless Steel	200~390	0.0004~0.0012	0.0004~0.0016	0.0004~0.0020	0.0004~0.0016	0.0012~0.0028	0.0016~0.0031	0.0016~0.0047	0.0031~0.0063	



KYOCERA Precision Tools
238 Marc Drive
Cuyahoga Falls, OH 44223



COMPLETE METALWORKING SOLUTIONS

(800) 991-4225

www.ahbinc.com
ISO Certified
customerservice@ahbinc.com



©KYOCERA Precision Tools
10/2024