

# AHB

**TOOLING & MACHINERY**

**COMPLETE METALWORKING SOLUTIONS**

(800) 991-4225

[www.ahbinc.com](http://www.ahbinc.com)

ISO Certified

[customerservice@ahbinc.com](mailto:customerservice@ahbinc.com)

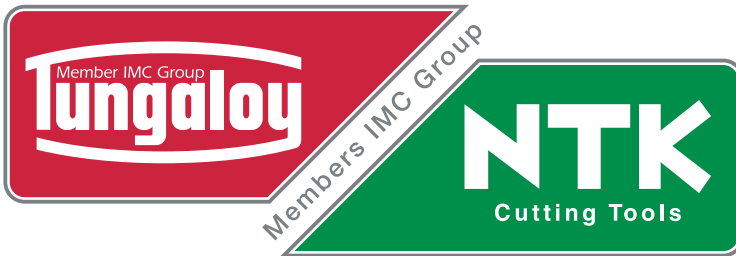

# PROMOTIONS

*Valid from January 1st to June 30th, 2026*

## 1st half 2026

Updated Offers Inside:  
TungMeister and  
DrillMeister!



# T6200 SERIES

Valid from January 1st to June 30th, 2026



## HIGH-PERFORMANCE GRADE SERIES FOR STAINLESS STEEL TURNING

T6215 and T6225 feature a thick, high-adhesion Al<sub>2</sub>O<sub>3</sub> coating with a hardened outer layer, delivering superior wear resistance and long tool life

**BUY 30 inserts**  
AND  
**GET 10 corresponding inserts**

**FREE of charge!**  
Promo Code: T6259

\*Offer must be ordered through our Customer Service Team, not available on Webshop.

Inserts:  
ISO type

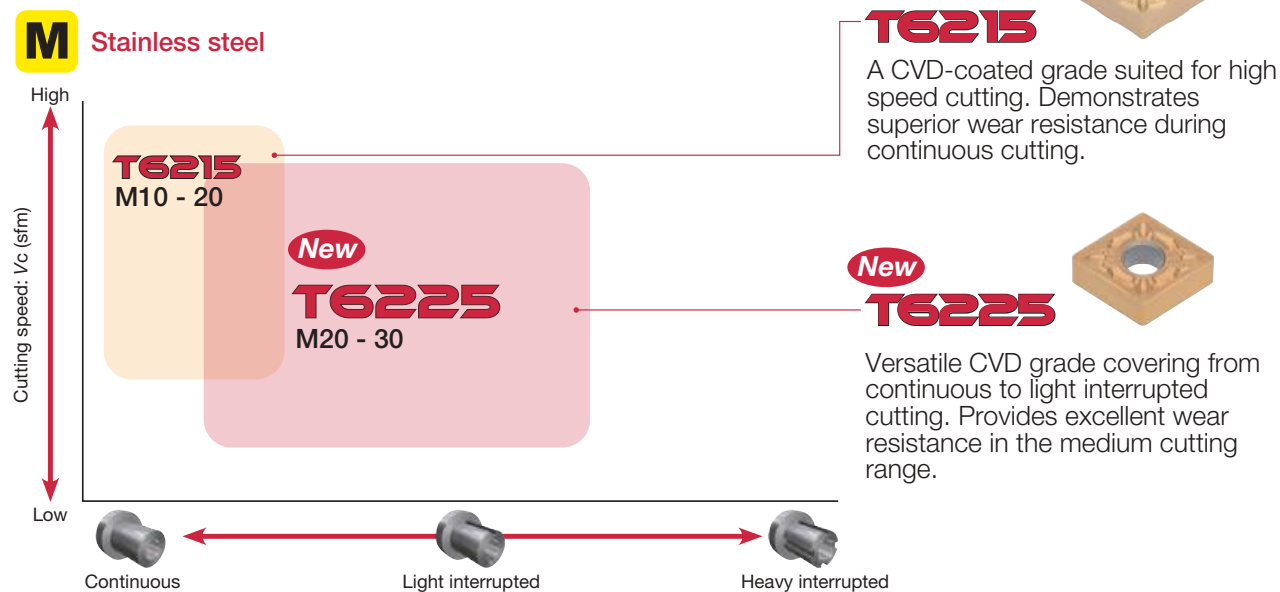

**BM05M / SBN30 / BX4015**

Valid from January 1st to June 30th, 2026

**HIGH-PRODUCTIVITY CBN GRADES FOR MULTIPLE MACHINING MATERIALS**

**BM05M** coated CBN grade for high speed continuous cuts of hardened steel parts

**BX4015** CBN grade for sintered alloys

**SBN30** CBN grade for high speed machining of cast iron

**BUY 8 inserts**

AND

**GET 2 corresponding insert**

**FREE**  
*of charge!*

Promo Code: TG260

\*Offer must be ordered through our Customer Service Team, not available on Webshop.

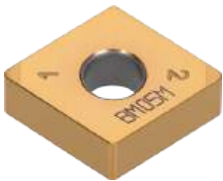

**BM05M**

First-choice coated CBN grade for high-speed continuous cutting of hardened steel at speeds up to 1,148 sfm.

**Inserts:**

ISO type:

C, D, G, T, V, W

MiniForce-Turn:

DX, WX



**SBN30**

Solid CBN grade for high-speed cast iron machining, offering deep cuts, high feeds, and exceptional wear and fracture resistance.

**Inserts:**

ISO type:

C, R, S

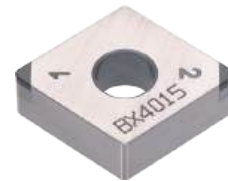

**BX4015**

CBN grade for sintered alloys, delivering excellent performance in continuous to light-interrupted cuts.

**Inserts:**

ISO type:

C, D, T, V



# MINIFORCE TURN

Valid from January 1st to June 30th, 2026

**ECONOMICAL, DOUBLE-SIDED POSITIVE INSERT WITH AN INNOVATIVE GEOMETRY AND SEAT INTERFACE THAT DELIVERS STABILITY AND HIGH PERFORMANCE.**

**BUY 20** inserts

AND

**GET 1** holder

**FREE**  
*of charge!*

Promo Code: TUS56

**BUY 20** inserts

AND

**GET 1 CHP** holder at

**50 %**  
*additional discount!*

Promo Code: TUS56

**Inserts:**

CXMU, DXGU, DXMU, VXGU, WXGU

**Toolholders:**

A/E-SCLXR/L	JS-SDUXL	JSVJ2XR/L	JSWL2XR/L-X-CHP
A/E-SDXXR/L	JS-SVUXL	JSVJ2XR/L-CHP	JSWLXR-F
A/E-SDZXR/L	JSDJ2XR/L	JSVJ2XR/L-X-CHP	JSWLXR/L
A/E-SWLXR/L	JSDJ2XR/L-CHP	JSVJXR-F	
JPDJ2XR/L	JSDJ2XR/L-X-CHP	JSVJXR/L	
JPVJ2XR/L	JSDJXR-F	JSWL2XR/L	
JPWL2XR/L	JSDJXR/L	JSWL2XR/L-CHP	



## SUPERB STABILITY AND PRODUCTIVITY IN DEEP FACE GROOVING OPERATIONS

Newly designed insert profile ensures unobstructed chip flow and consistent chip evacuation.

**BUY 20** inserts

AND

**GET 1** adapter

**FREE**  
of charge!

Promo Code: TG262

**BUY 20** inserts

AND

**GET 1** CHP holder at

**50 %**  
additional  
discount!

Promo Code: TG262

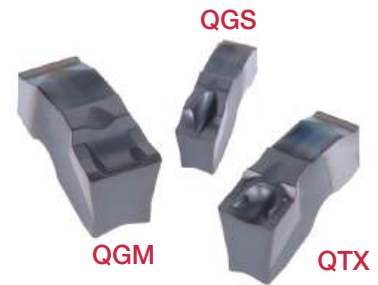

**Inserts (Grades AH7025, AH6235):**

QGM, QGS and QTX

CW = 0.118", 0.157", 0.197"

Max. grooving depths for face grooving

CDX = 1.65"

**Adapters:**

QSDR/L-CHP... Face grooving adapter

(for CW = 0.118", 0.157", 0.197",

CDX = 1.02" - 1.65")

**Holders for adapters:**

QHSR/L-CHP

QHTR/L-CHP

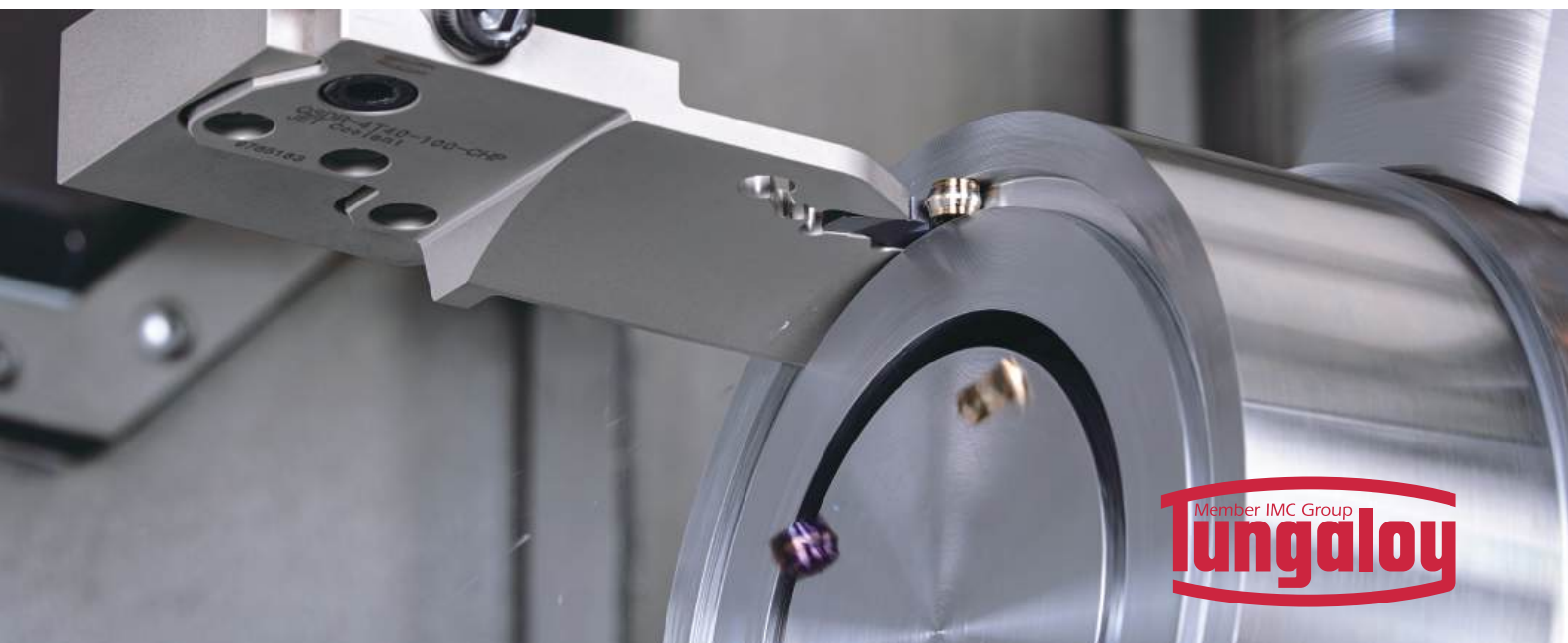

## INNOVATIVE 4-CUTTING-EDGE TOOLS FOR FACE GROOVING IN MINIATURE MACHINING

Unique clamping design ensures high rigidity, excellent repeatability, and outstanding productivity.

**BUY 10** inserts

AND

**GET 1** corresponding toolholder at

**60 %**  
additional discount!

Promo Code: TG261

Inserts (Grades SH7025, SH725):  
TCF18

Toolholders:  
JS-STCFL  
STCFVR

**TCF18**

CW = 0.019" - 0.098"

Max. grooving depth: 0.118"

Minimum grooving diameter:  $\varnothing 0.236$ "



## DEEP FACE GROOVING OF UP TO 10 MM DAXN AND UP TO 0.354" GROOVE DEPTH IS POSSIBLE

Extremely rigid insert clamping ensures tool stability during deep face grooving operations. Sharp cutting edge, **combined with SH7025, the latest PVD grade**, provides long tool life and superior surface quality. The direct coolant supply from holder and insert geometry effectively redirects chips out and away from the part.

**BUY 10** inserts

AND

**GET 1** corresponding toolholder

**FREE**  
of charge!

Promo Code: TG263

Inserts (Grade SH7025):

MFGR...

Toolholder:

A-MFR10...



MFGR10

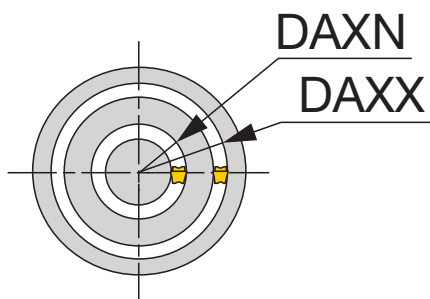

## MORE THAN 13,000 POSSIBLE COMBINATIONS

Solutions for conventional and Swiss machining applications. Easy and accurate head-holder coupling provides reduced tool change time and high accuracy of cutting point repeatability. Covers a broad range of applications from precision machining to large parts. Tool Diameter range: 5mm - 32mm / 0.250" - 1.000".

**BUY 6 heads**

AND

**GET 1 steel shank**

OR

**GET 1 carbide shank at**

Promo Code: TG267

**FREE of Charge**

**50% additional discount**

### Heads (Grade: AH715, AH725, AH750, GH730, KS15F):

Square heads: VEH, VEE, VED

Face mills: VFM

High-feed: VFX

Ball: VBB, VBD, VBE

Radius: VRB, VRC, VRD

Barrel: VBO

Bull nose: VBN

Lens: VBL

Chamfering: VCA, VCW, VCR

Chamfering and spot drill: VCP, VDS

Center drill: VDP

Counterboring: VGC

Multi-function: VVFH

Slotting: VST, VTB

Threading: VMT, VTR



### Shanks:

Steel, Carbide, ER collet type



# HIGH FEED MILLING CUTTERS WITH SIX CUTTING EDGE INSERTS

The cutter's small entry angle ensures smooth material access, perfect for long reach applications

**BUY 10** inserts per pocket up to max 50 inserts

AND

**GET 1** cutter

**FREE**  
*of charge!*

DoFeedTri03 Promo Code: TG264  
DoFeedTri06 Promo Code: TG265

Inserts (Grades: AH3225, AH3135, AH130, AH8015):

WXMU03-MM/ML/MS  
WXMU06-MM

**Cutter bodies:**

Bore type:

**TXWX03**

DCX =  $\varnothing 1.500'' - \varnothing 4.000''$  ( $\varnothing 40 - \varnothing 80$  mm)

**TXWX06**

DCX =  $\varnothing 2.000'' - \varnothing 4.000''$  ( $\varnothing 40 - \varnothing 80$  mm)

Shank type:

**EXWX03...**

DCX =  $\varnothing 0.620'' - \varnothing 1.250''$  ( $\varnothing 16 - \varnothing 40$  mm)

Modular type:

**HXWX03**

DCX =  $\varnothing 16$  mm –  $\varnothing 40$  mm



## HIGH-SPEED, ECONOMICAL FACE MILLING CUTTER DESIGNED FOR HIGH PRODUCTIVITY ACROSS ALL MATERIALS WHILE DELIVERING A SUPERIOR SURFACE FINISH.

**BUY** 10 inserts per  
pocket up to max 50 inserts  
**AND**  
**GET** 1 cutter

**FREE**  
*of charge!*  
Promo Code: TUS61

Limited up to diameter 5.000" (125 mm)

**Inserts:**  
PN\*U0905

**Cutters:**  
Shank type: EEN09  
Bore type: TEN09

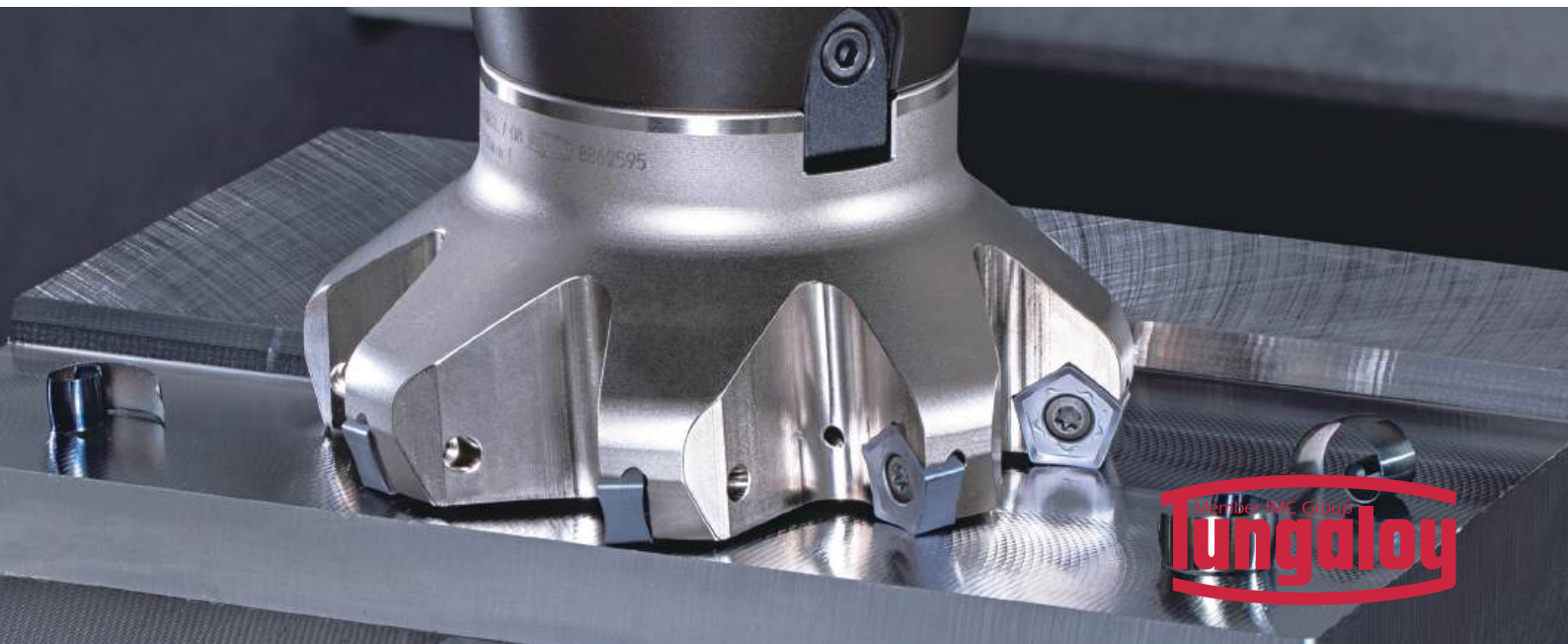

## COMPLETE SOLUTION FOR SHOULDER MILLING WITH OUTSTANDING PERFORMANCE AND COST-EFFECTIVE INSERTS

Economical shoulder milling cutter with 3 cutting edged insert with wide range of sizes, grades and diameters.

**BUY 10** inserts per pocket up to max 50 inserts  
**AND**  
**GET 1** cutter

**FREE**  
*of charge!*  
 Promo Code: TG266

Limited up to diameter 5.000" (125 mm)

Inserts (Grade: T1215, KS05F, DS2005, T3225, AH8015, AH3135, AH3225, AH120):  
 TO\*T04/06/10/15 - MJ/MM/AJ/NMJ

**Cutter bodies:**

Bore type:

**TPA06/10/15**

DC =  $\phi 1.500'' - \phi 5.000''$  ( $\phi 32$  mm –  $\phi 125$  mm)

Shank type:

**EPA04/06/10/15**

DC =  $\phi 0.500'' - \phi 2.000''$  ( $\phi 8$  mm –  $\phi 50$  mm)

Modular type:

**HPA06/10-M**

DCX =  $\phi 16 - \phi 32$  mm

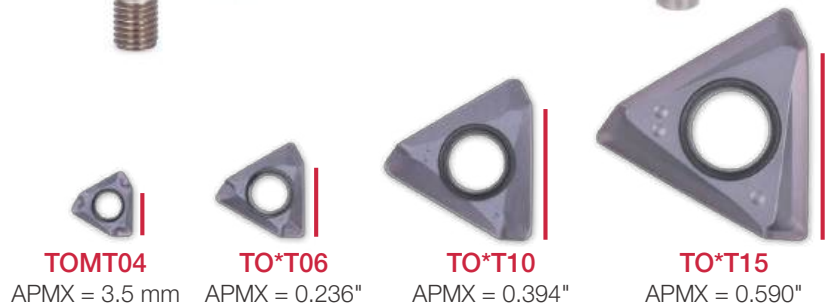

## VERSATILE SHOULDER MILLING CUTTER WITH UNIQUE V-SHAPED INSERT BOTTOM FOR MAXIMUM PRODUCTIVITY

Unmatched stability across all materials, with an innovative clamping system

**BUY 10 inserts per  
AND pocket UP TO MAX 50 INSERTS  
GET 1 Cutter**

**FREE  
of charge!**

**Promo Codes:**  
Size 04: TUS57  
Size 06: TUS58  
Size 12: TUS59  
Size 18: TUS60

Limited up to diameter 5" (125 mm)

Inserts (Grades: AH3225, AH3135, AH8015,  
AH120, AH130, T1215, T3225 and KS05F):

AVMT04, AVGT06, AV\*T12, AV\*T18

**Cutter bodies:**

**Bore type:**

TPAV\*\*

DC =  $\varnothing 1.5'' - \varnothing 5''$

( $\varnothing 40 - \varnothing 125$  mm)

**Shank type:**

EPAV\*\*

DC =  $\varnothing 0.313'' - \varnothing 1.25''$

( $\varnothing 6 - \varnothing 32$  mm)

**Modular type:**

**HPAV\*\*-M** (TungFlex connection)

DC =  $\varnothing 10 - \varnothing 40$  mm

**HPAV06-S** (TungMeister connection)

DC =  $\varnothing 10 - \varnothing 16$  mm



**AVMT04**  
APMX:  
4 mm



**AVGT06**  
APMX:  
0.236" (6 mm)



**AV\*T12**  
APMX:  
0.453" (11.5 mm)



**AV\*T18**  
APMX:  
0.650" (16.5 mm)



## EXCHANGEABLE HEAD DRILL SYSTEM FOR SUPERIOR DRILLING PERFORMANCE AND LONG TOOL LIFE

Quick drill tip change for reduced machine downtime.

Tool inventory and management costs are significantly reduced as there is no need for regrinding.

**BUY** 4 drill heads

AND

**GET** 1 drill body

1.5xD - 3.5xD and Modular type

**FREE**  
of charge!

### Promo Codes:

1.5-2xD: TG268

3-3.5xD: TG269

Modular type: TG272

5-6xD: TG270

Inch chamfering: TG273

8xD: TG271

**BUY** 6 drill heads

AND

**GET** 1 drill body

5xD, 6xD, and Inch Chamfering

**FREE**  
of charge!

Drill heads (Grades: AH725, AH9130, KS15F):

DMP, DMC, DMF, DMH, DMN, DMM

Drill bodies:

TID-F (1.5xD, 3xD, 5xD, 8xD)

TID-R (2xD, 3.5xD, 6xD, 8xD)

TIDC (3xD, 5xD)

Modular drill bodies:

TID-M (2xD, 3xD)

TID-S (2xD)

TID-L-A-M

Inch chamfering:

TID-L-A

**BUY** 8 drill heads

AND

**GET** 1 drill body

up to 8xD

**FREE**  
of charge!



## DRILL HEADS LINEUP



**DMP**

Drill dia.:  
ø0.236" - ø1.020"  
(ø6 - ø25.9 mm)

General purpose drilling head ideal for various drilling applications



**DMC**

Drill dia.:  
ø0.236" - ø1.020"  
(ø6 - ø25.9 mm)

High-precision head with double margin and self-centering edge



**DMF**

Drill dia.:  
ø0.236" - ø1.020"  
(ø6 - ø25.9 mm)

180° flat edges for counterboring and flat bottoms



**DMH**

Drill dia.:  
ø0.236" - ø1.020"  
(ø6 - ø25.9 mm)

General purpose head with enhanced cutting edge



**DMN**

Drill dia.:  
ø0.268" - ø0.768"  
(ø6.8 - ø19.5 mm)

Drill head with sharp edges for non-ferrous materials



**DMM**

Drill dia.:  
ø0.393" - ø0.783"  
(ø10 - ø19.9 mm)

General purpose drilling head for stainless steel and superalloy materials

## DRILL BODIES LINEUP

**TIDC**

Drill dia.:  
ø0.295" - ø0.783"  
(ø7.5 - ø19.9 mm)  
3xD and 5xD



**TID-F**

Drill dia.:  
ø0.236" - ø1.020"  
(ø6 - ø25.9 mm)  
1.5xD, 3xD, 5xD, 8xD



**TID-R / TID-R-E**

Drill dia.:  
ø0.236" - ø0.783"  
(ø6 - ø19.9 mm)  
2xD, 3.5xD, 6xD, 8xD



**TID-L-A**

3/8" - 7/8" UNC/UNF Tap Sizes  
Inch chamfer for tap sizes

## MODULAR DRILL BODIES LINEUP

video



**TID-M**

Drill dia.:  
ø0.236" - ø0.744"  
(ø6 - ø18.9 mm)  
2xD and 3xD

TungFlex connection

video



**TID-S**

Drill dia.:  
ø0.256" - ø0.429"  
(ø6.5 - ø10.9 mm)  
2xD

TungMeister connection



**TID-L-A-M**

Drill dia.:  
ø0.256" - ø0.665"  
(ø6.5 - ø16.9 mm)  
TungFlex connection  
drilling+chamfering /  
pre-thread drilling

# TMV Chipbreaker Series

Valid from January 1st to June 30th, 2026

# NTK

## TURNING & MINIATURE

## OUTSTANDING CHIPBREAKER FOR CONVENTIONAL AND VIBRATION MACHINING

Advanced chipbreaker design for reliable performance & longer tool life

**BUY 30** inserts

AND

**GET 10** corresponding inserts

**FREE**  
*of charge!*

Promo Code: NW010

\*Offer must be ordered through our Customer Service Team, not available on Webshop.

Inserts (Grades DM4, TM4, ST4 and NTK650):  
DCGT, DCGT-WP, TNGG, CCGT, VCGT

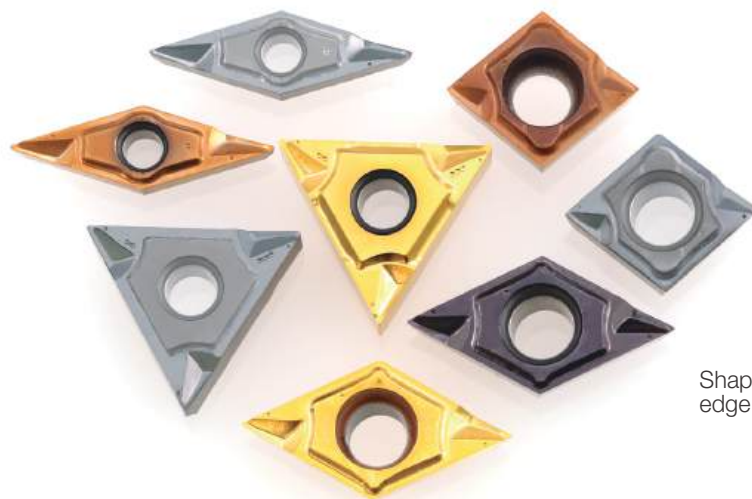

Controls chip flow reliably

Shape to prevent cutting edge damage from chipping

Rake face shape to withstand high cutting feeds

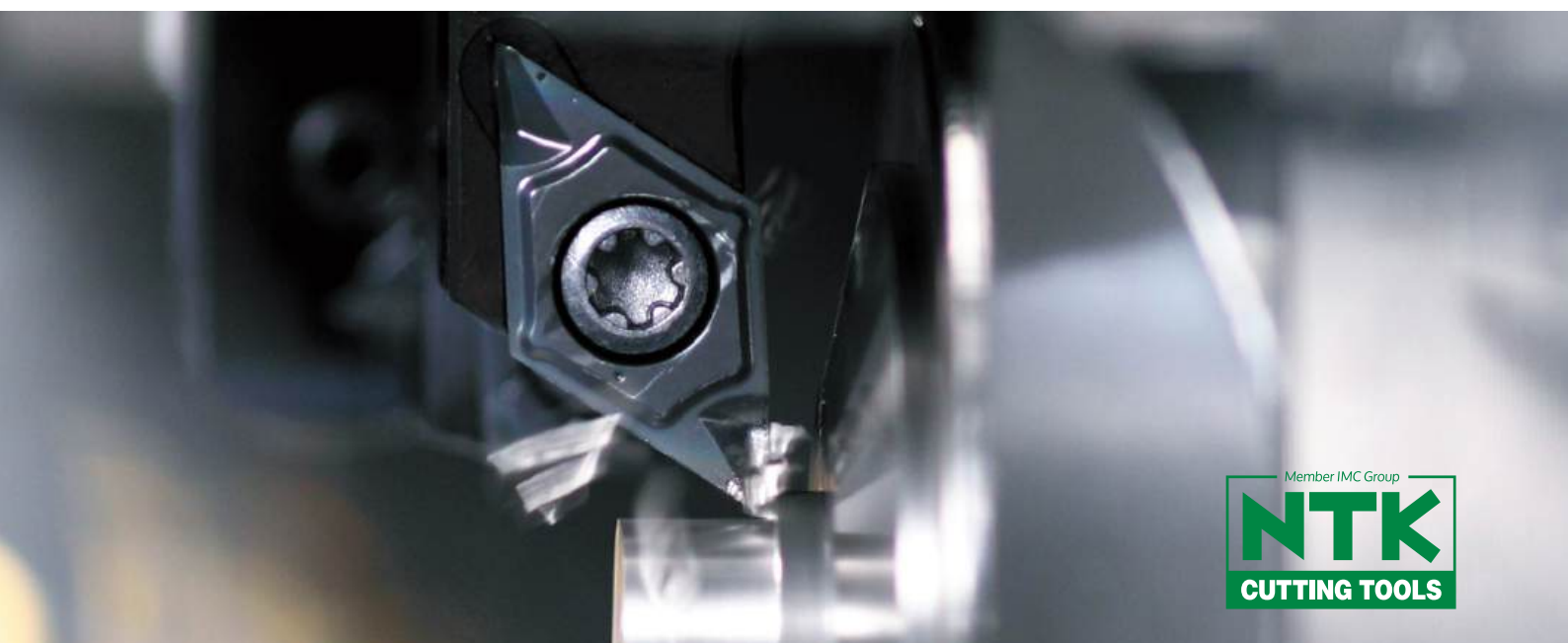
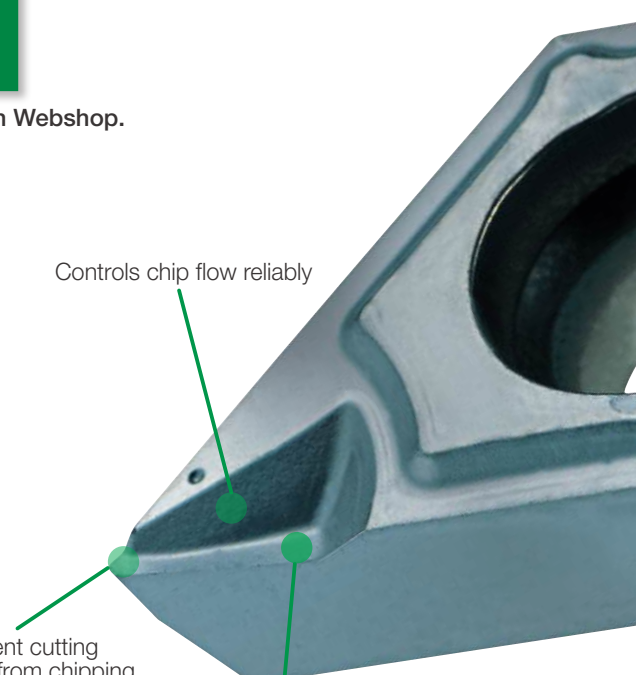

# YL Chipbreaker Series

Valid from January 1st to June 30th, 2026

# NTK

## TURNING & MINIATURE

## FIRST RECOMMENDATION FOR FRONT TURNING OPERATIONS

Combination of sharpness, toughness, and chip control to handle an extremely wide range of cutting conditions

**BUY 30** inserts

AND

**GET 10** corresponding inserts

**FREE**  
*of charge!*

Promo Code: NW011

\*Offer must be ordered through our Customer Service Team, not available on Webshop.

Inserts (Grades DM4, DT4, TM4, ST4, QM3 and NTK650):  
DCGT, CCGT, VBG, VCGT



# N-SWISS JOINT

Valid from January 1st to June 30th, 2026

# NTK

## TURNING & MINIATURE

## QUICK-CHANGE MODULAR-TYPE TOOL SERIES FOR AUTOMATIC LATHES

Multiple heads compatible with a single shank, covering a broad range of applications.

**BUY** 1 modular head  
and **10** inserts

AND

**GET** 1 corresponding  
shank

**FREE**  
*of charge!*

Promo Code: NW012

Inserts (Grades NTK650, ST4, DM4, DT4, QM3, TM4, VM1, ZM3):

ISO inserts

Modular heads (QC10, QC12, QC16):

Front turning: SDJC, SCLC, PTXN, SVJC

Toolholders:

QC-1012-OH2

QC-1212-OH/OH2

QC-1216-OH/OH2

QC-1616-OH2

QC-06H-IN-OH2

QC-08F-IN-OH

QC-08X-IN-OH2

QC-10X-IN-OH2

**BUY** 1 modular head  
and **10** inserts

AND

**GET** 1 corresponding  
modular head at

**50 %**  
*additional  
discount!*

Promo Code: NW012



SCLC



SDJC



PTXN



SVJC

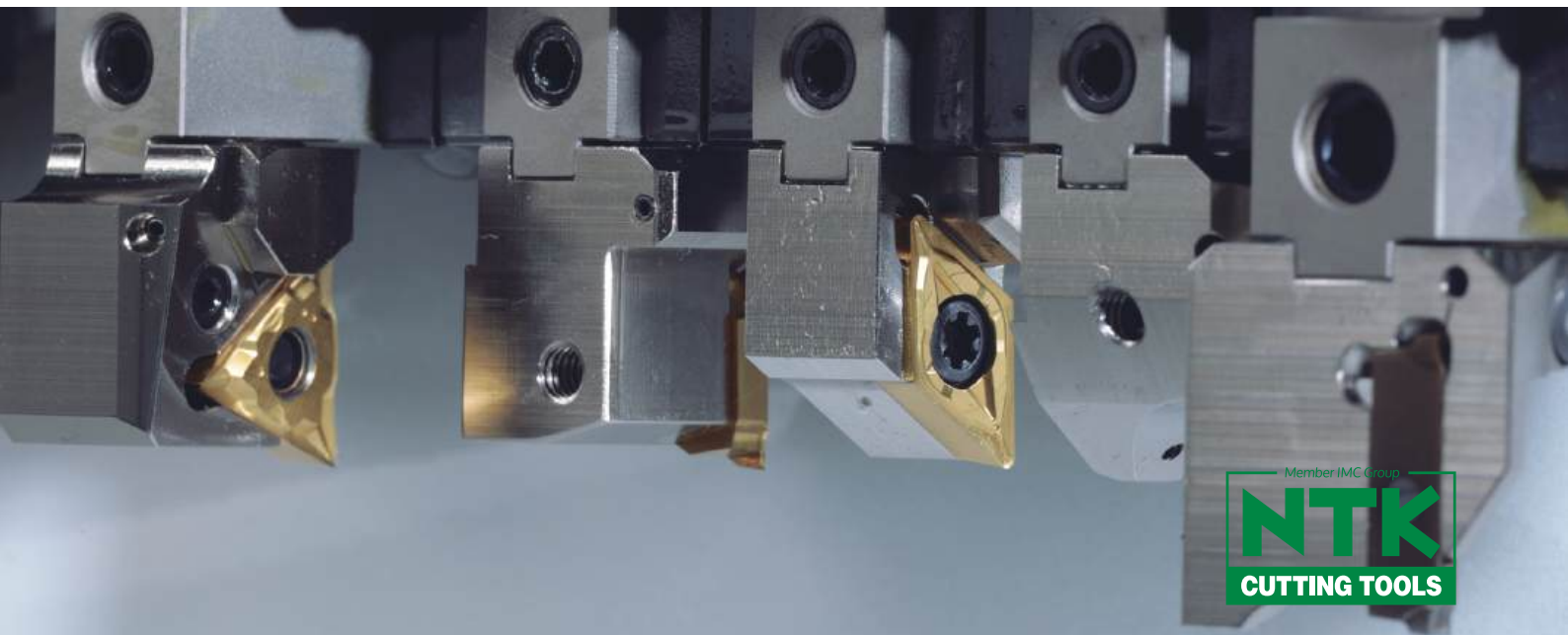

Member IMC Group  
**NTK**  
CUTTING TOOLS

# DS-ACH Holder Series

Valid from January 1st to June 30th, 2026

# NTK

## TURNING & MINIATURE

## DESIGNED TO EASILY ADJUST THE CUTTING EDGE HEIGHT IN MACHINES WITHOUT Y2 AXIS CAPABILITY

**BUY 20 ISO inserts**

AND

**GET 1 corresponding toolholder at**

**50 % additional discount!**

Promo Code: NW013

Inserts (Grades 650, ST4, DM4, DT4, QM3, TM4, VM1, ZM3):

ISO inserts

Toolholders:

DS-PTX-ACH-OH  
DS-PTX-ACH  
DS-SCL-ACH  
DS-SDU-ACH-OH  
DS-SDU-ACH  
DS-SVVPN-ACH

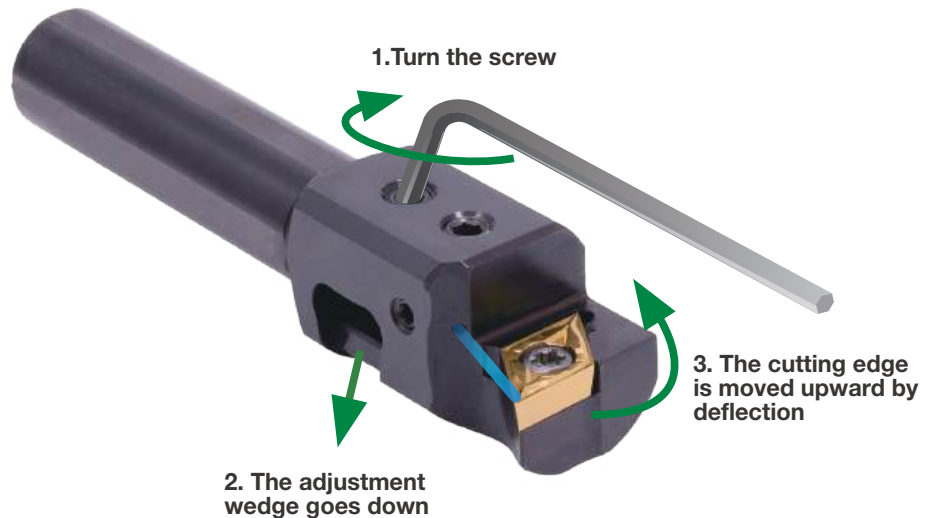

Range of centerline adjustment: 0" - 0.008"

Height adjustment of the cutting edge is done by turning a screw and bending the tip of the holder with a wedge mechanism. Patented holder design improves rigidity, compared to conventional holders, to eliminate vibration

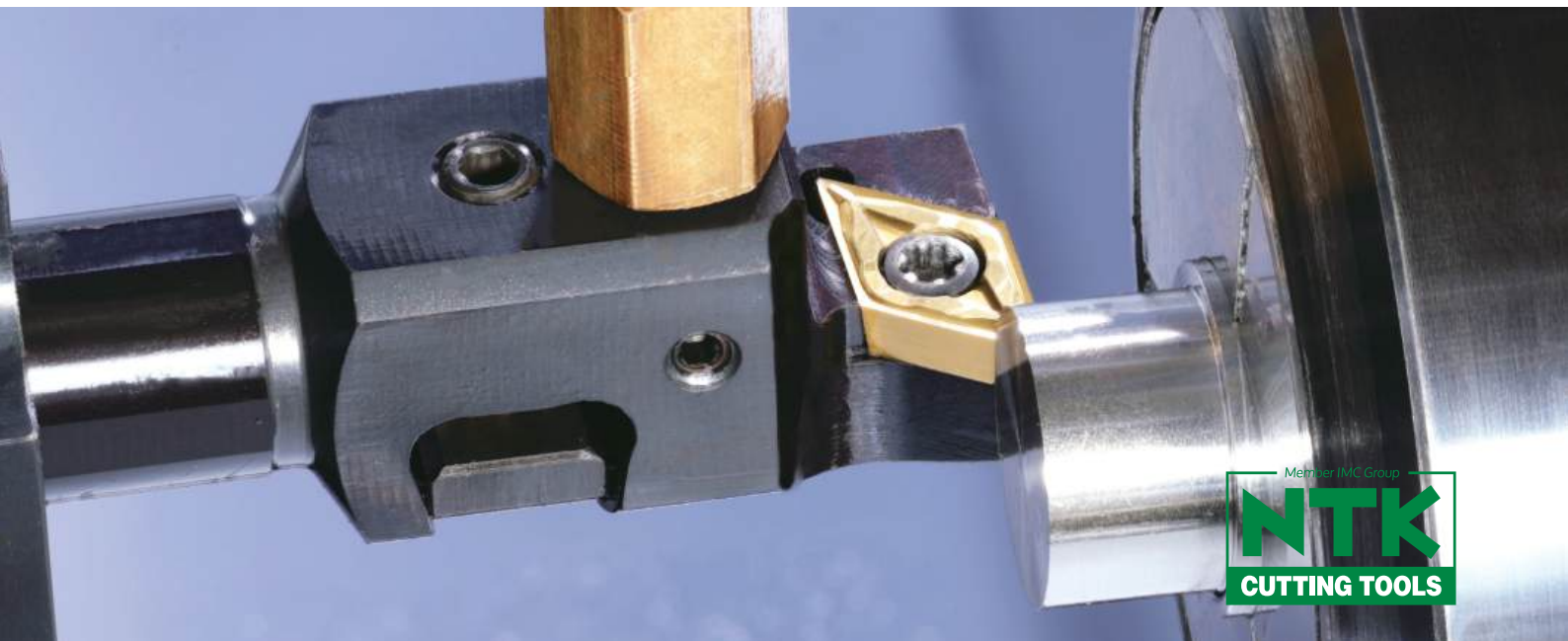

# YOUR GATEWAY TO TUNGALOY & NTK SUCCESS REPORTS!

We invite you to visit the updated TSR platform and discover how Tungaloy and NTK's products have successfully met diverse challenges and delivered outstanding results. These reports can provide insights and inspiration for your own applications and projects, offering detailed solutions to succeed in various industrial fields.

Find applications that fit your current needs, elevate your productivity, and solve your production bottlenecks.

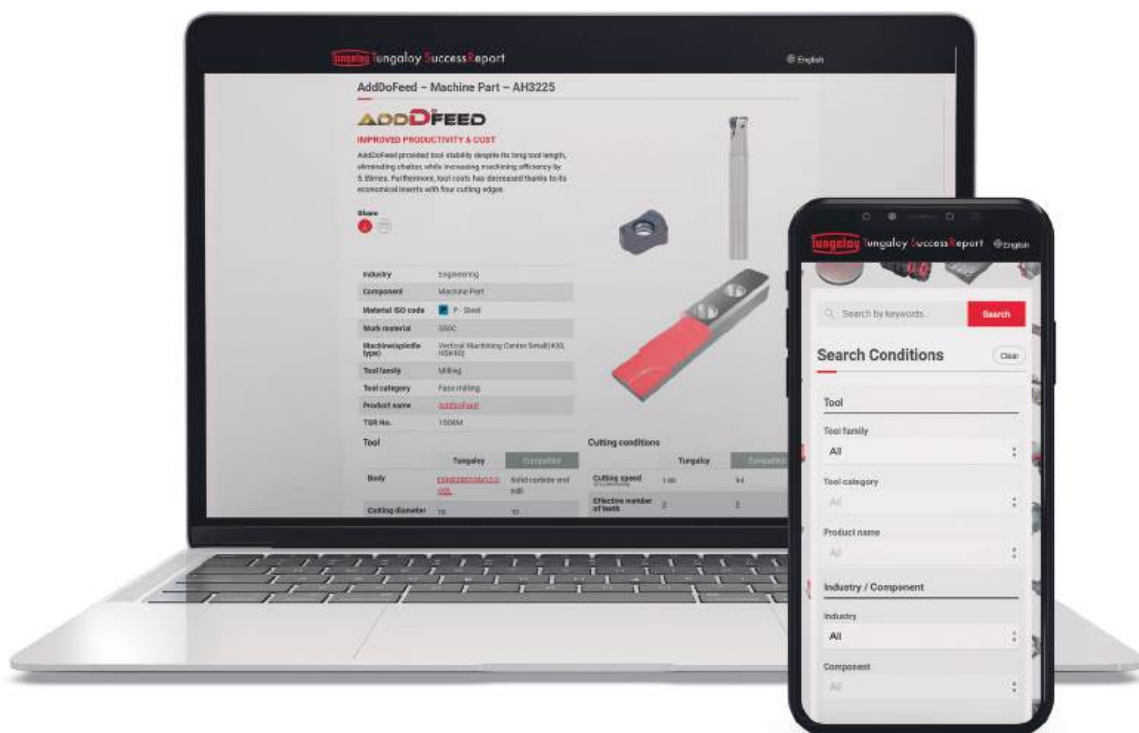

[tsr.tungaloy.com](https://tsr.tungaloy.com)

## *Tungaloy-NTK America Promotion Details:*

- Valid January 1 - June 30, 2026
- Orders must be drop shipped to the end user
- Promo code must be included at time of order
- Prices valid in U.S. only
- No returns

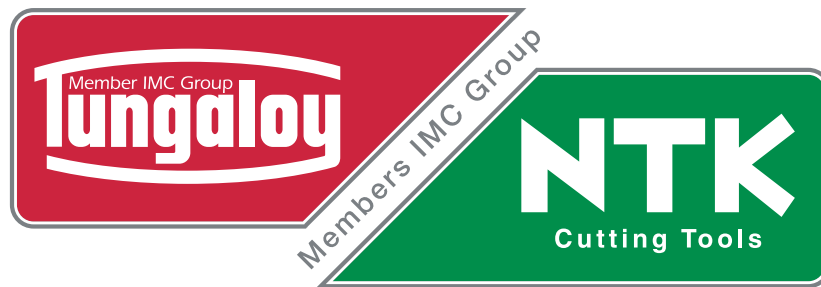

Tungaloy-NTK America Inc.  
3726 N Ventura Drive  
Arlington Heights, IL 60004, U.S.A.

# Leading in Innovation

Distributed by:



**COMPLETE  
METALWORKING  
SOLUTIONS**

(800) 991-4225

[www.ahbinc.com](http://www.ahbinc.com)

ISO Certified

[customerservice@ahbinc.com](mailto:customerservice@ahbinc.com)



**FIND US ON THE CLOUD!**  
[machingcloud.com](http://machingcloud.com)